

Oracle® Revenue Management and Billing
Version 3.1.0.0.0

Insurance User Guide

Revision 13.7

F49292-01

November 2021



Notices

Oracle Revenue Management and Billing Version 3.1.0.0.0 Insurance User Guide

F49292-01

Copyright Notice

Copyright © 2009, 2022 Oracle and/or its affiliates. All rights reserved.

Trademark Notice

Oracle, Java, JD Edwards, PeopleSoft, and Siebel are registered trademarks of Oracle Corporation and/or its affiliates. Other names may be trademarks of their respective owners.

Intel and Intel Xeon are trademarks or registered trademarks of Intel Corporation. All SPARC trademarks are used under license and are trademarks or registered trademarks of SPARC International, Inc. AMD, Opteron, the AMD logo, and the AMD Opteron logo are trademarks or registered trademarks of Advanced Micro Devices. UNIX is a registered trademark of The Open Group.

License Restrictions Warranty/Consequential Damages Disclaimer

This software and related documentation are provided under a license agreement containing restrictions on use and disclosure, and are protected by intellectual property laws. Except as expressly permitted in your license agreement or allowed by law, you may not use, copy, reproduce, translate, broadcast, modify, license, transmit, distribute, exhibit, perform, publish, or display any part, in any form, or by any means. Reverse engineering, disassembly, or de-compilation of this software, unless required by law for interoperability, is prohibited.

Warranty Disclaimer

The information contained herein is subject to change without notice and is not warranted to be error-free. If you find any errors, please report them to us in writing.

Restricted Rights Notice

If this software or related documentation is delivered to the U.S. Government or anyone licensing it on behalf of the U.S. Government, the following notice is applicable:

U.S. GOVERNMENT RIGHTS

Oracle programs, including any operating system, integrated software, any programs installed on the hardware, documentation, and/or technical data delivered to U.S. Government end users are “commercial computer software” or “commercial technical data” pursuant to the applicable Federal Acquisition Regulation and agency-specific supplemental regulations. As such, use, duplication, disclosure, modification, and adaptation of the programs, including any operating system, integrated software, any programs installed on the hardware, documentation, and/or technical data shall be subject to license terms and restrictions as mentioned in Oracle License Agreement, and to the extent applicable, the additional rights set forth in FAR 52.227-19, Commercial Computer Software--Restricted Rights (June 1987). No other rights are granted to the U.S. Government.

Hazardous Applications Notice

This software is developed for general use in a variety of information management applications. It is not developed or intended for use in any inherently dangerous applications, including applications that may create a risk of personal injury. If you use this software in dangerous applications, then you shall be responsible to take all appropriate fail-safe, backup, redundancy, and other measures to ensure the safe use of this software. Oracle Corporation and its affiliates disclaim any liability for any damages caused by use of this software in dangerous applications.

Third Party Content, Products, and Services Disclaimer

This software and documentation may provide access to or information on content, products, and services from third parties. Oracle Corporation and its affiliates are not responsible for and expressly disclaim all warranties of any kind with respect to third party content, products, and services unless otherwise set forth in an applicable agreement between you and Oracle. Oracle Corporation and its affiliates will not be responsible for any loss, costs, or damages incurred due to your access to or use of third party content, products, or services.

Contents

About this Document.....	49
Intended Audience.....	49
Organization of the Document.....	49
Conventions.....	53
Related Documents.....	53
Change Log.....	55
Chapter 1: Fully-Insured Group Customer Management.....	57
Fully-Insured Entities.....	58
Parent Customer.....	59
Bill Groups.....	59
Bill Group's Account.....	59
Fully-Insured Group Policy.....	60
Policy Plans.....	60
Price Items.....	61
Pricing Rule Types.....	61
Pricing Rules.....	61
Price Assignments.....	61
Chapter 2: Self-Funded Customer Management.....	63
Self-Funded Entities.....	64
Parent Customer.....	65
Bill Groups.....	65
Bill Group's Account.....	65
Self-Funded Policy.....	66
Price Items.....	66
Pricing Rule Types.....	66
Pricing Rules.....	67
Price Assignments.....	68
Chapter 3: Health Insurance Business Management.....	69
Policy Type.....	70
Policy Type List.....	70
Policy Type.....	71
Defining a Policy Type.....	72
Defining a Characteristic for a Policy Type.....	74
Editing a Policy Type.....	74
Copying a Policy Type.....	76
Deleting a Policy Type.....	78
Viewing the Policy Type Details.....	78
Policy Person Role.....	79
Policy Person Role List.....	79
Defining a Policy Person Role.....	79
Editing a Policy Person Role.....	80
Deleting a Policy Person Role.....	81
Contract Relationship Type.....	81
Filtering the Contract Relationship Types.....	81
Defining a Contract Relationship Type	82

Editing a Contract Relationship Type.....	83
Deleting a Contract Relationship Type.....	83
Source System Extendable Lookup.....	84
Extendable Lookup Search.....	84
Searching for the Source System Extendable Lookup.....	85
Viewing the Values of the Source System Extendable Lookup.....	85
Extendable Lookup (Source System).....	86
Extendable Lookup Value List.....	86
Extendable Lookup Value.....	87
Defining a Source System.....	88
Editing a Source System.....	89
Copying a Source System.....	90
Deleting a Source System.....	91
Viewing the Source System Details.....	91
Membership Identifier Type.....	92
Membership Identifier Type List.....	92
Membership Identifier Type.....	93
Defining a Membership Identifier Type.....	94
Editing a Membership Identifier Type.....	95
Copying a Membership Identifier Type.....	97
Deleting a Membership Identifier Type.....	98
Viewing the Membership Identifier Type Details.....	99
Pricing Parameters.....	99
Geographic Rating Area.....	100
Prerequisites.....	101
Uploading a Geographic Rating Area File in the CSV Format.....	102
CSV File Format for Uploading Geographic Rating Areas.....	103
Sample CSV Format for Uploading Geographic Rating Areas.....	104
Geographic Rating Area (Used for Searching).....	105
Search Geographic Rating Area.....	105
Geographic Rating Area.....	108
Searching for a Geographic Rating Area.....	109
Defining a Geographic Rating Area.....	110
Adding the Plan Details for a Geographic Rating Area.....	111
Editing a Geographic Rating Area.....	112
Inactivating a Geographic Rating Area.....	114
Viewing the Geographic Rating Area Details.....	114
Member Relationship Pricing Parameter.....	114
Prerequisites.....	118
Member Relationship/Subscription Tier Structure (Used for Searching).....	119
Member Relationship/Subscription Tier Structure List.....	119
Member Relationship/Subscription Tier Structure.....	120
Defining a Member Relationship Structure.....	121
Editing a Member Relationship Structure.....	123
Copying a Member Relationship Structure.....	126
Deleting a Member Relationship Structure.....	128
Viewing the Member Relationship Structure Details.....	129
Subscription Tier Pricing Parameter.....	129
Prerequisites.....	133
Member Relationship/Subscription Tier Structure (Used for Searching).....	133
Member Relationship/Subscription Tier Structure List.....	133
Member Relationship/Subscription Tier Structure.....	134
Defining a Subscription Tier Structure.....	136
Editing a Subscription Tier Structure.....	138
Copying a Subscription Tier Structure.....	140
Deleting a Subscription Tier Structure.....	142

Viewing the Subscription Tier Structure Details.....	143
Medicare Benefits.....	144
Benefit Status Transition.....	144
Algorithms Used in C1-Benefits.....	145
C1-FIAUDEV.....	145
C1-BENVAL.....	146
Benefit Sub Type.....	147
Benefit Sub Type List.....	147
Benefit Sub Type.....	148
Defining a Benefit Sub Type.....	151
Defining a Characteristic for a Benefit Sub Type.....	153
Editing a Benefit Sub Type.....	154
Copying a Benefit Sub Type.....	157
Deleting a Benefit Sub Type.....	160
Viewing the Details of a Benefit Sub Type.....	161
Benefit (Used for Searching).....	161
Search Benefit.....	161
Searching for a Medicare Benefit.....	166
Defining a Medicare Benefit.....	166
Defining a Characteristic for a Medicare Benefit.....	169
Viewing the Medicare Benefit Details.....	170
Benefit (Used for Viewing).....	170
Benefit - Main.....	170
Benefit - Log.....	172
Editing a Medicare Benefit.....	173
Discarding a Medicare Benefit.....	175
Viewing the Log of a Medicare Benefit.....	175
Adding a Log Entry for a Medicare Benefit.....	176
Medicare Preference.....	176
Searching for a Medicare Preference.....	177
Viewing the Medicare Preference Details.....	177
Defining a Medicare Preference.....	178
Editing a Medicare Preference.....	180
Copying a Medicare Preference.....	182
Deleting a Medicare Preference.....	185
Medicare Plan Benefit Package.....	185
Searching for a Medicare Plan Benefit Package.....	185
Viewing the Medicare Plan Benefit Package Details.....	186
Defining a Medicare Plan Benefit Package.....	186
Editing a Medicare Plan Benefit Package.....	187
Copying a Medicare Plan Benefit Package.....	188
Deleting a Medicare Plan Benefit Package.....	189
Geographic Rating Area Preference.....	189
Searching for a Geographic Rating Area Preference.....	190
Viewing the Geographic Rating Area Preference Details.....	190
Defining a Geographic Rating Area Preference.....	191
Editing a Geographic Rating Area Preference.....	197
Copying a Geographic Rating Area Preference.....	203
Deleting a Geographic Rating Area Preference.....	208
Member Relationship and Subscription Tier Preference.....	209
Searching for a Member Relationship and Subscription Tier Preference.....	210
Viewing the Member Relationship and Subscription Tier Preference Details.....	210
Defining a Member Relationship and Subscription Tier Preference.....	211
Editing a Member Relationship and Subscription Tier Preference.....	221
Copying a Member Relationship and Subscription Tier Preference.....	232
Deleting a Member Relationship and Subscription Tier Preference.....	241

Chapter 4: Fully-Insured Group Health Insurance.....	243
Pre-requisites.....	245
Fully-Insured Group Policy.....	247
Fully-Insured Group Policy Activation.....	248
Fully-Insured Group Policy Termination.....	248
Fully-Insured Group Policy Reinstatement.....	249
Fully-Insured Group Policy Renewal.....	250
Single Contract Creation Across Fully-Insured Group Policies and Plans.....	250
Policy Plan Specific Contract Creation.....	269
Fully-Insured Group Policy Status Transition.....	281
Membership Status Transition.....	282
Types of Policy Plan.....	283
Commercial Plans.....	283
Medicare Affiliated Plans.....	284
Types of Membership.....	284
Active Employee Coverage Membership.....	285
Medicare Membership.....	286
COBRA Membership.....	288
Retiree Membership.....	290
Algorithms Used in C1-POLICY.....	291
C1-REAUDEVNT.....	292
C1-POLBOVAL.....	293
C1-TRNDFLSYS.....	294
F1-AT-RQJ.....	294
C1-EVCSTSTAT.....	294
C1-PLCYTRMRQ.....	294
C1-POLCYTERM.....	295
C1-DELTRMLTR.....	295
C1-PLCYREIRQ.....	296
C1-POLCYREIN.....	296
C1-CCPOLRE1.....	297
Algorithms Used in C1-PolicyPlan.....	298
C1-PPCONCRE.....	298
C1-VALPPBO.....	298
Algorithms Used in C1-Membership.....	299
C1-FIAUDEV.....	299
C1-RTAREAMEM.....	300
C1-MPCONCREA.....	301
C1-MEMSTPRE.....	301
C1-VALMEMBO.....	301
C1-MEMINACT.....	302
Late Setup Notification.....	302
Policy (Used for Searching).....	302
Search Policy.....	303
Searching for a Policy.....	307
Viewing the Policy Details.....	308
Defining a Policy.....	308
Associating a Person with a Policy.....	311
Defining a Characteristic for a Policy.....	313
Policy (Used for Viewing).....	314
Policy - Main.....	315
Policy.....	315
Policy Characteristics.....	321
Policy - Plan.....	322

Plans.....	322
Memberships.....	323
Policy - Log.....	324
Policy Log.....	324
Activating a Policy.....	325
Editing a Policy.....	325
Initiating the Cancellation Process for a Fully-Insured Group Policy.....	329
Canceling a Fully-Insured Group Policy.....	329
Initiating the Termination Process for a Fully-Insured Group Policy.....	330
Terminating a Fully-Insured Group Policy.....	331
Initiating the Reinstatement Process for a Fully-Insured Group Policy.....	331
Reinstating a Fully-Insured Group Policy.....	332
Viewing the Plans of a Fully-Insured Group Policy.....	333
Viewing the Memberships of a Fully-Insured Group Policy Plan.....	333
Viewing the Fully-Insured Group Policy Plan Details.....	334
Viewing the Membership Details of a Fully-Insured Group Policy Plan.....	335
Defining a Plan for a Fully-Insured Group Policy.....	336
Defining a Proration Rule for a Fully-Insured Group Policy Plan.....	338
Associating a Pricing Rule Type with a Fully-Insured Group Policy Plan.....	341
Defining a Characteristic for a Fully-Insured Group Policy Plan.....	342
Editing a Plan of a Fully-Insured Group Policy.....	343
Viewing the Log of a Policy.....	346
Adding a Log Entry for a Policy.....	346
Policy Plan (Used for Viewing).....	347
Policy Plan.....	347
Plan Characteristics.....	349
Memberships.....	350
Membership (Used for Searching).....	351
Search Membership.....	351
Searching for a Membership.....	357
Viewing the Membership Details.....	358
Defining a Membership for a Fully-Insured Group Policy Plan.....	359
Defining a Characteristic for a Membership.....	361
Membership (Used for Viewing).....	363
Membership - Main.....	363
Membership.....	363
Membership Characteristics.....	366
Member Persons.....	366
Member Person Characteristics.....	368
Other Plans of Main Subscriber.....	368
Membership - Contracts and Charges.....	369
Membership Contracts.....	369
Billable Charges.....	370
Bill Segment Details.....	372
Billable Charge Timeline Details.....	373
Pricing Calculation Details.....	373
Membership - Log.....	375
Membership Log.....	375
Editing a Membership of a Fully-Insured Group Policy Plan.....	376
Adding a Person to a Membership.....	377
Defining a Characteristic for a Member Person.....	379
Inactivating a Membership.....	380
Inactivating a Member Person.....	381
Editing the Membership Details of a Person.....	382
Associating a Contract with a Membership.....	384
Disassociating a Contract from a Membership.....	385

Editing the Contract Association Details of a Membership.....	386
Viewing the Characteristics of a Member Person.....	388
Viewing the Billable Charges Created for a Membership.....	388
Viewing the Bill Segments Generated for a Billable Charge.....	389
Viewing the Timeline Details of a Membership Billable Charge.....	389
Viewing the Pricing Calculation Details of a Timeline.....	390
Viewing the Log of a Membership.....	390
Adding a Log Entry for a Membership.....	391

Chapter 5: Self-Funded Group Health Insurance.....393

Pre-requisites.....	395
Self-Funded Policy.....	395
Self-Funded Policy Activation.....	397
Transition of Self-Funded Policy to Runout Status.....	398
Transition of Self-Funded Policy to Post Runout Status.....	398
Self-Funded Policy Renewal.....	399
Self-Funded Policy Contract Creation.....	399
Self-Funded Policy Status Transition.....	401
Algorithms Used in C1-ASOPolicy.....	404
C1-ASOPOLVAL.....	405
C1-ASOBOPOSP.....	406
C1-ASOPRUCPY.....	406
C1-ASOPOLMOA.....	406
C1-ASOPOLREN.....	407
C1-ASOPCKTD.....	407
Policy (Used for Searching).....	407
Search Policy.....	408
Searching for a Policy.....	412
Viewing the Policy Details.....	413
Defining a Policy.....	413
Associating a Person with a Policy.....	416
Defining a Characteristic for a Policy.....	418
Policy (Used for Viewing).....	419
Policy - Main.....	420
Policy.....	420
Policy Characteristics.....	426
Policy - Plan.....	427
Plans.....	427
Memberships.....	428
Policy - Log.....	429
Policy Log.....	429
Activating a Policy.....	430
Editing a Policy.....	430
Manually Changing the Status of a Self-Funded Policy to Runout.....	434
Renewing a Self-Funded Policy of a Bill Group.....	435
Viewing the Log of a Policy.....	438
Adding a Log Entry for a Policy.....	438

Chapter 6: Individual Health Insurance..... 441

Individual Membership.....	443
Individual Membership Termination.....	445
Individual Membership Renewal.....	446
Automatic Contract Creation for Individual Membership.....	447
Rate Guarantee for Individual Membership.....	447

Late Setup Notification.....	448
Individual Membership Preference.....	449
Searching for an Individual Membership Preference.....	449
Viewing the Individual Membership Preference Details.....	450
Defining an Individual Membership Preference.....	450
Editing an Individual Membership Preference.....	453
Copying an Individual Membership Preference.....	455
Deleting an Individual Membership Preference.....	457
Binder Payment for Individual Membership.....	457
Prerequisites.....	458
Algorithms Used in Binder Payment.....	459
C1-BNDRH.....	459
C1-BNFTODO.....	460
C1-CCPYTSADS.....	460
C1-FICRETBC.....	462
C1-THRSHDAMT.....	464
Binder Payment Creation.....	465
Binder Payment Monitoring.....	465
Binder Payment Preference.....	467
Searching for a Binder Payment Preference.....	468
Viewing the Binder Payment Preference Details.....	468
Defining a Binder Payment Preference.....	469
Editing a Binder Payment Preference.....	473
Copying a Binder Payment Preference.....	476
Deleting a Binder Payment Preference.....	480
Membership Status Reason Preference.....	480
Searching for a Membership Status Reason Preference.....	480
Viewing the Membership Status Reason Preference Details.....	481
Defining a Membership Status Reason Preference.....	481
Editing a Membership Status Reason Preference.....	483
Copying a Membership Status Reason Preference.....	486
Deleting a Membership Status Reason Preference.....	487

Chapter 7: Customer Registration.....489

Customer Registration (Without Approval) Status Transition.....	493
Customer Registration (With Approval) Status Transition.....	493
Customer Registration Template.....	495
Search Customer Registration Template.....	496
Customer Registration Template.....	498
Searching for a Customer Registration Template.....	499
Viewing the Customer Registration Template Details.....	500
Defining a Customer Registration Template.....	500
Adding the Pages and Sections in a Customer Registration Template.....	502
Setting the Field Attributes for a Template Section.....	508
Editing a Customer Registration Template.....	513
Copying a Customer Registration Template.....	515
Deleting a Customer Registration Template.....	516
Customer Registration Type.....	517
Customer Registration Type List.....	518
Customer Registration Type.....	519
Searching for a Customer Registration Type.....	525
Defining a Customer Registration Type.....	526
Defining Additional Data for a Customer Registration Type.....	529
Defining a Characteristic for a Customer Registration Type.....	533
Associating a Customer Registration Template with a Customer Registration Type.....	534

Setting Attributes to Define a Customer Registration Using the Existing Customer	
Registration.....	536
Editing a Customer Registration Type.....	539
Copying a Customer Registration Type.....	542
Deleting a Customer Registration Type.....	544
Viewing the Customer Registration Type Details.....	545
Customer Registration (Used for Searching).....	545
Search Customer Registration.....	546
Searching for a Customer Registration.....	556
Viewing the Customer Registration Details.....	557
Defining a Customer Registration.....	558
Adding the Names of a Person.....	561
Adding the Phone Details of a Person.....	562
Adding the Identifier Details of a Person.....	563
Adding the Contact Details of a Person.....	564
Defining a Characteristic for a Person.....	567
Defining a Person to Person Relationship for a Person.....	568
Defining a Characteristic for a Person to Person Relationship.....	570
Adding an Account for a Person.....	571
Adding the Identifier Details of an Account.....	575
Adding the Automatic Payment Details of an Account.....	576
Associating a Person to an Account.....	579
Adding the Bill Routing Information for an Account.....	581
Defining a Characteristic for an Account.....	582
Defining a Policy.....	583
Associating a Person to a Policy.....	586
Defining a Characteristic for a Policy.....	588
Adding a Plan in a Policy.....	589
Associating a Pricing Rule Type with a Policy Plan.....	591
Defining a Characteristic for a Policy Plan.....	592
Defining a Characteristic for a Customer Registration.....	594
Viewing the Details of an Account.....	595
Viewing the Details of a Statement Construct.....	595
Editing the Account Details of a Person.....	596
Copying a Customer Registration.....	599
Viewing the Parent Policies.....	602
Viewing the Details of a Policy.....	603
Editing the Policy Details.....	603
Viewing the Details of a Policy Plan.....	605
Editing the Policy Plan Details.....	606
Customer Registration (Used for Viewing).....	608
Customer Registration - Main.....	609
Customer Registration.....	609
Bill Group Information.....	614
Account Information.....	615
Statement Constructs.....	616
Policies.....	617
Parent Policies.....	617
Customer Registration - Account.....	618
Account Information.....	618
Customer Registration - Policy.....	622
Policy Information.....	622
Plans.....	623
Customer Registration - Plan Information.....	624
Plan Information.....	624
Customer Registration - Log.....	625

Customer Registration Log.....	625
Editing the Customer Registration Details.....	626
Submitting a Customer Registration.....	629
Approving a Customer Registration.....	629
Rejecting a Customer Registration.....	630
Requesting to Resubmit a Customer Registration for Approval.....	632
Viewing the Log of a Customer Registration.....	633
Adding a Log Entry for a Customer Registration.....	634
Chapter 8: Customer 360° View.....	637
Prerequisites.....	639
Customer 360° View.....	639
360° Search.....	639
Searching for a Person.....	648
Searching for an Account.....	649
Searching for a Policy.....	650
Viewing the 360° Information of a Person.....	651
Viewing the 360° Information of an Account.....	653
Viewing the 360° Information of a Policy.....	655
Viewing the Pricing Information of a Parent Customer.....	655
Viewing the Pricing Information of a Bill Group.....	657
Customer 360° Information.....	659
Customer 360° Information - Person.....	663
Person Information.....	665
Person Characteristics.....	666
Child Persons.....	667
Person Hierarchy.....	667
Person Billing Hierarchy.....	668
Bill Group Derivation and Pricing Parameters.....	671
Bill Group Sorting.....	673
Customer Contacts.....	674
Bill Groups Created Via Customer Registration.....	675
Customer 360° Information - Account.....	675
Account List.....	676
Account Information.....	677
Account Characteristics.....	679
Administrative Contracts.....	680
Auto Pay Details.....	680
Account Financial and Collections Summary.....	681
Billing and Adjustment Summary.....	681
Open Bills.....	682
Billed Vs Paid.....	684
Timeline.....	686
Trial Bills.....	689
Customer 360° Information - Policy.....	689
Policy List.....	691
Policy Information.....	692
Policy Persons.....	692
Policy Plans.....	693
Customer 360° Information - Pricing Information.....	693
Parent Customer Pricing Rules.....	696
Bill Group Self-Funded Policy Pricing Rule Summary.....	699
Parent Customer Pricing Rule Summary.....	700
Bill Group Self-Funded Policy Information.....	701
Bill Group Self-Funded Policy Pricing Rules.....	702

Bill Group Pricing Groups.....	707
Fully-Insured Pricing Rules.....	708
Pricing Rule Summary.....	709
Pricing Rule Approval Transactions.....	710
Defining a Sort ID for a Bill Group.....	711
Editing a Sort ID of a Bill Group.....	713
Deleting a Sort ID of a Bill Group.....	714
Creating a Bill Group Sorting Upload Request.....	715
Defining the Derivation and Pricing Parameters for a Bill Group and Sort ID Combination.....	717
Editing the Derivation and Pricing Parameters of a Bill Group and Sort ID Combination.....	719
Creating a Bill Group Derivation and Pricing Parameters Upload Request.....	721
Viewing the Pricing Rules Defined for a Self-Funded Policy of a Bill Group.....	723
Viewing the Pricing Rules Defined for a Self-Funded Parent Customer.....	723
Viewing the Pricing Groups of a Bill Group.....	724
Renewing a Self-Funded Policy of a Bill Group.....	725
Viewing the Bill Details.....	728
Viewing the Pricing Rules Defined for a Fully-Insured Group Policy Plan.....	729
Viewing the Pricing Rules Defined for a Fully-Insured Group Policy.....	730
Viewing the Pricing Rules Defined for a Fully-Insured Parent Customer.....	731
Viewing the Pricing Rules Defined for the State of Issue.....	732
Bill Information.....	732
Bill Information.....	733
Adjustments.....	733
Settlement Activities.....	734
Bill Segment Summary.....	734
Bill Segment Details.....	735
SQ Details.....	736
Bill Segment Calculation Lines.....	737
Transaction Details.....	737
Transaction Leg Calculation Lines.....	738
Hold Details.....	739
Offset Details.....	740
Refund and Write Off Details.....	740
Viewing the SQ Details of a Bill Segment.....	741
Viewing the Calculation Lines of a Bill Segment.....	742
Viewing the Transactions Whose Charges are Billed Through a Bill Segment.....	742
Viewing the Calculation Lines of All Legs of a Transaction.....	743

Chapter 9: Pricing Management (Health Insurance Business)..... 745

Prerequisites (Health Insurance Business).....	747
Pricing Methodologies and Pricing Variation Based on Parameters (Health Insurance Business)..	747
Parameter.....	752
Parameter (Used for Searching).....	753
Search Parameter.....	753
Searching for a Parameter.....	756
Defining a Parameter.....	756
Editing a Parameter.....	763
Deleting a Parameter.....	770
Copying a Parameter.....	771
Viewing the Parameter Details.....	778
Parameter (Used for Viewing).....	779
Parameter.....	779
Price Item (Health Insurance Business).....	781
Price Item (Used for Searching).....	782

Search Price Item.....	782
Searching for a Price Item or Price Item Bundle.....	785
Defining a Price Item or Price Item Bundle.....	785
Associating a Parameter with a Price Item or Price Item Bundle.....	793
Defining the Valid Predefined Parameter Values for a Price Item or Price Item Bundle.....	797
Associating a Price Item or Price Item Bundle with a Division.....	798
Associating an SQI with a Price Item or Price Item Bundle for a Division.....	802
Defining a Division-Specific Characteristic for a Price Item or Price Item Bundle.....	803
Defining the Accrual Type Criteria of a Price Item or Price Item Bundle for a Division.....	805
Associating a Price Item or Price Item Bundle with a Hierarchy Entity in an Entity Hierarchy Relationship of a Division.....	807
Defining the Cost of a Price Item or Price Item Bundle for a Division.....	809
Defining the Average Price Floor and Ceil Values of a Price Item or Price Item Bundle for a Division.....	812
Defining a Characteristic for a Price Item or Price Item Bundle.....	815
Copying a Price Item or Price Item Bundle.....	816
Viewing the Price Item or Price Item Bundle Details.....	825
Price Item (Used for Viewing).....	826
Price Item.....	826
Parameters.....	828
Predefined Parameter Values for Price Item.....	829
Divisions.....	829
Division-Specific SQIs for Price Item.....	830
Division-Specific Characteristics for Price Item.....	831
Division-Specific Accrual Type Criteria for Price Item.....	831
Division-Specific Hierarchy for Price Item.....	832
Division-Specific Cost for Price Item.....	833
Division-Specific Average Price Floor and Ceil Values for Price Item.....	833
Price Item Relationship.....	834
Editing a Price Item or Price Item Bundle.....	836
Price List.....	844
Price List (Used for Searching).....	844
Search Price List.....	845
Price List Price Items.....	848
Searching for a Price List.....	849
Viewing Price Items Assigned to a Price List.....	850
Defining a Price List.....	850
Defining the Price List Hierarchy.....	853
Defining a Characteristic for a Price List.....	854
Associating a Price List with a Division.....	855
Defining Eligibility Criteria for a Price List.....	856
Copying a Price List.....	857
Viewing the Price List Details.....	859
Price List (Used for Viewing).....	860
Price List.....	860
Eligibility Criteria.....	862
Editing a Price List.....	863
Price List Price Item Pricing.....	865
Price List Price Items.....	866
Search Price Item.....	868
Viewing Price Items Assigned to a Price List.....	873
Removing a Price Item from a Price List.....	874
Viewing a Price Item Pricing.....	874

Editing a Price Item Pricing of a Price List.....	876
Assigning a Price Item to a Price List.....	881
Defining a Characteristic for a Price Item Pricing.....	888
Defining Parameters for a Price Item Pricing.....	889
Defining TFM Information in a Price Item Pricing.....	890
Price List Assignment.....	891
Price List Assignments.....	892
Price List Price Items.....	894
Search Price List for Assignment.....	896
Viewing Price Lists Assigned to an Account.....	898
Viewing Price Lists Assigned to a Person.....	899
Viewing Price Items Assigned to a Price List.....	900
Assigning a Price List to an Account.....	901
Assigning a Price List to a Person.....	904
Defining a Characteristic for a Price List Assignment.....	907
Editing the Price List Assignment Details of an Account.....	908
Editing the Price List Assignment Details of a Person.....	911
Price List Assignments.....	914
Accounts where Price List is Assigned.....	914
Persons to whom Price List is Assigned.....	915
Viewing Accounts and Persons where Price List is Assigned.....	916
Entities Eligible for Price List Assignment.....	916
Eligible Accounts.....	917
Eligible Persons.....	917
Assigning a Price List to One or More Eligible Accounts.....	918
Assigning a Price List to One or More Eligible Persons.....	920
Defining a Characteristic for a Price List Assignment.....	921
Rate Definition.....	923
Rate Schedule Components.....	923
Create/Edit Rate Definition.....	924
Defining Tiering Setup of a Rate Component.....	925
Editing Tiering Setup of a Rate Component.....	926
Deleting Tiering Setup of a Rate Component.....	927
Tiering Criterion.....	928
Tiering Criterion List.....	928
Edit Tiering Criterion.....	928
Create Tiering Criterion.....	929
Creating a Tiering Criterion.....	929
Editing a Tiering Criterion.....	930

Chapter 10: Division..... 933

Division.....	934
Division - Main.....	936
Division - Access Groups.....	937
Division - Price Items.....	938
Division - Price Lists.....	938
Division - Languages.....	939
Division - Invoice Currencies.....	939
Division - Person Identifier Types.....	939
Division - Algorithms.....	940
Division - Characteristics.....	940
Division - Bill Messages.....	941
Division - Party Char Types.....	941
Division - Bill Cycles.....	941
Division - Account Identifier Types.....	942

Division - Price Item Characteristics.....	942
Searching for a Division.....	943
Defining a Division.....	944
Associating an Access Group with a Division.....	947
Associating a Price Item or Price Item Bundle with a Division.....	948
Associating a Price List with a Division.....	950
Associating a Language with a Division.....	951
Associating an Invoice Currency with a Division.....	952
Associating a Person Identifier Type with a Division.....	953
Associating an Algorithm with a Division.....	954
Defining a Characteristic for a Division.....	961
Associating a Bill Message with a Division.....	962
Associating a Party Characteristic Type with a Division.....	964
Associating a Bill Cycle with a Division.....	965
Associating an Account Identifier Type with a Division.....	966
Defining a Division-Specific Characteristic for a Price Item.....	967
Associating a To Do Type and To Do Role with a Division.....	968

Chapter 11: Approval Workflow..... 971

Most Commonly Used Terms.....	973
Approval Workflow Process.....	973
Prerequisites.....	975
Approval Transaction.....	977
Search Approval Transaction.....	977
Approval Transaction Log.....	981
Searching for an Approval Transaction.....	982
Viewing the Log of an Approval Transaction.....	982
Comparison: New versus Existing.....	983
Approving an Approval Transaction.....	983
Rejecting an Approval Transaction.....	984
Canceling an Approval Transaction.....	985
Modifying an Approval Transaction.....	986
Withdrawing an Approval Transaction.....	987
Resolving an Approval Transaction.....	987
Approve Price Assignment.....	988
Search.....	988
List of Price Assignments.....	991
Approve Price Assignment - Comparison: New versus Existing.....	992
Approval Transaction Log.....	994
Approving a Price Assignment for an Account.....	995
Approving a Price Assignment for a Person.....	996
Approving a Price Assignment for a Price List.....	997
Rejecting a Price Assignment for an Account.....	998
Rejecting a Price Assignment for a Person.....	999
Rejecting a Price Assignment for a Price List.....	1001
Canceling a Price Assignment for an Account.....	1002
Canceling a Price Assignment for a Person.....	1003
Canceling a Price Assignment for a Price List.....	1005
Modify Price Assignment.....	1006
Search.....	1006
List of Price Assignments.....	1010
Modifying a Price Assignment for an Account.....	1011
Modifying a Price Assignment for a Person.....	1012
Modifying a Price Assignment for a Price List.....	1013
Withdrawing a Price Assignment for an Account.....	1013

Withdrawing a Price Assignment for a Person.....	1014
Withdrawing a Price Assignment for a Price List.....	1015
Viewing the Log of an Approval Transaction.....	1016
Resolve Price Assignment.....	1017
Search.....	1017
List of Price Assignments.....	1021
Resolving a Price Assignment for an Account.....	1022
Resolving a Price Assignment for a Person.....	1023
Resolving a Price Assignment for a Price List.....	1024
Withdrawing a Price Assignment for an Account.....	1024
Withdrawing a Price Assignment for a Person.....	1025
Withdrawing a Price Assignment for a Price List.....	1026
Viewing the Log of an Approval Transaction.....	1027
Approval Workflow Group (Used for Searching).....	1028
Search Approval Workflow Group.....	1028
Searching for an Approval Workflow Group.....	1029
Viewing the Approval Workflow Group Details.....	1030
Defining an Approval Workflow Group.....	1030
Adding a Business Object.....	1034
Defining a Group BO Relation.....	1036
Approval Workflow Group (Used for Viewing).....	1037
Approval Workflow Group.....	1038
Editing an Approval Workflow Group.....	1040
Deleting an Approval Workflow Group.....	1040
Editing a Business Object.....	1041
Deleting a Business Object.....	1043
Editing a Group BO Relation.....	1043
Deleting a Group BO Relation.....	1045
Approval Workflow Chain (Used for Searching).....	1045
Search Approval Workflow Chain.....	1045
Searching for an Approval Workflow Chain.....	1046
Viewing the Approval Workflow Chain Details.....	1047
Defining an Approval Workflow Chain.....	1047
Defining Approval Levels for an Approval Workflow Chain.....	1048
Approval Workflow Chain (Used for Viewing).....	1049
Approval Workflow Chain.....	1049
Editing an Approval Workflow Chain.....	1050
Deleting an Approval Workflow Chain.....	1051
Approval Workflow Criterion Type (Used for Searching).....	1052
Search Approval Workflow Criterion Type.....	1052
Searching for an Approval Workflow Criterion Type.....	1052
Viewing the Approval Workflow Criterion Type Details.....	1053
Defining an Approval Workflow Criterion Type.....	1053
Approval Workflow Criterion Type (Used for Viewing).....	1055
Approval Workflow Criterion Type.....	1055
Editing an Approval Workflow Criterion Type.....	1056
Deleting an Approval Workflow Criterion Type.....	1058
Approval Workflow Group Chain Linkage (Used for Searching).....	1058
Search Approval Workflow Group Chain Linkage.....	1058
Searching for an Approval Workflow Group Chain Linkage.....	1059
Viewing the Approval Workflow Group Chain Linkage Details.....	1060
Defining an Approval Workflow Group Chain Linkage.....	1060
Defining Group Chain Linkage Criteria for an Approval Workflow.....	1062
Defining a Field Approval Rule.....	1062
Approval Workflow Group Chain Linkage (Used for Viewing).....	1064
Approval Workflow Group Chain Linkage.....	1065

Editing an Approval Workflow Group Chain Linkage.....	1067
Deleting an Approval Workflow Group Chain Linkage.....	1068
Approval Workflow Setting (Used for Searching).....	1068
Search Approval Workflow Group.....	1068
Searching for an Approval Workflow Group.....	1069
Viewing the Approval Workflow Setting Details.....	1070
Defining Approval Workflow Group Settings.....	1070
Approval Workflow Setting (Used for Viewing).....	1072
Approval Workflow Group Settings.....	1072
Editing Approval Workflow Group Settings.....	1074
Deleting Approval Workflow Group Settings.....	1074
Regenerating Input and Display UI Maps.....	1075
Approval Workflow Reason (Used for Searching).....	1075
Approval Workflow Reason List.....	1075
Filtering the Approval Workflow Reasons.....	1076
Viewing the Approval Workflow Reason Details.....	1077
Defining an Approval Workflow Reason.....	1077
Approval Workflow Reason (Used for Viewing).....	1078
Approval Workflow Reason.....	1078
Editing an Approval Workflow Reason.....	1079
Deleting an Approval Workflow Reason.....	1080

Chapter 12: Rules Engine..... 1081

Rule Type (Used for Searching).....	1083
Search Rule Type.....	1083
Searching for a Rule Type.....	1084
Defining a Rule Type.....	1085
Defining Input and Output Parameters for a Rule Type.....	1087
Associating a Characteristic Entity with a Rule Type.....	1089
Associating an Algorithm with a Rule Type.....	1090
Editing a Rule Type.....	1091
Deleting a Rule Type.....	1094
Copying a Rule Type.....	1094
Rule Type (Used for Viewing).....	1096
Rule Type.....	1097
Viewing the Rule Type Details.....	1098
Editing a Rule Type.....	1099
Rule.....	1101
Search Rule.....	1101
Searching for a Rule.....	1102
Viewing the Rule Details.....	1103
Defining a Rule.....	1103
Editing a Rule.....	1109
Deleting a Rule.....	1115
Copying a Rule.....	1116
Rule.....	1122
Rule Information.....	1122
Viewing the Rule Details.....	1124
Rule Check.....	1124
Rule Check.....	1126

Chapter 13: Alternate Sequential Bill Numbers.....1129

Alternate Sequential Bill Number Generation Algorithms.....	1130
C1_ALTBLLSYS.....	1130

C1_ALTBSYS1.....	1130
C1_ALTBLDV.....	1133
C1_ALTBLDIV1.....	1133
Enabling the Alternate Sequential Bill Numbers Feature.....	1136

Chapter 14: Transaction Feed Management..... 1139

Prerequisites.....	1140
Transaction Rating Before Billing.....	1140
Transaction Aggregation.....	1149
Header Validation.....	1150
Transaction Validation and Initial Price Item Determination.....	1152
Price Item Pricing Verification.....	1163
Aggregation.....	1168
Clean Up.....	1172
Transaction Aggregation Batch Processing.....	1174
Transaction Disaggregation.....	1177
Transaction Disaggregation Batch Processing.....	1184
Reseeding.....	1185
Transaction Cancellation.....	1188
Transaction Cancellation Batch Processing.....	1191
Transaction Rollback.....	1192
Feed Status Transition.....	1194
Transaction Status Transition.....	1195
Transaction Leg Status Transition.....	1196
Transaction Data File.....	1204
Error List.....	1207
Alert Notification for Transaction Feed Management.....	1243
Feed Management Dashboard.....	1243
Search.....	1244
Division Level Information.....	1250
Transaction Level Information.....	1251
Transaction Leg Information.....	1252
Transaction Leg Service Quantity.....	1253
Transaction Leg Calculation Lines.....	1254
Transaction Leg Calc Line Characteristics.....	1255
Searching for a Transaction Feed.....	1255
Viewing Division Level Details of a Transaction Feed.....	1256
Viewing Transactions that Belong to a Division.....	1256
Viewing Legs of a Transaction.....	1257
Viewing the SQIs Calculated for a Transaction Leg.....	1258
Viewing the Calculation Lines of a Transaction Leg.....	1258
Viewing Characteristics of a Calculation Line.....	1259
Transaction Details.....	1259
Search.....	1259
Transaction Legs.....	1263
Transaction Error Messages.....	1266
Searching for a Transaction.....	1267
Viewing the Transaction Legs.....	1267
Viewing Error Messages.....	1268
Viewing the Transaction Details.....	1268
Adding a Transaction.....	1269
Copying a Transaction.....	1271
Transaction Source.....	1274
Search Transaction Source.....	1274
Searching for a Transaction Source.....	1275

Defining a Transaction Source.....	1275
Editing a Transaction Source.....	1276
Deleting a Transaction Source.....	1277
Copying a Transaction Source.....	1277
Transaction Record Type.....	1278
Search Transaction Record Type.....	1279
Searching for a Transaction Record Type.....	1280
Defining a Transaction Record Type.....	1280
Editing a Transaction Record Type.....	1286
Deleting a Transaction Record Type.....	1292
Copying a Transaction Record Type.....	1293
Transaction Aggregation Rule.....	1298
Transaction Aggregation Rules.....	1298
Defining Transaction Aggregation Rule for an SQL.....	1299
Editing Transaction Aggregation Rule of an SQL.....	1300
Deleting Transaction Aggregation Rule of an SQL.....	1301
Schedule.....	1302
Search Schedule.....	1302
Searching for a Schedule.....	1303
Viewing the Schedule Details.....	1303
Defining a Schedule.....	1304
Editing a Schedule.....	1305
Deleting a Schedule.....	1306
Disaggregation Request.....	1307
Search Disaggregation Request.....	1307
Searching for a Disaggregation Request.....	1312
Creating a Disaggregation Request for a Person.....	1313
Creating a Disaggregation Request for an Account.....	1319
Creating a Disaggregation Request for a Price item.....	1325
Creating a Disaggregation Request for a Price Assignment.....	1331
Creating a Disaggregation Request for a Billable Charge.....	1335
Creating a Reseeding Request for a Parent Accumulation Group.....	1339
Deleting a Disaggregation Request.....	1342

Chapter 15: Upload Validated Payment Data..... 1345

Payment Upload Process.....	1346
Upload Payment Records in the Pre-Staging Area.....	1346
Move Payment Records to the Staging Area.....	1347
Create Payment Events and Payments.....	1347
Prerequisites.....	1348
CSV File Format.....	1349
Payment Data File Status Transition.....	1351
Payment Record Status Transition.....	1351
Error Messages.....	1353
Payment Upload.....	1357
Search Payment Data File.....	1358
Payment Data Records.....	1360
Payment Data File Log.....	1361
Searching for a Payment Data File.....	1362
Uploading a Payment Data File.....	1362
Replacing an Existing File.....	1364
Cancelling a Payment Data File.....	1365
Moving the Payment Records to the Staging Area.....	1365
Editing a Payment Staging Record.....	1366
Viewing the Records of a Payment Data File.....	1367

Viewing the Log of a Payment Data File.....	1367
Viewing the Error Messages.....	1368

Chapter 16: Freeze Payments on Notification..... 1369

Freeze Payments on Notification Process.....	1371
Creating Automatic Payments and Refunds.....	1371
Generating a Flat File.....	1371
Uploading Response from Auto Clearing House (ACH).....	1371
Retry Automatic Payment.....	1372
Freezing or Canceling Automatic Payments.....	1373
Voiding Refund Requests and Canceling Refund Adjustments.....	1373
Generating To Do Entries.....	1374
Creating Tender Controls.....	1374
Prerequisites.....	1374
Automatic Payment or Refund Clearing Staging Record Status Transition.....	1375
EDI 824 File Format.....	1376
Sample EDI 824 File Format.....	1377
Automatic Payment and Refund Upload Reason.....	1377
Upload Reasons.....	1378
Defining an Upload Reason.....	1378
Editing an Upload Reason.....	1380
Deleting an Upload Reason.....	1382
Automatic Payment and Refund Clearing Staging.....	1383
Search Clearing Record.....	1383
Associated Clearing Staging Records.....	1385
Clearing Staging Upload Reasons.....	1386
Clearing Staging Characteristics.....	1387
Searching for a Clearing Record.....	1387
Viewing the Clearing Staging Records Associated to a Clearing Record.....	1388
Viewing the Upload Reason Specified in the Clearing Staging Record.....	1388
Viewing the Characteristics of the Clearing Staging Record.....	1389
Editing a Clearing Staging Record.....	1389
Defining a Characteristic for a Clearing Staging Record.....	1391
Deleting a Clearing Staging Record.....	1392

Chapter 17: Trial Billing..... 1395

Prerequisites.....	1397
Trial Bill (Used for Searching).....	1397
Search Trial Bill	1397
Searching for a Trial Bill.....	1399
Viewing the Trial Bill Details.....	1399
Trial Bill (Used for Viewing).....	1400
Trial Bill.....	1400
Trial Bill Segments.....	1402
Trial Bill Segment Calc Lines.....	1403
Trial Bill Segment SQ Details.....	1404
Trial Bill Segment Financial Details.....	1405
Policy Details.....	1405
Printing a Trial Bill in the PDF Format.....	1406
Viewing the Segments of a Trial Bill.....	1406
Filtering the Trial Bill Segments.....	1407
Viewing the Calc Lines of a Trial Bill Segment.....	1407
Viewing the SQ Details of a Trial Bill Segment.....	1408
Viewing the Financial Details of a Trial Bill Segment.....	1408

Viewing the Policy Details of a Trial Bill Segment.....	1409
Chapter 18: GL Account Validation.....	1411
Static GL Account Validation.....	1412
Dynamic GL Account Validation.....	1412
Chapter 19: Upload Validated Adjustment Data.....	1413
Prerequisites.....	1415
CSV File Format.....	1415
Adjustment Upload Request (Without Approval) Status Transition.....	1416
Adjustment Upload Request (With Approval) Status Transition.....	1417
Algorithms Used in C1-ADJUPLD.....	1418
Upload Request Type.....	1421
Upload Request Type List.....	1422
Upload Request Type.....	1423
Defining an Upload Request Type.....	1426
Defining a Characteristic for an Upload Request Type.....	1432
Editing an Upload Request Type.....	1433
Copying an Upload Request Type.....	1436
Mapping an Upload Request Type.....	1440
Deleting an Upload Request Type.....	1441
Viewing the Upload Request Type Details.....	1442
Adjustment Upload Request (Used for Searching).....	1443
Search Adjustment Upload Request.....	1443
Searching for an Adjustment Upload Request.....	1445
Uploading an Adjustment Data File.....	1445
Replacing an Adjustment Data File.....	1448
Viewing the Adjustment Upload Request Details.....	1450
Adjustment Upload Request (Used for Viewing).....	1451
Adjustment Upload Request - Main.....	1451
Adjustment Upload Request.....	1451
Adjustment Data Records.....	1454
Adjustment Upload Request - Log.....	1455
Adjustment Upload Request Log.....	1455
Cancelling an Adjustment Data File.....	1455
Creating Adjustments for an Adjustment Data File.....	1456
Submitting an Adjustment Data File for Approval.....	1457
Approving an Adjustment Data File.....	1458
Rejecting an Adjustment Data File.....	1459
Viewing the Log of an Adjustment Upload Request.....	1460
Adding a Log Entry for an Adjustment Upload Request.....	1461
Chapter 20: Payment Request.....	1463
Prerequisites.....	1465
Payment Request (Without Approval) Status Transition.....	1466
Payment Request (With Approval) Status Transition.....	1467
Algorithms Used in C1-PaymentRequest.....	1468
Algorithms Used in C1-PaymentTransferRequest.....	1472
Payment Request Type.....	1477
Payment Request Type List.....	1477
Payment Request Type.....	1478
Defining a Payment Request Type.....	1480
Defining a Characteristic for a Payment Request Type.....	1483

Editing a Payment Request Type.....	1484
Copying a Payment Request Type.....	1487
Deleting a Payment Request Type.....	1490
Viewing the Payment Request Type Details.....	1491
Payment Request (Used for Searching).....	1491
Search Payment Request.....	1492
Searching for a Payment Request.....	1494
Viewing the Payment Request Details.....	1495
Payment Request (Used for Viewing).....	1496
Payment Request - Main.....	1496
Payment Request.....	1496
Payment Distribution.....	1502
Payment Request - Log.....	1504
Payment Request Log.....	1504
Creating a Payment Creation Request.....	1505
Defining a Characteristic for a Payment Tender.....	1510
Editing the Payment Amount.....	1511
Editing a Payment Request.....	1513
Deleting a Payment Request.....	1516
Distributing the Tender or Payment Amount.....	1517
Distributing and Freezing the Tender or Payment Amount.....	1518
Redistributing the Tender or Payment Amount.....	1519
Editing the Payment Segment Amount.....	1520
Freezing Payments Created Through a Payment Request.....	1522
Submitting a Payment Request for Approval.....	1523
Approving a Payment Request.....	1523
Rejecting a Payment Request.....	1525
Discarding a Payment Request.....	1527
Viewing the Log of a Payment Request.....	1527
Adding a Log Entry for a Payment Request.....	1528
Payment Event Summary.....	1529
Search Payment Event.....	1529
Payments.....	1532
Payment Segments.....	1534
Searching for a Payment Event.....	1534
Creating a Payment Transfer Request.....	1535
Cancelling a Payment Event.....	1539
Deleting a Payment Event.....	1540
Viewing Payments Created Through a Payment Event.....	1540
Cancelling a Payment.....	1541
Deleting a Payment.....	1541
Viewing Payment Segments of a Payment.....	1542

Chapter 21: Account Receivable Central..... 1543

Single Offset.....	1544
Mass Offset.....	1544
Cross Currency Offset.....	1545
Hold.....	1545
Refund.....	1546
Write Off.....	1546
Dispute.....	1546
Account Receivable Central.....	1546
Search Bill	1546
Bill Information.....	1550
Offset Details.....	1550

Hold Details.....	1550
Garnishment Details.....	1551
Bill Line Items.....	1551
Searching for a Bill.....	1551
Viewing the Bill Details.....	1552

Chapter 22: Offset Request..... 1553

Single Offset.....	1555
Mass Offset.....	1556
Cross Currency Offset.....	1559
Prerequisites.....	1561
Offset Request (Without Approval) Status Transition.....	1562
Offset Request (With Approval) Status Transition.....	1563
Algorithms Used in C1-OffsetRequest.....	1565
C1-OFFST-INF.....	1566
F1-TODOCOMPL.....	1566
C1-OFFSUBENT.....	1566
C1-OFFAPPENT.....	1566
C1-OFFAPPEXT.....	1567
C1-OFSAPRENT.....	1567
F1-AT-RQJ.....	1567
C1-OFST-DIST.....	1567
C1-UPD-HOLD.....	1568
C1-UPD-FUND.....	1568
C1-DFRUNAPLY.....	1568
C1-UNAPOFST.....	1569
C1-UPDT-FUND.....	1569
C1-WTBS-CRBL.....	1569
Additional Algorithms Used in Offset Request.....	1569
C1-OFST-AMT.....	1569
C1-WTBS-CRBL.....	1570
Offset Request Type.....	1570
Offset Request Type List.....	1570
Offset Request Type.....	1571
Defining an Offset Request Type.....	1573
Defining a Characteristic for an Offset Request Type.....	1578
Editing an Offset Request Type.....	1579
Deleting an Offset Request Type.....	1584
Copying an Offset Request Type.....	1585
Viewing the Offset Request Type Details.....	1589
Offset Request (Used for Searching).....	1590
Search Offset Request.....	1590
Searching for an Offset Request.....	1593
Creating an Offset Request.....	1594
Viewing the Offset Request Details.....	1596
Offset Request (Used for Viewing).....	1597
Offset Request - Main.....	1597
Offset Request.....	1597
Selected Bills.....	1600
Search Bill.....	1601
Offset Request Adjustments.....	1606
Offset Request - Log.....	1606
Offset Request Log.....	1606
Viewing the Debit and Credit Bills Added to an Offset Request.....	1607
Viewing the Adjustments Created Through an Offset Request.....	1607

Adding a Debit or Credit Bill to an Offset Request.....	1608
Editing an Offset Request.....	1609
Defining a Characteristic for an Offset Request.....	1610
Editing the Offset Amount of a Debit or Credit Bill.....	1612
Removing a Debit or Credit Bill from an Offset Request.....	1613
Deleting an Offset Request.....	1613
Submitting an Offset Request.....	1614
Approving an Offset Request.....	1616
Rejecting an Offset Request.....	1618
Unapplying an Offset Request.....	1620
Viewing the Log of an Offset Request.....	1621
Adding a Log Entry for an Offset Request.....	1621

Chapter 23: Funding Request..... 1623

Prerequisites.....	1626
Funding Request (Without Approval) Status Transition.....	1626
Funding Request (With Approval) Status Transition.....	1627
Algorithms Used in C1-FundingReq.....	1628
C1-FUNDINFO.....	1629
C1-FUNDSUBMT.....	1629
C1-FUNDAPP.....	1630
C1-FUNDAPRVD.....	1630
F1-TODOCOMPL.....	1630
F1-AT-RQJ.....	1630
C1-FNDRESUBM.....	1631
C1-FUNDVAL.....	1631
C1-FUNDAPAY.....	1631
C1-FUNDADJCR.....	1631
C1-FUNDCANCL.....	1632
Funding Request Type.....	1632
Funding Request Type List.....	1632
Funding Request Type.....	1633
Defining a Funding Request Type.....	1636
Defining a Characteristic for a Funding Request Type.....	1643
Editing a Funding Request Type.....	1644
Deleting a Funding Request Type.....	1651
Copying a Funding Request Type.....	1652
Viewing the Funding Request Type Details.....	1659
Funding Request (Used for Searching).....	1660
Search Funding Request.....	1660
Searching for a Funding Request.....	1663
Creating a Funding Request.....	1664
Viewing the Funding Request Details.....	1664
Funding Request (Used for Viewing).....	1665
Funding Request - Main.....	1665
Funding Request.....	1666
Search Bill.....	1669
Funding Request - Bills.....	1673
Currency Statistics.....	1673
Selected Bills.....	1673
Funding Payment Details.....	1676
Funding Adjustments.....	1677
Funding Request - Log.....	1677
Funding Request Log.....	1677
Adding a Debit or Credit Bill to a Funding Request.....	1678

Deleting a Debit or Credit Bill from a Funding Request.....	1679
Excluding a Bill from a Funding Request.....	1679
Editing a Funding Request.....	1681
Defining a Characteristic for a Funding Request.....	1683
Deleting a Funding Request.....	1684
Cancelling a Funding Request.....	1685
Submitting a Funding Request.....	1686
Approving a Funding Request.....	1688
Rejecting a Funding Request.....	1690
Requesting to Resubmit a Funding Request.....	1692
Withdrawing a Funding Request.....	1693
Transferring the Funding Amount of a Credit Bill to a Garnishment Contract.....	1694
Viewing the Garnishment Details of a Credit Bill.....	1695
Viewing the Payments Created Through a Funding Request.....	1696
Viewing the Adjustments Created Through a Funding Request.....	1697
Viewing the Log of a Funding Request.....	1697
Adding a Log Entry for a Funding Request.....	1698

Chapter 24: Refund/Write Off Request..... 1699

Refund Request (Without Approval) Status Transition.....	1701
Refund Request (With Approval) Status Transition.....	1701
Write Off Request (Without Approval) Status Transition.....	1702
Write Off Request (With Approval) Status Transition.....	1703
Algorithms Used in C1-RefundReq.....	1704
Algorithms Used in C1-WORequest.....	1709
Prerequisites.....	1713
Refund/Write Off Request Type.....	1713
Refund/Write Off Request Type List.....	1717
Refund/Write Off Request Type.....	1718
Defining a Refund or Write Off Request Type.....	1720
Defining a Characteristic for a Refund or Write Off Request Type.....	1723
Editing a Refund or Write Off Request Type.....	1724
Copying a Refund or Write Off Request Type.....	1728
Deleting a Refund or Write Off Request Type.....	1731
Viewing the Refund or Write Off Request Type Details.....	1732
Refund/Write Off Request.....	1733
Search Refund/Write Off Request.....	1733
Searching for a Refund or Write Off Request.....	1737
Creating a Refund Request.....	1738
Creating a Write Off Request.....	1740
Viewing the Refund Request Details.....	1743
Viewing the Write Off Request Details.....	1743
Refund Request.....	1744
Refund Request - Main.....	1745
Refund Request.....	1745
Refund Details.....	1747
Bill Line Items.....	1748
Refund Request - Bills.....	1749
Search Bills.....	1749
Bill Line Items.....	1751
Refund Request - Payments.....	1751
Search Payment Event.....	1752
Payments.....	1753
Refund Request - Log.....	1753
Refund Request Log.....	1754

Creating a Refund Request.....	1754
Defining a Characteristic for a Refund Request.....	1757
Adding a Payment Event to the Refund Request.....	1758
Adding a Payment to the Refund Request.....	1759
Adding a Credit Bill to the Refund Request.....	1760
Adding a Credit Bill Line Item to the Refund Request.....	1761
Editing a Refund Request.....	1762
Editing the Refund Details.....	1765
Deleting a Refund Request.....	1767
Deleting a Bill from the Refund Request.....	1767
Deleting a Bill Line Item from the Refund Request.....	1768
Submitting a Refund Request.....	1768
Approving a Refund Request.....	1771
Rejecting a Refund Request.....	1773
Viewing the Log of a Refund Request.....	1774
Adding a Log Entry for a Refund Request.....	1775
Voiding a Refund Request.....	1776
Write Off Request.....	1777
Write Off Request - Main.....	1778
Write Off Request.....	1778
Write Off Details.....	1780
Bill Line Items.....	1781
Write Off Request - Bills.....	1782
Search Bills.....	1782
Bill Line Items.....	1783
Write Off Request - Log.....	1784
Write Off Request Log.....	1784
Creating a Write Off Request.....	1785
Defining a Characteristic for a Write Off Request.....	1787
Adding a Debit Bill to the Write Off Request.....	1788
Adding a Debit Bill Line Item to the Write Off Request.....	1790
Editing a Write Off Request.....	1791
Editing the Write Off Details.....	1793
Deleting a Write Off Request.....	1795
Deleting a Bill from the Write Off Request.....	1795
Deleting a Bill Line Item from the Write Off Request.....	1796
Submitting a Write Off Request.....	1796
Approving a Write Off Request.....	1798
Rejecting a Write Off Request.....	1800
Viewing the Log of a Write Off Request.....	1801
Adding a Log Entry for a Write Off Request.....	1802
Cancelling a Write Off Request.....	1803

Chapter 25: Hold Request..... 1805

Prerequisites.....	1808
Hold Request (Without Approval) Status Transition.....	1808
Hold Request (With Approval) Status Transition.....	1810
Types of Hold Processes.....	1812
Auto Pay.....	1812
Bill Generation.....	1813
Funding.....	1814
Overdue.....	1816
Algorithms Used in C1-HoldRequest.....	1818
C1-HLDARCTRN.....	1818
F1-TODOCOMPL.....	1819

C1-HOLDSUBMT.....	1819
F1-AT-RQJ.....	1819
C1-HOLDAPP.....	1819
C1-HOLDAPRVD.....	1819
C1-HLDRESUBM.....	1819
C1-HOLDACTV.....	1819
C1-RELENTITY.....	1820
C1-RLSHOLD.....	1820
Hold Request Type.....	1820
Hold Request Type List.....	1821
Hold Request Type.....	1821
Defining a Hold Request Type.....	1824
Defining Hold Process for a Hold Request Type.....	1827
Defining a Characteristic for a Hold Request Type.....	1827
Editing a Hold Request Type.....	1828
Deleting a Hold Request Type.....	1832
Copying a Hold Request Type.....	1832
Viewing the Hold Request Type Details.....	1836
Hold Request (Used for Searching).....	1836
Search Hold Request.....	1836
Searching for a Hold Request.....	1840
Creating a Hold Request.....	1841
Adding an Entity in a Hold Request.....	1844
Adding a Process in a Hold Request.....	1845
Viewing the Hold Request Details.....	1846
Hold Request (Used for Viewing).....	1847
Hold Request - Main.....	1847
Hold Request.....	1848
Hold Entities.....	1850
Search Account.....	1851
Search Bill.....	1855
Search Person.....	1857
Hold Request - Log.....	1859
Hold Request Log.....	1859
Searching Persons.....	1860
Searching Accounts.....	1860
Searching Bills.....	1861
Adding Persons in a Hold Request.....	1861
Adding Accounts in a Hold Request.....	1862
Adding Bills in a Hold Request.....	1862
Adding Processes in a Hold Request.....	1863
Defining a Characteristic for a Hold Request.....	1864
Editing a Hold Request.....	1865
Editing the Entity Details in a Hold Request.....	1867
Deleting an Entity from a Hold Request.....	1868
Deleting a Hold Request.....	1869
Submitting a Hold Request.....	1869
Approving a Hold Request.....	1870
Releasing a Hold Request.....	1871
Rejecting a Hold Request.....	1873
Resubmitting a Hold Request.....	1874
Viewing the Log of a Hold Request.....	1875
Adding a Log Entry for a Hold Request.....	1876

Chapter 26: Delinquency Central..... 1879

Prerequisites.....	1880
Delinquency Central (Used for Viewing).....	1880
Search Overdue Process.....	1880
Overdue Events.....	1885
Searching for an Overdue Process.....	1886
Viewing Events of an Overdue Process.....	1886
Viewing the Overdue Process Details.....	1887
Overdue Process Information for Account: {Account ID}.....	1887
Person Information.....	1888
Account Information.....	1888
Customer Contact Details.....	1888
Promise To Pay.....	1888
Hold Details.....	1889
Overdue Bills.....	1889
Payment Arrangement.....	1890
Search Bill.....	1890
Searching for a Bill.....	1891
Adding the Customer Contact Details.....	1892
Creating a Hold Request for an Overdue Process.....	1892
Creating a Payment Arrangement for an Overdue Process.....	1893
Defining a Promise To Pay for an Overdue Process.....	1893

Chapter 27: Upload Request..... 1895

Upload Request (Without Approval) Status Transition.....	1898
Upload Request (With Approval) Status Transition.....	1899
Prerequisites.....	1900
Algorithms Used in C1-BillCycleUpdateUpReq.....	1901
Algorithms Used in C1-ContractRiderUpdateUpReq.....	1906
Algorithms Used in C1-HoldUploadRequest.....	1911
Algorithms Used in C1-RefundUploadRequest.....	1918
Algorithms Used in C1-WriteOffUploadRequest.....	1922
Algorithms Used in C1-BillableChargeUploadRequest.....	1926
Algorithms Used in C1-ReinstatementUploadRequest.....	1930
Algorithms Used in C1-BillGrpSortUploadRequest.....	1936
C1-BLSRTUPLD.....	1937
C1-BLSRTDERV.....	1937
C1-BLSRTVALD.....	1937
F1-AT-RQJ.....	1938
C1-UPLSUBENT.....	1938
C1-DEFERUPLD.....	1938
C1-UPLAPPENT.....	1938
C1-UPLAPPEXT.....	1938
F1-TODOCOMPL.....	1938
C1-BLSRTPROC.....	1939
Algorithms Used in C1-BillLevelUploadRequest.....	1939
C1-BLVUPLDTL.....	1940
C1-BLVLDERIV.....	1940
C1-BLVLVALID.....	1940
F1-AT-RQJ.....	1941
C1-UPLSUBENT.....	1941
C1-DEFERUPLD.....	1941
C1-UPLAPPENT.....	1941
C1-UPLAPPEXT.....	1941
F1-TODOCOMPL.....	1941
C1-BLVLVLPPO.....	1941

CSV File Format for Account Bill Cycle Upload Request.....	1942
CSV File Format for Contract Rider Upload Request.....	1942
CSV File Format for Billable Charge Upload.....	1943
CSV File Format for Hold Upload Request.....	1947
CSV File Format for Refund Request Upload.....	1951
CSV File Format for Write Off Request Upload.....	1952
CSV File Format for Reinstatement Upload Request.....	1953
CSV File Format for Bill Group Sorting Upload Request.....	1954
CSV File Format for Bill Group Derivation and Pricing Parameters Upload Request.....	1955
Upload Request Type.....	1957
Upload Request Type List.....	1958
Upload Request Type.....	1959
Defining an Upload Request Type.....	1962
Defining a Characteristic for an Upload Request Type.....	1968
Editing an Upload Request Type.....	1969
Deleting an Upload Request Type.....	1972
Copying an Upload Request Type.....	1973
Mapping an Upload Request Type.....	1977
Viewing the Upload Request Type Details.....	1978
Upload Request (Used for Searching).....	1979
Search Upload Request.....	1979
Searching for an Upload Request.....	1981
Viewing the Upload Request Details.....	1982
Creating an Upload Request.....	1982
Defining a Characteristic for an Upload Request.....	1985
Upload Request (Used for Viewing).....	1986
Upload Request - Main.....	1986
Upload Request.....	1986
Data Records.....	1988
Upload Request - Log.....	1990
Upload Request Log.....	1990
Editing an Upload Request.....	1991
Deleting an Upload Request.....	1992
Validating an Upload Request.....	1992
Cancelling an Upload Request.....	1993
Submitting an Upload Request.....	1994
Approving an Upload Request.....	1998
Rejecting an Upload Request.....	2001
Viewing the Data Record Details.....	2002
Viewing the Log of an Upload Request.....	2003
Adding a Log Entry for an Upload Request.....	2004

Chapter 28: General Ledger (GL) Accounting Template..... 2005

GL Accounting Template (Without Approval) Status Transition.....	2010
GL Accounting Template (With Approval) Status Transition.....	2010
Algorithms Used in C1- GLAT.....	2011
Prerequisites.....	2013
GL Accounting Template (Used for Searching).....	2013
Search GL Accounting Template.....	2014
GL Accounting Template Lines.....	2015
Searching for a GL Accounting Template.....	2016
Creating a GL Accounting Template.....	2016
Viewing the GL Accounting Template Details.....	2018
Viewing the GL Accounting Template Lines Details.....	2019
GL Accounting Template (Used for Viewing).....	2019

GL Accounting Template - Main.....	2019
GL Accounting Template.....	2019
GL Accounting Template - Log.....	2021
GL Accounting Template Log.....	2021
Editing a GL Accounting Template.....	2022
Deleting a GL Accounting Template.....	2023
Submitting a GL Accounting Template.....	2024
Approving a GL Accounting Template.....	2025
Rejecting a GL Accounting Template.....	2026
Deactivating a GL Accounting Template.....	2028
Viewing the Log of a GL Accounting Template.....	2029
Adding a Log Entry for a GL Accounting Template.....	2030

Chapter 29: Payment Agreement Request.....2031

Payment Agreement Request (Without Approval) Status Transition.....	2034
Payment Agreement Request (With Approval) Status Transition.....	2034
Prerequisites.....	2035
Algorithms Used in C1-PaymentAgreementRequest.....	2036
Payment Agreement Request Type.....	2036
Payment Agreement Request Type List.....	2037
Payment Agreement Request Type.....	2037
Defining a Payment Agreement Request Type.....	2040
Defining a Characteristic for a Payment Agreement Request Type.....	2043
Editing a Payment Agreement Request Type.....	2044
Copying a Payment Agreement Request Type.....	2046
Deleting a Payment Agreement Request Type.....	2048
Viewing the Payment Agreement Request Type Details.....	2049
Payment Agreement Request (Used for Searching).....	2050
Search Payment Agreement Request.....	2050
Bill Details.....	2053
Searching for a Payment Agreement Request.....	2054
Creating a Payment Agreement Request.....	2054
Defining a Characteristic for a Payment Agreement Request.....	2055
Defining Payment Schedule for a Payment Agreement Request.....	2056
Viewing the Bills Added in the Payment Agreement Request.....	2057
Viewing the Payment Agreement Request Details.....	2058
Payment Agreement Request (Used for Viewing).....	2058
Payment Agreement Request - Main.....	2059
Payment Agreement Request.....	2059
Bill Details.....	2061
Payment Schedule.....	2062
Payment Agreement Request - Bills.....	2062
Search Bills.....	2062
Payment Agreement Request - Log.....	2064
Payment Agreement Request Log.....	2064
Editing a Payment Agreement Request.....	2064
Deleting a Payment Agreement Request.....	2067
Submitting a Payment Agreement Request.....	2068
Removing an Overdue Bill from a Payment Agreement Request.....	2069
Approving a Payment Agreement Request.....	2069
Rejecting a Payment Agreement Request.....	2071
Resubmitting a Payment Agreement Request.....	2072
Filtering Overdue Bills of an Account.....	2073
Adding an Overdue Bill in a Payment Agreement Request.....	2074
Viewing the Log of a Payment Agreement Request.....	2075

Adding a Log Entry for a Payment Agreement Request.....	2076
---	------

Chapter 30: Inbound Message.....2079

Health Care Inbound Message.....	2080
Prerequisites.....	2085
Health Care Inbound Message Status Transition through User Interface.....	2087
Health Care Inbound Message Status Transition through a Batch Process.....	2088
Algorithms Used in C1-HCInboundMessage.....	2089
C1-AT-RQJ.....	2090
F1-AT-RQJ.....	2090
C1-HCINVAL.....	2090
C1-HCINPROC.....	2091
C1-TODORETRY.....	2091
C1-TDCRINMSG.....	2092
Health Care Inbound Message XML Format.....	2092
Health Care Inbound Message Schema.....	2135
Sample Health Care Inbound Message for Fully-Insured Group Customer Setup.....	2142
Sample Health Care Inbound Message for Self-Funded Customer Setup.....	2180
Sample Health Care Inbound Message for Pricing Rules.....	2205
Sample Health Care Inbound Message for Membership.....	2223
Health Product and Plan Inbound Message.....	2237
Prerequisites.....	2238
Health Product and Plan Inbound Message Status Transition through User Interface.....	2238
Health Product and Plan Inbound Message Status Transition through a Batch Process.....	2239
Algorithms Used in C1-HCProdHlthPlnInbound.....	2240
C1-AT-RQJ.....	2241
F1-AT-RQJ.....	2241
C1-HLTPRDVAL.....	2241
C1-HCPRPROC.....	2242
C1-TODORETRY.....	2243
C1-TDCRINMSG.....	2243
Health Product and Plan Inbound Message XML Format.....	2243
Health Product and Plan Inbound Message Schema.....	2260
Sample Health Product and Plan Inbound Message for Health Product Setup.....	2262
Sample Health Product and Plan Inbound Message for Health Plan Setup.....	2262
Sample Health Product and Plan Inbound Message for Health Plan Pricing Rules Setup.....	2264
Inbound Message Type.....	2269
Inbound Message Type List.....	2269
Inbound Message Type.....	2270
Viewing the Inbound Message Type Details.....	2272
Defining an Inbound Message Type.....	2272
Defining a Characteristic for an Inbound Message Type.....	2275
Editing an Inbound Message Type.....	2276
Copying an Inbound Message Type.....	2278
Deleting an Inbound Message Type.....	2280
Inbound Message (Used for Searching).....	2281
Search Inbound Message.....	2281
Searching for an Inbound Message.....	2284
Creating an Inbound Message.....	2285
C1-HCInboundMessage.....	2285
C1-HCProdHlthPlnInboundMessage (SOAP Based Service).....	2286
C1-HCProdHlthPlnInboundMes (REST Based Service).....	2286
Viewing the Inbound Message Details.....	2286
Inbound Message (Used for Viewing).....	2287
Inbound Message - Main.....	2287

Inbound Message.....	2287
Inbound Message - Message.....	2289
Inbound Message Content.....	2289
Inbound Message - Log.....	2290
Inbound Message Log.....	2290
Editing an Inbound Message.....	2291
Defining a Characteristic for an Inbound Message.....	2292
Deleting an Inbound Message.....	2293
Processing an Inbound Message.....	2293
Using the Retry Option for an Inbound Message.....	2295
Voiding an Inbound Message.....	2296
Viewing the Content of an Inbound Message.....	2296
Viewing the Log of an Inbound Message.....	2297
Adding a Log Entry for an Inbound Message.....	2297
Statement Construct Preference.....	2298
Searching for a Statement Construct Preference.....	2299
Viewing the Statement Construct Preference Details.....	2299
Defining a Statement Construct Preference.....	2300
Editing a Statement Construct Preference.....	2305
Copying a Statement Construct Preference.....	2309
Deleting a Statement Construct Preference.....	2313

Chapter 31: Upload Lockbox Payment and Remittance Advices

Overview.....	2315
Prerequisites.....	2317
EDI 820 Flat File Description.....	2317
Sample EDI 820 Flat File.....	2319
Upload EDI 820 Files in ORMB.....	2320

Chapter 32: Deferred Revenue Recognition..... 2323

Prerequisites.....	2325
Deferred Revenue Recognition Status Transition.....	2325
Algorithms Used in Deferred Revenue Recognition.....	2327
Deferred Revenue Recognition Template (Used for Searching).....	2332
Search Deferred Revenue Recognition Template.....	2332
Searching for a Deferred Revenue Recognition Template.....	2333
Defining a Deferred Revenue Recognition Template.....	2334
Associating Algorithms with a Deferred Revenue Recognition Template.....	2336
Associating Deferred Revenue Recognition Template With A Division.....	2337
Defining a Characteristic for a Deferred Revenue Recognition Template.....	2338
Viewing the Deferred Revenue Recognition Template Details.....	2339
Deferred Revenue Recognition Template (Used for Viewing).....	2340
Deferred Revenue Recognition Template.....	2340
Editing a Deferred Revenue Recognition Template.....	2342
Deleting a Deferred Revenue Recognition Template.....	2343
Viewing the Deferred Revenue Recognition Template Details.....	2343
Deferred Revenue Recognition (Used for Searching).....	2344
Search Deferred Revenue Recognition.....	2344
Searching for a Deferred Revenue Recognition.....	2348
Viewing the Deferred Revenue Recognition Details.....	2349
Deferred Revenue Recognition (Used for Viewing).....	2350
Deferred Revenue Recognition - Main.....	2350
Deferred Revenue Recognition.....	2350
Associated Deferred Revenue Recognitions.....	2352

Recognition Schedule.....	2352
Revenue Recognition Items.....	2353
Deferred Revenue Recognition - Log.....	2353
Deferred Revenue Recognition Log.....	2353
Editing a Deferred Revenue Recognition.....	2354
Creating the Deferred Revenue Recognition Schedule.....	2354
Defining a Characteristic for a Deferred Revenue Recognition.....	2355
Adding Related Deferred Revenue Recognitions.....	2356
Editing the Deferred Revenue Recognition Schedule Details.....	2357
Viewing the Log of a Deferred Revenue Recognition.....	2358
Adding a Log Entry for a Deferred Revenue Recognition.....	2359

Chapter 33: Reconciliation.....2361

Pre-requisites.....	2364
Reconciliation Status Transition.....	2364
Pay Instruction Status Transition.....	2365
Discrepancy Report Status Transition.....	2367
EDI 820 File Format For Reconciliation.....	2367
Sample EDI 820 File Format.....	2368
Algorithms Used in C1-MemberReconType.....	2369
C1-REOCNPEP.....	2369
Algorithms Used in C1-MemberReconciliation.....	2370
C1-RECONINFO.....	2371
C1-MRECONVAL.....	2371
F1-AT-RQJ.....	2371
F1-TDCREATE.....	2372
C1-VALPAYINS.....	2372
F1-TODOCOMPL.....	2372
C1-MRECONVAL.....	2373
C1-MONPAYINS.....	2373
C1-TRNPAYRCN.....	2373
C1-RCOPNPYIN.....	2374
C1-RCNOPNMR.....	2374
C1-RCMONPNCN.....	2374
C1-CANPAYINS.....	2375
C1-CANRCNPAY.....	2375
C1-RCNCANLTD.....	2375
Algorithms Used in C1-PayInstruction.....	2375
C1-MPAYININF.....	2376
C1-PYINDRVAN.....	2376
C1-PIRECOCIL.....	2377
C1-PYICNADJ.....	2378
F1-AT-RQJ.....	2378
Algorithms Used in C1-MemberDiscReportType.....	2378
C1-DISCPEP.....	2379
Algorithms Used in C1-DiscrepancyReport.....	2379
F1-AT-RQJ.....	2379
C1-DISRINFO.....	2379
C1-VALNEWDIS.....	2380
C1-CRDSLNITM.....	2380
F1-TODOCOMPL.....	2380
C1-VALCMPDIS.....	2380
Reconciliation Type.....	2380
Reconciliation Type List.....	2381
Reconciliation Type.....	2381

Defining a Reconciliation Type.....	2383
Defining a Characteristic for a Reconciliation Type.....	2385
Associating an Algorithm with a Reconciliation Type.....	2385
Editing a Reconciliation Type.....	2387
Deleting a Reconciliation Type.....	2388
Copying a Reconciliation Type.....	2389
Viewing the Reconciliation Type Details.....	2390
Reconciliation (Used for Searching).....	2391
Search Reconciliation.....	2391
Searching for a Reconciliation.....	2394
Viewing the Reconciliation Details.....	2395
Reconciliation (Used for Viewing).....	2395
Reconciliation - Main.....	2396
Reconciliation.....	2396
Reconciliation - Pay Instruction.....	2398
Pay Instructions.....	2398
Reconciliation - Log.....	2400
Reconciliation Log.....	2401
Editing a Reconciliation.....	2401
Defining a Characteristic for a Reconciliation.....	2402
Deleting a Reconciliation.....	2403
Submitting Pay Instructions for a Reconciliation.....	2403
Reconciling Pay Instructions.....	2404
Adding a Log Entry for a Reconciliation.....	2404
Viewing the Log of a Reconciliation.....	2405
Canceling a Reconciliation.....	2406
Searching for a Pay Instruction.....	2406
Viewing the Pay Instruction Details.....	2407
Pay Instruction.....	2408
Pay Instruction - Main.....	2408
Pay Instruction.....	2408
Reconciliation Adjustments.....	2410
Related Objects.....	2410
Pay Instruction - Log.....	2411
Pay Instruction Log.....	2411
Adding a Log Entry for a Pay Instruction.....	2411
Viewing the Log of a Pay Instruction.....	2412
Discrepancy Report Type.....	2413
Discrepancy Report Type List.....	2413
Discrepancy Report Type.....	2414
Defining a Discrepancy Report Type.....	2415
Defining a Characteristic for a Discrepancy Report Type.....	2416
Editing a Discrepancy Report Type.....	2417
Deleting a Discrepancy Report Type.....	2419
Copying a Discrepancy Report Type.....	2419
Viewing the Discrepancy Report Type Details.....	2420
Discrepancy Report (Used for Searching).....	2421
Search Discrepancy Report.....	2421
Searching for a Discrepancy Report.....	2424
Creating a Discrepancy Report.....	2424
Viewing the Discrepancy Report Details.....	2426
Discrepancy Report (Used for Viewing).....	2426
Discrepancy Report - Main.....	2427
Discrepancy Report.....	2427
Discrepancy Line Items.....	2428
Discrepancy Line Item Related Objects.....	2429

Discrepancy Line Items Characteristics Zone.....	2430
Discrepancy Report - Log.....	2430
Discrepancy Report Log.....	2430
Editing a Discrepancy Line Item.....	2430
Deleting a Discrepancy Report.....	2432
Finalizing a Discrepancy Report.....	2432
Adding a Log Entry for a Discrepancy Report.....	2433
Viewing the Log of a Discrepancy Report.....	2433
Member Reconciliation Preference.....	2434
Searching for a Member Reconciliation Preference.....	2434
Viewing the Member Reconciliation Preference Details.....	2435
Defining a Member Reconciliation Preference.....	2435
Editing a Member Reconciliation Preference.....	2441
Copying a Member Reconciliation Preference.....	2446
Deleting a Member Reconciliation Preference.....	2451

Chapter 34: Self-Funded Pricing..... 2453

Prerequisites.....	2455
Approval Workflow for the Self-Funded Pricing Rules.....	2455
Line Item Extendable Lookup.....	2456
Extendable Lookup Search.....	2457
Searching for the Line Item Extendable Lookup.....	2458
Viewing the Values of the Line Item Extendable Lookup.....	2459
Extendable Lookup (Line Item).....	2459
Extendable Lookup Value List.....	2459
Extendable Lookup Value.....	2460
Defining a Line Item.....	2463
Associating a Line Item with a Pricing Rule Type Category.....	2465
Defining the Markup or Markdown Billing Information for the Line Items.....	2467
Defining Line Item Billing Information for the Line Items.....	2468
Defining the Claim Handling Fees Billing Information for the Line Items.....	2469
Editing a Line Item.....	2471
Copying a Line Item.....	2473
Deleting a Line Item.....	2476
Viewing the Line Item Details.....	2476
Claim Template Extendable Lookup.....	2477
Extendable Lookup Search.....	2478
Searching for the Claim Template Extendable Lookup.....	2479
Viewing the Values of the Claim Template Extendable Lookup.....	2479
Extendable Lookup (Claim Template).....	2480
Extendable Lookup Value List.....	2480
Extendable Lookup Value.....	2481
Defining a Claim Template.....	2484
Defining the Claim Handling Fees for Line Items in the Claim Template.....	2486
Defining the Default Markup or Markdown Values for Line Items in a Claim Template..	2488
Adding a Line Item in a Claim Template.....	2489
Editing a Claim Template.....	2492
Copying a Claim Template.....	2493
Deleting a Claim Template.....	2495
Viewing the Claim Template Details.....	2495
Rate Option Extendable Lookup.....	2496
Extendable Lookup Search.....	2497
Searching for the Rate Option Extendable Lookup.....	2498
Viewing the Values of the Rate Option Extendable Lookup.....	2498
Extendable Lookup (Rate Option).....	2499

Extendable Lookup Value List.....	2499
Extendable Lookup Value.....	2500
Defining a Rate Option.....	2502
Editing a Rate Option.....	2504
Copying a Rate Option.....	2507
Deleting a Rate Option.....	2510
Viewing the Rate Option Details.....	2510
Rate Type Extendable Lookup.....	2511
Extendable Lookup Search.....	2511
Searching for the Rate Type Extendable Lookup.....	2512
Viewing the Values of the Rate Type Extendable Lookup.....	2513
Extendable Lookup (Rate Type).....	2513
Extendable Lookup Value List.....	2513
Extendable Lookup Value.....	2514
Defining a Rate Type.....	2515
Editing a Rate Type.....	2517
Copying a Rate Type.....	2519
Deleting a Rate Type.....	2521
Viewing the Rate Type Details.....	2521
Pricing Group.....	2522
Viewing the Pricing Groups of a Bill Group.....	2522
Defining a Pricing Group for a Bill Group.....	2523
Editing a Pricing Group of a Bill Group.....	2526
Deleting a Pricing Group of a Bill Group.....	2529
Copying a Pricing Group of a Bill Group.....	2529
Pricing Rule Type.....	2532
Pricing Rule Type List.....	2533
Pricing Rule Type.....	2536
Claim Pricing.....	2545
Defining a Claim Pricing Rule Type.....	2547
Adding Related Pricing Rule Types in a Primary Pricing Rule Type.....	2549
Defining Transaction Field Mapping in a Primary Pricing Rule Type.....	2551
Associating Algorithms with a Pricing Rule Type.....	2557
Defining Additional Data for a Pricing Rule Type.....	2559
Adding Price Items in a Pricing Rule Type.....	2561
Adding a Price Item Parameter in a Pricing Rule Type.....	2564
Defining a Characteristic for a Pricing Rule Type.....	2566
Adding Claim Templates in a Claim Pricing Rule Type.....	2568
Adding the Claim-Specific Data in a Pricing Rule Type.....	2569
Adding Claim Handling Fees Indicator in a Claim Pricing Rule Type.....	2570
Editing a Claim Pricing Rule Type.....	2572
Deleting a Claim Pricing Rule Type.....	2574
Viewing the Claim Pricing Rule Type Details.....	2575
Defining a Claim Pricing Rule for a Parent Customer.....	2575
Defining the Markup or Markdown Values For Line Items in a Claim Pricing Rule.....	2578
Defining the Markup or Markdown Values for Line Items for Each Rule in a Claim Pricing Rule.....	2579
Defining a Characteristic for a Claim Pricing Rule.....	2581
Editing a Claim Pricing Rule of a Parent Customer.....	2582
Viewing a Claim Pricing Rule of a Parent Customer.....	2584
Deleting a Claim Pricing Rule of a Parent Customer.....	2585
Defining a Claim Pricing Rule for a Bill Group.....	2586
Defining a Claim Pricing Rule for a Bill Group Using a Pricing Group.....	2589
Editing a Claim Pricing Rule of a Bill Group.....	2592
Viewing a Claim Pricing Rule of a Bill Group.....	2594
Deleting a Claim Pricing Rule of a Bill Group.....	2595

Specific Stop-Loss (SSL) Pricing.....	2595
Defining a Specific Stop-Loss (SSL) Pricing Rule Type.....	2598
Adding the SSL-Specific Data in a Pricing Rule Type.....	2601
Editing a Specific Stop-Loss (SSL) Pricing Rule Type.....	2603
Deleting a Specific Stop-Loss (SSL) Pricing Rule Type.....	2606
Viewing the Specific Stop-Loss (SSL) Pricing Rule Type Details.....	2606
Defining a Specific Stop-Loss Pricing Rule for a Parent Customer.....	2607
Defining Accumulation Parameters in a Specific Stop-Loss Pricing Rule.....	2610
Defining Run-in Parameters in a Specific Stop-Loss Pricing Rule.....	2612
Defining Lasering and Exclusion Information in a Specific Stop-Loss Pricing Rule.....	2613
Defining a Characteristic for a Specific Stop-Loss Pricing Rule.....	2614
Editing a Specific Stop-Loss Pricing Rule of a Parent Customer.....	2615
Viewing a Specific Stop-Loss Pricing Rule of a Parent Customer.....	2618
Deleting a Specific Stop-Loss Pricing Rule of a Parent Customer.....	2619
Defining a Specific Stop-Loss Pricing Rule for a Bill Group.....	2619
Defining Accumulation Criteria in a Specific Stop-Loss Pricing Rule.....	2622
Defining Claim Pricing Information in a Specific Stop Loss Pricing Rule.....	2624
Defining a Specific Stop-Loss Pricing Rule for a Bill Group Using a Pricing Group.....	2626
Editing a Specific Stop-Loss Pricing Rule of a Bill Group.....	2629
Viewing a Specific Stop-Loss Pricing Rule of a Bill Group.....	2630
Deleting a Specific Stop-Loss Pricing Rule of a Bill Group.....	2631
Aggregate Stop-Loss (ASL) Pricing.....	2632
Defining a Aggregate Stop-Loss (ASL) Pricing Rule Type.....	2634
Adding the ASL-Specific Data in a Pricing Rule Type.....	2637
Editing an Aggregate Stop-Loss (ASL) Pricing Rule Type.....	2639
Deleting an Aggregate Stop-Loss (ASL) Pricing Rule Type.....	2642
Viewing the Aggregate Stop-Loss (ASL) Pricing Rule Type Details.....	2642
Defining an Aggregate Stop-Loss Pricing Rule for a Parent Customer.....	2643
Defining Accumulation Parameters in an Aggregate Stop-Loss Pricing Rule.....	2646
Defining Run-in Parameters in an Aggregate Stop-Loss Pricing Rule.....	2649
Defining a Characteristic for an Aggregate Stop-Loss Pricing Rule.....	2650
Editing an Aggregate Stop-Loss Pricing Rule of a Parent Customer.....	2651
Viewing an Aggregate Stop-Loss Pricing Rule of a Parent Customer.....	2654
Deleting an Aggregate Stop-Loss Pricing Rule of a Parent Customer.....	2654
Defining an Aggregate Stop-Loss Pricing Rule for a Bill Group.....	2655
Defining Accumulation Criteria in an Aggregate Stop-Loss Pricing Rule.....	2658
Defining Claim Pricing Rules in an Aggregate Stop-Loss Pricing Rule.....	2660
Defining an Aggregate Stop-Loss Pricing Rule for a Bill Group Using a Pricing Group...	2662
Editing an Aggregate Stop-Loss Pricing Rule of a Bill Group.....	2665
Viewing an Aggregate Stop-Loss Pricing Rule of a Bill Group.....	2666
Deleting an Aggregate Stop-Loss Pricing Rule of a Bill Group.....	2667
Retention Type Claim Based Pricing.....	2668
Defining a Retention Type Claim Based Pricing Rule Type.....	2669
Adding Claim Based Disposition Details in a Pricing Rule Type.....	2672
Editing a Retention Type Claim Based Pricing Rule Type.....	2673
Deleting a Retention Type Claim Based Pricing Rule Type.....	2675
Viewing the Retention Type Claim Based Pricing Rule Type Details.....	2676
Defining a Retention Type Claim Based Pricing Rule for a Parent Customer.....	2677
Defining a Characteristic for a Retention Type Claim Based Pricing Rule.....	2680
Editing a Retention Type Claim Based Pricing Rule of a Parent Customer.....	2681
Deleting a Retention Type Claim Based Pricing Rule of a Parent Customer.....	2684
Defining a Retention Type Claim Based Pricing Rule for a Bill Group.....	2685
Defining a Characteristic for a Retention Type Claim Based Pricing Rule.....	2687
Editing a Retention Type Claim Based Pricing Rule of a Bill Group.....	2688
Deleting a Retention Type Claim Based Pricing Rule of a Bill Group.....	2691

Defining a Retention Type Claim Based Pricing Rule for a Bill Group Using a Pricing Group.....	2691
Defining a Characteristic for a Retention Type Claim Based Pricing Rule for a Bill Group Using a Pricing Group.....	2694
Viewing a Retention Type Claim Based Pricing Rule of a Parent Customer.....	2695
Viewing a Retention Type Claim Based Pricing Rule of a Bill Group.....	2696
Retention Type Enrollment Based Pricing.....	2697
Defining a Retention Type Enrollment Based Pricing Rule Type.....	2698
Adding the Enrollment Specific Data in a Pricing Rule Type.....	2701
Editing a Retention Type Enrollment Based Pricing Rule Type.....	2702
Deleting a Retention Type Enrollment Based Pricing Rule Type.....	2704
Viewing the Retention Type Enrollment Based Pricing Rule Type Details.....	2705
Defining a Retention Type Enrollment Based Pricing Rule for a Parent Customer.....	2705
Defining a Characteristic for a Retention Type Enrollment Based Pricing Rule.....	2708
Editing a Retention Type Enrollment Based Pricing Rule of a Parent Customer.....	2709
Deleting a Retention Type Enrollment Based Pricing Rule of a Parent Customer.....	2712
Defining a Retention Type Enrollment Based Pricing Rule for a Bill Group.....	2712
Defining a Characteristic for a Retention Type Enrollment Based Pricing Rule.....	2715
Editing a Retention Type Enrollment Based Pricing Rule of a Bill Group.....	2716
Deleting a Retention Type Enrollment Based Pricing Rule of a Bill Group.....	2719
Defining a Retention Type Enrollment Based Pricing Rule for a Bill Group Using a Pricing Group.....	2720
Defining a Characteristic for a Retention Type Enrollment Based Pricing Rule for a Bill Group Using a Pricing Group.....	2723
Viewing a Retention Type Enrollment Based Pricing Rule of a Parent Customer.....	2724
Viewing a Retention Type Enrollment Based Pricing Rule of a Bill Group.....	2725
Flat Fee Pricing.....	2725
Defining a One-Time Flat Fee Pricing Rule Type.....	2727
Adding the One-Time Flat Fee Specific Data in a Pricing Rule Type.....	2730
Editing a One-Time Flat Fee Pricing Rule Type.....	2731
Deleting a One-Time Flat Fee Pricing Rule Type.....	2734
Viewing the One-Time Flat Fee Pricing Rule Type Details.....	2735
Defining a One-Time Flat Fee Pricing Rule for a Bill Group.....	2735
Defining a Characteristic for a One-Time Flat Fee Pricing Rule.....	2738
Editing a One-Time Flat Fee Pricing Rule of a Bill Group.....	2739
Viewing a One-Time Flat Fee Pricing Rule of a Bill Group.....	2740
Deleting a One-Time Flat Fee Pricing Rule of a Bill Group.....	2741
Defining a Bill Period Based Recurring Flat Fee Pricing Rule Type.....	2742
Adding the Recurring Flat Fee Specific Data in a Pricing Rule Type.....	2745
Editing a Bill Period Based Recurring Flat Fee Pricing Rule Type.....	2746
Deleting a Bill Period Based Recurring Flat Fee Pricing Rule Type.....	2749
Viewing the Bill Period Based Recurring Flat Fee Pricing Rule Type Details.....	2750
Defining a Bill Period Based Recurring Flat Fee Pricing Rule for a Bill Group.....	2750
Defining a Characteristic for a Bill Period Based Recurring Flat Fee Pricing Rule.....	2753
Editing a Bill Period Based Recurring Flat Fee Pricing Rule of a Bill Group.....	2754
Viewing a Bill Period Based Recurring Flat Fee Pricing Rule of a Bill Group.....	2755
Deleting a Bill Period Based Recurring Flat Fee Pricing Rule of a Bill Group.....	2756
Defining a Frequency Based Recurring Flat Fee Pricing Rule Type.....	2757
Adding the Recurring Flat Fee Specific Data in a Pricing Rule Type.....	2760
Editing a Frequency Based Recurring Flat Fee Pricing Rule Type.....	2761
Deleting a Frequency Based Recurring Flat Fee Pricing Rule Type.....	2764
Viewing the Frequency Based Recurring Flat Fee Pricing Rule Type Details.....	2764
Defining a Frequency Based Recurring Flat Fee Pricing Rule for a Bill Group.....	2765
Defining a Characteristic for a Frequency Based Recurring Flat Fee Pricing Rule.....	2767
Editing a Frequency Based Recurring Flat Fee Pricing Rule of a Bill Group.....	2768
Viewing a Frequency Based Recurring Flat Fee Pricing Rule of a Bill Group.....	2770

Deleting a Frequency Based Recurring Flat Fee Pricing Rule of a Bill Group.....	2771
Ancillary Pricing.....	2771
Defining an Ancillary Pricing Rule Type.....	2774
Adding a Related Pricing Rule Type in an Ancillary Pricing Rule Type.....	2779
Mapping the Transaction Field in an Ancillary Pricing Rule Type.....	2781
Associating an Algorithm with an Ancillary Pricing Rule Type.....	2785
Defining Additional Data in an Ancillary Pricing Rule Type.....	2788
Adding a Price Item in an Ancillary Pricing Rule Type.....	2791
Adding a Price Item Parameter in an Ancillary Pricing Rule Type.....	2794
Defining the Ancillary-Specific Data in an Ancillary Pricing Rule Type.....	2795
Defining Pricing Arrangements in an Ancillary Pricing Rule Type.....	2797
Defining a Characteristic for a Ancillary Pricing Rule Type.....	2798
Editing an Ancillary Pricing Rule Type.....	2799
Deleting an Ancillary Pricing Rule Type.....	2803
Viewing the Ancillary Pricing Rule Type Details.....	2804
Defining an Ancillary Pricing Rule for a Parent Customer.....	2804
Defining a Characteristic for an Ancillary Pricing Rule.....	2807
Editing an Ancillary Pricing Rule of a Parent Customer.....	2809
Deleting an Ancillary Pricing Rule of a Parent Customer.....	2811
Defining an Ancillary Pricing Rule for a Bill Group.....	2812
Defining a Characteristic for an Ancillary Pricing Rule.....	2815
Editing an Ancillary Pricing Rule of a Bill Group.....	2817
Deleting an Ancillary Pricing Rule of a Bill Group.....	2819
Discount Pricing.....	2820
Types of Discount Arrangement.....	2821
Discount Share.....	2821
Discount Guarantee.....	2821
Defining a Discount Arrangement Pricing Rule Type.....	2821
Associating Algorithms with a Discount Arrangement Pricing Rule Type.....	2825
Defining Additional Data in a Discount Arrangement Pricing Rule Type.....	2828
Adding a Price Item in a Discount Arrangement Pricing Rule Type.....	2830
Adding a Price Item Parameter in a Discount Arrangement Pricing Rule Type.....	2833
Defining a Characteristic for a Discount Arrangement Pricing Rule Type.....	2834
Defining the Discount Specific Data in a Discount Arrangement Pricing Rule Type.....	2835
Editing a Discount Arrangement Pricing Rule Type.....	2838
Deleting a Discount Arrangement Pricing Rule Type.....	2841
Viewing the Discount Arrangement Pricing Rule Type Details.....	2842
Defining a Discount Arrangement Pricing Rule for a Parent Customer.....	2842
Adding the Discount Details in a Discount Arrangement Pricing Rule	2845
Defining the Discount Limits in a Discount Arrangement Pricing Rule.....	2846
Excluding a Network or Provider in a Discount Arrangement Pricing Rule.....	2848
Defining a Characteristic for a Discount Arrangement Pricing Rule.....	2849
Editing a Discount Arrangement Pricing Rule of a Parent Customer.....	2850
Deleting a Discount Arrangement Pricing Rule of a Parent Customer.....	2852
Write-Off Charges during Post Runout.....	2853
Level Funding Pricing.....	2853
Defining a Level Funded Pricing Rule Type.....	2857
Associating an Algorithm with a Level Funded Pricing Rule Type.....	2859
Defining Additional Data in a Level Funded Pricing Rule Type.....	2860
Adding a Price Item in a Level Funded Pricing Rule Type.....	2862
Adding a Price Item Parameter in a Level Funded Pricing Rule Type.....	2865
Defining a Characteristic for a Level Funded Pricing Rule Type.....	2866
Defining the Level Funded Specific Additional Data in a Level Funded Pricing Rule Type.....	2867
Editing a Level Funded Pricing Rule Type.....	2871
Deleting a Level Funded Pricing Rule Type.....	2874

Viewing the Level Funded Pricing Rule Type Details.....	2874
Defining a Level Funded Pricing Rule for a Parent Customer.....	2875
Defining Accumulation Parameters in a Level Funded Pricing Rule.....	2878
Defining the Final Settlement Rules in a Level Funded Pricing Rule.....	2879
Defining a Characteristic for a Level Funded Pricing Rule.....	2884
Defining a Level Funded Pricing Rule for a Bill Group.....	2885
Defining Accumulation Criteria in a Level Funded Pricing Rule.....	2888
Defining Claim Pricing Information in a Level Funded Pricing Rule.....	2891
Defining Ancillary Pricing Information in a Level Funded Pricing Rule.....	2894
Defining Discount Arrangement Pricing Information in a Level Funded Pricing Rule.....	2897
Defining Retention Type Claim Based and/or Retention Type Enrollment Based Pricing Rule Information in a Level Funded Pricing Rule.....	2899
Defining a Characteristic for a Level Funded Pricing Rule.....	2900
Terminal Liability Reserve (Run Out) Level Funding Pricing.....	2901
Pricing Rule (Used for Viewing).....	2902
Claim.....	2903
Aggregate Stop-Loss.....	2906
Specific Stop-Loss.....	2912
Retention Type Claim Based.....	2917
Retention Type Enrollment Based.....	2919
Flat Fee.....	2920
Ancillary.....	2922
Discount Arrangement.....	2924
Level Funded.....	2926
Age Based Pricing Rule.....	2932
Tier Based Pricing Rule.....	2933
Additional Charge Pricing Rule.....	2935
Self-Funded Pricing Rule Versioning.....	2936

Chapter 35: Stop-Loss..... 2941

Accumulation Data.....	2942
------------------------	------

Chapter 36: Self-Funded Billing..... 2943

Pre-requisites.....	2945
Bill Group Derivation and Pricing Parameters.....	2946
Related Pricing Rule Type Eligibility.....	2948
Price Item Eligibility.....	2950
Self-Funded Billing Process.....	2951
Transaction Aggregation.....	2951
Stop Loss Calculation.....	2956
Bill Generation.....	2956
Bill Group Derivation.....	2957
Account and Price Item Derivation (for the Claim Pricing Rule Type Category).....	2960
Account and Price Item Derivation (for the Specific Stop-Loss and Aggregate Stop-Loss Pricing Rule Type Categories).....	2965
Account and Price Item Derivation (for the Retention Type Claim Based Pricing Rule Type Category).....	2978
Account and Price Item Derivation (for the Retention Type Enrollment Based Pricing Rule Type Category).....	2990
Account and Price Item Derivation (for the Ancillary Pricing Rule Type Category).....	3000
Bill After Date Determination.....	3008
Advance Billing for Claim Fund Charge.....	3010
SSL Accumulation across Bill Groups.....	3011

Chapter 37: Fully-Insured Pricing.....3013

Age Based Pricing.....	3014
Defining an Age Based Pricing Rule Type.....	3017
Adding the Related Pricing Rule Types in an Age Based Pricing Rule Type.....	3019
Associating an Algorithm with an Age Based Pricing Rule Type.....	3021
Adding a Price Item in an Age Based Pricing Rule Type.....	3023
Adding a Price Item Parameter in an Age Based Pricing Rule Type.....	3026
Defining a Characteristic for an Age Based Pricing Rule Type.....	3027
Adding Elements for Audit in an Age Based Pricing Rule Type.....	3028
Defining an Age Based Specific Additional Data in an Age Based Pricing Rule Type.....	3029
Mapping Characteristic Attributes in an Age Based Pricing Rule Type.....	3030
Editing an Age Based Pricing Rule Type.....	3031
Deleting an Age Based Pricing Rule Type.....	3034
Viewing the Age Based Pricing Rule Type Details.....	3034
Tier Based Pricing.....	3035
Defining a Tier Based Pricing Rule Type.....	3037
Adding the Related Pricing Rule Types in a Tier Based Pricing Rule Type.....	3040
Associating an Algorithm with a Tier Based Pricing Rule Type.....	3041
Adding a Price Item in a Tier Based Pricing Rule Type.....	3043
Adding a Price Item Parameter in a Tier Based Pricing Rule Type.....	3046
Defining a Characteristic for a Tier Based Pricing Rule Type.....	3047
Adding Elements for Audit in a Tier Based Pricing Rule Type.....	3048
Editing a Tier Based Pricing Rule Type.....	3049
Deleting a Tier Based Pricing Rule Type.....	3051
Viewing the Tier Based Pricing Rule Type Details.....	3052
Pass-Through Billable Charge.....	3052
Defining a Pass-Through Billable Charge Pricing Rule Type.....	3053
Associating an Algorithm with a Pass-Through Billable Charge Pricing Rule Type.....	3055
Adding a Price Item in a Pass-Through Billable Charge Pricing Rule Type.....	3057
Adding a Price Item Parameter in a Pass-Through Billable Charge Pricing Rule Type.....	3060
Defining a Characteristic for a Pass-Through Billable Charge Pricing Rule Type.....	3060
Editing a Pass-Through Billable Charge Pricing Rule Type.....	3061
Deleting a Pass-Through Billable Charge Pricing Rule Type.....	3063
Viewing the Pass-Through Billable Charge Pricing Rule Type Details.....	3064
Administration Fee Pricing for COBRA Membership.....	3065
Defining an Additional Charge Pricing Rule Type.....	3067
Associating an Algorithm with an Additional Charge Pricing Rule Type.....	3069
Adding a Price Item in an Additional Charge Pricing Rule Type.....	3071
Adding a Price Item Parameter in an Additional Charge Pricing Rule Type.....	3074
Defining a Characteristic for an Additional Charge Pricing Rule Type.....	3075
Adding Elements for Audit in an Additional Charge Pricing Rule Type.....	3076
Editing an Additional Charge Pricing Rule Type.....	3077
Deleting an Additional Charge Pricing Rule Type.....	3079
Viewing the Additional Charge Pricing Rule Type Details.....	3080
Medicare Part D LIS and LEP Pricing.....	3080
Defining a Benefit Pricing Rule Type.....	3081
Associating Algorithms with a Benefit Pricing Rule Type.....	3083
Adding a Price Item in a Benefit Pricing Rule Type.....	3085
Adding a Price Item Parameter in a Benefit Pricing Rule Type.....	3087
Defining a Characteristic for a Benefit Pricing Rule Type.....	3088
Adding Elements for Audit in a Benefit Pricing Rule Type.....	3089
Editing a Benefit Pricing Rule Type.....	3090
Deleting a Benefit Pricing Rule Type.....	3092
Viewing the Benefit Pricing Rule Type Details.....	3093

Discount Charge Pricing for Retiree Membership.....	3093
Prerequisites.....	3094
Discount Charge Pricing Rule.....	3095
Defining a Discount Charge Pricing Rule Type.....	3097
Associating an Algorithm with a Discount Charge Pricing Rule Type.....	3099
Adding a Price Item in a Discount Charge Pricing Rule Type.....	3101
Adding a Price Item Parameter in a Discount Charge Pricing Rule Type.....	3104
Defining a Characteristic for a Discount Charge Pricing Rule Type.....	3105
Adding Elements for Audit in a Discount Charge Pricing Rule Type.....	3106
Editing a Discount Charge Pricing Rule Type.....	3107
Deleting a Discount Charge Pricing Rule Type.....	3109
Viewing the Discount Charge Pricing Rule Type Details.....	3110
Viewing the Discount Charge Pricing Rule Details.....	3111
Pricing Rule Inactivation.....	3112

Chapter 38: Fully-Insured Group Billing..... 3113

Audit Framework for Fully-Insured Group Health Insurance Billing.....	3115
Age Based and Tier Based Pricing Rules Audit Process.....	3116
Membership Audit Process.....	3117
Person Audit Process.....	3123
Bill Group Derivation and Pricing Parameters Audit Process.....	3125
Premium Proration Rules.....	3128
Age Monitoring.....	3130
State of Issue.....	3131
Membership Premium Calculation.....	3132
Bill Group Derivation for Membership.....	3137
Account and Price Item Derivation for Membership.....	3140
Bill Cycle and Bill Period Derivation.....	3140
Bill Period Timeline.....	3141
9/10 Billing (Skip Months).....	3141
Repricing.....	3142
Fully-Insured Group Billable Charge Creation.....	3143
Repricing Request.....	3145
Search Repricing Entity Detail Record.....	3145
Repricing Requests.....	3148
Timeline and Billable Charge Details.....	3149
Pricing Calculation Details.....	3149
Searching for a Repricing Entity Detail Record.....	3150
Viewing the Repricing Requests Created for a Repricing Entity Detail Record.....	3151
Viewing the Billable Charge Timeline Details of a Repricing Request.....	3151
Viewing the Pricing Calculation Details of a Timeline.....	3152
Membership Premium Calculation Through Inbound Web Service.....	3152
Prerequisites.....	3152
C1-MembershipRepricing Business Service.....	3154
C1-MembRepricing Business Service Schema.....	3155
Membership Premium Calculation Request and Response - Tags in XML Format.....	3159
Sample Individual Membership Creation Request and Response in XML Format.....	3183
Sample Group Membership Creation Request and Response in XML Format.....	3187
Sample Group Membership Read Request and Response in XML Format.....	3191
Sample Individual Membership Read Request and Response in XML Format.....	3196
Sample Member Person Creation Read Request and Response in XML Format.....	3200
Sample Individual Membership Premium Simulation Request and Response in XML Format.....	3204
Sample Group Membership Premium Simulation Request and Response in XML Format.....	3208

Sample Account Balance Read Request and Response in XML Format.....	3213
---	------

Chapter 39: Off-Process Request.....3219

Prerequisites.....	3222
Off-Process Request (Without Approval) Status Transition.....	3222
Off-Process Request (With Approval) Status Transition.....	3222
Algorithms Used in C1-OffProcessRequest.....	3223
Off-Process Request Type.....	3223
Off-Process Request Type List.....	3224
Off-Process Request Type.....	3224
Defining an Off-Process Request Type.....	3227
Adding the Accumulation Amendment Details in an Off-Process Request Type.....	3229
Defining a Characteristic for an Off-Process Request Type.....	3231
Editing an Off-Process Request Type.....	3232
Deleting an Off-Process Request Type.....	3234
Copying an Off-Process Request Type.....	3235
Viewing the Off-Process Request Type Details.....	3238
Off-Process Request (Used for Searching).....	3238
Search Off-Process Request.....	3238
Searching for an Off-Process Request.....	3241
Defining an Off-Process Request.....	3241
Viewing the Off-Process Request Details of an Off-Process Request.....	3243
Off-Process Request (Used for Viewing).....	3244
Off-Process Request - Main.....	3244
Off-Process Request.....	3244
Off-Process Request Details.....	3246
Off-Process Request Error Message.....	3248
Off-Process Request - Log.....	3248
Off-Process Request Log.....	3248
Viewing the Error Message of an Off-Process Request.....	3249
Adding the Off-Process Request Details in an Off-Process Request.....	3250
Defining a Characteristic for an Off-Process Request.....	3253
Editing an Off-Process Request.....	3253
Deleting an Off-Process Request.....	3254
Submitting an Off-Process Request.....	3255
Approving an Off-Process Request.....	3256
Rejecting an Off-Process Request.....	3257
Viewing the Log of an Off-Process Request.....	3259
Adding a Log Entry for an Off-Process Request.....	3259

Chapter 40: Individual Health Insurance Pricing.....3261

Business Rules.....	3263
Business Rule Type.....	3263
Search Business Rule Type.....	3263
Business Rule Type.....	3267
Business Rule Criteria.....	3268
Searching for a Business Rule Type.....	3268
Viewing the Business Rule Type Details.....	3269
Defining a Business Rule Type.....	3269
Associating a Parameter with a Business Rule Type.....	3271
Defining a Characteristic for a Business Rule Type.....	3271
Editing a Business Rule Type.....	3272
Deleting a Business Rule Type.....	3273
Defining a Business Rule Criteria for a Business Rule Type.....	3274

Editing the Business Rule Criteria of a Business Rule Type.....	3275
Deleting the Business Rule Criteria of a Business Rule Type.....	3276
Business Rule (Used for Searching).....	3277
Search Business Rule.....	3277
Business Rule Log.....	3280
Searching for a Business Rule.....	3281
Defining a Binder Payment Business Rule.....	3282
Defining a Fully-Insured Pricing Business Rule.....	3284
Defining a New Born Business Rule.....	3287
Defining a Rate Guarantee Business Rule.....	3288
Editing a Binder Payment Business Rule.....	3290
Editing a Fully-Insured Pricing Business Rule.....	3291
Editing a New Born Business Rule.....	3293
Editing a Rate Guarantee Business Rule.....	3294
Deleting a Business Rule.....	3295
Viewing the Log of a Business Rule.....	3296

Chapter 41: Individual Health Insurance Billing.....3297

Chapter 42: Entity Audit..... 3299

Audit Event Status Transition.....	3300
Prerequisites.....	3300
Entity Audit Process.....	3301
Audit Event Creation.....	3301
Audit Event Processing.....	3302
Algorithms Used in the Entity Audit Process.....	3302
C1-REAUDEVNT.....	3302
C1-AUDEVMPR.....	3303
Audit Event Type.....	3303
Audit Event Type List.....	3305
Audit Event Type.....	3306
Defining an Audit Event Type.....	3308
Associating an Algorithm with an Audit Event Type.....	3311
Adding an Element for Auditing in an Audit Event Type.....	3312
Defining a Characteristic for an Audit Event Type.....	3315
Editing an Audit Event Type.....	3316
Copying an Audit Event Type.....	3318
Deleting an Audit Event Type.....	3321
Viewing the Audit Event Type Details.....	3321
Audit Event (Used for Searching).....	3322
Search Audit Event.....	3322
Searching for an Audit Event.....	3325
Viewing the Audit Event Details.....	3326
Audit Event (Used for Viewing).....	3326
Audit Event - Main.....	3327
Audit Event.....	3327
Audit Event - Log.....	3328
Audit Event Log.....	3328
Canceling an Audit Event.....	3329
Viewing the Log of an Audit Event.....	3330

Chapter 43: Invoice Request..... 3331

Prerequisites.....	3334
--------------------	------

Types of Invoice Request.....	3334
Manual Regular Bill Generation Invoice Request.....	3334
Manual Trial Bill Generation Invoice Request.....	3336
Automatic Regular Bill Generation Invoice Request.....	3336
Invoice Request Manual Trial Bill Generation (Without Approval) Status Transition.....	3337
Invoice Request Manual Regular Bill Generation (Without Approval) Status Transition.....	3341
Invoice Request Manual Regular Bill Generation (With Approval) Status Transition.....	3347
Invoice Request Automatic Regular Bill Generation (Without Approval) Status Transition.....	3352
Invoice Request Type.....	3355
Invoice Request Type List.....	3355
Invoice Request Type.....	3356
Defining an Invoice Request Type.....	3359
Defining a Characteristic for an Invoice Request Type.....	3364
Editing an Invoice Request Type.....	3365
Deleting an Invoice Request Type.....	3369
Copying an Invoice Request Type.....	3370
Viewing the Invoice Request Type Details.....	3374
Invoice Request (Used for Searching).....	3375
Search Invoice Request.....	3375
Searching for an Invoice Request.....	3379
Manually Creating an Invoice Request.....	3380
Viewing the Invoice Request Details.....	3382
Invoice Request (Used for Viewing).....	3382
Invoice Request - Main.....	3382
Invoice Request.....	3383
Invoice Request Details/Account List.....	3386
Excluded Accounts.....	3387
Invoice Request - Log.....	3387
Invoice Request Log.....	3387
Editing an Invoice Request.....	3388
Defining a Characteristic for an Invoice Request.....	3390
Deleting an Invoice Request.....	3391
Canceling an Invoice Request.....	3392
Submitting an Invoice Request.....	3393
Approving an Invoice Request.....	3394
Rejecting an Invoice Request.....	3395
Requesting to Resubmit an Invoice Request.....	3396
Viewing the Log of an Invoice Request.....	3398
Adding a Log Entry for an Invoice Request.....	3398

Chapter 44: Mass Payment Transfer..... 3401

Full Payment Transfer.....	3402
Mass Payment Transfer Process.....	3404
Defining a File Request Type for Payment Transfer.....	3404
Uploading a Payment Transfer File.....	3406
Transferring Payments.....	3406
CSV File Format for Mass Payment Transfer.....	3406
Sample CSV File for Mass Payment Transfer.....	3407

Chapter 45: FOP Reports..... 3409

Chapter 46: Garbling Customer Information..... 3411

Appendix A: Most Commonly Used Tasks..... 3413

Changing the Layout.....	3414
Adding a Column to the Zone.....	3414
Rearranging Columns in the Zone.....	3414
Removing a Column from the Zone.....	3414

Appendix B: Administration.....3417

UI Maps.....	3418
Creating Display UI Map for an Approval Workflow Group.....	3418
Creating Input UI Map for an Approval Workflow Group.....	3419
Feature Configurations.....	3420
Setting the C1_ACCTINFO Feature Configuration.....	3420
Setting the C1-ASOBLLNG Feature Configuration.....	3421
Setting the C1_AXENTITY Feature Configuration.....	3441
Setting the C1-BILLADJSQ Feature Configuration.....	3443
Setting the C1_CMO Feature Configuration.....	3445
Setting the C1_DIVFUNCT Feature Configuration.....	3446
Setting the C1-EHRCONFIG Feature Configuration.....	3447
Setting the C1_EXCHRATE Feature Configuration.....	3448
Setting the C1_EXP_OVRD Feature Configuration.....	3449
Setting the C1_FINTRANOP Feature Configuration.....	3450
Setting the C1_FM Feature Configuration.....	3453
Setting the C1-OFFSETREQ Feature Configuration.....	3459
Setting the C1-PAYPORTAL Feature Configuration.....	3460
Setting the C1_PER_REL Feature Configuration.....	3462
Setting the C1_PERSTYPE Feature Configuration.....	3463
Setting the C1_PPARAM_FLG Feature Configuration.....	3464
Setting the C1_PR_REC Feature Configuration.....	3465
Setting the C1_PRASNORDR Feature Configuration.....	3466
Setting the C1_PRICING Feature Configuration.....	3467
Setting the C1-PYREQSRT Feature Configuration.....	3468
Setting the C1_RLENG Feature Configuration.....	3469
Setting the C1-TXNDMYID Feature Configuration.....	3470
Setting the C1-PAYFLUPLD Feature Configuration.....	3471

About this Document

This document lists and describes various features in Oracle Revenue Management and Billing which can be used in the health insurance domain. It describes all screens related to these features and explains how to perform various tasks through these screens.

Intended Audience

This document is intended for the following audience:

- End-users
- System Administrators
- Consulting Team
- Implementation Team
- Development Team

Organization of the Document

Each insurance feature is described in a separate chapter in this document. All screens related to the feature and tasks related to the screen are explained in each chapter. This document contains the following chapters:

Chapter Number	Chapter Name	Chapter Description
Chapter 1	Fully-Insured Group Customer Management	Explains how to create customers and accounts for billing the fully-insured group health plans.
Chapter 2	Self-Funded Customer Management	Explains how to create customers and accounts for billing the self-funded plans.
Chapter 3	Health Insurance Business Management	Describes how to setup the pricing and billing engines for the following three lines of health insurance business — Fully-Insured Group Health Insurance, Self-Funded Group Health Insurance, and Individual Health Insurance.
Chapter 4	Fully-Insured Group Health Insurance	Explains how to design the pricing and billing models for the fully-insured group health insurance business in ORMB. It also explains how to create policies, plans, and memberships for the fully-insured group health insurance.
Chapter 5	Self-Funded Group Health Insurance	Explains how to design the pricing and billing models for the self-funded group health insurance business in ORMB. It also explains how to create policies for the self-funded group health insurance.
Chapter 6	Individual Health Insurance	Explains how to design the pricing and billing models for the individual health insurance business in ORMB. It also explains how to create health products, plans, and memberships for the individual health insurance.
Chapter 7	Customer Registration	Describes how to create a person, account, policy, and policy plan through a customer registration object.

Chapter Number	Chapter Name	Chapter Description
Chapter 8	Customer 360° View	Explains how to view in-depth information about the person, account, or policy in the Customer 360° View screen. It explains how to create sort records for bill groups and derivation and pricing parameters for bill groups. It explains how to view the pricing rules of a parent customer and the pricing rules defined for a policy of a bill group. It also explains how to define, edit, and delete the different types of pricing rules of a parent customer and bill group. In addition, it explains how to view the detailed information about the bill.
Chapter 9	Pricing Management (Health Insurance Business)	Explains the different concepts of the pricing model supported in the application. It explains how to define a parameter, price item, price list, and tiering criterion. It also explains how to define pricing for a price item, how to assign a price item to a price list, and how to assign a price list to a person or account.
Chapter 10	Division	Describes the different types of division. It also explains how to define a division.
Chapter 11	Approval Workflow	Describes the approval workflow process and explains how to perform various tasks involved in the process. It explains how to implement the approval workflow process for an entity, such as account, person, and so on. It explains how to define an approval workflow group, approval workflow chain, approval workflow criterion type, approval workflow group chain linkage, approval workflow reasons, and approval workflow settings.
Chapter 12	Rules Engine	Describes how the rules engine function. It explains how to define, execute, and maintain business rules separately from the application code.
Chapter 13	Alternate Sequential Bill Numbers	Explains how to generate alternate sequential bill numbers which are either unique throughout the system or within the division.
Chapter 14	Transaction Feed Management	Describes the transaction feed management process and its sub-processes. It explains how to execute each sub-process. It also explains how to view the details of various transactions uploaded in the system. In addition, it explains how to create a transaction source, transaction record type, transaction aggregation rule, aggregation schedule, and disaggregation request.
Chapter 15	Upload Validated Payment Data	Explains how to upload and validate the payment records before you move them to the staging area. It also explains how to create payment events and payments using the validated payment records.
Chapter 16	Freeze Payments on Notification	Explains how the system freezes or cancels the automatic payments, voids the refund requests and cancels the refund adjustments when the review comments are received from the auto clearing house.
Chapter 17	Trial Billing	Explains how to generate trial bills before the actual bill is generated for an account. It also explains how to view the trial bills in the system.
Chapter 18	GL Account Validation	Explains how to enable the static or dynamic GL account validation feature.
Chapter 19	Upload Validated Adjustment Data	Explains how to validate and upload an adjustment data file and create adjustments through an adjustment upload request.

Chapter Number	Chapter Name	Chapter Description
Chapter 20	Payment Request	Explains how to create or transfer payments through a payment request.
Chapter 21	Account Receivable Central	Explains how to use the Account Receivable Central screen to search for a bill which you need to offset against another bill. It explains how to perform single, mass, and cross currency offset against one or more bills. It also enables you to create a hold request, refund request, write off request, and dispute request through this screen.
Chapter 22	Offset Request	Explains how to offset the bill's outstanding amount against one or more bills through an offset request. It explains how to create the offset request types and offset requests in the system.
Chapter 23	Funding Request	Describes how to change the automatic payment amount through the funding process. It explains how to create the funding request types and funding requests in the system.
Chapter 24	Refund/Write Off Request	Describes how to refund a payment or credit bill or bill line item and write off a debit bill or bill line item through a refund or write off request, respectively. It explains how to create the refund or write off request types and refund or write off requests in the system.
Chapter 25	Hold Request	Describes how to hold some processes and/or bills at the account or person level for a time period through a hold request. It explains how to create the hold request types and hold requests in the system.
Chapter 26	Delinquency Central	Explains how to track the overdue processes of a delinquent account through the Delinquency Central screen. It also explains how to create a hold request, payment arrangement, and promise to pay for a delinquent account from this screen.
Chapter 27	Upload Request	Explains how to do the following through an upload request: <ul style="list-style-type: none"> • Update bill cycle of accounts • Update contract riders in contracts • Create hold requests, refund requests, write off requests, or billable charges • Reinstate the policies • Create sort records for bill groups • Create derivation and pricing parameters for bill groups
Chapter 28	General Ledger (GL) Accounting Template	Describes how to override the distribution code used for creating FT GL entries using the GL Accounting Template feature. It explains how to create the GL accounting templates for each process and sub processes combination.
Chapter 29	Payment Agreement Request	Describes how to schedule payments in installments for a set of unpaid bills of an account through a payment agreement request. It explains how to create the payment agreement request types and payment agreement requests in the system.

Chapter Number	Chapter Name	Chapter Description
Chapter 30	Inbound Message	Explains how to create the customer and membership inbound messages through the web services. It explains the XML format in which the customer and membership data should be available while calling the respective web service. It also explains how to create the inbound message types and how to process the inbound messages in the system.
Chapter 31	Upload Lockbox Payment and Remittance Advices	Explains how to upload lockbox payment and remittance advices received in the Electronic Data Exchange (EDI) 820 format. It also explains the format in which EDI 820 flat file should be uploaded in the system.
Chapter 32	Deferred Revenue Recognition	Describes how to recognize the deferred revenue in the system. It explains how to create a deferred revenue recognition template for each distribution code and contract type combination. It also explains how to generate the schedule for a deferred revenue recognition. In addition, it explains how to edit the deferred revenue recognition schedule.
Chapter 33	Reconciliation	Describes how to reconcile pay instructions received from the external system against the bill segments based on the account identifier, policy number, plan number, member identifier, and coverage period combination. It explains the CSV and EDI 820 file formats in which you can upload the pay instructions. It also explains how to create reconciliation types, reconciliations, discrepancy report types, and discrepancy reports in the system.
Chapter 34	Self-Funded Pricing	Explains how to create the following in the system: <ul style="list-style-type: none"> • Claim, Specific Stop-Loss, Aggregate Stop-Loss, Retention Type Claim Based, Retention Type Enrollment Based, One-Time Flat Fees, Bill Period Based Recurring Flat Fees, Frequency Based Recurring Flat Fees, Ancillary, Discount, and Level-Funded pricing rule types • Claim, Specific Stop-Loss, Aggregate Stop-Loss, Retention Type Claim Based, Retention Type Enrollment Based, Ancillary, and Level-Funded pricing rules for the parent customers and the policies of the bill groups • One-Time Flat Fees, Bill Period Based Recurring Flat Fees, and Frequency Based Recurring Flat Fees pricing rules for the policies of the bill groups • Discount pricing rules for the parent customers
Chapter 35	Stop-Loss	Explains how to accumulate the specific stop-loss and aggregate stop-loss and create billable charges for them.
Chapter 36	Self-Funded Billing	Explains the billing process for the self-funded plans.
Chapter 37	Fully-Insured Pricing	Explains how to create the following in the system: <ul style="list-style-type: none"> • Age Based, Tier Based, and Pass-Through Billable Charge pricing rule types • Age Based and Tier Based pricing rules for the fully-insured group policy plans

Chapter Number	Chapter Name	Chapter Description
Chapter 38	Fully-Insured Group Billing	Explains how the system creates the fully-insured pass-through billable charges.
Chapter 39	Off-Process Request	Describes how to amend the agreed limits, funds, or calculated amounts of the accumulation products within the policy period through an off-process request. It explains how to create the off-process request types and off-process requests in the system.
Chapter 40	Individual Health Insurance Pricing	Explains how to define the pricing for different services offered in a health plan.
Chapter 41	Individual Health Insurance Billing	Explains how the system calculates premium for an individual using the fully-insured pricing and new born business rules.
Chapter 42	Entity Audit	Explains how to use the entity audit framework to track various actions, such as add, update, and delete for an entity.
Chapter 43	Invoice Request	Describes how to create adhoc regular and trial bills for an account through an invoice request. It explains how to create the invoice request types and invoice requests in the system.
Chapter 44	Mass Payment Transfer	Explains how the system facilitates mass payment transfer using the File Upload Interface utility.
Chapter 45	FOP Reports	Lists various FOP reports using which you can extract data from the system in the PDF format.
Chapter 46	Garbling Customer Information	Explains how to garble the personal information of a customer, such as the customer name, address, email ID, social security number or any other identifier, birth date, gender, and so on, on receiving the data erasure request from the customer.
Appendix A	Most Commonly Used Tasks	Lists and describes some of the common tasks that you may perform while using the application.
Appendix B	Administration	Describes how to create UI maps and set various feature configurations in the system.

Conventions

The following conventions are used across this document:

Convention	Meaning
boldface	Boldface indicates graphical user interface elements associated with an action, or terms defined in the text.
<i>italic</i>	Italic indicates a document or book title.
Monospace	Monospace indicates information that an end-user needs to enter in the application.

Related Documents

You can refer to the following documents for more information:

Document Name	Description
<i>Oracle Revenue Management and Billing Version 3.1.0.0.0 Release Notes</i>	Provides a brief description about the new features, enhancements, and UI level changes introduced in the current release. The new features and enhancements are classified under three distinct heads – Generic (which is intended for both domains), Financial Services, and Health Insurance. It also contains high-level information about the supported platforms, framework upgrade, supported upgrades, and documentation updates. In addition, it contains a list of discontinued features, planned deprecation notices, customer bugs fixed or forward ported and known issues in the current release.
<i>Oracle Utilities Application Framework Business Process Guide</i>	Explains how to get acquainted with the user interface. It explains the different types of pages or portals that you may come across in the application. It explains how to set the user preferences and how to create, manage, assign, and complete a To Do in the application. It also explains how to submit reports and view historic reports in the application.
<i>Oracle Utilities Application Framework Administrative Guide</i>	Explains the general, security, user, designing, developing, and scripting options available in Oracle Utilities Application Framework (OUAF). It describes the user interface, database, configuration, and reporting tools available in OUAF. In addition, it provides information about the application viewer, how to configure incoming and outgoing messages, and how to integrate Lightweight Directory Access Protocol (LDAP), Oracle Identity Manager (OIM), and Batch Scheduler with Oracle Revenue Management and Billing (ORMB).
<i>Oracle Revenue Management and Billing Business Process Guide</i>	<p>Explains how to maintain the demographic, geographic, and financial objects (i.e. accounts) of a customer. It explains how to manage a customer's bills, payments, adjustments, credits, collections processing, statements and deposits in Oracle Revenue Management and Billing (ORMB). It also describes the financial transactions, case management, sales and marketing functions, rates engine, quotations, loans, how to monitor and execute job streams, and how to manage workflows, notifications and overdue processing. In addition, it explains how to extract the data from the system using an extract template.</p> <p>The features listed and described in this document can be used in both financial services and health insurance domains.</p>
<i>Oracle Revenue Management and Billing Administrative Guide</i>	<p>Explains how to configure various features and functionalities in Oracle Revenue Management and Billing (ORMB). For example, billing, payments, adjustments, financial transactions, credits, collections processing, loans, service credits, background processes, quotations, case management, security, overdue processing, batch scheduler, workflow and notifications, etc.</p> <p>The information available in this document can be used in both financial services and health insurance domains.</p>

Document Name	Description
<i>Oracle Revenue Management and Billing TFM - Batch Execution Guide</i>	Explains the sequence in which the batches should be executed while performing various tasks in the Transaction Feed Management (TFM) module. It provides detailed information about each TFM batch and its parameters. It also indicates the restart and multi-threading ability of each batch. In addition, it recommends values for various parameters which can be used for tuning batch performance as per the available hardware.
<i>Oracle Revenue Management and Billing Batch Guide</i>	Provides detailed information about various batches which are used in different modules, such as billing, payments, financial transaction, pricing management, funding request, offset request, hold request, upload request, inbound message, payment agreement request, accruals, earnings credit rate, ILM, deferred revenue recognition, reconciliation, garbling, repricing, entity audit, statements, etc. It also contains information about the batch parameters and the batch restart and multi-threading abilities.

Change Log

Revision	Last Update	Chapter Name	Updated Section	Comments
13.1	23-11-2021	Fully-Insured Group Health Insurance	Membership	Added Information
		Individual Health Insurance	Individual Membership	Added Information
		Health Insurance Business Management	Membership Identifier Type	Updated Information
13.2	02-02-2022	Fully-Insured Group Billing	Membership Premium Calculation Through Inbound Web Service	Updated Information
		FOP Reports	-	Added Chapter
		Garbling Customer Information	-	Added Chapter
13.3	07-04-2022	Hold Request	-	Updated Information
		Alternate Sequential Bill Numbers	-	Updated Information
13.4	09-11-2022	Mass Payment Transfer	-	Added Chapter
13.5	24-01-2023	Inbound Message	Inbound Message (Used for Searching)	Updated Information

Revision	Last Update	Chapter Name	Updated Section	Comments
13.6	24-04-2023	Fully-Insured Pricing	Discount Charge Pricing for Retiree Membership	Added Information
		Administration	Setting the C1-PAYFLUPLD Feature Configuration	Updated Information
13.7	12-04-2024	Invoice Request	Invoice Request Type	Added Information

Chapter 1

Fully-Insured Group Customer Management

Topics:

- [Fully-Insured Entities](#)

A fully-insured group health plan is the traditional way to structure an employer-sponsored health plan. In the fully-insured group health plan, the employer contracts an insurance company to cover the employees and dependents. The employer pays a premium to the insurance carrier. The premium rates are fixed for a year, based on the number of employees enrolled in the plan each month. The monthly premium changes during the year when the number of enrolled employees in the plan changes. The insurance carrier collects the premiums and pays the health insurance claims based on the coverage benefits outlined in the policy. The covered persons (i.e. employees and dependents) are responsible to pay any deductible amounts or co-payments required for covered services under the policy.

The system enables you to create customers and accounts for the fully-insured group health insurance business. This chapter explains how to create different entities involved in the fully-insured group health insurance business.

Related Topics

For more information on...	See...
Fully-Insured Entities	Fully-Insured Entities on page 58

Fully-Insured Entities

The following figure graphically represents the different entities involved in the fully-insured group health insurance business:

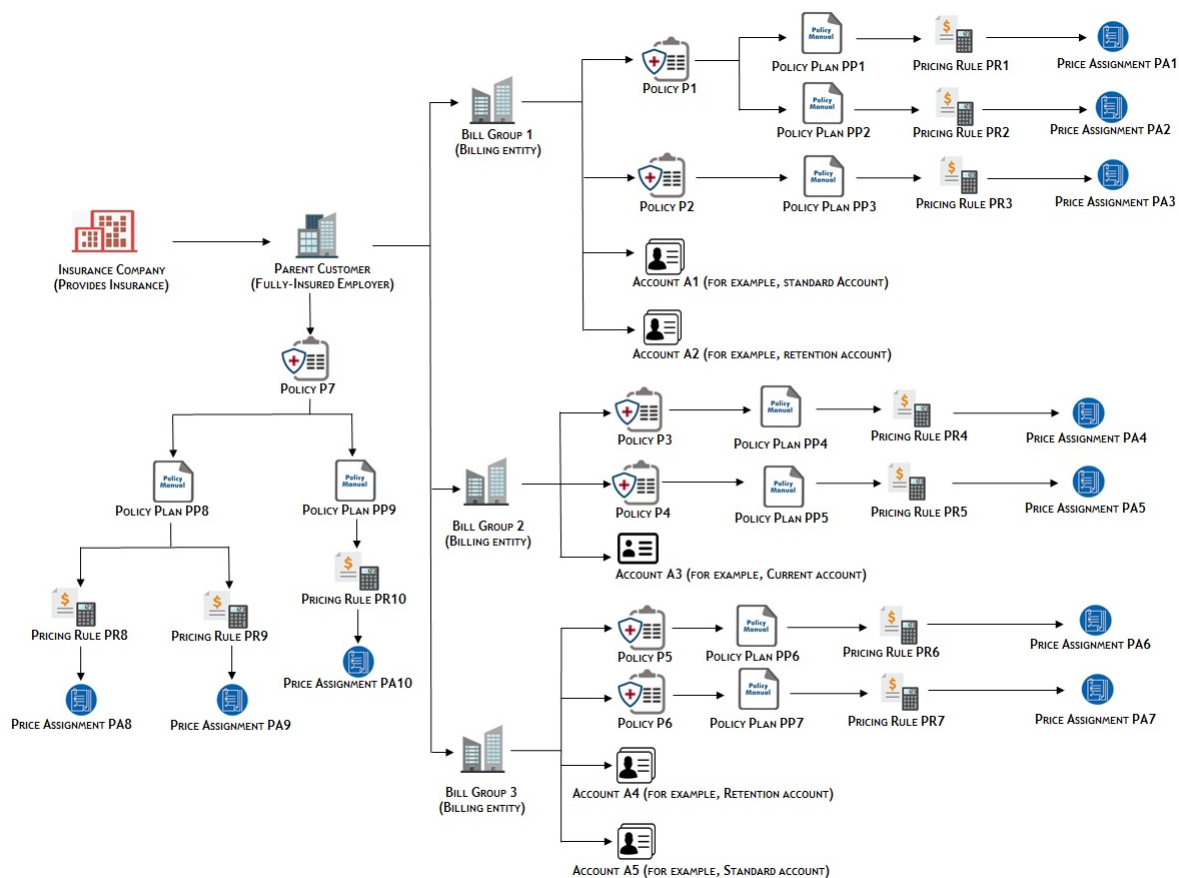

Related Topics

For more information on...	See...
Parent Customer	Parent Customer on page 59
Bill Groups	Bill Groups on page 59
Bill Group's Account	Bill Group's Account on page 59
Fully-Insured Group Policy	Fully-Insured Group Policy on page 60
Policy Plans	Policy Plans on page 60
Price Items	Price Items on page 61
Pricing Rule Types	Pricing Rule Types on page 61
Pricing Rules	Pricing Rules on page 61
Price Assignments	Price Assignments on page 61

Parent Customer

The fully-insured employers must be defined as parent customers in the system. You can define a person as the parent customer by setting its person type to **Parent Customer**. You can create a parent customer through a customer registration object or a health care inbound message.

Bill Groups

The system allows you to define one or more bill groups for a parent customer. The membership premium of the employees are billed to a bill group. Each bill group will handle the membership premium of employees based on the employee attributes, such as location, employment status, employment department, and so on. The system allows you to define the derivation and pricing parameters, such as source system, parameter 1, parameter 2, parameter 3, and parameter 4 for a bill group. These parameters are used to derive the bill group against which the membership premium should be billed in the system. You can define a person as the bill group by setting its person type to **Bill Group**. The bill groups should be defined as the child persons of the parent customer (i.e. fully-insured employer) using the relationship type which is specified in the **Person Relationship Type** option type of the **C1-ASOBLNG** feature configuration. You can create a bill group through a customer registration object or a health care inbound message.

Related Topics

For more information on...	See...
Bill Group Derivation and Pricing Parameters	Bill Group Derivation and Pricing Parameters on page 2946
How to setup the C1-ASOBLNG feature configuration	Setting the C1-ASOBLNG Feature Configuration on page 3421

Bill Group's Account

The membership premium of employees are billed to the bill group's account. Therefore, every bill group should have at least one account in the system. You can create multiple accounts for a bill group. You can create an account for a bill group through a customer registration object or a health care inbound message.

Depending on the employer's preference, the charges for one or more membership and price item combinations can be billed on the same or different accounts of the bill group. The system enables you to create different types of accounts (such as, MEDCARE1 and MEDCARE2) for a bill group. You can specify the type of account by defining the **Invoice Type (C1INVTYP)** characteristic for the account.

Note: At present, we have not shipped any predefined values for the **Invoice Type (C1INVTYP)** characteristic type. You must define the predefined characteristic values as per the business requirements.

You can also set the priority for an account based on the invoice type while specifying the billing account information for a price item in a pricing rule type. For example,

Price Item	Priority	Invoice Type	Account
P1	10	MEDCARE1	A1
	20	MEDCARE2	A2
P2	10	MEDCARE2	A2
	20	MEDCARE1	A1

Now, when the effective pricing rule is derived for P1 on the policy plan, the system checks whether an account where the **Invoice Type (C1INVTYP)** characteristic type is set to **MEDCARE1** exists for the bill group. If so, it considers the account (A1) of the bill group for billing. However, if an account where the **Invoice Type (C1INVTYP)** characteristic type is set to **MEDCARE1** does not exist for the bill group, the system checks whether an account where the **Invoice**

Type (C1INVTYP) characteristic type is set to **MEDCARE2** exists for the bill group. If so, it considers the account (A2) of the bill group for billing. If an account where the **Invoice Type (C1INVTYP)** characteristic type is set to **MEDCARE2** does not exist for the bill group, the status of the record in the **CI_REPRC_ENTITY_DTL** table is set to **Error (E)**.

Similarly, when the effective pricing rule is derived for P2 on the policy plan, the system considers the account of the bill group which is available based on the priority. The system derives the billing account for only those price items for which the effective pricing rule is derived.

The system searches the account of the bill group based on the priority when the **Invoice Type Characteristic Type** option type of the **C1-ASOBLNG** feature configuration is set to **C1INVTYP**.

Related Topics

For more information on...	See...
How to setup the C1-ASOBLNG feature configuration	Setting the C1-ASOBLNG Feature Configuration on page 3421

Fully-Insured Group Policy

You can create a fully-insured group policy using a policy type where the policy category is set to **Fully-Insured Group**. You can create a fully-insured group policy through a customer registration object or a health care inbound message. If the fully-insured group policy information is given for a bill group in a health care inbound message, the system does the following:

- Associates the bill group with the policy using the policy person role which is specified in the **Bill Group Policy Person Role** option type of the **C1-ASOBLNG** feature configuration
- Associates the parent customer with the policy using the policy person role which is specified in the **Parent Customer Policy Person Role** option type of the **C1-ASOBLNG** feature configuration

However, if the fully-insured group policy information is given for a parent customer in a health care inbound message, the system does the following:

- Associates the parent customer with the policy using the policy person role which is specified in the **Parent Customer Policy Person Role** option type of the **C1-ASOBLNG** feature configuration

Note: At present, the **Fully-Insured Individual** policy category is not yet supported in the system.

Policy Plans

A fully-insured group policy may cover various plans for medical, dental, or disability benefits. You can subscribe a person for one or more policy plans within or across policies. The system creates one membership for each person who is subscribed to the policy plan. You can then add dependent members in each membership whenever required.

While creating a policy plan, you need to specify either a price item or at least one pricing rule type. The price item given in the policy plan is used to create a pass-through billable charge for pre-calculated premium amount which is received in an inbound message.

Alternatively, you can associate a pricing rule type with a policy plan. You can only associate a pricing rule type where the pricing rule type category is set to **Age Based**, **Tier Based**, or **Pass-Through Billable Charge**. If you associate an age based pricing rule type with the policy plan, the system creates the SQI based billable charge whenever the membership premium is calculated for eligible members. If you associate a tier based pricing rule type with the policy plan, the system creates the SQI based billable charge whenever the premium is calculated for membership. However, if you associate a pass-through billable charge pricing rule type with the policy plan, the system creates an SQI based billable charge using the pass-through billable charge pricing rule type whenever the price item information is given, but the account information is not given in a health care inbound message. Note that if both the price item and account details are given in the billable charge information, the system directly creates the SQI based billable charge for the pre-calculated premium and does not refer the pass-through billable charge pricing rule type which is associated with the policy plan.

Price Items

Each service offered in the fully-insured group health plan should be defined as a price item in the system. You can define a price item from the user interface. You must add the price item in a pricing rule type. The system then enables you to create a pricing rule for a price item using the respective pricing rule type.

Pricing Rule Types

You can create a pricing rule using the respective pricing rule type. The system enables you to create pricing rule types of the following categories for the fully-insured group health plan through a health care inbound message:

Pricing Rule Type	Pricing Rule Type Category	Sample Shipped with the Product
Age Based	Age Based	AGE_BASED
Tier Based	Tier Based	TIER_BASED
Pass-Through Billable Charge	Pass-Through Billable Charge	FI_PASSTBC

Note: You cannot define a pricing rule using a pricing rule type where the pricing rule type category is set to **Pass-Through Billable Charge**.

Pricing Rules

The fully-insured group health plan may offer various services to the employer, such as medical insurance, dental insurance, vision care, life insurance, short-term and long-term disability benefits, and so on. Oracle Revenue Management and Billing enables you to define pricing rules for various services offered in the fully-insured group health plan. The below table lists the pricing rules which you can define for the following services offered in the fully-insured group health plan:

Service	Pricing Rule	Created for....
Medical Insurance, Dental Insurance, Vision Care, Life Insurance, Short-Term and Long-Term Disability Benefits, etc.	Age Based	Fully-Insured Group Policy Plan
	Tier Based	Fully-Insured Group Policy Plan

You can create the above mentioned pricing rules for the fully-insured group policy plans through a health care inbound message and not from the user interface. The system creates a price assignment for each pricing rule. In the age based pricing rules, you can define different premium fee for employees who belong different age band. You can also offer different premium fee for the employees with the same age band, but with the different set of attributes. The system also enables you to charge additional fee for the eligible member based on certain modifiers. For example, you can charge additional fee when the eligible member is alcoholic and/or consumes tobacco. However, in the tier based pricing rules, you can define different premium fee for employees who belong to different membership tier, such as Employee (E), Employee + Spouse (ES), Employee + Spouse + Children (F), and so on.

The system searches for the pricing rule of a price item (i.e. service) on the policy plan to which the membership belongs. If the effective pricing rule for a price item is not available on the policy plan, the system does not consider the respective price item for billing.

Price Assignments

The system creates a price assignment for each fully-insured pricing rule. If different premium fee is defined for employees with different set of employee attributes, then the system creates a separate price component for each set of employee attributes. If the modifiers are used in the age based pricing rule, the system creates a price component for each modifier. In the price component, the age band or tier band parameter, the employee attributes, and modifiers are used to define the pricing eligibility criteria. Once the age based or tier based pricing rule is defined for a policy plan, the system creates a price item pricing and price list, and then assigns the price item pricing to the price list.

Chapter

2

Self-Funded Customer Management

Topics:

- [Self-Funded Entities](#)

Self-funded health insurance, also known as Administrative Services Only (ASO), is a self insurance arrangement whereby an employer provides health or disability benefits to employees using the company's own funds. In self-funded health plan, employers operate their own health plan. However, in the fully-insured group health plan, the employer contracts an insurance company to cover the employees and dependents. Employers choose to self-insure because it allows them to save the profit margin that an insurance company adds to its premium for a fully-insured group health plan. However, self-insuring exposes the company to much larger risk in the event that more claims than expected must be paid.

Oracle Revenue Management and Billing (ORMB) supports the following types of self-funding approach:

- **Fully Self-Funded** - In the fully self-funded approach, the employer retains all the risk and bears the claim costs irrespective of any limit.
- **Partially Self-Funded** - In the partially self-funded approach, the employer purchases reinsurance or stop loss coverage to pass the risk to insurance company.

The system enables you to create customers and accounts for the self-funded health insurance business. This chapter explains how to create different entities involved in the self-funded health insurance business.

For more information on...	See...
Self-Funded Entities	Self-Funded Entities on page 64

Self-Funded Entities

The following figure graphically represents the different entities involved in the self-funded health insurance business:

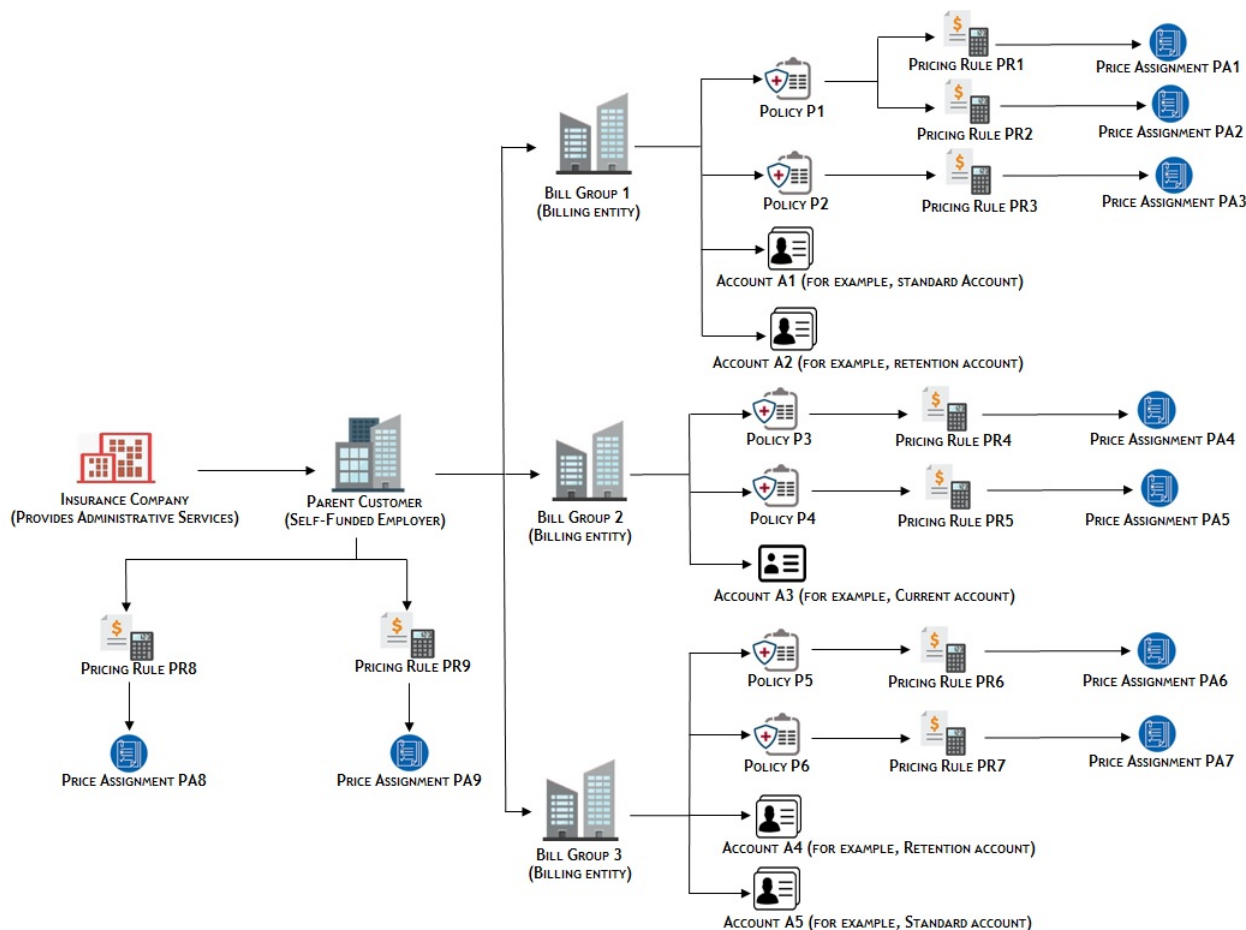

For more information on...	See...
Parent Customer	Parent Customer on page 65
Bill Group	Bill Groups on page 65
Bill Group's Account	Bill Group's Account on page 65
Self-Funded Policy	Self-Funded Policy on page 66
Price Items	Price Items on page 66
Pricing Rule Types	Pricing Rule Types on page 66
Pricing Rules	Pricing Rules on page 67
Price Assignments	Price Assignments on page 68

Parent Customer

The self-funded employers must be defined as parent customers in the system. You can define a person as the parent customer by setting its person type to **Parent Customer**. You can create a parent customer through a customer registration object or a health care inbound message.

Bill Groups

The system allows you to define one or more bill groups for a parent customer. The claim, enrollment, and ancillary transactions of the employees are billed to a bill group. Each bill group will handle the claim, enrollment, and ancillary transactions of employees based on the employee attributes, such as location, employment status, employment department, and so on. The system allows you to define the derivation and pricing parameters, such as source system, parameter 1, parameter 2, parameter 3, and parameter 4 for a bill group. These parameters are used to derive the bill group against which the claim, enrollment, and ancillary charges should be billed in the system. The derived bill group is also used for billing the claim based fees, specific stop-loss credits, aggregate stop-loss credits, discount, and level funding charges.

You can define a person as the bill group by setting its person type to **Bill Group**. The bill groups should be defined as the child persons of the parent customer (i.e. self-funded employer) using the relationship type which is specified in the **Person Relationship Type** option type of the **C1-ASOBLNG** feature configuration. You can create a bill group through a customer registration object or a health care inbound message.

Related Topics

For more information on...	See...
Bill Group Derivation and Pricing Parameters	Bill Group Derivation and Pricing Parameters on page 2946
How to setup the C1-ASOBLNG feature configuration	Setting the C1-ASOBLNG Feature Configuration on page 3421

Bill Group's Account

The claim charges, specific stop-loss credits, aggregate stop-loss credits, claim based fees, enrollment based fees, ancillary charges, discount, and level funding charges are billed to the bill group's account. Therefore, every bill group should have at least one account in the system. You can create multiple accounts for a bill group. You can create an account for a bill group through a customer registration object or a health care inbound message.

Depending on the employer's preference, the claim charges, specific stop-loss credits, aggregate stop-loss credits, claim based fees, enrollment based fees, ancillary charges, discount, and level funding charges can be billed on the same or different accounts of the bill group. The system enables you to create different types of accounts (such as, standard and retention) for a bill group. You can specify the type of account by defining the **Invoice Type (C1INVTYP)** characteristic for the account.

Note: At present, we have not shipped any predefined values for the **Invoice Type (C1INVTYP)** characteristic type. You must define the predefined characteristic values as per the business requirements.

You can also set the priority for an account based on the invoice type while specifying the billing account information for a price item in a pricing rule type. For example,

Price Item	Priority	Invoice Type	Account
P1	10	Standard	A1
	20	Retention	A2
P2	10	Retention	A2

Price Item	Priority	Invoice Type	Account
	20	Standard	A1

Now, when a claim transaction is mapped to P1, the system checks whether an account where the **Invoice Type (C1INVTYP)** characteristic type is set to **Standard** exists for the bill group. If so, it considers the standard account (A1) of the bill group for billing. However, if an account where the **Invoice Type (C1INVTYP)** characteristic type is set to **Standard** does not exist for the bill group, the system checks whether an account where the **Invoice Type (C1INVTYP)** characteristic type is set to **Retention** exists for the bill group. If so, it considers the retention account (A2) of the bill group for billing. If an account where the **Invoice Type (C1INVTYP)** characteristic type is set to **Retention** does not exist for the bill group, the status of the transaction is changed to **Error**.

Similarly, when a claim transaction is mapped to P2, the system considers the account of the bill group which is available based on the priority. The system derives the billing account for only those price items for which the effective pricing rule is derived.

The system searches the account of the bill group based on the priority when the **Invoice Type Characteristic Type** option type of the **C1-ASOBLNG** feature configuration is set to **C1INVTYP**.

Related Topics

For more information on...	See...
How to setup the C1-ASOBLNG feature configuration	Setting the C1-ASOBLNG Feature Configuration on page 3421

Self-Funded Policy

You can create a self-funded policy using a policy type where the policy category is set to **Self-Funded**. You can create a self-funded policy through a customer registration object or a health care inbound message. If the self-funded policy information is given for a bill group in a health care inbound message, the system does the following:

- Associates the bill group with the policy using the policy person role which is specified in the **Bill Group Policy Person Role** option type of the **C1-ASOBLNG** feature configuration
- Associates the parent customer with the policy using the policy person role which is specified in the **Parent Customer Policy Person Role** option type of the **C1-ASOBLNG** feature configuration

Price Items

Each service offered in the self-funded plan should be defined as a price item in the system. You must add the price item in a pricing rule type. The system then enables you to create a pricing rule for a price item using the respective pricing rule type.

You can define a price item and associate the required parameters with the price item from the user interface. You can use the price item parameters for defining multi parameter based pricing or for aggregating the transactions.

Pricing Rule Types

You can create a pricing rule using the respective pricing rule type. The system enables you to create pricing rule types of the following categories for the self-funded plan from the user interface:

Pricing Rule Type	Pricing Rule Type Category	Sample Shipped with the Product
Claim	Claim	CLAIM
Retention Type Claim Based	Retention Type Claim Based	RETCLMBSD
Discount Share	Discount Arrangement	DISSHARE
Discount Guarantee	Discount Arrangement	DISGUAR

Pricing Rule Type	Pricing Rule Type Category	Sample Shipped with the Product
One-Time Flat Fees	Flat Fees	ONETIMEFLATFEES
Bill Period Based Recurring Flat Fees	Flat Fees	RECFLATFEES_BP
Frequency Based Recurring Flat Fees	Flat Fees	RECFLATFEES_FREQ
Retention Type Enrollment Based	Retention Type Enrollment Based	RETENRLBSD
Ancillary	Ancillary	ANCILLARY
Specific Stop-Loss	Specific Stop-Loss	SSL
Aggregate Stop-Loss	Aggregate Stop-Loss	ASL
Enrollment Based Premium	Level Funded	LVLLENRLPRE
Flat Rate Based Premium	Level Funded	LVLFLATPRE

Pricing Rules

The self-funded plan may offer various services to the employer, such as claim administration, reinsurance or stop-loss, discount or level funding arrangement, and so on. Oracle Revenue Management and Billing enables you to define pricing rules for various services offered in the self-funded plan. The below table lists the pricing rules which you can define for the following services offered in the self-funded plan:

Service	Pricing Rule	Created for....
Claim Administration	Claim	Parent Customer
Claim Administration	Claim	Bill Group's Policy where the Parent Customer is the Policy Holder
Claim Administration	Retention Type Claim Based	Parent Customer
Claim Administration	Retention Type Claim Based	Bill Group's Policy where the Parent Customer is the Policy Holder
Claim Administration	Discount Share	Parent Customer
Claim Administration	Discount Guarantee	Parent Customer
Claim Administration	One-Time Flat Fees	Bill Group's Policy where the Parent Customer is the Policy Holder
Claim Administration	Bill Period Based Recurring Flat Fees	Bill Group's Policy where the Parent Customer is the Policy Holder
Claim Administration	Frequency Based Recurring Flat Fees	Bill Group's Policy where the Parent Customer is the Policy Holder
Enrollment	Retention Type Enrollment Based	Parent Customer
Enrollment	Retention Type Enrollment Based	Bill Group's Policy where the Parent Customer is the Policy Holder
Ancillary, such as Laboratory, Radiology, Pharmacy, Physical Therapy, or Preventive Care	Ancillary	Parent Customer

Service	Pricing Rule	Created for....
Ancillary, such as Laboratory, Radiology, Pharmacy, Physical Therapy, or Preventive Care	Ancillary	Bill Group's Policy where the Parent Customer is the Policy Holder
Stop-Loss	Specific Stop-Loss	Parent Customer
Stop-Loss	Specific Stop-Loss	Bill Group's Policy where the Parent Customer is the Policy Holder
Stop-Loss	Aggregate Stop-Loss	Parent Customer
Stop-Loss	Aggregate Stop-Loss	Bill Group's Policy where the Parent Customer is the Policy Holder
Level Funding Arrangement	Enrollment Based Premium	Parent Customer
Level Funding Arrangement	Enrollment Based Premium	Bill Group's Policy where the Parent Customer is the Policy Holder
Level Funding Arrangement	Flat Rate Based Premium	Parent Customer
Level Funding Arrangement	Flat Rate Based Premium	Bill Group's Policy where the Parent Customer is the Policy Holder

You can create the above mentioned self-funded pricing rules for a parent customer or for the policy of the bill group from the user interface and not through a health care inbound message.

The system creates a price assignment for each pricing rule. In case of the retention type claim and enrollment based pricing rules, the system creates multiple price assignments when different claim based or enrollment based fee is offered for employees with different set of employee attributes.

The system first searches for the pricing rule of a price item (i.e. service) at the bill group level. If the effective pricing rule for a price item is available at the bill group level, the system uses it for deriving the price assignment. However, if the effective pricing rule for a price item is not available at the bill group level, the system searches for the pricing rule of a price item at the parent customer level. If the effective pricing rule for a price item is available at the parent customer level, the system uses it for deriving the price assignment. However, if the effective pricing rule for a price item is not available at the bill group or parent customer level, the system does not consider the respective price item for billing.

Price Assignments

The system creates a price assignment for each self-funded pricing rule. In case of the retention type claim and enrollment based pricing rules, the system creates multiple price assignments when different claim based or enrollment based fee is offered for employees with different set of employee attributes.

The system automatically creates a price assignment whenever you create a self-funded pricing rule. The system creates the price assignment in a price list and assigns the price list to the parent customer or bill group. The system creates multiple price assignments when you define a pricing rule for a policy of a bill group using a pricing group.

Related Topics

For more information on...	See...
Pricing Group	Pricing Group on page 2522

Chapter

3

Health Insurance Business Management

Topics:

- [Policy Type](#)
- [Policy Person Role](#)
- [Contract Relationship Type](#)
- [Source System Extendable Lookup](#)
- [Extendable Lookup \(Source System\)](#)
- [Membership Identifier Type](#)
- [Pricing Parameters](#)
- [Geographic Rating Area](#)
- [Member Relationship Pricing Parameter](#)
- [Subscription Tier Pricing Parameter](#)
- [Medicare Benefits](#)
- [Geographic Rating Area Preference](#)
- [Member Relationship and Subscription Tier Preference](#)

Health insurance is a type of insurance coverage that typically pays for medical, surgical, prescription drug and sometimes dental expenses incurred by the insured. Health insurance can reimburse the insured for expenses incurred from illness or injury, or pay the care provider directly. It is often included in employer benefit packages as a means of enticing quality employees, with premiums partially covered by the employer but often also deducted from employee paychecks.

Oracle Revenue Management and Billing has extended its pricing and billing engines to meet the requirements of the following three lines of health insurance business:

- [Fully-Insured Group Health Insurance](#) on page 243
- [Self-Funded Group Health Insurance](#) on page 393
- [Individual Health Insurance](#) on page 441

To use the pricing and billing engines for the above three lines of health insurance business, you need to set the respective prerequisites:

Line of Business	Prerequisites
Fully-Insured Group Health Insurance	Refer to the Pre-requisites on page 245 section.
Self-Funded Group Health Insurance	Refer to the Pre-requisites on page 395 section.
Individual Health Insurance	Refer to the Pre-requisites section.

Policy Type

Oracle Revenue Management and Billing enables you to define a policy type using which you can create a policy. The policy type helps the system to determine:

- **Policy Category** - The category implies the line of business in the health insurance domain for which the policy should be created using the policy type. The valid values are:
 - Fully-Insured Group
 - Fully-Insured Individual
 - Self-Funded

Note: At present, the **Fully-Insured Individual** policy category is not supported in the system.



- **Policy Business Object** - The business object using which the policy should be created in the system. You can specify the **C1-POLICY** or **C1-ASOPolicy** business object depending on whether you want to create the policy type for the fully-insured group or self-funded health insurance business.

The **Policy Type** screen allows you to define, edit, copy, and delete a policy type. It contains the following zones:

- [Policy Type List](#) on page 70
- [Policy Type](#) on page 71

Policy Type List

The **Policy Type List** zone lists the policy types that are already defined in the system. It contains the following columns:

Column Name	Column Description
Policy Type	Displays the policy type.
Description	Displays the description of the policy type.
Policy Category	Indicates the category to which the policy type belongs. The valid values are: <ul style="list-style-type: none"> • Self-Funded • Fully-Insured Group • Fully-Insured Individual
Edit	On clicking the Edit () icon, the Policy Type screen appears where you can edit the details of the policy type.
Duplicate	On clicking the Duplicate () icon, the Policy Type screen appears where you can define a new policy type using an existing policy type.
Delete	On clicking the Delete () icon, you can delete the policy type. <p>Note: You can delete a policy type when a policy is not created using the policy type.</p>

Note: Pagination is used to display limited number of records in this zone. You can use the navigation links, such as **Previous** and **Next** to navigate between pages.

On clicking the **Broadcast** () icon corresponding to a policy type, the **Policy Type** zone appears with the details of the respective policy type.

You can filter the list using the **Policy Category** field available in the **Filter** area. By default, the **Filter** area is hidden. You can view the **Filter** area by clicking the **Filters** () icon in the upper right corner of this zone.

Related Topics

For more information on...	See...
How to edit a policy type	Editing a Policy Type on page 74
How to copy a policy type	Copying a Policy Type on page 76
How to delete a policy type	Deleting a Policy Type on page 78
How to view the details of a policy type	Viewing the Policy Type Details on page 78

Policy Type

The **Policy Type** zone displays the details of the policy type. It contains the following sections:

- **Main** - Displays basic information about the policy type. It contains the following fields:

Field Name	Field Description
Policy Type	Displays the policy type.
Policy Business Object	Indicates the business object using which the policy should be created. In addition, a context menu appears corresponding to this field which helps in navigating to other screens in the application. Note: It has a link. On clicking the link, the Business Object screen appears where you can view the details of the respective business object.
Description	Displays the description of the policy type.
Status	Indicates the status of the policy type. The valid values are: <ul style="list-style-type: none"> • Active • Inactive
Policy Category	Indicates the category to which the policy type belongs. The valid values are: <ul style="list-style-type: none"> • Self-Funded • Fully-Insured Group • Fully-Insured Individual
Detailed Description	Displays additional information about the policy type.

- **Characteristics** - Lists the characteristics defined for the policy type. It contains the following columns:

Column Name	Column Description
Characteristic Type	Indicates the characteristic type.
Characteristic Value	Displays the value of the characteristic type.

- **Record Actions** - This section contains the following buttons:

Button Name	Button Description
Edit	Used to edit the details of the policy type.

Button Name	Button Description
Delete	Used to delete the policy type.
	Note: You can delete a policy type when a policy is not created using the policy type.
Duplicate	Used to create a new policy type using an existing policy type.

- **Record Information** - This section contains the following field:

Field Name	Field Description
Business Object	Indicates the business object using which the policy type is created. In addition, a context menu appears corresponding to this field which helps in navigating to other screens in the application.
	Note: It has a link. On clicking the link, the Business Object screen appears where you can view the details of the respective business object.

By default, the **Policy Type** zone does not appear in the **Policy Type** screen. It appears when you click the **Broadcast** (📡) icon corresponding to the policy type in the **Policy Type List** zone.

Related Topics

For more information on...	See...
How to edit a policy type	Editing a Policy Type on page 74
How to delete a policy type	Deleting a Policy Type on page 78
How to copy a policy type	Copying a Policy Type on page 76
How to view the details of a policy type	Viewing the Policy Type Details on page 78

Defining a Policy Type

Prerequisites

To define a policy type, you should have:

- Required policy business object defined in the application

Note: The **C1-POLICY** and **C1-ASOPolicy** business objects are shipped with the product. You can use the **C1-POLICY** business object to create a fully-insured group policy and the **C1-ASOPolicy** business object to create a self-funded policy.

Procedure

To define a policy type:

1. Click the **Admin** link in the **Application** toolbar.
A list appears.
2. From the **Admin** menu, select **P** and then click **Policy Type**.
A sub-menu appears.
3. Click the **Add** option from the **Policy Type** sub-menu.

The **Policy Type** screen appears. It contains the following sections:

- **Main** - Used to specify basic details about the policy type.

- **Characteristics** - Used to define the characteristics for the policy type.

The **Main** section contains the following fields:

Field Name	Field Description	Mandatory (Yes or No)
Policy Type	Used to specify the policy type.	Yes
Business Object	Indicates the business object using which you are defining the policy type.	Not applicable
Policy Business Object	Used to indicate the business object using which you want to create a policy.	Yes
Description	Used to specify the description for the policy type.	Yes
Status	Used to indicate the status of the policy type. The valid values are: <ul style="list-style-type: none"> • Active • Inactive 	Yes
Policy Category	Used to indicate the category to which the policy type belongs. The valid values are: <ul style="list-style-type: none"> • Fully-Insured Group • Fully-Insured Individual • Self-Funded 	Yes
	Note: At present, the Fully-Insured Individual policy category is not supported in the system.	
Detailed Description	Used to specify additional information about the policy type.	No

Tip: Alternatively, you can access this screen by clicking the **Add** button in the **Page Title** area of the **Policy Type** screen.

4. Enter the required details in the **Main** section.

Note: If you want to create a policy type for the fully-insured group health insurance business, select the **C1-POLICY** business object from the **Policy Business Object** list and the **Fully-Insured Group** option from the **Policy Category** list. However, if you want to create a policy type for the self-funded health insurance business, select the **C1-ASOPolicy** business object from the **Policy Business Object** list and the **Self-Funded** option from the **Policy Category** list.

5. Define the characteristics for the policy type, if required.
6. Click **Save**.

The policy type is defined.

Related Topics

For more information on...	See...
Policy Type screen	Policy Type on page 70
How to define a characteristic for a policy type	Defining a Characteristic for a Policy Type on page 74

Defining a Characteristic for a Policy Type

Prerequisites

To define a characteristic for a policy type, you should have:

- Characteristic types defined in the application (where the characteristic entity is set to **Policy Type**).

Procedure

To define a characteristic for a policy type:

1. Ensure that the **Characteristics** section is expanded when you are defining, editing, or copying a policy type.

The **Characteristics** section contains the following fields in a grid:

Field Name	Field Description	Mandatory (Yes or No)
Characteristic Type	Used to indicate the characteristic type.	Yes (Conditional)
	Note: The list includes only those characteristic types where the characteristic entity is set to the Policy Type .	Note: This field is required when you are defining a characteristic for the policy type.
Characteristic Value	Used to specify the value for the characteristic type.	Yes (Conditional)
	Note: If you select a predefined characteristic type, the Search (🔍) icon appears corresponding to the Characteristic Value field. On clicking the Search icon, the Predefined Characteristic Search window appears. On specifying the value for a predefined characteristic type, the description of the characteristic value appears corresponding to the Characteristic Value field.	Note: This field is required when you are defining a characteristic for the policy type.

2. Enter the required details in the **Characteristics** section.
3. If you want to define more than one characteristic for the policy type, click the **Add** (+) icon and then repeat step 2.

Note: However, if you want to remove a characteristic from the policy type, click the **Delete** (🗑️) icon corresponding to the characteristic.

Related Topics

For more information on...	See...
How to define a policy type	Defining a Policy Type on page 72
How to edit a policy type	Editing a Policy Type on page 74
How to copy a policy type	Copying a Policy Type on page 76

Editing a Policy Type

Prerequisites

To edit a policy type, you should have:

- Required policy business object defined in the application

Note: The **C1-POLICY** and **C1-ASOPolicy** business objects are shipped with the product. You can use the **C1-POLICY** business object to create a fully-insured group policy and the **C1-ASOPolicy** business object to create a self-funded policy.

Procedure

To edit a policy type:

1. Click the **Admin** link in the **Application** toolbar.
A list appears.
2. From the **Admin** menu, select **P** and then click **Policy Type**.
A sub-menu appears.
3. Click the **Search** option from the **Policy Type** sub-menu.
The **Policy Type** screen appears.
4. In the **Policy Type List** zone, click the **Edit** (✎) icon in the **Edit** column corresponding to the policy type whose details you want to edit.

The **Policy Type** screen appears. It contains the following sections:

- **Main** - Used to specify basic details about the policy type.
- **Characteristics** - Used to define the characteristics for the policy type.

The **Main** section contains the following fields:

Field Name	Field Description	Mandatory (Yes or No)
Policy Type	Displays the policy type.	Not applicable
Business Object	Indicates the business object using which you are defining the policy type.	Not applicable
Policy Business Object	Used to indicate the business object using which you want to create a policy.	Yes
Description	Used to specify the description for the policy type.	Yes
Status	Used to indicate the status of the policy type. The valid values are: <ul style="list-style-type: none"> • Active • Inactive 	Yes
Policy Category	Used to indicate the category to which the policy type belongs. The valid values are: <ul style="list-style-type: none"> • Fully-Insured Group • Fully-Insured Individual • Self-Funded 	Yes
	Note: At present, the Fully-Insured Individual policy category is not supported in the system.	

Field Name	Field Description	Mandatory (Yes or No)
Detailed Description	Used to specify additional information about the policy type.	No

Tip: Alternatively, you can edit the details of a policy type by clicking the **Edit** button in the **Policy Type** zone.

5. Modify the required details in the **Main** section.
6. Define, edit, or remove characteristics of the policy type, if required.
7. Click **Save**.

The changes made to the policy type are saved.

Related Topics

For more information on...	See...
Policy Type screen	Policy Type on page 70
Policy Type List zone	Policy Type List on page 70
Policy Type zone	Policy Type on page 71
How to define a characteristic for a policy type	Defining a Characteristic for a Policy Type on page 74

Copying a Policy Type

Instead of creating a policy type from scratch, you can create a new policy type using an existing policy type. This is possible through copying a policy type. On copying a policy type, the details including the characteristics are copied to the new policy type. You can then edit the details, if required.

Prerequisites

To copy a policy type, you should have:

- Policy type (whose copy you want to create) defined in the application
- Required policy business object defined in the application

Note: The **C1-POLICY** and **C1-ASOPolicy** business objects are shipped with the product. You can use the **C1-POLICY** business object to create a fully-insured group policy and the **C1-ASOPolicy** business object to create a self-funded policy.

Procedure

To copy a policy type:

1. Click the **Admin** link in the **Application** toolbar.
A list appears.
2. From the **Admin** menu, select **P** and then click **Policy Type**.
A sub-menu appears.
3. Click the **Search** option from the **Policy Type** sub-menu.
The **Policy Type** screen appears.
4. In the **Policy Type List** zone, click the **Duplicate** () icon in the **Duplicate** column corresponding to the policy type whose copy you want to create.

The **Policy Type** screen appears. It contains the following sections:

- **Main** - Used to specify basic details about the policy type.
- **Characteristics** - Used to define the characteristics for the policy type.

The **Main** section contains the following fields:

Field Name	Field Description	Mandatory (Yes or No)
Policy Type	Used to specify the policy type.	Yes
Business Object	Indicates the business object using which you are defining the policy type.	Not applicable
Policy Business Object	Used to indicate the business object using which you want to create a policy.	Yes
Description	Used to specify the description for the policy type.	Yes
Status	Used to indicate the status of the policy type. The valid values are: <ul style="list-style-type: none"> • Active • Inactive 	Yes
Policy Category	Used to indicate the category to which the policy type belongs. The valid values are: <ul style="list-style-type: none"> • Fully-Insured Group • Fully-Insured Individual • Self-Funded 	Yes
	Note: At present, the Fully-Insured Individual policy category is not supported in the system.	
Detailed Description	Used to specify additional information about the policy type.	No

Tip: Alternatively, you can copy a policy type by clicking the **Duplicate** button in the **Policy Type** zone.

5. Enter the required details in the **Main** section.
6. Define, edit, or remove characteristics of the policy type, if required.
7. Click **Save**.

The new policy type is defined.

Related Topics

For more information on...	See...
Policy Type screen	Policy Type on page 70
Policy Type List zone	Policy Type List on page 70
Policy Type zone	Policy Type on page 71
How to define a characteristic for a policy type	Defining a Characteristic for a Policy Type on page 74

Deleting a Policy Type

Procedure

To delete a policy type:

1. Click the **Admin** link in the **Application** toolbar.
A list appears.
2. From the **Admin** menu, select **P** and then click **Policy Type**.
A sub-menu appears.
3. Click the **Search** option from the **Policy Type** sub-menu.
The **Policy Type** screen appears.
4. In the **Policy Type List** zone, click the **Delete** (🗑️) icon in the **Delete** column corresponding to the policy type that you want to delete.
A message appears confirming whether you want to delete the policy type.

Note: You can delete a policy type when a policy is not created using the policy type.

Tip: Alternatively, you can delete a policy type by clicking the **Delete** button in the **Policy Type** zone.

5. Click **OK**.
The policy type is deleted.

Related Topics

For more information on...	See...
Policy Type screen	Policy Type on page 70
Policy Type List zone	Policy Type List on page 70
Policy Type zone	Policy Type on page 71

Viewing the Policy Type Details

Procedure

To view the details of a policy type:

1. Click the **Admin** link in the **Application** toolbar.
A list appears.
2. From the **Admin** menu, select **P** and then click **Policy Type**.
A sub-menu appears.
3. Click the **Search** option from the **Policy Type** sub-menu.
The **Policy Type** screen appears.
4. In the **Policy Type List** zone, click the **Broadcast** (📡) icon corresponding to the policy type whose details you want to view.
The **Policy Type** zone appears.
5. View the details of the policy type in the **Policy Type** zone.

Related Topics

For more information on...	See...
Policy Type screen	Policy Type on page 70
Policy Type List zone	Policy Type List on page 70
Policy Type zone	Policy Type on page 71



Policy Person Role

Oracle Revenue Management and Billing enables you to specify the role of a person while associating the person to a policy. This helps to indicate whether the person is a policy holder, broker, underwriter, and so on in a policy. The **Policy Person Role** screen allows you to define, edit, and delete a policy person role. It contains the following zone:

- [Policy Person Role List](#) on page 79

Policy Person Role List

The **Policy Person Role List** zone lists the roles which you can assign to a person in a policy. It contains the following columns:

Column Name	Column Description
Policy Person Role	Displays the policy person role.
Description	Displays the description of the policy person role.
Edit	On clicking the Edit () icon, the Policy Person Role screen appears where you can edit the details of the policy person role.
Delete	On clicking the Delete () icon, you can delete the policy person role.
	Note: You can delete a policy person role when it is not used while associating a person with a policy.

You can define a new policy person role by clicking the **Add** link in the upper-right corner of this zone.

You can filter the list using various search criteria (such as **Policy Person Role** and **Description**) available in the **Filter** area. By default, the **Filter** area is hidden. You can view the **Filter** area by clicking the **Filters** () icon in the upper-right corner of this zone.

You can change the layout of this zone. For more information on how to change the layout, see [Changing the Layout](#) on page 3414.

Related Topics

For more information on...	See...
How to define a policy person role	Defining a Policy Person Role on page 79
How to edit a policy person role	Editing a Policy Person Role on page 80
How to delete a policy person role	Deleting a Policy Person Role on page 81

Defining a Policy Person Role

Procedure

To define a policy person role:

1. Click the **Admin** link in the **Application** toolbar.
A list appears.
2. From the **Admin** menu, select **P** and then click **Policy Person Role**.
The **Policy Person Role** screen appears.
3. Click the **Add** link in the upper-right corner of the **Policy Person Role List** zone.
The **Policy Person Role** screen appears. It contains the following fields:

Field Name	Field Description	Mandatory (Yes or No)
Policy Person Role	Used to specify the policy person role.	Yes
Description	Used to specify the description for the policy person role.	Yes

4. Enter the required details in the **Policy Person Role** screen.
5. Click **Save**.
The policy person role is defined.

Related Topics

For more information on...	See...
Policy Person Role screen	Policy Person Role on page 79
Policy Person Role List zone	Policy Person Role List on page 79

Editing a Policy Person Role

Procedure

To edit a policy person role:

1. Click the **Admin** link in the **Application** toolbar.
A list appears.
2. From the **Admin** menu, select **P** and then click **Policy Person Role**.
The **Policy Person Role** screen appears.
3. In the **Policy Person Role List** zone, click the **Edit** (✎) icon in the **Edit** column corresponding to the policy person role whose details you want to edit.

The **Policy Person Role** screen appears. It contains the following fields:

Field Name	Field Description	Mandatory (Yes or No)
Policy Person Role	Displays the policy person role.	Not applicable
Description	Used to specify the description for the policy person role.	Yes

4. Modify the required details in the **Policy Person Role** screen.
5. Click **Save**.
The changes made to the policy person role are saved.

Related Topics

For more information on...	See...
Policy Person Role screen	Policy Person Role on page 79
Policy Person Role List zone	Policy Person Role List on page 79

Deleting a Policy Person Role

Procedure

To delete a policy person role:

1. Click the **Admin** link in the **Application** toolbar.
A list appears.
2. From the **Admin** menu, select **P** and then click **Policy Person Role**.
The **Policy Person Role** screen appears.
3. In the **Policy Person Role List** zone, click the **Delete** (🗑️) icon in the **Delete** column corresponding to the policy person role that you want to delete.
A message appears confirming whether you want to delete the policy person role.

Note: You can delete a policy person role only when it is not used while associating a person with a policy.

4. Click **OK**.
The policy person role is deleted.

Related Topics

For more information on...	See...
Policy Person Role screen	Policy Person Role on page 79
Policy Person Role List zone	Policy Person Role List on page 79

Contract Relationship Type

Oracle Revenue Management and Billing enables you to define various relationship types using which you can relate main subscriber and other dependent persons in a membership. The **Contract Relationship Type** screen allows you to define, edit, and delete such relationship types. It also allows you to filter the contract relationship types using various search criteria.

Filtering the Contract Relationship Types

Prerequisites

To filter the contract relationship types, you should have:

- Contract relationship types defined in the application

Procedure

To filter the contract relationship types:

1. Click the **Admin** link in the **Application** toolbar.
A list appears.
2. From the **Admin** menu, select **C** and then click **Contract Relationship Type**.

The **Contract Relationship Type** screen appears. It contains the following field:

Field Name	Field Description	Mandatory (Yes or No)
Relationship Type	Used to search a particular contract relationship type.	Yes

- Enter the search criteria in the **Relationship Type** field.

Note: ORMB search engine supports wildcard search, where you can substitute the percentage (%) symbol as a stand in for any word or letter in a search criteria. You can use the ‘%’ wildcard character in all input fields except the date and ID fields. The ‘%’ wildcard character is suffixed automatically at the end of the partial search criteria. Therefore, you may or may not specify the wildcard character at the end of the partial search criteria. However, you have to prefix the wildcard character manually wherever required.

- Click **Search**.

The search results are filtered based on the specified criteria.

Related Topics

For more information on...	See...
Contract Relationship Type screen	Contract Relationship Type on page 81

Defining a Contract Relationship Type

Procedure

To define a contract relationship type:

- Click the **Admin** link in the **Application** toolbar.
A list appears.
- From the **Admin** menu, select **C** and then click **Contract Relationship Type**.

The **Contract Relationship Type** screen appears. It contains the following fields in a grid:

Field Name	Field Description	Mandatory (Yes or No)
Relationship Type	Used to specify the contract relationship type.	Yes
Description	Used to specify the description for the contract relationship type.	Yes

- Enter the required details in the **Contract Relationship Type** screen.
- If you want to define more than one contract relationship type, click the **Add (+)** icon and then repeat step 3.

Note: However, if you want to remove a contract relationship type, click the **Delete (🗑)** icon corresponding to the contract relationship type.

- Click **Save**.

The contract relationship type is defined.

Related Topics

For more information on...	See...
Contract Relationship Type screen	Contract Relationship Type on page 81

Editing a Contract Relationship Type

Procedure

To edit a contract relationship type:

1. Click the **Admin** link in the **Application** toolbar.
A list appears.
2. From the **Admin** menu, select **C** and then click **Contract Relationship Type**.

The **Contract Relationship Type** screen appears.

3. If required, you can filter the list in the **Contract Relationship Type** screen.

A list of contract relationship types that meet the search criteria appears in the search results. The **Search Results** section contains the following fields in a grid:

Field Name	Field Description	Mandatory (Yes or No)
Relationship Type	Displays the contract relationship type.	Not applicable
Description	Used to specify the description for the contract relationship type.	Yes

4. Modify the required details in the **Contract Relationship Type** screen.
5. Click **Save**.

The changes made to the contract relationship type are saved.

Related Topics

For more information on...	See...
Contract Relationship Type screen	Contract Relationship Type on page 81
How to filter the contract relationship types	Filtering the Contract Relationship Types on page 81

Deleting a Contract Relationship Type

Procedure

To delete a contract relationship type:

1. Click the **Admin** link in the **Application** toolbar.
A list appears.
2. From the **Admin** menu, select **C** and then click **Contract Relationship Type**.

The **Contract Relationship Type** screen appears.

3. If required, you can filter the list in the **Contract Relationship Type** screen.

A list of contract relationship types that meet the search criteria appears in the **Search Results** section.

4. Click the **Delete** (🗑️) icon corresponding to the contract relationship type that you want to delete.

Note: You can delete a contract relationship type when it is not yet used in the system.

5. Click **Save**.

The contract relationship type is deleted.

Related Topics

For more information on...	See...
Contract Relationship Type screen	Contract Relationship Type on page 81
How to filter the contract relationship types	Filtering the Contract Relationship Types on page 81

Source System Extendable Lookup

Oracle Revenue Management and Billing enables you to track the external system from where the fully-insured group or self-funded policies are received for billing. Each external system must be defined in the system using the **Source System (C1-SourceSystemLookup)** extendable lookup.

The **Extendable Lookup Query** screen allows you to search for an extendable lookup. It contains the following zone:

- [Extendable Lookup Search](#) on page 84

Extendable Lookup Search

The **Extendable Lookup Search** zone allows you to search for an extendable lookup. It contains the following two sections:

- **Search Criteria** – The **Search Criteria** section contains the following fields:

Field Name	Field Description	Mandatory (Yes or No)
Business Object	Used to search a particular extendable lookup business object.	No
Description	Used to search extendable lookups with a particular description.	No

Note: You must specify at least one search criterion while searching for an extendable lookup.

- **Search Results** – On clicking the **Search** button, the search results appear based on the specified search criteria. The **Search Results** section contains the following columns:

Column Name	Column Description
Business Object	Displays the extendable lookup business object.
Description	Displays the description of the extendable lookup business object.
	Note: It has a link. On clicking the link, the Extendable Lookup screen appears where you can view the details of the respective extendable lookup.

Related Topics

For more information on...	See...
How to search for the Source System extendable lookup	Searching for the Source System Extendable Lookup on page 85
How to view the values of the Source System extendable lookup	Viewing the Values of the Source System Extendable Lookup on page 85

Searching for the Source System Extendable Lookup

Procedure

To search for the **Source System** extendable lookup:

1. Click the **Admin** link in the **Application** toolbar.
A list appears.
2. From the **Admin** menu, select **E** and then click **Extendable Lookup**.
The **Extendable Lookup Query** screen appears.
3. In the **Extendable Lookup Search** zone, enter **C1-SourceSystemLookup** in the **Business Object** field.

Note: ORMB search engine supports wildcard search, where you can substitute the percentage (%) symbol as a stand in for any word or letter in a search criteria. You can use the ‘%’ wildcard character in all input fields except the date and ID fields. The ‘%’ wildcard character is suffixed automatically at the end of the partial search criteria. Therefore, you may or may not specify the wildcard character at the end of the partial search criteria. However, you have to prefix the wildcard character manually wherever required.

4. Click **Search**.

The **Source System** extendable lookup business object appears in the **Search Results** section.

Related Topics

For more information on...	See...
Extendable Lookup Query screen	Source System Extendable Lookup on page 84
Extendable Lookup Search zone	Extendable Lookup Search on page 84

Viewing the Values of the Source System Extendable Lookup

Procedure

To view the values of the **Source System** extendable lookup:

1. Search for the **Source System** extendable lookup in the **Extendable Lookup Query** screen.
2. In the **Search Results** section, click the link in the **Description** column corresponding to the extendable lookup business object whose details you want to view.
The **Extendable Lookup** screen appears.
3. View the values of the **Source System** extendable lookup in the **Extendable Lookup Value List** zone.

Related Topics

For more information on...	See...
How to search for the source system extendable lookup	Searching for the Source System Extendable Lookup on page 85
Extendable Lookup screen	Extendable Lookup (Source System) on page 86

For more information on...	See...
Extendable Lookup Value List zone	Extendable Lookup Value List on page 86



Extendable Lookup (Source System)

The **Extendable Lookup** screen allows you to view the values of the **Source System (C1-SourceSystemLookup)** extendable lookup. It also allows you to define, edit, copy, and delete a source system. It contains the following zones:

- [Extendable Lookup Value List](#) on page 86
- [Extendable Lookup Value](#) on page 87

Extendable Lookup Value List

The **Extendable Lookup Value List** zone lists the values which are already defined for the **Source System** extendable lookup. It contains the following columns:

Column Name	Column Description
Value	Displays the source system.
Description	Displays the description of the source system.
Owner	Indicates who has created the source system. The valid values are: <ul style="list-style-type: none"> • Framework • Base • Customer Modification
Edit	On clicking the Edit () icon, the Extendable Lookup screen appears where you can edit the details of the source system.
Duplicate	On clicking the Duplicate () icon, the Extendable Lookup screen appears where you can define a new source system using an existing source system.
Delete	On clicking the Delete () icon, you can delete the source system.
	Note: You can delete a source system when it is not yet used in the system.
Detailed Description	Displays additional information about the source system.

Note: Pagination is used to display limited number of records in this zone. You can use the navigation buttons, such as **Previous** and **Next** to navigate between pages.

On clicking the **Broadcast** () icon corresponding to a source system, the **Extendable Lookup Value** zone appears with the details of the respective source system.

You can filter the list using various search criteria (such as, **Value** and **Description**) available in the **Filter** area. By default, the **Filter** area is hidden. You can view the **Filter** area by clicking the **Filters** () icon in the upper right corner of this zone.

Related Topics

For more information on...	See...
How to edit a source system	Editing a Source System on page 89

For more information on...	See...
How to copy a source system	Copying a Source System on page 90
How to delete a source system	Deleting a Source System on page 91
How to view the details of a source system	Viewing the Source System Details on page 91

Extendable Lookup Value

The **Extendable Lookup Value** zone displays the details of the source system. It contains the following sections:

- **Main** – Displays basic information about the source system. It contains the following fields:

Field Name	Field Description
Source System	Displays the source system.
Description	Displays the description of the source system.
Override Description	Displays the overridden description of the source system.
Detailed Description	Displays additional information about the source system.
Status	Indicates the status of the source system. The valid values are: <ul style="list-style-type: none"> • Active • Inactive

- **Record Actions** – This section contains the following buttons:

Button Name	Button Description
Edit	Used to edit the details of the source system.
Delete	Used to delete the source system.
	Note: You can delete a source system when it is not yet used in the system.
Duplicate	Used to create a source system using an existing source system.

- **Record Information** – This section contains the following fields:

Field Name	Field Description
Business Object	Indicates the extendable lookup business object using which the source system is created. In addition, a context menu appears corresponding to this field which helps in navigating to other screens in the application.
	Note: It has a link. On clicking the link, the Business Object screen appears where you can view the details of the respective business object.
Owner	Indicates who has created the source system. The valid values are: <ul style="list-style-type: none"> • Framework • Base • Customer Modification

By default, the **Extendable Lookup Value** zone does not appear in the **Extendable Lookup** screen. It appears when you click the **Broadcast** () icon corresponding to the source system in the **Extendable Lookup Value List** zone.

Related Topics

For more information on...	See...
How to edit a source system	Editing a Source System on page 89
How to copy a source system	Copying a Source System on page 90
How to delete a source system	Deleting a Source System on page 91
How to view the details of a source system	Viewing the Source System Details on page 91

Defining a Source System

Procedure

To define a source system:

1. Search for the **Source System** extendable lookup in the **Extendable Lookup Query** screen.
2. In the **Search Results** section, click the link in the **Description** column corresponding to the extendable lookup business object whose details you want to view.

The **Extendable Lookup** screen appears.

3. Click the **Add** button in the **Page Title** area of the **Extendable Lookup** screen.

The **Extendable Lookup** screen appears. It contains the following section:

- **Main** – Used to specify basic details about the source system.

The **Main** section contains the following fields:

Field Name	Field Description	Mandatory (Yes or No)
Source System	Used to specify the external system from where the policies are received for billing.	Yes
Description	Used to specify the description for the source system.	Yes
Override Description	Used when you want to override the description of the source system.	No
Detailed Description	Used to specify additional information about the source system.	No
Status	Used to indicate the status of the source system. The valid values are: <ul style="list-style-type: none"> • Active • Inactive 	Yes
	Note: By default, the value is set to Active .	

4. Enter the required details in the **Main** section.
5. Click **Save**.

The source system is added in the **C1-SourceSystemLookup** extendable lookup.

Related Topics

For more information on...	See...
How to search for the Source System extendable lookup	Searching for the Source System Extendable Lookup on page 85
Extendable Lookup screen	Extendable Lookup (Source System) on page 86

Editing a Source System

Procedure

To edit a source system:

1. Search for the **Source System** extendable lookup in the **Extendable Lookup Query** screen.
2. In the **Search Results** section, click the link in the **Description** column corresponding to the extendable lookup business object whose details you want to view.

The **Extendable Lookup** screen appears.

3. In the **Extendable Lookup Value List** zone, click the **Edit**  icon in the **Edit** column corresponding to the source system whose details you want to edit.

The **Extendable Lookup** screen appears. It contains the following section:

- **Main** – Used to specify basic details about the source system.

The **Main** section contains the following fields:

Field Name	Field Description	Mandatory (Yes or No)
Source System	Displays the source system.	Not applicable
Description	Used to specify the description for the source system.	Yes
Override Description	Used when you want to override the description of the source system.	No
Detailed Description	Used to specify additional information about the source system.	No
Status	Used to indicate the status of the source system. The valid values are: <ul style="list-style-type: none"> • Active • Inactive 	Yes

Tip: Alternatively, you can edit the details of a source system by clicking the **Edit** button in the **Extendable Lookup Value** zone.

4. Modify the required details in the **Main** section.
5. Click **Save**.

The changes made to the source system are saved.

Related Topics

For more information on...	See...
How to search for the Source System extendable lookup	Searching for the Source System Extendable Lookup on page 85
Extendable Lookup screen	Extendable Lookup (Source System) on page 86

For more information on...	See...
Extendable Lookup Value List zone	Extendable Lookup Value List on page 86
Extendable Lookup Value zone	Extendable Lookup Value on page 87

Copying a Source System

Instead of creating a source system from scratch, you can create a new source system using an existing source system. This is possible through copying a source system. On copying a source system, the details of the source system are copied to the new source system. You can then edit the details, if required.

Prerequisites

To copy a source system, you should have:

- Source system (whose copy you want to create) defined in the application

Procedure

To copy a source system:

1. Search for the **Source System** extendable lookup in the **Extendable Lookup Query** screen.
2. In the **Search Results** section, click the link in the **Description** column corresponding to the extendable lookup business object whose details you want to view.

The **Extendable Lookup** screen appears.

3. In the **Extendable Lookup Value List** zone, click the **Duplicate** () icon in the **Duplicate** column corresponding to the source system whose copy you want to create.

The **Extendable Lookup** screen appears. It contains the following section:

- **Main** – Used to specify basic details about the source system.

The **Main** section contains the following fields:

Field Name	Field Description	Mandatory (Yes or No)
Source System	Used to specify the external system from where the policies are received for billing.	Yes
Description	Used to specify the description for the source system.	Yes
Override Description	Used when you want to override the description of the source system.	No
Detailed Description	Used to specify additional information about the source system.	No
Status	Used to indicate the status of the source system. The valid values are: <ul style="list-style-type: none"> • Active • Inactive 	Yes

Tip: Alternatively, you can copy a source system by clicking the **Duplicate** button in the **Extendable Lookup Value** zone.

4. Enter the required details in the **Main** section.
5. Click **Save**.

The new source system is added in the **C1-SourceSystemLookup** extendable lookup.

Related Topics

For more information on...	See...
How to search for the Source System extendable lookup	Searching for the Source System Extendable Lookup on page 85
Extendable Lookup screen	Extendable Lookup (Source System) on page 86
Extendable Lookup Value List zone	Extendable Lookup Value List on page 86
Extendable Lookup Value zone	Extendable Lookup Value on page 87

Deleting a Source System**Procedure**

To delete a source system:

1. Search for the **Source System** extendable lookup in the **Extendable Lookup Query** screen.
2. In the **Search Results** section, click the link in the **Description** column corresponding to the extendable lookup business object whose details you want to view.

The **Extendable Lookup** screen appears.

3. In the **Extendable Lookup Value List** zone, click the **Delete** (🗑️) icon in the **Delete** column corresponding to the source system that you want to delete.

A message appears confirming whether you want to delete the source system.

Note: You can delete a source system when it is not yet used in the system.

Tip: Alternatively, you can delete a source system by clicking the **Delete** button in the **Extendable Lookup Value** zone.

4. Click **OK**.

The source system is deleted from the **C1-SourceSystemLookup** extendable lookup.

Related Topics

For more information on...	See...
How to search for the Source System extendable lookup	Searching for the Source System Extendable Lookup on page 85
Extendable Lookup screen	Extendable Lookup (Source System) on page 86
Extendable Lookup Value List zone	Extendable Lookup Value List on page 86
Extendable Lookup Value zone	Extendable Lookup Value on page 87

Viewing the Source System Details**Procedure**

To view the details of a source system:

1. Search for the **Source System** extendable lookup in the **Extendable Lookup Query** screen.
2. In the **Search Results** section, click the link in the **Description** column corresponding to the extendable lookup business object whose details you want to view.

The **Extendable Lookup** screen appears.

3. In the **Extendable Lookup Value List** zone, click the **Broadcast** () icon corresponding to the source system whose details you want to view.

The **Extendable Lookup Value** zone appears.

4. View the details of the source system in the **Extendable Lookup Value** zone.

Related Topics

For more information on...	See...
How to search for the Source System extendable lookup	Searching for the Source System Extendable Lookup on page 85
Extendable Lookup screen	Extendable Lookup (Source System) on page 86
Extendable Lookup Value List zone	Extendable Lookup Value List on page 86
Extendable Lookup Value zone	Extendable Lookup Value on page 87

Membership Identifier Type

Oracle Revenue Management and Billing enables you to define an identifier for the group and individual memberships using a membership identifier type. The **Membership Identifier Type** screen allows you to create, edit, delete, and copy a membership identifier type. It contains the following zones:

- [Membership Identifier Type List](#) on page 92
- [Membership Identifier Type](#) on page 93

When you create or edit a group or individual membership through a health care inbound message or through the membership repricing inbound web service, you can define various identifiers (for example, beneficiary ID, exchange subscriber ID, and so on) associated with the membership using the membership identifier type.

Related Topics

For more information on...	See...
How to define a membership identifier type	Defining a Membership Identifier Type on page 94
How to edit a membership identifier type	Editing a Membership Identifier Type on page 95
How to copy a membership identifier type	Copying a Membership Identifier Type on page 97
How to delete a membership identifier type	Deleting a Membership Identifier Type on page 98
How to view the details of a membership identifier type	Viewing the Membership Identifier Type Details on page 99

Membership Identifier Type List

The **Membership Identifier Type List** zone lists the membership identifier types that are already defined in the system. It contains the following columns:

Column Name	Column Description
Membership Identifier Type	Displays the membership identifier type.

Column Name	Column Description
Description	Displays the description of the membership identifier type.
Edit	On clicking the Edit (✎) icon, the Membership Identifier Type screen appears where you can edit the details of the membership identifier type.
Duplicate	On clicking the Duplicate (📄) icon, the Membership Identifier Type screen appears where you can define a new membership identifier type using an existing membership identifier type.
Delete	On clicking the Delete (🗑) icon, you can delete the membership identifier type.
	Note: You can delete a membership identifier type when it is not yet used in the system.

Note: Pagination is used to display limited number of records in this zone. You can use the navigation links, such as **Previous** and **Next** to navigate between pages.

On clicking the **Broadcast** (📡) icon corresponding to a membership identifier type, the **Membership Identifier Type** zone appears with the details of the respective membership identifier type.

Related Topics

For more information on...	See...
Membership Identifier Type zone	Membership Identifier Type on page 93
How to edit a membership identifier type	Editing a Membership Identifier Type on page 95
How to copy a membership identifier type	Copying a Membership Identifier Type on page 97
How to delete a membership identifier type	Deleting a Membership Identifier Type on page 98
How to view the details of a membership identifier type	Viewing the Membership Identifier Type Details on page 99

Membership Identifier Type

The **Membership Identifier Type** zone displays the details of the membership identifier type. It contains the following sections:

- **Main** - Displays the basic details of the membership identifier type. It contains the following fields:

Field Name	Field Description
Membership Identifier Type	Displays the membership identifier type.
Description	Displays the description of the membership identifier type.
Validation Algorithm	Indicates the algorithm which is used to validate the value of the membership identifier type.
	Note: It has a link. On clicking the link, the Algorithm screen appears where you can view the details of the respective algorithm.
Detailed Description	Displays additional information about the membership identifier type.

- **Record Actions** - This section contains the following buttons:

Button Name	Button Description
Edit	Used to edit the details of the membership identifier type.
Delete	Used to delete the membership identifier type.
	Note: You can delete a membership identifier type when it is not yet used in the system.
Duplicate	Used to create a new membership identifier type using an existing membership identifier type.

- **Record Information** - This section contains the following field:

Field Name	Field Description
Business Object	Indicates the business object using which the membership identifier type is created. In addition, a context menu appears corresponding to this field which helps in navigating to other screens in the application.
	Note: It has a link. On clicking the link, the Business Object screen appears where you can view the details of the respective business object.

By default, the **Membership Identifier Type** zone does not appear in the **Membership Identifier Type** screen. It appears only when you click the **Broadcast** () icon corresponding to a membership identifier type in the **Membership Identifier Type List** zone.

Related Topics

For more information on...	See...
Membership Identifier Type screen	Membership Identifier Type on page 92
Membership Identifier Type List zone	Membership Identifier Type List on page 92
How to edit a membership identifier type	Editing a Membership Identifier Type on page 95
How to copy a membership identifier type	Copying a Membership Identifier Type on page 97
How to delete a membership identifier type	Deleting a Membership Identifier Type on page 98
How to view the details of a membership identifier type	Viewing the Membership Identifier Type Details on page 99

Defining a Membership Identifier Type

Prerequisites

To define a membership identifier type, you should have:

- Validation algorithm defined in the application (in case you want to use it)

Note: No validation algorithm type for membership identifier type is shipped with the product. However, the **Membership Identifier Type - Validation** algorithm entity is available in the application. You can create the required custom validation algorithms for the **Membership Identifier Type - Validation** algorithm entity.

Procedure

To define a membership identifier type:

1. Click the **Admin** link in the **Application** toolbar.
A list appears.
2. From the **Admin** menu, select **M** and then click **Membership Identifier Type**.
A sub-menu appears.
3. Click the **Add** option from the **Membership Identifier Type** sub-menu.

The **Membership Identifier Type** screen appears. It contains the following section:

- **Main** - Used to specify the basic details of the membership identifier type. It contains the following fields:

Field Name	Field Description	Mandatory (Yes or No)
Membership Identifier Type	Used to specify the membership identifier type.	Yes
Description	Used to specify the description for the membership identifier type.	Yes
Validation Algorithm	Used to indicate the algorithm using which you want to validate the value of the membership identifier type. It is triggered when you define an identifier for a membership using the membership identifier type. Note: The Search (🔍) icon appears corresponding to the Validation Algorithm field. On clicking the Search icon, the Algorithm Search window appears.	No
Detailed Description	Used to specify additional information about the membership identifier type.	No

Tip: Alternatively, you can access the **Membership Identifier Type** screen by clicking the **Add** button in the **Page Title** area of the **Membership Identifier Type** screen.

4. Enter the required details in the **Main** section.
5. Click **Save**.

The membership identifier type is defined.

Related Topics

For more information on...	See...
Membership Identifier Type screen	Membership Identifier Type on page 92

Editing a Membership Identifier Type**Prerequisites**

To edit a membership identifier type, you should have:

- Validation algorithm defined in the application (in case you want to use it)

Note: No validation algorithm type for membership identifier type is shipped with the product. However, the **Membership Identifier Type - Validation** algorithm entity is available in the application. You can create the required custom validation algorithms for the **Membership Identifier Type - Validation** algorithm entity.

Procedure

To edit a membership identifier type:

1. Click the **Admin** link in the **Application** toolbar.
A list appears.
2. From the **Admin** menu, select **M** and then click **Membership Identifier Type**.
A sub-menu appears.
3. Click the **Search** option from the **Membership Identifier Type** sub-menu.
The **Membership Identifier Type** screen appears.
4. In the **Membership Identifier Type List** zone, click the **Edit** (✎) icon in the **Edit** column corresponding to the membership identifier type whose details you want to edit.

The **Membership Identifier Type** screen appears. It contains the following sections:

- **Main** - Used to specify the basic details of the membership identifier type. It contains the following fields:

Field Name	Field Description	Mandatory (Yes or No)
Membership Identifier Type	Displays the membership identifier type.	Not applicable
Description	Used to specify the description for the membership identifier type.	Yes
Validation Algorithm	Used to indicate the algorithm using which you want to validate the value of the membership identifier type. It is triggered when you define an identifier for a membership using the membership identifier type. Note: The Search (🔍) icon appears corresponding to the Validation Algorithm field. On clicking the Search icon, the Algorithm Search window appears.	No
Detailed Description	Used to specify additional information about the membership identifier type.	No

Tip: Alternatively, you can edit the details of a membership identifier type by clicking the **Edit** button in the **Membership Identifier Type** zone.

5. Modify the required details in the **Main** section.
6. Click **Save**.
The changes made to the membership identifier type are saved.

Related Topics

For more information on...	See...
Membership Identifier Type screen	Membership Identifier Type on page 92
Membership Identifier Type List zone	Membership Identifier Type List on page 92
Membership Identifier Type zone	Membership Identifier Type on page 93

Copying a Membership Identifier Type

Prerequisites

To copy a membership identifier type, you should have:

- Validation algorithm defined in the application (in case you want to use it)

Note: No validation algorithm type for membership identifier type is shipped with the product. However, the **Membership Identifier Type - Validation** algorithm entity is available in the application. You can create the required custom validation algorithms for the **Membership Identifier Type - Validation** algorithm entity.

Procedure

To copy a membership identifier type:

1. Click the **Admin** link in the **Application** toolbar.
A list appears.
2. From the **Admin** menu, select **M** and then click **Membership Identifier Type**.
A sub-menu appears.
3. Click the **Search** option from the **Membership Identifier Type** sub-menu.
The **Membership Identifier Type** screen appears.
4. In the **Membership Identifier Type List** zone, click the **Duplicate**  icon in the **Duplicate** column corresponding to the membership identifier type whose copy you want to create.

The **Membership Identifier Type** screen appears. It contains the following section:

- **Main** - Used to specify the basic details of the membership identifier type. It contains the following fields:

Field Name	Field Description	Mandatory (Yes or No)
Membership Identifier Type	Used to specify the membership identifier type.	Yes
Description	Used to specify the description for the membership identifier type.	Yes
Validation Algorithm	Used to indicate the algorithm using which you want to validate the value of the membership identifier type. It is triggered when you define an identifier for a membership using the membership identifier type.	No
<p>Note: The Search  icon appears corresponding to the Validation Algorithm field. On clicking the Search icon, the Algorithm Search window appears.</p>		

Field Name	Field Description	Mandatory (Yes or No)
Detailed Description	Used to specify additional information about the membership identifier type.	No

Tip: Alternatively, you can copy a membership identifier type by clicking the **Duplicate** button in the **Membership Identifier Type** zone.

5. Enter the required details in the **Main** section.
6. Click **Save**.

The new membership identifier type is defined.

Related Topics

For more information on...	See...
Membership Identifier Type screen	Membership Identifier Type on page 92
Membership Identifier Type List zone	Membership Identifier Type List on page 92
Membership Identifier Type zone	Membership Identifier Type on page 93

Deleting a Membership Identifier Type

Procedure

To delete a membership identifier type:

1. Click the **Admin** link in the **Application** toolbar.
A list appears.
2. From the **Admin** menu, select **M** and then click **Membership Identifier Type**.
A sub-menu appears.
3. Click the **Search** option from the **Membership Identifier Type** sub-menu.
The **Membership Identifier Type** screen appears.
4. In the **Membership Identifier Type List** zone, click the **Delete** (🗑️) icon in the **Delete** column corresponding to the membership identifier type that you want to delete.
A message appears confirming whether you want to delete the membership identifier type.

Note: You can delete a membership identifier type when it is not yet used in the system.

Tip: Alternatively, you can delete a membership identifier type by clicking the **Delete** button in the **Membership Identifier Type** zone.

5. Click **OK**.
The membership identifier type is deleted.

Related Topics

For more information on...	See...
Membership Identifier Type screen	Membership Identifier Type on page 92
Membership Identifier Type List zone	Membership Identifier Type List on page 92

For more information on...	See...
Membership Identifier Type zone	Membership Identifier Type on page 93

Viewing the Membership Identifier Type Details

Procedure

To view the details of a membership identifier type:

1. Click the **Admin** link in the **Application** toolbar.
A list appears.
2. From the **Admin** menu, select **M** and then click **Membership Identifier Type**.
A sub-menu appears.
3. Click the **Search** option from the **Membership Identifier Type** sub-menu.
The **Membership Identifier Type** screen appears.
4. In the **Membership Identifier Type List** zone, click the **Broadcast** () icon corresponding to the membership identifier type whose details you want to view.
The **Membership Identifier Type** zone appears.
5. View the details of the membership identifier type in the **Membership Identifier Type** zone.

Related Topics

For more information on...	See...
Membership Identifier Type screen	Membership Identifier Type on page 92
Membership Identifier Type List zone	Membership Identifier Type List on page 92
Membership Identifier Type zone	Membership Identifier Type on page 93

Pricing Parameters

Oracle Revenue Management and Billing enables you to create new set of pricing parameters, such as, Geographic Rating Area, Member Relationship, and Subscription Tier for a fully-insured group customer.

To create a geographic rating area pricing parameter the ORMB system uses the policy plan and geographical details (of a member person) to retrieve the appropriate rating area. This rating area is further used to obtain the rate information defined on the pricing rule that is eventually based on a particular geographical rating area. To create a member relationship pricing parameter, the ORMB system retrieves the appropriate member relationship through the post processing algorithm and stamps the retrieved member relationship on the member person belonging to a particular membership. However, to create a subscription tier pricing parameter, the ORMB system retrieves the subscription tier information through the post processing algorithm and stamps the tier information on the desired membership.

For more information on how to setup the **Pricing Parameters** feature, see [Prerequisites](#)

Related Topics

For more information on...	See...
Geographic Rating Area	Geographic Rating Area on page 100
Member Relationship Pricing Parameter	Member Relationship Pricing Parameter on page 114

For more information on...	See...
Subscription Tier Pricing Parameter	Subscription Tier Pricing Parameter on page 129

Geographic Rating Area

Oracle Revenue Management and Billing enables you to use the geographic rating area as a pricing parameter while defining the age based, tier based, and additional charge pricing rules. This feature facilitates you to offer different rates for a price item based on different geographic rating area.

The system enables you to add and edit a geographic rating area from the user interface. You can also add or edit a set of geographic rating areas at once using the **File Upload Interface** utility. However, note that while editing a geographic rating area, you can only change the end date to a far future date and the status from **Active** to **Inactive**.

While maintaining a geographic rating area in the system, you can also list the policy plans available in the geographic rating area. You can add the policy plan information for a geographic rating area from the user interface or through the **File Upload Interface** utility. But, you cannot edit the policy plan information of a geographic rating area through the **File Upload Interface** utility.

You can upload the geographic rating areas from the CSV file using the **C1GEORATINGARCSVUPLD** file request type through the **File Transformation and Upload (C1-FTRAN)** batch.

Note: You need to set the **Include Plan Or Product Details** parameter in the **C1-GEORAVALD** algorithm to Y or N. If the value for this parameter is set to Y, the system identifies the record using the State, Zip From, Zip Plus4 From, Zip To, Zip Plus4 To, Start Date, Policy Number, Plan Number, and Source System combination. However, if the value for this parameter is set to N, the system identifies the record using the State, Zip From, Zip Plus4 From, Zip To, Zip Plus4 To, and Start Date combination.

Once you define a geographic rating area, the system can derive the geographic rating area for a membership using the **Address Source** and **Address Type** characteristic types. The system supports two address sources named **Policy Holder** and **Main Subscriber** and three address types named **Person Mailing**, **Person Seasonal**, and **Account Override**.

On adding a membership to a policy plan, the system first derives the characteristic types from the **Address Source Characteristic Type** and **Address Type Characteristic Type** attributes of a geographic rating area preference. The system considers the geographic rating area preference which is specified in the **Rating Area Field Mapping for Group** option type of the **C1-ASOBLNG** feature configuration. Then, the system searches for these characteristics on the following entities in the specified sequence:

1. Policy Plan
2. State where the Policy Plan is Issued
3. Policy
4. State where the Policy is Issued

If these characteristics are not defined for any of the above listed entities, the system derives the default address source and address type from the geographic rating area preference.

Note: By default, the **Address Source (C1-ADSRC)** and **Address Type (C1-ADTYP)** characteristic types are shipped with the product. You need to set these characteristic types in the respective attribute of the geographic rating area preference.

If the address source is set to **Policy Holder**, the system fetches the value from the **Parent Customer Policy Person Role** option type of the **C1-ASOBLNG** feature configuration. The system then derives the person who is associated with the policy using the parent customer policy person role. Once the address source and address type are derived, the system fetches the state and zip code from the address type of the address source. For example, if the address source is set to **Policy Holder** and address type is set to **Person Mailing**, the system fetches the state and zip code from the policy holder's mailing address. Once the state and zip code are fetched from the address, the system checks whether the zip code is a 9-digit code. If not, the system appends zeros to make it a 9-digit zip code. The system then derives the value of the **Use Plan Details** attribute from the geographic rating area preference. If the attribute is set to

Y, the system then derives a geographic rating area for the state, zip code, policy number, plan number, and source system combination. However, if the attribute is set to **N**, the system then derives a geographic rating area for the state and zip code combination. If the system could not derive the geographic rating area, the system derives the default geographic rating area from the geographic rating area preference. Once the geographic rating area is derived, the system stores the geographic rating area for the membership. The characteristic type specified in the **Geographic Rating Area Characteristic Type** attribute of the geographic rating area preference is used to store geographic rating area for the membership. The effective date of the characteristic is set to effective date of the address.

The geographic rating area of the membership must be changed when the address of the policy holder or main subscriber is updated. Therefore, when an address of a person is change, the system identifies the following:

- Memberships of policies where the person is the policy holder
- Memberships where the person is the main customer

For each membership, the system searches for the **Address Source** and **Address Type** characteristics on the following entities in the specified sequence:

1. Policy Plan
2. State where the Policy Plan is Issued
3. Policy
4. State where the Policy is Issued

If these characteristics are not defined for any of the above listed entities, the system derives the default address source and address type from the geographic rating area preference. If the address source is set to **Policy Holder**, the system fetches the value from the **Parent Customer Policy Person Role** option type of the **C1-ASOBLNG** feature configuration. The system then derives the person who is associated with the policy using the parent customer policy person role.

Once the address source and address type are derived, the system fetches the state and zip code from the address type of the address source. The system then derives a geographic rating area for the state, zip code, policy number, plan number, and source system combination or for the state and zip code combination depending on the value defined for the **Use Plan Details** attribute. If the system could not derive the geographic rating area, the system derives the default geographic rating area from the geographic rating area preference. If the geographic rating area is different, the system creates a new characteristic to store the geographic rating area for the membership. The effective date of the characteristic is set to effective date of the address.

To use the geographic rating area as a pricing parameter, you need to define the Geographic Rating Area parameter where:

- **Value Type** is to **Adhoc**
- **Source Entity** is set to **Membership**
- **Source Type** is set to **Characteristic**
- **Source Type Code** is set to a characteristic type which is specified in the **Geographic Rating Area Characteristic Type** attribute of the geographic rating area preference
- **Parameter Usage** is set to **Price Item** and **Pricing Eligibility Criteria**

Once the Geographic Rating Area parameter is defined, you need to associate the parameter with the price items for which you want to define different rates in a pricing rule using the parameter. This helps to define different base fee for a price item based on geographic rating area to which the membership belongs.

A new screen named **Geographic Rating Area** is introduced in this release. It enables you to add, edit, and inactivate a geographic rating area.

Prerequisites

To create a geographic rating area pricing parameter, you need to do the following:

- Ensure that the upstream system contains the geographic rating area details in **CSV** file.
- Ensure that the **CSV** file is available at the desired path on the server, before the file upload batch is triggered.

- Set the **C1-GeoRatingArea** business object validation soft parameter (**Include Plan Value Details**) to either include or exclude plan details (Y/N) before the file is uploaded.
- Include the **C1GEORATINGARCSVUPLD** file request type for file upload purposes.
- Ensure that **C1_GEO_RATING_AREA** and **C1_GEO_RATING_AREA_REL_OBJ** tables are populated before any memberships are created in the system for derivation purposes.
- Configure the pricing parameter with the geographic rating area on the pricing rule.
- Define the required **Address Source (C1-ADSRC)** and **Address Type (C1-ADTYP)** characteristic types in the system. Values for these characteristics can be defined either on the policy or plan characteristics level. The address source and address type can also be defined on the state of issue of the policy or plan.
- Define the parent policy role in the **C1-ASOBLLNG** feature configuration.
- Define the following billing preferences in the **Field Mapping** screen:
 - Default Address Source
 - Default Address Type
 - Use Plan Details
 - Address Source Value for Policy Holder
 - Address Source Value for Main Subscriber
 - Geographic Rating Area Characteristic Type
 - Address Source Characteristic Type
 - Address Type Characteristic Type
- Define the default value for **Geographic Rating Area Characteristic Type** in the **Field Mapping** screen.
- Define the required health plan in the system.

Related Topics

For more information on...	See...
Uploading a Geographic Rating Area File in the CSV Format	Uploading a Geographic Rating Area File in the CSV Format on page 102
CSV File Format for Uploading Geographic Rating Areas	CSV File Format for Uploading Geographic Rating Areas on page 103
Sample CSV Format for Uploading Geographic Rating Areas	Sample CSV Format for Uploading Geographic Rating Areas on page 104

Uploading a Geographic Rating Area File in the CSV Format

To upload a geographic rating area file in the CSV format using the **File Upload Interface** utility, you need to do the following:

- Define a file request type for uploading geographic rating area in the CSV format. To define a file request type:
 1. Click the **Admin** link in the **Application** toolbar.
A list appears.
 2. From the **Admin** menu, select **F** and then click **File Request Type**.
A sub-menu appears.
 3. Click the **Add** option from the **File Request Type** sub-menu.

The **File Request Type** screen appears.

4. Enter the file request type and description in the respective fields.
5. Select the **Data Transformation Required** option.
The **File Format** field is enabled.
6. Select the **Comma Separated Values** option from the **File Format** list.
7. Select the Upload and Process File Simultaneously option.
8. Attach an algorithm created using the **C1-FRTA** algorithm type to the **Data Transformation Algorithm** field.
9. In the **Services** section, enter the required sequence number.
10. Select the **Business Object** option from the **Service Type** list.
11. Enter the **C1-GeoRatingArea** business object or custom price item business object in the **Service Name** field.
12. Select the **Add** or **Update** option from the **Operation** list depending on whether you want to create new geographic rating area details or edit the existing geographic rating area details using the file request type.
13. In the **Field Transformation** section, specify the following details:

Field Name	Field Description	Mandatory (Yes or No)
Sequence	Used to indicate the data field in the CSV record which you want to upload in the system.	Yes
Field Name	Used to indicate the field for which the data is uploaded in the system.	Yes
Map Field XPath	Used to specify the XPath of the field where you want to store the data field from the CSV record.	Yes
Default Value	Used to specify the default value for the field.	No

14. Click **Save**.

The file request type is defined for uploading the geographic rating area in the CSV format.

Related Topics

For more information on...	See...
CSV File Format for Uploading Geographic Rating Areas	CSV File Format for Uploading Geographic Rating Areas on page 103
Sample CSV Format for Uploading Geographic Rating Areas	Sample CSV Format for Uploading Geographic Rating Areas on page 104

CSV File Format for Uploading Geographic Rating Areas

Before uploading a geographic rating area file through the **File Upload Interface** utility, you need to ensure that the CSV file contains the following data:

Data	Description	Mandatory (Yes or No)
GEO_RATING_AREA	Used to specify the geographic rating area.	Yes
STATE	Used to specify the state code which belongs to the geographical rating area.	Yes
ZIP_FROM	Used to specify the zip code from where the geographic rating area begins.	Yes
ZIP_PLUS4_FROM	Used to specify the additional four digits after the zip code from where the geographic rating area begins.	Yes
ZIP_TO	Used to specify the zip code till where the geographic rating area ends.	Yes
ZIP_PLUS4_TO	Used to specify the additional four digits after the zip code till where the geographic rating area ends.	Yes
START_DT	Used to specify the date from when the geographic rating area is effective.	Yes
END_DT	Used to specify the date till when the geographic rating area is effective.	Yes
PLAN_NBR	Used to specify the plan number belonging to a particular geographical rating area.	No
HEALTH_PLAN_CD	Used to specify the health plan belonging to a particular geographical rating area.	No
POLICY_NBR	Used to specify the policy number belonging to a particular geographical rating area.	No
SOURCE_SYSTEM	Used to specify the source system from where the policy is originated.	No
STATUS	Used to indicate the status for the geographic rating area. The valid values are: <ul style="list-style-type: none"> • Active • Inactive 	Yes

Related Topics

For more information on...	See...
Uploading a Geographic Rating Area File in the CSV Format	Uploading a Geographic Rating Area File in the CSV Format on page 102
Sample CSV Format for Uploading Geographical Rating Area	Sample CSV Format for Uploading Geographic Rating Areas on page 104

Sample CSV Format for Uploading Geographic Rating Areas

The CSV format must contain the following field transformation details that are used for uploading the geographic rating area information in the system:

Sequence	Field Name	Map Field XPath
1	GEO_RATING_AREA	C1-GeoRatingArea/geoRatingArea
2	STATE	C1-GeoRatingArea/state
3	ZIP_FROM	C1-GeoRatingArea/zipFrom
4	ZIP_PLUS4_FROM	C1-GeoRatingArea/zipPlus4From
5	ZIP_TO	C1-GeoRatingArea/zipTo
6	ZIP_PLUS4_TO	C1-GeoRatingArea/zipPlus4To
7	START_DT	C1-GeoRatingArea/startDate
8	END_DT	C1-GeoRatingArea/endDate
9	PLAN_NBR	C1-GeoRatingArea/0/geoRatingAreaRelatedObject/ planNumber
10	HEALTH_PLAN_CD	C1-GeoRatingArea/0/geoRatingAreaRelatedObject/ healthPlanCode
11	POLICY_NBR	C1-GeoRatingArea/0/geoRatingAreaRelatedObject/ policyNumber
12	SOURCE_SYSTEM_CD	C1-GeoRatingArea/0/geoRatingAreaRelatedObject/ sourceSystem
13	STATUS	C1-GeoRatingArea/boStatus

Sample CSV

```
100,AR,15000,0,15000,10,02/02/2019,02/02/2030,45675767565,MED_PLN_01,7.87E+11,SOURCE,ACTIVE
```

Related Topics

For more information on...	See...
Uploading a Geographic Rating Area File in the CSV Format	Uploading a Geographic Rating Area File in the CSV Format on page 102
CSV File Format for Uploading Geographic Rating Areas	CSV File Format for Uploading Geographic Rating Areas on page 103

Geographic Rating Area (Used for Searching)

The **Geographic Rating Area** screen allows you to search for a geographic rating area using various search criteria. It also allows you to create a geographic rating area. This screen consists of the following zone:

- [Search Geographic Rating Area](#) on page 105

Search Geographic Rating Area

The **Search Geographic Rating Area** zone allows you to search for geographic rating area using various search criteria. This zone contains the following two sections:

- **Search Criteria** - The **Search Criteria** section contains the following fields:

Field Name	Field Description	Mandatory (Yes or No)
Search By	Used to indicate whether you want to search for a geographic rating area detail record using the geographic rating area details or through policy or plan details. The valid values are: <ul style="list-style-type: none"> • Geographic Rating Area Details • Policy or Plan Details • Health Plan Details 	No
	Note: By default, the Geographic Rating Area Details option is selected.	
State Code	Used to search the geographic rating area details belonging to a particular state code.	No
	Note: You must specify a state code which is already defined in the system.	
Geographic Rating Area	Used to search the geographic rating area details based on a geographic rating area.	No
Zip Code From	Used to search the geographic rating area details which are effective from a particular zip code.	No
Zip Code To	Used to search the geographic rating area details which are effective till a particular zip code.	No
Start Date	Used to search the geographic rating area details which are effective from a particular date.	No
	Note: The geographic rating area start date cannot be later than the geographic rating area end date.	
End Date	Used to search the geographic rating area details which are effective till a particular date.	No
	Note: The geographic rating area end date cannot be earlier than the geographic rating area start date	
Status	Used to search the geographic rating area details based on a particular status. The valid values are: <ul style="list-style-type: none"> • Active • Inactive 	No
Policy Number	Used to search the geographic rating area details with a particular policy number.	No
Plan Number	Used to search the geographic rating area details with a particular plan number.	No

Field Name	Field Description	Mandatory (Yes or No)
Health Plan	Used to search the geographic rating area details which are associated with a health plan. Note: The Search (🔍) icon appears corresponding to this field. On clicking the Search icon, the Health Plan Search window appears. This field appears when the Health Plan Details option is selected from the Search By list.	No

- **Search Results** - On clicking the **Search** button, the search results appear based on the specified search criteria. The **Search Results** section contains the following columns:

Column Name	Column Description
Geographic Rating Area	Displays the geographic rating area.
State Code	Displays the state code to which the geographic rating area belongs.
Zip Code From	Displays the zip code from where the geographic rating area is effective.
Zip Code Plus 4 From	Displays the zip code plus four additional digits which identify from where the geographic rating area is effective.
Zip Code To	Displays the zip code till where the geographic rating area is effective.
Zip Code Plus 4 To	Displays the zip code plus four additional digits which identify till where the geographic rating area is effective.
Start Date	Displays the date from when the geographic rating area is effective.
End Date	Displays the date till when the geographic rating area is effective.
Status	Indicates the status of the geographic rating area. The valid values are: <ul style="list-style-type: none"> • Active • Inactive

<p>Note:</p> <p>Pagination is used to display limited number of records in the Search Results section. You can use the navigation links, such as Previous and Next to navigate between pages.</p> <p>You can filter the list using various search criteria (such as, State Code, Geographic Rating Area, Zip Code From, Zip Code To, Start Date, End Date, and Status) available in the Filter area. By default, the Filter area is hidden. You can view the Filter area by clicking the Filters (🔽) icon in the upper right corner of this zone.</p>
--

Related Topics

For more information on...	See...
How to search for a geographic rating area	Searching for a Geographic Rating Area on page 109

For more information on...	See...
How to view the details of a geographic rating area	Viewing the Geographic Rating Area Details on page 114
How to define a geographic rating area	Defining a Geographic Rating Area on page 110

Geographic Rating Area

The **Geographic Rating Area** zone displays the details of the geographic rating area. It contains the following sections:

- **Main** - Displays basic information about the geographic rating area. It contains the following fields:

Field Name	Field Description
Geographic Rating Area	Displays information about the geographic rating area.
State Code	Displays the state code to which the geographic rating area belongs.
Zip Code From	Displays the zip code from where the geographic rating area is effective.
Zip Code Plus 4 From	Displays the zip code plus four additional digits which identify from where the geographic rating area is effective.
Zip Code To	Displays the zip code till where the geographic rating area is effective.
Zip Code Plus 4 To	Displays the zip code plus four additional digits which identify till where the geographic rating area is effective.
Start Date	Displays the date from when the geographic rating area is effective.
End Date	Displays the date till when the geographic rating area is effective.
Status	Displays the status of the geographic rating area. The valid values are: <ul style="list-style-type: none"> • Active • Inactive

- **Plan Details** - Lists the plan information of the geographic rating area. It contains the following columns:

Column Name	Column Description
Policy Number	Displays the policy number which is associated with the geographic rating area.
Plan Number	Displays the plan number of the policy.
Health Plan	Indicates the health plan to which the geographic rating area is associated. Note: The data in this column appears only when the geographic rating area is specified for fully-insured individual.
Source System	Displays the name of the external system from where the policy is originated.

- **Record Actions** - This section contains the following buttons:

Button Name	Button Description
Edit	Used to edit the details of the geographic rating area. Note: The Edit button appears when the geographic rating area is in the Active status.

Button Name	Button Description
Inactive	Used to change the status of the geographic rating area.
	Note: The Inactive button appears when the geographic rating area is in the Active status.

- **Record Information** - This section contains the following fields:

Field Name	Field Description
Business Object	Indicates the business object using which the geographic rating area is created. In addition, a context menu appears corresponding to this field which helps in navigating to other screens in the application.
	Note: It has a link. On clicking the link, the Business Object screen appears where you can view the details of the respective business object.
Status Date/Time	Displays the date and time when the geographic rating area status is updated.
Creation Date/Time	Displays the date and time when the geographic rating area is created.

Related Topics

For more information on...	See...
How to edit a geographic rating area	Editing a Geographic Rating Area on page 112
How to inactivate a geographic rating area	Inactivating a Geographic Rating Area on page 114

Searching for a Geographic Rating Area

Prerequisites

To search for a geographic rating area, you should have:

- Geographic rating area defined in the application.
- Policy and plan defined in the application.

Procedure

To search for a geographic rating area:

1. Click the **Admin** link in the **Application** toolbar.
A list appears.
2. From the **Admin** menu, select **G** and then click **Geographic Rating Area**.
The **Geographic Rating Area** screen appears.
3. Enter the search criteria in the **Search Geographic Rating Area** zone.

Note: ORMB search engine supports wildcard search, where you can substitute the percentage (%) symbol as a stand in for any word or letter in a search criteria. You can use the ‘%’ wildcard character in all input fields except the date and ID fields. The ‘%’ wildcard character is suffixed automatically at the end of the partial search criteria. Therefore, you may or may not specify the wildcard character at the end of the partial search criteria. However, you have to prefix the wildcard character manually wherever required.

4. Click **Search**.

A list of geographic rating area that meet the search criteria appears in the **Search Results** section.

Related Topics

For more information on...	See...
Geographic Rating Area screen	Geographic Rating Area (Used for Searching) on page 105
Geographic Rating Area zone	Geographic Rating Area on page 108

Defining a Geographic Rating Area

Procedure

To define a geographic rating area

1. Click the **Admin** link in the **Application** toolbar.

A list appears.

2. From the **Admin** menu, select **G** and then click **Geographic Rating Area**.

The **Geographic Rating Area** screen appears.

3. Click the **Add** button in the **Page Title** area of the **Geographic Rating Area** screen.

The **Geographic Rating Area** screen appears. It contains the following sections:

- **Main** - Used to specify basic details about the geographic rating area.
- **Plan Details** - Used to specify the plan details for the geographic rating area.

The **Main** section contains the following fields:

Field Name	Field Description	Mandatory (Yes or No)
Geographic Rating Area	Used to specify the geographic rating area.	Yes
State Code	Used to specify the state code which belongs to the geographical rating area. Note: You must specify a state code which is already defined in the system.	Yes
Zip Code From	Used to specify the zip code from where the geographic rating area begins.	Yes
Zip Code Plus 4 From	Used to specify the additional four digits after the zip code from where the geographic rating area begins.	Yes
Zip Code To	Used to specify the zip code till where the geographic rating area ends.	Yes
Zip Code Plus 4 To	Used to specify the additional four digits after the zip code till where the geographic rating area ends.	Yes
Start Date	Used to specify the date from when the geographic rating area is effective. Note: The geographic rating area start date cannot be later than the geographic rating area end date.	Yes

Field Name	Field Description	Mandatory (Yes or No)
End Date	Used to specify the date till when the geographic rating area is effective.	No
	Note: The geographic rating area end date cannot be earlier than the geographic rating area start date	
Status	Used to indicate the status for the geographic rating area. The valid values are: <ul style="list-style-type: none"> • Active • Inactive 	Yes
	Note: You cannot assign an Inactive status to the geographic rating area record while you are defining a geographic rating area.	

4. Enter the required details in the **Main** section.
5. Add the plan details for the geographic rating area, if required.
6. Click **Save**.

The geographic rating area is defined in the **Active** status.

Related Topics

For more information on...	See...
Geographic Rating Area screen	Geographic Rating Area (Used for Searching) on page 105
How to add the plan details for a geographic rating area	Adding the Plan Details for a Geographic Rating Area on page 111

Adding the Plan Details for a Geographic Rating Area

Prerequisites

To add plan details for a geographic rating area, you should have:

- Policy and plan defined in the application.
- Source system defined in the application.
- Health plan defined in the application.

Procedure

To add plan details for a geographic rating area:

1. Ensure that the **Plan Details** section is expanded when you are defining or editing the geographic rating area information.

Note: If you want to use the geographic rating area for a fully-insured group, you need to specify policy number, plan number, and source system fields. You can specify the health plan only when you want to use the geographic rating area for a fully-insured individual membership.

The **Plan Details** section contains the following fields in a grid:

Field Name	Field Description	Mandatory (Yes or No)
Policy Number	Used to specify the policy number which is associated with the geographic rating area.	No
Plan Number	Used to specify the plan number of the policy.	No
Health Plan	Used to specify the health plan which is associated with the geographic rating area.	No
	Note: You need to specify the health plan, if you want to use the geographic rating area for a fully-insured individual membership.	
Source System	Used to specify the name of the external system from where the policy is originated.	No

- Enter the required details in the **Plan Details** section.
- If you want to define more than one plan information for the geographic rating area, click the **Add (+)** icon and then repeat step 2.

Note: However, if you want to remove a plan information from the geographic rating area, click the **Delete** (🗑️) icon corresponding to the policy number column.

Related Topics

For more information on...	See...
How to edit a geographic rating area	Editing a Geographic Rating Area on page 112

Editing a Geographic Rating Area

Procedure

To edit a geographic rating area

- Search for the geographic rating area in the **Geographic Rating Area** screen.
- In the **Search Results** section, click the **Broadcast** (📡) icon corresponding to the geographic rating area column whose details you want to view.

The **Geographic Rating Area** zone appears.

- Click the **Edit** button in the **Geographic Rating Area** screen.

The **Geographic Rating Area** screen appears. It contains the following sections:

- Main** - Used to specify basic details about the geographic rating area.
- Plan Details** - Used to specify the plan details for the geographic rating area.

The **Main** section contains the following fields:

Field Name	Field Description	Mandatory (Yes or No)
Geographic Rating Area	Used to specify the geographic rating area.	Yes

Field Name	Field Description	Mandatory (Yes or No)
State Code	Used to specify the state code which belongs to the geographical rating area.	Yes
	Note: You must specify a state code which is already defined in the system.	
Zip Code From	Used to specify the zip code from where the geographic rating area begins.	Yes
Zip Code Plus 4 From	Used to specify the additional four digits after the zip code from where the geographic rating area begins.	Yes
Zip Code To	Used to specify the zip code till where the geographic rating area ends.	Yes
Zip Code Plus 4 To	Used to specify the additional four digits after the zip code till where the geographic rating area ends.	Yes
Start Date	Used to specify the date from when the geographic rating area is effective.	Yes
	Note: The geographic rating area start date cannot be later than the geographic rating area end date.	
End Date	Used to specify the date till when the geographic rating area is effective.	No
	Note: The geographic rating area end date cannot be earlier than the geographic rating area start date	
Status	Used to indicate the status for the geographic rating area. The valid values are: <ul style="list-style-type: none"> • Active • Inactive 	Yes
	Note: You cannot assign an Inactive status to the geographic rating area record while you are defining a geographic rating area.	

4. Modify the geographic rating area details, if required.
5. Define, edit, or remove plan details for the geographic rating area, if required.
6. Click **Save**.

The changes made to the geographic rating area are saved.

Related Topics

For more information on...	See...
How to search for a geographic rating area	Searching for a Geographic Rating Area on page 109
Geographic Rating Area screen	Geographic Rating Area (Used for Searching) on page 105
How to add the plan details for a geographic rating area	Adding the Plan Details for a Geographic Rating Area on page 111

Inactivating a Geographic Rating Area

Procedure

To inactivate a geographic rating area:

1. Search for the geographic rating area in the **Geographic Rating Area** screen.
2. In the **Search Results** section, click the **Broadcast** () icon corresponding to the geographic rating area column whose details you want to view.
The **Geographic Rating Area** zone appears.
3. Click the **Inactive** button in the **Geographic Rating Area** zone.
The status of the geographic rating area is changed to **Inactive**.

Note: The **Inactive** button appears when the geographic rating area is in the **Active** status.

Related Topics

For more information on...	See...
How to search for the geographic rating area	Searching for a Geographic Rating Area on page 109
Geographic Rating Area screen	Geographic Rating Area (Used for Searching) on page 105
Geographic Rating Area zone	Geographic Rating Area on page 108

Viewing the Geographic Rating Area Details

Procedure

To view the details of the geographic rating area:

1. Search for the geographic rating area in the **Geographic Rating Area** screen.
2. In the **Search Results** section, click the **Broadcast** () icon corresponding to the geographic rating area column whose details you want to view.
The **Geographic Rating Area** zone appears.
3. View the details of the geographic rating area in the **Geographic Rating Area** zone.

Related Topics

For more information on...	See...
How to search for the geographic rating area	Searching for a Geographic Rating Area on page 109
Geographic Rating Area screen	Geographic Rating Area (Used for Searching) on page 105
Geographic Rating Area zone	Geographic Rating Area on page 108

Member Relationship Pricing Parameter

Oracle Revenue Management and Billing enables you to use the member relationship (i.e. how a member is related to the main subscriber of the membership) as a pricing parameter while defining the age based, tier based, and additional charge pricing rules. This feature facilitates you to offer different rates for a price item based on different member relationship.

While adding a membership to a policy plan or while adding or inactivating a member person in a membership, the system automatically derives member relationship for each member person of the membership from a member relationship structure. You can define a member relationship structure through a characteristic on the policy plan. While

defining a member relationship structure for a policy plan, you must use the characteristic type specified in the **Member Relationship Structure Characteristic Type** attribute of a member relationship and subscription tier preference. The system considers the member relationship and subscription tier preference which is specified in the **Relation Structure Code Field Mapping** option type of the **C1-ASOBLNG** feature configuration.

The system enables you to define two types of member relationship structure:

- **Step Member Relationship Structure** - A step member relationship structure helps the system to determine how each member person is related to the main subscriber of the membership. You can specify a list of member relationships in a step member relationship structure. A member relationship is derived for a member person depending on the following:
 - Whether the member person is a self, spouse, or dependent
 - Number of spouses, dependents, and young adults in the membership

A relationship matrix indicates whether a member person with a particular relationship type should be considered as self, spouse, or dependent while deriving the member relationship. In a step member relationship structure, a spouse is never considered as a dependent. Only children are considered as dependents.

For example, you can create a step member relationship structure named STEPEX1 as shown below:

Member Relationship	Self	Number of Spouses	Number of Dependents	Number of Young Adults
Self	1	0	0	0
Spouse 1	1	1	0	0
Spouse 2	1	2	0	0
Child 1	1	1	1	0
Young Adult 1	1	1	0	1
CD1 and YA1	1	1	1	1
Child 2	1	1	2	0
Young Adult 2	1	1	0	2
CD2 and YA2	1	1	2	2
Additional Dependent	1	3	3	3

Note: You can only define one member relationship in a step member relationship structure where the sum of self, number of spouses, number of dependents, and number of young adults exceeds the maximum member count specified in the step member relationship structure.

In addition, you can create a relationship matrix in the STEPEX1 member relationship structure as shown below:

Relation	Relationship Type	Relationship
Main Subscriber	Owner	Self
Main Subscriber	Member	Self
Children	Child	Dependent
Spouse	Wife	Spouse
Spouse	Spouse	Spouse

- **Party Member Relationship Structure** - A party member relationship structure helps the system to determine how each member person is related to the main subscriber of the membership. You can specify a list of member relationships in a party member relationship structure. A member relationship is derived for a member person depending on the following:
 - Whether the member person is a self or dependent
 - Number of dependents in the membership

A relationship matrix indicates whether a member person with a particular relationship type should be considered as self or dependent while deriving the member relationship. In a party member relationship structure, a spouse is always considered as a dependent. Also, children are not categorized as young adults.

For example, you can create a party member relationship structure named PARTYEX1 as shown below:

Member Relationship	Self	Number of Spouses	Number of Dependents	Number of Young Adults
Self	1	0	0	0
Dependent 1	1	0	1	0
Dependent 2	1	0	2	0
Dependent 3	1	0	3	0
Additional Dependents	1	0	9	0

Note: You can only define one member relationship in a party member relationship structure where the sum of self and number of dependents exceeds the maximum member count specified in the party member relationship structure.

In addition, you can create a relationship matrix in the PARTYEX1 member relationship structure as shown below:

Relation	Relationship Type	Relationship
Main Subscriber	Owner	Self
Main Subscriber	Member	Self
Children	Child	Dependent
Spouse	Wife	Dependent
Spouse	Spouse	Dependent

Once the member relationship structure is derived from the policy plan, the system determines the member relationship for each member person in the membership. While determining the member relationship for a member person, the system derives the following characteristic types from the respective attributes of the member relationship and subscription tier preference:

- Age Calculation Date Basis
- Max Age Limit for Max Dependent Count
- Max Number of Dependents Order Priority
- Maximum Number of Dependents
- Member Relationship Derivation Date
- New Born Gift Days
- New Born Gift Days Applicability

- Young Adult Max Age Limit
- Young Adult Max Age Limit Applicability

The system then derives these characteristics from the policy plan. If the **Member Relationship Derivation Date** characteristic type is set to **Enrollment Date**, the system derives the member relationship for each member person of the membership in order of the member start date. However, if the Member Relationship Derivation Date characteristic type is set to Date of Birth, the system derives the member relationship for each member person of the membership in order of the date of birth. For example, if a membership with the following member persons is added to a policy plan:

Member Start Date	Member End Date	Person Name	Main Subscriber	Relationship Type	Member	Date of Birth
1-Jan-18	31-Dec-20	Mark	Yes	Self	Yes	15-Jan-68
1-Jan-18	31-Dec-20	Nancy	No	Wife	Yes	20-Apr-72
1-Jan-18	31-Dec-20	Roger	No	Child	Yes	15-May-01
1-Jan-18	31-Dec-20	Tom	No	Child	Yes	16-May-04

Now, if the following characteristics are defined on the policy plan:

- Member Relationship Structure - STEPEX1
- Member Relationship Derivation Date – Date of Birth
- Age Calculation Date Basis – Enrollment Date
- Maximum Number of Dependents – 3
- Max Number of Dependents Order Priority - YOUNGEST

The system will consider the STEPEX1 member relationship structure and derives the member relationship for each member person as shown below:

Member Person	Effective Date	Characteristic Type	Characteristic Value
Mark	1-Jan-18	Member Relationship	Self
Nancy	1-Jan-18	Member Relationship	Spouse 1
Tom	1-Jan-18	Member Relationship	Child 1
Roger	1-Jan-18	Member Relationship	Child 2

Note that the member relationship of Tom is derived before Roger because he is youngest of all dependents. Now, assume if one more member person named Harry with the date of birth as 05-11-08 and relationship type as Child is added to the membership on 05-Jan-18, then the system derives the member relationship for each member person of the membership as shown below:

Effective Date	Member	Member Characteristics	Person	Value
1-Jan-18	Mark	Member Relationship		Self
1-Jan-18	Nancy	Member Relationship		Spouse 1
5-Jan-18	Harry	Member Relationship		Child 1
5-Jan-18	Tom	Member Relationship		Child 2
5-Jan-18	Roger	Member Relationship		Additional Dependent

The member relationship for Harry, Tom, and Roger is derived in the order of their age which is calculated from the enrollment date. Because the member relationship derived for Tom and Roger is different, the system creates a new characteristic to store the member relationship for Tom and Roger. Here, the effective date of the characteristics is set to the new member person's start date.

If a new born is added to the membership, the effective date of the new born's member relationship characteristic is calculated considering the gift days if applicable. If a member person is end dated, the system derives the member relationship of all other member persons once again. If the member relationship for a member person is different, the system creates a new characteristic to store the member relationship for the member person. The effective date of the new characteristic is set to member person's end date + 1. However, if a member person is inactivated, the system derives the member relationship of all other member persons once again. If the member relationship for a member person is different, the system updates the existing member relationship characteristic of the member person.

To use the member relationship as a pricing parameter, you need to define the Member Relationship parameter where:

- **Value Type** is to **Adhoc**
- **Source Entity** is set to **Membership Person**
- **Source Type** is set to **Characteristic**
- **Source Type Code** is set to a characteristic type which is specified in the **Member Relationship Characteristic Type** attribute of the member relationship and subscription tier preference
- **Parameter Usage** is set to **Price Item** and **Pricing Eligibility Criteria**

Once the Member Relationship parameter is defined, you need to associate the parameter with the price items for which you want to define different rates in a pricing rule using the parameter. This helps to define different base fee for a price item based on the member relationship.

A new screen named **Member Relationship/Subscription Tier Structure** is introduced in this release. It enables you to add, edit, copy, and delete the member relationship and subscription tier structures.

Prerequisites

To create a member relationship pricing parameter, you need to do the following:

- Define the pricing parameter with the member relationship.
- The **Admin** user must define different types of member relationship structures for step or party, where all the member relationships must be defined in the **Member Relationship/Subscription Tier Structure** screen. These member relationships must also exist in the **C1-ASOBLLNG** feature configuration.
- Define the required characteristic types, such as, **Member Relationship Structure (C1-MRLST)**, **Member Relationship - Derivation Date Basis (C1-MRDDDB)**, and **Age Calculation Date Basis (C1-AGCAL)** on the policy plan.
- Define the following set of characteristics while adding the characteristics for the policy plan and also when the premium billing preferences are defined:
 - Max Age of Dependent
 - Max Number of Dependents
 - Order Priority
 - Young Adult Max Age Limit
 - Young Adult Inclusion Applicability
- The above characteristic types along with the **Member Relationship (C1-MEMRL)** characteristic type would be stamped on the member person, must be specified in the **Field Mapping** screen.

Related Topics

For more information on...	See...
Uploading a Geographic Rating Area File in the CSV Format	Uploading a Geographic Rating Area File in the CSV Format on page 102
CSV File Format for Uploading Geographic Rating Areas	CSV File Format for Uploading Geographic Rating Areas on page 103
Sample CSV Format for Uploading Geographic Rating Areas	Sample CSV Format for Uploading Geographic Rating Areas on page 104

Member Relationship/Subscription Tier Structure (Used for Searching)



The **Member Relationship/Subscription Tier Structure** screen allows you to search for a member relationship/subscription tier using various search criteria. It also allows you to create a member relationship/subscription tier. Through this screen, you can navigate to the following screen. It contains the following zone:

This screen consists of the following zone:

- [Member Relationship/Subscription Tier Structure List](#) on page 119
- [Member Relationship/Subscription Tier Structure](#) on page 120

Member Relationship/Subscription Tier Structure List

The **Member Relationship/Subscription Tier Structure List** zone displays the member relationship or subscription tier structure information. It contains the following columns:

Column Name	Column Description
Structure	Used to specify the structure code for the structure.
Description	Used to specify the description for the structure.
Edit	On clicking the Edit () icon, the Member Relationship/Subscription Tier Structure screen appears where you can edit the structural details of the member relationship or subscription tier.
Duplicate	On clicking the Duplicate () icon, the Member Relationship/Subscription Tier Structure screen appears where you can define a new member relationship or subscription tier using an existing member relationship or subscription tier.
Delete	On clicking the Delete () icon, you can delete the member relationship or subscription tier structure.

Note:

Pagination is used to display limited number of records in the **Search Results** section. You can use the navigation links, such as **Previous** and **Next** to navigate between pages.

You can filter the list using various search criteria (such as, **Structure** and **Description**) available in the **Filter** area. By default, the **Filter** area is hidden. You can view the **Filter** area by clicking the **Filters** () icon in the upper right corner of this zone.

Related Topics

For more information on...	See...
How to view the details of a member relationship/subscription tier structure	Viewing the Subscription Tier Structure Details on page 143

For more information on...	See...
How to define a member relationship/subscription tier structure	Defining a Subscription Tier Structure on page 136

Member Relationship/Subscription Tier Structure

The **Member Relationship/Subscription Tier Structure** zone displays the details of the member relationship or subscription tier structure. It contains the following sections:

- **Main** - Displays basic information about the member relationship or subscription tier structure. It contains the following fields:

Field Name	Field Description
Structure	Displays the type of structure.
Description	Displays the description of the structure.
Detailed Description	Displays additional information about the structure.
Maximum Member Count	Displays the maximum count of the members allowed in the structure.

- **Member Relationship/Subscription Tier Criteria** - Lists the criteria details of the member relationship or subscription tier. It contains the following columns:

Column Name	Column Description
Member Relationship/Subscription Tier	Displays the criteria code for the member relationship or subscription tier.
Self	Displays the main subscriber who meets the member relationship or subscription tier criteria. Note: The total count in the Self column cannot exceed more than one.
Number of Spouses	Displays the total number of spouses in the membership who meet the member person relationship criteria.
Number of Dependents	Displays the total number of dependents in the membership who meet the member person relationship criteria.
Number of Young Adults	Displays the total number of young adults in the membership who meet the member person relationship criteria.

- **Relationship Matrix** - Lists the relationship matrix details defined for the member relationship or subscription tier structure. It contains the following columns:

Column Name	Column Description
Relation	Indicates an entity defined in the relationship matrix.
Relationship Type	Indicates how a member person is associated with the main subscriber using a relationship type.
Relationship	Indicates how a member person is associated with the relationship type.

- **Record Actions** - This section contains the following buttons:

Button Name	Button Description
Edit	Used to edit the structural details of the member relationship or subscription tier.

Button Name	Button Description
Delete	Used to delete the member relationship or subscription tier structure.
Duplicate	Used to create a new member relationship or subscription tier structure using an existing structure.

- **Record Information** - This section contains the following fields:

Field Name	Field Description
Business Object	Indicates the business object using which the member relationship or subscription tier structure is created. In addition, a context menu appears corresponding to this field which helps in navigating to other screens in the application.
	Note: It has a link. On clicking the link, the Business Object screen appears where you can view the details of the respective business object.

Related Topics

For more information on...	See...
How to edit a member relationship/subscription tier structure	Editing a Subscription Tier Structure on page 138
How to delete a member relationship/subscription tier structure	Deleting a Subscription Tier Structure on page 142
How to copy a member relationship/subscription tier structure	Copying a Subscription Tier Structure on page 140

Defining a Member Relationship Structure

Procedure

To define a member relationship structure:

1. Click the **Admin** link in the **Application** toolbar.
A list appears.
2. From the **Admin** menu, select **M** and then click **Member Relationship/Subscription Tier Structure**.
A sub-menu appears.
3. Click the **Add** option from the **Member Relationship/Subscription Tier Structure** sub-menu.

The **Member Relationship/Subscription Tier Structure** screen appears. It contains the following sections:

- **Main** - Used to specify basic details about the member relationship structure. It contains the following fields:

Field Name	Field Description	Mandatory (Yes or No)
Structure	Used to specify a code name for the structure.	Yes
	Note: You must specify a unique code name for the structure.	
Description	Used to specify the description for the structure.	Yes

Field Name	Field Description	Mandatory (Yes or No)
Detailed Description	Used to specify additional information about the structure.	No
Maximum Member Count	Used to specify the maximum number of members allowed in the structure. Note: If you do not specify the value, by default, it is set to zero (0).	No

- **Member Relationship/Subscription Tier Criteria** - Used to specify the criteria details for the member relationship. It contains the following fields:

Field Name	Field Description	Mandatory (Yes or No)
Member Relationship/Subscription Tier	Used to specify a code name for the criteria. Note: You must specify a unique code name for the member relationship/subscription criteria.	No
Self	Used to specify the main subscriber for the member relationship. Note: The value for this field must be a positive integer.	No
Number of Spouses	Used to specify the total number of spouses in the membership who meet the member relationship criteria. Note: The value for this field must be a positive integer.	No
Number of Dependents	Used to specify the total number of dependents in the membership who meet the member relationship criteria. Note: The value for this field must be a positive integer.	No
Number of Young Adults	Used to specify the total number of young adults in the membership who meet the member relationship criteria. Note: The value for this field must be a positive integer.	No

Note: You must specify at least one criteria for the member relationship structure. However, you can specify only a single member relationship criteria, if the maximum member count is set to zero (0) or one (1).

Relationship Matrix - Used to specify the relationship matrix for the member relationship. It contains the following fields:

Field Name	Field Description	Mandatory (Yes or No)
Relation	Used to indicate an entity in the relationship matrix.	No
Relationship Type	Used to indicate how a member person is associated with the main subscriber using a relationship type.	No
Relationship	Used to indicate how the relation is associated with the relationship type in the relationship matrix	No

Note: You must specify at least one relationship matrix.

Tip: Alternatively, you can access this screen by clicking the **Add** button in the **Page Title** area of the **Member Relationship/Subscription Tier Structure** screen.

- Enter the required details in the **Main** section.
- Define a criteria (for the member relationship structure) in the **Member Relationship/Subscription Tier Criteria** section.
- If you want to define more than one criteria for the member relationship structure, click the **Add (+)** icon and then repeat step 5.

Note: However, if you want to remove a criteria from the member relationship structure, click the **Delete (🗑)** icon corresponding to the **Member Relationship/Subscription Tier** field.

- Define the relationship matrix (for the member relationship structure) in the **Relationship Matrix** section.
- If you want to define more than one relationship matrix for the member relationship structure, click the **Add (+)** icon and then repeat step 7.

Note: However, if you want to remove a relationship matrix from the member relationship structure, click the **Delete (🗑)** icon corresponding to the **Relation** field.

- Click **Save**.

The member relationship structure is defined.

Related Topics

For more information on...	See...
Member Relationship/Subscription Tier Structure screen	Member Relationship/Subscription Tier Structure (Used for Searching) on page 119

Editing a Member Relationship Structure

Procedure

To edit a member relationship structure:

- Click the **Admin** link in the **Application** toolbar.
A list appears.
- From the **Admin** menu, select **M** and then click **Member Relationship/Subscription Tier Structure**.
The **Member Relationship/Subscription Tier Structure** screen appears.
- In the **Member Relationship/Subscription Tier Structure List** zone, click the **Edit (🖋)** icon in the **Edit** column corresponding to the member relationship structure whose details you want to edit.

The **Member Relationship/Subscription Tier Structure** screen appears. It contains the following sections:

- **Main** - Used to specify basic details about the member relationship structure. It contains the following fields:

Field Name	Field Description	Mandatory (Yes or No)
Structure	Displays the member relationship structure name.	Not applicable
Description	Used to specify the description for the structure.	Yes
Detailed Description	Used to specify additional information about the structure.	No
Maximum Member Count	Used to specify the maximum number of members allowed in the structure.	No
	Note: If you do not specify the value, by default, it is set to zero (0).	

- **Member Relationship/Subscription Tier Criteria** - Used to define a criteria for the member relationship. It contains the following fields:

Field Name	Field Description	Mandatory (Yes or No)
Member Relationship/Subscription Tier	Used to specify a code name for the criteria.	No
	Note: You must specify a unique code name for the member relationship/subscription criteria.	
Self	Used to specify the main subscriber for the member relationship.	No
	Note: The value for this field must be a positive integer.	
Number of Spouses	Used to specify the total number of spouses in the membership who meet the member relationship criteria.	No
	Note: The value for this field must be a positive integer.	
Number of Dependents	Used to specify the total number of dependents in the membership who meet the member relationship criteria.	No
	Note: The value for this field must be a positive integer.	
Number of Young Adults	Used to specify the total number of young adults in the membership who meet the member relationship criteria.	No
	Note: The value for this field must be a positive integer.	

Note:

You must specify at least one criteria for the member relationship structure. However, you can specify only a single member relationship criteria, if the maximum member count is set to zero (0) or one (1).

Relationship Matrix - Used to define a relationship matrix for the member relationship. It contains the following fields:

Field Name	Field Description	Mandatory (Yes or No)
Relation	Used to indicate an entity in the relationship matrix.	No
Relationship Type	Used to indicate how a member person is associated with the main subscriber using a relationship type.	No
Relationship	Used to indicate how the relation is associated with the relationship type in the relationship matrix	No

Note: You must specify at least one relationship matrix.

Tip: Alternatively, you can edit the details of a member relationship structure by clicking the **Edit** button in the **Member Relationship/Subscription Tier Structure** zone.

4. Modify the details in the **Main** section.
5. Define, edit, or remove the criteria (for the member relationship structure) in the **Member Relationship/Subscription Tier Criteria** section.
6. If you want to define more than one criteria for the member relationship structure, click the **Add (+)** icon and then repeat step 5.

Note: However, if you want to remove a criteria from the member relationship structure, click the **Delete** (🗑️) icon corresponding to the **Member Relationship/Subscription Tier** field.

7. Define, edit, or remove the relationship matrix (for the member relationship structure) in the **Relationship Matrix** section.
8. If you want to define more than one relationship matrix for the member relationship structure, click the **Add (+)** icon and then repeat step 7.

Note: However, if you want to remove a relationship matrix from the member relationship structure, click the **Delete** (🗑️) icon corresponding to the **Relation** field.

9. Click **Save**.

The changes made to the member relationship structure are saved.

Related Topics

For more information on...	See...
Member Relationship/Subscription Tier Structure screen	Member Relationship/Subscription Tier Structure (Used for Searching) on page 119
Member Relationship/Subscription Tier Structure List zone	Member Relationship/Subscription Tier Structure List on page 119
Member Relationship/Subscription Tier Structure zone	Member Relationship/Subscription Tier Structure on page 120

Copying a Member Relationship Structure

Procedure

To copy a member relationship structure:

1. Click the **Admin** link in the **Application** toolbar.

A list appears.

2. From the **Admin** menu, select **M** and then click **Member Relationship/Subscription Tier Structure**.

The **Member Relationship/Subscription Tier Structure** screen appears.

3. In the **Member Relationship/Subscription Tier Structure List** zone, click the **Duplicate** (📄) icon in the **Duplicate** column corresponding to the member relationship structure whose copy you want to create.

The **Member Relationship/Subscription Tier Structure** screen appears. It contains the following sections:

- **Main** - Used to specify basic details about the member relationship structure. It contains the following fields:

Field Name	Field Description	Mandatory (Yes or No)
Structure	Used to specify a code name for the structure.	Not applicable
	Note: You must specify a unique code name for the structure.	
Description	Used to specify the description for the structure.	Yes
Detailed Description	Used to specify additional information about the structure.	No
Maximum Member Count	Used to specify the maximum number of members allowed in the structure.	No
	Note: If you do not specify the value, by default, it is set to zero (0).	

- **Member Relationship/Subscription Tier Criteria** - Used to specify the criteria details for the member relationship. It contains the following fields:

Field Name	Field Description	Mandatory (Yes or No)
Member Relationship/Subscription Tier	Used to specify a code name for the criteria.	No
	Note: You must specify a unique code name for the member relationship/subscription criteria.	
Self	Used to specify the main subscriber for the member relationship.	No
	Note: The value for this field must be a positive integer.	

Field Name	Field Description	Mandatory (Yes or No)
Number of Spouses	Used to specify the total number of spouses in the membership who meet the member relationship criteria.	No
	Note: The value for this field must be a positive integer.	
Number of Dependents	Used to specify the total number of dependents in the membership who meet the member relationship criteria.	No
	Note: The value for this field must be a positive integer.	
Number of Young Adults	Used to specify the total number of young adults in the membership who meet the member relationship criteria.	No
	Note: The value for this field must be a positive integer.	

Note:

You must specify at least one criteria for the member relationship structure. However, you can specify only a single member relationship criteria, if the maximum member count is set to zero (0) or one (1).

Relationship Matrix - Used to specify the relationship matrix for the member relationship. It contains the following fields:

Field Name	Field Description	Mandatory (Yes or No)
Relation	Used to indicate an entity in the relationship matrix.	No
Relationship Type	Used to indicate how a member person is associated with the main subscriber using a relationship type.	No
Relationship	Used to indicate how the relation is associated with the relationship type in the relationship matrix	No

Note: You must specify at least one relationship matrix.

Tip: Alternatively, you can copy a member relationship structure by clicking the **Duplicate** button in the **Member Relationship/Subscription Tier Structure** zone.

4. Enter the required details in the **Main** section.
5. Define, edit, or remove a criteria (for the member relationship structure) in the **Member Relationship/Subscription Tier Criteria** section.
6. If you want to define more than one criteria for the member relationship structure, click the **Add (+)** icon and then repeat step 5.

Note: However, if you want to remove a criteria from the member relationship structure, click the **Delete** (🗑️) icon corresponding to the **Member Relationship/Subscription Tier** field.

7. Define, edit, or remove the relationship matrix (for the member relationship structure) in the **Relationship Matrix** section.
8. If you want to define more than one relationship matrix for the member relationship structure, click the **Add (+)** icon and then repeat step 7.

Note: However, if you want to remove a relationship matrix from the member relationship structure, click the **Delete (🗑)** icon corresponding to the **Relation** field.

9. Click **Save**.

The new member relationship structure is created.

Related Topics

For more information on...	See...
Member Relationship/Subscription Tier Structure screen	Member Relationship/Subscription Tier Structure (Used for Searching) on page 119
Member Relationship/Subscription Tier Structure List zone	Member Relationship/Subscription Tier Structure List on page 119
Member Relationship/Subscription Tier Structure zone	Member Relationship/Subscription Tier Structure on page 120

Deleting a Member Relationship Structure

Procedure

To delete a member relationship structure:

1. Click the **Admin** link in the **Application** toolbar.
A list appears.
2. From the **Admin** menu, select **M** and then click **Member Relationship/Subscription Tier Structure**.
A sub-menu appears.
3. Click the **Search** option from the **Member Relationship/Subscription Tier Structure** sub-menu.
The **Member Relationship/Subscription Tier Structure** screen appears.
4. In the **Member Relationship/Subscription Tier Structure List** section, click the **Delete (🗑)** icon in the **Delete** column corresponding to the member relationship structure that you want to delete.
A message appears confirming whether you want to delete the member relationship structure.

Tip: Alternatively, you can click the **Delete** button in the **Member Relationship/Subscription Tier Structure** zone to delete the member relationship structure.

5. Click **OK**.

The member relationship structure is deleted.

Related Topics

For more information on...	See...
Member Relationship/Subscription Tier Structure screen	Member Relationship/Subscription Tier Structure (Used for Searching) on page 119
Member Relationship/Subscription Tier Structure List zone	Member Relationship/Subscription Tier Structure List on page 119

For more information on...	See...
Member Relationship/Subscription Tier Structure zone	Member Relationship/Subscription Tier Structure on page 120

Viewing the Member Relationship Structure Details

Procedure

To view the details of the member relationship structure:

1. Click the **Admin** link in the **Application** toolbar.
A list appears.
2. From the **Admin** menu, select **M** and then click **Member Relationship/Subscription Tier Structure**.
A sub-menu appears.
3. Click the **Search** option from the **Member Relationship/Subscription Tier Structure** sub-menu.
The **Member Relationship/Subscription Tier Structure** screen appears.
4. In the **Member Relationship/Subscription Tier Structure List** zone, click the **Broadcast** () icon corresponding to the structure column whose details you want to view.
The **Member Relationship/Subscription Tier Structure** zone appears.
5. View the details of the member relationship structure in the **Member Relationship/Subscription Tier Structure** zone.

Related Topics

For more information on...	See...
Member Relationship/Subscription Tier Structure screen	Member Relationship/Subscription Tier Structure (Used for Searching) on page 119
Member Relationship/Subscription Tier Structure List zone	Member Relationship/Subscription Tier Structure List on page 119
Member Relationship/Subscription Tier Structure zone	Member Relationship/Subscription Tier Structure on page 120

Subscription Tier Pricing Parameter

Oracle Revenue Management and Billing enables you to use the subscription tier as a pricing parameter while defining the tier based pricing rules. This feature facilitates you to offer different rates for a price item based on different subscription tier.

On creating the bill period timelines, the system executes the **Derive Subscription Tier for Membership (C1-DERSUBTR)** algorithm attached to the **Account and Price Item Derivation Post-Processing** system event in the respective tier based pricing rule type. This algorithm determines the subscription tier of the membership for each bill period timeline. While determining the subscription tier for a membership, the system derives subscription tier for the membership from a subscription tier structure. Note that while deriving the subscription tier of a membership for a bill period timeline, the system refers the proration rules defined on the respective policy plan and accordingly derives the subscription tier for the membership. The system invokes the **C1-DERSUBTR** algorithm in the **C1-REPC1** batch.

You can define a subscription tier structure through a characteristic on the policy plan. While defining a subscription tier structure for a policy plan, you must use the characteristic type specified in the **Subscription Tier Structure Characteristic Type** attribute of a member relationship and subscription tier preference. The system considers the

member relationship and subscription tier preference which is specified in the **Relation Structure Code Field Mapping** option type of the **C1-ASOBLNG** feature configuration.

A subscription tier structure helps the system to determine the subscription tier to which the membership belongs. You can specify a list of subscription tiers in a subscription tier structure. A subscription tier is derived for a membership depending on the following:

- Whether the member person is a self, spouse, or dependent
- Number of spouses, dependents, and young adults in the membership in the respective bill period timeline

A relationship matrix indicates whether a member person with a particular relationship type should be considered as self, spouse, or dependent while deriving the subscription tier. In a subscription tier structure, a spouse is never considered as a dependent. Only children are considered as dependents.

For example, you can create a subscription tier structure named STEX1 as shown below:

Subscription Tier	Self	Number of Spouses	Number of Dependents	Number of Young Adults
E	1	0	0	0
ES	1	1	0	0
ESC1	1	1	1	0
ESC2	1	1	2	0
EC1	1	0	1	0
EC2	1	0	2	0
EC3	1	0	3	0
F	1	9	9	9

Note: You can only define one subscription tier in a subscription tier structure where the sum of self, number of spouses, number of dependents, and number of young adults exceeds the maximum member count specified in the subscription tier structure.

In addition, you can create a relationship matrix in the STEX1 subscription tier structure as shown below:

Relation	Relationship Type	Relationship
Main Subscriber	Owner	Self
Main Subscriber	Member	Self
Children	Child	Dependent
Spouse	Wife	Spouse
Spouse	Spouse	Spouse

Once the subscription tier structure is derived from the policy plan, the system determines the subscription tier of the membership for the bill period timeline. While determining the subscription tier of a membership for the bill period timeline, the system derives the following characteristic types from the respective attributes of the member relationship and subscription tier preference:

- Age Calculation Date Basis
- Max Age Limit for Max Dependent Count

- Max Number of Dependents Order Priority
- Maximum Number of Dependents
- New Born Gift Days
- New Born Gift Days Applicability
- Young Adult Max Age Limit
- Young Adult Max Age Limit Applicability

The system then derives these characteristics from the policy plan. For example, if a membership with the following member persons is added to a policy plan:

Member Start Date	Member End Date	Person Name	Main Subscriber	Relationship Type	Member	Date of Birth
1-Jan-20	31-Dec-20	Mark	Yes	Self	Yes	15-Jan-68
1-Jan-20	31-Dec-20	Nancy	No	Wife	Yes	20-Apr-72
1-Jan-20	31-Dec-20	Roger	No	Child	Yes	15-May-01
1-Jan-20	31-Dec-20	Tom	No	Child	Yes	16-May-04

Now, if the following characteristics are defined on the policy plan:

- Subscription Tier Structure - STEX1
- Age Calculation Date Basis – Enrollment Date
- Maximum Number of Dependents – 3
- Max Number of Dependents Order Priority - ELDEST
- Max Age Limit for Max Dependent Count – 21
- New Born Gift Days - 30
- New Born Gift Days Applicability - Y
- Young Adult Max Age Limit - 25
- Young Adult Max Age Limit Applicability - Y

The system considers the STEX1 subscription tier structure and derives the subscription tier of the membership for each bill period timeline as shown below:

Bill Period Timeline	Characteristic Type	Characteristic Value
1-Jan-20 to 31-Jan-20	Subscription Tier	ESC2
1-Feb-20 to 29-Feb-20	Subscription Tier	ESC2
1-Mar-20 to 31-Mar-20	Subscription Tier	ESC2
1-Apr-20 to 30-Apr-20	Subscription Tier	ESC2
1-May-20 to 31-May-20	Subscription Tier	ESC2
1-Jun-20 to 30-Jun-20	Subscription Tier	ESC2
1-Jul-20 to 31-Jul-20	Subscription Tier	ESC2

Bill Period Timeline	Characteristic Type	Characteristic Value
1-Aug-20 to 31-Aug-20	Subscription Tier	ESC2
1-Sep-20 to 30-Sep-20	Subscription Tier	ESC2
1-Oct-20 to 31-Oct-20	Subscription Tier	ESC2
1-Nov-20 to 30-Nov-20	Subscription Tier	ESC2
1-Dec-20 to 31-Dec-20	Subscription Tier	ESC2

Because the characteristic value is same across all bill period timelines, the system will create one subscription tier characteristic with the effective date as 01-Jan-2020. Now, assume if one more member person named Harry with the date of birth as 05-11-08 and relationship type as Child is added to the membership on 05-Mar-20, then the system derives the subscription tier of the membership for each bill period timeline as shown below:

Bill Period Timeline	Characteristic Type	Characteristic Value
5-Mar-20 to 31-Mar-20	Subscription Tier	F
1-Apr-20 to 30-Apr-20	Subscription Tier	F
1-May-20 to 31-May-20	Subscription Tier	F
1-Jun-20 to 30-Jun-20	Subscription Tier	F
1-Jul-20 to 31-Jul-20	Subscription Tier	F
1-Aug-20 to 31-Aug-20	Subscription Tier	F
1-Sep-20 to 30-Sep-20	Subscription Tier	F
1-Oct-20 to 31-Oct-20	Subscription Tier	F
1-Nov-20 to 30-Nov-20	Subscription Tier	F
1-Dec-20 to 31-Dec-20	Subscription Tier	F

In this case, the system will have two subscription tier characteristics for the membership – one with the effective date as 01-Jan-2020 where the characteristic value is set to **ESC2** and another with the effective date as 05-Mar-2020 where the characteristic value is set to **F**.

If a new born is added to the membership, the effective date of the new subscription tier characteristic is calculated considering the gift days if applicable. If a member person is end dated, the system derives the subscription tier of the membership once again. If the subscription tier for the membership is different, the system creates a new characteristic to store the subscription tier for the membership. The effective date of the new characteristic is set according to the proration rule defined for the termination event. If a member person is inactivated, the system derives the subscription tier of the membership once again. In this case, if the subscription tier for the membership is different, the system updates the existing subscription tier characteristic of the membership.

To use the subscription tier as a pricing parameter, you need to define the Subscription Tier parameter where:

- **Value Type** is to **Adhoc**
- **Source Entity** is set to **Membership**
- **Source Type** is set to **Characteristic**
- **Source Type Code** is set to a characteristic type which is specified in the **Subscription Tier Characteristic Type** attribute of the member relationship and subscription tier preference
- **Parameter Usage** is set to **Price Item** and **Pricing Eligibility Criteria**

Once the Subscription Tier parameter is defined, you need to associate the parameter with the price items for which you want to define different rates in a pricing rule using the parameter. This helps to define different base fee for a price item based on the subscription tier.

A new screen named **Member Relationship/Subscription Tier Structure** is introduced in this release. It enables you to add, edit, copy, and delete the member relationship and subscription tier structures.

Prerequisites

To create a subscription tier pricing parameter, you need to do the following:

- Define the pricing parameter with the subscription tier.
- The **Admin** user must define different types of subscription tiers, where all the tiers must be defined in the **Member Relationship/Subscription Tier Structure** screen. These subscription tiers must also exist in the **C1-ASOBLNG** feature configuration.
- Define the required characteristic types, such as, **Subscription Tier Structure (C1-STRST)** and **Age Calculation Date Basis (C1-AGCAL)** on the policy plan.
- Define the following set of characteristics while adding the characteristics for the policy plan and also when the premium billing preferences are defined:
 - Max Age of Dependent
 - Max Number of Dependents
 - Order Priority
 - Young Adult Max Age Limit
 - Young Adult Inclusion Applicability
- The above characteristic types along with the **Subscription (C1-SUBST)** characteristic type would be stamped on member person, must be specified in the **Field Mapping** screen.

Related Topics

For more information on...	See...
Uploading a Geographic Rating Area File in the CSV Format	Uploading a Geographic Rating Area File in the CSV Format on page 102
CSV File Format for Uploading Geographic Rating Areas	CSV File Format for Uploading Geographic Rating Areas on page 103
Sample CSV Format for Uploading Geographic Rating Areas	Sample CSV Format for Uploading Geographic Rating Areas on page 104

Member Relationship/Subscription Tier Structure (Used for Searching)

The **Member Relationship/Subscription Tier Structure** screen allows you to search for a member relationship/subscription tier using various search criteria. It also allows you to create a member relationship/subscription tier. Through this screen, you can navigate to the following screen. It contains the following zone:

This screen consists of the following zone:

- [Member Relationship/Subscription Tier Structure List](#) on page 119
- [Member Relationship/Subscription Tier Structure](#) on page 120

Member Relationship/Subscription Tier Structure List

The **Member Relationship/Subscription Tier Structure List** zone displays the member relationship or subscription tier structure information. It contains the following columns:

Column Name	Column Description
Structure	Used to specify the structure code for the structure.
Description	Used to specify the description for the structure.
Edit	On clicking the Edit (✎) icon, the Member Relationship/Subscription Tier Structure screen appears where you can edit the structural details of the member relationship or subscription tier.
Duplicate	On clicking the Duplicate (📄) icon, the Member Relationship/Subscription Tier Structure screen appears where you can define a new member relationship or subscription tier using an existing member relationship or subscription tier.
Delete	On clicking the Delete (🗑) icon, you can delete the member relationship or subscription tier structure.

Note:

Pagination is used to display limited number of records in the **Search Results** section. You can use the navigation links, such as **Previous** and **Next** to navigate between pages.

You can filter the list using various search criteria (such as, **Structure** and **Description**) available in the **Filter** area. By default, the **Filter** area is hidden. You can view the **Filter** area by clicking the Filters (🔍) icon in the upper right corner of this zone.

Related Topics

For more information on...	See...
How to view the details of a member relationship/subscription tier structure	Viewing the Subscription Tier Structure Details on page 143
How to define a member relationship/subscription tier structure	Defining a Subscription Tier Structure on page 136

Member Relationship/Subscription Tier Structure

The **Member Relationship/Subscription Tier Structure** zone displays the details of the member relationship or subscription tier structure. It contains the following sections:

- **Main** - Displays basic information about the member relationship or subscription tier structure. It contains the following fields:

Field Name	Field Description
Structure	Displays the type of structure.
Description	Displays the description of the structure.
Detailed Description	Displays additional information about the structure.
Maximum Member Count	Displays the maximum count of the members allowed in the structure.

- **Member Relationship/Subscription Tier Criteria** - Lists the criteria details of the member relationship or subscription tier. It contains the following columns:

Column Name	Column Description
Member Relationship/Subscription Tier	Displays the criteria code for the member relationship or subscription tier.

Column Name	Column Description
Self	Displays the main subscriber who meets the member relationship or subscription tier criteria. Note: The total count in the Self column cannot exceed more than one.
Number of Spouses	Displays the total number of spouses in the membership who meet the member person relationship criteria.
Number of Dependents	Displays the total number of dependents in the membership who meet the member person relationship criteria.
Number of Young Adults	Displays the total number of young adults in the membership who meet the member person relationship criteria.

- **Relationship Matrix** - Lists the relationship matrix details defined for the member relationship or subscription tier structure. It contains the following columns:

Column Name	Column Description
Relation	Indicates an entity defined in the relationship matrix.
Relationship Type	Indicates how a member person is associated with the main subscriber using a relationship type.
Relationship	Indicates how a member person is associated with the relationship type.

- **Record Actions** - This section contains the following buttons:

Button Name	Button Description
Edit	Used to edit the structural details of the member relationship or subscription tier.
Delete	Used to delete the member relationship or subscription tier structure.
Duplicate	Used to create a new member relationship or subscription tier structure using an existing structure.

- **Record Information** - This section contains the following fields:

Field Name	Field Description
Business Object	Indicates the business object using which the member relationship or subscription tier structure is created. In addition, a context menu appears corresponding to this field which helps in navigating to other screens in the application. Note: It has a link. On clicking the link, the Business Object screen appears where you can view the details of the respective business object.

Related Topics

For more information on...	See...
How to edit a member relationship/subscription tier structure	Editing a Subscription Tier Structure on page 138

For more information on...	See...
How to delete a member relationship/subscription tier structure	Deleting a Subscription Tier Structure on page 142
How to copy a member relationship/subscription tier structure	Copying a Subscription Tier Structure on page 140

Defining a Subscription Tier Structure

Procedure

To define a subscription tier structure:

1. Click the **Admin** link in the **Application** toolbar.
A list appears.
2. From the **Admin** menu, select **M** and then click **Member Relationship/Subscription Tier Structure**.
A sub-menu appears.
3. Click the **Add** option from the **Member Relationship/Subscription Tier Structure** sub-menu.

The **Member Relationship/Subscription Tier Structure** screen appears. It contains the following sections:

- **Main** - Used to specify basic details about the subscription tier structure. It contains the following fields:

Field Name	Field Description	Mandatory (Yes or No)
Structure	Used to specify a code name for the structure.	Yes
	Note: You must specify a unique code name for the structure.	
Description	Used to specify the description for the structure.	Yes
Detailed Description	Used to specify additional information about the structure.	No
Maximum Member Count	Used to specify the maximum number of members allowed in the structure.	No
	Note: If you do not specify the value, by default, it is set to zero (0).	

- **Member Relationship/Subscription Tier Criteria** - Used to specify a criteria for the subscription tier. It contains the following fields:

Field Name	Field Description	Mandatory (Yes or No)
Member Relationship/Subscription Tier	Used to specify a code name for the criteria.	No
	Note: You must specify a unique code name for the subscription tier criteria.	
Self	Used to specify the main subscriber for the subscription tier.	No
	Note: The value for this field must be a positive integer.	

Field Name	Field Description	Mandatory (Yes or No)
Number of Spouses	Used to specify the total number of spouses in the membership who meet the subscription tier criteria.	No
	Note: The value for this field must be a positive integer.	
Number of Dependents	Used to specify the total number of dependents in the membership who meet the subscription tier criteria.	No
	Note: The value for this field must be a positive integer.	
Number of Young Adults	Used to specify the total number of young adults in the membership who meet the subscription tier criteria.	No
	Note: The value for this field must be a positive integer.	

Note: You must specify at least one criteria for the subscription tier structure. However, you can specify only a single subscription tier criteria, if the maximum member count is set to zero (0) or one (1).

Relationship Matrix - Used to specify the relationship matrix for the subscription tier. It contains the following fields:

Field Name	Field Description	Mandatory (Yes or No)
Relation	Used to indicate an entity in the relationship matrix.	No
Relationship Type	Used to indicate how a member person is associated with the main subscriber using a relationship type.	No
Relationship	Used to indicate how the relation is associated with the relationship type in the relationship matrix	No

Note: You must specify at least one relationship matrix.

Tip: Alternatively, you can access this screen by clicking the **Add** button in the **Page Title** area of the **Member Relationship/Subscription Tier Structure** screen.

4. Enter the required details in the **Main** section.
5. Define a criteria (for the subscription tier structure) in the **Member Relationship/Subscription Tier Criteria** section.
6. If you want to define more than one criteria for the subscription tier structure, click the **Add (+)** icon and then repeat step 5.

Note: However, if you want to remove a criteria from the subscription tier structure, click the **Delete** (🗑️) icon corresponding to the **Member Relationship/Subscription Tier** field.

7. Define a relationship matrix (for the subscription tier structure) in the **Relationship Matrix** section.

- If you want to define more than one relationship matrix for the subscription tier structure, click the **Add (+)** icon and then repeat step 7.

Note: However, if you want to remove a relationship matrix from the subscription tier structure, click the **Delete** (🗑️) icon corresponding to the **Relation** field.

- Click **Save**.

The subscription tier structure is defined.

Related Topics

For more information on...	See...
Member Relationship/Subscription Tier Structure screen	Member Relationship/Subscription Tier Structure (Used for Searching) on page 119

Editing a Subscription Tier Structure

Procedure

To edit a subscription tier structure:

- Click the **Admin** link in the **Application** toolbar.
A list appears.
- From the **Admin** menu, select **M** and then click **Member Relationship/Subscription Tier Structure**.
The **Member Relationship/Subscription Tier Structure** screen appears.
- In the **Member Relationship/Subscription Tier Structure List** zone, click the **Edit** (✎) icon in the **Edit** column corresponding to the subscription tier structure whose details you want to edit.

The **Member Relationship/Subscription Tier Structure** screen appears. It contains the following sections:

- Main** - Used to specify basic details about the subscription tier structure. It contains the following fields:

Field Name	Field Description	Mandatory (Yes or No)
Structure	Displays the subscription tier structure name.	Not applicable
Description	Used to specify the description for the structure.	Yes
Detailed Description	Used to specify additional information about the structure.	No
Maximum Member Count	Used to specify the maximum number of members allowed in the structure.	No
	Note: If you do not specify the value, by default, it is set to zero (0).	

- Member Relationship/Subscription Tier Criteria** - Used to specify a criteria for the subscription tier. It contains the following fields:

Field Name	Field Description	Mandatory (Yes or No)
Member Relationship/Subscription Tier	Used to specify a code name for the criteria.	No
	Note: You must specify a unique code name for the criteria.	

Field Name	Field Description	Mandatory (Yes or No)
Self	Used to specify the main subscriber for the subscription tier.	No
	Note: The value for this field must be a positive integer.	
Number of Spouses	Used to specify the total number of spouses in the membership who meet the subscription tier criteria.	No
	Note: The value for this field must be a positive integer.	
Number of Dependents	Used to specify the total number of dependents in the membership who meet the subscription tier criteria.	No
	Note: The value for this field must be a positive integer.	
Number of Young Adults	Used to specify the total number of young adults in the membership who meet the subscription tier criteria.	No
	Note: The value for this field must be a positive integer.	

Note:
You must specify at least one criteria for the subscription tier structure. However, you can specify only a single subscription tier criteria, if the maximum member count is set to zero (0) or one (1).

Relationship Matrix - Used to specify a relationship matrix for the subscription tier. It contains the following fields:

Field Name	Field Description	Mandatory (Yes or No)
Relation	Used to indicate an entity in the relationship matrix.	No
Relationship Type	Used to indicate how a member person is associated with the main subscriber using a relationship type.	No
Relationship	Used to indicate how the relation is associated with the relationship type in the relationship matrix.	No

Note: You must specify at least one relationship matrix.

Tip: Alternatively, you can edit the details of a member relationship structure by clicking the **Edit** button in the **Member Relationship/Subscription Tier Structure** zone.

4. Modify the details in the **Main** section.
5. Define, edit, or remove a criteria (for the subscription tier structure) in the **Member Relationship/Subscription Tier Criteria** section.

6. If you want to define more than one criteria for the subscription tier structure, click the **Add (+)** icon and then repeat step 5.

Note: However, if you want to remove a criteria from the subscription tier structure, click the **Delete (🗑)** icon corresponding to the **Member Relationship/Subscription Tier** field.

7. Define, edit, or remove a relationship matrix (for the subscription tier structure) in the **Relationship Matrix** section.
8. If you want to define more than one relationship matrix for the subscription tier structure, click the **Add (+)** icon and then repeat step 7.

Note: However, if you want to remove a relationship matrix from the subscription tier structure, click the **Delete (🗑)** icon corresponding to the **Relation** field.

9. Click **Save**.

The changes made to the subscription tier structure are saved.

Related Topics

For more information on...	See...
Member Relationship/Subscription Tier Structure screen	Member Relationship/Subscription Tier Structure (Used for Searching) on page 119
Member Relationship/Subscription Tier Structure List zone	Member Relationship/Subscription Tier Structure List on page 119
Member Relationship/Subscription Tier Structure zone	Member Relationship/Subscription Tier Structure on page 120

Copying a Subscription Tier Structure

Procedure

To copy a subscription tier structure:

- Click the **Admin** link in the **Application** toolbar.
A list appears.
- From the **Admin** menu, select **M** and then click **Member Relationship/Subscription Tier Structure**.
The **Member Relationship/Subscription Tier Structure** screen appears.
- In the **Member Relationship/Subscription Tier Structure List** zone, click the **Duplicate (📄)** icon in the **Duplicate** column corresponding to the subscription tier structure whose copy you want to create.

The **Member Relationship/Subscription Tier Structure** screen appears. It contains the following sections:

- Main** - Used to specify basic details about the subscription tier structure. It contains the following fields:

Field Name	Field Description	Mandatory (Yes or No)
Structure	Used to specify a code name for the structure.	Not applicable
	Note: You must specify a unique code name for the structure.	
Description	Used to specify the description for the structure.	Yes

Field Name	Field Description	Mandatory (Yes or No)
Detailed Description	Used to specify additional information about the structure.	No
Maximum Member Count	Used to specify the maximum number of members allowed in the structure. Note: If you do not specify the value, by default, it is set to zero (0).	No

- **Member Relationship/Subscription Tier Criteria** - Used to specify the criteria details for the subscription tier. It contains the following fields:

Field Name	Field Description	Mandatory (Yes or No)
Member Relationship/Subscription Tier	Used to specify a code name for the criteria. Note: You must specify a unique code name for the member relationship/subscription criteria.	No
Self	Used to specify the main subscriber for the subscription tier. Note: The value for this field must be a positive integer.	No
Number of Spouses	Used to specify the total number of spouses in the membership who meet the subscription tier criteria. Note: The value for this field must be a positive integer.	No
Number of Dependents	Used to specify the total number of dependents in the membership who meet the subscription tier criteria. Note: The value for this field must be a positive integer.	No
Number of Young Adults	Used to specify the total number of young adults in the membership who meet the subscription tier criteria. Note: The value for this field must be a positive integer.	No

Note:

You must specify at least one criteria for the subscription tier structure. However, you can specify only a single subscription tier criteria, if the maximum member count is set to zero (0) or one (1).

Relationship Matrix - Used to specify the relationship matrix for the subscription tier. It contains the following fields:

Field Name	Field Description	Mandatory (Yes or No)
Relation	Used to indicate an entity in the relationship matrix.	No
Relationship Type	Used to indicate how a member person is associated with the main subscriber using a relationship type.	No
Relationship	Used to indicate how the relation is associated with the relationship type in the relationship matrix	No

Note: You must specify at least one relationship matrix.

Tip: Alternatively, you can copy a member relationship structure by clicking the **Duplicate** button in the **Member Relationship/Subscription Tier Structure** zone.

- Enter the required details in the **Main** section.
- Define, edit, or remove a criteria (for the subscription tier structure) in the **Member Relationship/Subscription Tier Criteria** section.
- If you want to define more than one criteria for the subscription tier structure, click the **Add (+)** icon and then repeat step 5.

Note: However, if you want to remove a criteria from the subscription tier structure, click the **Delete** (🗑️) icon corresponding to the **Member Relationship/Subscription Tier** field.

- Define, edit, or remove the relationship matrix (for the subscription tier structure) in the **Relationship Matrix** section.
- If you want to define more than one relationship matrix for the subscription tier structure, click the **Add (+)** icon and then repeat step 7.

Note: However, if you want to remove a relationship matrix from the subscription tier structure, click the **Delete** (🗑️) icon corresponding to the **Relation** field.

- Click **Save**.

The new subscription tier structure is created.

Related Topics

For more information on...	See...
Member Relationship/Subscription Tier Structure screen	Member Relationship/Subscription Tier Structure (Used for Searching) on page 119
Member Relationship/Subscription Tier Structure List zone	Member Relationship/Subscription Tier Structure List on page 119
Member Relationship/Subscription Tier Structure zone	Member Relationship/Subscription Tier Structure on page 120

Deleting a Subscription Tier Structure

Procedure

To delete a subscription tier structure:

- Click the **Admin** link in the **Application** toolbar.

A list appears.

- From the **Admin** menu, select **M** and then click **Member Relationship/Subscription Tier Structure**.

A sub-menu appears.

- Click the **Search** option from the **Member Relationship/Subscription Tier Structure** sub-menu.

The **Member Relationship/Subscription Tier Structure** screen appears.

- In the **Member Relationship/Subscription Tier Structure List** section, click the **Delete** () icon in the **Delete** column corresponding to the subscription tier structure that you want to delete.

A message appears confirming whether you want to delete the subscription tier structure.

Tip: Alternatively, you can click the **Delete** button in the **Member Relationship/Subscription Tier Structure** zone to delete the subscription tier structure.

- Click **OK**.

The subscription tier structure is deleted.

Related Topics

For more information on...	See...
Member Relationship/Subscription Tier Structure screen	Member Relationship/Subscription Tier Structure (Used for Searching) on page 119
Member Relationship/Subscription Tier Structure List zone	Member Relationship/Subscription Tier Structure List on page 119
Member Relationship/Subscription Tier Structure zone	Member Relationship/Subscription Tier Structure on page 120

Viewing the Subscription Tier Structure Details

Procedure

To view the details of the subscription tier structure:

- Click the **Admin** link in the **Application** toolbar.
A list appears.
- From the **Admin** menu, select **M** and then click **Member Relationship/Subscription Tier Structure**.
A sub-menu appears.
- Click the **Search** option from the **Member Relationship/Subscription Tier Structure** sub-menu.
The **Member Relationship/Subscription Tier Structure** screen appears.
- In the **Member Relationship/Subscription Tier Structure List** zone, click the **Broadcast** () icon corresponding to the structure column whose details you want to view.
The **Member Relationship/Subscription Tier Structure** zone appears.
- View the details of the subscription tier structure in the **Member Relationship/Subscription Tier Structure** zone.

Related Topics

For more information on...	See...
Member Relationship/Subscription Tier Structure screen	Member Relationship/Subscription Tier Structure (Used for Searching) on page 119

For more information on...	See...
Member Relationship/Subscription Tier Structure List zone	Member Relationship/Subscription Tier Structure List on page 119
Member Relationship/Subscription Tier Structure zone	Member Relationship/Subscription Tier Structure on page 120

Medicare Benefits

Oracle Revenue Management and Billing enables you to maintain the Medicare benefits (such as, Part A, Part B, Part D, Part D LIS, and Part D LEP) of a member person. The system enables you to define and edit the Medicare benefits from the user interface, through a health care inbound message, or through the membership repricing inbound web service. While defining a Medicare benefit of a member person for Part A, Part B, and Part D, you need to specify a Medicare plan benefit package (i.e. 800 series plan) which is applicable for the Medicare benefit. The system enables you to define and edit a Medicare plan benefit package through the **Field Mapping** screen. You can use the Medicare plan benefit package as a pricing parameter in the age based or tier based pricing rules using which the Medicare premium is calculated. While defining a Medicare benefit of a member person for Part D LIS and Part D LEP, you need to specify the benefit amount (i.e. subsidy or penalty amount).

While editing a Medicare benefit of a member person from the user interface, you can only edit the characteristics of the Medicare benefit. However, while editing a Medicare benefit of a member person through a health care inbound message or through the membership repricing inbound web service, you can edit the end date, benefit amount, and characteristics of the Medicare benefit. On editing a Medicare benefit, the system inactivates the old record and creates a new record in the system. The status of the old benefit record is set to **Inactive** and the status of the new benefit record is set to **Active**.

The system enables you to discard an active or inactive Medicare benefit from the user interface by clicking the **Discard** button.

Benefit Status Transition

The following figure graphically indicates how a Medicare benefit moves from one status to another in its lifecycle:

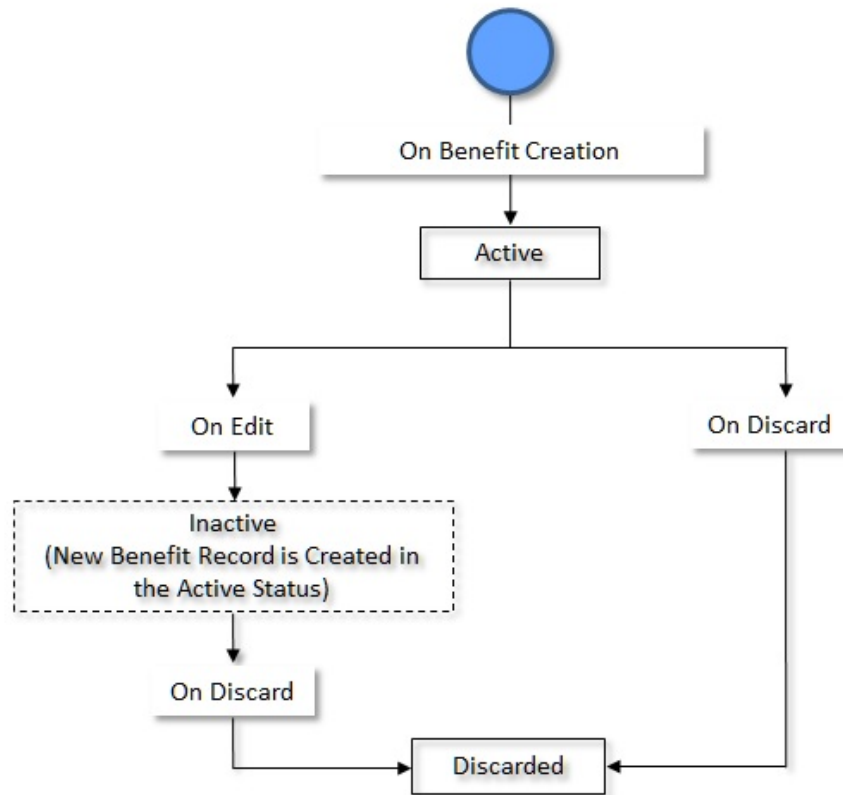

Algorithms Used in C1-Benefits

The following table lists the algorithms which are attached to the **C1-Benefits** business object:

System Event	Algorithm	Algorithm Type	Description
Audit	C1-FIAUDEV	C1-FIAUDEV	Refer to C1-FIAUDEV on page 145.
Validation	C1-BENVAL	C1-BENVAL	C1-BENVAL on page 146

C1-FIAUDEV

If this algorithm is attached to the **Audit** system event of the **C1-Membership**, **C1-Benefits**, and **C1_PERSON_BO** business objects, it is invoked whenever you define, edit, or delete the respective entity. It checks whether an active audit event type exists for the entity business object. If so, it considers the active audit event type and creates the audit event using the respective audit event type. The system creates the audit event whenever a membership is added to a policy plan, member person is added to a membership, and a Medicare benefit is defined for a member person. It also creates the audit event whenever the membership, member person, and Medicare benefit details are updated. However, note that the audit events are created in the update scenario when the element listed for auditing in the age based, tier based, or benefit pricing rule type is updated. The system considers only those pricing rule types whose pricing rules are effective during the respective entity (i.e. membership, member person, or Medicare benefit whichever is updated) date range.

It creates one or more audit events in the **Pending** status. The entity type and entity ID for which an audit event is created are added corresponding to the audit event in the **C1_AUDIT_EVENT** table. In addition, the effective date is stamped corresponding to the audit event in the **C1_AUDIT_EVENT** table.

Note:

The system creates an audit event whenever the membership start and end dates and member person's start and end dates are changed in the system irrespective of whether these fields are listed for auditing or not in the age based or tier based pricing rule types.

Before creating an audit event, the system checks whether an audit event for the entity ID with the same effective date already exists in the **Pending** or **Error** status for the respective action. If so, the system does not create a new audit event for the entity. Instead, the system adds a new log entry in the existing audit event.

For each audit event, this algorithm derives the memberships on the policy plans which are impacted and the pricing rule types whose pricing rules are defined on the respective policy plans. A repricing entity detail record is then created for each membership, pricing rule type, and effective date combination in the **CI_REPRC_ENTITY_DTL** table. The status of the repricing entity detail record is set to **P**. Once the repricing entity detail records are created successfully, the status of the audit event is changed to **Complete**.

It contains the following parameters:

- **Audit Event Business Object** – Used to specify the business object using which you want to create the audit event.
- **Audit Event Pending Status** – Used to specify the status in which you want to create the audit event. This parameter is also used for determining whether an audit event for the entity ID already exists in the system.
- **Audit Event Error Status** – Used to specify the status in which an audit event is transitioned when an error occurs while processing the audit event. This parameter is used for determining whether an audit event for the entity ID already exists in the system.

All the above parameters are mandatory.

Related Topics

For more information on...	See...
How the audit events are created and processed for an age based or tier based pricing rule	Age Based and Tier Based Pricing Rules Audit Process on page 3116
How the audit events are created and processed for a membership	Membership Audit Process on page 3117
How the audit events are created and processed for a person	Person Audit Process on page 3123
How the audit events are created and processed for a Medicare benefit	Medicare Benefit Audit Process

C1-BENVAL

This algorithm validates a benefit. It checks the following:

- Whether the benefit end date is not earlier than the benefit start date.
- Whether the membership and member person are specified while defining a Medicare benefit.
- Whether the benefit amount is specified while defining a Medicare benefit of a member person for Part D LIS and Part D LEP.
- Whether the Medicare plan benefit package is specified while defining a Medicare benefit of a member person for Part A, Part B, and Part D.

While editing a Medicare benefit, this algorithm only allows you to edit the following information:

- Benefit Amount
- Benefit End Date

- Benefit Status
- Benefit Characteristics

Benefit Sub Type

Oracle Revenue Management and Billing allows you to define a benefit at the membership level for an individual membership where the system assumes the following:

- There will be only one member person in the Medicare membership who will avail the Medicare benefit.
- The other benefits would be availed by all the member persons of an individual membership.

The **Benefit Sub Type** screen enables you to create, edit, delete, and copy a benefit sub type. It contains the following zones:

- [Benefit Sub Type List](#) on page 147
- [Benefit Sub Type](#) on page 148

For more information on...	See...
Benefit Sub Type List zone	Benefit Sub Type List on page 147
Benefit Sub Type zone	Benefit Sub Type on page 148
How to define a benefit sub type	Defining a Benefit Sub Type on page 151
How to edit a benefit sub type	Editing a Benefit Sub Type on page 154
How to copy a benefit sub type	Copying a Benefit Sub Type on page 157
How to delete a benefit sub type	Deleting a Benefit Sub Type on page 160
How to view the details of a benefit sub type	Viewing the Details of a Benefit Sub Type on page 161

Benefit Sub Type List

The **Benefit Sub Type List** zone lists the benefit sub types that are already defined in the system. It contains the following columns:

Column Name	Column Description
Benefit Sub Type	Displays the benefit sub type.
Description	Displays the description of the benefit sub type.
Status	Indicates the status of the benefit sub type. The valid values are: <ul style="list-style-type: none"> • Active • Inactive
Value Type	Indicates the type of value that you want to store in the benefit sub type. The valid values are: <ul style="list-style-type: none"> • Flat • NA
Edit	On clicking the Edit () icon, the Benefit Sub Type screen appears where you can edit the details of the benefit sub type. <p>Note: The Edit icon appears only when the benefit sub type is not yet used.</p>

Column Name	Column Description
Duplicate	On clicking the Duplicate (📄) icon, the Benefit Sub Type screen appears where you can define a benefit sub type using an existing benefit sub type.
Delete	On clicking the Delete (🗑️) icon, you can delete a benefit sub type.

You can filter the list using various search criteria (such as **Benefit Sub Type, Status, Description, Value Type, Reconciliation Required, Price, and Validate**) available in the **Filter** area. By default, the **Filter** area is hidden. You can view the **Filter** area by clicking the **Filter** (🔍) icon in the upper right corner of this zone.

On clicking the **Broadcast** (📡) icon corresponding to the benefit sub type, the **Benefit Sub Type** zone appears with the details of the respective benefit sub type.

Note: Pagination is used to display limited number of records in this zone. You can use the navigation links, such as **Previous** and **Next** to navigate between pages.

Related Topics

For more information on...	See...
Benefit Sub Type zone	Benefit Sub Type on page 148
How to edit a benefit sub type	Editing a Benefit Sub Type on page 154
How to copy a benefit sub type	Copying a Benefit Sub Type on page 157
How to delete a benefit sub type	Deleting a Benefit Sub Type on page 160
How to view the details of a benefit sub type	Viewing the Details of a Benefit Sub Type on page 161

Benefit Sub Type

The **Benefit Sub Type** zone displays the details of the benefit sub type. It contains the following sections:

- **Main** - Displays the basic information about the benefit sub type. It contains the following fields:

Field Name	Field Description
Benefit Sub Type	Displays the benefit sub type.
Description	Displays the description of the benefit sub type.
Status	Indicates the status of the benefit sub type. The valid values are: <ul style="list-style-type: none"> • Active • Inactive
	Note: By default the Status option is selected.
Value Type	Indicates whether the benefit amount should be a flat or calculated amount. The valid values are: <ul style="list-style-type: none"> • Flat • Not applicable

Field Name	Field Description
Externally Priced	Indicates whether the benefit amount is calculated in the enrollment system.
	Note: This field appears when Flat option is selected from the Value Type list.
Charge Negatively	Indicates whether you want to create a negative charge for the benefit amount.
	Note: This field appears when the Flat option is selected from the Value Type list and the Externally Priced check box is not selected.
Benefit SQI	Indicates the SQI using which you want to create an SQI based billable charge for the benefit.
	Note: This field appears when the Flat option is selected from the Value Type list and the Externally Priced check box is not selected.
Charge Benefit Sponsor	Indicates whether you want to create a reverse charge for the benefit sponsor. The reverse charge can then be used by the health insurance payer for reconciliation.
	Note: This field appears when Flat option is selected from the Value Type list and
Validate External Price	Indicates that you want to validate whether the externally calculated benefit amount is within the threshold range.
	Note: This field appears when the Flat option is selected from the Value Type list and the Externally Priced check box is selected.
Validate Price Item	Indicates the price item that you have chosen to validate for the externally calculated benefit amount.
	<p>Note:</p> <p>It has a link. On clicking the link, the Price Item screen appears where you can view the details of the respective price item.</p> <p>This field appears when the Validate External Price check box is selected.</p>
Benefit Sponsor Account	Indicates the account of the sponsor on which you want to create the reverse charge.
	Note: This field appears when the Charge Benefit Sponsor check box is selected.
Benefit Sponsor Price Item	Indicates the price item using which you want to create the reverse charge.
	Note: This field appears when the Charge Benefit Sponsor check box is selected.

Field Name	Field Description
Benefit Sponsor SQI	Indicates the SQI using which you want to create the SQI based billable charge for the reverse charge.
	<p>Note:</p> <p>If you do not specify the value, the system will derive the SQI from the Proration SQI option type of the C1-ASOBLNG feature configuration.</p> <p>This field appears when the Charge Benefit Sponsor check box is selected.</p>

- **Characteristics** - Lists the characteristics defined for the benefit sub type. It contains the following columns:

Column Name	Column Description
Characteristic Type	Indicates the characteristic type.
Characteristic Value	Displays the value of the characteristic type.

- **Record Actions** - This section contains the following buttons:

Button Name	Button Description
Edit	Used to edit the details of the benefit sub type.
	<p>Note: The Edit button appears only when the benefit sub type is not yet used.</p>
Delete	Used to delete the benefit sub type.
Duplicate	Used to create a new benefit sub type using an existing benefit sub type.

- **Record Information** - This section contains the following fields:

Field Name	Field Description
Business Object	Indicates the business object using which the benefit sub type is created in the system. In addition, a context menu appears corresponding to this field which helps in navigating to other screens in the application.
	<p>Note: It has a link. On clicking the link, the Business Object screen appears where you can view the details of the respective business object.</p>

By default, the **Benefit Sub Type** zone does not appear in the **Benefit Sub Type** screen. It appears only when you click the **Broadcast** () icon corresponding to a benefit sub type in the **Benefit Sub Type List** zone.

Related Topics

For more information on...	See...
How to edit a benefit sub type	Editing a Benefit Sub Type on page 154
How to copy a benefit sub type	Copying a Benefit Sub Type on page 157
How to delete a benefit sub type	Deleting a Benefit Sub Type on page 160
How to view the details of a benefit sub type	Viewing the Details of a Benefit Sub Type on page 161

Defining a Benefit Sub Type

Prerequisites

To define a benefit sub type, you should have:

- Values defined in the **BENEFIT_SUB_TYPE_FLG**, **FIELD_STATUS_FLG**, and **VALUE_TYPE_FLG** lookup type.
- Values defined for the **Proration SQI** option type in the **C1-ASOBLNG** feature configuration.
- Benefit sub type business object defined in the application.

Procedure

To define a benefit sub type:

1. Click the **Admin** link in the **Application** toolbar.
A list appears.
2. From the **Admin** menu, select **B** and then click **Benefit Sub Type**.
A sub-menu appears.
3. Click the **Add** option from the **Benefit Sub Type** sub-menu.

The **Benefit Sub Type** screen appears. It contains the following sections:

- **Main** - Used to specify basic details about the benefit sub type. It contains the following fields:

Field Name	Field Description	Mandatory (Yes or No)
Benefit Sub Type	Used to specify the benefit sub type.	Yes
Description	Used to specify the description for the benefit sub type.	Yes
Status	Used to indicate the status of the benefit sub type. <ul style="list-style-type: none"> • Active • Inactive 	Yes
	Note: You cannot change the status of a benefit sub type to Inactive when the corresponding benefit is in Active status.	
Value Type	Used to indicate whether the benefit amount should be a flat or calculated amount. The valid values are: <ul style="list-style-type: none"> • Flat • Not Applicable 	Yes
Externally Priced	Used to indicate whether the benefit amount is calculated in the enrollment system.	No
	Note: This field appears when Flat option is selected from the Value Type list.	

Field Name	Field Description	Mandatory (Yes or No)
Charge Negatively	Used to indicate whether you want to create a negative charge for the benefit amount.	No
	Note: This field appears when the Flat option is selected from the Value Type list and the Externally Priced check box is not selected.	
Benefit SQI	Used to indicate the SQI using which you want to create an SQI based billable charge for the benefit.	No
	Note: This field appears when the Flat option is selected from the Value Type list and the Externally Priced check box is not selected.	
Charge Benefit Sponsor	Used to indicate whether you want to create a reverse charge for the benefit sponsor. The reverse charge can then be used by the health insurance payer for reconciliation.	No
	Note: This field appears when Flat option is selected from the Value Type list and	
Validate External Price	Used to indicate that you want to validate whether the externally calculated benefit amount is within the threshold range.	No
	Note: This field appears when the Flat option is selected from the Value Type list and the Externally Priced check box is selected.	
Validate Price Item	Used to indicate the price item that you want to validate for the externally calculated benefit amount.	Yes (Conditional)
	Note: The Search (🔍) icon appears corresponding to the Validate Price Item field. On clicking the Search icon, the Search window appears. This field appears when the Validate External Price check box is selected.	
Benefit Sponsor Account	Used to indicate the account of the sponsor on which you want to create the reverse charge.	Yes (Conditional)
	Note: The Search (🔍) icon appears corresponding to the Benefit Sponsor Account field. On clicking the Search icon, the Search window appears. This field appears when the Charge Benefit Sponsor check box is selected.	

Field Name	Field Description	Mandatory (Yes or No)
Benefit Sponsor Price Item	Used to indicate the price item using which you want to create the reverse charge.	No
	<p>Note:</p> <p>The Search (🔍) icon appears corresponding to the Benefit Sponsor Price Item field. On clicking the Search icon, the Search window appears.</p> <p>This field appears when the Charge Benefit Sponsor check box is selected.</p>	
Benefit Sponsor SQI	Used to indicate the SQI using which you want to create the SQI based billable charge for the reverse charge.	No
	<p>Note:</p> <p>If you do not specify the value, the system will derive the SQI from the Proration SQI option type of the C1-ASOBLNG feature configuration.</p> <p>This field appears when the Charge Benefit Sponsor check box is selected.</p>	

Tip: Alternatively, you can access the **Benefit Sub Type** screen by clicking the **Add** button in the **Page Title** area of the **Benefit Sub Type** screen.

- Enter the required details in the **Main** section.
- Click **Save**.

The benefit sub type is defined.

Related Topics

For more information on...	See...
Benefit Sub Type screen	Benefit Sub Type on page 147
How to define a characteristic for a benefit sub type	Defining a Characteristic for a Benefit Sub Type on page 153

Defining a Characteristic for a Benefit Sub Type

To define a characteristic for an benefit sub type, you should have:

- Characteristic types defined in the application (where the characteristic entity is set to **Benefit Sub Type**)

Procedure

To define a characteristic for a benefit sub type:

- Ensure that the **Characteristics** section is expanded when you are defining, editing, or copying a benefit sub type.

The **Characteristics** section contains the following fields:

Field Name	Field Description	Mandatory (Yes or No)
Characteristic Type	Used to indicate the characteristic type.	Yes (Conditional)
	Note: The list includes only those characteristic types where the characteristic entity is set to Benefit Sub Type .	Note: This field is required when you are defining the characteristics for a benefit sub type.
Characteristic Value	Used to specify the value for the characteristic type.	Yes (Conditional)
		Note: This field is required when you are defining the characteristics for a benefit sub type.

- Enter the required characteristic in the **Characteristics** section.
- If you want to define more than one characteristic for the benefit sub type, click the **Add (+)** icon and then repeat step 2.

Note: However, if you want to remove a characteristic from the benefit sub type, click the **Delete** (🗑️) icon corresponding to the characteristic

- Click **Save**.

The characteristic is defined for the benefit sub type.

Related Topics

For more information on...	See...
How to define a benefit sub type	Defining a Benefit Sub Type on page 151
How to edit a benefit sub type	Editing a Benefit Sub Type on page 154
How to copy a benefit sub type	Copying a Benefit Sub Type on page 157

Editing a Benefit Sub Type

Prerequisites

To edit a benefit sub type, you should have:

- Values defined in the **BENEFIT_SUB_TYPE_FLG**, **FIELD_STATUS_FLG**, and **VALUE_TYPE_FLG** lookup type.
- Values defined for the **Proration SQI** option type in the **C1-ASOBLNG** feature configuration.
- Benefit sub type business object defined in the application.

Procedure

To edit a benefit sub type:

- Click the **Admin** link in the **Application** toolbar.

A list appears.

- From the **Admin** menu, select **B** and then click **Benefit Sub Type**.

A sub-menu appears.

- Click the **Search** option from the **Benefit Sub Type** sub-menu.

The **Benefit Sub Type** screen appears.

- In the **Search Results** section, click the **Edit**  icon in the **Edit** column corresponding to the benefit sub type whose details you want to edit.

Note: The Edit icon appears only when a benefit is not defined using the benefit sub type.

The **Benefit Sub Type** screen appears. It contains the following sections:

- Main** - Used to specify the basic details about the benefit sub type. It contains the following fields:

Field Name	Field Description	Mandatory (Yes or No)
Benefit Sub Type	Displays the benefit sub type.	Not applicable
Description	Used to specify the description for the benefit sub type.	Yes
Status	Used to indicate the status of the benefit sub type. <ul style="list-style-type: none"> Active Inactive <p>Note: You can not change the status to a benefit sub type to Inactive when the corresponding benefit is in Active status.</p>	Yes
Value Type	Used to indicate whether the benefit amount should be a flat or calculated amount. The valid values are: <ul style="list-style-type: none"> Flat Not Applicable 	Yes
Externally Priced	Used to indicate whether the benefit amount is calculated in the enrollment system. <p>Note: This field appears when Flat option is selected from the Value Type list.</p>	No
Charge Negatively	Used to indicate whether you want to create a negative charge for the benefit amount. <p>Note: This field appears when the Flat option is selected from the Value Type list and the Externally Priced check box is not selected.</p>	No
Benefit SQI	Used to indicate the SQI using which you want to create an SQI based billable charge for the benefit. <p>Note: This field appears when the Flat option is selected from the Value Type list and the Externally Priced check box is not selected.</p>	No

Field Name	Field Description	Mandatory (Yes or No)
Charge Benefit Sponsor	Used to indicate whether you want to create a reverse charge for the benefit sponsor. The reverse charge can then be used by the health insurance payer for reconciliation. Note: This field appears when Flat option is selected from the Value Type list and	No
Validate External Price	Used to indicate that you want to validate whether the externally calculated benefit amount is within the threshold range. Note: This field appears when the Flat option is selected from the Value Type list and the Externally Priced check box is selected.	No
Validate Price Item	Used to indicate the price item that you want to validate for the externally calculated benefit amount. Note: The Search (🔍) icon appears corresponding to the Validate Price Item field. On clicking the Search icon, the Search window appears. This field appears when the Validate External Price check box is selected.	Yes (Conditional) Note: This field is required when the Validate External Price check box is selected.
Benefit Sponsor Account	Used to indicate the account of the sponsor on which you want to create the reverse charge. Note: The Search (🔍) icon appears corresponding to the Benefit Sponsor Account field. On clicking the Search icon, the Search window appears. This field appears when the Charge Benefit Sponsor check box is selected.	Yes (Conditional) Note: This field is required when the Charge Benefit Sponsor check box is selected.
Benefit Sponsor Price Item	Used to indicate the price item using which you want to create the reverse charge. Note: The Search (🔍) icon appears corresponding to the Benefit Sponsor Price Item field. On clicking the Search icon, the Search window appears. This field appears when the Charge Benefit Sponsor check box is selected.	No

Field Name	Field Description	Mandatory (Yes or No)
Benefit Sponsor SQI	Used to indicate the SQI using which you want to create the SQI based billable charge for the reverse charge.	No
	<p>Note:</p> <p>If you do not specify the value, the system will derive the SQI from the Proration SQI option type of the C1-ASOBLNG feature configuration.</p> <p>This field appears when the Charge Benefit Sponsor check box is selected.</p>	

Tip: Alternatively, you can edit the details of a benefit sub type by clicking the **Edit** button in the **Benefit Sub Type** zone.

5. Modify the required details in the **Main** section, if required.
6. Define, edit, or remove characteristics of the benefit sub type, if required
7. Click **Save**.

The changes made to the benefit sub type are saved.

Related Topics

For more information on...	See...
Benefit Sub Type screen	Benefit Sub Type on page 147
Benefit Sub Type List zone	Benefit Sub Type List on page 147
Benefit Sub Type zone	Benefit Sub Type on page 148
How to search for a benefit sub type	Searching a Benefit Sub Type
How to define a characteristic for a benefit sub type	Defining a Characteristic for a Benefit Sub Type on page 153

Copying a Benefit Sub Type

Instead of creating a benefit sub type from scratch, you can create a new benefit sub type using an existing benefit sub type. This is possible through copying a benefit sub type. On copying a benefit sub type, the details are copied to the new benefit sub type. You can then edit the details, if required.

Prerequisites

To define a benefit sub type, you should have:

- Values defined in the **BENEFIT_SUB_TYPE_FLG**, **FIELD_STATUS_FLG**, and **VALUE_TYPE_FLG** lookup type.
- Values defined for the **Proration SQI** option type in the **C1-ASOBLNG** feature configuration.
- Benefit sub type business object defined in the application.

Procedure

To copy a benefit sub type:

1. Click the **Admin** link in the **Application** toolbar.

A list appears.

- From the **Admin** menu, select **B** and then click **Benefit Sub Type**.

A sub-menu appears.

- Click the **Search** option from the **Benefit Sub Type** sub-menu.

The **Benefit Sub Type** screen appears.

- In the **Search Results** section, click the **Duplicate**  icon in the **Duplicate** column corresponding to the benefit sub type whose details you want to edit.

The **Benefit Sub Type** screen appears. It contains the following sections:

- Main** - Used to specify the basic details about the benefit sub type. It contains the following fields:

Field Name	Field Description	Mandatory (Yes or No)
Benefit Sub Type	Used to specify the benefit sub type.	Yes
Description	Used to specify the description for the benefit sub type.	Yes
Status	Used to indicate the status of the benefit sub type. <ul style="list-style-type: none"> Active Inactive 	Yes
	Note: You cannot change the status of a benefit sub type to Inactive when the corresponding benefit is in Active status.	
Value Type	Used to indicate whether the benefit amount should be a flat or calculated amount. The valid values are: <ul style="list-style-type: none"> Flat Not Applicable 	Yes
Externally Priced	Used to indicate whether the benefit amount is calculated in the enrollment system.	No
	Note: This field appears when Flat option is selected from the Value Type list.	
Charge Negatively	Used to indicate whether you want to create a negative charge for the benefit amount.	No
	Note: This field appears when the Flat option is selected from the Value Type list and the Externally Priced check box is not selected.	
Benefit SQI	Used to indicate the SQI using which you want to create an SQI based billable charge for the benefit.	No
	Note: This field appears when the Flat option is selected from the Value Type list and the Externally Priced check box is not selected.	

Field Name	Field Description	Mandatory (Yes or No)
Charge Benefit Sponsor	Used to indicate whether you want to create a reverse charge for the benefit sponsor. The reverse charge can then be used by the health insurance payer for reconciliation.	No
	Note: This field appears when Flat option is selected from the Value Type list and	
Validate External Price	Used to indicate that you want to validate whether the externally calculated benefit amount is within the threshold range.	No
	Note: This field appears when the Flat option is selected from the Value Type list and the Externally Priced check box is selected.	
Validate Price Item	Used to indicate the price item that you want to validate for the externally calculated benefit amount.	Yes (Conditional)
	Note: The Search (🔍) icon appears corresponding to the Validate Price Item field. On clicking the Search icon, the Search window appears. This field appears when the Validate External Price check box is selected.	Note: This field is required when the Validate External Price check box is selected.
Benefit Sponsor Account	Used to indicate the account of the sponsor on which you want to create the reverse charge.	Yes (Conditional)
	Note: The Search (🔍) icon appears corresponding to the Benefit Sponsor Account field. On clicking the Search icon, the Search window appears. This field appears when the Charge Benefit Sponsor check box is selected.	Note: This field is required when the Charge Benefit Sponsor check box is selected.
Benefit Sponsor Price Item	Used to indicate the price item using which you want to create the reverse charge.	No
	Note: The Search (🔍) icon appears corresponding to the Benefit Sponsor Price Item field. On clicking the Search icon, the Search window appears. This field appears when the Charge Benefit Sponsor check box is selected.	

Field Name	Field Description	Mandatory (Yes or No)
Benefit Sponsor SQI	Used to indicate the SQI using which you want to create the SQI based billable charge for the reverse charge. Note: If you do not specify the value, the system will derive the SQI from the Proration SQI option type of the C1-ASOBLNG feature configuration. This field appears when the Charge Benefit Sponsor check box is selected.	No

Tip: Alternatively, you can copy a benefit sub type by clicking the **Duplicate** button in the **Benefit Sub Type** zone.

- Define, edit or remove the required details in the **Main** section, if required.
- Click **Save**.

The new benefit sub type is saved.

Related Topics

For more information on...	See...
Benefit Sub Type screen	Benefit Sub Type on page 147
Benefit Sub Type List zone	Benefit Sub Type List on page 147
Benefit Sub Type zone	Benefit Sub Type on page 148
How to define a characteristic for a benefit sub type	Defining a Characteristic for a Benefit Sub Type on page 153

Deleting a Benefit Sub Type

Procedure

To delete a benefit sub type:

- Click the **Admin** link in the **Application** toolbar.
A list appears.
- From the **Admin** menu, select **B** and then click **Benefit Sub Type**.
A sub-menu appears.
- Click the **Search** option from the **Benefit Sub Type** sub-menu.
The **Benefit Sub Type** screen appears.
- In the **Benefit Sub Type List** zone, click the **Delete** () icon in the **Delete** column corresponding to the benefit sub type that you want to delete.
A message appears confirming whether you want to delete the benefit sub type.
- Click **OK**.
The benefit sub type is deleted.

Note: You can delete a benefit sub type only when a benefit is not defined using the benefit sub type.

Tip: Alternatively, you can delete a benefit sub type by clicking the **Delete** button in the **Benefit Sub Type** zone.

Related Topics

For more information on...	See...
Benefit Sub Type screen	Benefit Sub Type on page 147
Benefit Sub Type List zone	Benefit Sub Type List on page 147
Benefit Sub Type zone	Benefit Sub Type on page 148

Viewing the Details of a Benefit Sub Type

Procedure

To view the details of a benefit sub type :

1. Click the **Admin** link in the **Application** toolbar.
A list appears.
2. From the **Admin** menu, select **B** and then click **Benefit Sub Type**.
A sub-menu appears.
3. Click the **Search** option from the **Benefit Sub Type** sub-menu.
The **Benefit Sub Type** screen appears.
4. In the **Benefit Sub Type List** zone, click the **Broadcast** (📡) icon corresponding to the benefit sub type whose details you want to view:
The **Benefit Sub Type** zone appears.
5. View the details of a benefit sub type in the **Benefit Sub Type** zone.

Related Topics

For more information on...	See...
Benefit Sub Type screen	Benefit Sub Type on page 147
Benefit Sub Type List zone	Benefit Sub Type List on page 147
Benefit Sub Type zone	Benefit Sub Type on page 148

Benefit (Used for Searching)

The **Benefit** screen allows you to search for a Medicare benefit using various search criteria. It also allows you to create a Medicare benefit. It contains the following zone:

- [Search Benefit](#) on page 161

Search Benefit

The **Search Benefit** zone allows you to search for a benefit using various search criteria. It contains the following two sections:

- **Search Criteria** - The **Search Criteria** section contains the following fields:

Field Name	Field Description	Mandatory (Yes or No)
Search By	Used to indicate whether you want to search for a Medicare benefit using the benefit, policy, or person details. The valid values are: <ul style="list-style-type: none"> • Benefit Details • Policy Details • Person Details 	Yes
	Note: By default, the Benefit Details option is selected.	
Benefit ID	Used to search a particular Medicare benefit.	No
	Note: This field appears when the Benefit Details option is selected from the Search By list.	
Membership ID	Used to search Medicare benefits of the member persons who belong to a particular membership.	No
	Note: This field appears when the Benefit Details option is selected from the Search By list. The Search (🔍) icon appears corresponding to the Membership ID field. On clicking the Search icon, the Membership Search window appears.	
Start Date	Used to search Medicare benefits which are availed from a particular date onwards.	No
	Note: This field appears when the Benefit Details option is selected from the Search By list.	
End Date	Used to search Medicare benefits which are availed till a particular date.	No
	Note: This field appears when the Benefit Details option is selected from the Search By list.	
Status	Used to search Medicare benefits with a particular status. The valid values are: <ul style="list-style-type: none"> • Active • Discarded • Inactive 	No
	Note: This field appears when the Benefit Details option is selected from the Search By list.	

Field Name	Field Description	Mandatory (Yes or No)
Benefit Type	<p>Used to search benefits of a particular type. The valid values are:</p> <ul style="list-style-type: none"> • Commercial • Medicare Affiliated <p>Note: This field appears when the Benefit Details option is selected from the Search By list. At present, the Commercial benefit type is not supported. The implementation team can build the custom logic based on the business requirements.</p>	No
Benefit Sub Type	<p>Used to search a particular type of Medicare benefits.</p> <p>Note: This field appears when the Benefit Details option is selected from the Search By list. The list includes only those benefit types which are defined through the Benefit Sub Type screen.</p>	No
Benefit Source	<p>Used to search Medicare benefits which are received from a particular source. The valid values are:</p> <ul style="list-style-type: none"> • Centers for Medicare and Medicaid Services • State <p>Note: This field appears when the Benefit Details option is selected from the Search By list.</p>	No
Policy ID	<p>Used to search Medicare benefits which are availed under a particular fully-insured group policy.</p> <p>Note: This field appears when the Policy Details option is selected from the Search By list. The Search (🔍) icon appears corresponding to the Policy ID field. On clicking the Search icon, the Policy Search window appears.</p>	No

Field Name	Field Description	Mandatory (Yes or No)
Policy Plan ID	Used to search Medicare benefits which are availed under a particular fully-insured group policy plan.	No
	<p>Note:</p> <p>This field appears when the Policy Details option is selected from the Search By list.</p> <p>The Search (🔍) icon appears corresponding to the Policy Plan ID field. On clicking the Search icon, the Policy Plan Search window appears.</p>	
Membership Beneficiary ID	Used to search Medicare benefits which are availed by a particular Medicare beneficiary (i.e. member person).	No
	<p>Note: This field appears when the Person Details option is selected from the Search By list.</p>	
Person Name	Used to search Medicare benefits which are availed by a particular person.	No
	<p>Note: This field appears when the Person Details option is selected from the Search By list.</p>	
Person Identifier Type	Used to indicate the person identifier type.	Yes (Conditional)
	<p>Note: This field appears when the Person Details option is selected from the Search By list.</p>	
Person Identifier	Used to search Medicare benefits which are availed by a particular person.	Yes (Conditional)
	<p>Note: This field appears when the Person Details option is selected from the Search By list.</p>	
Relationship Type	Used to search Medicare benefits of member persons who are related to a main subscriber using a particular relationship type.	No
	<p>Note: This field appears when the Person Details option is selected from the Search By list.</p>	

Note: You must specify at least one search criterion while searching for a Medicare benefit.

- **Search Results** - On clicking the **Search** button, the search results appear based on the specified search criteria. The **Search Results** section contains the following columns:

Column Name	Column Description
Benefit Information	Displays information about the Medicare benefit.
	Note: It has a link. On clicking the link, the Benefit screen appears where you can view the details of the respective benefit.
Membership Information	Indicates the membership whose member person has availed the Medicare benefit.
	Note: It has a link. On clicking the link, the Membership screen appears where you can view the details of the respective membership.
Member Person Information	Indicates the member person who has availed the Medicare benefit. In addition, a context menu appears corresponding to this column which helps in navigating to other screens in application.
	Note: It has a link. On clicking the link, the Person screen appears where you can view the details of the respective member person.
Status	Indicates the status of the Medicare benefit. The valid values are: <ul style="list-style-type: none"> • Active • Discarded • Inactive
Benefit Source	Indicates the source from where the Medicare benefit is received. The valid values are: <ul style="list-style-type: none"> • Centers for Medicare and Medicaid Services • State
Benefit Type	Indicates the type of benefit. The valid values are: <ul style="list-style-type: none"> • Commercial • Medicare Affiliated
Benefit Sub Type	Indicates the type of Medicare benefit.
Benefit Amount	Displays the low income subsidy or late enrollment penalty amount for Medicare Part D.

Note: Pagination is used to display limited number of records in the **Search Results** section. You can use the navigation links, such as **Previous** and **Next** to navigate between pages.

Related Topics

For more information on...	See...
How to search for a Medicare benefit	Searching for a Medicare Benefit on page 166
How to view the details of a Medicare benefit	Viewing the Medicare Benefit Details on page 170
How to define a Medicare benefit	Defining a Medicare Benefit on page 166

Searching for a Medicare Benefit

Prerequisites

To search for a Medicare benefit, you should have:

- Values defined for the **BENEFIT_TYPE_FLG**, **BENEFIT_SUB_TYPE_FLG**, and **BENEFIT_SRC_FLG** lookup fields in the application.

Procedure

To search for a Medicare benefit:

1. Click the **Menu** link in the **Application** toolbar.
A list appears.
2. From the **Main** menu, select **Customer Management** and then click **Benefit**.
The **Benefit** screen appears.
3. Enter the search criteria in the **Search Benefit** zone.

Note: ORMB search engine supports wildcard search, where you can substitute the percentage (%) symbol as a stand in for any word or letter in a search criteria. You can use the ‘%’ wildcard character in all input fields except the date and ID fields. The ‘%’ wildcard character is suffixed automatically at the end of the partial search criteria. Therefore, you may or may not specify the wildcard character at the end of the partial search criteria. However, you have to prefix the wildcard character manually wherever required.

4. Click **Search**.

A list of Medicare benefits that meet the search criteria appears in the **Search Results** section.

Related Topics

For more information on...	See...
Benefit screen	Benefit (Used for Searching) on page 161
Search Benefit zone	Search Benefit on page 161

Defining a Medicare Benefit

Prerequisites

To define a Medicare benefit, you should have:

- Required membership defined in the application
- Required member person added to the membership in the application
- Values defined for the **BENEFIT_TYPE_FLG**, **BENEFIT_SUB_TYPE_FLG**, and **BENEFIT_SRC_FLG** lookup fields in the application
- Required Medicare plan benefit packages defined in the application

Procedure

To define a Medicare benefit:

1. Click the **Menu** link in the **Application** toolbar.
A list appears.
2. From the **Main** menu, select **Customer Management** and then click **Benefit**.
A sub-menu appears.
3. Click the **Add** option from the **Benefit** sub-menu.

The **Benefit** screen appears. It contains the following sections:

- **Main** - Used to specify basic details of the Medicare benefit.
- **Characteristics** - Used to define the characteristics for the Medicare benefit.

The **Main** section contains the following fields:

Field Name	Field Description	Mandatory (Yes or No)
Membership ID	Used to indicate the membership whose member person has availed the Medicare benefit.	Yes
	<p>Note:</p> <p>The Search  icon appears corresponding to the Membership ID field. On clicking the Search icon, the Membership Search window appears.</p> <p>On specifying the membership ID, the information about the membership appears corresponding to the Membership ID field.</p>	
Benefit Source	Used to indicate the source from where the Medicare benefit is received. The valid values are: <ul style="list-style-type: none"> • Centers for Medicare and Medicaid Services • State 	Yes
	<p>Note: The list includes only those benefit sources which are defined in the BENEFIT_SRC_FLG lookup field.</p>	
Benefit Type	Used to indicate the type of benefit. The valid value is: <ul style="list-style-type: none"> • Medicare Affiliated 	Yes
	<p>Note: The list includes only those benefit types which are defined in the BENEFIT_TYPE_FLG lookup field.</p>	
Benefit Sub Type	Used to indicate the type of Medicare benefit.	Yes
	<p>Note: The list includes only those benefit types which are defined through the Benefit Sub Type screen.</p>	
Medicare Plan Benefit Package	Used to indicate the medicare plan benefit package (i.e. 800 series plan) which is applicable for Medicare Part A, Part B, or Part D benefit.	Yes (Conditional)
	<p>Note: This field appears when the benefit sub type is set to Part A-Inpatient Hospital Coverage, Part B-Outpatient Medical Coverage, or Part D-Medicare Prescription Drug Coverage.</p>	
	<p>Note: This field is required when the benefit sub type is set to Part A-Inpatient Hospital Coverage, Part B-Outpatient Medical Coverage, or Part D-Medicare Prescription Drug Coverage.</p>	

Field Name	Field Description	Mandatory (Yes or No)
Start Date	Used to specify the date from when the member person has availed the Medicare benefit.	Yes
	<p>Note:</p> <p>The start date of the Medicare benefit cannot be earlier than the member person start date or later than the member person end date.</p> <p>The Medicare benefit start date cannot be later than the Medicare benefit end date.</p>	
End Date	Used to specify the date till when the member person has availed the Medicare benefit.	No
	<p>Note:</p> <p>The end date of the Medicare benefit cannot be earlier than the member person start date or later than the member person end date.</p> <p>The Medicare benefit end date cannot be earlier than the Medicare benefit start date.</p>	
Benefit Amount	Used to specify the low income subsidy or late enrollment penalty amount for Medicare Part D.	No
	<p>Note: This field appears when the benefit sub type is set to Late Enrollment Penalty or Low Income Subsidy.</p>	

Tip: Alternatively, you can access this screen by clicking the **Add** button in the **Page Title** area of the **Benefit** screen.

4. Enter the required details in the **Main** section.
5. Define characteristics for the Medicare benefit, if required.
6. Click **Save**.

The Medicare benefit is defined for the member person in the **Active** status.

Note: You cannot define more than one Medicare benefit for the same membership, member person, benefit source, benefit type, and benefit sub type combination.

Related Topics

For more information on...	See...
Benefit screen	Benefit (Used for Searching) on page 161
How to define a characteristic for a Medicare benefit	Defining a Characteristic for a Medicare Benefit on page 169
How to define a Medicare plan benefit package	Defining a Medicare Plan Benefit Package on page 186

Defining a Characteristic for a Medicare Benefit

Prerequisites

To define a characteristic for a Medicare benefit, you should have:

- Characteristic types defined in the application (where the characteristic entity is set to **Benefits**)

Procedure

To define a characteristic for a Medicare benefit:

1. Ensure that the **Characteristics** section is expanded when you are defining or editing a Medicare benefit.

The **Characteristics** section contains the following fields in a grid:

Field Name	Field Description	Mandatory (Yes or No)
Effective Date	Used to specify the date from when the characteristic is effective for the Medicare benefit.	Yes (Conditional)
		Note: This field is required while defining a characteristic for the Medicare benefit.
Characteristic Type	Used to indicate the characteristic type. Note: The list includes only those characteristic types where the characteristic entity is set to Benefits .	Yes (Conditional)
		Note: This field is required while defining a characteristic for the Medicare benefit.
Characteristic Value	Used to specify the value for the characteristic type. Note: If you select a predefined characteristic type, the Search (🔍) icon appears corresponding to the Characteristic Value field. On clicking the Search icon, you can search for a predefined characteristic value. On specifying the value for a predefined characteristic type, the description of the characteristic value appears corresponding to the Characteristic Value field.	Yes (Conditional)
		Note: This field is required while defining a characteristic for the Medicare benefit.

2. Enter the required details in the **Characteristics** section.
3. If you want to define more than one characteristic for the Medicare benefit, click the **Add** (+) icon and then repeat step 2.

Note: However, if you want to remove a characteristic of the Medicare benefit, click the **Delete** (🗑️) icon corresponding to the characteristic.

4. Click **Save**.

The characteristics are defined for the Medicare benefit.

Related Topics

For more information on...	See...
How to define a Medicare benefit	Defining a Medicare Benefit on page 166
How to edit a Medicare benefit	Editing a Medicare Benefit on page 173

Viewing the Medicare Benefit Details

Procedure

To view the details of a Medicare benefit:

1. Search for the Medicare benefit in the **Benefit** screen.
2. In the **Search Results** section, click the link in the **Benefit Information** column corresponding to the Medicare benefit whose details you want to view.
The **Benefit** screen appears.
3. Ensure that the **Main** tab is selected.
4. View the details of the Medicare benefit in the **Benefit** zone.
5. View the characteristics of the Medicare benefit in the **Benefit Characteristics** zone.

Related Topics

For more information on...	See...
How to search for a Medicare benefit	Searching for a Medicare Benefit on page 166
Benefit screen	Benefit (Used for Viewing) on page 170
Benefit zone	Benefit on page 171
Benefit Characteristics zone	Benefit Characteristics on page 172

Benefit (Used for Viewing)

Once you create a Medicare benefit, the **Benefit** screen allows you to:

- View the details of the Medicare benefit
- Edit the details of the Medicare benefit
- Discard the Medicare benefit
- View the log of the Medicare benefit
- Add a log entry for the Medicare benefit

It consists of the following tabs:

- [Benefit - Main](#) on page 170
- [Benefit - Log](#) on page 172

Benefit - Main

The **Main** tab displays information about the Medicare benefit. It contains the following zones:

- [Benefit](#) on page 171
- [Benefit Characteristics](#) on page 172

Benefit

The **Benefit** zone displays the details of the Medicare benefit. It contains the following sections:

- **Main** - Displays basic information about the Medicare benefit. It contains the following fields:

Field Name	Field Description
Benefit Information	Displays information about the Medicare benefit.
Membership Information	Indicates the membership whose member person has availed the Medicare benefit. Note: It has a link. On clicking the link, the Membership screen appears where you can view the details of the respective membership.
Benefit Source	Indicates the source from where the Medicare benefit is received. The valid values are: <ul style="list-style-type: none"> • Centers for Medicare and Medicaid Services • State
Benefit Type	Indicates the type of benefit. The valid value is: <ul style="list-style-type: none"> • Medicare Affiliated
Benefit Sub Type	Indicates the type of Medicare benefit.
Medicare Plan Benefit Package	Indicates the medicare plan benefit package (i.e. 800 series plan) which is applicable for Medicare Part A, Part B, or Part D benefit. Note: This field appears when the benefit sub type is set to Part A-Inpatient Hospital Coverage, Part B-Outpatient Medical Coverage, or Part D-Medicare Prescription Drug Coverage.
Start Date	Displays the date from when the member person has availed the Medicare benefit.
End Date	Displays the date till when the member person has availed the Medicare benefit.
Status	Indicates the status of the Medicare benefit. The valid values are: <ul style="list-style-type: none"> • Active • Discarded • Inactive
Benefit Amount	Displays the low income subsidy or late enrollment penalty amount for Medicare Part D. Note: This field appears when the benefit sub type is set to Late Enrollment Penalty or Low Income Subsidy.

- **Record Actions** - This section contains the following buttons:

Button Name	Button Description
Edit	Used to edit the details of the Medicare benefit. Note: The Edit button appears when the Medicare benefit is in the Active status.

Button Name	Button Description
Discard	Used to discard a Medicare benefit.
	Note: The Discard button appears when the benefit is in the Active or Inactive status.

- **Record Information** - This section contains the following fields:

Field Name	Field Description
Business Object	Indicates the business object using which the Medicare benefit is created. In addition, a context menu appears corresponding to this field which helps in navigating to other screens in the application. Note: It has a link. On clicking the link, the Business Object screen appears where you can view the details of the respective business object.
Status Date/Time	Displays the date and time when the Medicare benefit status is updated.
Create Date/Time	Displays the date and time when the Medicare benefit is created.

Related Topics

For more information on...	See...
How to edit a Medicare benefit	Editing a Medicare Benefit on page 173
How to discard a Medicare benefit	Discarding a Medicare Benefit on page 175

Benefit Characteristics

The **Benefit Characteristics** zone lists the characteristics of the Medicare benefit. It contains the following columns:

Column Name	Column Description
Effective Date	Displays the date from when the characteristic is effective for the Medicare benefit.
Characteristic Type	Indicates the characteristic type.
Characteristic Value	Displays the value of the characteristic type.
Description	Displays the description of the characteristic value. Note: The data appears in this column when the type of characteristic value is set to Predefined Value .

You can filter the list using the **Effective Date** field available in the **Filter** area. By default, the **Filter** area is hidden. You can view the **Filter** area by clicking the **Filters** (∨) icon in the upper right corner of this zone.

Benefit - Log

The **Log** tab contains the following zone:

- [Benefit Log](#) on page 172

Benefit Log

The **Benefit Log** zone lists the complete trail of actions performed on the Medicare benefit. It contains the following columns:

Column Name	Column Description
Creation Date Time	Displays the date and time when the action was performed on the Medicare benefit.
Details	Displays the details about the action performed on the Medicare benefit.
User	Indicates the user who has performed the action on the Medicare benefit.
Log Type	Indicates the type of log.
Related Object	Indicates the object or entity which is created when the action is performed on the Medicare benefit.
	Note: At present, no data appears in this column. The implementation team can build the custom logic to meet the business requirements.
Status Reason	Indicates the reason why the status of the Medicare benefit is changed.
	Note: At present, no data appears in this column. The implementation team can build the custom logic to meet the business requirements.

Note: You can manually add a log entry for the Medicare benefit by clicking the **Add Log Entry** link in the upper right corner of the **Benefit Log** zone.

Related Topics

For more information on...	See...
How to view the log of a Medicare benefit	Viewing the Log of a Medicare Benefit on page 175
How to add a log entry for a Medicare benefit	Adding a Log Entry for a Medicare Benefit on page 176

Editing a Medicare Benefit

You can only edit the characteristics of a Medicare benefit from the user interface. On editing a Medicare benefit of a member person, the system inactivates the old record and creates a new record in the system. The status of the old benefit record is set to **Inactive** and the status of the new benefit record is set to **Active**.

Procedure

To edit a Medicare benefit:

1. Search for the Medicare benefit in the **Benefit** screen.
2. In the **Search Results** section, click the link in the **Benefit Information** column corresponding to the Medicare benefit whose details you want to edit.

The **Benefit** screen appears.

3. Ensure that the **Main** tab is selected.
4. Click the **Edit** button in the **Benefit** zone.

The **Benefit** screen appears. It contains the following sections:

- **Main** - Displays basic details of the Medicare benefit.
- **Characteristics** - Used to define the characteristics for the Medicare benefit.

The **Main** section contains the following fields:

Field Name	Field Description
Benefit Information	Displays information about the Medicare benefit.
Membership Information	Indicates the membership whose member person has availed the Medicare benefit.
Benefit Source	Indicates the source from where the Medicare benefit is received. The valid values are: <ul style="list-style-type: none"> Centers for Medicare and Medicaid Services State
Benefit Type	Indicates the type of benefit. The valid values are: <ul style="list-style-type: none"> Commercial Medicare Affiliated
Benefit Sub Type	Indicates the type of Medicare benefit. Note: The list includes only those benefit types which are defined through the Benefit Sub Type screen.
Medicare Plan Benefit Package	Indicates the medicare plan benefit package (i.e. 800 series plan) which is applicable for Medicare Part A, Part B, or Part D benefit. Note: This field appears when the benefit sub type is set to Part A-Inpatient Hospital Coverage, Part B-Outpatient Medical Coverage, or Part D-Medicare Prescription Drug Coverage.
Start Date	Displays the date from when the member person has availed the Medicare benefit.
End Date	Displays the date till when the member person has availed the Medicare benefit. Note: The system enables you to edit the end date of a Medicare benefit through a health care inbound message or through the membership repricing inbound web service.
Benefit Amount	Displays the low income subsidy or late enrollment penalty amount for Medicare Part D. Note: This field appears when the benefit sub type is set to Late Enrollment Penalty or Low Income Subsidy. The system enables you to edit the amount of a Medicare benefit through a health care inbound message or through the membership repricing inbound web service.

Note: The **Edit** button appears when the Medicare benefit is in the **Active** status.

- Define, edit, or remove characteristics of the Medicare benefit, if required.
- Click **Save**.

The changes made to the Medicare benefit are saved.

Related Topics

For more information on...	See...
How to search for a Medicare benefit	Searching for a Medicare Benefit on page 166
Benefit screen	Benefit (Used for Viewing) on page 170
Benefit zone	Benefit on page 171
How to define a characteristic for a Medicare benefit	Defining a Characteristic for a Medicare Benefit on page 169

Discarding a Medicare Benefit

Procedure

To discard a Medicare benefit:

1. Search for the Medicare benefit in the **Benefit** screen.
2. In the **Search Results** section, click the link in the **Benefit Information** column corresponding to the Medicare benefit that you want to discard.

The **Benefit** screen appears.

3. Ensure that the **Main** tab is selected.
4. Click the **Discard** button in the **Benefit** zone.

The status of the Medicare benefit is changed to **Discarded**.

Note: The **Discard** button appears when the Medicare benefit is in the **Active** or **Inactive** status.

Related Topics

For more information on...	See...
How to search for a Medicare benefit	Searching for a Medicare Benefit on page 166
Benefit screen	Benefit (Used for Viewing) on page 170
Benefit zone	Benefit on page 171

Viewing the Log of a Medicare Benefit

Procedure

To view the log of a Medicare benefit:

1. Search for the Medicare benefit in the **Benefit** screen.
2. In the **Search Results** section, click the link in the **Benefit Information** column corresponding to the Medicare benefit whose details you want to view.

The **Benefit** screen appears.

3. Click the **Log** tab.

The **Log** tab appears.

4. View the complete trail of actions performed on the Medicare benefit in the **Benefit Log** zone.

Related Topics

For more information on...	See...
How to search for a Medicare benefit	Searching for a Medicare Benefit on page 166
Benefit screen	Benefit (Used for Viewing) on page 170
Benefit Log zone	Benefit Log on page 172
How to add a log entry for a Medicare benefit	Adding a Log Entry for a Medicare Benefit on page 176

Adding a Log Entry for a Medicare Benefit

Procedure

To add a log entry for a Medicare benefit:

1. Search for the Medicare benefit in the **Benefit** screen.
2. In the **Search Results** section, click the link in the **Benefit Information** column corresponding to the Medicare benefit whose log you want to edit.

The **Benefit** screen appears.

3. Click the **Log** tab.

The **Log** tab appears.

4. Click the **Add Log Entry** link in the upper right corner of the **Benefit Log** zone.

The **Add Benefit Log** window appears. It contains the following fields:

Field Name	Field Description	Mandatory (Yes or No)
Benefit Information	Displays information about the Medicare benefit.	Not applicable
Log Details	Used to specify additional comments for the Medicare benefit.	Yes

5. Enter the comments in the **Log Details** field.

6. Click **Save**.

The log entry is added in the **Benefit Log** zone.

Related Topics

For more information on...	See...
How to search for a Medicare benefit	Searching for a Medicare Benefit on page 166
Benefit screen	Benefit (Used for Viewing) on page 170
Benefit Log zone	Benefit Log on page 172

Medicare Preference

The Medicare preference enables you to set the attributes which are used while creating charges for Medicare Part D Low Income Subsidy (LIS) and Late Enrollment Penalty (LEP). While deriving the LIS and LEP details, the system uses the following attributes from the medicare preference:

- Late Enrollment Penalty
- Low Income Subsidy

- Medicare Prescription Drug Coverage

For more information about these attributes, see [Defining a Medicare Preference](#) on page 178.

The system considers the medicare preference which is specified in the **Medicare** option type of the **C1-ASOBLLNG** feature configuration. You can define, edit, delete, and copy a medicare preference through the **Field Mapping** screen.

Related Topics

For more information on...	See...
How to setup the C1-ASOBLLNG feature configuration	Setting the C1-ASOBLLNG Feature Configuration on page 3421

Searching for a Medicare Preference

Prerequisites

To search for a medicare preference, you should have:

- Values defined in the **FIELD_CAT_FLG** lookup field

Procedure

To search for a medicare preference:

1. Click the **Admin** link in the **Application** toolbar.
A list appears.
2. From the **Admin** menu, select **F** and then click **Field Mapping**.
A sub-menu appears.
3. Click the **Search** option from the **Field Mapping** sub-menu.
The **Field Mapping** screen appears.
4. Select the **Medicare** option from the **Preference Category** list.
5. Enter the additional search criteria in the **Search Field Mapping** zone.

Note: ORMB search engine supports wildcard search, where you can substitute the percentage (%) symbol as a stand in for any word or letter in a search criteria. You can use the ‘%’ wildcard character in all input fields except the date and ID fields. The ‘%’ wildcard character is suffixed automatically at the end of the partial search criteria. Therefore, you may or may not specify the wildcard character at the end of the partial search criteria. However, you have to prefix the wildcard character manually wherever required.

6. Click **Search**.

A list of medicare preferences that meet the search criteria appears in the **Search Results** section.

Viewing the Medicare Preference Details

Procedure

To view the details of a medicare preference:

1. Search for the medicare preference in the **Field Mapping** screen.
2. In the **Search Results** section, click the **Broadcast** (📡) icon corresponding to the medicare preference whose details you want to view.
The **Field Mapping** zone appears.
3. View the details of the medicare preference in the **Field Mapping** zone.

Related Topics

For more information on...	See...
How to search for a medicare preference	Searching for a Medicare Preference on page 177

Defining a Medicare Preference

Prerequisites

To define a medicare preference, you should have:

- Values defined in the **MAP_ENTITY_FLG** lookup field
- Value defined for the **Medicare** option type in the **C1-ASOBLLNG** feature configuration.

Procedure

To define a medicare preference:

1. Click the **Admin** link in the **Application** toolbar.
A list appears.
2. From the **Admin** menu, select **F** and then click **Field Mapping**.
A sub-menu appears.
3. Click the **Add** option from the **Field Mapping** sub-menu.

The **Select Business Object** screen appears. It contains the following field:

Field Name	Field Description	Mandatory (Yes or No)
Field Mapping Business Object	Used to indicate the business object using which you want to create the billing preference. The valid values are: <ul style="list-style-type: none"> • Field Mapping • Medicare Plan Benefit Package • Membership Status Reason Mapping 	Yes

Note: Alternatively, you can access the **Select Business Object** screen by clicking the **Add** button in the **Page Title** area of the **Field Mapping** screen.

4. Select the **Field Mapping** option from the **Field Mapping Business Object** list.
5. Click **OK**.

The **Field Mapping** screen appears. It contains the following sections:

- **Main** - Used to specify basic details of the billing preference. It contains the following fields:

Field Name	Field Description	Mandatory (Yes or No)
Preference	Used to specify the billing preference.	Yes
Description	Used to specify the description for the billing preference.	Yes
Detailed Description	Used to specify additional information about the billing preference.	No

Field Name	Field Description	Mandatory (Yes or No)
Status	Used to indicate the status of the billing preference. The valid values are: <ul style="list-style-type: none"> Active Inactive 	Yes

- **Preference Category** - This section contains the following field:

Field Name	Field Description	Mandatory (Yes or No)
Preference Category	Used to indicate the category to which the preference belongs. The valid values are: <ul style="list-style-type: none"> Billing Binder Payment Geographic Rating Area Individual Membership Medicare Medicare Plan Benefit Member Reconciliation Member Relationship and Subscription Tier Membership Status Reason Statement Construct 	Yes

- **Preference Settings** - Used to set the attributes in the billing preference. It contains the following fields in a grid:

Field Name	Field Description	Mandatory (Yes or No)
Attribute	Used to indicate the attribute which you want to set in the medicare preference. The valid values are: <ul style="list-style-type: none"> Late Enrollment Penalty - Used when you want to indicate the benefit sub type for LEP in the medicare preference. Low Income Subsidy - Used when you want to indicate the benefit sub type for LIS in the medicare preference. Medicare Prescription Drug Coverage - Used when you want to indicate the benefit sub type for Medicare Part D in the medicare preference. 	Yes (Conditional) <div style="border: 1px solid black; padding: 5px; margin-top: 5px;"> Note: This field is required while setting an attribute in the medicare preference. </div>

Field Name	Field Description	Mandatory (Yes or No)								
Value	Used to specify the attribute value. The attribute value that you can specify varies depending on the attribute you want to set in the billing preference:	Yes (Conditional)								
	<table border="1"> <thead> <tr> <th>If the attribute is set to...</th> <th>Then, this field is...</th> </tr> </thead> <tbody> <tr> <td>Late Enrollment Penalty</td> <td>Used to specify the benefit sub type for which the member person incurs the late enrollment penalty.</td> </tr> <tr> <td>Low Income Subsidy</td> <td>Used to specify the benefit sub type for which the member person is qualified.</td> </tr> <tr> <td>Medicare Prescription Drug Coverage</td> <td>Used to specify the benefit sub type availed by the member person.</td> </tr> </tbody> </table>	If the attribute is set to...	Then, this field is...	Late Enrollment Penalty	Used to specify the benefit sub type for which the member person incurs the late enrollment penalty.	Low Income Subsidy	Used to specify the benefit sub type for which the member person is qualified.	Medicare Prescription Drug Coverage	Used to specify the benefit sub type availed by the member person.	Note: This field is required while setting an attribute in the medicare preference.
	If the attribute is set to...	Then, this field is...								
	Late Enrollment Penalty	Used to specify the benefit sub type for which the member person incurs the late enrollment penalty.								
Low Income Subsidy	Used to specify the benefit sub type for which the member person is qualified.									
Medicare Prescription Drug Coverage	Used to specify the benefit sub type availed by the member person.									
Entity Type	Used to indicate the type of entity for which the attribute is applicable. The valid values are: <ul style="list-style-type: none"> • Account • Billable Charge 	No								
	Note: At present, this data is stored for informational purposes only and is not considered in the business logic. If required, you can add more entity types to the MAP_ENTITY_FLG lookup field.									

Note: While defining a medicare preference, you must set at least one attribute in the billing preference.

6. Select the **Medicare** option from the **Preference Category** list.
7. Enter the required details in the **Main** section.
8. Select the required attribute and value from the respective fields.
9. If you want to set more than one attribute in the medicare preference, click the **Add (+)** icon and then repeat step 8.

Note: However, if you want to remove an attribute from the medicare preference, click the **Delete** (🗑️) icon corresponding to the attribute.

10. Click **Save**.

The medicare preference is defined.

Editing a Medicare Preference

Prerequisites

To edit a medicare preference, you should have:

- Values defined in the **MAP_ENTITY_FLG** lookup field
- Value defined for the **Medicare** option type in the **C1-ASOBLNG** feature configuration.

Procedure

To edit a medicare preference:

1. Search for the medicare preference in the **Field Mapping** screen.
2. In the **Search Results** section, click the **Edit** (✎) icon in the **Edit** column corresponding to the medicare preference whose details you want to edit.

The **Field Mapping** screen appears. It contains the following sections:

- **Main** - Used to specify basic details of the medicare preference. It contains the following fields:

Field Name	Field Description	Mandatory (Yes or No)
Preference	Displays the medicare preference.	Not applicable
Description	Used to specify the description for the medicare preference.	Yes
Detailed Description	Used to specify additional information about the medicare preference.	No
Status	Used to indicate the status of the medicare preference. The valid values are: <ul style="list-style-type: none"> • Active • Inactive 	Yes
Preference Category	Indicates the category to which the preference belongs. The valid value is: <ul style="list-style-type: none"> • Medicare 	Not applicable

- **Preference Settings** - Used to set the attributes in the medicare preference. It contains the following fields in a grid:

Field Name	Field Description	Mandatory (Yes or No)
Attribute	Used to indicate the attribute which you want to set in the medicare preference. The valid values are: <ul style="list-style-type: none"> • Late Enrollment Penalty - Used when you want to indicate the benefit sub type for LEP in the medicare preference. • Low Income Subsidy - Used when you want to indicate the benefit sub type for LIS in the medicare preference. • Medicare Prescription Drug Coverage - Used when you want to indicate the benefit sub type for Medicare Part D in the medicare preference. 	Yes (Conditional) Note: This field is required while setting an attribute in the medicare preference.

Field Name	Field Description	Mandatory (Yes or No)								
Value	Used to specify the attribute value. The attribute value that you can specify varies depending on the attribute you want to set in the medicare preference:	Yes (Conditional) Note: This field is required while setting an attribute in the medicare preference.								
	<table border="1"> <thead> <tr> <th>If the attribute is set to...</th> <th>Then, this field is...</th> </tr> </thead> <tbody> <tr> <td>Late Enrollment Penalty</td> <td>Used to specify the benefit sub type for which the member person incurs late enrollment penalty.</td> </tr> <tr> <td>Low Income Subsidy</td> <td>Used to specify the benefit sub type for which the member person is qualified.</td> </tr> <tr> <td>Medicare Prescription Drug Coverage</td> <td>Used to specify the benefit sub type availed by the member person.</td> </tr> </tbody> </table>		If the attribute is set to...	Then, this field is...	Late Enrollment Penalty	Used to specify the benefit sub type for which the member person incurs late enrollment penalty.	Low Income Subsidy	Used to specify the benefit sub type for which the member person is qualified.	Medicare Prescription Drug Coverage	Used to specify the benefit sub type availed by the member person.
	If the attribute is set to...		Then, this field is...							
	Late Enrollment Penalty		Used to specify the benefit sub type for which the member person incurs late enrollment penalty.							
	Low Income Subsidy		Used to specify the benefit sub type for which the member person is qualified.							
Medicare Prescription Drug Coverage	Used to specify the benefit sub type availed by the member person.									
Entity Type	Used to indicate the type of entity for which the attribute is applicable. The valid values are: <ul style="list-style-type: none"> Account Billable Charge <p>Note: At present, this data is stored for informational purposes only and is not considered in the business logic. If required, you can add more entity types to the MAP_ENTITY_FLG lookup field.</p>	No								

Tip: Alternatively, you can edit the details of a medicare preference by clicking the **Edit** button in the **Field Mapping** zone.

3. Modify the required details in the **Main** section.
4. Define, edit, or remove the attribute from the medicare preference, if required.

Note: You must set at least one attribute in a medicare preference.

5. Click **Save**.

The changes made to the medicare preference are saved.

Related Topics

For more information on...	See...
How to search for a medicare preference	Searching for a Medicare Preference on page 177

Copying a Medicare Preference

Instead of creating a medicare preference from scratch, you can create a new medicare preference using an existing medicare preference. This is possible through copying a medicare preference. On copying a medicare preference, the details including the attributes are copied to the new medicare preference. You can then edit the details, if required.

Prerequisites

To copy a medicare preference, you should have:

- Medicare preference (whose copy you want to create) defined in the application
- Values defined in the **MAP_ENTITY_FLG** lookup field
- Value defined for the **Medicare** option type in the **C1-ASOBLNG** feature configuration.

Procedure

To copy a medicare preference:

1. Search for the medicare preference in the **Field Mapping** screen.
2. In the **Search Results** section, click the **Duplicate**  icon in the **Duplicate** column corresponding to the medicare preference whose copy you want to create.

The **Field Mapping** screen appears. It contains the following sections:

- **Main** - Used to specify basic details of the medicare preference. It contains the following fields:

Field Name	Field Description	Mandatory (Yes or No)
Preference	Used to specify the medicare preference.	Yes
Description	Used to specify the description for the medicare preference.	Yes
Detailed Description	Used to specify additional information about the medicare preference.	No
Status	Used to indicate the status of the medicare preference. The valid values are: <ul style="list-style-type: none"> • Active • Inactive 	Yes
Preference Category	Used to indicate the category to which the preference belongs. The valid values are: <ul style="list-style-type: none"> • Medicare 	Not applicable

- **Preference Settings** - Used to set the attributes in the medicare preference. It contains the following fields in a grid:

Field Name	Field Description	Mandatory (Yes or No)								
Attribute	<p>Used to indicate the attribute which you want to set in the medicare preference. The valid values are:</p> <ul style="list-style-type: none"> • Late Enrollment Penalty - Used when you want to indicate the benefit sub type for LEP in the medicare preference. • Low Income Subsidy - Used when you want to indicate the benefit sub type for LIS in the medicare preference. • Medicare Prescription Drug Coverage - Used when you want to indicate the benefit sub type for Medicare Part D in the medicare preference. 	<p>Yes (Conditional)</p> <p>Note: This field is required while setting an attribute in the medicare preference.</p>								
Value	<p>Used to specify the attribute value. The attribute value that you can specify varies depending on the attribute you want to set in the billing preference:</p> <table border="1"> <thead> <tr> <th>If the attribute is set to...</th> <th>Then, this field is...</th> </tr> </thead> <tbody> <tr> <td>Late Enrollment Penalty</td> <td>Used to specify the benefit sub type for which the member person incurs the late enrollment penalty.</td> </tr> <tr> <td>Low Income Subsidy</td> <td>Used to specify the benefit sub type for which the member person is qualified.</td> </tr> <tr> <td>Medicare Prescription Drug Coverage</td> <td>Used to specify the benefit sub type availed by the member person.</td> </tr> </tbody> </table>	If the attribute is set to...	Then, this field is...	Late Enrollment Penalty	Used to specify the benefit sub type for which the member person incurs the late enrollment penalty.	Low Income Subsidy	Used to specify the benefit sub type for which the member person is qualified.	Medicare Prescription Drug Coverage	Used to specify the benefit sub type availed by the member person.	<p>Yes (Conditional)</p> <p>Note: This field is required while setting an attribute in the medicare preference.</p>
If the attribute is set to...	Then, this field is...									
Late Enrollment Penalty	Used to specify the benefit sub type for which the member person incurs the late enrollment penalty.									
Low Income Subsidy	Used to specify the benefit sub type for which the member person is qualified.									
Medicare Prescription Drug Coverage	Used to specify the benefit sub type availed by the member person.									
Entity Type	<p>Used to indicate the type of entity for which the attribute is applicable. The valid values are:</p> <ul style="list-style-type: none"> • Account • Billable Charge <p>Note: At present, this data is stored for informational purposes only and is not considered in the business logic. If required, you can add more entity types to the MAP_ENTITY_FLG lookup field.</p>	No								

Note: While defining a medicare preference, you must set at least one attribute in the medicare preference.

Tip: Alternatively, you can copy a medicare preference by clicking the **Duplicate** button in the **Field Mapping** zone.

3. Enter the required details in the **Main** section.
4. Define, edit, or remove the attribute from the medicare preference, if required.
5. Click **Save**.

The new medicare preference is defined.

Related Topics

For more information on...	See...
How to search for a medicare preference	Searching for a Medicare Preference on page 177

Deleting a Medicare Preference

Procedure

To delete a medicare preference:

1. Search for the medicare preference in the **Field Mapping** screen.
2. In the **Search Results** section, click the **Delete** (🗑️) icon in the **Delete** column corresponding to the medicare preference that you want to delete.

A message appears confirming whether you want to delete the medicare preference.

Tip: Alternatively, you can delete a medicare preference by clicking the **Delete** button in the **Field Mapping** zone.

3. Click **OK**.

The medicare preference is deleted.

Related Topics

For more information on...	See...
How to search for a medicare preference	Searching for a Medicare Preference on page 177

Medicare Plan Benefit Package

You can define an Employer Group Waiver Plan (EGWP) (i.e. 800 series plan) as a Medicare plan benefit package in the system. While defining a Medicare benefit of a member person for Medicare Part A, Part B, and Part D, you need to indicate the Medicare plan benefit package which is applicable for the Medicare benefit. You can then use the Medicare plan benefit package as a pricing parameter in the age based or tier based pricing rules using which the Medicare premium is calculated. In this way, the system enables you to offer different pricing for different EGWPs (i.e. 800 series plans).

The system enables you to define, edit, delete, and copy a Medicare plan benefit package through the **Field Mapping** screen.

Searching for a Medicare Plan Benefit Package

Prerequisites

To search for a Medicare plan benefit package, you should have:

- Values defined in the **FIELD_CAT_FLG** lookup field

Procedure

To search for a Medicare plan benefit package:

1. Click the **Admin** link in the **Application** toolbar.

A list appears.

- From the **Admin** menu, select **F** and then click **Field Mapping**.

A sub-menu appears.

- Click the **Search** option from the **Field Mapping** sub-menu.

The **Field Mapping** screen appears.

- Select the **Medicare Plan Benefit** option from the **Preference Category** list.
- Enter the additional search criteria in the **Search Field Mapping** zone.

Note: ORMB search engine supports wildcard search, where you can substitute the percentage (%) symbol as a stand in for any word or letter in a search criteria. You can use the ‘%’ wildcard character in all input fields except the date and ID fields. The ‘%’ wildcard character is suffixed automatically at the end of the partial search criteria. Therefore, you may or may not specify the wildcard character at the end of the partial search criteria. However, you have to prefix the wildcard character manually wherever required.

- Click **Search**.

A list of Medicare plan benefit packages that meet the search criteria appears in the **Search Results** section.

Viewing the Medicare Plan Benefit Package Details

Procedure

To view the details of a Medicare plan benefit package:

- Search for the Medicare plan benefit package in the **Field Mapping** screen.
- In the **Search Results** section, click the **Broadcast** () icon corresponding to the Medicare plan benefit package whose details you want to view.
The **Field Mapping** zone appears.
- View the details of the Medicare plan benefit package in the **Field Mapping** zone.

Related Topics

For more information on...	See...
How to search for a Medicare plan benefit package	Searching for a Medicare Plan Benefit Package on page 185

Defining a Medicare Plan Benefit Package

Procedure

To define a Medicare plan benefit package:

- Click the **Admin** link in the **Application** toolbar.
A list appears.
- From the **Admin** menu, select **F** and then click **Field Mapping**.
A sub-menu appears.
- Click the **Add** option from the **Field Mapping** sub-menu.
The **Select Business Object** screen appears. It contains the following field:

Field Name	Field Description	Mandatory (Yes or No)
Field Mapping Business Object	Used to indicate the business object using which you want to create the Medicare plan benefit package. The valid values are: <ul style="list-style-type: none"> Field Mapping Medicare Plan Benefit Package Membership Status Reason Mapping 	Yes

Note: Alternatively, you can access the **Select Business Object** screen by clicking the **Add** button in the **Page Title** area of the **Field Mapping** screen.

- Select the **Medicare Plan Benefit Package** option from the **Field Mapping Business Object** list.
- Click **OK**.

The **Medicare Plan Benefit Package** screen appears. It contains the following section:

- Main** - Used to specify basic details of the Medicare plan benefit package. It contains the following fields:

Field Name	Field Description	Mandatory (Yes or No)
Medicare Plan Benefit Package	Used to specify the Medicare plan benefit package (i.e. 800 series plan).	Yes
Description	Used to specify the description for the Medicare plan benefit package.	Yes

- Enter the required details in the **Main** section.
- Click **Save**.

The Medicare plan benefit package is defined.

Editing a Medicare Plan Benefit Package

Procedure

To edit a Medicare plan benefit package:

- Search for the Medicare plan benefit package in the **Field Mapping** screen.
- In the **Search Results** section, click the **Edit**  icon in the **Edit** column corresponding to the Medicare plan benefit package whose details you want to edit.

The **Medicare Plan Benefit Package** screen appears. It contains the following section:

- Main** - Used to specify basic details of the Medicare plan benefit package. It contains the following fields:

Field Name	Field Description	Mandatory (Yes or No)
Medicare Plan Benefit Package	Displays the Medicare plan benefit package (i.e. 800 series plan).	Not applicable
Description	Used to specify the description for the Medicare plan benefit package.	Yes

Tip: Alternatively, you can edit the details of a Medicare plan benefit package by clicking the **Edit** button in the **Field Mapping** zone.

3. Modify the required details in the **Main** section.
4. Click **Save**.

The changes made to the Medicare plan benefit package are saved.

Related Topics

For more information on...	See...
How to search for a Medicare plan benefit package	Searching for a Medicare Plan Benefit Package on page 185

Copying a Medicare Plan Benefit Package

Instead of creating a Medicare plan benefit package from scratch, you can create a new Medicare plan benefit package using an existing Medicare plan benefit package. This is possible through copying a Medicare plan benefit package. On copying a Medicare plan benefit package, the details are copied to the new Medicare plan benefit package. You can then edit the details, if required.

Prerequisites

To copy a Medicare plan benefit package, you should have:

- Medicare plan benefit package (whose copy you want to create) defined in the application

Procedure

To copy a Medicare plan benefit package:

1. Search for the Medicare plan benefit package in the **Field Mapping** screen.
2. In the **Search Results** section, click the **Duplicate**  icon in the **Duplicate** column corresponding to the Medicare plan benefit package whose copy you want to create.

The **Medicare Plan Benefit Package** screen appears. It contains the following section:

- **Main** - Used to specify basic details of the Medicare plan benefit package. It contains the following fields:

Field Name	Field Description	Mandatory (Yes or No)
Medicare Plan Benefit Package	Used to specify the Medicare plan benefit package (i.e. 800 series plan).	Yes
Description	Used to specify the description for the Medicare plan benefit package.	Yes

Tip: Alternatively, you can copy a Medicare plan benefit package by clicking the **Duplicate** button in the **Field Mapping** zone.

3. Enter the required details in the **Main** section.
4. Click **Save**.

The new Medicare plan benefit package is defined.

Related Topics

For more information on...	See...
How to search for a Medicare plan benefit package	Searching for a Medicare Plan Benefit Package on page 185

Deleting a Medicare Plan Benefit Package

Procedure

To delete a Medicare plan benefit package:

1. Search for the Medicare plan benefit package in the **Field Mapping** screen.
2. In the **Search Results** section, click the **Delete** (🗑️) icon in the **Delete** column corresponding to the Medicare plan benefit package that you want to delete.

A message appears confirming whether you want to delete the Medicare plan benefit package.

Tip: Alternatively, you can delete a Medicare plan benefit package by clicking the **Delete** button in the **Field Mapping** zone.

3. Click **OK**.

The Medicare plan benefit package is deleted.

Related Topics

For more information on...	See...
How to search for a Medicare plan benefit package	Searching for a Medicare Plan Benefit Package on page 185

Geographic Rating Area Preference

Oracle Revenue Management and Billing enables you to use the geographic rating area as a pricing parameter while defining the age based, tier based, and additional charge pricing rules. This feature facilitates you to offer different rates for a price item based on different geographic rating area.

Once you define a geographic rating area, the system can derive the geographic rating area for a membership. While deriving the geographic rating area for a membership, the system uses the following attributes from the geographic rating area preference:

- Address Source Characteristic Type
- Address Type Characteristic Type
- Default Address Source
- Default Address Type
- Default Geographic Rating Area
- Geographic Rating Area Characteristic Type
- Use Plan Details

For more information about these attributes, see [Defining a Geographic Rating Area Preference](#) on page 191.

The system considers the geographic rating area preference which is specified in the **Rating Area Field Mapping for Group** option type of the **C1-ASOBLNG** feature configuration. You can define, edit, delete, and copy a geographic rating area preference through the **Field Mapping** screen.

Related Topics

For more information on...	See...
How to setup the C1-ASOBLLNG feature configuration	Setting the C1-ASOBLLNG Feature Configuration on page 3421

Searching for a Geographic Rating Area Preference

Prerequisites

To search for a geographic rating area preference, you should have:

- Values defined in the **FIELD_CAT_FLG** lookup field

Procedure

To search for a geographic rating area preference:

1. Click the **Admin** link in the **Application** toolbar.
A list appears.
2. From the **Admin** menu, select **F** and then click **Field Mapping**.
A sub-menu appears.
3. Click the **Search** option from the **Field Mapping** sub-menu.
The **Field Mapping** screen appears.
4. Select the **Geographic Rating Area** option from the **Preference Category** list.
5. Enter the additional search criteria in the **Search Field Mapping** zone.

Note: ORMB search engine supports wildcard search, where you can substitute the percentage (%) symbol as a stand in for any word or letter in a search criteria. You can use the ‘%’ wildcard character in all input fields except the date and ID fields. The ‘%’ wildcard character is suffixed automatically at the end of the partial search criteria. Therefore, you may or may not specify the wildcard character at the end of the partial search criteria. However, you have to prefix the wildcard character manually wherever required.

6. Click **Search**.

A list of geographic rating area preferences that meet the search criteria appears in the **Search Results** section.

Viewing the Geographic Rating Area Preference Details

Procedure

To view the details of a geographic rating area preference:

1. Search for the geographic rating area preference in the **Field Mapping** screen.
2. In the **Search Results** section, click the **Broadcast** (📡) icon corresponding to the geographic rating area preference whose details you want to view.
The **Field Mapping** zone appears.
3. View the details of the geographic rating area preference in the **Field Mapping** zone.

Related Topics

For more information on...	See...
How to search for a geographic rating area preference	Searching for a Geographic Rating Area Preference on page 190

Defining a Geographic Rating Area Preference

Prerequisites

To define a geographic rating area preference, you should have:

- Values defined in the **ADDRESS_SRC_FLG**, **ADDRESS_TYPE_FLG**, and **MAP_ENTITY_FLG** lookup fields
- Geographic rating areas defined in the application

Procedure

To define a geographic rating area preference:

1. Click the **Admin** link in the **Application** toolbar.
A list appears.
2. From the **Admin** menu, select **F** and then click **Field Mapping**.
A sub-menu appears.
3. Click the **Add** option from the **Field Mapping** sub-menu.

The **Select Business Object** screen appears. It contains the following field:

Field Name	Field Description	Mandatory (Yes or No)
Field Mapping Business Object	Used to indicate the business object using which you want to create the geographic rating area preference. The valid values are: <ul style="list-style-type: none"> • Field Mapping • Medicare Plan Benefit Package • Membership Status Reason Mapping 	Yes

Note: Alternatively, you can access the **Select Business Object** screen by clicking the **Add** button in the **Page Title** area of the **Field Mapping** screen.

4. Select the **Field Mapping** option from the **Field Mapping Business Object** list.
5. Click **OK**.

The **Field Mapping** screen appears. It contains the following sections:

- **Main** - Used to specify basic details of the geographic rating area preference. It contains the following fields:

Field Name	Field Description	Mandatory (Yes or No)
Preference	Used to specify the geographic rating area preference.	Yes
Description	Used to specify the description for the geographic rating area preference.	Yes
Detailed Description	Used to specify additional information about the geographic rating area preference.	No

Field Name	Field Description	Mandatory (Yes or No)
Status	Used to indicate the status of the geographic rating area preference. The valid values are: <ul style="list-style-type: none"> • Active • Inactive 	Yes

- **Preference Category** - This section contains the following field:

Field Name	Field Description	Mandatory (Yes or No)
Preference Category	Used to indicate the category to which the preference belongs. The valid values are: <ul style="list-style-type: none"> • Billing • Binder Payment • Geographic Rating Area • Individual Membership • Medicare • Medicare Plan Benefit • Member Reconciliation • Member Relationship and Subscription Tier • Membership Status Reason • Statement Construct 	Yes

- **Preference Settings** - Used to set the attributes in the geographic rating area preference. It contains the following fields in a grid:

Field Name	Field Description	Mandatory (Yes or No)
Attribute	<p>Used to indicate the attribute which you want to set in the geographic rating area preference. The valid values are:</p> <ul style="list-style-type: none"> • Address Source Characteristic Type - Used when the system derives the geographic rating area for a membership. • Address Type Characteristic Type - Used when the system derives the geographic rating area for a membership. • Default Address Source - Used when the address source characteristic is not defined for any of the following entities: <ul style="list-style-type: none"> • Policy Plan • State where the Policy Plan is Issued • Policy • State where the Policy is Issued • Default Address Type - Used when the address type characteristic is not defined for any of the following entities: <ul style="list-style-type: none"> • Policy Plan • State where the Policy Plan is Issued • Policy • State where the Policy is Issued • Default Geographic Rating Area - Used when the system is unable to derive the geographic rating area for the following combination: <ul style="list-style-type: none"> • State and zip code (this combination is considered when the Use Plan Details attribute is set to No) • State, zip code, policy number, plan number, and source system (this combination is considered when the Use Plan Details attribute is set to Yes) • Geographic Rating Area Characteristic Type - Used when the system stores the geographic rating area for a membership. • Use Plan Details - Used to indicate whether the policy number, plan number, and source system should be considered while deriving the geographic rating area for a membership. 	<p>Yes (Conditional)</p> <div style="border: 1px solid black; padding: 5px; margin-top: 10px;"> <p>Note: This field is required while setting an attribute in the geographic rating area preference.</p> </div>

Field Name	Field Description	Mandatory (Yes or No)						
Value	Used to specify the attribute value. The attribute value that you can specify varies depending on the attribute you want to set in the geographic rating area preference:	Yes (Conditional)						
	<table border="1" data-bbox="639 390 1179 1436"> <thead> <tr> <th data-bbox="639 390 873 474">If the attribute is set to...</th> <th data-bbox="873 390 1179 474">Then, this field is...</th> </tr> </thead> <tbody> <tr> <td data-bbox="639 474 873 1436"> Address Source Characteristic Type </td> <td data-bbox="873 474 1179 1436"> Used to specify the characteristic type that indicates the address source. The system supports two address sources named Policy Holder and Main Subscriber. This type of characteristic can be defined for the following entities: <ul style="list-style-type: none"> • Policy Plan • State where the Policy Plan is Issued • Policy • State where the Policy is Issued Here, you must specify a characteristic type where the characteristic entity is set to Policy Plan, State, and Policy. <div data-bbox="878 1310 1174 1415" style="border: 1px solid black; padding: 2px;"> Note: The C1-ADSRC characteristic type is shipped with the product. </div> </td> </tr> <tr> <td data-bbox="639 1436 873 1986"> Address Type Characteristic Type </td> <td data-bbox="873 1436 1179 1986"> Used to specify the characteristic type that indicates the address type. The system supports three address types named Person Mailing, Person Seasonal, and Account Override. This type of characteristic can be defined for the following entities: <ul style="list-style-type: none"> • Policy Plan • State where the Policy Plan is Issued </td> </tr> </tbody> </table>	If the attribute is set to...	Then, this field is...	Address Source Characteristic Type	Used to specify the characteristic type that indicates the address source. The system supports two address sources named Policy Holder and Main Subscriber . This type of characteristic can be defined for the following entities: <ul style="list-style-type: none"> • Policy Plan • State where the Policy Plan is Issued • Policy • State where the Policy is Issued Here, you must specify a characteristic type where the characteristic entity is set to Policy Plan, State, and Policy . <div data-bbox="878 1310 1174 1415" style="border: 1px solid black; padding: 2px;"> Note: The C1-ADSRC characteristic type is shipped with the product. </div>	Address Type Characteristic Type	Used to specify the characteristic type that indicates the address type. The system supports three address types named Person Mailing, Person Seasonal, and Account Override . This type of characteristic can be defined for the following entities: <ul style="list-style-type: none"> • Policy Plan • State where the Policy Plan is Issued 	Note: This field is required while setting an attribute in the geographic rating area preference.
	If the attribute is set to...	Then, this field is...						
Address Source Characteristic Type	Used to specify the characteristic type that indicates the address source. The system supports two address sources named Policy Holder and Main Subscriber . This type of characteristic can be defined for the following entities: <ul style="list-style-type: none"> • Policy Plan • State where the Policy Plan is Issued • Policy • State where the Policy is Issued Here, you must specify a characteristic type where the characteristic entity is set to Policy Plan, State, and Policy . <div data-bbox="878 1310 1174 1415" style="border: 1px solid black; padding: 2px;"> Note: The C1-ADSRC characteristic type is shipped with the product. </div>							
Address Type Characteristic Type	Used to specify the characteristic type that indicates the address type. The system supports three address types named Person Mailing, Person Seasonal, and Account Override . This type of characteristic can be defined for the following entities: <ul style="list-style-type: none"> • Policy Plan • State where the Policy Plan is Issued 							

Field Name	Field Description		Mandatory (Yes or No)
		<ul style="list-style-type: none"> • Policy • State where the Policy is Issued <p>Here, you must specify a characteristic type where the characteristic entity is set to Policy Plan, State, and Policy.</p> <p>Note: The C1-ADTYP characteristic type is shipped with the product.</p>	
	Default Address Source	<p>Used to specify the address source. The valid values are:</p> <ul style="list-style-type: none"> • Main Subscriber • Policy Holder <p>Note: The list includes only those values which are defined in the ADDRESS_SRC_FLG lookup field.</p>	
	Default Address Type	<p>Used to specify the address type. The valid values are:</p> <ul style="list-style-type: none"> • Person Mailing • Person Seasonal • Account Override <p>Note: The list includes only those values which are defined in the ADDRESS_TYPE_FLG lookup field.</p>	
	Default Geographic Rating Area	<p>Used to specify the geographic rating area.</p> <p>Note: Here, you can specify a geographic rating area which is already defined in the system.</p>	

Field Name	Field Description		Mandatory (Yes or No)
	Geographic Rating Area Characteristic Type	<p>Used to specify the characteristic type where you can store the geographic rating area. This type of characteristic is defined for the membership. Here, you must specify a characteristic type where the characteristic entity is set to Membership.</p> <div style="border: 1px solid black; padding: 5px;"> <p>Note: The C1-GEORT characteristic type is shipped with the product.</p> </div>	
	Use Plan Details	<p>Used to indicate whether the policy plan details should be considered while deriving the geographic rating area for a membership. The valid values are:</p> <ul style="list-style-type: none"> • Yes - Used when you want to derive the geographic rating area using the state, zip code, policy number, plan number, and source system combination. • No - Used when you want to derive the geographic rating area using the state and zip code combination. 	

Field Name	Field Description	Mandatory (Yes or No)
Entity Type	Used to indicate the type of entity for which the attribute is applicable. The valid values are: <ul style="list-style-type: none"> Account Billable Charge 	No
	Note: At present, this data is stored for informational purposes only and is not considered in the business logic. If required, you can add more entity types to the MAP_ENTITY_FLG lookup field.	

Note: While defining a geographic rating area preference, you must set at least one attribute in the geographic rating area preference.

6. Select the **Geographic Rating Area** option from the **Preference Category** list.
7. Enter the required details in the **Main** section.
8. Select the required attribute and value from the respective fields.
9. If you want to set more than one attribute in the geographic rating area preference, click the **Add (+)** icon and then repeat step 8.

Note: However, if you want to remove an attribute from the geographic rating area preference, click the **Delete** (🗑️) icon corresponding to the attribute.

10. Click **Save**.

The geographic rating area preference is defined.

Editing a Geographic Rating Area Preference

Prerequisites

To edit a geographic rating area preference, you should have:

- Values defined in the **ADDRESS_SRC_FLG**, **ADDRESS_TYPE_FLG**, and **MAP_ENTITY_FLG** lookup fields
- Geographic rating areas defined in the application

Procedure

To edit a geographic rating area preference:

1. Search for the geographic rating area preference in the **Field Mapping** screen.
2. In the **Search Results** section, click the **Edit** (✎) icon in the **Edit** column corresponding to the geographical rating area preference whose details you want to edit.

The **Field Mapping** screen appears. It contains the following sections:

- **Main** - Used to specify basic details of the geographic rating area preference. It contains the following fields:

Field Name	Field Description	Mandatory (Yes or No)
Preference	Displays the geographic rating area preference.	Not applicable

Field Name	Field Description	Mandatory (Yes or No)
Description	Used to specify the description for the geographic rating area preference.	Yes
Detailed Description	Used to specify additional information about the geographic rating area preference.	No
Status	Used to indicate the status of the geographic rating area preference. The valid values are: <ul style="list-style-type: none"> Active Inactive 	Yes
Preference Category	Indicates the category to which the preference belongs. The valid value is: <ul style="list-style-type: none"> Geographic Rating Area 	Not applicable

- **Preference Settings** - Used to set the attributes in the geographic rating area preference. It contains the following fields in a grid:

Field Name	Field Description	Mandatory (Yes or No)
Attribute	Used to indicate the attribute which you want to set in the geographic rating area preference. The valid values are: <ul style="list-style-type: none"> • Address Source Characteristic Type - Used when the system derives the geographic rating area for a membership. • Address Type Characteristic Type - Used when the system derives the geographic rating area for a membership. • Default Address Source - Used when the address source characteristic is not defined for any of the following entities: <ul style="list-style-type: none"> • Policy Plan • State where the Policy Plan is Issued • Policy • State where the Policy is Issued • Default Address Type - Used when the address type characteristic is not defined for any of the following entities: <ul style="list-style-type: none"> • Policy Plan • State where the Policy Plan is Issued • Policy • State where the Policy is Issued 	Yes (Conditional)
		Note: This field is required while setting an attribute in the geographic rating area preference.

Field Name	Field Description	Mandatory (Yes or No)				
	<ul style="list-style-type: none"> • Default Geographic Rating Area - Used when the system is unable to derive the geographic rating area for the following combination: <ul style="list-style-type: none"> • State and zip code (this combination is considered when the Use Plan Details attribute is set to No) • State, zip code, policy number, plan number, and source system (this combination is considered when the Use Plan Details attribute is set to Yes) • Geographic Rating Area Characteristic Type - Used when the system stores the geographic rating area for a membership. • Use Plan Details - Used to indicate whether the policy number, plan number, and source system should be considered while deriving the geographic rating area for a membership. 					
Value	<p>Used to specify the attribute value. The attribute value that you can specify varies depending on the attribute you want to set in the geographic rating area preference:</p> <table border="1" data-bbox="639 1060 1182 1808"> <thead> <tr> <th data-bbox="639 1060 873 1144">If the attribute is set to...</th> <th data-bbox="873 1060 1182 1144">Then, this field is...</th> </tr> </thead> <tbody> <tr> <td data-bbox="639 1144 873 1808">Address Source Characteristic Type</td> <td data-bbox="873 1144 1182 1808"> <p>Used to specify the characteristic type that indicates the address source. The system supports two address sources named Policy Holder and Main Subscriber. This type of characteristic can be defined for the following entities:</p> <ul style="list-style-type: none"> • Policy Plan • State where the Policy Plan is Issued • Policy • State where the Policy is Issued </td> </tr> </tbody> </table>	If the attribute is set to...	Then, this field is...	Address Source Characteristic Type	<p>Used to specify the characteristic type that indicates the address source. The system supports two address sources named Policy Holder and Main Subscriber. This type of characteristic can be defined for the following entities:</p> <ul style="list-style-type: none"> • Policy Plan • State where the Policy Plan is Issued • Policy • State where the Policy is Issued 	<p>Yes (Conditional)</p> <p>Note: This field is required while setting an attribute in the geographic rating area preference.</p>
If the attribute is set to...	Then, this field is...					
Address Source Characteristic Type	<p>Used to specify the characteristic type that indicates the address source. The system supports two address sources named Policy Holder and Main Subscriber. This type of characteristic can be defined for the following entities:</p> <ul style="list-style-type: none"> • Policy Plan • State where the Policy Plan is Issued • Policy • State where the Policy is Issued 					

Field Name	Field Description		Mandatory (Yes or No)
		<p>Here, you must specify a characteristic type where the characteristic entity is set to Policy Plan, State, and Policy.</p> <p>Note: The C1-ADSRC characteristic type is shipped with the product.</p>	
	Address Type Characteristic Type	<p>Used to specify the characteristic type that indicates the address type. The system supports three address types named Person Mailing, Person Seasonal, and Account Override. This type of characteristic can be defined for the following entities:</p> <ul style="list-style-type: none"> • Policy Plan • State where the Policy Plan is Issued • Policy • State where the Policy is Issued <p>Here, you must specify a characteristic type where the characteristic entity is set to Policy Plan, State, and Policy.</p> <p>Note: The C1-ADTYP characteristic type is shipped with the product.</p>	
	Default Address Source	<p>Used to specify the address source. The valid values are:</p> <ul style="list-style-type: none"> • Main Subscriber • Policy Holder <p>Note: The list includes only those values which are defined in the ADDRESS_SRC_FLG lookup field.</p>	

Field Name	Field Description	Mandatory (Yes or No)								
	<table border="1"> <tr> <td data-bbox="639 254 870 709">Default Address Type</td> <td data-bbox="870 254 1179 709"> <p>Used to specify the address type. The valid values are:</p> <ul style="list-style-type: none"> • Person Mailing • Person Seasonal • Account Override <p>Note: The list includes only those values which are defined in the ADDRESS_TYPE_FLG lookup field.</p> </td> </tr> <tr> <td data-bbox="639 709 870 999">Default Geographic Rating Area</td> <td data-bbox="870 709 1179 999"> <p>Used to specify the geographic rating area.</p> <p>Note: Here, you can specify a geographic rating area which is already defined in the system.</p> </td> </tr> <tr> <td data-bbox="639 999 870 1507">Geographic Rating Area Characteristic Type</td> <td data-bbox="870 999 1179 1507"> <p>Used to specify the characteristic type where you can store the geographic rating area. This type of characteristic is defined for the membership. Here, you must specify a characteristic type where the characteristic entity is set to Membership.</p> <p>Note: The C1-GEORT characteristic type is shipped with the product.</p> </td> </tr> <tr> <td data-bbox="639 1507 870 1728">Use Plan Details</td> <td data-bbox="870 1507 1179 1728"> <p>Used to indicate whether the policy plan details should be considered while deriving the geographic rating area for a membership.</p> </td> </tr> </table>	Default Address Type	<p>Used to specify the address type. The valid values are:</p> <ul style="list-style-type: none"> • Person Mailing • Person Seasonal • Account Override <p>Note: The list includes only those values which are defined in the ADDRESS_TYPE_FLG lookup field.</p>	Default Geographic Rating Area	<p>Used to specify the geographic rating area.</p> <p>Note: Here, you can specify a geographic rating area which is already defined in the system.</p>	Geographic Rating Area Characteristic Type	<p>Used to specify the characteristic type where you can store the geographic rating area. This type of characteristic is defined for the membership. Here, you must specify a characteristic type where the characteristic entity is set to Membership.</p> <p>Note: The C1-GEORT characteristic type is shipped with the product.</p>	Use Plan Details	<p>Used to indicate whether the policy plan details should be considered while deriving the geographic rating area for a membership.</p>	
Default Address Type	<p>Used to specify the address type. The valid values are:</p> <ul style="list-style-type: none"> • Person Mailing • Person Seasonal • Account Override <p>Note: The list includes only those values which are defined in the ADDRESS_TYPE_FLG lookup field.</p>									
Default Geographic Rating Area	<p>Used to specify the geographic rating area.</p> <p>Note: Here, you can specify a geographic rating area which is already defined in the system.</p>									
Geographic Rating Area Characteristic Type	<p>Used to specify the characteristic type where you can store the geographic rating area. This type of characteristic is defined for the membership. Here, you must specify a characteristic type where the characteristic entity is set to Membership.</p> <p>Note: The C1-GEORT characteristic type is shipped with the product.</p>									
Use Plan Details	<p>Used to indicate whether the policy plan details should be considered while deriving the geographic rating area for a membership.</p>									

Field Name	Field Description	Mandatory (Yes or No)
	<div style="border: 1px solid black; padding: 5px;"> <p>The valid values are:</p> <ul style="list-style-type: none"> • Yes - Used when you want to derive the geographic rating area using the state, zip code, policy number, plan number, and source system combination. • No - Used when you want to derive the geographic rating area using the state and zip code combination. </div>	
Entity Type	<p>Used to indicate the type of entity for which the attribute is applicable. The valid values are:</p> <ul style="list-style-type: none"> • Account • Billable Charge <div style="border: 1px solid black; padding: 5px; margin-top: 5px;"> <p>Note: At present, this data is stored for informational purposes only and is not considered in the business logic. If required, you can add more entity types to the MAP_ENTITY_FLG lookup field.</p> </div>	No

Tip: Alternatively, you can edit the details of a geographic rating area preference by clicking the **Edit** button in the **Field Mapping** zone.

3. Modify the required details in the **Main** section.
4. Define, edit, or remove the attribute from the geographic rating area preference, if required.

Note: You must set at least one attribute in a geographic rating area preference.

5. Click **Save**.

The changes made to the geographic rating area preference are saved.

Related Topics

For more information on...	See...
How to search for a geographic rating area preference	Searching for a Geographic Rating Area Preference on page 190

Copying a Geographic Rating Area Preference

Instead of creating a geographic rating area preference from scratch, you can create a new geographic rating area preference using an existing geographic rating area preference. This is possible through copying a geographic rating area preference. On copying a geographic rating area preference, the details including the attributes are copied to the new geographic rating area preference. You can then edit the details, if required.

Prerequisites

To copy a geographic rating area preference, you should have:

- Geographic rating area preference (whose copy you want to create) defined in the application
- Values defined in the **ADDRESS_SRC_FLG**, **ADDRESS_TYPE_FLG**, and **MAP_ENTITY_FLG** lookup fields
- Geographic rating areas defined in the application

Procedure

To copy a geographic rating area preference:

1. Search for the geographic rating area preference in the **Field Mapping** screen.
2. In the **Search Results** section, click the **Duplicate**  icon in the **Duplicate** column corresponding to the geographical rating area preference whose copy you want to create.

The **Field Mapping** screen appears. It contains the following sections:

- **Main** - Used to specify basic details of the geographic rating area preference. It contains the following fields:

Field Name	Field Description	Mandatory (Yes or No)
Preference	Used to specify the geographic rating area preference.	Yes
Description	Used to specify the description for the geographic rating area preference.	Yes
Detailed Description	Used to specify additional information about the geographic rating area preference.	No
Status	Used to indicate the status of the geographic rating area preference. The valid values are: <ul style="list-style-type: none"> • Active • Inactive 	Yes
Preference Category	Indicates the category to which the preference belongs. The valid value is: <ul style="list-style-type: none"> • Geographic Rating Area 	Not applicable

- **Preference Settings** - Used to set the attributes in the geographic rating area preference. It contains the following fields in a grid:

Field Name	Field Description	Mandatory (Yes or No)
Attribute	<p>Used to indicate the attribute which you want to set in the geographic rating area preference. The valid values are:</p> <ul style="list-style-type: none"> • Address Source Characteristic Type - Used when the system derives the geographic rating area for a membership. 	<p>Yes (Conditional)</p> <div style="border: 1px solid black; padding: 2px; margin-top: 5px;"> <p>Note: This field is required while setting an attribute in the geographic rating area preference.</p> </div>
	<ul style="list-style-type: none"> • Address Type Characteristic Type - Used when the system derives the geographic rating area for a membership. • Default Address Source - Used when the address source characteristic is not defined for any of the following entities: <ul style="list-style-type: none"> • Policy Plan • State where the Policy Plan is Issued • Policy • State where the Policy is Issued • Default Address Type - Used when the address type characteristic is not defined for any of the following entities: <ul style="list-style-type: none"> • Policy Plan • State where the Policy Plan is Issued • Policy • State where the Policy is Issued • Default Geographic Rating Area - Used when the system is unable to derive the geographic rating area for the following combination: <ul style="list-style-type: none"> • State and zip code (this combination is considered when the Use Plan Details attribute is set to No) • State, zip code, policy number, plan number, and source system (this combination is considered when the Use Plan Details attribute is set to Yes) • Geographic Rating Area Characteristic Type - Used when the system stores the geographic rating area for a membership. • Use Plan Details - Used to indicate whether the policy number, plan number, and source system should be considered while deriving the geographic rating area for a membership. 	

Field Name	Field Description	Mandatory (Yes or No)						
Value	Used to specify the attribute value. The attribute value that you can specify varies depending on the attribute you want to set in the geographic rating area preference:	Yes (Conditional)						
	<table border="1" data-bbox="639 390 1179 1440"> <thead> <tr> <th data-bbox="639 390 873 474">If the attribute is set to...</th> <th data-bbox="873 390 1179 474">Then, this field is...</th> </tr> </thead> <tbody> <tr> <td data-bbox="639 474 873 1440">Address Source Characteristic Type</td> <td data-bbox="873 474 1179 1440"> <p>Used to specify the characteristic type that indicates the address source. The system supports two address sources named Policy Holder and Main Subscriber. This type of characteristic can be defined for the following entities:</p> <ul style="list-style-type: none"> • Policy Plan • State where the Policy Plan is Issued • Policy • State where the Policy is Issued <p>Here, you must specify a characteristic type where the characteristic entity is set to Policy Plan, State, and Policy.</p> <div data-bbox="878 1310 1174 1415" style="border: 1px solid black; padding: 2px;"> <p>Note: The C1-ADSRC characteristic type is shipped with the product.</p> </div> </td> </tr> <tr> <td data-bbox="639 1440 873 1986">Address Type Characteristic Type</td> <td data-bbox="873 1440 1179 1986"> <p>Used to specify the characteristic type that indicates the address type. The system supports three address types named Person Mailing, Person Seasonal, and Account Override. This type of characteristic can be defined for the following entities:</p> <ul style="list-style-type: none"> • Policy Plan • State where the Policy Plan is Issued </td> </tr> </tbody> </table>	If the attribute is set to...	Then, this field is...	Address Source Characteristic Type	<p>Used to specify the characteristic type that indicates the address source. The system supports two address sources named Policy Holder and Main Subscriber. This type of characteristic can be defined for the following entities:</p> <ul style="list-style-type: none"> • Policy Plan • State where the Policy Plan is Issued • Policy • State where the Policy is Issued <p>Here, you must specify a characteristic type where the characteristic entity is set to Policy Plan, State, and Policy.</p> <div data-bbox="878 1310 1174 1415" style="border: 1px solid black; padding: 2px;"> <p>Note: The C1-ADSRC characteristic type is shipped with the product.</p> </div>	Address Type Characteristic Type	<p>Used to specify the characteristic type that indicates the address type. The system supports three address types named Person Mailing, Person Seasonal, and Account Override. This type of characteristic can be defined for the following entities:</p> <ul style="list-style-type: none"> • Policy Plan • State where the Policy Plan is Issued 	<p>Note: This field is required while setting an attribute in the geographic rating area preference.</p>
	If the attribute is set to...	Then, this field is...						
Address Source Characteristic Type	<p>Used to specify the characteristic type that indicates the address source. The system supports two address sources named Policy Holder and Main Subscriber. This type of characteristic can be defined for the following entities:</p> <ul style="list-style-type: none"> • Policy Plan • State where the Policy Plan is Issued • Policy • State where the Policy is Issued <p>Here, you must specify a characteristic type where the characteristic entity is set to Policy Plan, State, and Policy.</p> <div data-bbox="878 1310 1174 1415" style="border: 1px solid black; padding: 2px;"> <p>Note: The C1-ADSRC characteristic type is shipped with the product.</p> </div>							
Address Type Characteristic Type	<p>Used to specify the characteristic type that indicates the address type. The system supports three address types named Person Mailing, Person Seasonal, and Account Override. This type of characteristic can be defined for the following entities:</p> <ul style="list-style-type: none"> • Policy Plan • State where the Policy Plan is Issued 							

Field Name	Field Description		Mandatory (Yes or No)
		<ul style="list-style-type: none"> • Policy • State where the Policy is Issued <p>Here, you must specify a characteristic type where the characteristic entity is set to Policy Plan, State, and Policy.</p> <p>Note: The C1-ADTYP characteristic type is shipped with the product.</p>	
	Default Address Source	<p>Used to specify the address source. The valid values are:</p> <ul style="list-style-type: none"> • Main Subscriber • Policy Holder <p>Note: The list includes only those values which are defined in the ADDRESS_SRC_FLG lookup field.</p>	
	Default Address Type	<p>Used to specify the address type. The valid values are:</p> <ul style="list-style-type: none"> • Person Mailing • Person Seasonal • Account Override <p>Note: The list includes only those values which are defined in the ADDRESS_TYPE_FLG lookup field.</p>	
	Default Geographic Rating Area	<p>Used to specify the geographic rating area.</p> <p>Note: Here, you can specify a geographic rating area which is already defined in the system.</p>	

Field Name	Field Description		Mandatory (Yes or No)
	Geographic Rating Area Characteristic Type	<p>Used to specify the characteristic type where you can store the geographic rating area. This type of characteristic is defined for the membership. Here, you must specify a characteristic type where the characteristic entity is set to Membership.</p> <div style="border: 1px solid black; padding: 5px;"> <p>Note: The C1-GEORT characteristic type is shipped with the product.</p> </div>	
	Use Plan Details	<p>Used to indicate whether the policy plan details should be considered while deriving the geographic rating area for a membership. The valid values are:</p> <ul style="list-style-type: none"> • Yes - Used when you want to derive the geographic rating area using the state, zip code, policy number, plan number, and source system combination. • No - Used when you want to derive the geographic rating area using the state and zip code combination. 	

Field Name	Field Description	Mandatory (Yes or No)
Entity Type	Used to indicate the type of entity for which the attribute is applicable. The valid values are: <ul style="list-style-type: none"> Account Billable Charge 	No
	Note: At present, this data is stored for informational purposes only and is not considered in the business logic. If required, you can add more entity types to the MAP_ENTITY_FLG lookup field.	

Note: While defining a geographic rating area preference, you must set at least one attribute in the geographic rating area preference.

Tip: Alternatively, you can copy a geographic rating area preference by clicking the **Duplicate** button in the **Field Mapping** zone.

3. Enter the required details in the **Main** section.
4. Define, edit, or remove the attribute from the geographic rating area preference, if required.
5. Click **Save**.

The new geographic rating area preference is defined.

Related Topics

For more information on...	See...
How to search for a geographic rating area preference	Searching for a Geographic Rating Area Preference on page 190

Deleting a Geographic Rating Area Preference

Procedure

To delete a geographic rating area preference:

1. Search for the geographic rating area preference in the **Field Mapping** screen.
2. In the **Search Results** section, click the **Delete** (🗑️) icon in the **Delete** column corresponding to the geographic rating area preference that you want to delete.

A message appears confirming whether you want to delete the geographic rating area preference.

Tip: Alternatively, you can delete a geographic rating area preference by clicking the **Delete** button in the **Field Mapping** zone.

3. Click **OK**.

The geographic rating area preference is deleted.

Related Topics

For more information on...	See...
How to search for a geographic rating area preference	Searching for a Geographic Rating Area Preference on page 190

Member Relationship and Subscription Tier Preference

Oracle Revenue Management and Billing enables you to use the member relationship (i.e. how a member is related to the main subscriber of the membership) as a pricing parameter while defining the age based, tier based, and additional charge pricing rules. This feature facilitates you to offer different rates for a price item based on different member relationship.

While adding a membership to a policy plan or while adding or inactivating a member person in a membership, the system automatically derives the member relationship for each member person of the membership from a member relationship structure. While deriving the member relationship for a member person, the system uses the following attributes from the member relationship and subscription tier preference:

- Age Calculation Date Basis Characteristic Type
- Max Age Limit for Max Dependent Count Characteristic Type
- Max Number of Dependents Order Priority Characteristic Type
- Member Relationship Characteristic Type
- Maximum Number of Dependents Characteristic Type
- Member Relationship Derivation Date Characteristic Type
- Member Relationship Structure Characteristic Type
- New Born Gift Days Characteristic Type
- New Born Gift Days Applicability Characteristic Type
- Young Adult Max Age Limit Characteristic Type
- Young Adult Max Age Limit Applicability Characteristic Type

For more information about these attributes, see [Defining a Member Relationship and Subscription Tier Preference](#) on page 211.

Similarly, the system enables you to use the membership subscription tier as a pricing parameter while defining the tier based pricing rules. This feature facilitates you to offer different rates for a price item based on different membership subscription tier.

While determining the subscription tier for a membership, the system derives the subscription tier for the membership from a subscription tier structure. While deriving the subscription tier for a membership, the system uses the following attributes from the member relationship and subscription tier preference:

- Age Calculation Date Basis Characteristic Type
- Max Age Limit for Max Dependent Count Characteristic Type
- Max Number of Dependents Order Priority Characteristic Type
- Maximum Number of Dependents Characteristic Type
- New Born Gift Days Characteristic Type
- New Born Gift Days Applicability Characteristic Type
- Subscription Tier Structure Characteristic Type
- Subscription Tier Characteristic Type
- Young Adult Max Age Limit Characteristic Type

- Young Adult Max Age Limit Applicability Characteristic Type

For more information about these attributes, see [Defining a Member Relationship and Subscription Tier Preference](#) on page 211.

The system considers the member relationship and subscription tier preference which is specified in the **Relation Structure Code Field Mapping** option type of the **C1-ASOBLLNG** feature configuration. You can define, edit, delete, and copy a member relationship and subscription tier preference through the **Field Mapping** screen.

Related Topics

For more information on...	See...
How to setup the C1-ASOBLLNG feature configuration	Setting the C1-ASOBLLNG Feature Configuration on page 3421

Searching for a Member Relationship and Subscription Tier Preference

Prerequisites

To search for a member relationship and subscription tier preference, you should have:

- Values defined in the **FIELD_CAT_FLG** lookup field

Procedure

To search for a member relationship and subscription tier preference:

1. Click the **Admin** link in the **Application** toolbar.
A list appears.
2. From the **Admin** menu, select **F** and then click **Field Mapping**.
A sub-menu appears.
3. Click the **Search** option from the **Field Mapping** sub-menu.
The **Field Mapping** screen appears.
4. Select the **Member Relationship and Subscription Tier Preferences** option from the **Preference Category** list.
5. Enter the additional search criteria in the **Search Field Mapping** zone.

Note: ORMB search engine supports wildcard search, where you can substitute the percentage (%) symbol as a stand in for any word or letter in a search criteria. You can use the ‘%’ wildcard character in all input fields except the date and ID fields. The ‘%’ wildcard character is suffixed automatically at the end of the partial search criteria. Therefore, you may or may not specify the wildcard character at the end of the partial search criteria. However, you have to prefix the wildcard character manually wherever required.

6. Click **Search**.
A list of member relationship and subscription tier preferences that meet the search criteria appears in the **Search Results** section.

Viewing the Member Relationship and Subscription Tier Preference Details

Procedure

To view the details of a member relationship and subscription tier preference:

1. Search for the member relationship and subscription tier preference in the **Field Mapping** screen.

- In the **Search Results** section, click the **Broadcast** (📡) icon corresponding to the member relationship and subscription tier preference whose details you want to view. The **Field Mapping** zone appears.
- View the details of the member relationship and subscription tier preference in the **Field Mapping** zone.

Related Topics

For more information on...	See...
How to search for a member relationship and subscription tier preference	Searching for a Member Relationship and Subscription Tier Preference on page 210

Defining a Member Relationship and Subscription Tier Preference

Prerequisites

To define a member relationship and subscription tier preference, you should have:

- Required characteristic types defined in the application
- Values defined in the **MAP_ENTITY_FLG** lookup field

Procedure

To define a member relationship and subscription tier preference:

- Click the **Admin** link in the **Application** toolbar.
A list appears.
- From the **Admin** menu, select **F** and then click **Field Mapping**.
A sub-menu appears.
- Click the **Add** option from the **Field Mapping** sub-menu.

The **Select Business Object** screen appears. It contains the following field:

Field Name	Field Description	Mandatory (Yes or No)
Field Mapping Business Object	Used to indicate the business object using which you want to create the member relationship and subscription tier preference. The valid values are: <ul style="list-style-type: none"> Field Mapping Medicare Plan Benefit Package Membership Status Reason Mapping 	Yes

Note: Alternatively, you can access the **Select Business Object** screen by clicking the **Add** button in the **Page Title** area of the **Field Mapping** screen.

- Select the **Field Mapping** option from the **Field Mapping Business Object** list.
- Click **OK**.

The **Field Mapping** screen appears. It contains the following sections:

- Main** - Used to specify basic details of the member relationship and subscription tier preference. It contains the following fields:

Field Name	Field Description	Mandatory (Yes or No)
Preference	Used to specify the member relationship and subscription tier preference.	Yes
Description	Used to specify the description for the member relationship and subscription tier preference.	Yes
Detailed Description	Used to specify additional information about the member relationship and subscription tier preference.	No
Status	Used to indicate the status of the member relationship and subscription tier preference. The valid values are: <ul style="list-style-type: none"> • Active • Inactive 	Yes

- **Preference Category** - This section contains the following field:

Field Name	Field Description	Mandatory (Yes or No)
Preference Category	Used to indicate the category to which the preference belongs. The valid values are: <ul style="list-style-type: none"> • Billing • Binder Payment • Geographic Rating Area • Individual Membership • Medicare • Medicare Plan Benefit • Member Reconciliation • Member Relationship and Subscription Tier • Membership Status Reason • Statement Construct 	Yes

- **Preference Settings** - Used to set the attributes in the member relationship and subscription tier preference. It contains the following fields in a grid:

Field Name	Field Description	Mandatory (Yes or No)
Attribute	<p>Used to indicate the attribute which you want to set in the member relationship and subscription tier preference. The valid values are:</p> <ul style="list-style-type: none"> • Age Calculation Date Basis Characteristic Type - Used when the system derives the member relationship for a member person and the subscription tier for a membership. • Max Age Limit for Max Dependent Count Characteristic Type - Used when the system derives the member relationship for a member person and the subscription tier for a membership. • Max Number of Dependents Order Priority Characteristic Type - Used when the system derives the member relationship for a member person and the subscription tier for a membership. 	<p>Yes (Conditional)</p> <p>Note: This field is required while setting an attribute in the member relationship and subscription tier preference.</p>

Field Name	Field Description	Mandatory (Yes or No)
	<ul style="list-style-type: none"> • Member Relationship Characteristic Type - Used when the system stores the member relationship for a member person. • Maximum Number of Dependents Characteristic Type - Used when the system derives the member relationship for a member person and the subscription tier for a membership. • Member Relationship Derivation Date Characteristic Type - Used when the system derives the member relationship for a member person. • Member Relationship Structure Characteristic Type - Used when the system derives the member relationship for a member person. • New Born Gift Days Characteristic Type - Used when the system derives the member relationship for a member person and the subscription tier for a membership. • New Born Gift Days Applicability Characteristic Type - Used when the system derives the member relationship for a member person and the subscription tier for a membership. • Subscription Tier Structure Characteristic Type - Used when the system derives the subscription tier for a membership. • Subscription Tier Characteristic Type - Used when the system stores the subscription tier for a membership. • Young Adult Max Age Limit Characteristic Type - Used when the system derives the member relationship for a member person and the subscription tier for a membership. • Young Adult Max Age Limit Applicability Characteristic Type - Used when the system derives the member relationship for a member person and the subscription tier for a membership. 	

Field Name	Field Description	Mandatory (Yes or No)						
Value	Used to specify the attribute value. The attribute value that you can specify varies depending on the attribute you want to set in the member relationship and subscription tier preference:	Yes (Conditional)						
	<table border="1" data-bbox="639 390 1177 1522"> <thead> <tr> <th data-bbox="639 390 867 474">If the attribute is set to...</th> <th data-bbox="867 390 1177 474">Then, this field is...</th> </tr> </thead> <tbody> <tr> <td data-bbox="639 474 867 1522">Age Calculation Date Basis Characteristic Type</td> <td data-bbox="867 474 1177 1522"> <p>Used to specify the characteristic type that indicates how the member person's age should be calculated. The system supports the following characteristic values:</p> <ul style="list-style-type: none"> • Member Enrollment Date • Member Enrollment Nearest Age • Plan Start Date • Policy Renewal/ Start Date <p>This type of characteristic can be defined for the following entities:</p> <ul style="list-style-type: none"> • Policy Plan • Policy <p>Here, you must specify a characteristic type where the characteristic entity is set to Policy Plan and Policy.</p> <div data-bbox="873 1388 1170 1503" style="border: 1px solid black; padding: 2px;"> <p>Note: The C1-AGCAL characteristic type is shipped with the product.</p> </div> </td> </tr> <tr> <td data-bbox="639 1522 867 1946">Max Age Limit for Max Dependent Count Characteristic Type</td> <td data-bbox="867 1522 1177 1946"> <p>Used to specify the characteristic type that indicates the maximum age limit for children which are eligible for premium calculation. This type of characteristic can be defined for the following entities:</p> <ul style="list-style-type: none"> • Policy Plan • Policy </td> </tr> </tbody> </table>	If the attribute is set to...	Then, this field is...	Age Calculation Date Basis Characteristic Type	<p>Used to specify the characteristic type that indicates how the member person's age should be calculated. The system supports the following characteristic values:</p> <ul style="list-style-type: none"> • Member Enrollment Date • Member Enrollment Nearest Age • Plan Start Date • Policy Renewal/ Start Date <p>This type of characteristic can be defined for the following entities:</p> <ul style="list-style-type: none"> • Policy Plan • Policy <p>Here, you must specify a characteristic type where the characteristic entity is set to Policy Plan and Policy.</p> <div data-bbox="873 1388 1170 1503" style="border: 1px solid black; padding: 2px;"> <p>Note: The C1-AGCAL characteristic type is shipped with the product.</p> </div>	Max Age Limit for Max Dependent Count Characteristic Type	<p>Used to specify the characteristic type that indicates the maximum age limit for children which are eligible for premium calculation. This type of characteristic can be defined for the following entities:</p> <ul style="list-style-type: none"> • Policy Plan • Policy 	<p>Note: This field is required while setting an attribute in the member relationship and subscription tier preference.</p>
	If the attribute is set to...	Then, this field is...						
Age Calculation Date Basis Characteristic Type	<p>Used to specify the characteristic type that indicates how the member person's age should be calculated. The system supports the following characteristic values:</p> <ul style="list-style-type: none"> • Member Enrollment Date • Member Enrollment Nearest Age • Plan Start Date • Policy Renewal/ Start Date <p>This type of characteristic can be defined for the following entities:</p> <ul style="list-style-type: none"> • Policy Plan • Policy <p>Here, you must specify a characteristic type where the characteristic entity is set to Policy Plan and Policy.</p> <div data-bbox="873 1388 1170 1503" style="border: 1px solid black; padding: 2px;"> <p>Note: The C1-AGCAL characteristic type is shipped with the product.</p> </div>							
Max Age Limit for Max Dependent Count Characteristic Type	<p>Used to specify the characteristic type that indicates the maximum age limit for children which are eligible for premium calculation. This type of characteristic can be defined for the following entities:</p> <ul style="list-style-type: none"> • Policy Plan • Policy 							

Field Name	Field Description		Mandatory (Yes or No)
		<p>Here, you must specify a characteristic type where the characteristic entity is set to Policy Plan and Policy.</p>	
	<p>Max Number of Dependents Order Priority Characteristic Type</p>	<p>Used to specify the characteristic type that indicates whether the system should first consider youngest or eldest children during premium calculation. The system supports the following two characteristic values — Youngest and Eldest. This type of characteristic can be defined for the following entities:</p> <ul style="list-style-type: none"> • Policy Plan • Policy <p>Here, you must specify a characteristic type where the characteristic entity is set to Policy Plan and Policy.</p> <div style="border: 1px solid black; padding: 2px;"> <p>Note: The DEPORPRI characteristic type is shipped with the product.</p> </div>	
	<p>Member Relationship Characteristic Type</p>	<p>Used to specify the characteristic type where you can store the member relationship for a member person. This type of characteristic is defined for the member person. Here, you must specify a characteristic type where the characteristic entity is set to Membership Person.</p> <div style="border: 1px solid black; padding: 2px;"> <p>Note: The C1-MEMRL characteristic type is shipped with the product.</p> </div>	

Field Name	Field Description		Mandatory (Yes or No)
	Maximum Number of Dependents Characteristic Type	<p>Used to specify the characteristic type that indicates the maximum number of dependent persons which are eligible for premium calculation. This type of characteristic can be defined for the following entities:</p> <ul style="list-style-type: none"> • Policy Plan • Policy <p>Here, you must specify a characteristic type where the characteristic entity is set to Policy Plan and Policy.</p>	
	Member Relationship Derivation Date Characteristic Type	<p>Used to specify the characteristic type that indicates whether the member relationship should be derived for a member person using its date of birth or enrollment date. The system supports the following two characteristic values — Date of Birth and Enrollment Date. This type of characteristic can be defined for the following entities:</p> <ul style="list-style-type: none"> • Policy Plan • Policy <p>Here, you must specify a characteristic type where the characteristic entity is set to Policy Plan and Policy.</p> <div style="border: 1px solid black; padding: 5px; margin-top: 10px;"> <p>Note: The C1-MRDDDB characteristic type is shipped with the product.</p> </div>	

Field Name	Field Description		Mandatory (Yes or No)
	Member Relationship Structure Characteristic Type	<p>Used to specify the characteristic type that indicates the member relationship structure which should be considered while deriving the member relationship for a member person. This type of characteristic can be defined for the following entities:</p> <ul style="list-style-type: none"> • Policy Plan • Policy <p>Here, you must specify a characteristic type where the characteristic entity is set to Policy Plan and Policy.</p> <div data-bbox="873 905 1182 1024" style="border: 1px solid black; padding: 5px;"> <p>Note: The C1-MRLST characteristic type is shipped with the product.</p> </div>	
	New Born Gift Days Characteristic Type	<p>Used to specify the characteristic type that indicates the number of days you want to offer as gift days from the new born child's birth date. This type of characteristic can be defined for the following entities:</p> <ul style="list-style-type: none"> • Policy Plan • Policy <p>Here, you must specify a characteristic type where the characteristic entity is set to Policy Plan and Policy.</p> <div data-bbox="873 1619 1182 1843" style="border: 1px solid black; padding: 5px;"> <p>Note: The NOOFGIFT characteristic type is shipped with the product. Here, you must define the required predefined characteristic values.</p> </div>	

Field Name	Field Description	Mandatory (Yes or No)				
	<table border="1"> <tr> <td data-bbox="639 254 865 1066"> <p>New Born Gift Days Applicability Characteristic Type</p> </td> <td data-bbox="865 254 1182 1066"> <p>Used to specify the characteristic type that indicates whether you want to offer gift days in case of a new born. The system supports the following two characteristic values — Y and N. This type of characteristic can be defined for the following entities:</p> <ul style="list-style-type: none"> • Policy Plan • Policy <p>Here, you must specify a characteristic type where the characteristic entity is set to Policy Plan and Policy.</p> <div style="border: 1px solid black; padding: 2px;"> <p>Note: The NEWBORNA characteristic type is shipped with the product.</p> </div> </td> </tr> <tr> <td data-bbox="639 1066 865 1810"> <p>Subscription Tier Structure Characteristic Type</p> </td> <td data-bbox="865 1066 1182 1810"> <p>Used to specify the characteristic type that indicates the subscription tier structure which should be considered while deriving the subscription tier for a membership. This type of characteristic can be defined for the following entities:</p> <ul style="list-style-type: none"> • Policy Plan • Policy <p>Here, you must specify a characteristic type where the characteristic entity is set to Policy Plan and Policy.</p> <div style="border: 1px solid black; padding: 2px;"> <p>Note: The C1-STRST characteristic type is shipped with the product.</p> </div> </td> </tr> </table>	<p>New Born Gift Days Applicability Characteristic Type</p>	<p>Used to specify the characteristic type that indicates whether you want to offer gift days in case of a new born. The system supports the following two characteristic values — Y and N. This type of characteristic can be defined for the following entities:</p> <ul style="list-style-type: none"> • Policy Plan • Policy <p>Here, you must specify a characteristic type where the characteristic entity is set to Policy Plan and Policy.</p> <div style="border: 1px solid black; padding: 2px;"> <p>Note: The NEWBORNA characteristic type is shipped with the product.</p> </div>	<p>Subscription Tier Structure Characteristic Type</p>	<p>Used to specify the characteristic type that indicates the subscription tier structure which should be considered while deriving the subscription tier for a membership. This type of characteristic can be defined for the following entities:</p> <ul style="list-style-type: none"> • Policy Plan • Policy <p>Here, you must specify a characteristic type where the characteristic entity is set to Policy Plan and Policy.</p> <div style="border: 1px solid black; padding: 2px;"> <p>Note: The C1-STRST characteristic type is shipped with the product.</p> </div>	
<p>New Born Gift Days Applicability Characteristic Type</p>	<p>Used to specify the characteristic type that indicates whether you want to offer gift days in case of a new born. The system supports the following two characteristic values — Y and N. This type of characteristic can be defined for the following entities:</p> <ul style="list-style-type: none"> • Policy Plan • Policy <p>Here, you must specify a characteristic type where the characteristic entity is set to Policy Plan and Policy.</p> <div style="border: 1px solid black; padding: 2px;"> <p>Note: The NEWBORNA characteristic type is shipped with the product.</p> </div>					
<p>Subscription Tier Structure Characteristic Type</p>	<p>Used to specify the characteristic type that indicates the subscription tier structure which should be considered while deriving the subscription tier for a membership. This type of characteristic can be defined for the following entities:</p> <ul style="list-style-type: none"> • Policy Plan • Policy <p>Here, you must specify a characteristic type where the characteristic entity is set to Policy Plan and Policy.</p> <div style="border: 1px solid black; padding: 2px;"> <p>Note: The C1-STRST characteristic type is shipped with the product.</p> </div>					

Field Name	Field Description		Mandatory (Yes or No)
	Subscription Tier Characteristic Type	<p>Used to specify the characteristic type where you can store the subscription tier for a membership. This type of characteristic is defined for the membership. Here, you must specify a characteristic type where the characteristic entity is set to Membership.</p> <p>Note: The C1-SUBST characteristic type is shipped with the product.</p>	
	Young Adult Max Age Limit Characteristic Type	<p>Used to specify the characteristic type that indicates the maximum age limit for young adults which are eligible for premium calculation. This type of characteristic can be defined for the following entities:</p> <ul style="list-style-type: none"> • Policy Plan • Policy <p>Here, you must specify a characteristic type where the characteristic entity is set to Policy Plan and Policy.</p> <p>Note: The YADULTAG characteristic type is shipped with the product. Here, you must define the required predefined characteristic values.</p>	
	Young Adult Max Age Limit Applicability Characteristic Type	<p>Used to specify the characteristic type that indicates whether you want to consider the young adults during the premium calculation. The system supports the following two characteristic values — Y and N.</p>	

Field Name	Field Description	Mandatory (Yes or No)		
	<table border="1"> <tr> <td></td> <td> <p>This type of characteristic can be defined for the following entities:</p> <ul style="list-style-type: none"> • Policy Plan • Policy <p>Here, you must specify a characteristic type where the characteristic entity is set to Policy Plan and Policy.</p> </td> </tr> </table>		<p>This type of characteristic can be defined for the following entities:</p> <ul style="list-style-type: none"> • Policy Plan • Policy <p>Here, you must specify a characteristic type where the characteristic entity is set to Policy Plan and Policy.</p>	
	<p>This type of characteristic can be defined for the following entities:</p> <ul style="list-style-type: none"> • Policy Plan • Policy <p>Here, you must specify a characteristic type where the characteristic entity is set to Policy Plan and Policy.</p>			
Entity Type	<p>Used to indicate the type of entity for which the attribute is applicable. The valid values are:</p> <ul style="list-style-type: none"> • Account • Billable Charge <p>Note: At present, this data is stored for informational purposes only and is not considered in the business logic. If required, you can add more entity types to the MAP_ENTITY_FLG lookup field.</p>	No		

Note: While defining a member relationship and subscription tier preference, you must set at least one attribute in the member relationship and subscription tier preference.

6. Select the **Member Relationship and Subscription Tier Preferences** option from the **Preference Category** list.
7. Enter the required details in the **Main** section.
8. Select the required attribute and value from the respective fields.
9. If you want to set more than one attribute in the member relationship and subscription tier preference, click the **Add (+)** icon and then repeat step 8.

Note: However, if you want to remove an attribute from the member relationship and subscription tier preference, click the **Delete (🗑)** icon corresponding to the attribute.

10. Click **Save**.

The member relationship and subscription tier preference is defined.

Editing a Member Relationship and Subscription Tier Preference

Prerequisites

To edit a member relationship and subscription tier preference, you should have:

- Required characteristic types defined in the application
- Values defined in the **MAP_ENTITY_FLG** lookup field

Procedure

To edit a member relationship and subscription tier preference:

1. Search for the member relationship and subscription tier preference in the **Field Mapping** screen.
2. In the **Search Results** section, click the **Edit** (✎) icon in the **Edit** column corresponding to the member relationship and subscription tier preference whose details you want to edit.

The **Field Mapping** screen appears. It contains the following sections:

- **Main** - Used to specify basic details of the member relationship and subscription tier preference. It contains the following fields:

Field Name	Field Description	Mandatory (Yes or No)
Preference	Displays the member relationship and subscription tier preference.	Not applicable
Description	Used to specify the description for the member relationship and subscription tier preference.	Yes
Detailed Description	Used to specify additional information about the member relationship and subscription tier preference.	No
Status	Used to indicate the status of the member relationship and subscription tier preference. The valid values are: <ul style="list-style-type: none"> • Active • Inactive 	Yes
Preference Category	Indicates the category to which the preference belongs. The valid value is: <ul style="list-style-type: none"> • Member Relationship and Subscription Tier 	Not applicable

- **Preference Settings** - Used to set the attributes in the member relationship and subscription tier preference. It contains the following fields in a grid:

Field Name	Field Description	Mandatory (Yes or No)
Attribute	<p>Used to indicate the attribute which you want to set in the member relationship and subscription tier preference. The valid values are:</p> <ul style="list-style-type: none"> • Age Calculation Date Basis Characteristic Type - Used when the system derives the member relationship for a member person and the subscription tier for a membership. • Max Age Limit for Max Dependent Count Characteristic Type - Used when the system derives the member relationship for a member person and the subscription tier for a membership. • Max Number of Dependents Order Priority Characteristic Type - Used when the system derives the member relationship for a member person and the subscription tier for a membership. 	<p>Yes (Conditional)</p> <div style="border: 1px solid black; padding: 5px; margin-top: 5px;"> <p>Note: This field is required while setting an attribute in the member relationship and subscription tier preference.</p> </div>

Field Name	Field Description	Mandatory (Yes or No)
	<ul style="list-style-type: none"> • Member Relationship Characteristic Type - Used when the system stores the member relationship for a member person. • Maximum Number of Dependents Characteristic Type - Used when the system derives the member relationship for a member person and the subscription tier for a membership. • Member Relationship Derivation Date Characteristic Type - Used when the system derives the member relationship for a member person. • Member Relationship Structure Characteristic Type - Used when the system derives the member relationship for a member person. • New Born Gift Days Characteristic Type - Used when the system derives the member relationship for a member person and the subscription tier for a membership. • New Born Gift Days Applicability Characteristic Type - Used when the system derives the member relationship for a member person and the subscription tier for a membership. • Subscription Tier Structure Characteristic Type - Used when the system derives the subscription tier for a membership. • Subscription Tier Characteristic Type - Used when the system stores the subscription tier for a membership. • Young Adult Max Age Limit Characteristic Type - Used when the system derives the member relationship for a member person and the subscription tier for a membership. • Young Adult Max Age Limit Applicability Characteristic Type - Used when the system derives the member relationship for a member person and the subscription tier for a membership. 	

Field Name	Field Description	Mandatory (Yes or No)						
Value	Used to specify the attribute value. The attribute value that you can specify varies depending on the attribute you want to set in the member relationship and subscription tier preference:	Yes (Conditional)						
	<table border="1" data-bbox="639 390 1177 1522"> <thead> <tr> <th data-bbox="639 390 867 474">If the attribute is set to...</th> <th data-bbox="867 390 1177 474">Then, this field is...</th> </tr> </thead> <tbody> <tr> <td data-bbox="639 474 867 1522">Age Calculation Date Basis Characteristic Type</td> <td data-bbox="867 474 1177 1522"> <p>Used to specify the characteristic type that indicates how the member person's age should be calculated. The system supports the following characteristic values:</p> <ul style="list-style-type: none"> • Member Enrollment Date • Member Enrollment Nearest Age • Plan Start Date • Policy Renewal/ Start Date <p>This type of characteristic can be defined for the following entities:</p> <ul style="list-style-type: none"> • Policy Plan • Policy <p>Here, you must specify a characteristic type where the characteristic entity is set to Policy Plan and Policy.</p> <div data-bbox="873 1388 1170 1503" style="border: 1px solid black; padding: 2px;"> <p>Note: The C1-AGCAL characteristic type is shipped with the product.</p> </div> </td> </tr> <tr> <td data-bbox="639 1522 867 1946">Max Age Limit for Max Dependent Count Characteristic Type</td> <td data-bbox="867 1522 1177 1946"> <p>Used to specify the characteristic type that indicates the maximum age limit for children which are eligible for premium calculation. This type of characteristic can be defined for the following entities:</p> <ul style="list-style-type: none"> • Policy Plan • Policy </td> </tr> </tbody> </table>	If the attribute is set to...	Then, this field is...	Age Calculation Date Basis Characteristic Type	<p>Used to specify the characteristic type that indicates how the member person's age should be calculated. The system supports the following characteristic values:</p> <ul style="list-style-type: none"> • Member Enrollment Date • Member Enrollment Nearest Age • Plan Start Date • Policy Renewal/ Start Date <p>This type of characteristic can be defined for the following entities:</p> <ul style="list-style-type: none"> • Policy Plan • Policy <p>Here, you must specify a characteristic type where the characteristic entity is set to Policy Plan and Policy.</p> <div data-bbox="873 1388 1170 1503" style="border: 1px solid black; padding: 2px;"> <p>Note: The C1-AGCAL characteristic type is shipped with the product.</p> </div>	Max Age Limit for Max Dependent Count Characteristic Type	<p>Used to specify the characteristic type that indicates the maximum age limit for children which are eligible for premium calculation. This type of characteristic can be defined for the following entities:</p> <ul style="list-style-type: none"> • Policy Plan • Policy 	<p>Note: This field is required while setting an attribute in the member relationship and subscription tier preference.</p>
	If the attribute is set to...	Then, this field is...						
Age Calculation Date Basis Characteristic Type	<p>Used to specify the characteristic type that indicates how the member person's age should be calculated. The system supports the following characteristic values:</p> <ul style="list-style-type: none"> • Member Enrollment Date • Member Enrollment Nearest Age • Plan Start Date • Policy Renewal/ Start Date <p>This type of characteristic can be defined for the following entities:</p> <ul style="list-style-type: none"> • Policy Plan • Policy <p>Here, you must specify a characteristic type where the characteristic entity is set to Policy Plan and Policy.</p> <div data-bbox="873 1388 1170 1503" style="border: 1px solid black; padding: 2px;"> <p>Note: The C1-AGCAL characteristic type is shipped with the product.</p> </div>							
Max Age Limit for Max Dependent Count Characteristic Type	<p>Used to specify the characteristic type that indicates the maximum age limit for children which are eligible for premium calculation. This type of characteristic can be defined for the following entities:</p> <ul style="list-style-type: none"> • Policy Plan • Policy 							

Field Name	Field Description		Mandatory (Yes or No)
		<p>Here, you must specify a characteristic type where the characteristic entity is set to Policy Plan and Policy.</p>	
	<p>Max Number of Dependents Order Priority Characteristic Type</p>	<p>Used to specify the characteristic type that indicates whether the system should first consider youngest or eldest children during premium calculation. The system supports the following two characteristic values — Youngest and Eldest. This type of characteristic can be defined for the following entities:</p> <ul style="list-style-type: none"> • Policy Plan • Policy <p>Here, you must specify a characteristic type where the characteristic entity is set to Policy Plan and Policy.</p> <div style="border: 1px solid black; padding: 2px;"> <p>Note: The DEPORPRI characteristic type is shipped with the product.</p> </div>	
	<p>Member Relationship Characteristic Type</p>	<p>Used to specify the characteristic type where you can store the member relationship for a member person. This type of characteristic is defined for the member person. Here, you must specify a characteristic type where the characteristic entity is set to Membership Person.</p> <div style="border: 1px solid black; padding: 2px;"> <p>Note: The C1-MEMRL characteristic type is shipped with the product.</p> </div>	

Field Name	Field Description		Mandatory (Yes or No)
	Maximum Number of Dependents Characteristic Type	<p>Used to specify the characteristic type that indicates the maximum number of dependent persons which are eligible for premium calculation. This type of characteristic can be defined for the following entities:</p> <ul style="list-style-type: none"> • Policy Plan • Policy <p>Here, you must specify a characteristic type where the characteristic entity is set to Policy Plan and Policy.</p>	
	Member Relationship Derivation Date Characteristic Type	<p>Used to specify the characteristic type that indicates whether the member relationship should be derived for a member person using its date of birth or enrollment date. The system supports the following two characteristic values — Date of Birth and Enrollment Date. This type of characteristic can be defined for the following entities:</p> <ul style="list-style-type: none"> • Policy Plan • Policy <p>Here, you must specify a characteristic type where the characteristic entity is set to Policy Plan and Policy.</p> <div style="border: 1px solid black; padding: 5px; margin-top: 10px;"> <p>Note: The C1-MRDDDB characteristic type is shipped with the product.</p> </div>	

Field Name	Field Description		Mandatory (Yes or No)
	Member Relationship Structure Characteristic Type	<p>Used to specify the characteristic type that indicates the member relationship structure which should be considered while deriving the member relationship for a member person. This type of characteristic can be defined for the following entities:</p> <ul style="list-style-type: none"> • Policy Plan • Policy <p>Here, you must specify a characteristic type where the characteristic entity is set to Policy Plan and Policy.</p> <div style="border: 1px solid black; padding: 2px;"> <p>Note: The C1-MRLST characteristic type is shipped with the product.</p> </div>	
	New Born Gift Days Characteristic Type	<p>Used to specify the characteristic type that indicates the number of days you want to offer as gift days from the new born child's birth date. This type of characteristic can be defined for the following entities:</p> <ul style="list-style-type: none"> • Policy Plan • Policy <p>Here, you must specify a characteristic type where the characteristic entity is set to Policy Plan and Policy.</p> <div style="border: 1px solid black; padding: 2px;"> <p>Note: The NOOFGIFT characteristic type is shipped with the product. Here, you must define the required predefined characteristic values.</p> </div>	

Field Name	Field Description	Mandatory (Yes or No)				
	<table border="1"> <tr> <td data-bbox="641 254 865 1066"> <p>New Born Gift Days Applicability Characteristic Type</p> </td> <td data-bbox="865 254 1182 1066"> <p>Used to specify the characteristic type that indicates whether you want to offer gift days in case of a new born. The system supports the following two characteristic values — Y and N. This type of characteristic can be defined for the following entities:</p> <ul style="list-style-type: none"> • Policy Plan • Policy <p>Here, you must specify a characteristic type where the characteristic entity is set to Policy Plan and Policy.</p> <div data-bbox="873 936 1174 1056" style="border: 1px solid black; padding: 2px;"> <p>Note: The NEWBORNA characteristic type is shipped with the product.</p> </div> </td> </tr> <tr> <td data-bbox="641 1066 865 1810"> <p>Subscription Tier Structure Characteristic Type</p> </td> <td data-bbox="865 1066 1182 1810"> <p>Used to specify the characteristic type that indicates the subscription tier structure which should be considered while deriving the subscription tier for a membership. This type of characteristic can be defined for the following entities:</p> <ul style="list-style-type: none"> • Policy Plan • Policy <p>Here, you must specify a characteristic type where the characteristic entity is set to Policy Plan and Policy.</p> <div data-bbox="873 1682 1174 1801" style="border: 1px solid black; padding: 2px;"> <p>Note: The C1-STRST characteristic type is shipped with the product.</p> </div> </td> </tr> </table>	<p>New Born Gift Days Applicability Characteristic Type</p>	<p>Used to specify the characteristic type that indicates whether you want to offer gift days in case of a new born. The system supports the following two characteristic values — Y and N. This type of characteristic can be defined for the following entities:</p> <ul style="list-style-type: none"> • Policy Plan • Policy <p>Here, you must specify a characteristic type where the characteristic entity is set to Policy Plan and Policy.</p> <div data-bbox="873 936 1174 1056" style="border: 1px solid black; padding: 2px;"> <p>Note: The NEWBORNA characteristic type is shipped with the product.</p> </div>	<p>Subscription Tier Structure Characteristic Type</p>	<p>Used to specify the characteristic type that indicates the subscription tier structure which should be considered while deriving the subscription tier for a membership. This type of characteristic can be defined for the following entities:</p> <ul style="list-style-type: none"> • Policy Plan • Policy <p>Here, you must specify a characteristic type where the characteristic entity is set to Policy Plan and Policy.</p> <div data-bbox="873 1682 1174 1801" style="border: 1px solid black; padding: 2px;"> <p>Note: The C1-STRST characteristic type is shipped with the product.</p> </div>	
<p>New Born Gift Days Applicability Characteristic Type</p>	<p>Used to specify the characteristic type that indicates whether you want to offer gift days in case of a new born. The system supports the following two characteristic values — Y and N. This type of characteristic can be defined for the following entities:</p> <ul style="list-style-type: none"> • Policy Plan • Policy <p>Here, you must specify a characteristic type where the characteristic entity is set to Policy Plan and Policy.</p> <div data-bbox="873 936 1174 1056" style="border: 1px solid black; padding: 2px;"> <p>Note: The NEWBORNA characteristic type is shipped with the product.</p> </div>					
<p>Subscription Tier Structure Characteristic Type</p>	<p>Used to specify the characteristic type that indicates the subscription tier structure which should be considered while deriving the subscription tier for a membership. This type of characteristic can be defined for the following entities:</p> <ul style="list-style-type: none"> • Policy Plan • Policy <p>Here, you must specify a characteristic type where the characteristic entity is set to Policy Plan and Policy.</p> <div data-bbox="873 1682 1174 1801" style="border: 1px solid black; padding: 2px;"> <p>Note: The C1-STRST characteristic type is shipped with the product.</p> </div>					

Field Name	Field Description		Mandatory (Yes or No)
	Subscription Tier Characteristic Type	<p>Used to specify the characteristic type where you can store the subscription tier for a membership. This type of characteristic is defined for the membership. Here, you must specify a characteristic type where the characteristic entity is set to Membership.</p> <div data-bbox="873 632 1182 747" style="border: 1px solid black; padding: 2px;"> <p>Note: The C1-SUBST characteristic type is shipped with the product.</p> </div>	
	Young Adult Max Age Limit Characteristic Type	<p>Used to specify the characteristic type that indicates the maximum age limit for young adults which are eligible for premium calculation. This type of characteristic can be defined for the following entities:</p> <ul style="list-style-type: none"> • Policy Plan • Policy <p>Here, you must specify a characteristic type where the characteristic entity is set to Policy Plan and Policy.</p> <div data-bbox="873 1350 1182 1570" style="border: 1px solid black; padding: 2px;"> <p>Note: The YADULTAG characteristic type is shipped with the product. Here, you must define the required predefined characteristic values.</p> </div>	

Field Name	Field Description	Mandatory (Yes or No)		
	<table border="1"> <tr> <td>Young Adult Max Age Limit Applicability Characteristic Type</td> <td> <p>Used to specify the characteristic type that indicates whether you want to consider the young adults during the premium calculation. The system supports the following two characteristic values — Y and N. This type of characteristic can be defined for the following entities:</p> <ul style="list-style-type: none"> • Policy Plan • Policy <p>Here, you must specify a characteristic type where the characteristic entity is set to Policy Plan and Policy.</p> </td> </tr> </table>	Young Adult Max Age Limit Applicability Characteristic Type	<p>Used to specify the characteristic type that indicates whether you want to consider the young adults during the premium calculation. The system supports the following two characteristic values — Y and N. This type of characteristic can be defined for the following entities:</p> <ul style="list-style-type: none"> • Policy Plan • Policy <p>Here, you must specify a characteristic type where the characteristic entity is set to Policy Plan and Policy.</p>	
Young Adult Max Age Limit Applicability Characteristic Type	<p>Used to specify the characteristic type that indicates whether you want to consider the young adults during the premium calculation. The system supports the following two characteristic values — Y and N. This type of characteristic can be defined for the following entities:</p> <ul style="list-style-type: none"> • Policy Plan • Policy <p>Here, you must specify a characteristic type where the characteristic entity is set to Policy Plan and Policy.</p>			
Entity Type	<p>Used to indicate the type of entity for which the attribute is applicable. The valid values are:</p> <ul style="list-style-type: none"> • Account • Billable Charge <p>Note: At present, this data is stored for informational purposes only and is not considered in the business logic. If required, you can add more entity types to the MAP_ENTITY_FLG lookup field.</p>	No		

Tip: Alternatively, you can edit the details of a member relationship and subscription tier preference by clicking the **Edit** button in the **Field Mapping** zone.

3. Modify the required details in the **Main** section.
4. Define, edit, or remove the attribute from the member relationship and subscription tier preference, if required.

Note: You must set at least one attribute in a member relationship and subscription tier preference.

5. Click **Save**.

The changes made to the member relationship and subscription tier preference are saved.

Related Topics

For more information on...	See...
How to search for a member relationship and subscription tier preference	Searching for a Member Relationship and Subscription Tier Preference on page 210

Copying a Member Relationship and Subscription Tier Preference

Instead of creating a member relationship and subscription tier preference from scratch, you can create a new member relationship and subscription tier preference using an existing member relationship and subscription tier preference. This is possible through copying a member relationship and subscription tier preference. On copying a member relationship and subscription tier preference, the details including the attributes are copied to the new member relationship and subscription tier preference. You can then edit the details, if required.

Prerequisites

To copy a member relationship and subscription tier preference, you should have:

- Member relationship and subscription tier preference (whose copy you want to create) defined in the application
- Required characteristic types defined in the application
- Values defined in the **MAP_ENTITY_FLG** lookup field

Procedure

To copy a member relationship and subscription tier preference:

1. Search for the member relationship and subscription tier preference in the **Field Mapping** screen.
2. In the **Search Results** section, click the **Duplicate**  icon in the **Duplicate** column corresponding to the member relationship and subscription tier preference whose copy you want to create.

The **Field Mapping** screen appears. It contains the following sections:

- **Main** - Used to specify basic details of the member relationship and subscription tier preference. It contains the following fields:

Field Name	Field Description	Mandatory (Yes or No)
Preference	Used to specify the member relationship and subscription tier preference.	Yes
Description	Used to specify the description for the member relationship and subscription tier preference.	Yes
Detailed Description	Used to specify additional information about the member relationship and subscription tier preference.	No
Status	Used to indicate the status of the member relationship and subscription tier preference. The valid values are: <ul style="list-style-type: none"> • Active • Inactive 	Yes
Preference Category	Indicates the category to which the preference belongs. The valid value is: <ul style="list-style-type: none"> • Member Relationship and Subscription Tier 	Not applicable

- **Preference Settings** - Used to set the attributes in the member relationship and subscription tier preference. It contains the following fields in a grid:

Field Name	Field Description	Mandatory (Yes or No)
Attribute	<p>Used to indicate the attribute which you want to set in the member relationship and subscription tier preference. The valid values are:</p> <ul style="list-style-type: none"> • Age Calculation Date Basis Characteristic Type - Used when the system derives the member relationship for a member person and the subscription tier for a membership. • Max Age Limit for Max Dependent Count Characteristic Type - Used when the system derives the member relationship for a member person and the subscription tier for a membership. • Max Number of Dependents Order Priority Characteristic Type - Used when the system derives the member relationship for a member person and the subscription tier for a membership. • Member Relationship Characteristic Type - Used when the system stores the member relationship for a member person. • Maximum Number of Dependents Characteristic Type - Used when the system derives the member relationship for a member person and the subscription tier for a membership. • Member Relationship Derivation Date Characteristic Type - Used when the system derives the member relationship for a member person. • Member Relationship Structure Characteristic Type - Used when the system derives the member relationship for a member person. • New Born Gift Days Characteristic Type - Used when the system derives the member relationship for a member person and the subscription tier for a membership. • New Born Gift Days Applicability Characteristic Type - Used when the system derives the member relationship for a member person and the subscription tier for a membership. 	<p>Yes (Conditional)</p> <div style="border: 1px solid black; padding: 5px; margin-top: 10px;"> <p>Note: This field is required while setting an attribute in the member relationship and subscription tier preference.</p> </div>

Field Name	Field Description	Mandatory (Yes or No)				
	<ul style="list-style-type: none"> • Subscription Tier Structure Characteristic Type - Used when the system derives the subscription tier for a membership. • Subscription Tier Characteristic Type - Used when the system stores the subscription tier for a membership. • Young Adult Max Age Limit Characteristic Type - Used when the system derives the member relationship for a member person and the subscription tier for a membership. • Young Adult Max Age Limit Applicability Characteristic Type - Used when the system derives the member relationship for a member person and the subscription tier for a membership. 					
Value	<p>Used to specify the attribute value. The attribute value that you can specify varies depending on the attribute you want to set in the member relationship and subscription tier preference:</p> <table border="1" data-bbox="639 982 1182 1808"> <thead> <tr> <th data-bbox="639 982 867 1066">If the attribute is set to...</th> <th data-bbox="867 982 1182 1066">Then, this field is...</th> </tr> </thead> <tbody> <tr> <td data-bbox="639 1066 867 1808">Age Calculation Date Basis Characteristic Type</td> <td data-bbox="867 1066 1182 1808"> <p>Used to specify the characteristic type that indicates how the member person's age should be calculated. The system supports the following characteristic values:</p> <ul style="list-style-type: none"> • Member Enrollment Date • Member Enrollment Nearest Age • Plan Start Date • Policy Renewal/ Start Date <p>This type of characteristic can be defined for the following entities:</p> <ul style="list-style-type: none"> • Policy Plan • Policy </td> </tr> </tbody> </table>	If the attribute is set to...	Then, this field is...	Age Calculation Date Basis Characteristic Type	<p>Used to specify the characteristic type that indicates how the member person's age should be calculated. The system supports the following characteristic values:</p> <ul style="list-style-type: none"> • Member Enrollment Date • Member Enrollment Nearest Age • Plan Start Date • Policy Renewal/ Start Date <p>This type of characteristic can be defined for the following entities:</p> <ul style="list-style-type: none"> • Policy Plan • Policy 	<p>Yes (Conditional)</p> <p>Note: This field is required while setting an attribute in the member relationship and subscription tier preference.</p>
If the attribute is set to...	Then, this field is...					
Age Calculation Date Basis Characteristic Type	<p>Used to specify the characteristic type that indicates how the member person's age should be calculated. The system supports the following characteristic values:</p> <ul style="list-style-type: none"> • Member Enrollment Date • Member Enrollment Nearest Age • Plan Start Date • Policy Renewal/ Start Date <p>This type of characteristic can be defined for the following entities:</p> <ul style="list-style-type: none"> • Policy Plan • Policy 					

Field Name	Field Description		Mandatory (Yes or No)
		<p>Here, you must specify a characteristic type where the characteristic entity is set to Policy Plan and Policy.</p> <p>Note: The C1-AGCAL characteristic type is shipped with the product.</p>	
	<p>Max Age Limit for Max Dependent Count Characteristic Type</p>	<p>Used to specify the characteristic type that indicates the maximum age limit for children which are eligible for premium calculation. This type of characteristic can be defined for the following entities:</p> <ul style="list-style-type: none"> • Policy Plan • Policy <p>Here, you must specify a characteristic type where the characteristic entity is set to Policy Plan and Policy.</p>	
	<p>Max Number of Dependents Order Priority Characteristic Type</p>	<p>Used to specify the characteristic type that indicates whether the system should first consider youngest or eldest children during premium calculation. The system supports the following two characteristic values — Youngest and Eldest. This type of characteristic can be defined for the following entities:</p> <ul style="list-style-type: none"> • Policy Plan • Policy 	

Field Name	Field Description		Mandatory (Yes or No)
		<p>Here, you must specify a characteristic type where the characteristic entity is set to Policy Plan and Policy.</p> <p>Note: The DEPORPRI characteristic type is shipped with the product.</p>	
	Member Relationship Characteristic Type	<p>Used to specify the characteristic type where you can store the member relationship for a member person. This type of characteristic is defined for the member person. Here, you must specify a characteristic type where the characteristic entity is set to Membership Person.</p> <p>Note: The C1-MEMRL characteristic type is shipped with the product.</p>	
	Maximum Number of Dependents Characteristic Type	<p>Used to specify the characteristic type that indicates the maximum number of dependent persons which are eligible for premium calculation. This type of characteristic can be defined for the following entities:</p> <ul style="list-style-type: none"> • Policy Plan • Policy <p>Here, you must specify a characteristic type where the characteristic entity is set to Policy Plan and Policy.</p>	

Field Name	Field Description		Mandatory (Yes or No)
	Member Relationship Derivation Date Characteristic Type	<p>Used to specify the characteristic type that indicates whether the member relationship should be derived for a member person using its date of birth or enrollment date. The system supports the following two characteristic values — Date of Birth and Enrollment Date. This type of characteristic can be defined for the following entities:</p> <ul style="list-style-type: none"> • Policy Plan • Policy <p>Here, you must specify a characteristic type where the characteristic entity is set to Policy Plan and Policy.</p> <div style="border: 1px solid black; padding: 2px;"> <p>Note: The C1-MRDDDB characteristic type is shipped with the product.</p> </div>	
	Member Relationship Structure Characteristic Type	<p>Used to specify the characteristic type that indicates the member relationship structure which should be considered while deriving the member relationship for a member person. This type of characteristic can be defined for the following entities:</p> <ul style="list-style-type: none"> • Policy Plan • Policy <p>Here, you must specify a characteristic type where the characteristic entity is set to Policy Plan and Policy.</p>	

Field Name	Field Description		Mandatory (Yes or No)
		<p>Note: The C1-MRLST characteristic type is shipped with the product.</p>	
	<p>New Born Gift Days Characteristic Type</p>	<p>Used to specify the characteristic type that indicates the number of days you want to offer as gift days from the new born child's birth date. This type of characteristic can be defined for the following entities:</p> <ul style="list-style-type: none"> • Policy Plan • Policy <p>Here, you must specify a characteristic type where the characteristic entity is set to Policy Plan and Policy.</p> <p>Note: The NOOFGIFT characteristic type is shipped with the product. Here, you must define the required predefined characteristic values.</p>	
	<p>New Born Gift Days Applicability Characteristic Type</p>	<p>Used to specify the characteristic type that indicates whether you want to offer gift days in case of a new born. The system supports the following two characteristic values — Y and N. This type of characteristic can be defined for the following entities:</p> <ul style="list-style-type: none"> • Policy Plan • Policy 	

Field Name	Field Description		Mandatory (Yes or No)
		<p>Here, you must specify a characteristic type where the characteristic entity is set to Policy Plan and Policy.</p> <p>Note: The NEWBORNA characteristic type is shipped with the product.</p>	
	Subscription Tier Structure Characteristic Type	<p>Used to specify the characteristic type that indicates the subscription tier structure which should be considered while deriving the subscription tier for a membership. This type of characteristic can be defined for the following entities:</p> <ul style="list-style-type: none"> • Policy Plan • Policy <p>Here, you must specify a characteristic type where the characteristic entity is set to Policy Plan and Policy.</p> <p>Note: The C1-STRST characteristic type is shipped with the product.</p>	
	Subscription Tier Characteristic Type	<p>Used to specify the characteristic type where you can store the subscription tier for a membership. This type of characteristic is defined for the membership. Here, you must specify a characteristic type where the characteristic entity is set to Membership.</p>	

Field Name	Field Description		Mandatory (Yes or No)
		<p>Note: The C1-SUBST characteristic type is shipped with the product.</p>	
	<p>Young Adult Max Age Limit Characteristic Type</p>	<p>Used to specify the characteristic type that indicates the maximum age limit for young adults which are eligible for premium calculation. This type of characteristic can be defined for the following entities:</p> <ul style="list-style-type: none"> • Policy Plan • Policy <p>Here, you must specify a characteristic type where the characteristic entity is set to Policy Plan and Policy.</p> <p>Note: The YADULTAG characteristic type is shipped with the product. Here, you must define the required predefined characteristic values.</p>	
	<p>Young Adult Max Age Limit Applicability Characteristic Type</p>	<p>Used to specify the characteristic type that indicates whether you want to consider the young adults during the premium calculation. The system supports the following two characteristic values — Y and N. This type of characteristic can be defined for the following entities:</p> <ul style="list-style-type: none"> • Policy Plan • Policy 	

Field Name	Field Description	Mandatory (Yes or No)		
	<table border="1"> <tr> <td></td> <td>Here, you must specify a characteristic type where the characteristic entity is set to Policy Plan and Policy.</td> </tr> </table>		Here, you must specify a characteristic type where the characteristic entity is set to Policy Plan and Policy .	
	Here, you must specify a characteristic type where the characteristic entity is set to Policy Plan and Policy .			
Entity Type	<p>Used to indicate the type of entity for which the attribute is applicable. The valid values are:</p> <ul style="list-style-type: none"> Account Billable Charge <p>Note: At present, this data is stored for informational purposes only and is not considered in the business logic. If required, you can add more entity types to the MAP_ENTITY_FLG lookup field.</p>	No		

Note: While defining a member relationship and subscription tier preference, you must set at least one attribute in the member relationship and subscription tier preference.

Tip: Alternatively, you can copy a member relationship and subscription tier preference by clicking the **Duplicate** button in the **Field Mapping** zone.

- Enter the required details in the **Main** section.
- Define, edit, or remove the attribute from the member relationship and subscription tier preference, if required.
- Click **Save**.

The new member relationship and subscription tier preference is defined.

Related Topics

For more information on...	See...
How to search for a member relationship and subscription tier preference	Searching for a Member Relationship and Subscription Tier Preference on page 210

Deleting a Member Relationship and Subscription Tier Preference

Procedure

To delete a member relationship and subscription tier preference:

- Search for the member relationship and subscription tier preference in the **Field Mapping** screen.
- In the **Search Results** section, click the **Delete** (🗑️) icon in the **Delete** column corresponding to the member relationship and subscription tier preference that you want to delete.

A message appears confirming whether you want to delete the member relationship and subscription tier preference.

Tip: Alternatively, you can delete a member relationship and subscription tier preference by clicking the **Delete** button in the **Field Mapping** zone.

3. Click OK.

The member relationship and subscription tier preference is deleted.

Related Topics

For more information on...	See...
How to search for a member relationship and subscription tier preference	Searching for a Member Relationship and Subscription Tier Preference on page 210

Chapter

4

Fully-Insured Group Health Insurance

Topics:

- [Pre-requisites](#)
- [Fully-Insured Group Policy](#)
- [Fully-Insured Group Policy Status Transition](#)
- [Membership Status Transition](#)
- [Types of Policy Plan](#)
- [Types of Membership](#)
- [Algorithms Used in C1-POLICY](#)
- [Algorithms Used in C1-PolicyPlan](#)
- [Algorithms Used in C1-Membership](#)
- [Late Setup Notification](#)
- [Policy \(Used for Searching\)](#)
- [Policy \(Used for Viewing\)](#)
- [Policy Plan \(Used for Viewing\)](#)
- [Membership \(Used for Searching\)](#)
- [Membership \(Used for Viewing\)](#)

Group insurance health plans provide coverage to a group of members, usually comprised of company employees or members of an organization. Among all types of group insurance health plans, the fully-insured plan is one of the traditional ways to structure an employer-sponsored health plan. It is also commonly known as fully-insured employee health insurance.

In the fully-insured group health plan, the employer contracts an insurance company to cover the employees and their dependents. The employer pays a premium to the insurance carrier. The premium rates are fixed for a year based on the number of employees which are enrolled in the plan. The monthly premium changes during the year when the number of enrolled employees change in the plan. The insurance carrier collects the premium from the employer and pays the health insurance claims to the employees based on the coverage benefits outlined in the policy. The covered persons (i.e. employees and dependents) are responsible to pay any deductible amounts or co-payments required for covered services under the policy.

Oracle Revenue Management and Billing (ORMB) provides specialized methodologies for calculating premium for the employees and their dependents and then bill the total premium to the employer (known as the parent customer in ORMB) or to its logical designed billing entities (known as the bill groups in ORMB). The system enables you to offer different rates for a covered service depending on the following:

- Age of the employee or dependent
- How dependent person is related to the main subscriber
- Membership subscription tier
- Geographic rating area
- Membership or member person attributes

Oracle Revenue Management and Billing (ORMB) enables you to use the pricing methodologies and the billing engine for the fully-insured group health insurance business. To design the pricing and billing models for the fully-insured group health insurance business, you need to create the following entities in ORMB:

- Parent Customer
- Bill Groups
- Bill Group's Account
- Fully-Insured Group Policy
- Policy Plans
- Price Items (for each covered service in the policy)

- Pricing Rule Types
- Pricing Rules

Pre-requisites

To set the billing system for a fully-insured group customer, you need to do the following:

- Define the required policy types in the system.
- Define the required policy person roles in the system.
- Define the values for the **C1-SourceSystemLookup** extendable lookup.
- Define the required characteristic types where the characteristic entity is set to **Policy Type**.
- Define the required characteristic types where the characteristic entity is set to **Policy**.
- Define the status reasons for the **Terminated** status of the **C1-POLICY** business object in the **Status Reason** screen.
- Define the status reasons for the **Reinstated** status of the **C1-POLICY** business object in the **Status Reason** screen.
- Define the required price items in the system.
- Define the required age based, tier based, pass-through billable charge, additional charge, and/or benefit pricing rule types.
- Define the required characteristic types where the characteristic entity is set to **Policy Plan**.
- Define the required contract relationship types in the system.
- Define the required characteristic types where the characteristic entity is set to **Membership**.
- Define the required characteristic types where the characteristic entity is set to **Membership Person**.
- Define the required characteristic types where the characteristic entity is set to **Benefits**.
- Define the required contracts (which you want to associate with a membership) in the system.
- Define the values for the **BILL_TO_TYPE_FLG**, **BENEFIT_TYPE_FLG**, **BENEFIT_SUB_TYPE_FLG**, and **BENEFIT_SRC_FLG** lookup fields
- Define the required parameter values in the following algorithm which is attached to the **C1-POLICY** business object:
 - C1-POLBOVAL
- Define the required parameter values in the following algorithms which are used in the lifecycle of the **C1-POLICY** business object:
 - C1-EVCSTSTAT
 - C1-PLCYTRMRQ
 - C1-POLCYTERM
 - C1-DELTRMLTR
 - C1-PLCYREIRQ
 - C1-POLCYREIN
 - C1-CCPOLRE1
- Define a predefined characteristic type named **Active Employee Coverage Billing Arrangement** with the following characteristic values:

Characteristic Value	Description
DRT	Direct Billing
GRP	Group Billing

You must set the characteristic entity of the **Active Employee Coverage Billing Arrangement** characteristic type to **Person**.

- Define a predefined characteristic type named **Benefit Billing Arrangement** with the following characteristic values:

Characteristic Value	Description
DRT	Direct Billing
GRP	Group Billing

You must set the characteristic entity of the **Benefit Billing Arrangement** characteristic type to **Person, Policy, and Policy Plan**.

- Define a predefined characteristic type named **COBRA Billing Arrangement** with the following characteristic values:

Characteristic Value	Description
DRT	Direct Billing
GRP	Group Billing
TPA	TPA Billing

You must set the characteristic entity of the **COBRA Billing Arrangement** characteristic type to **Person, Policy, and Policy Plan**.

- Define the required person relationship types and account relationship types in the system.
- Define the required geographic rating areas in the system.
- Define the required member relationship/subscription tier structures in the system.
- Define the required geographic rating area preference and member relationship and subscription tier preference through the **Field Mapping** screen.
- Define the required Medicare plan benefit packages in the system.
- Set the values for the following option types in the **C1-PERSTYPE** feature configuration:
 - Bill Group Person Type
 - Parent Person Type
 - TPA Person Type
- Set the values for the following option types in the **C1-ASOBLNG** feature configuration:
 - Membership ID Characteristic for Billable Charge
 - Parent Customer Policy Person Role
 - Bill Group Policy Person Role
 - Membership Inactive Status
 - Membership Person Inactive Status
 - Rating Area Field Mapping for Group

- Relation Structure Code Field Mapping
- Billing Arrangement
- Benefit Billing Arrangement
- Cobra Billing Arrangement
- TPA Person Relationship Type
- TPA Account Relationship Type
- TPA Policy Person Role

Related Topics

For more information on...	See...
How to setup the C1-ASOBLNG feature configuration	Setting the CI-ASOBLNG Feature Configuration on page 3421
How to setup the C1-PERSTYPE feature configuration	Setting the CI_PERSTYPE Feature Configuration on page 3463
How to define a geographic rating area preference	Defining a Geographic Rating Area Preference on page 191
How to define a member relationship and subscription tier preference	Defining a Member Relationship and Subscription Tier Preference on page 211
How to define a geographic rating area	Defining a Geographic Rating Area on page 110
How to define a member relationship structure	Defining a Member Relationship Structure on page 121
How to define a subscription tier structure	Defining a Subscription Tier Structure on page 136
How to define a Medicare plan benefit package	Defining a Medicare Plan Benefit Package on page 186

Fully-Insured Group Policy

You can create a fully-insured group policy using a policy type where the policy category is set to **Fully-Insured Group** or **Fully-Insured Individual**. The policy type indicates the business object using which the fully-insured group policy should be created in the system.

Note: At present, the **Fully-Insured Individual** policy category is not yet supported in the system.

As per the fully-insured group health insurance business, the system enables you to create a fully-insured group policy for the following:

- A parent customer (where a bill group is not associated)
- A bill group (where the parent customer is the policy holder)

You can create or edit a fully-insured group policy from the **Policy** screen. In addition, you can create or edit a fully-insured group policy through a customer registration object or a health care inbound message. If the fully-insured group policy information is given for a bill group in a health care inbound message, the system does the following:

- Associates the bill group with the policy using the policy person role which is specified in the **Bill Group Policy Person Role** option type of the **C1-ASOBLNG** feature configuration
- Associates the parent customer with the policy using the policy person role which is specified in the **Parent Customer Policy Person Role** option type of the **C1-ASOBLNG** feature configuration

However, if the fully-insured group policy information is given for a parent customer in a health care inbound message, the system does the following:

- Associates the parent customer with the policy using the policy person role which is specified in the **Parent Customer Policy Person Role** option type of the **C1-ASOBLLNG** feature configuration

A fully-insured group policy encapsulates the following information:

- **Policy Persons** – While creating a fully-insured group policy, you need to associate the person who is the main customer of the policy. While associating a person with a fully-insured group policy, you need to specify the policy person role which indicates the role of the person in the policy. For example, whether the person associated with the policy is the policy holder, broker, or underwriter. You can associate multiple persons with a fully-insured group policy using the same or different policy person role. However, at a time, only one person can be the main customer of the policy.
- **Policy Plans** – You can define different types of plans in a fully-insured group policy. For more information, refer to *Types of Policy Plan* on page 283.
- **Memberships** – You can define different types of memberships for a fully-insured group policy plan. For more information, refer to *Types of Membership* on page 284.
- **Member Persons** – While adding a person to a membership, you need to specify whether the person is the main subscriber of the membership, whether the person is financially responsible for the membership, and how the person is related to the main subscriber. At a time, only one person can be the main subscriber of the membership. You cannot remove a member person, who is the main subscriber, from the membership. You can inactivate a member person whenever required. If you inactivate a member person who is the main subscriber, the system automatically inactivates the membership and all other member persons which are included in the membership.
- **Membership Contracts** – You can associate one or more contracts with a membership. At present, the system uses the contract created for a policy plan on the accounts of the parent customer or bill group for billing the respective membership premium. The system does not use the membership contracts for billing the membership premium.
- **Policy Plan Contracts** – The system creates or updates contracts of a policy plan when you do either of the following:
 - Create or Edit a Policy Plan from the User Interface or through an Inbound Message
 - Create or Edit an Account from the User Interface or through an Inbound Message

The system uses the contract created for a policy plan on the accounts of the parent customer or bill group for billing the respective membership premium. For more information, refer to *Single Contract Creation Across Fully-Insured Group Policies and Plans* on page 250 and *Policy Plan Specific Contract Creation* on page 269.

On defining a fully-insured group policy, the status of the policy is set to **Pending**. You can then edit, delete or activate a policy. Once a fully-insured group policy is activated, you can terminate, reinstate, or renew the policy whenever required.

Fully-Insured Group Policy Activation

You can activate a fully-insured group policy by clicking the **Activate** button in the **Policy** screen. On activating a fully-insured group policy, the status of the policy is set to **In Force/Active**.

Note: If a fully-insured group policy is created through a customer registration object or a health care inbound message, the status of the policy is directly set to **In Force/Active**

Once a fully-insured group policy is activated, you can terminate, reinstate, or renew the policy whenever required.

Fully-Insured Group Policy Termination

The system enables you to terminate a fully-insured group policy whenever required. There are two ways in which you can terminate a fully-insured group policy:

- **Initiate Policy Termination Process** – In this method, you can initiate the policy termination process from the user interface. To initiate the termination process, you need to specify the termination date and termination reason. On initiating the termination process, the status of the policy is changed to **Pending Termination**. In addition, the

system creates an outbound message which request for confirmation whether the policy should be terminated. This outbound message can be sent to the policy processing system via custom mechanism. On receiving confirmation from the policy processing system through a health care inbound message, the system changes the status of the policy to **Terminated**.

- **Terminate Policy** – In this method, you can directly terminate a fully-insured group policy. To terminate a fully-insured group policy, you need to specify the termination reason. You can directly terminate the policy from the user interface or through a health care inbound message. On clicking the **Terminate** button, the system will terminate the fully-insured group policy on the system date. However, when you terminate a fully-insured group policy through a health care inbound message, the policy is terminated when the health care inbound message is processed in the system. On terminating a fully-insured group policy, the status of the policy is changed to **Terminated**.

Once the status of the policy is changed to **Terminated**, the system sets the end date of the following entities to the termination date when the respective condition is met:

- Policy (when the termination date is not earlier than the policy start date or later than the policy end date)
- Policy Person (when the termination date falls within the date range in which the person is associated with the policy)

Note: The system does not consider those persons associated with policy whose start date is later than the termination date or whose end date is earlier than the termination date.

- Policy Plan (when the termination date falls within the date range of the policy plan)

Note: The system does not consider those policy plans whose start date is later than the termination date or whose end date is earlier than the termination date.

- Membership (when the termination date falls within the date range of the membership)

Note: The system does not consider those memberships whose start date is later than the termination date or whose end date is earlier than the termination date.

- Member Person (when the termination date falls within the date range in which the person is associated with the membership)

Note: The system does not consider those member persons whose start date is later than the termination date or whose end date is earlier than the termination date.

- Contracts Associated with the Membership (when the termination date falls within the date range of the contract)

Note: The system does not consider those contracts whose start date is later than the termination date or whose end date is earlier than the termination date.

The system also changes the status of all memberships to **Terminated** irrespective of whether it is effective on the termination date or not. On terminating a membership, the system creates an audit event for the membership. For each audit event, the system identifies the policy plan to which the membership belongs and the active pricing rules defined on the policy plan. It then identifies the pricing rule types using which these active pricing rules are created in the system. An entry for each membership, pricing rule type, and effective date combination is created in the **Pending (P)** status in the **CI_REPRC_ENTITY_DTL** table. For more information, see [Audit Framework for Fully-Insured Group Health Insurance Billing](#) on page 3115.

Fully-Insured Group Policy Reinstatement

The system enables you to reinstate the terminated policy whenever required. There are two ways in which you can reinstate a fully-insured group policy:

- **Initiate Policy Reinstatement Process** – In this method, you can initiate the policy reinstatement process from the user interface. To initiate the reinstatement process, you need to specify the reinstatement reason. On initiating

the reinstatement process, the status of the policy is changed to **Pending Reinstatement**. In addition, the system creates an outbound message which request for confirmation whether the policy should be reinstated. This outbound message can be sent to the policy processing system via custom mechanism. On receiving confirmation from the policy processing system through a health care inbound message, the system changes the status of the policy to **Reinstated**.

- **Reinstate Policy** – In this method, you can directly reinstate a fully-insured group policy. To reinstate a fully-insured group policy, you need to specify the reinstatement reason. You can directly reinstate the policy from the user interface or through a health care inbound message. On clicking the **Reinstate** button, the system will reinstate the fully-insured group policy on the system date. However, when you reinstate a fully-insured group policy through a health care inbound message, the policy is reinstated when the health care inbound message is processed in the system. On reinstating a fully-insured group policy, the status of the policy is changed to **Reinstated**.

Once the status of the policy is changed to **Reinstated**, the system updates the end date of the following entities to the respective original end date:

- Policy
- Policy Person
- Policy Plan
- Membership
- Member Person
- Contracts Associated with the Membership

Note:

The system stores the original end date of the above listed entities when you define or edit a policy, policy plan, or membership.

Here, the assumption is that the pass-through billable charges information for the membership will be sent again through an inbound message along with the reinstatement reason. And, therefore the exiting billable charges will not be extended.

Finally, the system automatically transitions the fully-insured group policy from **Reinstated** to **In Force/Active**.

Fully-Insured Group Policy Renewal

You can renew a fully-insured group policy only through a health care inbound message and not from the user interface. If you want to renew a fully-insured group policy, you must sent the renewal date along with the new policy end date through a health care inbound message. On processing the health care inbound message, the fully-insured group policy is renewed. The renewal date is stamped on the fully-insured group policy. The policy end date is extended as mentioned in the health care inbound message. The policy plan and membership information for the renewed period must be sent in the subsequent health care inbound messages.

Note: You can renew a fully-insured group policy when it is in the **In Force/Active** status.

Single Contract Creation Across Fully-Insured Group Policies and Plans

The system automatically creates a contract for a fully-insured group policy plan on the parent customer and/or bill group accounts. The system creates or updates contracts of a policy plan when you do either of the following:

- **Create or Edit a Policy Plan from the User Interface or through an Inbound Message** – The system creates a contract in either of the following ways:
 - If a price item is associated with the policy plan, it creates a contract using the contract type which is associated with the price item.

- If a pricing rule type is associated with the policy plan and the pricing rule type contains one or more price items, it creates one contract using each contract type which may be associated with one or more price items. Let us assume that a pricing rule type named PRT1 is associated with the policy plan and it contains three price items – PI1, PI2, and PI3. Now, if the PI1 is associated with the CT1 contract type, PI2 is associated with the CT2 contract type, and PI3 is associated with the CT3 contract type, the system will create three contracts - C1 using CT1, C2 using CT2, and C3 using CT3. However, if the PI1 and PI3 are associated with the CT1 contract type and PI2 is associated with the CT2 contract type, the system will create two contracts - C1 using CT1 and C2 using CT2.

If a policy has two or more plans, multiple pricing rule types are associated with each policy plan and each pricing rule type contains multiple price items, it creates one contract using each contract type which may be associated with one or more price items. Let us assume that P1 has two plans — PP1 and PP2, PRT1 is associated with PP1, PRT2 is associated with PP2, PRT1 contains three price items – PI1, PI2, and PI3, and PRT2 contains three price items – PI1, PI4, and PI5. Now, if the PI1 is associated with the CT1 contract type, PI2 is associated with the CT2 contract type, PI3 is associated with the CT3 contract type, PI4 is associated with the CT4 contract type, and PI5 is associated with the CT5 contract type, the system will create five contracts - C1 using CT1, C2 using CT2, C3 using CT3, C4 using CT4, and C5 using CT5. However, if PI1, PI2, and PI5 are associated with the CT1 contract type and PI3 and PI4 are associated with the CT2 contract type, the system will create two contracts - C1 using CT1 and C2 using CT2.

The status of each contract is set to **Active**. The contract start date is set to the start date of the respective plan. If the same contract type is associated with different price items, and if these price items are added on different pricing rule types, and if these pricing rule types are associated with different plans, the contract start date is set to the start date of the earliest plan. The default rate schedule specified on the respective contract type is added to the contract in the rate information and its effective date is set to the contract start date.

Example 1 — Contract Creation for a Parent Customer

If a policy plan belongs to a policy of the parent customer (where a bill group is not associated), the system will create one contract using each contract type on each account of the parent customer and bill groups. Let us assume that...

- PC1 has two bill groups – BG1 and BG2
- PC1 has A1 account, BG1 has A2 account, and BG2 has A3 and A4 accounts
- A policy named P1 with two plans – PP1 and PP2 - is created for PC1 (where none of the bill groups are associated)
- PP1 (with the start date as 01-01-2019) is associated with PRT1 and PRT2
- PP2 (with the start date as 03-01-2019) is associated with PRT2 and PRT3
- PRT1 contains two price items – PI1 and PI2
- PRT2 contains three price items – PI1, PI3, and PI4
- PRT3 contains three price items – PI4, PI5, and PI6
- PI1 is associated with the CT1 contract type, PI2 is associated with the CT2 contract type, PI3 is associated with the CT3 contract type, PI4 and PI5 are associated with the CT4 contract type, and PI6 is associated with the CT6 contract type

Now, in such case, the system will create the following contracts on the A1, A2, A3, and A4 accounts:

Account	Plan	Pricing Rule Type	Price Item	Contract Type	Contract	Plans for which the contract is created...	Contract Start Date (i.e. Earliest Plan Date)
A1	PP1	PRT1	PI1	CT1	A1C1	PP1 (01-01-2019) and PP2 (03-01-2019)	01-01-2019
			PI2	CT2	A1C2	PP1 (01-01-2019)	01-01-2019
		PRT2	PI1	CT1	A1C1	PP1 (01-01-2019) and PP2 (03-01-2019)	01-01-2019
			PI3	CT3	A1C3	PP1 (01-01-2019) and PP2 (03-01-2019)	01-01-2019
			PI4	CT4	A1C4	PP1 (01-01-2019) and PP2 (03-01-2019)	01-01-2019
	PP2	PRT2	PI1	CT1	A1C1	PP1 (01-01-2019) and PP2 (03-01-2019)	01-01-2019
			PI3	CT3	A1C3	PP1 (01-01-2019) and PP2 (03-01-2019)	01-01-2019
			PI4	CT4	A1C4	PP1 (01-01-2019) and PP2 (03-01-2019)	01-01-2019
		PRT3	PI4	CT4	A1C4	PP1 (01-01-2019) and PP2 (03-01-2019)	01-01-2019

Account	Plan	Pricing Rule Type	Price Item	Contract Type	Contract	Plans for which the contract is created...	Contract Start Date (i.e. Earliest Plan Date)
			PI5	CT4	A1C4	PP2 (03-01-2019)	01-01-2019 (because PI4 and PI5 are associated with the same contract type (i.e. CT4))
			PI6	CT6	A1C6	PP2 (03-01-2019)	03-01-2019
A2	PP1	PRT1	PI1	CT1	A2C1	PP1 (01-01-2019) and PP2 (03-01-2019)	01-01-2019
			PI2	CT2	A2C2	PP1 (01-01-2019)	01-01-2019
		PRT2	PI1	CT1	A2C1	PP1 (01-01-2019) and PP2 (03-01-2019)	01-01-2019
			PI3	CT3	A2C3	PP1 (01-01-2019) and PP2 (03-01-2019)	01-01-2019
			PI4	CT4	A2C4	PP1 (01-01-2019) and PP2 (03-01-2019)	01-01-2019
	PP2	PRT2	PI1	CT1	A2C1	PP1 (01-01-2019) and PP2 (03-01-2019)	01-01-2019
			PI3	CT3	A2C3	PP1 (01-01-2019) and PP2 (03-01-2019)	01-01-2019
			PI4	CT4	A2C4	PP1 (01-01-2019) and PP2 (03-01-2019)	01-01-2019

Account	Plan	Pricing Rule Type	Price Item	Contract Type	Contract	Plans for which the contract is created...	Contract Start Date (i.e. Earliest Plan Date)
		PRT3	PI4	CT4	A2C4	PP1 (01-01-2019) and PP2 (03-01-2019)	01-01-2019
			PI5	CT4	A2C4	PP2 (03-01-2019)	01-01-2019 (because PI4 and PI5 are associated with the same contract type (i.e. CT4))
			PI6	CT6	A2C6	PP2 (03-01-2019)	03-01-2019
A3	PP1	PRT1	PI1	CT1	A3C1	PP1 (01-01-2019) and PP2 (03-01-2019)	01-01-2019
			PI2	CT2	A3C2	PP1 (01-01-2019)	01-01-2019
		PRT2	PI1	CT1	A3C1	PP1 (01-01-2019) and PP2 (03-01-2019)	01-01-2019
			PI3	CT3	A3C3	PP1 (01-01-2019) and PP2 (03-01-2019)	01-01-2019
			PI4	CT4	A3C4	PP1 (01-01-2019) and PP2 (03-01-2019)	01-01-2019
	PP2	PRT2	PI1	CT1	A3C1	PP1 (01-01-2019) and PP2 (03-01-2019)	01-01-2019
			PI3	CT3	A3C3	PP1 (01-01-2019) and PP2 (03-01-2019)	01-01-2019

Account	Plan	Pricing Rule Type	Price Item	Contract Type	Contract	Plans for which the contract is created...	Contract Start Date (i.e. Earliest Plan Date)
			PI4	CT4	A3C4	PP1 (01-01-2019) and PP2 (03-01-2019)	01-01-2019
		PRT3	PI4	CT4	A3C4	PP1 (01-01-2019) and PP2 (03-01-2019)	01-01-2019
			PI5	CT4	A3C4	PP2 (03-01-2019)	01-01-2019 (because PI4 and PI5 are associated with the same contract type (i.e. CT4))
			PI6	CT6	A3C6	PP2 (03-01-2019)	03-01-2019
A4	PP1	PRTI	PI1	CT1	A4C1	PP1 (01-01-2019) and PP2 (03-01-2019)	01-01-2019
			PI2	CT2	A4C2	PP1 (01-01-2019)	01-01-2019
		PRT2	PI1	CT1	A4C1	PP1 (01-01-2019) and PP2 (03-01-2019)	01-01-2019
			PI3	CT3	A4C3	PP1 (01-01-2019) and PP2 (03-01-2019)	01-01-2019
			PI4	CT4	A4C4	PP1 (01-01-2019) and PP2 (03-01-2019)	01-01-2019
	PP2	PRT2	PI1	CT1	A4C1	PP1 (01-01-2019) and PP2 (03-01-2019)	01-01-2019

Account	Plan	Pricing Rule Type	Price Item	Contract Type	Contract	Plans for which the contract is created...	Contract Start Date (i.e. Earliest Plan Date)
			PI3	CT3	A4C3	PP1 (01-01-2019) and PP2 (03-01-2019)	01-01-2019
			PI4	CT4	A4C4	PP1 (01-01-2019) and PP2 (03-01-2019)	01-01-2019
		PRT3	PI4	CT4	A4C4	PP1 (01-01-2019) and PP2 (03-01-2019)	01-01-2019
			PI5	CT4	A4C4	PP2 (03-01-2019)	01-01-2019 (because PI4 and PI5 are associated with the same contract type (i.e. CT4))
			PI6	CT6	A4C6	PP2 (03-01-2019)	03-01-2019

The following figure graphically illustrates the example 1:

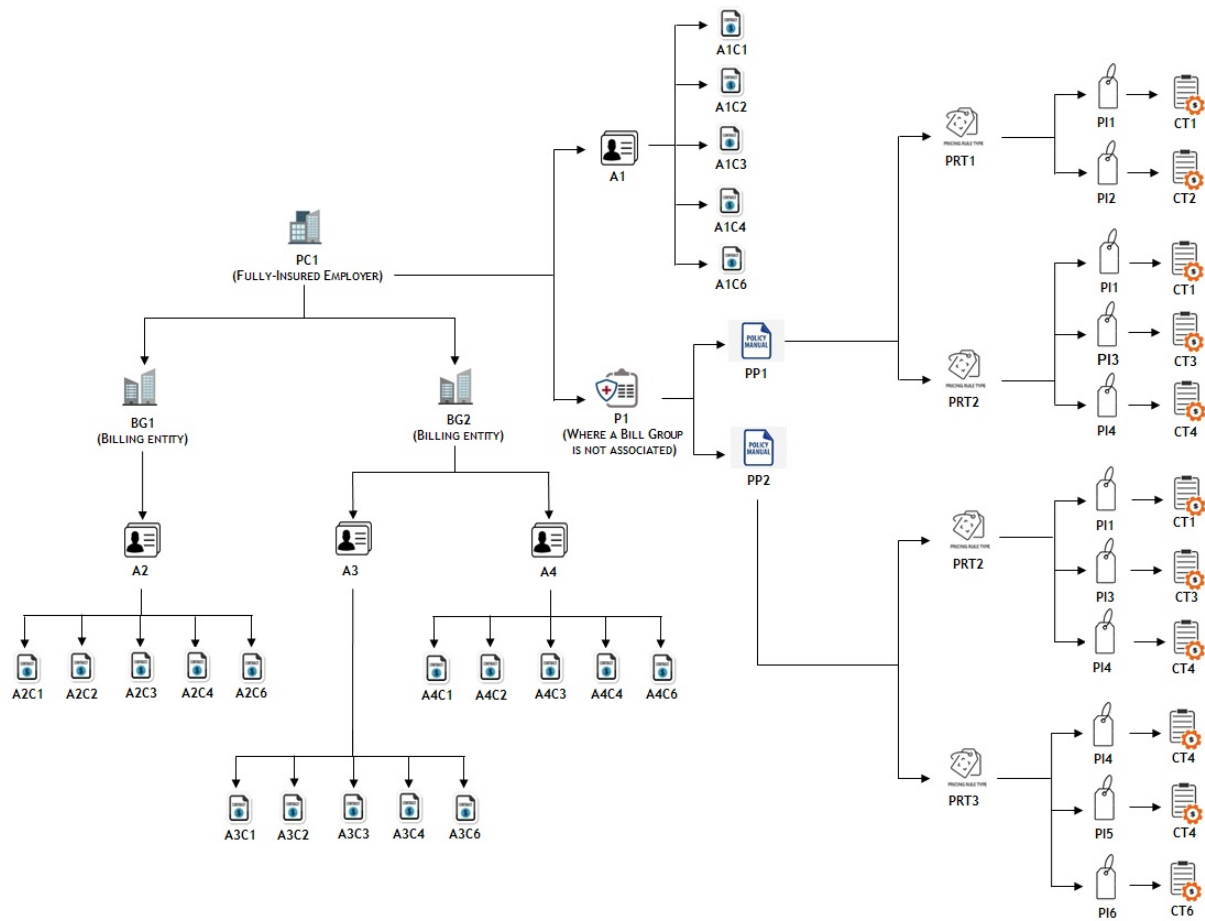

Example 2 — Contract Creation for a Bill Group

If a policy plan belongs to a policy of a bill group (where the parent customer is the policy holder), the system will create one contract using each contract type on each account of the parent customer and the bill group. Let us assume that...

- PC1 has two bill groups – BG1 and BG2
- PC1 has A1 account, BG1 has A2 account, and BG2 has A3 and A4 accounts
- A policy named P1 with three plans – PP1, PP2, and PP3 – is created for BG1 (where PC1 is the policy holder)
- PP1 (with the start date as 01-01-2019) is associated with PRT1 and PRT2
- PP2 (with the start date as 03-01-2019) is associated with PRT2 and PRT3
- PP3 (with the start date as 06-01-2019) is associated with PRT1
- PRT1 contains two price items – PI1 and PI2
- PRT2 contains three price items – PI1, PI3, and PI4
- PRT3 contains three price items – PI4, PI5, and PI6
- PI1 is associated with the CT1 contract type, PI2 is associated with the CT2 contract type, PI3 is associated with the CT3 contract type, PI4 and PI5 are associated with the CT4 contract type, and PI6 is associated with the CT6 contract type

Now, in such case, the system will create the following contracts on the A1 and A2 accounts:

Account	Plan	Pricing Rule Type	Price Item	Contract Type	Contract	Plans for which the contract is created...	Contract Start Date (i.e. Earliest Plan Date)
A1	PP1	PRT1	PI1	CT1	A1C1	PP1 (01-01-2019), PP2 (03-01-2019), and PP3 (06-01-2019)	01-01-2019
			PI2	CT2	A1C2	PP1 (01-01-2019) and PP3 (06-01-2019)	01-01-2019
		PRT2	PI1	CT1	A1C1	PP1 (01-01-2019), PP2 (03-01-2019), and PP3 (06-01-2019)	01-01-2019
			PI3	CT3	A1C3	PP1 (01-01-2019) and PP2 (03-01-2019)	01-01-2019
			PI4	CT4	A1C4	PP1 (01-01-2019) and PP2 (03-01-2019)	01-01-2019
	PP2	PRT2	PI1	CT1	A1C1	PP1 (01-01-2019), PP2 (03-01-2019), and PP3 (06-01-2019)	01-01-2019
			PI3	CT3	A1C3	PP1 (01-01-2019) and PP2 (03-01-2019)	01-01-2019
			PI4	CT4	A1C4	PP1 (01-01-2019) and PP2 (03-01-2019)	01-01-2019

Account	Plan	Pricing Rule Type	Price Item	Contract Type	Contract	Plans for which the contract is created...	Contract Start Date (i.e. Earliest Plan Date)
		PRT3	PI4	CT4	A1C4	PP1 (01-01-2019) and PP2 (03-01-2019)	01-01-2019
			PI5	CT4	A1C4	PP2 (03-01-2019)	01-01-2019 (because PI4 and PI5 are associated with the same contract type (i.e. CT4))
			PI6	CT6	A1C6	PP2 (03-01-2019)	03-01-2019
	PP3	PRT1	PI1	CT1	A1C1	PP1 (01-01-2019), PP2 (03-01-2019), and PP3 (06-01-2019)	01-01-2019
			PI2	CT2	A1C2	PP1 (01-01-2019) and PP3 (06-01-2019)	01-01-2019
	A2	PP1	PRT1	PI1	CT1	A2C1	PP1 (01-01-2019), PP2 (03-01-2019), and PP3 (06-01-2019)
PI2				CT2	A2C2	PP1 (01-01-2019) and PP3 (06-01-2019)	01-01-2019
PRT2			PI1	CT1	A2C1	PP1 (01-01-2019), PP2 (03-01-2019), and PP3 (06-01-2019)	01-01-2019

Account	Plan	Pricing Rule Type	Price Item	Contract Type	Contract	Plans for which the contract is created...	Contract Start Date (i.e. Earliest Plan Date)
			PI3	CT3	A2C3	PP1 (01-01-2019) and PP2 (03-01-2019)	01-01-2019
			PI4	CT4	A2C4	PP1 (01-01-2019) and PP2 (03-01-2019)	01-01-2019
	PP2	PRT2	PI1	CT1	A2C1	PP1 (01-01-2019), PP2 (03-01-2019), and PP3 (06-01-2019)	01-01-2019
			PI3	CT3	A2C3	PP1 (01-01-2019) and PP2 (03-01-2019)	01-01-2019
			PI4	CT4	A2C4	PP1 (01-01-2019) and PP2 (03-01-2019)	01-01-2019
		PRT3	PI4	CT4	A2C4	PP1 (01-01-2019) and PP2 (03-01-2019)	01-01-2019
			PI5	CT4	A2C4	PP2 (03-01-2019)	01-01-2019 (because PI4 and PI5 are associated with the same contract type (i.e. CT4))
			PI6	CT6	A2C6	PP2 (03-01-2019)	03-01-2019

Account	Plan	Pricing Rule Type	Price Item	Contract Type	Contract	Plans for which the contract is created...	Contract Start Date (i.e. Earliest Plan Date)
	PP3	PRT1	PI1	CT1	A2C1	PP1 (01-01-2019), PP2 (03-01-2019), and PP3 (06-01-2019)	01-01-2019
			PI2	CT2	A2C2	PP1 (01-01-2019) and PP3 (06-01-2019)	01-01-2019

The following figure graphically illustrates the example 2:

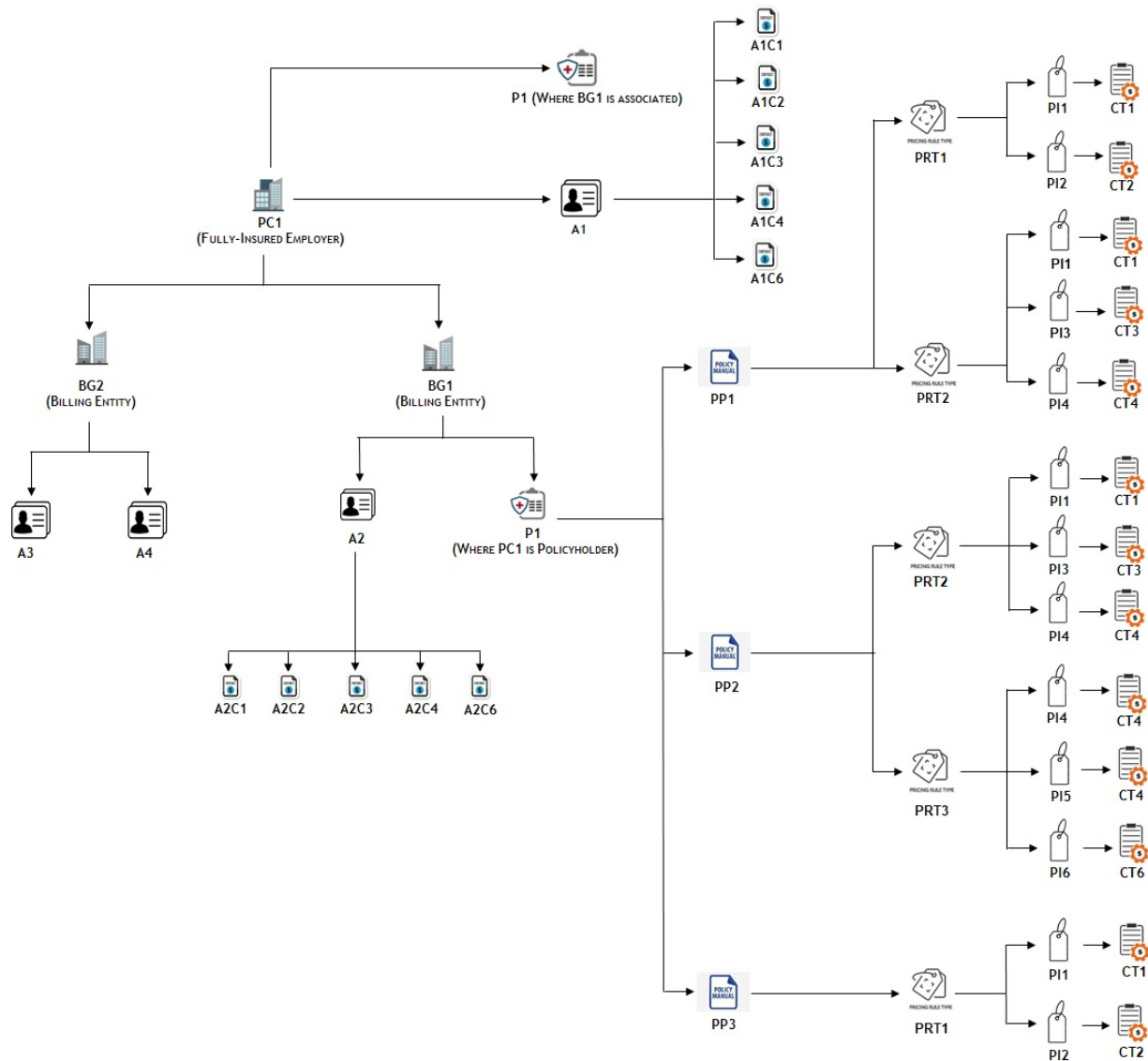
**Note:**

The system creates a contract using a contract type for an account only when the division to which the account and contract type belongs is same.

If a contract of a contract type is already present on the account, the system will not create a new contract. Instead, it will update the start date of the existing contract, if required.

- **Create or Edit an Account from the User Interface or through an Inbound Message** – The system creates a contract when either of the following condition is met:
 - The main customer of the account is a parent customer and holds a policy (where a bill group is not associated) which is created using the policy type where the policy category is set to **Fully-Insured Group**.
 - The main customer of the account is a parent customer and holds a policy (where a bill group is associated) which is created using the policy type where the policy category is set to **Fully-Insured Group**.
 - The main customer of the account is a bill group and holds a policy (where the parent customer is the policy holder) which is created using the policy type where the policy category is set to **Fully-Insured Group**.

The system creates a contract in either of the following ways:

- If a price item is associated with the policy plan, it creates a contract using the contract type which is associated with the price item.
- If a pricing rule type is associated with the policy plan and the pricing rule type contains one or more price items, it creates one contract using each contract type which may be associated with one or more price items. Let us assume that a pricing rule type named PRT1 is associated with the policy plan and it contains three price items – PI1, PI2, and PI3. Now, if the PI1 is associated with the CT1 contract type, PI2 is associated with the CT2 contract type, and PI3 is associated with the CT3 contract type, the system will create three contracts - C1 using CT1, C2 using CT2, and C3 using CT3. However, if the PI1 and PI3 are associated with the CT1 contract type and PI2 is associated with the CT2 contract type, the system will create two contracts - C1 using CT1 and C2 using CT2.

If a policy has two or more plans, multiple pricing rule types are associated with each policy plan and each pricing rule type contains multiple price items, it creates one contract using each contract type which may be associated with one or more price items. Let us assume that P1 has two plans — PP1 and PP2, PRT1 is associated with PP1, PRT2 is associated with PP2, PRT1 contains three price items – PI1, PI2, and PI3, and PRT2 contains three price items – PI1, PI4, and PI5. Now, if the PI1 is associated with the CT1 contract type, PI2 is associated with the CT2 contract type, PI3 is associated with the CT3 contract type, PI4 is associated with the CT4 contract type, and PI5 is associated with the CT5 contract type, the system will create five contracts - C1 using CT1, C2 using CT2, C3 using CT3, C4 using CT4, and C5 using CT5. However, if PI1, PI2, and PI5 are associated with the CT1 contract type and PI3 and PI4 are associated with the CT2 contract type, the system will create two contracts - C1 using CT1 and C2 using CT2.

The status of each contract is set to **Active**. The contract start date is set to the start date of the respective plan. If the same contract type is associated with different price items, and if these price items are added on different pricing rule types, and if these pricing rule types are associated with different plans, the contract start date is set to the start date of the earliest plan. The default rate schedule specified on the respective contract type is added to the contract in the rate information and its effective date is set to the contract start date.

Example 3 — Contract Creation for an Account of a Parent Customer

If you create an account for a parent customer who holds policies (where a bill group may or may not be associated), the system will create one contract using each contract type for all parent customer's policies on the account. Let us assume...

- PC1 has two bill groups – BG1 and BG2
- PC1 has two policies – a policy named P1 (where a bill group is not associated) and a policy named P2 (where BG1 is associated)
- BG1 has one policy named P2 where PC1 is the policy holder
- An account named A1 is added for PC1
- P1 has two plans – PP1 and PP2
- P2 has two plans – PP11 and PP12
- PP1 (with the start date as 01-01-2019) is associated with PRT1 and PRT2
- PP2 (with the start date as 06-01-2019) is associated with PRT2, PRT3, and PRT4
- PP11 (with the start date as 05-01-2019) is associated with PRT111 and PRT112
- PP12 (with the start date as 09-01-2019) is associated with PRT113 and PRT114
- PRT1 contains two price items – PI1 and PI2
- PRT2 contains two price items – PI3 and PI4
- PRT3 contains two price items – PI1 and PI5
- PRT4 contains two price items – PI6 and PI7

- PRT111 contains two price items – PI11 and PI12
- PRT112 contains two price items – PI1 and PI5
- PRT113 contains two price items – PI13 and PI14
- PRT114 contains two price items – PI7 and PI15
- PI1 is associated with the CT1 contract type, PI2 and PI3 are associated with the CT2 contract type, PI4 is associated with the CT4 contract type, PI5 is associated with the CT5 contract type, PI6 is associated with the CT6 contract type, PI7 is associated with the CT7 contract type, PI11 is associated with the CT11 contract type, PI12 is associated with the CT12 contract type, PI13 is associated with the CT13 contract type, PI14 is associated with the CT14 contract type, and PI15 is associated with the CT15 contract type

Now, in such case, the system will create the following contracts on the A1 account:

Account	Policy	Plan	Pricing Rule Type	Price Item	Contract Type	Contract	Plans for which the contract is created...	Contract Start Date (i.e. Earliest Plan Date)
A1	P1	PP1	PRT1	PI1	CT1	A1C1	PP1 (01-01-2019), PP2 (06-01-2019), and PP11 (05-01-2019)	01-01-2019
				PI2	CT2	A1C2	PP1 (01-01-2019)	01-01-2019
			PRT2	PI3	CT2	A1C2	PP1 (01-01-2019) and PP2 (06-01-2019)	01-01-2019
				PI4	CT4	A1C4	PP1 (01-01-2019) and PP2 (06-01-2019)	01-01-2019
		PP2	PRT2	PI3	CT2	A1C2	PP1 (01-01-2019) and PP2 (06-01-2019)	01-01-2019
				PI4	CT4	A1C4	PP1 (01-01-2019) and PP2 (06-01-2019)	01-01-2019

Account	Policy	Plan	Pricing Rule Type	Price Item	Contract Type	Contract	Plans for which the contract is created...	Contract Start Date (i.e. Earliest Plan Date)	
			PRT3	PI1	CT1	A1C1	PP1 (01-01-2019), PP2 (06-01-2019), and PP11 (05-01-2019)	01-01-2019	
				PI5	CT5	A1C5	PP2 (06-01-2019) and PP11 (05-01-2019)	05-01-2019	
			PRT4	PI6	CT6	A1C6	PP2 (06-01-2019)	06-01-2019	
				PI7	CT7	A1C7	PP2 (06-01-2019) and PP12 (09-01-2019)	06-01-2019	
	P2	PP11	PRT111	PI11	CT11	A1C11	PP11 (05-01-2019)	05-01-2019	
						PI12	CT12	A1C12	PP11 (05-01-2019)
				PRT112	PI1	CT1	A1C1	PP1 (01-01-2019), PP2 (06-01-2019), and PP11 (05-01-2019)	01-01-2019
					PI5	CT5	A1C5	PP2 (06-01-2019) and PP11 (05-01-2019)	05-01-2019
			PP12	PRT113	PI13	CT13	A1C13	PP12 (09-01-2019)	09-01-2019
					PI14	CT14	A1C14	PP12 (09-01-2019)	09-01-2019
				PRT114	PI7	CT7	A1C7	PP2 (06-01-2019) and PP12 (09-01-2019)	06-01-2019

Account	Policy	Plan	Pricing Rule Type	Price Item	Contract Type	Contract	Plans for which the contract is created...	Contract Start Date (i.e. Earliest Plan Date)
				PI15	CT15	A1C15	PP12 (09-01-2019)	09-01-2019

The following figure graphically illustrates the example 3:

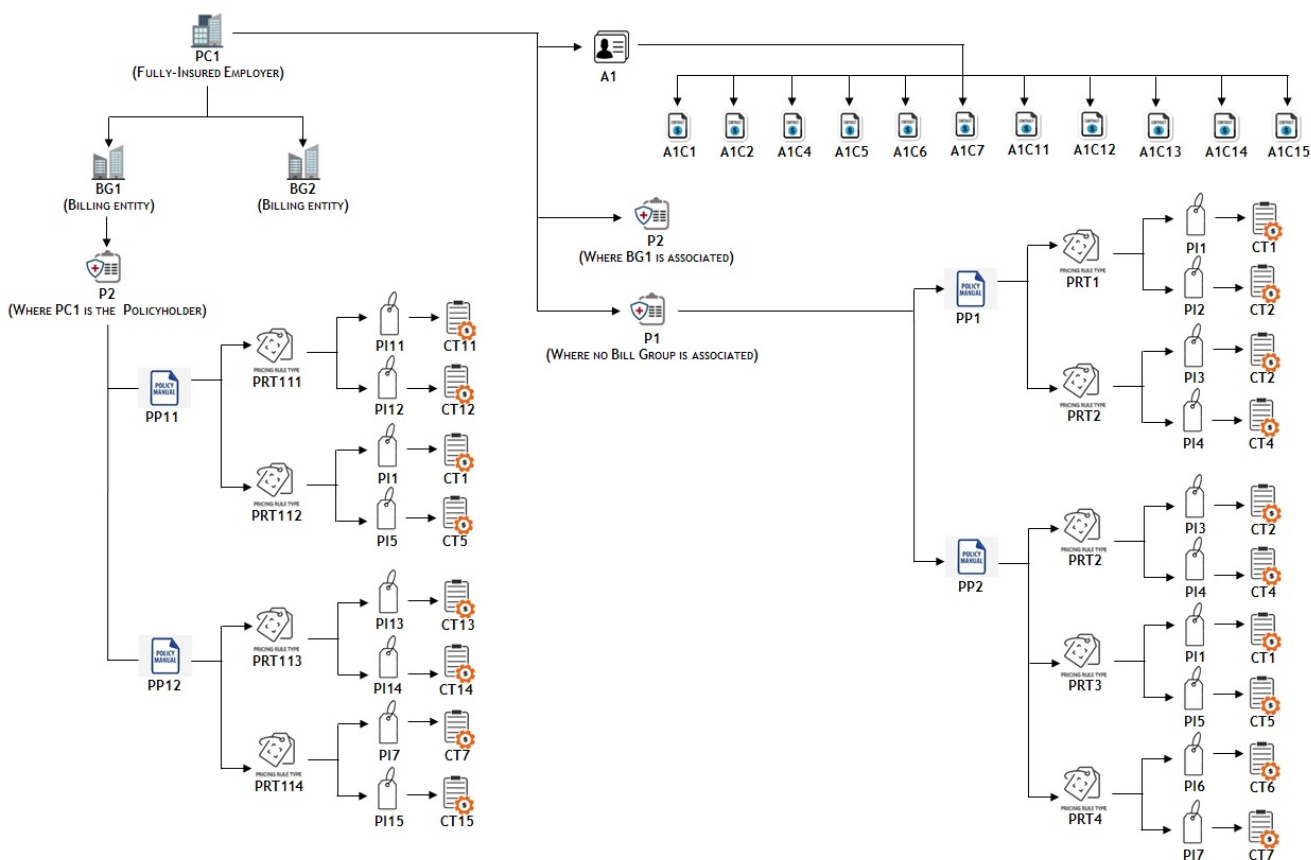

Example 4 — Contract Creation for an Account of a Bill Group

If you create an account for a bill group who holds policies and its parent customer holds policies (where a bill group may or may not be associated), the system will create one contract using each contract type for the bill group’s polices and parent customer’s polices (where a bill group is not associated) on the account. Let us assume...

- PC1 has two bill groups – BG1 and BG2
- PC1 has two policies – a policy named P2 (where a bill group is not associated) and a policy named P1 (where BG2 is associated)
- BG2 has one policy named P1 where PC1 is the policy holder
- An account named A1 is added for BG2
- P1 has two plans – PP11 and PP12

- P2 has two plans – PP1 and PP2
- PP1 (with the start date as 01-01-2019) is associated with PRT1 and PRT2
- PP2 (with the start date as 04-01-2019) is associated with PRT3 and PRT4
- PP11 (with the start date as 07-01-2019) is associated with PRT11 and PRT12
- PP12 (with the start date as 11-01-2019) is associated with PRT13 and PRT14
- PRT1 contains two price items – PI1 and PI2
- PRT2 contains two price items – PI3 and PI2
- PRT3 contains two price items – PI3 and PI4
- PRT4 contains two price items – PI5 and PI6
- PRT11 contains two price items – PI111 and PI112
- PRT12 contains two price items – PI1 and PI6
- PRT13 contains two price items – PI113 and PI114
- PRT14 contains two price items – PI115 and PI5
- PI1 is associated with the CT1 contract type, PI2 and PI3 are associated with the CT2 contract type, PI4 is associated with the CT4 contract type, PI5 is associated with the CT5 contract type, PI6 is associated with the CT6 contract type, PI111 is associated with the CT111 contract type, PI112 is associated with the CT112 contract type, PI113 is associated with the CT113 contract type, and PI114 and PI115 is associated with the CT114 contract type

Now, in such case, the system will create the following contracts on the A1 account:

Account	Policy	Plan	Pricing Rule Type	Price Item	Contract Type	Contract	Plans for which the contract is created...	Contract Start Date (i.e. Earliest Plan Date)
A1	P1	PP11	PRT11	PI111	CT111	A1C111	PP11 (07-01-2019)	07-01-2019
				PI112	CT112	A1C112	PP11 (07-01-2019)	07-01-2019
			PRT12	PI1	CT1	A1C1	PP1 (01-01-2019) and PP11 (07-01-2019)	01-01-2019
				PI6	CT6	A1C6	PP2 (04-01-2019) and PP11 (07-01-2019)	04-01-2019
		PP12	PRT13	PI113	CT113	A1C113	PP12 (11-01-2019)	11-01-2019
				PI114	CT114	A1C114	PP12 (11-01-2019)	11-01-2019

Account	Policy	Plan	Pricing Rule Type	Price Item	Contract Type	Contract	Plans for which the contract is created...	Contract Start Date (i.e. Earliest Plan Date)
			PRT14	PI115	CT114	A1C114	PP12 (11-01-2019)	11-01-2019
				PI5	CT5	A1C5	PP2 (04-01-2019) and PP12 (11-01-2019)	04-01-2019
	P2	PP1	PRT1	PI1	CT1	A1C1	PP1 (01-01-2019) and PP11 (07-01-2019)	01-01-2019
				PI2	CT2	A1C2	PP1 (01-01-2019)	01-01-2019
			PRT2	PI2	CT2	A1C2	PP1 (01-01-2019)	01-01-2019
				PI3	CT2	A1C2	PP1 (01-01-2019) and PP2 (04-01-2019)	01-01-2019
		PP2	PRT3	PI3	CT2	A1C2	PP1 (01-01-2019) and PP2 (04-01-2019)	01-01-2019
				PI4	CT4	A1C4	PP2 (04-01-2019)	04-01-2019
			PRT4	PI5	CT5	A1C5	PP2 (04-01-2019) and PP12 (11-01-2019)	04-01-2019
				PI6	CT6	A1C6	PP2 (04-01-2019) and PP11 (07-01-2019)	04-01-2019

The following figure graphically illustrates the example 4:

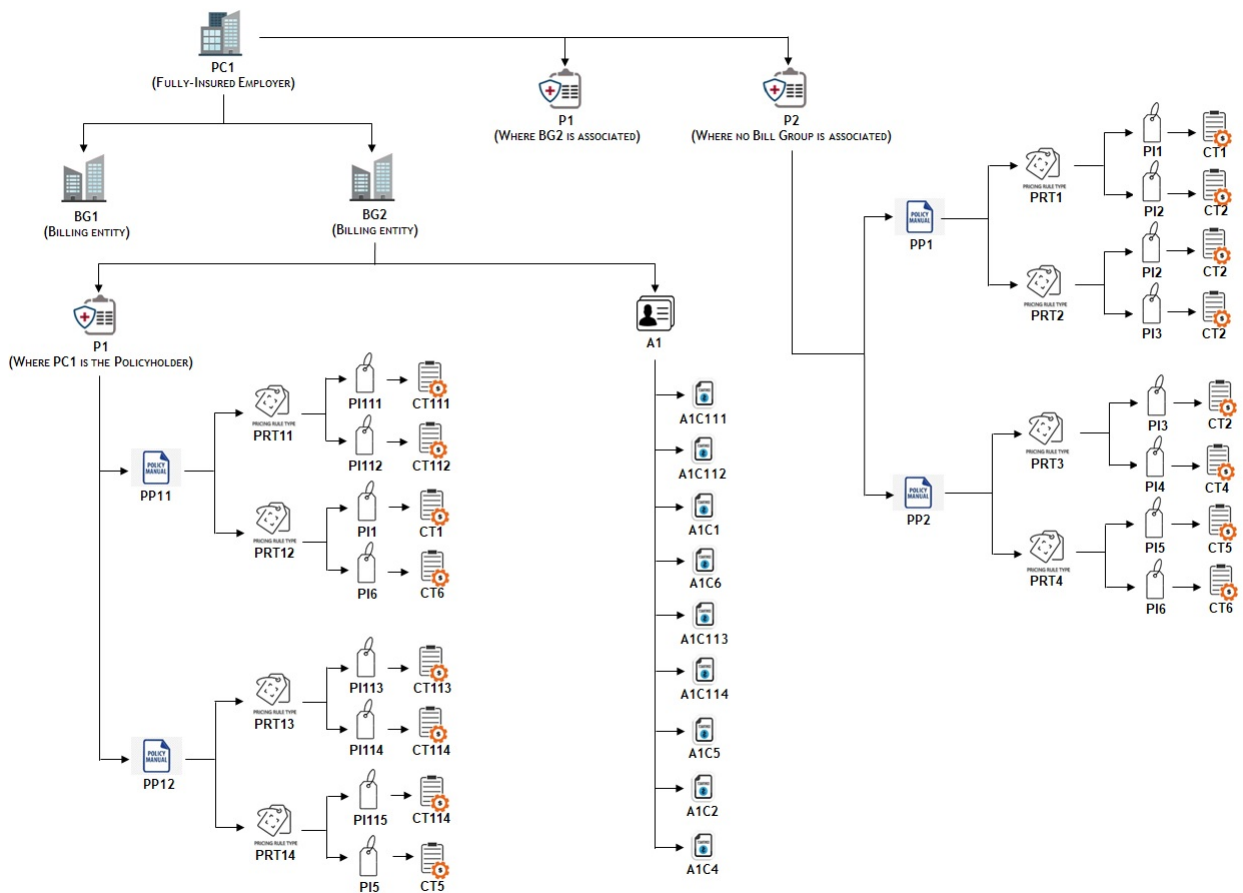
**Note:**

The system creates a contract using a contract type for an account only when the division to which the account and contract type belongs is same.

If a contract of a contract type is already present on the account, the system will not create a new contract. Instead, it will update the start date of the existing contract, if required.

Policy Plan Specific Contract Creation

In the [Single Contract Creation Across Fully-Insured Group Policies and Plans](#) on page 250 section, we have seen how the system creates one contract across fully-insured group policies and plans on the parent customer and/or bill group accounts. Alternatively, the system enables you to create a plan-specific contract (i.e. a contract using a contract type for each plan) on the parent customer and/or bill group accounts. You can opt for the plan-specific contract creation feature when you want to implement plan-specific business rules. For example, different payment priorities for your medical and dental plans. Under such conditions, you can create different contract types for different plans, say Medical and Dental and enable creation of different contracts using these contract types for billing different plans.

You can configure the plan-specific contract creation feature for the fully-insured group health insurance business by setting the following option types in the **C1-ASOBLNG** feature configuration:

- **Plan ID Characteristic Type** – Used to specify the characteristic type where you want to store the plan for which the contract is created. During the plan-specific contract creation, this characteristic is defined on the contract. Here, you must specify a characteristic type where the characteristic entity is set to **Contract**.
- **Plan Based Contract Creation Eligibility** – Used to indicate whether the system should create plan-specific contract on the account. The valid value is **Yes**.

Alternatively, you can also configure the plan-specific contract creation feature for specific persons (i.e. main customers of the policy) based on the business requirement. This is possible by setting the following option types in the **C1-ASOBLLNG** feature configuration:

- **Plan Based Contract Characteristic Type** – Used to specify the characteristic type which helps the system to determine whether plan-specific contracts should be created on the account. This characteristic must be defined on the person for whom you want to create plan-specific contracts on the accounts. Here, you must specify a characteristic type where the characteristic entity is set to **Person**.
- **Plan Based Contract Characteristic Value** – Used to specify the characteristic value which indicates that the system should create plan-specific contracts on the accounts.
- **Plan ID Characteristic Type** – Used to specify the characteristic type where you want to store the plan for which the contract is created. During the plan-specific contract creation, this characteristic is defined on the contract. Here, you must specify a characteristic type where the characteristic entity is set to **Contract**.

Here, the system creates or updates contracts of a policy plan when you do either of the following:

- **Create or Edit a Policy Plan from the User Interface or through an Inbound Message** – The system creates a contract in either of the following ways:
 - If a price item is associated with the policy plan, it creates a contract using the contract type which is associated with the price item.
 - If a pricing rule type is associated with the policy plan and the pricing rule type contains one or more price items, it creates one plan-specific contract using each contract type which may be associated with one or more price items. Let us assume that a pricing rule type named PRT1 is associated with the policy plan and it contains three price items – PI1, PI2, and PI3. Now, if the PI1 is associated with the CT1 contract type, PI2 is associated with the CT2 contract type, and PI3 is associated with the CT3 contract type, the system will create three contracts - C1 using CT1, C2 using CT2, and C3 using CT3. However, if the PI1 and PI3 are associated with the CT1 contract type and PI2 is associated with the CT2 contract type, the system will create two contracts - C1 using CT1 and C2 using CT2.

If a policy has two or more plans, multiple pricing rule types are associated with each policy plan and each pricing rule type contains multiple price items, it creates one plan-specific contract using each contract type which may be associated with one or more price items. Let us assume that P1 has two plans — PP1 and PP2, PRT1 is associated with PP1, PRT2 is associated with PP2, PRT1 contains three price items – PI1, PI2, and PI3, and PRT2 contains three price items – PI1, PI4, and PI5. Now, if the PI1 is associated with the CT1 contract type, PI2 is associated with the CT2 contract type, PI3 is associated with the CT3 contract type, PI4 is associated with the CT4 contract type, and PI5 is associated with the CT5 contract type, the system will create six contracts - C1PP1 using CT1 for PP1, C1PP2 using CT1 for PP2, C2PP1 using CT2 for PP1, C3PP1 using CT3 for PP1, C4PP2 using CT4 for PP2, and C5PP2 using CT5 for PP2. However, if PI1, PI2, and PI5 are associated with the CT1 contract type and PI3 and PI4 are associated with the CT2 contract type, the system will create four contracts - C1PP1 using CT1 for PP1, C1PP2 using CT1 for PP2, C2PP1 using CT2 for PP1, and C2PP2 using CT2 for PP2.

The status of each contract is set to **Active**. The contract start date is set to the start date of the respective plan. The default rate schedule specified on the respective contract type is added to the contract in the rate information and its effective date is set to the contract start date. The characteristic type, which is specified in the **Plan ID Characteristic Type** option type of the **C1-ASOBLLNG** feature configuration, is defined for each contract. It stores the plan ID which indicates the plan for which the contract is created.

Example 1 — Plan-Specific Contract Creation for a Parent Customer

If a policy plan belongs to a policy of the parent customer (where a bill group is not associated), the system will create one plan-specific contract using each contract type on each account of the parent customer and bill groups. Let us assume that...

- PC1 has two bill groups – BG1 and BG2
- PC1 has A1 account, BG1 has A2 account, and BG2 has A3 and A4 accounts

- A policy named P1 with two plans – PP1 and PP2 - is created for PC1 (where none of the bill groups are associated)
- PP1 (with the start date as 01-01-2019) is associated with PRT1 and PRT2
- PP2 (with the start date as 03-01-2019) is associated with PRT2 and PRT3
- PRT1 contains two price items – PI1 and PI2
- PRT2 contains three price items – PI1, PI3, and PI4
- PRT3 contains three price items – PI4, PI5, and PI6
- PI1 is associated with the CT1 contract type, PI2 is associated with the CT2 contract type, PI3 is associated with the CT3 contract type, PI4 and PI5 are associated with the CT4 contract type, and PI6 is associated with the CT6 contract type

Now, in such case, the system will create the following contracts on the A1, A2, A3, and A4 accounts:

Account	Plan	Pricing Rule Type	Price Item	Contract Type	Contract	Contract Start Date
A1	PP1	PRT1	PI1	CT1	A1C1PP1	01-01-2019
			PI2	CT2	A1C2PP1	01-01-2019
		PRT2	PI1	CT1	A1C1PP1	01-01-2019
			PI3	CT3	A1C3PP1	01-01-2019
			PI4	CT4	A1C4PP1	01-01-2019
		PP2	PRT2	PI1	CT1	A1C1PP2
	PI3			CT3	A1C3PP2	03-01-2019
	PI4			CT4	A1C4PP2	03-01-2019
	PRT3		PI4	CT4	A1C4PP2	03-01-2019
			PI5	CT4	A1C4PP2	03-01-2019
			PI6	CT6	A1C6PP2	03-01-2019
	A2	PP1	PRT1	PI1	CT1	A2C1PP1
PI2				CT2	A2C2PP1	01-01-2019
PRT2			PI1	CT1	A2C1PP1	01-01-2019
			PI3	CT3	A2C3PP1	01-01-2019
			PI4	CT4	A2C4PP1	01-01-2019
PP2			PRT2	PI1	CT1	A2C1PP2
		PI3		CT3	A2C3PP2	03-01-2019
		PI4		CT4	A2C4PP2	03-01-2019

Account	Plan	Pricing Rule Type	Price Item	Contract Type	Contract	Contract Start Date
		PRT3	PI4	CT4	A2C4PP2	03-01-2019
			PI5	CT4	A2C4PP2	03-01-2019
			PI6	CT6	A2C6PP2	03-01-2019
A3	PP1	PRT1	PI1	CT1	A3C1PP1	01-01-2019
			PI2	CT2	A3C2PP1	01-01-2019
		PRT2	PI1	CT1	A3C1PP1	01-01-2019
			PI3	CT3	A3C3PP1	01-01-2019
			PI4	CT4	A3C4PP1	01-01-2019
		PP2	PRT2	PI1	CT1	A3C1PP2
	PI3			CT3	A3C3PP2	03-01-2019
	PI4			CT4	A3C4PP2	03-01-2019
	PRT3		PI4	CT4	A3C4PP2	03-01-2019
			PI5	CT4	A3C4PP2	03-01-2019
			PI6	CT6	A3C6PP2	03-01-2019
	A4	PP1	PRT1	PI1	CT1	A4C1PP1
PI2				CT2	A4C2PP1	01-01-2019
PRT2			PI1	CT1	A4C1PP1	01-01-2019
			PI3	CT3	A4C3PP1	01-01-2019
			PI4	CT4	A4C4PP1	01-01-2019
PP2			PRT2	PI1	CT1	A4C1PP2
		PI3		CT3	A4C3PP2	03-01-2019
		PI4		CT4	A4C4PP2	03-01-2019
		PRT3	PI4	CT4	A4C4PP2	03-01-2019
			PI5	CT4	A4C4PP2	03-01-2019
			PI6	CT6	A4C6PP2	03-01-2019

The following figure graphically illustrates the example 1:

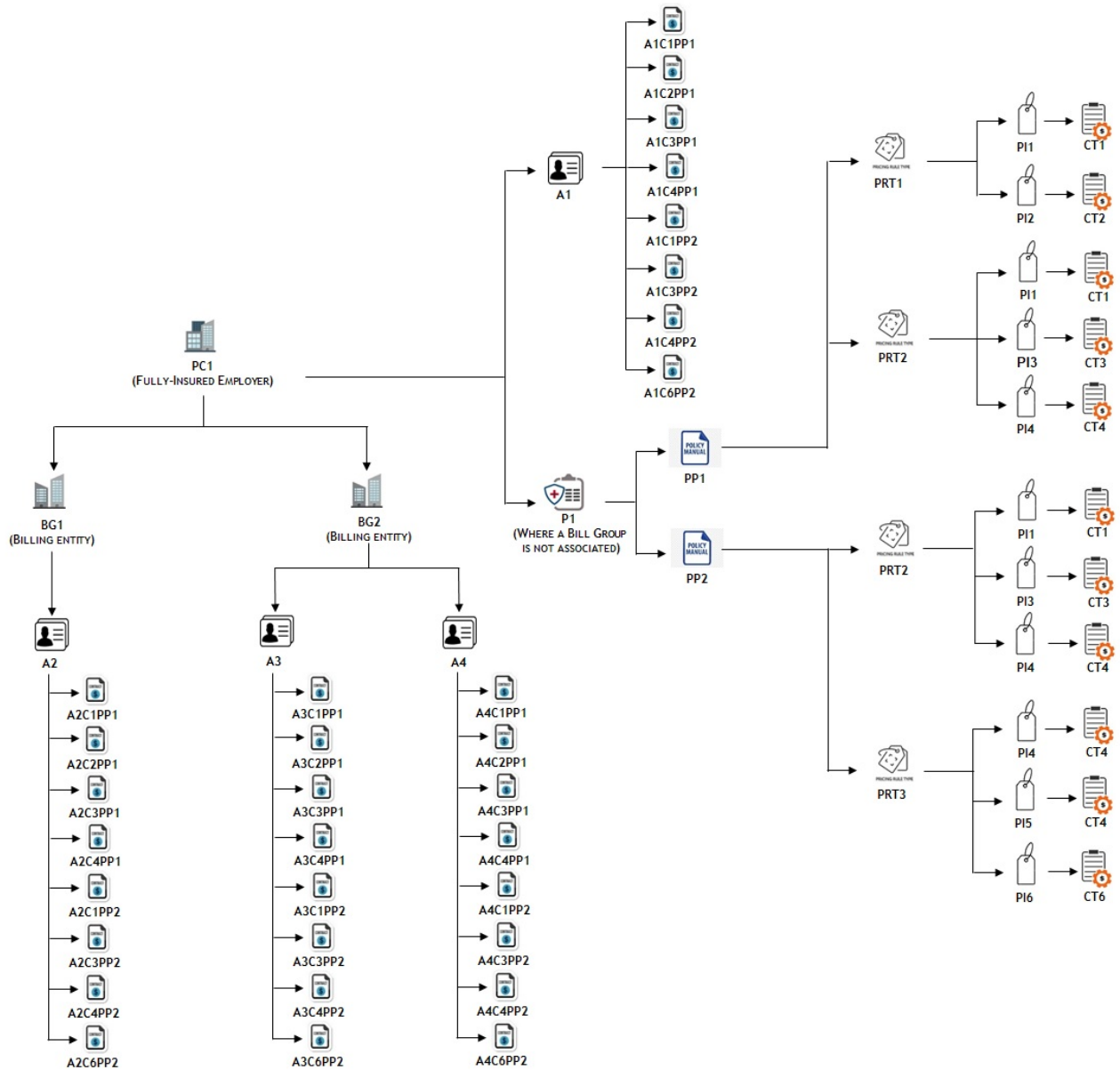

Example 2 — Plan-Specific Contract Creation for a Bill Group

If the policy plan belongs to a policy of a bill group (where the parent customer is the policy holder), the system will create one plan-specific contract using each contract type on each account of the parent customer and the bill group. Let us assume that...

- PC1 has two bill groups – BG1 and BG2
- PC1 has A1 account, BG1 has A2 account, and BG2 has A3 and A4 accounts
- A policy named P1 with three plans – PP1, PP2, and PP3 – is created for BG1 (where PC1 is the policy holder)
- PP1 (with the start date as 01-01-2019) is associated with PRT1 and PRT2
- PP2 (with the start date as 03-01-2019) is associated with PRT2 and PRT3
- PP3 (with the start date as 06-01-2019) is associated with PRT1
- PRT1 contains two price items – PI1 and PI2

- PRT2 contains three price items – PI1, PI3, and PI4
- PRT3 contains three price items – PI4, PI5, and PI6
- PI1 is associated with the CT1 contract type, PI2 is associated with the CT2 contract type, PI3 is associated with the CT3 contract type, PI4 and PI5 are associated with the CT4 contract type, and PI6 is associated with the CT6 contract type

Now, in such case, the system will create the following contracts on the A1 and A2 accounts:

Account	Plan	Pricing Rule Type	Price Item	Contract Type	Contract	Contract Start Date
A1	PP1	PRT1	PI1	CT1	A1C1PP1	01-01-2019
			PI2	CT2	A1C2PP1	01-01-2019
		PRT2	PI1	CT1	A1C1PP1	01-01-2019
			PI3	CT3	A1C3PP1	01-01-2019
			PI4	CT4	A1C4PP1	01-01-2019
		PP2	PRT2	PI1	CT1	A1C1PP2
	PI3			CT3	A1C3PP2	03-01-2019
	PI4			CT4	A1C4PP2	03-01-2019
	PRT3		PI4	CT4	A1C4PP2	03-01-2019
			PI5	CT4	A1C4PP2	03-01-2019
			PI6	CT6	A1C6PP2	03-01-2019
	PP3	PRT1	PI1	CT1	A1C1PP3	06-01-2019
PI2			CT2	A1C2PP3	06-01-2019	
A2	PP1	PRT1	PI1	CT1	A2C1PP1	01-01-2019
			PI2	CT2	A2C2PP1	01-01-2019
		PRT2	PI1	CT1	A2C1PP1	01-01-2019
			PI3	CT3	A2C3PP1	01-01-2019
			PI4	CT4	A2C4PP1	01-01-2019
		PP2	PRT2	PI1	CT1	A2C1PP2
	PI3			CT3	A2C3PP2	03-01-2019
	PI4			CT4	A2C4PP2	03-01-2019
	PRT3		PI4	CT4	A2C4PP2	03-01-2019
				PI5	CT4	A2C4PP2

Account	Plan	Pricing Rule Type	Price Item	Contract Type	Contract	Contract Start Date
			PI6	CT6	A2C6PP2	03-01-2019
	PP3	PRT1	PI1	CT1	A2C1PP3	06-01-2019
			PI2	CT2	A2C2PP3	06-01-2019

The following figure graphically illustrates the example 2:

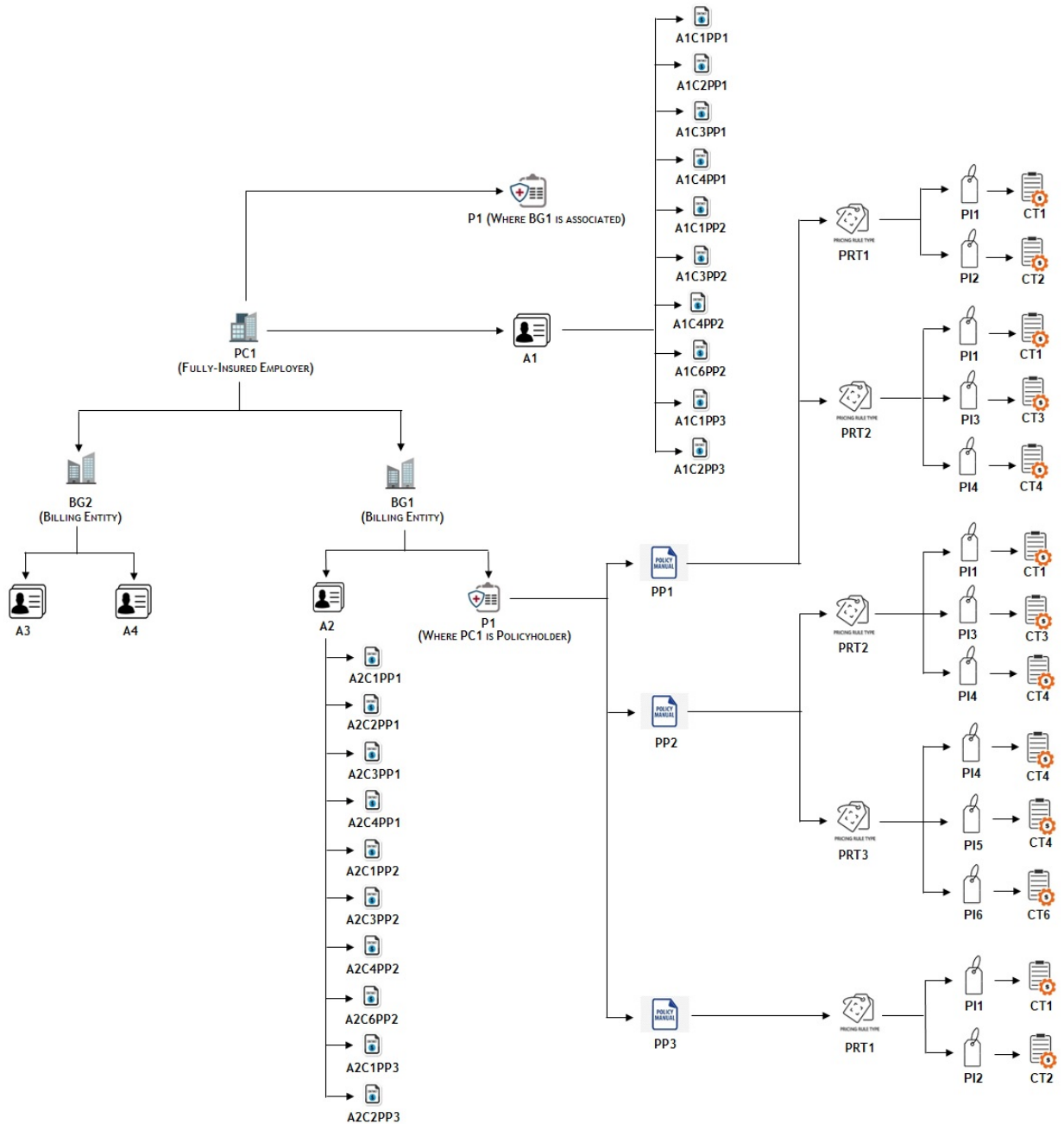

Note: The system creates a contract using a contract type for an account when the division to which the account and contract type belongs is same.

- **Create or Edit an Account from the User Interface or through an Inbound Message** – The system creates a contract when either of the following condition is met:
 - The main customer of the account is a parent customer and holds a policy (where a bill group is not associated) which is created using the policy type where the policy category is set to **Fully-Insured Group**.
 - The main customer of the account is a parent customer and holds a policy (where a bill group is associated) which is created using the policy type where the policy category is set to **Fully-Insured Group**.
 - The main customer of the account is a bill group and holds a policy (where the parent customer is the policy holder) which is created using the policy type where the policy category is set to **Fully-Insured Group**.

The system creates a contract in either of the following ways:

- If a price item is associated with the policy plan, it creates a contract using the contract type which is associated with the price item.
- If a pricing rule type is associated with the policy plan and the pricing rule type contains one or more price items, it creates one plan-specific contract using each contract type which may be associated with one or more price items. Let us assume that a pricing rule type named PRT1 is associated with the policy plan and it contains three price items – PI1, PI2, and PI3. Now, if the PI1 is associated with the CT1 contract type, PI2 is associated with the CT2 contract type, and PI3 is associated with the CT3 contract type, the system will create three contracts - C1 using CT1, C2 using CT2, and C3 using CT3. However, if the PI1 and PI3 are associated with the CT1 contract type and PI2 is associated with the CT2 contract type, the system will create two contracts - C1 using CT1 and C2 using CT2.

If a policy has two or more plans, multiple pricing rule types are associated with each policy plan and each pricing rule type contains multiple price items, it creates one plan-specific contract using each contract type which may be associated with one or more price items. Let us assume that P1 has two plans — PP1 and PP2, PRT1 is associated with PP1, PRT2 is associated with PP2, PRT1 contains three price items – PI1, PI2, and PI3, and PRT2 contains three price items – PI1, PI4, and PI5. Now, if the PI1 is associated with the CT1 contract type, PI2 is associated with the CT2 contract type, PI3 is associated with the CT3 contract type, PI4 is associated with the CT4 contract type, and PI5 is associated with the CT5 contract type, the system will create six contracts - C1PP1 using CT1 for PP1, C1PP2 using CT1 for PP2, C2PP1 using CT2 for PP1, C3PP1 using CT3 for PP1, C4PP2 using CT4 for PP2, and C5PP2 using CT5 for PP2. However, if PI1, PI2, and PI5 are associated with the CT1 contract type and PI3 and PI4 are associated with the CT2 contract type, the system will create four contracts - C1PP1 using CT1 for PP1, C1PP2 using CT1 for PP2, C2PP1 using CT2 for PP1, and C2PP2 using CT2 for PP2.

The status of each contract is set to **Active**. The contract start date is set to the start date of the respective plan. The default rate schedule specified on the respective contract type is added to the contract in the rate information and its effective date is set to the contract start date. The characteristic type, which is specified in the **Plan ID Characteristic Type** option type of the **C1-ASOBLLNG** feature configuration, is defined for each contract. It stores the plan ID which indicates the plan for which the contract is created.

Example 3 — Plan-Specific Contract Creation for an Account of a Parent Customer

If you create an account for a parent customer who holds policies (where a bill group may or may not be associated), the system will create one plan-specific contract using each contract type for all parent customer's policies on the account. Let us assume...

- PC1 has two bill groups – BG1 and BG2
- PC1 has two policies – a policy named P1 (where a bill group is not associated) and a policy named P2 (where BG1 is associated)
- BG1 has one policy named P2 where PC1 is the policy holder
- An account named A1 is added for PC1

- P1 has two plans – PP1 and PP2
- P2 has two plans – PP11 and PP12
- PP1 (with the start date as 01-01-2019) is associated with PRT1 and PRT2
- PP2 (with the start date as 06-01-2019) is associated with PRT2, PRT3, and PRT4
- PP11 (with the start date as 05-01-2019) is associated with PRT111 and PRT112
- PP12 (with the start date as 09-01-2019) is associated with PRT113 and PRT114
- PRT1 contains two price items – PI1 and PI2
- PRT2 contains two price items – PI3 and PI4
- PRT3 contains two price items – PI1 and PI5
- PRT4 contains two price items – PI6 and PI7
- PRT111 contains two price items – PI11 and PI12
- PRT112 contains two price items – PI1 and PI5
- PRT113 contains two price items – PI13 and PI14
- PRT114 contains two price items – PI7 and PI15
- PI1 is associated with the CT1 contract type, PI2 and PI3 are associated with the CT2 contract type, PI4 is associated with the CT4 contract type, PI5 is associated with the CT5 contract type, PI6 is associated with the CT6 contract type, PI7 is associated with the CT7 contract type, PI11 is associated with the CT11 contract type, PI12 is associated with the CT12 contract type, PI13 is associated with the CT13 contract type, PI14 is associated with the CT14 contract type, and PI15 is associated with the CT15 contract type

Now, in such case, the system will create the following contracts on the A1 account:

Account	Policy	Plan	Pricing Rule Type	Price Item	Contract Type	Contract	Contract Start Date	
A1	P1	PP1	PRT1	PI1	CT1	A1C1PP1	01-01-2019	
				PI2	CT2	A1C2PP1	01-01-2019	
			PRT2	PI3	CT2	A1C2PP1	01-01-2019	
				PI4	CT4	A1C4PP1	01-01-2019	
		PP2	PRT2	PI3	CT2	A1C2PP2	06-01-2019	
				PI4	CT4	A1C4PP2	06-01-2019	
			PRT3	PI1	CT1	A1C1PP2	06-01-2019	
				PI5	CT5	A1C5PP2	06-01-2019	
			PRT4	PI6	CT6	A1C6PP2	06-01-2019	
				PI7	CT7	A1C7PP2	06-01-2019	
		P2	PP11	PRT111	PI11	CT11	A1C11PP11	05-01-2019
					PI12	CT12	A1C12PP11	05-01-2019

Account	Policy	Plan	Pricing Rule Type	Price Item	Contract Type	Contract	Contract Start Date
			PRT112	PI1	CT1	A1C1PP11	05-01-2019
				PI5	CT5	A1C5PP11	05-01-2019
		PP12	PRT113	PI13	CT13	A1C13PP12	09-01-2019
				PI14	CT14	A1C14PP12	09-01-2019
			PRT114	PI7	CT7	A1C7PP12	09-01-2019
				PI15	CT15	A1C15PP12	09-01-2019

The following figure graphically illustrates the example 3:

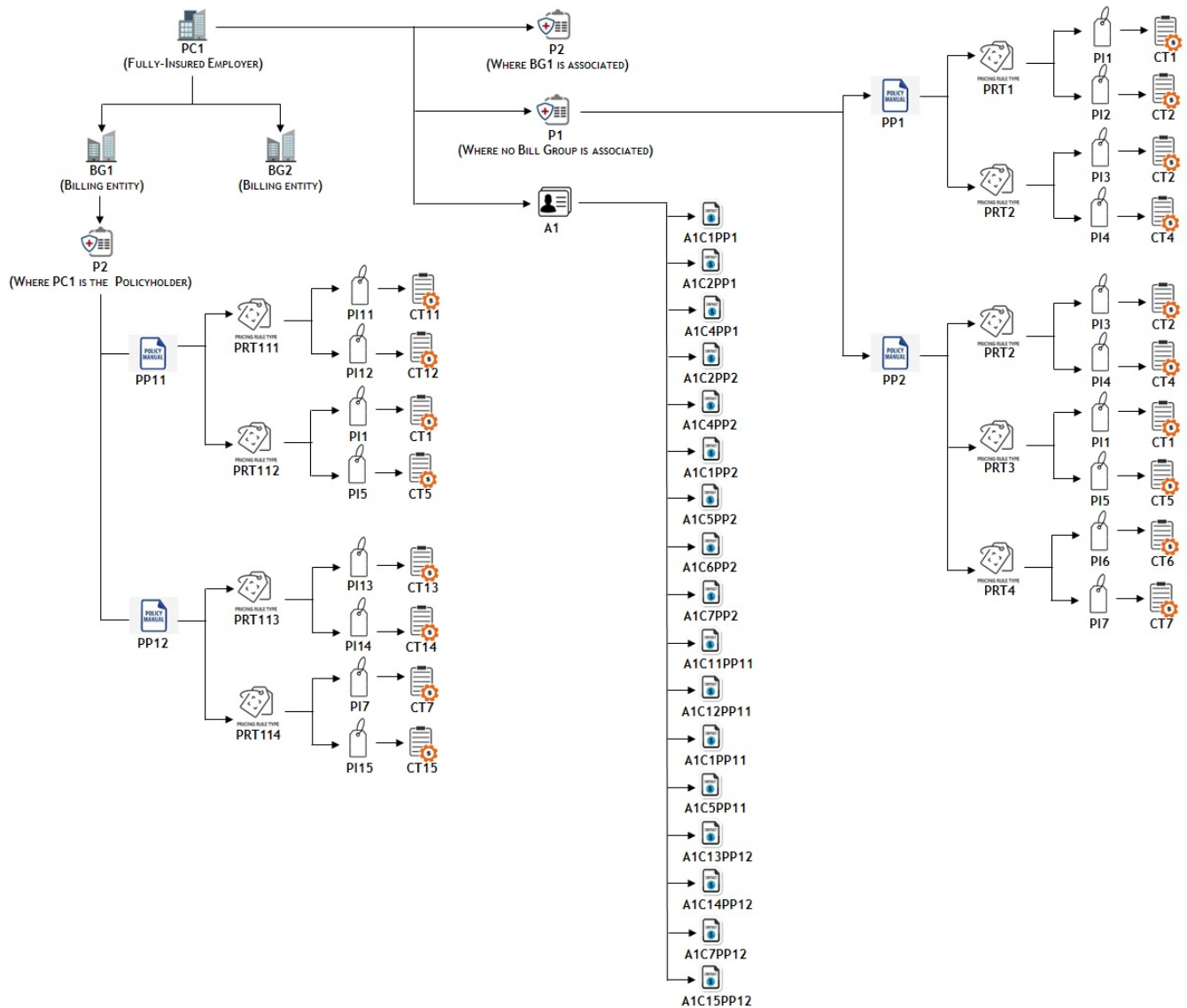

Example 4 — Plan-Specific Contract Creation for an Account of a Bill Group

If you create an account for a bill group who holds policies and its parent customer holds policies (where a bill group may or may not be associated), the system will create one plan-specific contract using each contract type for the bill group's polices and parent customer's polices (where a bill group is not associated) on the account. Let us assume...

- PC1 has two bill groups – BG1 and BG2
- PC1 has two policies – a policy named P2 (where a bill group is not associated) and a policy named P1 (where BG2 is associated)
- BG2 has one policy named P1 where PC1 is the policy holder
- An account named A1 is added for BG2
- P1 has two plans – PP11 and PP12
- P2 has two plans – PP1 and PP2
- PP1 (with the start date as 01-01-2019) is associated with PRT1 and PRT2
- PP2 (with the start date as 04-01-2019) is associated with PRT3 and PRT4
- PP11 (with the start date as 07-01-2019) is associated with PRT11 and PRT12
- PP12 (with the start date as 11-01-2019) is associated with PRT13 and PRT14
- PRT1 contains two price items – PI1 and PI2
- PRT2 contains two price items – PI3 and PI2
- PRT3 contains two price items – PI3 and PI4
- PRT4 contains two price items – PI5 and PI6
- PRT11 contains two price items – PI111 and PI112
- PRT12 contains two price items – PI1 and PI6
- PRT13 contains two price items – PI113 and PI114
- PRT14 contains two price items – PI115 and PI5
- PI1 is associated with the CT1 contract type, PI2 and PI3 are associated with the CT2 contract type, PI4 is associated with the CT4 contract type, PI5 is associated with the CT5 contract type, PI6 is associated with the CT6 contract type, PI111 is associated with the CT111 contract type, PI112 is associated with the CT112 contract type, PI113 is associated with the CT113 contract type, and PI114 and PI115 is associated with the CT114 contract type

Now, in such case, the system will create the following contracts on the A1 account:

Account	Policy	Plan	Pricing Rule Type	Price Item	Contract Type	Contract	Contract Start Date
A1	P1	PP11	PRT11	PI111	CT111	A1C111PP11	07-01-2019
				PI112	CT112	A1C112PP11	07-01-2019
			PRT12	PI1	CT1	A1C1PP11	07-01-2019
				PI6	CT6	A1C6PP11	07-01-2019
		PP12	PRT13	PI113	CT113	A1C113PP12	11-01-2019

Account	Policy	Plan	Pricing Rule Type	Price Item	Contract Type	Contract	Contract Start Date
				PI114	CT114	A1C114PP12	11-01-2019
			PRT14	PI115	CT114	A1C114PP12	11-01-2019
				PI5	CT5	A1C5PP12	11-01-2019
	P2	PP1	PRT1	PI1	CT1	A1C1PP1	01-01-2019
				PI2	CT2	A1C2PP1	01-01-2019
			PRT2	PI2	CT2	A1C2PP1	01-01-2019
				PI3	CT2	A1C2PP1	01-01-2019
		PP2	PRT3	PI3	CT2	A1C2PP2	04-01-2019
				PI4	CT4	A1C4PP2	04-01-2019
			PRT4	PI5	CT5	A1C5PP2	04-01-2019
				PI6	CT6	A1C6PP2	04-01-2019

The following figure graphically illustrates the example 4:

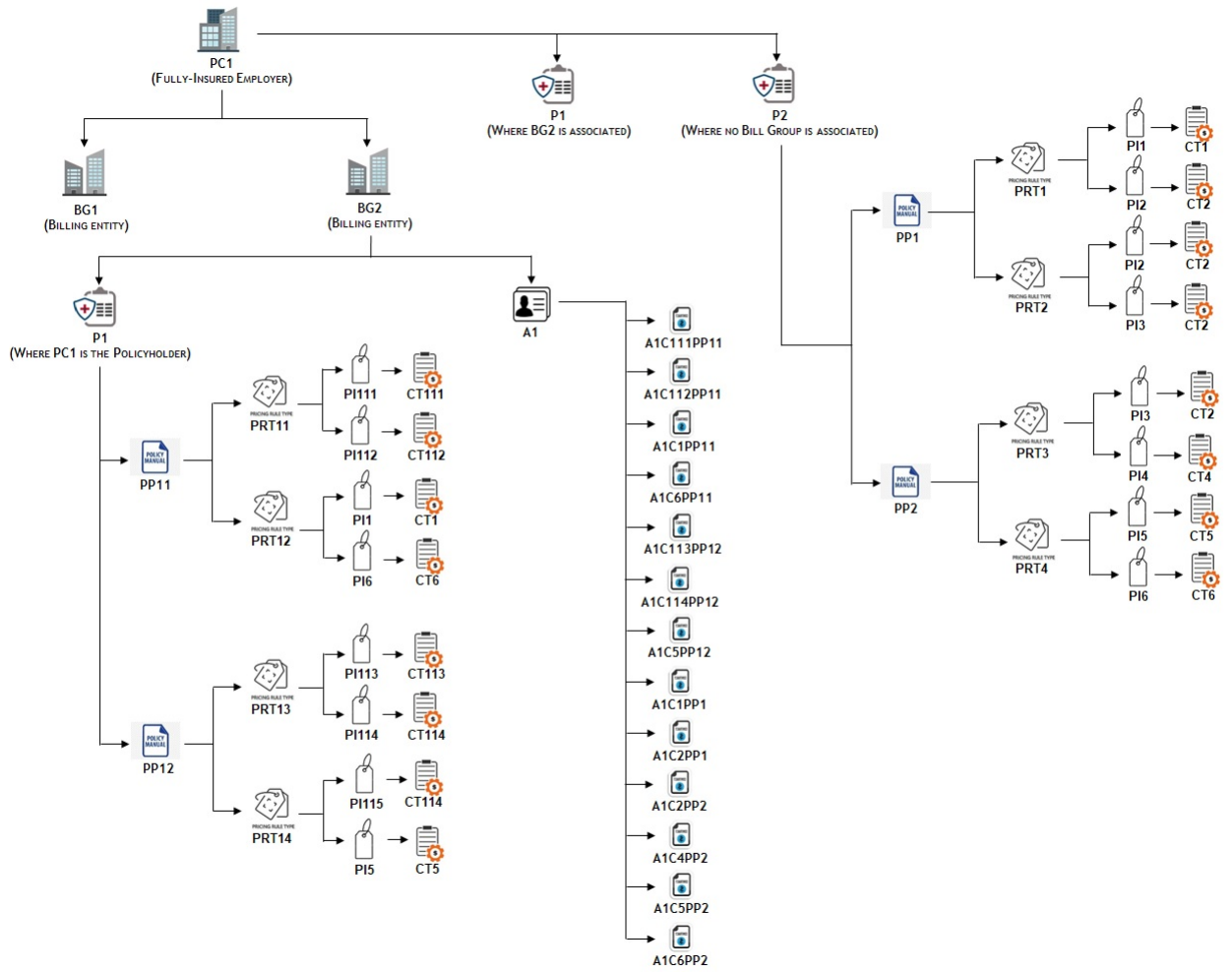

Note: The system creates a contract using a contract type for an account only when the division to which the account and contract type belongs is same.

Fully-Insured Group Policy Status Transition

The following figure graphically indicates how a fully-insured group policy moves from one status to another in its lifecycle:

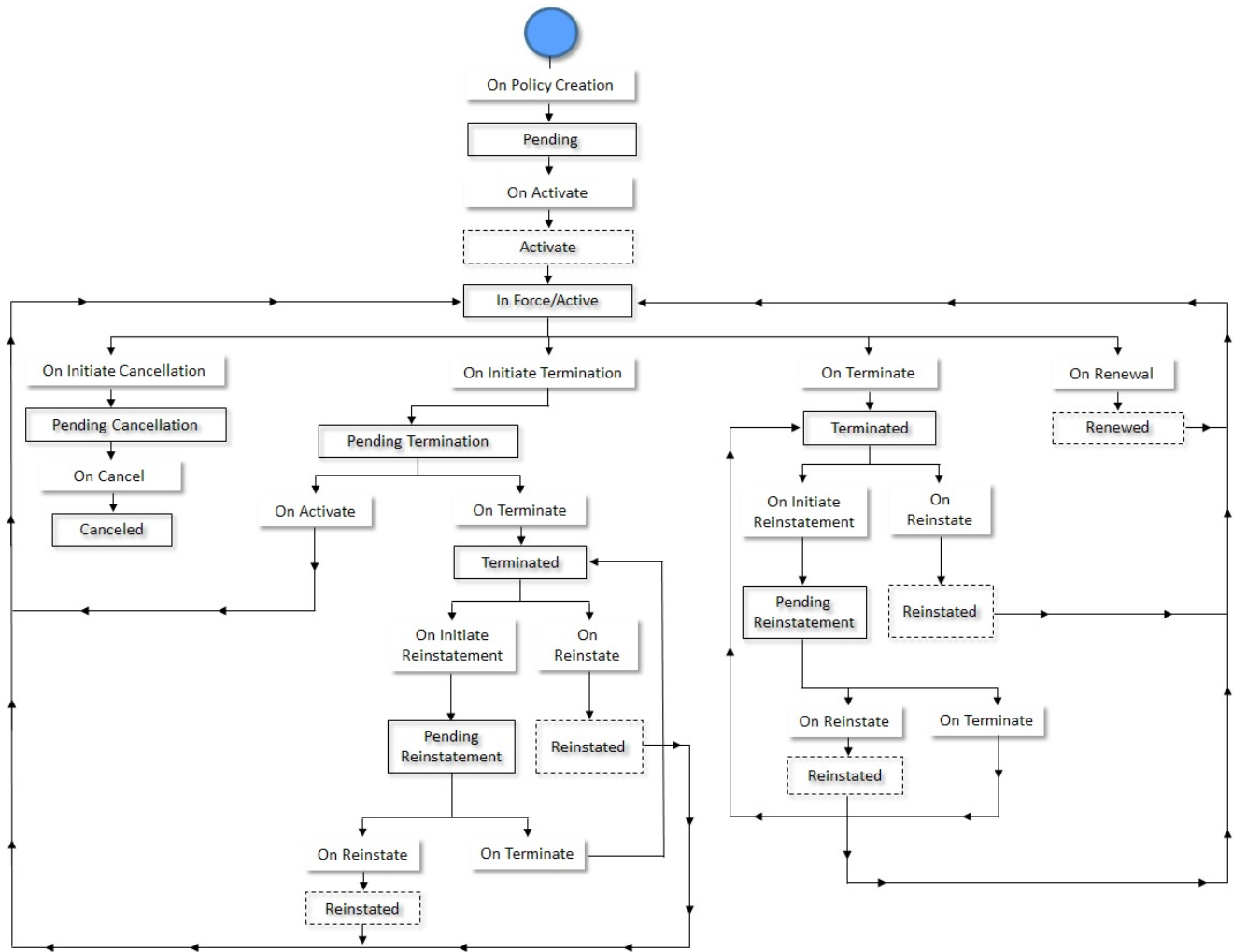

Membership Status Transition

The following figure graphically indicates how a membership moves from one status to another in its lifecycle:

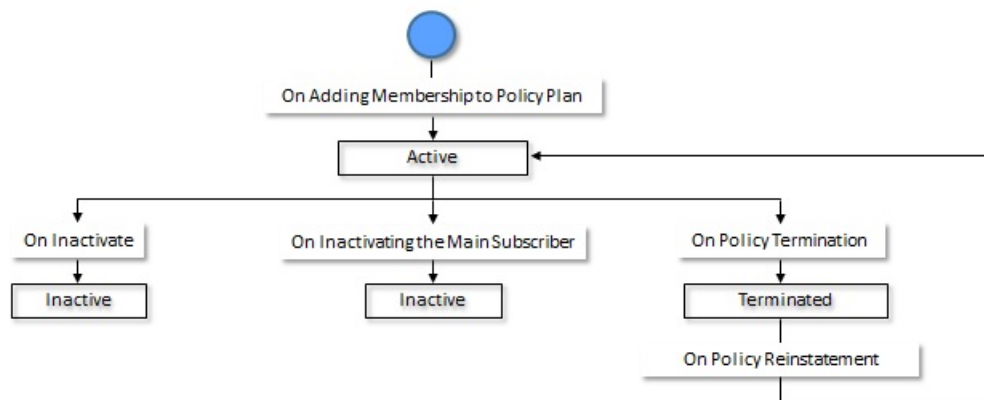

Types of Policy Plan

Oracle Revenue Management and Billing enables you to create different types of plan for a fully-insured group policy:

- [Commercial Plans](#) on page 283
- [Medicare Affiliated Plans](#) on page 284

Commercial Plans

A commercial plan is a health insurance plan which is offered and administered by non-governmental entities (i.e. insurance companies). It can cover medical or dental expenses and disability income for the insured. Two of the most popular types of commercial health insurance plans are:

- **Preferred Provider Organization (PPO)** - A Preferred Provider Organization (PPO) is a medical care arrangement in which medical professionals and facilities provide services to subscribed clients at reduced rates.
- **Health Maintenance Organization (HMO)** - A Health Maintenance Organization (HMO) is an insurance structure that provides coverage through a network of physicians at a fixed annual fee.

A commercial health insurance plan can be offered to the individual or group customers. Usually, the insurance companies design special commercial health plans for fully-insured group customers and provide cost-effective health coverage for the employees and their family members (at an additional cost).

The system enables you to create and edit a policy plan from the user interface or through a health care inbound message. While creating a Commercial policy plan, you must set the benefit type to **Commercial**. While defining a Commercial policy plan, you need to specify either a price item or at least one pricing rule type. The price item given in the policy plan is used to create a pass-through billable charge for pre-calculated premium amount which is received through a health care inbound message.

Alternatively, you can associate a pricing rule type with a policy plan. You can associate the age based, tier based, pass-through billable charge, and/or additional charge pricing rule types with a Commercial policy plan. If you associate an age based pricing rule type with the policy plan, the system calculates the active employee coverage or COBRA membership premium for eligible members using the age based pricing rule type. If you associate a tier based pricing rule type with the policy plan, the system calculates the active employee coverage or COBRA membership premium using the tier based pricing rule type. The active employee coverage and COBRA membership premium are then charged through the SQI based billable charges. In case of an active employee coverage membership, the charge is billed to the bill group of the fully-insured group customer. However, in case of a COBRA membership, the charge is billed to either of the following depending on the billing arrangement which is defined for the COBRA membership:

- Bill Group of the Fully-Insured Group Customer
- TPA Person
- Financially Responsible Member Person

If you associate an additional charge pricing rule type (which is a related pricing rule type) with the policy plan, the system derives the flat or percentage based administration fee for the COBRA membership using the additional charge pricing rule type. This administration fee is charged along with the COBRA membership premium through an SQI based billable charge

If you associate a pass-through billable charge pricing rule type with the policy plan, the system creates an SQI based billable charge using the pass-through billable charge pricing rule type whenever the price item information is given, but the account information is not given in a health care inbound message. Note that if both the price item and account details are given in the billable charge information of a health care inbound message, the system directly creates the SQI based billable charge for the pre-calculated premium and does not refer to the pass-through billable charge pricing rule type which is associated with the policy plan.

The system enables you to prorate the membership premium using the proration rules defined for the fully-insured group policy plan. A proration rule indicates how you want to prorate the membership premium on various events, such as enrollment, termination, etc. For more information, refer to [Premium Proration Rules](#) on page 3128.

Medicare Affiliated Plans

A Group Medicare Advantage plan, also known as Employer Group Waiver Plan (EGWP), is a type of Medicare Advantage plan offered by some employers to their retired or retiring employees. It may offer more benefits than traditional Medicare Advantage plans. EGWP are provided by private insurance companies who manage fully-insured large group customer's retiree Medicare benefits. The different parts of Medicare that EGWPs cover are:

- **Part A** - Medicare Part A insurance is the portion that pays for hospital costs, such as inpatient hospital care or rehabilitation facility care related to illness or injury.
- **Part B** - Medicare Part B is the Medicare portion that pays for doctor visits and related medical costs, including emergency care when you are not admitted.
- **Part D** - Medicare Part D is the prescription drug coverage portion of Medicare. Most prescription drug coverage plans involve different "tiers" of medications where you may pay little to no costs for generic medications and a greater portion of costs for name-brand medicines.

The system enables you to create and edit a policy plan from the user interface or through a health care inbound message. While creating a Medicare Affiliated policy plan, you must set the benefit type to **Medicare Affiliated**. While defining a Medicare Affiliated policy plan, you need to specify either a price item or at least one pricing rule type. The price item given in the policy plan is used to create a pass-through billable charge for pre-calculated premium amount which is received through a health care inbound message.

Alternatively, you can associate a pricing rule type with a policy plan. You can associate the age based, tier based, pass-through billable charge, and/or benefit pricing rule types with a Medicare Affiliated policy plan. If you associate an age based pricing rule type with the policy plan, the system calculates the Medicare premium for Part A, Part B, and/or Part D for eligible members using the age based pricing rule type. If you associate a tier based pricing rule type with the policy plan, the system calculates the Medicare membership premium for Part A, Part B, and Part D using the tier based pricing rule type. This membership premium is then charged through the SQI based billable charge. The charge is billed to either of the following depending on the billing arrangement which is defined for the Medicare membership:

- Bill Group of the Fully-Insured Group Customer
- Financially Responsible Member Person

The system considers the low income subsidy (LIS) and late enrollment penalty (LEP) while calculating the Medicare Part D premium. If you associate a benefit pricing rule type with the policy plan, the system determines the price items through which LIS and LEP should be charged.

If you associate a pass-through billable charge pricing rule type with the policy plan, the system creates an SQI based billable charge using the pass-through billable charge pricing rule type whenever the price item information is given, but the account information is not given in a health care inbound message. Note that if both the price item and account details are given in the billable charge information of a health care inbound message, the system directly creates the SQI based billable charge for the pre-calculated premium and does not refer to the pass-through billable charge pricing rule type which is associated with the policy plan.

The system enables you to prorate the Medicare premium using the proration rules defined for the fully-insured group policy plan. A proration rule indicates how you want to prorate the membership premium on various events, such as enrollment, termination, etc. For more information, refer to [Premium Proration Rules](#) on page 3128.

Types of Membership

Oracle Revenue Management and Billing enables you to create different types of membership for a fully-insured group policy plan:

- [Active Employee Coverage Membership](#) on page 285

- [Medicare Membership](#) on page 286
- [COBRA Membership](#) on page 288
- [Retiree Membership](#) on page 290

Active Employee Coverage Membership

Oracle Revenue Management and Billing enables you to maintain an active employee coverage membership for the group insurance health plans and charge age based or tier based premium for the active employee coverage membership. An active employee coverage membership includes the employee or member of the organization who is covered under the group health insurance plan. Here, the covered employee or member is known as the main subscriber of the membership.

If the health insurance coverage is extended to the immediate family and/or other dependents of group members for an extra cost, the active employee coverage membership may include dependents who are related to the main subscriber. The system enables you to define various relationship types using which you can relate main subscriber and other dependent persons in a membership. You can define and edit relationship types through the **Contract Relationship Type** screen. The dependents can be members or non-members in an active employee coverage membership. The system calculates age based premium for both eligible members and non-members in an active employee coverage membership. If you select the **Skip Non-Members** option in the age based pricing rule type, the system will only consider the eligible members and not non-members of the active employee coverage membership during age based premium calculation.

The system enables you to create and edit an active employee coverage membership from the user interface, through a health care inbound message, or through the membership repricing inbound web service. While creating an active employee coverage membership, you must not set the membership type of the membership (i.e. leave the **Membership Type** field blank). Ideally, you must define an active employee coverage membership on a Commercial policy plan. However, at present, the system does not validate whether an active employee coverage membership is defined only on a Commercial policy plan and not on a Medicare Affiliated policy plan.

You can create an active employee coverage membership when you specify the main subscriber of the membership. Ideally, the main subscriber and dependent persons should exist as persons in the system before creating the active employee coverage membership from the user interface, through a health care inbound message, or through the membership repricing inbound web service. The system enables you to create the main subscriber, dependent persons, and active employee coverage membership through the same health care inbound message or through the same membership repricing request. In such case, the system will first create the person records for the main subscriber and dependent persons and then create the active employee coverage membership.

On creating an active employee coverage membership, the status of the membership and main subscriber is set to **Active**. On adding a dependent person to a membership, the status of the dependent person is set to **Active**. You can inactivate an active employee coverage membership from the user interface, through a health care inbound message, or through the membership repricing inbound web service. There are two ways in which you can inactivate the membership from the user interface:

- On clicking the **Inactivate** button
- On inactivating the main subscriber of the membership

However, through a health care inbound message or through the membership repricing inbound web service, you can inactivate the membership only by inactivating the main subscriber of the membership. On inactivating the main subscriber of an active employee coverage membership, the system automatically inactivates the membership and all other member persons which are included in the membership. The status of the active employee coverage membership, main subscriber, and other member persons (if any) is set to **Inactive**. In addition, the system does the following:

- Cancels the billable charges which are created for the membership
- Cancels the corresponding bill segments (if any)

If an audit event exists for the membership which is inactivated, the **BO_STATUS_CD** column corresponding to the record in the **C1_AUDIT_EVENT**, **C1_AUDIT_EVENT_LOG**, and **CI_PRCE_CALC** tables is set to **INVALID**. If a repricing entity detail record exists for the membership in the **PENDING** or **ERROR** status, then the **BO_STATUS_CD** column corresponding to the record in the **CI_REPRC_ENTITY_DTL** table is set

to **COMPLETE**. If a repricing request exists for the membership in the **PENDING** or **ERROR** status, then the **BO_STATUS_CD** column corresponding to the record in the **CI_REPRC_REQ_DTL** table is set to **COMPLETE**.

You can also inactivate a member person, who is not the main subscriber of an active employee coverage membership, from the user interface, through a health care inbound message, or through the membership repricing inbound web service. On inactivating the member person, the status of the member person is set to **Inactive**.

On terminating a fully-insured group policy, the status of all active employee coverage memberships on the respective policy plans is set to **Terminated**. Similarly, on reinstating a fully-insured group policy, the status of all active employee coverage memberships on the respective policy plans is set to **Active**.

The system requires the following information to create charges for an active employee coverage membership:

- Whom to bill the active employee coverage membership charges
- Age based or tier based pricing rules using which the premium should be calculated for the active employee coverage membership
- Respective age based or tier based pricing rule type associated with the respective policy plan

The system supports the following billing arrangements for an active employee coverage membership:

- **Group Billing** – Here, an active employee coverage membership is billed to a bill group which is derived for the active employee coverage membership.
- **Direct Billing** – Here, an active employee coverage membership is billed to the member who is financially responsible for the active employee coverage membership.

You can indicate the billing arrangement for the active employee coverage memberships by defining a characteristic on the bill group or parent customer. The system searches for the characteristic which is specified in the **Billing Arrangement** option type of the **C1-ASOBLNG** feature configuration on the following entities in the specified sequence:

1. Bill Group
2. Parent Customer

Note: If the billing arrangement characteristic is not defined for any of the above listed entities, the system, by default, charges the active employee coverage membership premium to the bill group.

The system requires the bill group and its account to bill the active employee coverage memberships when the billing arrangement is set to **Group Billing**. You can create a bill group and its account from the user interface or through a health care inbound message. On creating an account for a bill group, the system automatically creates a contract on the account using distinct contract types for all policy plans of the parent customer and bill group policies. While creating a contract, the system considers all price items in all pricing rule types (including the related pricing rule types) which are associated with the policy plans of the parent customer and bill group policies.

The system requires the member person's account to bill the active employee coverage membership when the billing arrangement is set to **Direct Billing**. You can create an account for a member person who is financially responsible for the active employee coverage membership through a health care inbound message. On creating an account for a member person, the system automatically creates a contract on the account using distinct contract types for the respective policy plan. While creating a contract, the system considers all price items in all pricing rule types (including the related pricing rule types) which are associated with the respective policy plan.

Medicare Membership

Oracle Revenue Management and Billing enables you to maintain an employer sponsored group medicare membership (800 series plans) for a fully-insured large group customer and create age based or tier based premium charges for the Medicare Part A, Part B, and Part D. A Medicare beneficiary may qualify for a low income subsidy (LIS) for Medicare Part D or may incur late enrollment penalty (LEP) for Medicare Part D. In such case, the system enables you to consider the low income subsidy (LIS) and late enrollment penalty (LEP) while calculating the Medicare Part D premium.

The system enables you to create and edit a Medicare membership from the user interface, through a health care inbound message, or through the membership repricing inbound web service. While creating a Medicare membership, you must set the membership type to **Medicare**. Ideally, you must define a Medicare membership on a Medicare Affiliated policy

plan. However, at present, the system does not validate whether a Medicare membership is defined only on a Medicare Affiliated policy plan and not on a Commercial policy plan.

You can create a Medicare membership when you specify the main subscriber of the membership. A Medicare membership should have only one member person who is covered for Medicare and who is financially responsible for the membership. Ideally, the main subscriber should exist as a person in the system before creating the Medicare membership from the user interface, through a health care inbound message, or through the membership repricing inbound web service. The system enables you to create the main subscriber and Medicare membership through the same health care inbound message or through the same membership repricing request. In such case, the system will first create the person record for the main subscriber and then create the Medicare membership.

On creating a Medicare membership, the status of the membership and main subscriber is set to **Active**. You can inactivate a Medicare membership from the user interface, through a health care inbound message, or through the membership repricing inbound web service. There are two ways in which you can inactivate the membership from the user interface:

- On clicking the **Inactivate** button
- On inactivating the main subscriber of the membership

However, through a health care inbound message or through the membership repricing inbound web service, you can inactivate the membership only by inactivating the main subscriber of the membership. On inactivating a Medicare membership, the system does the following:

- Set the status of the membership and main subscriber to **Inactive**
- Cancels the billable charges which are created for the membership
- Cancels the corresponding bill segments (if any)

If an audit event exists for the membership which is inactivated, the **BO_STATUS_CD** column corresponding to the record in the **C1_AUDIT_EVENT**, **C1_AUDIT_EVENT_LOG**, and **CI_PRCE_CALC** tables is set to **INVALID**. If a repricing entity detail record exists for the membership in the **PENDING** or **ERROR** status, then the **BO_STATUS_CD** column corresponding to the record in the **CI_REPRC_ENTITY_DTL** table is set to **COMPLETE**. If a repricing request exists for the membership in the **PENDING** or **ERROR** status, then the **BO_STATUS_CD** column corresponding to the record in the **CI_REPRC_REQ_DTL** table is set to **COMPLETE**.

On terminating a fully-insured group policy, the status of all Medicare memberships on the respective policy plans is set to **Terminated**. Similarly, on reinstating a fully-insured group policy, the status of all Medicare memberships on the respective policy plans is set to **Active**.

The system enables you to maintain the Medicare benefits (such as, Part A, Part B, Part D, Part D LIS, and Part D LEP) of a member person through the **Benefit** screen. The system enables you to define and edit the Medicare benefits from the user interface, through a health care inbound message, or through the membership repricing inbound web service. While defining a Medicare benefit of a member person for Part A, Part B, and Part D, you need to specify a Medicare plan benefit package (i.e. 800 series plan) which is applicable for the Medicare benefit. The system enables you to define and edit a Medicare plan benefit package through the **Field Mapping** screen. You can use the Medicare plan benefit package as a pricing parameter in the age based or tier based pricing rules using which the Medicare premium is calculated. While defining a Medicare benefit of a member person for Part D LIS and Part D LEP, you need to specify the benefit amount (i.e. subsidy or penalty amount).

While editing a Medicare benefit of a member person from the user interface, you can only edit the characteristics of the Medicare benefit. However, while editing a Medicare benefit of a member person through a health care inbound message or through the membership repricing inbound web service, you can edit the end date, benefit amount, and characteristics of the Medicare benefit. On editing a Medicare benefit, the system inactivates the old record and creates a new record in the system. The status of the old benefit record is set to **Inactive** and the status of the new benefit record is set to **Active**.

The system enables you to discard an active or inactive Medicare benefit from the user interface by clicking the **Discard** button. You can also discard an active or inactive Medicare benefit through a health care inbound message or through the membership repricing inbound web service by changing its status to **Discarded**.

The system requires the following information to create charges for a Medicare membership:

- Whom to bill the Medicare membership (i.e. billing arrangement details)

- Age based or tier based pricing rules using which the premium should be calculated for the Medicare Part A, Part B, and Part D.
- Respective age based, tier based, and benefit pricing rule types associated with the respective policy plan

The system supports the following billing arrangements for a Medicare membership:

- **Group Billing** – Here, a Medicare benefit is billed to a bill group which is derived for the Medicare membership.
- **Direct Billing** – Here, a Medicare benefit is billed to a member person who is financially responsible for the Medicare membership.

You can indicate the billing arrangement for the Medicare memberships by defining a characteristic on the policy plan, policy, or parent customer. The system searches for the characteristic which is specified in the **Benefit Billing Arrangement** option type of the **C1-ASOBLLNG** feature configuration on the following entities in the specified sequence:

1. Policy Plan
2. Policy
3. Parent Customer

Note: If the benefit billing arrangement characteristic is not defined for any of the above listed entities, the system, by default, charges the Medicare membership premium to the bill group.

The system requires the bill group and its account to bill the Medicare memberships when the benefit billing arrangement is set to **Group Billing**. You can create a bill group and its account from the user interface or through a health care inbound message. On creating an account for a bill group, the system automatically creates a contract on the account using distinct contract types for all policy plans of the parent customer and bill group policies. While creating a contract, the system considers all price items in all pricing rule types (including the related pricing rule types) which are associated with the policy plans of the parent customer and bill group policies.

The system requires the member person's account to bill the Medicare membership when the benefit billing arrangement is set to **Direct Billing**. You can create an account for a member person who is financially responsible for the Medicare membership through a health care inbound message. On creating an account for a member person, the system automatically creates a contract on the account using distinct contract types for the respective policy plan. While creating a contract, the system considers all price items in all pricing rule types (including the related pricing rule types) which are associated with the respective policy plan.

COBRA Membership

Oracle Revenue Management and Billing enables you to maintain a COBRA membership and charge age based or tier based premium and administration fee for the COBRA membership. In COBRA membership, an employer provides temporary continuation of group health coverage in certain situations where it would otherwise be terminated. This may include situations, such as:

- Death of the covered employee
- Reduction in the hours or termination of the covered employee's employment
- Covered employee becoming entitled for Medicare
- Divorce or legal separation from the covered employee
- A dependent child ceasing to be a dependent in an active employee coverage membership

The system enables you to create and edit a COBRA membership from the user interface, through a health care inbound message, or through the membership repricing inbound web service. While creating a COBRA membership, you must set the membership type to **COBRA**. Ideally, you must define a COBRA membership on a Commercial policy plan. However, at present, the system does not validate whether a COBRA membership is defined only on a Commercial policy plan and not on a Medicare Affiliated policy plan.

Through a health care inbound message, the system must receive the end date of the active employee coverage membership along with the details of the COBRA membership. You can create a COBRA membership when you specify the main subscriber of the membership. Here, the main subscriber can be an employee or member of the organization or a family member who is covered through the COBRA membership. In a COBRA membership, you need to specify

the member person who is financially responsible for the COBRA membership. Note that, at a time, only one member person can be financially responsible for the COBRA membership.

On creating a COBRA membership, the status of the membership and main subscriber is set to **Active**. On adding a dependent person to a membership, the status of the dependent person is set to **Active**. You can inactivate a COBRA membership from the user interface, through a health care inbound message, or through the membership repricing inbound web service. There are two ways in which you can inactivate the membership from the user interface:

- On clicking the **Inactivate** button
- On inactivating the main subscriber of the membership

However, through a health care inbound message or through the membership repricing inbound web service, you can inactivate the membership only by inactivating the main subscriber of the membership. On inactivating the main subscriber of a COBRA membership, the system automatically inactivates the membership and all other member persons which are included in the membership. The status of the COBRA membership, main subscriber, and other member persons (if any) is set to **Inactive**. In addition, the system does the following:

- Cancels the billable charges which are created for the membership
- Cancels the corresponding bill segments (if any)

If an audit event exists for the membership which is inactivated, the **BO_STATUS_CD** column corresponding to the record in the **C1_AUDIT_EVENT**, **C1_AUDIT_EVENT_LOG**, and **CI_PRCE_CALC** tables is set to **INVALID**. If a repricing entity detail record exists for the membership in the **PENDING** or **ERROR** status, then the **BO_STATUS_CD** column corresponding to the record in the **CI_REPRC_ENTITY_DTL** table is set to **COMPLETE**. If a repricing request exists for the membership in the **PENDING** or **ERROR** status, then the **BO_STATUS_CD** column corresponding to the record in the **CI_REPRC_REQ_DTL** table is set to **COMPLETE**.

You can also inactivate a member person, who is not the main subscriber of a COBRA membership, from the user interface, through a health care inbound message, or through the membership repricing inbound web service. On inactivating a member person, the status of the member person is set to **Inactive**.

On terminating a fully-insured group policy, the status of all COBRA memberships on the respective policy plans is set to **Terminated**. Similarly, on reinstating a fully-insured group policy, the status of all COBRA memberships on the respective policy plans is set to **Active**.

The system requires the following information to create charges for a COBRA membership:

- Whom to bill the COBRA membership (i.e. billing arrangement details)
- Age based or tier based pricing rules using which the premium should be calculated for the COBRA membership
- Respective age based or tier based pricing rule type associated with the respective policy plan
- Additional charge pricing rule using which the administration fee should be calculated for the COBRA membership
- Respective additional charge pricing rule type associated with the respective policy plan

The system supports the following billing arrangements for a COBRA membership:

- **Group Billing** – Here, a COBRA membership is billed to a bill group which is derived for the COBRA membership.
- **TPA Billing** – Here, a COBRA membership is billed to the third party administrator (i.e. TPA person).
- **Direct Billing** – Here, a COBRA membership is billed to the member who is financially responsible for the COBRA membership.

You can indicate the billing arrangement for the COBRA memberships by defining a characteristic on the policy plan, policy, or parent customer. The system searches for the characteristic which is specified in the **Cobra Billing Arrangement** option type of the **C1-ASOBLLNG** feature configuration on the following entities in the specified sequence:

1. Policy Plan
2. Policy

3. Parent Customer

Note: If the Cobra billing arrangement characteristic is not defined for any of the above listed entities, the system, by default, charges the COBRA membership premium to the bill group.

The system requires the bill group and its account to bill the COBRA memberships when the COBRA billing arrangement is set to **Group Billing**. You can create a bill group and its account from the user interface or through a health care inbound message. On creating an account for a bill group, the system automatically creates a contract on the account using distinct contract types for all policy plans of the parent customer and bill group policies. While creating a contract, the system considers all price items in all pricing rule types (including the related pricing rule types) which are associated with the policy plans of the parent customer and bill group policies.

The system requires the third party administrator (i.e. TPA person) and its account to bill the COBRA memberships when the COBRA billing arrangement is set to **TPA Billing**. You can create a third party administrator (i.e. TPA person) and its accounts through a health care inbound message. While sending the details of a TPA person through an inbound message, you must specify the parent of the TPA person and its account details. The system associates the parent customer with the TPA person using the relationship type which is specified in the **TPA Person Relationship Type** option type of the **C1-ASOBLLNG** feature configuration. If the person type specified in the health care inbound message matches the person type specified in the **TPA Person Type** option type of the **C1-PERSTYPE** feature configuration, the system creates or updates the TPA person and its account through a customer registration object. However, if the person type specified in the health care inbound message does not match the person type specified in the **TPA Person Type** option type of the **C1-PERSTYPE** feature configuration, the system creates or updates the TPA person and its accounts directly and not through a customer registration object.

The system associates the TPA person with the TPA account using the relationship type which is specified in the **TPA Account Relationship Type** option type of the **C1-ASOBLLNG** feature configuration. On creating an account for a TPA person, the system automatically creates a contract on the account using distinct contract types for all policy plans of the parent customer and bill group policies. While creating a contract, the system considers all price items in all pricing rule types (including the related pricing rule types) which are associated with the policy plans of the parent customer and bill group policies.

The system requires the member person's account to bill the COBRA membership when the COBRA billing arrangement is set to **Direct Billing**. You can create an account for a member person who is financially responsible for the COBRA membership through a health care inbound message. On creating an account for a member person, the system automatically creates a contract on the account using distinct contract types for the respective policy plan. While creating a contract, the system considers all price items in all pricing rule types (including the related pricing rule types) which are associated with the respective policy plan.

Retiree Membership

An employer may offer a retirement health plan coverage to its retired employees through a fully-insured group policy or an individual can independently opt for a government sponsored retirement health plan coverage. Oracle Revenue Management and Billing enables you to maintain a retiree membership for both the fully-insured group and individual business. The system enables you to maintain a flat or percentage based contribution of employer or sponsor for a retiree membership.

The system enables you to create and edit a retiree membership through a health care inbound message or through membership repricing inbound web service. While creating a retiree membership, the membership type must be set to **Retiree**. The system requires the following information to create charges for a retiree membership:

- Whom to bill the premium for the retiree membership (i.e. retiree billing arrangement details)
- Whom to bill the employer or sponsor contribution (i.e. sponsor billing arrangement details)
- Age based or tier based pricing rule using which the premium should be calculated for the retiree membership
- Discount charge pricing rule using which the employer or sponsor contribution should be calculated for the retiree membership

In case of the fully-insured individual business, the premium for a retiree membership is billed to the member who is financially responsible for the retiree membership. However, in case of the fully-insured group business, the system supports the following billing arrangements for the retiree membership:

- **Group Billing** – Here, the premium is billed to a bill group which is derived for the retiree membership.
- **TPA Billing** – Here, the premium is billed to the third party administrator (i.e. TPA person).
- **Direct Billing** – Here, the premium is billed to the member who is financially responsible for the retiree membership.

You can indicate the billing arrangement for a retiree membership in the fully-insured group business by defining a characteristic on the policy plan, policy, or parent customer. The system searches for the characteristic which is specified in the **Retiree Billing Arrangement** option type of the **C1-ASOBLNG** feature configuration on the following entities in the specified sequence:

1. Policy Plan
2. Policy
3. Parent Customer

The system enables you to maintain a flat or percentage based contribution of employer or sponsor through a discount charge pricing rule. A field named **Sponsored** is available in the **Price Items** section while defining or editing a discount charge pricing rule type. If the **Sponsored** option is selected for a price item, the system creates and bills the charge for the price item as per the sponsor billing arrangement. The system searches for the characteristic which is specified in the **Sponsors Billing Arrangement** option type of the **C1-ASOBLNG** feature configuration on the following entities in the specified sequence:

1. Policy Plan
2. Policy
3. Parent Customer

In the fully-insured group and individual business, the system supports the following sponsor billing arrangements for the retiree membership:

- **Group Billing** – Here, the system creates a negative charge for the employer or sponsor contribution against the beneficiary account and a positive charge for the employer or sponsor contribution against the sponsor account.
- **TPA Billing** – Here, the system creates a negative charge for the employer or sponsor contribution against the beneficiary account and a positive charge for the employer or sponsor contribution against the sponsor account.
- **Direct Billing** – Here, the system creates a memo only charge for the employer or sponsor contribution against the beneficiary account. A bill message code is derived from the **Retiree Bill Message Code** option type of the **C1-ASOBLNG** feature configuration and stamped against the beneficiary account.

In case of the group and TPA billing, the system derives the characteristic types which are specified in the **Sponsor Account Identifier Type Char Type** and **Sponsor Account Identifier Value Char Type** option types of the **C1-ASOBLNG** feature configuration. The system then checks whether these characteristics are defined on any of the following entity in the specified sequence:

1. Policy Plan
2. Policy
3. Parent Customer

If these characteristics are defined on any of the above entity, the system derives the sponsor account for the bill group. The system then bills the employer or sponsor contribution charges to the sponsor account.

However, if the **Sponsored** option is not selected for a price item in a discount charge pricing rule type, the system creates and bills the charge for the price item as per the retiree billing arrangement.

Algorithms Used in C1-POLICY

The following table lists the algorithms which are attached to the **C1-POLICY** business object:

System Event	Algorithm	Algorithm Type	Description
Audit	C1- REAUDEVNT	C1-REAUDEVNT	Refer to C1-REAUDEVNT on page 292.
Validation	C1- POLBOVAL	C1-POLBOVAL	Refer to C1-POLBOVAL on page 293.

The following table lists the algorithms which are used in the lifecycle of the **C1-POLICY** business object:

Status	System Event	Algorithm	Algorithm Type	Description
Pending	Monitor	C1-TRNDFLSYS	C1-TRNDFLSYS	Refer to C1-TRNDFLSYS on page 294.
Activate	Monitor	F1-AT-RQJ	F1-GEN-BOMNJ	Refer to F1-AT-RQJ on page 1567.
In Force/ Active	Enter	C1-EVCSTSTAT	C1-EVCSTSTAT	Refer to C1-EVCSTSTAT on page 294.
Pending Termination	Enter	C1-PLCYTRMRQ	C1-PLCYTRMRQ	Refer to C1-PLCYTRMRQ on page 294.
Terminated	Enter	C1-POLCYTERM	C1-POLCYTERM	Refer to C1-POLCYTERM on page 295.
	Enter	C1-DELTRMLTR	C1-CRTCUSCNT	Refer to C1-DELTRMLTR on page 295.
	Enter	C1-EVCSTSTAT	C1-EVCSTSTAT	Refer to C1-EVCSTSTAT on page 294.
Pending Reinstatement	Enter	C1-PLCYREIRQ	C1-PLCYREIRQ	Refer to C1-PLCYREIRQ on page 296.
Reinstated	Monitor	F1-AT-RQJ	F1-GEN-BOMNJ	Refer to F1-AT-RQJ on page 1567.
	Enter	C1-POLCYREIN	C1-POLCYREIN	Refer to C1-POLCYREIN on page 296.
	Enter	C1-CCPOLREI	C1-CRTCUSCNT	Refer to C1-CCPOLREI on page 297.
Renewed	Monitor	F1-AT-RQJ	F1-GEN-BOMNJ	Refer to F1-AT-RQJ on page 1567.
Pending Cancellation	-	-	-	-
Canceled	-	-	-	-

C1-REAUDEVNT

If this algorithm is attached to the **Audit** system event of a business object, it is invoked whenever you define, edit, or delete the respective entity. It checks whether an active audit event type exists for the entity business object. If so, it considers the active audit event type and creates the audit event using the respective audit event type. The system creates the audit event while:

- Defining an entity when the **Add Action** option is selected in the audit event type.
- Editing an entity when the **Update All** option is selected in the audit event type or when the updated element is listed in the **Audit Elements for Entity Update** section.

- Deleting an entity when the **Delete Action** option is selected in the audit event type.

The entity type and entity ID for which an audit event is created are added corresponding to the audit event in the **C1_AUDIT_EVENT** table. In addition, the effective date is stamped corresponding to the audit event in the **C1_AUDIT_EVENT** table. Note that if the entity has a start date, then the effective date is set to the entity's start date. But, if the entity does not have a start date, then the effective date is set to the system date.

Note: Before creating an audit event, the system checks whether an audit event for the entity ID with the same effective date already exists in the **Pending** or **Error** status for the respective action. If so, the system does not create a new audit event for the entity. Instead, the system adds a new log entry in the existing audit event

At present, this algorithm is designed to work with the business objects of the following maintenance objects:

- C1-POLICY
- C1-ASOPolicy
- C1-Membership
- C1-PolicyPlan
- C1_PERSON_BO
- C1-PricingRuleTierBased
- C1-PricingRuleAgeBased

In case, you want to create audit event for any other maintenance objects, you need to create a custom algorithm type.

It contains the following parameters:

- **Audit Event Business Object** – Used to specify the business object using which you want to create the audit event.
- **Audit Event Pending Status** – Used to specify the status in which you want to create the audit event. This parameter is also used for determining whether an audit event for the entity ID already exists in the system.
- **Audit Event Error Status** – Used to specify the status in which an audit event is transitioned when an error occurs while processing the audit event. This parameter is used for determining whether an audit event for the entity ID already exists in the system.

All the above parameters are mandatory.

C1-POLBOVAL

This algorithm validates a fully-insured group policy throughout its lifecycle. It checks the following:

- Whether the policy end date is not earlier than the policy start date.
- Whether the policy person end date is not earlier than the policy person start date.
- Whether the policy person start date is not earlier than the policy start date or later than policy end date.
- Whether the policy person end date is not earlier than the policy start date or later than policy end date.

Note: The above validation is done when the policy is transition to the status which is not specified in the **Skip Status for Policy Person End Date Validation** parameter. For example, if you set the **Skip Status for Policy Person End Date Validation** parameter to **TERMINATED**, the system will not perform the above validation when the status of the policy is changed to **Terminated**.

- Whether the person who is the main customer is associated with the policy.
- Whether the policy person role is specified while associating a person with the policy.

It contains the following parameter:

- **Skip Status for Policy Person End Date Validation** – Used to specify the policy status in which you do not want to validate the policy person end date. You can specify comma-separated values for this parameter.

C1-TRNDFLSYS

This algorithm checks whether the fully-insured group policy is created from the user interface or through an inbound message. If a fully-insured group policy is created through an inbound message, the system will automatically transition the fully-insured group policy to the default next status specified in its lifecycle.

F1-AT-RQJ

This algorithm transitions the current status of the business object to the specified status. It contains the following parameters:

- **Next Status** – Used when you want to override the default next status specified in the lifecycle.
- **Next Transition Condition** – Used when you want to override the default next transition condition specified in the lifecycle.

Note: At a time, you can specify value for either the **Next Status** or **Next Transition Condition** parameter. If you don't specify any value for these parameters, the system will transition the business object to the default next status specified in its lifecycle.

C1-EVCSTSTAT

This algorithm updates the **Customer Status** characteristic of the main customer of the policy. This characteristic indicates whether the customer is active or inactive. If the customer owns at least one active policy, the customer status is set to **Active**. However, if the customer does not own any active policy, the customer status is set to **Inactive**.

It is invoked while activating or terminating a fully-insured group policy. It contains the following parameters:

- **Customer Status Characteristic Type** – Used to specify the characteristic type whose value should be updated whenever the policy is activated or terminated. You must specify a characteristic type where the characteristic entity is set to **Person**.
- **Active Customer Status Characteristic Value** – Used to specify the characteristic value which should be used when the main customer owns at least one active policy.
- **Inactive Customer Status Characteristic Value** – Used to specify the characteristic value which should be used when the main customer does not own any active policy (in other words, when all policies of the main customer are terminated).
- **Policy Active Status** – Used to specify the status in which at least one policy should exist to indicate that the main customer is active.

All the above parameters are mandatory.

C1-PLCYTRMRQ

This algorithm creates an outbound message using the outbound message type whenever you initiate the policy termination process from the user interface. While creating the outbound message, the system identifies the account using the characteristic type specified in the **Main Customer Characteristic Type** parameter. The system checks whether this characteristic type is set to the main customer's ID on any account. If so, the system considers the account and then fetches the value of the account identifier type specified in the **Account Identifier Type** parameter.

In addition, it stores the details of the outbound message (which is created) in the log of the policy. It contains the following parameters:

- **Outbound Message Type** – Used to specify the outbound message type using which you want to create the outbound message. You must specify an outbound message type which is already defined in the system.
- **Source System** – Used to specify the source system that you want to use in the outbound message. You must specify a source system which is already defined in the **C1-SourceSystemLookup** extendable lookup.

- **Account Identifier Type** – Used to specify the account identifier type whose value you want to use in the outbound message. You must specify an account identifier type which is already defined in the system.
- **Main Customer Characteristic Type** – Used to specify the characteristic type using which you want to identify the account of the main customer. You must specify a characteristic type where the characteristic entity is set to **Person**.

All the above parameters are mandatory.

C1-POLCYTERM

This algorithm sets the end date of the following entities to the termination date when the respective condition is met:

- Policy (when the termination date is not earlier than the policy start date or later than the policy end date)
- Policy Person (when the termination date falls within the date range in which the person is associated with the policy)
- Policy Plan (when the termination date falls within the date range of the policy plan)
- Membership (when the termination date falls within the date range of the membership)
- Member Person (when the termination date falls within the date range in which the person is added to the membership)
- Contracts Associated with the Membership (when the termination date falls within the date range of the contract)

It contains the following parameters:

- **Membership Old Status** – Used to specify the status from which you want to transition the membership when the policy is terminated.
- **Membership New Status** – Used to specify the status to which you want to transition the membership when the policy is terminated.

C1-DELTRMLTR

This algorithm creates a customer contact whenever the policy is transition to the status where it is attached. For example, if this algorithm is attached to the **TERMINATED** status, it creates a customer contact whenever the policy is terminated. You can create a customer contact while terminating a policy. Optionally, you can configure the algorithm such that a customer contact is created when a particular status reason is specified while terminating a policy.

Once a customer contact is created, the policy for which the customer contact is created is stored as a characteristic on the customer contact. In addition, the customer contact which is created for the policy is stored as a characteristic in the log of the policy.

It contains the following parameters:

- **Check Policy Status Reason** – Used when you want to create a customer contact when the policy is terminated for a particular reason. The valid values are:
 - **Y** – Used to indicate that the system should create a customer contact when a particular status reason is specified while terminating a policy.
 - **N** – Used to indicate that the system should create a customer contact while terminating a policy irrespective of the status reason.
- **Policy Status Reason Codes** – Used to specify the status reason defined for the **TERMINATED** status. You can specify comma-separated values for this parameter.
- **Customer Contact Class** – Used to specify the customer contact class using which you want to create the customer contact. This field is mandatory.
- **Customer Contact Type** – Used to specify the customer contact type using which you want to create the customer contact. This field is mandatory.

- **Consolidate Customer Contact** – Used to indicate whether the system should update the existing customer contact or create a new customer contact for the main customer of the policy. The valid values are:
 - **Y** – If this parameter is set to **Y**, the system checks whether a customer contact is already created for the main customer of the policy on the system date. If so, the system does not create a new customer contact. Instead, it updates the existing customer contact of the main customer of the policy. However, if the customer contact is not already created on the system date, the system creates a new customer contact for the main customer of the policy.
 - **N** – If this parameter is set to **N**, the system creates a new customer contact for the main customer of the policy and does not update the existing customer contact, if any.

Note: If you do not specify the value for this parameter, by default, it is set to **N**.

- **Policy ID Characteristic Type** – Used to specify the characteristic type which you want to define for the customer contact. This characteristic indicates the policy for which the customer contact is created. You must specify a characteristic type where the characteristic entity is set to **Customer Contact**. This field is mandatory.
- **Customer Contact Characteristic Type** – Used to specify the characteristic type which you want to use in the log of the policy. This characteristic indicates the customer contact which is created for the policy. You must specify a characteristic type where the characteristic entity is set to **Policy**. This field is mandatory.
- **Status To Skip Process** – Used when you do not want to create the customer contact when the policy is transition to a particular status. You can specify comma-separated values for this parameter.

C1-PLCYREIRQ

This algorithm creates an outbound message using the outbound message type whenever you initiate the policy reinstatement process from the user interface. In addition, it stores the details of the outbound message (which is created) in the log of the policy.

It contains the following parameters:

- **Outbound Message Type** – Used to specify the outbound message type using which you want to create the outbound message. You must specify an outbound message type which is already defined in the system.
- **Source System** – Used to specify the source system that you want to use in the outbound message. You must specify a source system which is already defined in the **C1-SourceSystemLookup** extendable lookup.

All the above parameters are mandatory.

C1-POLCYREIN

This algorithm updates the end date of the following entities to the respective original end date:

- Policy
- Policy Person
- Policy Plan
- Membership
- Member Person
- Contracts Associated with the Membership

Note: The system stores the original end date of the above listed entities when you define or edit a policy, policy plan, or membership.

Here, the assumption is that the pass-through billable charges information for the membership will be sent again through an inbound message along with the reinstatement reason. And, therefore the exiting billable charges will not be extended.

It contains the following parameters:

- **Membership Old Status** – Used to specify the status from which you want to transition the membership when the policy is reinstated.
- **Membership New Status** - Used to specify the status to which you want to transition the membership when the policy is reinstated. This field is mandatory.

C1-CCPOLRE1

This algorithm creates a customer contact whenever the policy is transition to the status where it is attached. For example, if this algorithm is attached to the **REINSTATE** status, it creates a customer contact whenever the policy is reinstated. You can create a customer contact while reinstating a policy. Optionally, you can configure the algorithm such that a customer contact is created when a particular status reason is specified while reinstating a policy.

Once a customer contact is created, the policy for which the customer contact is created is stored as a characteristic on the customer contact. In addition, the customer contact which is created for the policy is stored as a characteristic in the log of the policy.

It contains the following parameters:

- **Check Policy Status Reason** – Used when you want to create a customer contact when the policy is reinstated for a particular reason. The valid values are:
 - **Y** – Used to indicate that the system should create a customer contact when a particular status reason is specified while reinstating a policy.
 - **N** – Used to indicate that the system should create a customer contact while reinstating a policy irrespective of the status reason.
- **Policy Status Reason Codes** – Used to specify the status reason defined for the **REINSTATE** status. You can specify comma-separated values for this parameter.
- **Customer Contact Class** – Used to specify the customer contact class using which you want to create the customer contact. This field is mandatory.
- **Customer Contact Type** – Used to specify the customer contact type using which you want to create the customer contact. This field is mandatory.
- **Consolidate Customer Contact** – Used to indicate whether the system should update the existing customer contact or create a new customer contact for the main customer of the policy. The valid values are:
 - **Y** – If this parameter is set to **Y**, the system checks whether a customer contact is already created for the main customer of the policy on the system date. If so, the system does not create a new customer contact. Instead, it updates the existing customer contact of the main customer of the policy. However, if the customer contact is not already created on the system date, the system creates a new customer contact for the main customer of the policy.
 - **N** – If this parameter is set to **N**, the system creates a new customer contact for the main customer of the policy and does not update the existing customer contact, if any.

Note: If you do not specify the value for this parameter, by default, it is set to **N**.

- **Policy ID Characteristic Type** – Used to specify the characteristic type which you want to define for the customer contact. This characteristic indicates the policy for which the customer contact is created. You must specify a characteristic type where the characteristic entity is set to **Customer Contact**. This field is mandatory.
- **Customer Contact Characteristic Type** – Used to specify the characteristic type which you want to use in the log of the policy. This characteristic indicates the customer contact which is created for the policy. You must specify a characteristic type where the characteristic entity is set to **Policy**. This field is mandatory.
- **Status To Skip Process** – Used when you do not want to create the customer contact when the policy is transition to a particular status. You can specify comma-separated values for this parameter.

Algorithms Used in C1-PolicyPlan

The following table lists the algorithms which are attached to the **C1-PolicyPlan** business object:

System Event	Algorithm	Algorithm Type	Description
Audit	C1-PPCONCRE	C1-PPCONCRE	Refer to C1-PPCONCRE on page 298.
Validation	C1-VALPPBO	C1-VALPPBO	Refer to C1-VALPPBO on page 298.

C1-PPCONCRE

This algorithm is invoked when you create or edit a policy plan from the user interface or through an inbound message. It creates a contract in either of the following ways:

- If a price item is associated with the policy plan, it creates a contract using the contract type which is associated with the price item.
- If a pricing rule type is associated with the policy plan and the pricing rule type contains one or more price items, it creates a contract using a distinct contract type which is associated with each price item.

Let us assume that PRT1 is associated with the policy plan and it contains three price items – P1, P2, and P3. Now, if the P1 is associated with the CT1 contract type, P2 is associated with the CT2 contract type, and P3 is associated with the CT3 contract type, the system will create three contracts - C1 using CT1, C2 using CT2, and C3 using CT3. However, if the P1 and P3 are associated with the CT1 contract type and P2 is associated with the CT2 contract type, the system will create two distinct contracts - C1 using CT1 and C2 using CT2.

If multiple pricing rule types are associated with the policy plan and each pricing rule type contains multiple price items, it creates a contract using a distinct contract type which is associated with each price item on each pricing rule type.

If a policy plan belongs to a policy of the parent customer (where a bill group is not associated), the system will create one contract using each contract type on each account of the parent customer and bill groups. If a policy plan belongs to a policy of a bill group (where the parent customer is the policy holder), the system will create one contract using each contract type on each account of the parent customer and the bill group.

The status of each contract is set to **Active**. The contract start date is set to the start date of the respective plan. If the same contract type is associated with the same or different price items on the same or different pricing rule types of different plans, the contract start date is set to the start date of the earliest plan. The default rate schedule specified on the respective contract type is added to the contract in the rate information and its effective date is set to the contract start date.

Note:

The system creates a contract using a contract type for an account when the division to which the account and contract type belongs is same.

If a contract of a contract type is already present on the account, the system will not create a new contract. Instead, it will update the start date of the existing contract, if required.

If the same contract type is associated with the same or different price items on the same or different pricing rule types of different plans on different policies, the contract start date is set to the start date of the earliest plan across policies.

C1-VALPPBO

This algorithm validates a policy plan. It checks the following:

- Whether the policy plan end date is not earlier than the policy plan start date.
- Whether the policy plan start date is not earlier than the policy start date or later than policy end date.

- Whether the policy plan end date is not earlier than the policy start date or later than policy end date.
- Whether the price item or at least one pricing rule type is associated with the policy plan.

Algorithms Used in C1-Membership

The following table lists the algorithms which are attached to the **C1-Membership** business object:

System Event	Algorithm	Algorithm Type	Description
Audit	C1-FIAUDEV	C1-FIAUDEV	Refer to C1-FIAUDEV on page 145.
Post-Processing	C1-RTAREAMEM	C1-RTAREAMEM	C1-RTAREAMEM on page 300
Post-Processing	C1-MEMRLSUBT	C1-MEMRLSUBT	C1-MEMRLSUBT
Post-Processing	C1-MPCONCREA	C1-MPCONCREA	C1-MPCONCREA on page 301
Pre-Processing	C1-MEMSTPRE	C1-MEMSTPRE	Refer to C1-MEMSTPRE on page 301.
Validation	C1-VALMEMBO	C1-VALMEMBO	Refer to C1-VALMEMBO on page 301.

The following table lists the algorithms which are used in the lifecycle of the **C1-Membership** business object:

Status	System Event	Algorithm	Algorithm Type	Description
Active	-	-	-	-
Inactive	Enter	C1-MEMINACT	C1-MEMINACT	Refer to C1-MEMINACT on page 302.
Terminated	-	-	-	-

C1-FIAUDEV

If this algorithm is attached to the **Audit** system event of the **C1-Membership**, **C1-Benefits**, and **C1_PERSON_BO** business objects, it is invoked whenever you define, edit, or delete the respective entity. It checks whether an active audit event type exists for the entity business object. If so, it considers the active audit event type and creates the audit event using the respective audit event type. The system creates the audit event whenever a membership is added to a policy plan, member person is added to a membership, and a Medicare benefit is defined for a member person. It also creates the audit event whenever the membership, member person, and Medicare benefit details are updated. However, note that the audit events are created in the update scenario when the element listed for auditing in the age based, tier based, or benefit pricing rule type is updated. The system considers only those pricing rule types whose pricing rules are effective during the respective entity (i.e. membership, member person, or Medicare benefit whichever is updated) date range.

It creates one or more audit events in the **Pending** status. The entity type and entity ID for which an audit event is created are added corresponding to the audit event in the **C1_AUDIT_EVENT** table. In addition, the effective date is stamped corresponding to the audit event in the **C1_AUDIT_EVENT** table.

Note:

The system creates an audit event whenever the membership start and end dates and member person's start and end dates are changed in the system irrespective of whether these fields are listed for auditing or not in the age based or tier based pricing rule types.

Before creating an audit event, the system checks whether an audit event for the entity ID with the same effective date already exists in the **Pending** or **Error** status for the respective action. If so, the system does not create a new audit event for the entity. Instead, the system adds a new log entry in the existing audit event.

For each audit event, this algorithm derives the memberships on the policy plans which are impacted and the pricing rule types whose pricing rules are defined on the respective policy plans. A repricing entity detail record is then created

for each membership, pricing rule type, and effective date combination in the **CI_REPRC_ENTITY_DTL** table. The status of the repricing entity detail record is set to **P**. Once the repricing entity detail records are created successfully, the status of the audit event is changed to **Complete**.

It contains the following parameters:

- **Audit Event Business Object** – Used to specify the business object using which you want to create the audit event.
- **Audit Event Pending Status** – Used to specify the status in which you want to create the audit event. This parameter is also used for determining whether an audit event for the entity ID already exists in the system.
- **Audit Event Error Status** – Used to specify the status in which an audit event is transitioned when an error occurs while processing the audit event. This parameter is used for determining whether an audit event for the entity ID already exists in the system.

All the above parameters are mandatory.

Related Topics

For more information on...	See...
How the audit events are created and processed for an age based or tier based pricing rule	Age Based and Tier Based Pricing Rules Audit Process on page 3116
How the audit events are created and processed for a membership	Membership Audit Process on page 3117
How the audit events are created and processed for a person	Person Audit Process on page 3123
How the audit events are created and processed for a Medicare benefit	Medicare Benefit Audit Process

C1-RTAREAMEM

This algorithm derives the geographic rating area for a membership using the **Address Source** and **Address Type** characteristic types. It supports two address sources named **Policy Holder** and **Main Subscriber** and three address types named **Person Mailing**, **Person Seasonal**, and **Account Override**.

On adding a membership to a policy plan, this algorithm derives the characteristic types from the **Address Source Characteristic Type** and **Address Type Characteristic Type** attributes of a geographic rating area preference. This algorithm considers the geographic rating area preference which is specified in the **Rating Area Field Mapping for Group** option type of the **C1-ASOBLNG** feature configuration. Then, it searches for these characteristics on the following entities in the specified sequence:

1. Policy Plan
2. State where the Policy Plan is Issued
3. Policy
4. State where the Policy is Issued

If these characteristics are not defined for any of the above listed entities, this algorithm derives the default address source and address type from the geographic rating area preference. If the address source is set to **Policy Holder**, this algorithm fetches the value from the **Parent Customer Policy Person Role** option type of the **C1-ASOBLNG** feature configuration. It then derives the person who is associated with the policy using the parent customer policy person role. Once the address source and address type are derived, this algorithm fetches the state and zip code from the address type of the address source. For example, if the address source is set to **Policy Holder** and address type is set to **Person Mailing**, this algorithm fetches the state and zip code from the policy holder's mailing address. Once the state and zip code are fetched from the address, this algorithm checks whether the zip code is a 9-digit code. If not, it appends zeros to make it a 9-digit zip code. It then derives the value of the **Use Plan Details** attribute from the geographic rating area preference. If the attribute is set to **Y**, this algorithm derives a geographic rating area for the state, zip code, policy number, plan number, and source system combination. However, if the attribute is set to **N**, this algorithm derives a geographic rating area for the state and zip code combination. If the geographic rating area is not derived for the specified combination, this algorithm derives the default geographic rating area from the geographic

rating area preference. Once the geographic rating area is derived, this algorithm stores the geographic rating area for the membership. The characteristic type specified in the **Geographic Rating Area Characteristic Type** attribute of the geographic rating area preference is used to store geographic rating area for the membership. The effective date of the characteristic is set to effective date of the address.

C1-MPCONCREA

This algorithm is invoked when the following conditions are met:

- A member person who is financially responsible for the membership is added to the membership
- One or more accounts already exist for the member person in the system

If the above conditions are met, this algorithm derives the membership in which the member person is added. It then derives the policy plan to which the membership belongs. It creates contracts for each account of the member person in either of the following ways:

- If a price item is associated with the policy plan, it creates a contract using the contract type which is associated with the price item.
- If a pricing rule type is associated with the policy plan and the pricing rule type contains one or more price items, it creates a contract using a distinct contract type which is associated with each price item.

Let us assume that PRT1 is associated with the policy plan and it contains three price items – PI1, PI2, and PI3. Now, if the PI1 is associated with the CT1 contract type, PI2 is associated with the CT2 contract type, and PI3 is associated with the CT3 contract type, this algorithm will create three contracts - C1 using CT1, C2 using CT2, and C3 using CT3. However, if the PI1 and PI3 are associated with the CT1 contract type and PI2 is associated with the CT2 contract type, this algorithm will create two distinct contracts - C1 using CT1 and C2 using CT2.

If multiple pricing rule types are associated with the policy plan and each pricing rule type contains multiple price items, it creates a contract using a distinct contract type which is associated with each price item on each pricing rule type.

The status of each contract is set to **Active**. The contract start date is set to the start date of the respective plan. The default rate schedule specified on the respective contract type is added to the contract in the rate information and its effective date is set to the contract start date.

Note:

The system creates a contract using a contract type for an account when the division to which the account and contract type belongs is same.

If a contract of a contract type is already present on the account, the system will not create a new contract. Instead, it will update the start date of the existing contract, if required.

C1-MEMSTPRE

Once the status of the main subscriber is changed to **Inactive**, this algorithm changes the status of the membership to the value specified in the **Membership Inactive Status** option type of the **C1-ASOBLNG** feature configuration. In addition, it does not allow you to add a member person in the **Inactive** status to a membership.

C1-VALMEMBO

This algorithm validates a membership. It checks the following:

- Whether the membership end date is not earlier than the membership start date.
- Whether the membership start date is not earlier than the policy plan start date or later than policy plan end date.
- Whether the membership end date is not earlier than the policy plan start date or later than policy plan end date.
- Whether the policy plan for which you want to define the membership is specified.

- Whether the person who is the main subscriber is added to the membership.
- Whether the relationship type is specified while adding a person to the membership.

C1-MEMINACT

This algorithm changes the status of the member person to the value specified in the **Membership Person Inactive Status** option type of the **C1-ASOBLLNG** feature configuration. It also does the following:

- Cancels the billable charges which are created for the membership
- Cancels the corresponding bill segments (if any)

If an audit event exists for the membership which is inactivated, the **BO_STATUS_CD** column corresponding to the record in the **C1_AUDIT_EVENT**, **C1_AUDIT_EVENT_LOG**, and **CI_PRCE_CALC** tables is set to **INVALID**. If a repricing entity detail record exists for the membership in the **PENDING** or **ERROR** status, then the **BO_STATUS_CD** column corresponding to the record in the **CI_REPRC_ENTITY_DTL** table is set to **COMPLETE**. If a repricing request exists for the membership in the **PENDING** or **ERROR** status, then the **BO_STATUS_CD** column corresponding to the record in the **CI_REPRC_REQ_DTL** table is set to **COMPLETE**.

Late Setup Notification

Oracle Revenue Management and Billing enables you to create a To Do notification when the details to include a member person in a group or individual membership is received in ORMB beyond the late setup threshold days from the member person start date. This notification can help the billing analyst to take appropriate actions, such as giving premium waiver to the member person if required.

To enable this feature, you need to set the following option types in the **C1-ASOBLLNG** feature configuration:

- **Monitor Late Setup** – Used to indicate whether you want to enable the late setup notification feature. The valid values are – **Y** and **N**. By default, the value is set to **N**.
- **Late Setup Threshold in Days** – Used to indicate the number of threshold days for late setup notification. This option type is required when the **Monitor Late Setup** option type is set to **Y**. The value must be greater than zero.

For example, if the system receives the information to add a member person with the start date as **01-15-2021** to an individual membership on **02-15-2021** and the late setup threshold days in the **C1-ASOBLLNG** feature configuration is set to **15**. In this case, the number of days between the member person start date and member person creation date is greater than late setup threshold days, and therefore a To Do is created using the To Do type which is specified in the **C1-LATESET** algorithm attached to the group or individual membership business object, respectively.

To implement this business requirement, the system stores the member person creation date (which was not done in the previous releases) while adding a member person to a group or individual membership. A new batch named **C1-LSUB** is introduced in this release. It derives the creation date for all member persons in the existing group and individual memberships and stamps it against the corresponding record in the **CRE_DTTM** column of the **CI_MEMBERSHIP_PER** table. This batch must be executed only once after upgrading to Oracle Revenue Management and Billing Version 3.1.0.0.0. For more information, refer to *Oracle Revenue Management and Billing Version 3.1.0.0.0 Upgrade Guide*.

Policy (Used for Searching)

The **Policy** screen allows you to search for a policy using various search criteria. It also allows you to define a policy. It contains the following zone:

- [Search Policy](#) on page 303

Through this screen, you can navigate to the following screen:

- [Policy \(Used for Viewing\)](#) on page 314

Search Policy

The **Search Policy** zone allows you to search for a policy using various search criteria. It contains the following two sections:

- **Search Criteria** - The **Search Criteria** section contains the following fields:

Field Name	Field Description	Mandatory (Yes or No)
Search By	Used to indicate whether you want to search for a policy using the policy or person details. The valid values are: <ul style="list-style-type: none"> • Policy Date/Policy Type/Status • Source System/Policy Number/Description • Person Name/Person Identifier • Policy Characteristics 	Yes
	Note: By default, the Policy Date/Policy Type/Status option is selected.	
Policy Type	Used to search policies which are created using a particular policy type.	No
	Note: This field appears when the Policy Date/Policy Type/Status option is selected from the Search By list.	
Start Date	Used to search policies which are effective from a particular date.	No
	Note: This field appears when the Policy Date/Policy Type/Status option is selected from the Search By list.	
Status	Used to search policies with a particular status. The valid values are: <ul style="list-style-type: none"> • In Force/Active • Canceled • Pending Cancellation • Pending • Pending Reinstatement • Pending Termination • Post Runout • Reinstated • Runout • Terminated 	No
	Note: This field appears when the Policy Date/Policy Type/Status option is selected from the Search By list.	

Field Name	Field Description	Mandatory (Yes or No)
End Date	Used to search policies which are effective till a particular date.	No
	Note: This field appears when the Policy Date/Policy Type/Status option is selected from the Search By list.	
Source System	Used to search policies which originated from a particular external system.	No
	Note: This field appears when the Source System/Policy Number/Description option is selected from the Search By list.	
Policy Number	Used to search a policy with a particular policy number.	No
	Note: This field appears when the Source System/Policy Number/Description option is selected from the Search By list.	
Description	Used to search policies with a particular description.	No
	Note: This field appears when the Source System/Policy Number/Description option is selected from the Search By list.	
Person Name	Used to search policies to which a particular person is associated.	No
	Note: This field appears when the Person Name/Person Identifier option is selected from the Search By list.	
Person Identifier Type	Used to indicate the person identifier type.	Yes (Conditional)
	Note: This field appears when the Person Name/Person Identifier option is selected from the Search By list.	Note: If you specify the person identifier as a search criteria, you have to select the person identifier type.
Person Identifier	Used to search policies to which a person is associated.	Yes (Conditional)
	Note: This field appears when the Person Name/Person Identifier option is selected from the Search By list.	Note: If you specify the person identifier type as a search criteria, you have to specify the person identifier.

Field Name	Field Description	Mandatory (Yes or No)
Characteristic Type	Used to search policies for which a particular characteristic type is defined.	Yes (Conditional)
	<p>Note:</p> <p>This field appears when the Policy Characteristics option is selected from the Search By list.</p> <p>The list includes only those characteristic types where the characteristic entity is set to Policy.</p>	<p>Note: This field is required when you are searching for a policy using a characteristic.</p>
Characteristic Value	Used to search policies with a particular characteristic value.	Yes (Conditional)
	<p>Note:</p> <p>This field appears when the characteristic type is selected.</p> <p>If you select a predefined characteristic type, the Search (🔍) icon appears corresponding to the Characteristic Value field. On clicking the Search icon, the Predefined Characteristic Search window appears.</p> <p>On specifying the value for a predefined characteristic type, the description of the characteristic value appears corresponding to the Characteristic Value field.</p>	<p>Note: This field is required when you are searching for a policy using a characteristic.</p>

Note: You must specify at least one search criterion while searching for a policy.

- **Search Results** - On clicking the **Search** button, the search results appear based on the specified search criteria. The **Search Results** section contains the following columns:

Column Name	Column Description
Policy Number	Displays the policy number.
Policy Information	Displays additional information about the policy.
	Note: It has a link. On clicking the link, the Policy screen appears where you can view the details of the respective policy.
Source System	Indicates the external system from where the policy is originated.
Description	Displays the description of the policy.
Start Date	Displays the date from when the policy is effective.
End Date	Displays the date till when the policy is effective.

Column Name	Column Description						
Status	<p>Indicates the status of the policy. If the policy is created using the C1-POLICY business object, the valid values are:</p> <ul style="list-style-type: none"> • Pending • In Force/Active • Pending Cancellation • Canceled • Pending Reinstatement • Reinstated • Pending Termination • Terminated <p>However, if the policy is created using the C1-ASOPolicy business object, the valid values are:</p> <ul style="list-style-type: none"> • Pending • In Force/Active • Runout • Post Runout 						
Main Customer	<p>This column displays different data depending on whether you search for a policy using the policy or person details. The following table describes this column:</p> <table border="1" data-bbox="574 1035 1463 1717"> <thead> <tr> <th data-bbox="574 1035 1019 1085">If you search for a policy using...</th> <th data-bbox="1019 1035 1463 1085">Then...</th> </tr> </thead> <tbody> <tr> <td data-bbox="574 1085 1019 1467">The Policy Date/Policy Type/Status, Source System/Policy Number/Description, or Policy Characteristics option</td> <td data-bbox="1019 1085 1463 1467"> <p>The Main Customer column displays the name of the person who is the main customer of the policy. In addition, this column has a context menu which helps in navigating to other screens in the application.</p> <div style="border: 1px solid black; padding: 5px; margin-top: 10px;"> <p>Note: It has a link. On clicking the link, the Person screen appears where you can view the details of the respective person.</p> </div> </td> </tr> <tr> <td data-bbox="574 1467 1019 1717">The Person Name/Person Identifier option</td> <td data-bbox="1019 1467 1463 1717"> <p>The Main Customer column indicates whether the person is the main customer of the policy. The valid values are:</p> <ul style="list-style-type: none"> • Yes • No </td> </tr> </tbody> </table>	If you search for a policy using...	Then...	The Policy Date/Policy Type/Status, Source System/Policy Number/Description, or Policy Characteristics option	<p>The Main Customer column displays the name of the person who is the main customer of the policy. In addition, this column has a context menu which helps in navigating to other screens in the application.</p> <div style="border: 1px solid black; padding: 5px; margin-top: 10px;"> <p>Note: It has a link. On clicking the link, the Person screen appears where you can view the details of the respective person.</p> </div>	The Person Name/Person Identifier option	<p>The Main Customer column indicates whether the person is the main customer of the policy. The valid values are:</p> <ul style="list-style-type: none"> • Yes • No
If you search for a policy using...	Then...						
The Policy Date/Policy Type/Status, Source System/Policy Number/Description, or Policy Characteristics option	<p>The Main Customer column displays the name of the person who is the main customer of the policy. In addition, this column has a context menu which helps in navigating to other screens in the application.</p> <div style="border: 1px solid black; padding: 5px; margin-top: 10px;"> <p>Note: It has a link. On clicking the link, the Person screen appears where you can view the details of the respective person.</p> </div>						
The Person Name/Person Identifier option	<p>The Main Customer column indicates whether the person is the main customer of the policy. The valid values are:</p> <ul style="list-style-type: none"> • Yes • No 						

Column Name	Column Description
Person Information	Indicates the person who is associated with the policy. In addition, this column has a context menu which helps in navigating to other screens in the application.
	<p>Note:</p> <p>It has a link. On clicking the link, the Person screen appears where you can view the details of the respective person.</p> <p>This column appears when the Person Name/Person Identifier option is selected from the Search By list.</p>
Policy Person Role	Indicates the role using which the person is associated with the policy.
	<p>Note: This column appears when the Person Name/Person Identifier option is selected from the Search By list.</p>

Note: Pagination is used to display limited number of records in the **Search Results** section. You can use the navigation links, such as **Previous** and **Next** to navigate between pages.

Related Topics

For more information on...	See...
How to search for a policy	Searching for a Policy on page 307
How to define a policy	Defining a Policy on page 308
How to view the details of a policy	Viewing the Policy Details on page 308

Searching for a Policy

Prerequisites

To search for a policy, you should have:

- Policy types and person identifier types defined in the application
- Values defined for the **C1-SourceSystemLookup** extendable lookup
- Characteristic types defined in the application (where the characteristic entity is set to **Policy**)

Procedure

To search for a policy:

1. Click the **Menu** link in the **Application** toolbar.
A list appears.
2. From the **Main** menu, select **Customer Management** and then click **Policy**.
A sub-menu appears.
3. Click the **Search** option from the **Policy** sub-menu.
The **Policy** screen appears.
4. Enter the search criteria in the **Search Policy** zone.

Note: ORMB search engine supports wildcard search, where you can substitute the percentage (%) symbol as a stand in for any word or letter in a search criteria. You can use the ‘%’ wildcard character in all input fields except the date and ID fields. The ‘%’ wildcard character is suffixed automatically at the end of the partial search criteria. Therefore, you may or may not specify the wildcard character at the end of the partial search criteria. However, you have to prefix the wildcard character manually wherever required.

5. Click **Search**.

A list of policies that meet the search criteria appears in the **Search Results** section.

Related Topics

For more information on...	See...
Policy screen	Policy (Used for Viewing) on page 314
Search Policy zone	Search Policy on page 303

Viewing the Policy Details

Procedure

To view the details of a policy:

1. Search for the policy in the **Policy** screen.
2. In the **Search Results** section, click the link in the **Policy Information** column corresponding to the policy whose details you want to view.

The **Policy** screen appears.

3. Ensure that the **Main** tab is selected.
4. View the details of the policy in the **Policy** zone.

Related Topics

For more information on...	See...
How to search for a policy	Searching for a Policy on page 307
Policy screen	Policy (Used for Viewing) on page 314
Policy zone	Policy on page 315

Defining a Policy

Oracle Revenue Management and Billing enables you to define a policy for the fully-insured and self-funded health insurance business. You can define a fully-insured group policy using a policy type where the policy category is set to **Fully-Insured Group** or **Fully-Insured Individual**. However, you can define a self-funded policy using a policy type where the policy category is set to **Self-Funded**.

Note: At present, the **Fully-Insured Individual** policy category is not supported in the system.

Prerequisites

To define a policy, you should have:

- Policy types defined in the application
- Values defined for the **C1-SourceSystemLookup** extendable lookup

Note: This prerequisite is applicable only when you want to define a fully-insured group policy.

- Values defined for the **RUNOUT_ADM_OPT_FLG** lookup field

Note: This prerequisite is applicable when you want to define a self-funded policy.

Procedure

To define a policy:

1. Click the **Menu** link in the **Application** toolbar.
A list appears.
2. From the **Main** menu, select **Customer Management** and then click **Policy**.
A sub-menu appears.
3. Click the **Add** option from the **Policy** sub-menu.

The **Select Policy Type** screen appears. It contains the following field:

Field Name	Field Description	Mandatory (Yes or No)
Policy Type	Used to indicate the policy type using which you want to create a policy. Note: If you want to create a fully-insured group policy, you must select a policy type where the policy category is set to Fully-Insured Group or Fully-Insured Individual . However, if you want to create a self-funded policy, you must select a policy type where the policy category is set to Self-Funded .	Yes

Tip: Alternatively, you can access this screen by clicking the **Add** button in the **Page Title** area of the **Policy** screen.

4. Select the required policy type from the respective field.
5. Click **OK**.

The **Policy** screen appears. It contains the following sections:

- **Main** - Used to specify the basic details about the policy.
- **Persons** - Used to associate persons with the policy.
- **Characteristics** - Used to define the characteristics for the policy.

The **Main** section contains the following fields:

Field Name	Field Description	Mandatory (Yes or No)
Policy Type	Indicates the policy type using which you are defining the policy.	Not applicable
Policy Number	Used to specify the policy number.	Yes
Description	Used to specify the description for the policy.	Yes

Field Name	Field Description	Mandatory (Yes or No)
Source System	Used to indicate the external system from where the policy is originated.	Yes
	Note: This field appears when you are defining a policy using a policy type where the policy category is set to Fully-Insured Group or Fully-Insured Individual .	
Start Date	Used to specify the date from when the policy is effective.	Yes
	Note: The policy start date cannot be later than the policy end date.	
End Date	Used to specify the date till when the policy is effective.	Yes
	Note: The policy end date cannot be earlier than the policy start date.	
Runout End Date	Used to specify the date when the runout period of the self-funded policy ends.	No
	Note: The runout end date cannot be earlier than or equal to the policy end date. This field appears when you are defining a policy using a policy type where the policy category is set to Self-Funded .	
Runout Administration Fees	Used to indicate whether the administration fees must be charged when the claim transaction for the self-funded policy is processed in the runout period. The valid values are: <ul style="list-style-type: none"> • None • Percentage of Claim 	No
	Note: At present, this field is used only for the informational purposes and is not considered during the billable charge creation for the claim transactions which are received in the runout period of the policy. This field appears when you are defining a policy using a policy type where the policy category is set to Self-Funded .	

Field Name	Field Description	Mandatory (Yes or No)
Advance Level Funding Eligibility	Indicates whether the self-funded policy is eligible for advance billing feature of level funding.	Not applicable
	<p>Note:</p> <p>This is a read-only field. By default, the value is set to No. You can edit the advance level funding eligibility only through a health care inbound message.</p> <p>This field appears when you are defining a policy using a policy type where the policy category is set to Self-Funded.</p>	

6. Enter the required details in the **Main** section.
7. Associate the required persons with the policy.

Note: While defining a policy, you must associate a person who is the main customer of the policy.

8. Define the characteristics for the policy, if required.
9. Click **Save**.

The policy is defined and its status is set to **Pending**.

Related Topics

For more information on...	See...
Policy screen	Policy (Used for Viewing) on page 314
How to associate a person with a policy	Associating a Person with a Policy on page 311
How to define a characteristic for a policy	Defining a Characteristic for a Policy on page 313

Associating a Person with a Policy

Prerequisites

To associate a person with a policy, you should have:

- Required persons defined in the application
- Required policy person roles defined in the application

Procedure

To associate a person with a policy:

1. Ensure that the **Persons** section is expanded when you are defining or editing a policy.

The **Persons** section contains the following fields in a grid:

Field Name	Field Description	Mandatory (Yes or No)
Person	Used to indicate the person that you want to associate with the policy.	Yes
	<p>Note:</p> <p>The Search (🔍) icon appears corresponding to this field. On clicking the Search icon, the Person Search window appears.</p> <p>On specifying the person ID, the person name appears corresponding to the Person field.</p>	
Sequence	Used to specify the sequence number for the associated person.	Yes
Policy Person Role	Used to indicate the role of a person in the policy.	Yes
Main Customer	Used to indicate whether the person is the main customer of the policy.	Yes (Conditional)
	<p>Note: At a time, only one person can be the main customer of the policy.</p>	
Start Date	Used to specify the date from when the person is associated with the policy.	Yes
	<p>Note:</p> <p>The start date cannot be later than the end date.</p> <p>The start date cannot be earlier than the policy start date and later than the policy end date.</p>	
End Date	Used to specify the date till when the person is associated with the policy.	No
	<p>Note:</p> <p>The end date cannot be earlier than the start date.</p> <p>The end date cannot be earlier than the policy start date and later than the policy end date. This validation is done when the policy is transition to the status which is not specified in the Skip Status for Policy Person End Date Validation parameter of the C1-POLBOVAL algorithm. For example, if you set the Skip Status for Policy Person End Date Validation parameter of the C1-POLBOVAL algorithm to TERMINATED, the system will not perform this validation when the status of the policy is changed to Terminated.</p>	

2. Enter the required details in the **Persons** section.

Note: While associating the persons with a policy, you must always ensure that one person is the main customer of the policy.

- If you want to associate more than one person with the policy, click the **Add (+)** icon and then repeat step 2.

Note: However, if you want to dissociate a person from the policy, click the **Delete (🗑)** icon corresponding to the person.

- Click **Save**.

The persons are associated with the policy.

Related Topics

For more information on...	See...
How to define a policy	Defining a Policy on page 308
How to edit a policy	Editing a Policy on page 325

Defining a Characteristic for a Policy

Prerequisites

To define a characteristic for a policy, you should have:

- Characteristic types defined in the application (where the characteristic entity is set to **Policy**)

Procedure

To define a characteristic for a policy:

- Ensure that the **Characteristics** section is expanded when you are defining or editing a policy.

The **Characteristics** section contains the following fields in a grid:

Field Name	Field Description	Mandatory (Yes or No)
Effective Date	Used to specify the date from when the characteristic is effective for the policy.	Yes (Conditional)
	Note: The effective date cannot be earlier than the policy start date and later than the policy end date.	Note: This field is required when you are defining a characteristic for the policy.
Characteristic Type	Used to indicate the characteristic type.	Yes (Conditional)
	Note: The list includes only those characteristic types where the characteristic entity is set to Policy .	Note: This field is required when you are defining a characteristic for the policy.

Field Name	Field Description	Mandatory (Yes or No)
Characteristic Value	Used to specify the value for the characteristic type.	Yes (Conditional)
	<p>Note:</p> <p>If you select a predefined characteristic type, the Search (🔍) icon appears corresponding to the Characteristic Value field. On clicking the Search icon, the Predefined Characteristic Search window appears.</p> <p>On specifying the value for a predefined characteristic type, the description of the characteristic value appears corresponding to the Characteristic Value field.</p>	<p>Note: This field is required when you are defining a characteristic for the policy.</p>

- Enter the required details in the **Characteristics** section.
- If you want to define more than one characteristic for the policy, click the **Add** (+) icon and then repeat step 2.

Note: However, if you want to remove a characteristic from the policy, click the **Delete** (🗑️) icon corresponding to the characteristic.

- Click **Save**.

The characteristics are defined for the policy.

Related Topics

For more information on...	See...
How to define a policy	Defining a Policy on page 308
How to edit a policy	Editing a Policy on page 325

Policy (Used for Viewing)

The **Policy** screen allows you to:

- View the details of a fully-insured group or self-funded policy
- Edit the details of a fully-insured group or self-funded policy
- Activate a fully-insured group or self-funded policy
- Add or edit plans in a fully-insured group policy
- Add memberships to a fully-insured group policy plan
- Initiate the termination process for a fully-insured group policy
- Terminate a fully-insured group policy
- Initiate the cancellation process for a fully-insured group policy
- Cancel a fully-insured group policy
- Initiate the reinstatement process for a fully-insured group policy
- Reinstatement a fully-insured group policy
- View the log of a fully-insured group or self-funded policy

- Add a log entry for a fully-insured group or self-funded policy

It consists of the following tabs:

- [Policy - Main](#) on page 315
- [Policy - Plan](#) on page 322
- [Policy - Log](#) on page 324

Policy - Main

The **Main** tab displays information about the policy. It contains the following zones:

- [Policy](#) on page 315
- [Policy Characteristics](#) on page 321

Policy

The **Policy** zone displays the details of the fully-insured group or self-funded policy. It contains the following sections:

- **Main** - Displays basic information about the policy. It contains the following fields:

Field Name	Field Description
Base Policy Information	Displays information about the base policy.
	Note: This field appears when you are viewing the details of a renewed policy which is created using a policy type where the policy category is set to Self-Funded .
Policy Information	Displays information about the policy.
Policy Type	Indicates the policy type using which the policy is created.
	Note: It has a link. On clicking the link, the Policy Type screen appears where you can view the details of the respective policy type.
Status	<p>Indicates the status of the policy. If the policy is created using the C1-POLICY business object, the valid values are:</p> <ul style="list-style-type: none"> • Pending • In Force/Active • Pending Cancellation • Canceled • Pending Reinstatement • Reinstated • Pending Termination • Terminated <p>However, if the policy is created using the C1-ASOPolicy business object, the valid values are:</p> <ul style="list-style-type: none"> • Pending • In Force/Active • Runout • Post Runout

Field Name	Field Description
Status Reason	Indicates the reason why the policy is terminated.
	<p>Note:</p> <p>It has a link. On clicking the link, the Status Reason screen appears where you can view the details of the respective termination reason.</p> <p>This field appears when you are viewing the details of a terminated or reinstated policy which is created using a policy type where the policy category is set to Fully-Insured Group or Fully-Insured Individual.</p>
Policy Number	Displays the policy number.
Description	Displays the description of the policy.
Source System	Indicates the external system from where the policy is originated.
Start Date	Displays the date from when the policy is effective.
End Date	Displays the date till when the policy is effective.
Renewal Date	Displays the date when the policy is renewed.
	<p>Note: This field appears when you are viewing the details of a policy which is renewed.</p>

Field Name	Field Description																																													
Paid Through Date	<p data-bbox="532 212 1468 275">Indicates the term end date of the last fully or partially paid term. The system considers the term to be fully paid when the threshold limit is met.</p> <div data-bbox="532 296 1468 562" style="border: 1px solid black; padding: 5px;"> <p data-bbox="532 302 597 327">Note:</p> <p data-bbox="532 348 1149 373">This field appears when the following conditions are met:</p> <ul data-bbox="561 394 1468 537" style="list-style-type: none"> <li data-bbox="561 394 1468 485">• When you are viewing the details of a policy which is created using a policy type where the policy category is set to Fully-Insured Group or Fully-Insured Individual. <li data-bbox="561 506 1235 537">• When the paid through date is calculated at the policy level. </div> <p data-bbox="532 583 1468 646">The paid through date is calculated while freezing or canceling a payment or adjustment depending on whether the required algorithm is attached to the respective system event:</p> <table border="1" data-bbox="532 667 1468 919"> <thead> <tr> <th data-bbox="532 667 792 716">Entity</th> <th data-bbox="792 667 1170 716">System Event</th> <th data-bbox="1170 667 1468 716">Algorithm</th> </tr> </thead> <tbody> <tr> <td data-bbox="532 716 792 764">Customer Class</td> <td data-bbox="792 716 1170 764">Payment Freeze</td> <td data-bbox="1170 716 1468 764">C1-PSPTDCAL</td> </tr> <tr> <td data-bbox="532 764 792 812">Customer Class</td> <td data-bbox="792 764 1170 812">Payment Cancellation</td> <td data-bbox="1170 764 1468 812">C1-PXPTDCAL</td> </tr> <tr> <td data-bbox="532 812 792 861">Adjustment Type</td> <td data-bbox="792 812 1170 861">Adjustment Freeze</td> <td data-bbox="1170 812 1468 861">C1-ADPTDCAL</td> </tr> <tr> <td data-bbox="532 861 792 909">Adjustment Type</td> <td data-bbox="792 861 1170 909">Adjustment Cancellation</td> <td data-bbox="1170 861 1468 909">C1-AXPTDCAL</td> </tr> </tbody> </table> <p data-bbox="532 940 1468 1003">The following table indicates when the paid through date is calculated at the policy and/or membership level:</p> <table border="1" data-bbox="532 1024 1468 1976"> <thead> <tr> <th data-bbox="532 1024 727 1234">If the Paid Through Date Calculation Level parameter is set to...</th> <th data-bbox="727 1024 1008 1234">If the following characteristics are defined for the billable charge or adjustment...</th> <th data-bbox="1008 1024 1468 1234">Then...</th> </tr> </thead> <tbody> <tr> <td data-bbox="532 1234 727 1318">P</td> <td data-bbox="727 1234 1008 1318">C1-POLID</td> <td data-bbox="1008 1234 1468 1318">Paid through date is calculated at the policy level</td> </tr> <tr> <td data-bbox="532 1318 727 1402">P</td> <td data-bbox="727 1318 1008 1402">C1-MPID</td> <td data-bbox="1008 1318 1468 1402">Paid through date is calculated at the policy level</td> </tr> <tr> <td data-bbox="532 1402 727 1486">P</td> <td data-bbox="727 1402 1008 1486">C1-POLID and C1-MPID</td> <td data-bbox="1008 1402 1468 1486">Paid through date is calculated at the policy level</td> </tr> <tr> <td data-bbox="532 1486 727 1570">M</td> <td data-bbox="727 1486 1008 1570">C1-POLID</td> <td data-bbox="1008 1486 1468 1570">Paid through date is not calculated at the membership level</td> </tr> <tr> <td data-bbox="532 1570 727 1654">M</td> <td data-bbox="727 1570 1008 1654">C1-MPID</td> <td data-bbox="1008 1570 1468 1654">Paid through date is calculated at the membership level</td> </tr> <tr> <td data-bbox="532 1654 727 1738">M</td> <td data-bbox="727 1654 1008 1738">C1-POLID and C1-MPID</td> <td data-bbox="1008 1654 1468 1738">Paid through date is calculated at the membership level</td> </tr> <tr> <td data-bbox="532 1738 727 1822">P, M</td> <td data-bbox="727 1738 1008 1822">C1-POLID</td> <td data-bbox="1008 1738 1468 1822">Paid through date is calculated at the policy level</td> </tr> <tr> <td data-bbox="532 1822 727 1906">P, M</td> <td data-bbox="727 1822 1008 1906">C1-MPID</td> <td data-bbox="1008 1822 1468 1906">Paid through date is calculated at both the policy and membership levels</td> </tr> <tr> <td data-bbox="532 1906 727 1976">P, M</td> <td data-bbox="727 1906 1008 1976">C1-POLID and C1-MPID</td> <td data-bbox="1008 1906 1468 1976">Paid through date is calculated at both the policy and membership levels</td> </tr> </tbody> </table>	Entity	System Event	Algorithm	Customer Class	Payment Freeze	C1-PSPTDCAL	Customer Class	Payment Cancellation	C1-PXPTDCAL	Adjustment Type	Adjustment Freeze	C1-ADPTDCAL	Adjustment Type	Adjustment Cancellation	C1-AXPTDCAL	If the Paid Through Date Calculation Level parameter is set to...	If the following characteristics are defined for the billable charge or adjustment...	Then...	P	C1-POLID	Paid through date is calculated at the policy level	P	C1-MPID	Paid through date is calculated at the policy level	P	C1-POLID and C1-MPID	Paid through date is calculated at the policy level	M	C1-POLID	Paid through date is not calculated at the membership level	M	C1-MPID	Paid through date is calculated at the membership level	M	C1-POLID and C1-MPID	Paid through date is calculated at the membership level	P, M	C1-POLID	Paid through date is calculated at the policy level	P, M	C1-MPID	Paid through date is calculated at both the policy and membership levels	P, M	C1-POLID and C1-MPID	Paid through date is calculated at both the policy and membership levels
Entity	System Event	Algorithm																																												
Customer Class	Payment Freeze	C1-PSPTDCAL																																												
Customer Class	Payment Cancellation	C1-PXPTDCAL																																												
Adjustment Type	Adjustment Freeze	C1-ADPTDCAL																																												
Adjustment Type	Adjustment Cancellation	C1-AXPTDCAL																																												
If the Paid Through Date Calculation Level parameter is set to...	If the following characteristics are defined for the billable charge or adjustment...	Then...																																												
P	C1-POLID	Paid through date is calculated at the policy level																																												
P	C1-MPID	Paid through date is calculated at the policy level																																												
P	C1-POLID and C1-MPID	Paid through date is calculated at the policy level																																												
M	C1-POLID	Paid through date is not calculated at the membership level																																												
M	C1-MPID	Paid through date is calculated at the membership level																																												
M	C1-POLID and C1-MPID	Paid through date is calculated at the membership level																																												
P, M	C1-POLID	Paid through date is calculated at the policy level																																												
P, M	C1-MPID	Paid through date is calculated at both the policy and membership levels																																												
P, M	C1-POLID and C1-MPID	Paid through date is calculated at both the policy and membership levels																																												

Field Name	Field Description
Runout End Date	Displays the date when the runout period of the self-funded policy ends.
	Note: This field appears when you are viewing the details of a policy which is created using a policy type where the policy category is set to Self-Funded .
Runout Administration Fees	Indicates whether the administration fees must be charged when the claim transaction for the self-funded policy is processed in the runout period. The valid values are: <ul style="list-style-type: none"> • None • Percentage of Claim
	Note: This field appears when you are viewing the details of a policy which is created using a policy type where the policy category is set to Self-Funded .
Advance Level Funding Eligibility	Indicates whether the self-funded policy is eligible for advance billing feature of level funding.
	Note: This field appears when you are viewing the details of a policy which is created using a policy type where the policy category is set to Self-Funded .

- **Persons** - Lists the persons which are associated with the policy. It contains the following columns:

Column Name	Column Description
Person Information	Indicates the person who is associated with the policy. In addition, this column has a context menu which helps in navigating to other screens in the application.
	Note: It has a link. On clicking the link, the Person screen appears where you can view the details of the respective person.
Sequence	Displays the sequence number of the associated person.
Policy Person Role	Indicates the role of the person in the policy.
Main Customer	Indicates whether the person is the main customer of the policy.
Start Date	Displays the date from when the person is associated with the policy.
End Date	Displays the date till when the person is associated with the policy.

- **Record Actions** - This section contains the following buttons:

Button Name	Button Description						
Edit	Used to edit the details of the fully-insured group or self-funded policy.						
	<p>Note:</p> <p>The Edit button appears only when a policy of the respective category is in either of the following status:</p>						
	<table border="1"> <thead> <tr> <th data-bbox="521 403 907 451">Policy Category</th> <th data-bbox="907 403 1463 451">Status</th> </tr> </thead> <tbody> <tr> <td data-bbox="521 451 907 804">Fully-Insured Group or Fully-Insured Individual</td> <td data-bbox="907 451 1463 804"> <ul style="list-style-type: none"> • In Force/Active • Canceled • Pending Cancellation • Pending • Pending Reinstatement • Pending Termination • Terminated </td> </tr> <tr> <td data-bbox="521 804 907 957">Self-Funded</td> <td data-bbox="907 804 1463 957"> <ul style="list-style-type: none"> • In Force/Active • Pending • Runout </td> </tr> </tbody> </table>	Policy Category	Status	Fully-Insured Group or Fully-Insured Individual	<ul style="list-style-type: none"> • In Force/Active • Canceled • Pending Cancellation • Pending • Pending Reinstatement • Pending Termination • Terminated 	Self-Funded	<ul style="list-style-type: none"> • In Force/Active • Pending • Runout
	Policy Category	Status					
Fully-Insured Group or Fully-Insured Individual	<ul style="list-style-type: none"> • In Force/Active • Canceled • Pending Cancellation • Pending • Pending Reinstatement • Pending Termination • Terminated 						
Self-Funded	<ul style="list-style-type: none"> • In Force/Active • Pending • Runout 						
Activate	Used to activate the fully-insured group or self-funded policy.						
	<p>Note:</p> <p>The Activate button appears when a policy of the respective category is in either of the following status:</p>						
	<table border="1"> <thead> <tr> <th data-bbox="521 1215 954 1264">Policy Category</th> <th data-bbox="954 1215 1463 1264">Status</th> </tr> </thead> <tbody> <tr> <td data-bbox="521 1264 954 1377">Fully-Insured Group or Fully-Insured Individual</td> <td data-bbox="954 1264 1463 1377"> <ul style="list-style-type: none"> • Pending • Pending Termination </td> </tr> <tr> <td data-bbox="521 1377 954 1438">Self-Funded</td> <td data-bbox="954 1377 1463 1438"> <ul style="list-style-type: none"> • Pending </td> </tr> </tbody> </table>	Policy Category	Status	Fully-Insured Group or Fully-Insured Individual	<ul style="list-style-type: none"> • Pending • Pending Termination 	Self-Funded	<ul style="list-style-type: none"> • Pending
	Policy Category	Status					
Fully-Insured Group or Fully-Insured Individual	<ul style="list-style-type: none"> • Pending • Pending Termination 						
Self-Funded	<ul style="list-style-type: none"> • Pending 						
Initiate Cancellation	Used to initiate the cancellation process for the fully-insured group policy.						
Cancel	<p>Note: The Initiate Cancellation button appears when the fully-insured group policy is in the In Force/Active status.</p>						
	<p>Used to cancel the fully-insured group policy.</p> <p>Note: The Cancel button appears when the fully-insured group policy is in the Pending Cancellation status.</p>						

Button Name	Button Description
Initiate Termination	Used to initiate the termination process for the fully-insured group policy.
	Note: The Initiate Termination button appears when the fully-insured group policy is in the In Force/Active status.
Terminate	Used to terminate the fully-insured group policy.
	Note: The Terminate button appears when the fully-insured group policy is in the In Force/Active, Pending Reinstatement, or Pending Termination status.
Initiate Reinstatement	Used to initiate the reinstatement process for the terminated policy.
	Note: The Initiate Reinstatement button appears when the fully-insured group policy is in the Terminated status.
Reinstate	Used to reinstate the terminated policy.
	Note: The Reinstate button appears when the fully-insured group policy is in the Pending Reinstatement or Terminated status.
Runout	Used to transition the self-funded policy to the Runout status.
	<p>Note:</p> <p>The Runout button appears when the self-funded policy is in the In Force/Active status. You cannot transition a self-funded policy to the Runout status when:</p> <ul style="list-style-type: none"> • The self-funded policy is renewed. • The runout end date is not specified. • The policy end date is earlier than the system date.

- **Record Information** - This section contains the following fields:

Field Name	Field Description
Business Object	Indicates the business object using which the policy is created. In addition, a context menu appears corresponding to this field which helps in navigating to other screens in the application.
	Note: It has a link. On clicking the link, the Business Object screen appears where you can view the details of the respective business object.
Status Date/Time	Displays the date and time when the policy status is updated.
Create Date/Time	Displays the date and time when the policy is created.

- **Termination Information** - Displays the termination details of the fully-insured group policy. It appears when the policy is in the **Pending Termination** status. It contains the following fields:

Field Name	Field Description
Terminate Date	Displays the date when you want to terminate the policy.

Field Name	Field Description
Terminate Reason	Indicates the reason why the termination process is initiated for the policy.
	Note: It has a link. On clicking the link, the Status Reason screen appears where you can view the details of the respective termination reason.

- **Reinstate Information** - Displays the reinstatement details of the terminated policy. It appears when the policy is in the **Pending Reinstatement** status. It contains the following fields:

Field Name	Field Description
Reinstate Reason	Indicates the reason why you want to reinstate the fully-insured group policy.
	Note: It has a link. On clicking the link, the Status Reason screen appears where you can view the details of the respective reinstatement reason.

Related Topics

For more information on...	See...
How to edit a policy	Editing a Policy on page 325
How to activate a policy	Activating a Policy on page 325
How to initiate a cancellation request for a fully-insured group policy	Initiating the Cancellation Process for a Fully-Insured Group Policy on page 329
How to cancel a fully-insured group policy	Canceling a Fully-Insured Group Policy on page 329
How to initiate a termination request for a fully-insured group policy	Initiating the Termination Process for a Fully-Insured Group Policy on page 330
How to terminate a fully-insured group policy	Terminating a Fully-Insured Group Policy on page 331
How to initiate a reinstatement request for a fully-insured group policy	Initiating the Reinstatement Process for a Fully-Insured Group Policy on page 331
How to reinstate a fully-insured group policy	Reinstating a Fully-Insured Group Policy on page 332

Policy Characteristics

The **Policy Characteristics** zone lists the characteristics of the fully-insured group or self-funded policy. It contains the following columns:

Column Name	Column Description
Effective Date	Displays the date from when the characteristic is effective for the policy.
Characteristic Type	Indicates the characteristic type.
Characteristic Value	Displays the value of the characteristic type.

Column Name	Column Description
Description	Displays the description of the characteristic value.
	Note: The data appears in this column when the type of characteristic value is set to Predefined Value .

You can filter the list using the **Effective Date** field available in the **Filter** area. By default, the **Filter** area is hidden. You can view the **Filter** area by clicking the **Filters** () icon in the upper right corner of this zone.

Policy - Plan

The **Plan** tab lists the plans defined for the policy and memberships defined for each policy plan. It contains the following zones:

- [Plans](#) on page 322
- [Memberships](#) on page 323

Plans

The **Plans** zone lists the plans which are defined in the policy. It contains the following columns:

Column Name	Column Description
Plan Information	Displays information about the policy plan. In addition, a context menu appears corresponding to this column which helps in navigating to other screens in the application.
	Note: It has a link. On clicking the link, the Policy Plan screen appears where you can view the details of the respective policy plan.
Price Item Information	Indicates the price item to which the policy plan is directly associated.
	Note: It has a link. On clicking the link, the Price Item screen appears where you can view the details of the respective price item.
Plan Number	Displays the plan number.
Plan Name	Displays the description of the policy plan.
Benefit Type	Indicates the type of health insurance plan. The valid values are: <ul style="list-style-type: none"> • Commercial • Medicare Affiliated
Start Date	Displays the date from when the policy plan is effective.
End Date	Displays the date till when the policy plan is effective.
Edit	On clicking the Edit () icon, the Plan screen appears where you can edit the details of the policy plan.

Note: Pagination is used to display limited number of records in this zone. You can use the navigation links, such as **Previous** and **Next** to navigate between pages.

You can define a new policy plan by clicking the **Add** link in the upper-right corner of this zone. On clicking the **Broadcast** () icon corresponding to a policy plan, the **Memberships** zone appears.

Note: Ideally, you define plans in a policy which is created using a policy type where the policy category is set to **Fully-Insured Group** or **Fully-Insured Individual**.

You can filter the list using various search criteria (such as, **Price Item**, **Plan Number**, and **Effective From**) available in the **Filter** area. By default, the **Filter** area is hidden. You can view the **Filter** area by clicking the **Filters** (∨) icon in the upper-right corner of this zone.

Related Topics

For more information on...	See...
How to define a plan for a fully-insured group policy	Defining a Plan for a Fully-Insured Group Policy
How to edit a plan of a fully-insured group policy	Editing a Plan of a Fully-Insured Group Policy on page 343
Memberships zone	Memberships on page 323
How to view the plans of a fully-insured group policy	Viewing the Plans of a Fully-Insured Group Policy on page 333
How to view the memberships of a fully-insured group policy plan	Viewing the Membership Details of a Fully-Insured Group Policy Plan on page 335

Memberships

The **Memberships** zone lists the memberships which are defined for the policy plan. It contains the following columns:

Column Name	Column Description
Start Date	Displays the date from when the membership is effective.
End Date	Displays the date till when the membership is effective.
Membership Information	Displays information about the membership. Note: It has a link. On clicking the link, the Membership screen appears where you can view the details of the respective membership.
Enrolled Members	Displays the number of members who have enrolled in the policy plan.
Status	Indicates the status of the membership. The valid values are: <ul style="list-style-type: none"> • Active • Inactive • Terminated
Membership Type	Indicates the type of membership. The valid values are: <ul style="list-style-type: none"> • COBRA • Medicare • Retiree

Column Name	Column Description
Benefits	On clicking the Benefits () icon, the Benefit screen appears where you can view the Medicare benefits of the member persons who belong to the membership.
	Note: The Benefits icon appears when a Medicare benefit is defined for a member person who belongs to the membership.
Membership ID	Displays the membership ID.

Note: Pagination is used to display limited number of records in this zone. You can use the navigation links, such as **Previous** and **Next** to navigate between pages.

You can define a new membership by clicking the **Add** link in the upper right corner of this zone.

By default, the **Memberships** zone does not appear in the **Plan** tab. It appears when you click the **Broadcast** () icon corresponding to the policy plan in the **Plans** zone.

You can filter the list using various search criteria (such as, **External Membership ID**, **Effective From**, **Person Name**, **Effective Till**, and **Status**) available in the **Filter** area. By default, the **Filter** area is hidden. You can view the **Filter** area by clicking the **Filters** () icon in the upper right corner of this zone.

You can change the layout of this zone. For more information on how to change the layout, see [Changing the Layout](#) on page 3414

Related Topics

For more information on...	See...
How to define a membership for a fully-insured group policy plan	Defining a Membership for a Fully-Insured Group Policy Plan on page 359

Policy - Log

The **Log** tab contains the following zone:

- [Policy Log](#) on page 324

Policy Log

The **Policy Log** zone lists the complete trail of actions performed on the policy. It contains the following columns:

Column Name	Column Description
Creation Date Time	Displays the date and time when the action was performed on the policy.
Details	Displays the details about the action performed on the policy.
User	Indicates the user who has performed the action on the policy.
Log Type	Indicates the type of log.
Related Object	Indicates the object or entity which is created when the action is performed on the policy.
	Note: It contains a link. On clicking the link, the screen appears where you can view the details of the respective related object.
Status Reason	Indicates the reason why the status of the policy is changed.

Note: You can manually add a log entry for the policy by clicking the **Add Log Entry** link in the upper right corner of the **Policy Log** zone.

Related Topics

For more information on...	See...
How to view the log of a policy	Viewing the Log of a Policy on page 346
How to add a log entry for a policy	Adding a Log Entry for a Policy on page 346

Activating a Policy

Procedure

To activate a policy:

1. Search for the policy in the **Policy** screen.
2. In the **Search Results** section, click the link in the **Policy Information** column corresponding to the policy that you want to activate.

The **Policy** screen appears.

3. Ensure that the **Main** tab is selected.
4. Click the **Activate** button in the **Policy** zone.

The status of the policy is changed to **In Force/Active**.

Note:

The **Activate** button appears only when a policy of the respective category is in either of the following status:

Policy Category	Status
Fully-Insured Group or Fully-Insured Individual	<ul style="list-style-type: none"> • Pending • Pending Termination
Self-Funded	<ul style="list-style-type: none"> • Pending

Related Topics

For more information on...	See...
How to search for a policy	Searching for a Policy on page 307
Policy screen	Policy (Used for Viewing) on page 314
Policy zone	Policy on page 315

Editing a Policy

Prerequisites

To edit a policy, you should have:

- Values defined for the **C1-SourceSystemLookup** extendable lookup

Note: This prerequisite is applicable only when you want to define a fully-insured group policy.

- Values defined for the **RUNOUT_ADM_OPT_FLG** lookup field

Note: This prerequisite is applicable when you want to define a self-funded policy.

Procedure

To edit a policy:

1. Search for the policy in the **Policy** screen.
2. In the **Search Results** section, click the link in the **Policy Information** column corresponding to the policy whose details you want to edit.

The **Policy** screen appears.

3. Ensure that the **Main** tab is selected.
4. Click the **Edit** button in the **Policy** zone.

The **Policy** screen appears. It contains the following sections:

- **Main** - Used to specify the basic details about the policy.
- **Persons** - Used to associate persons with the policy.
- **Characteristics** - Used to define the characteristics for the policy.

The **Main** section contains the following fields:

Field Name	Field Description	Mandatory (Yes or No)
Policy Information	Displays information about the policy.	Not applicable
Policy Type	Indicates the policy type using which the policy is defined.	Not applicable
Status	Indicates the status of the policy. The valid values are: <ul style="list-style-type: none"> • Pending • In Force/Active • Runout • Post Runout 	Not applicable
	Note: This field appears when you are editing a policy which is created using a policy type where the policy category is set to Self-Funded .	
Policy Number	Used to specify the policy number.	Yes
Description	Used to specify the description for the policy.	Yes
Source System	Used to indicate the external system from where the policy is originated.	Yes
	Note: This field appears when you are editing a policy which is created using a policy type where the policy category is set to Fully-Insured Group or Fully-Insured Individual .	

Field Name	Field Description	Mandatory (Yes or No)
Start Date	Used to specify the date from when the policy is effective.	Yes
	<p>Note:</p> <p>The policy start date cannot be later than the policy end date.</p> <p>You cannot change the start date of a self-funded policy when it is in the In Force/Active, Runout, or Post Runout status.</p>	
End Date	Used to specify the date till when the policy is effective.	Yes
	<p>Note:</p> <p>The policy end date cannot be earlier than the policy start date.</p> <p>You cannot change the end date when the self-funded policy is in the Runout status.</p> <p>You cannot set the end date of a self-funded policy to a date which is later than or equal to the start date of a pricing rule which is defined for the Runout status.</p> <p>You cannot change the end date when the policy is renewed.</p>	
Runout End Date	Used to specify the date when the runout period of the self-funded policy ends.	No
	<p>Note:</p> <p>This field appears when you are editing a policy which is created using a policy type where the policy category is set to Self-Funded.</p> <p>The runout end date cannot be earlier than or equal to the policy end date.</p> <p>The runout end date cannot be earlier than or equal to the system date when the policy is in the Runout status.</p> <p>You cannot remove the runout end date when the policy is in the Runout or Post Runout status.</p> <p>You cannot set the runout end date to a date which is later than or equal to the start date of a pricing rule which is defined for the Post Runout status.</p> <p>You cannot set the runout end date to a date which is earlier than the end date of a pricing rule which is defined for the Runout status.</p>	

Field Name	Field Description	Mandatory (Yes or No)
Runout Administration Fees	<p>Used to indicate whether the administration fees must be charged when the claim transaction for the self-funded policy is processed in the runout period. The valid values are:</p> <ul style="list-style-type: none"> • None • Percentage of Claim 	No
	<p>Note:</p> <p>At present, this field is used only for the informational purposes and is not considered during the billable charge creation for the claim transactions which are received in the runout period of the policy.</p> <p>This field appears when you are editing a policy which is created using a policy type where the policy category is set to Self-Funded.</p>	

Note:	
The Edit button appears when a policy of the respective category is in either of the following status:	
Policy Category	Status
Fully-Insured Group or Fully-Insured Individual	<ul style="list-style-type: none"> • In Force/Active • Canceled • Pending Cancellation • Pending • Pending Reinstatement • Pending Termination • Terminated
Self-Funded	<ul style="list-style-type: none"> • In Force/Active • Pending • Runout

5. Modify the required details in the **Main** section.
6. Associate the persons with the policy, if required.

Note: While editing a policy, you must ensure that one person is associated as the main customer of the policy.

7. Define, edit, or remove characteristics of the policy, if required.
8. Click **Save**.

The changes made to the policy are saved.

Related Topics

For more information on...	See...
How to search for a policy	Searching for a Policy on page 307
Policy screen	Policy (Used for Viewing) on page 314
Policy zone	Policy on page 315
How to associate a person with a policy	Associating a Person with a Policy on page 311
How to define a characteristic for a policy	Defining a Characteristic for a Policy on page 313

Initiating the Cancellation Process for a Fully-Insured Group Policy

Procedure

To initiate the cancellation process for a fully-insured group policy:

1. Search for the fully-insured group policy in the **Policy** screen.
2. In the **Search Results** section, click the link in the **Policy Information** column corresponding to the policy for which you want to initiate the cancellation process.

The **Policy** screen appears.

3. Ensure that the **Main** tab is selected.
4. Click the **Initiate Cancellation** button in the **Policy** zone.

The status of the policy is changed to **Pending Cancellation**.

Note: The **Initiate Cancellation** button appears when the fully-insured group policy is in the **In Force/Active** status.

Related Topics

For more information on...	See...
How to search for a fully-insured group policy	Searching for a Policy on page 307
Policy screen	Policy (Used for Viewing) on page 314
Policy zone	Policy on page 315

Canceling a Fully-Insured Group Policy

Procedure

To cancel a fully-insured group policy:

1. Search for the fully-insured group policy in the **Policy** screen.
2. In the **Search Results** section, click the link in the **Policy Information** column corresponding to the policy that you want to cancel.

The **Policy** screen appears.

3. Ensure that the **Main** tab is selected.
4. Click the **Cancel** button in the **Policy** zone.

The status of the policy is changed to **Canceled**.

Note: The **Cancel** button appears when the fully-insured group policy is in the **Pending Cancellation** status.

Related Topics

For more information on...	See...
How to search a fully-insured group policy	Searching for a Policy on page 307
Policy screen	Policy (Used for Viewing) on page 314
Policy zone	Policy on page 315

Initiating the Termination Process for a Fully-Insured Group Policy

Prerequisites

To initiate the termination process for a fully-insured group policy, you should have:

- Reasons defined for the **Terminated** status of the **C1-POLICY** business object in the **Status Reason** screen

Procedure

To initiate the termination process for a fully-insured group policy:

1. Search for the fully-insured group policy in the **Policy** screen.
2. In the **Search Results** section, click the link in the **Policy Information** column corresponding to the policy for which you want to initiate the termination process.

The **Policy** screen appears.

3. Ensure that the **Main** tab is selected.
4. Click the **Initiate Termination** button in the **Policy** zone.

The **Termination Information** window appears. It contains the following fields:

Field Name	Field Description	Mandatory (Yes or No)
Terminate Reason	Used to indicate the reason why you want to initiate the termination process for the fully-insured group policy.	Yes
Terminate Date	Used to specify the date when you want to terminate the policy.	Yes
	Note: The terminate date cannot be earlier than the policy start date or later than the policy end date.	

Note: The **Initiate Termination** button appears when the fully-insured group policy is in the **In Force/Active** status.

5. Enter the required details in the **Termination Information** window.
6. Click **Save**.

The status of the fully-insured group policy is changed to **Pending Termination**.

Related Topics

For more information on...	See...
How to search for a fully-insured group policy	Searching for a Policy on page 307
Policy screen	Policy (Used for Viewing) on page 314
Policy zone	Policy on page 315

Terminating a Fully-Insured Group Policy

Prerequisites

To terminate a fully-insured group policy, you should have:

- Reasons defined for the **Terminated** status of the **C1-POLICY** business object in the **Status Reason** screen

Procedure

To terminate a fully-insured group policy:

- Search for the fully-insured group policy in the **Policy** screen.
- In the **Search Results** section, click the link in the **Policy Information** column corresponding to the policy that you want to terminate.

The **Policy** screen appears.

- Ensure that the **Main** tab is selected.
- Click the **Terminate** button in the **Policy** zone.

The **Status Reason** window appears. It contains the following field:

Field Name	Field Description	Mandatory (Yes or No)
Status Reason	Used to indicate the reason why you want to terminate the fully-insured group policy.	Yes

Note: The **Terminate** button appears when the fully-insured group policy is in the **In Force/Active**, **Pending Reinstatement**, or **Pending Termination** status.

- Select the terminate reason from the respective field.
- Click **Save**.

The status of the policy is changed to **Terminated**.

Note: You cannot terminate a fully-insured group policy which is in the **Pending Termination** status when the terminate date is earlier than the system date.

Related Topics

For more information on...	See...
How to search for a fully-insured group policy	Searching for a Policy on page 307
Policy screen	Policy (Used for Viewing) on page 314
Policy zone	Policy on page 315

Initiating the Reinstatement Process for a Fully-Insured Group Policy

Prerequisites

To initiate the reinstatement process for a fully-insured group policy, you should have:

- Reasons defined for the **Reinstated** status of the **C1-POLICY** business object in the **Status Reason** screen

Procedure

To initiate the reinstatement process for a fully-insured group policy:

1. Search for the fully-insured group policy in the **Policy** screen.
2. In the **Search Results** section, click the link in the **Policy Information** column corresponding to the policy for which you want to initiate the reinstatement process.

The **Policy** screen appears.

3. Ensure that the **Main** tab is selected.
4. Click the **Initiate Reinstatement** button in the **Policy** zone.

The **Reinstatement Information** window appears. It contains the following field:

Field Name	Field Description	Mandatory (Yes or No)
Reinstatement Reason	Used to indicate the reason why you want to initiate the reinstatement process for the fully-insured group policy.	Yes

Note: The **Initiate Reinstatement** button appears when the fully-insured group policy is in the **Terminated** status.

5. Select the reinstatement reason from the respective field.
6. Click **Save**.

The status of the fully-insured group policy is changed to **Pending Reinstatement**.

Related Topics

For more information on...	See...
How to search for a fully-insured group policy	Searching for a Policy on page 307
Policy screen	Policy (Used for Viewing) on page 314
Policy zone	Policy on page 315

Reinstating a Fully-Insured Group Policy

Prerequisites

To reinstate a fully-insured group policy, you should have:

- Reasons defined for the **Reinstated** status of the **C1-POLICY** business object in the **Status Reason** screen

Procedure

To reinstate a fully-insured group policy:

1. Search for the fully-insured group policy in the **Policy** screen.
2. In the **Search Results** section, click the link in the **Policy Information** column corresponding to the policy that you want to reinstate.

The **Policy** screen appears.

3. Ensure that the **Main** tab is selected.
4. Click the **Reinstatement** button in the **Policy** zone.

The **Status Reason** window appears. It contains the following field:

Field Name	Field Description	Mandatory (Yes or No)
Status Reason	Used to indicate the reason why you want to reinstate the fully-insured group policy.	Yes

Note: The **Reinstate** button appears when the fully-insured group policy is in the **Pending Reinstatement** or **Terminated** status.

5. Select the reinstatement reason from the respective field.
6. Click **Save**.

The status of the policy is changed to **Reinstated**.

Related Topics

For more information on...	See...
How to search for a fully-insured group policy	Searching for a Policy on page 307
Policy screen	Policy (Used for Viewing) on page 314
Policy zone	Policy on page 315

Viewing the Plans of a Fully-Insured Group Policy

Procedure

To view the plans of a fully-insured group policy:

1. Search for the fully-insured group policy in the **Policy** screen.
2. In the **Search Results** section, click the link in the **Policy Information** column corresponding to the policy whose details you want to view.

The **Policy** screen appears.

3. Click the **Plan** tab.

The **Plan** tab appears.

4. View the plans of the fully-insured group policy in the **Plans** zone.

Related Topics

For more information on...	See...
How to search for a fully-insured group policy	Searching for a Policy on page 307
Policy screen	Policy (Used for Viewing) on page 314
Plans zone	Plans on page 322

Viewing the Memberships of a Fully-Insured Group Policy Plan

Procedure

To view the memberships of a fully-insured group policy plan:

1. Search for the fully-insured group policy in the **Policy** screen.

2. In the **Search Results** section, click the link in the **Policy Information** column corresponding to the policy whose details you want to view.
The **Policy** screen appears.
3. Click the **Plan** tab.
The **Plan** tab appears.
4. In the **Plans** zone, click the **Broadcast** (📡) icon corresponding to the policy plan whose memberships you want to view.
The **Memberships** zone appears.
5. View the memberships of the fully-insured group policy plan in the **Memberships** zone.

Related Topics

For more information on...	See...
How to search for a fully-insured group policy	Searching for a Policy on page 307
Policy screen	Policy (Used for Viewing) on page 314
Plans zone	Plans on page 322
Memberships zone	Memberships on page 323

Viewing the Fully-Insured Group Policy Plan Details

Procedure

To view the details of a fully-insured group policy plan:

1. Search for the fully-insured group policy in the **Policy** screen.
2. In the **Search Results** section, click the link in the **Policy Information** column corresponding to the policy whose details you want to view.
The **Policy** screen appears.
3. Click the **Plan** tab.
The **Plan** tab appears.
4. In the **Plans** zone, click the link in the **Plan Information** column corresponding to the policy plan whose details you want to view.
The **Policy Plan** screen appears.
5. View the basic details of the policy plan in the **Policy Plan** zone.
6. View the characteristics of the policy plan in the **Plan Characteristics** zone.
7. View the memberships of the policy plan in the **Memberships** zone.

Related Topics

For more information on...	See...
How to search for a fully-insured group policy	Searching for a Policy on page 307
Policy screen	Policy (Used for Viewing) on page 314
Plans zone	Plans on page 322

For more information on...	See...
Policy Plan screen	Policy Plan (Used for Viewing) on page 347
Policy Plan zone	Policy Plan on page 347
Plan Characteristics zone	Plan Characteristics on page 349
Memberships zone	Memberships on page 323

Viewing the Membership Details of a Fully-Insured Group Policy Plan

Procedure

To view the details of a membership in a fully-insured group policy plan:

1. Search for the fully-insured group policy in the **Policy** screen.
2. In the **Search Results** section, click the link in the **Policy Information** column corresponding to the policy whose details you want to view.
The **Policy** screen appears.
3. Click the **Plan** tab.
The **Plan** tab appears.
4. In the **Plans** zone, click the **Broadcast** () icon corresponding to the fully-insured group policy plan whose membership details you want to view.
The **Memberships** zone appears.
5. In the **Memberships** zone, click the link in the **Membership Information** column corresponding to the membership whose details you want to view.
The **Membership** screen appears.
6. Ensure that the **Main** tab is selected.
7. View the basic details of the membership in the **Membership** zone.
8. View the characteristics of the membership in the **Membership Characteristics** zone.
9. View the persons who are added to the membership in the **Member Persons** zone.
10. View the characteristics of the member person in the **Member Person Characteristics** zone.
11. View the additional memberships of the main subscriber in the **Other Plans of Main Subscriber** zone.

Related Topics

For more information on...	See...
How to search for a fully-insured group policy	Searching for a Policy on page 307
Policy screen	Policy (Used for Viewing) on page 314
Plans zone	Plans on page 322
Memberships zone	Memberships on page 323
Membership screen	Membership (Used for Viewing) on page 363
Membership zone	Membership on page 363
Membership Characteristics zone	Membership Characteristics on page 366

For more information on...	See...
Member Persons zone	Member Persons on page 366
Member Person Characteristics zone	Member Person Characteristics on page 368
Other Plans of Main Subscriber zone	Other Plans of Main Subscriber on page 368

Defining a Plan for a Fully-Insured Group Policy

Prerequisites

To define a plan for a fully-insured group policy, you should have:

- Policy plan business objects defined in the application
- Price items defined in the application

Procedure

To define a plan for a fully-insured group policy:

1. Search for the fully-insured group policy in the **Policy** screen.
2. In the **Search Results** section, click the link in the **Policy Information** column corresponding to the policy for which you want to define a plan.

The **Policy** screen appears.

3. Click the **Plan** tab.

The **Plan** tab appears.

4. Click the **Add** link in the upper right corner of the **Plans** zone.

The **Select Business Object** screen appears. It contains the following field:

Field Name	Field Description	Mandatory (Yes or No)
Policy Plan Business Object	Used to indicate the business object using which you want to create a plan for a fully-insured group policy.	Yes

Tip: Alternatively, you can access this screen by clicking the **Add** link in the upper right corner of the **Policy Plan** zone in the **Policy Plan** screen.

Note: The **Select Business Object** screen appears when there are multiple policy plan business objects defined in the application. If there is only one policy plan business object defined in the application, the **Plan** screen appears.

5. Select the required policy plan business object from the respective field.
6. Click **OK**.

The **Policy Plan** screen appears. It contains the following sections:

- **Main** - Used to specify the basic details about the policy plan.
- **Pricing Rule Types** - Used to associate the pricing rule types with the policy plan.
- **Proration Rules** - Used to define the proration rules for the policy plan.
- **Characteristics** - Used to define the characteristics for the policy plan.

The **Main** section contains the following fields:

Field Name	Field Description	Mandatory (Yes or No)
Policy Information	Indicates the fully-insured group policy for which you want to create the policy plan.	Not applicable
Price Item	Used to indicate the price item which you want to directly associate with the policy plan.	Yes (Conditional)
	<p>Note:</p> <p>The Search (🔍) icon appears corresponding to this field. On clicking the Search icon, the Price Item Search window appears.</p> <p>On specifying the price item, the description of the price item appears corresponding to the Price Item field.</p>	<p>Note: You must either specify the price item or associate at least one pricing rule type with the policy plan.</p>
Plan Number	Used to specify the plan number.	Yes
Plan Name	Used to specify the description for the policy plan.	No
Benefit Type	Used to indicate the type of health insurance plan. The valid values are: <ul style="list-style-type: none"> • Commercial • Medicare Affiliated 	No
Start Date	Used to specify the date from when the policy plan is effective.	Yes
	<p>Note:</p> <p>The policy plan start date cannot be earlier than the policy start date and later than the policy end date.</p> <p>The policy plan start date cannot be later than the policy plan end date.</p>	
End Date	Used to specify the date till when the policy plan is effective.	No
	<p>Note:</p> <p>The policy plan end date cannot be earlier than the policy start date and later than the policy end date.</p> <p>The policy plan end date cannot be earlier than the policy plan start date.</p>	

- Enter the required details in the **Main** section.
- Associate the pricing rule types with the fully-insured group policy plan, if required.

Note: You must associate at least one pricing rule type with the policy plan when the price item is not specified in the fully-insured group policy plan.

- Define the proration rules for the fully-insured group policy plan, if required.
- Define the characteristics for the fully-insured group policy plan, if required.

11. Click Save.

The plan is defined for the fully-insured group policy.

Related Topics

For more information on...	See...
How to search for a fully-insured group policy	Searching for a Policy on page 307
Policy screen	Policy (Used for Viewing) on page 314
Plans zone	Plans on page 322
Policy Plan zone	Policy Plan on page 347
How to associate a pricing rule type with a fully-insured group policy plan	Associating a Pricing Rule Type with a Fully-Insured Group Policy Plan on page 341
How to define a proration rule for a fully-insured group policy plan	Defining a Proration Rule for a Fully-Insured Group Policy Plan on page 338
How to define a characteristic for a fully-insured group policy plan	Defining a Characteristic for a Fully-Insured Group Policy Plan on page 342

Defining a Proration Rule for a Fully-Insured Group Policy Plan**Procedure**

To define a proration rule for a fully-insured group policy plan:

1. Ensure that the **Proration Rules** section is expanded when you are defining or editing a fully-insured group policy plan.

The **Proration Rules** section contains the following fields in a grid:

Field Name	Field Description	Mandatory (Yes or No)
Effective Date	Used to specify the date from when the proration rule is effective for the policy plan.	Yes (Conditional)
	<p>Note:</p> <p>The system considers the latest proration rule and not the effective proration rule while prorating the membership premium.</p> <p>The effective date cannot be earlier than the plan start date and later than the plan end date.</p>	<p>Note: This field is required when you are defining a proration rule for the policy plan.</p>

Field Name	Field Description	Mandatory (Yes or No)
Proration Event Type	Used to indicate the event when you want to prorate the membership premium. The valid values are: <ul style="list-style-type: none"> • Enrollment – Used when you want to prorate the membership premium on enrolling a member person. • Termination - Used when you want to prorate the membership premium on terminating a member person. • New Born - Used when you want to prorate the membership premium on enrolling a new born. • Same Month Enrollment and Termination - Used when you want to prorate the membership premium on enrolling and terminating a member person in the same month. 	Yes (Conditional)
		Note: This field is required when you are defining a proration rule for the policy plan.

Field Name	Field Description	Mandatory (Yes or No)
Proration Type	<p>Used to indicate how you want to prorate the membership premium. The valid values are:</p> <ul style="list-style-type: none"> • Daily – Used when you want to prorate the membership premium from the day the proration event has occurred. • Mid-Month – Used when you want to prorate the membership premium based on the proration date. The system calculates the proration date using the following formula: <div style="border: 1px solid black; padding: 2px; margin: 5px 0;"> $\text{Bill Period Start Date} + \text{Specified Number of Days}$ </div> For example, if the bill period start date is 1st of every month and number of days is 15, then the proration date would be 15th of every month. If a member person is enrolled to the membership on or before the proration date, the system will charge the premium for the member person. However, if a member person is enrolled to the membership after the proration date, the system will not charge the premium for the member person. And, if a member person is terminated from the membership on or after the proration date, the system will charge the premium for the member person. However, if a member person is terminated from the membership before the proration date, the system will not charge the premium for the member person. • Full Month – Used when the premium for a member person should be charged when the member person is enrolled or terminated on the coverage start date or coverage end date, respectively. If a member person is enrolled or terminated within the coverage period, the system will not charge the premium for the member person. • Waiver – Used when the premium for a member person should be waived off completely for the month when the member person is enrolled or terminated from the membership. • Coverage Days – Used when you want to prorate the premium for a member person based on the coverage days. If a member person is covered in the membership for a period less than the specified number of days, the system will not charge the premium for the member person. However, if a member person is covered in the membership for a period equal to or more than the specified number of days, the system will charge the premium for the member person. <div style="border: 1px solid black; padding: 5px; margin-top: 10px;"> <p>Note: You can use this proration type when the proration event is set to Same Month Enrollment and Termination.</p> </div>	<p>Yes (Conditional)</p> <div style="border: 1px solid black; padding: 5px; margin-top: 5px;"> <p>Note: This field is required when you are defining a proration rule for the policy plan.</p> </div>

Field Name	Field Description	Mandatory (Yes or No)
Number of Days	Used to specify the number of days to determine the cutoff date.	Yes (Conditional)
		Note: This field is required when the proration type is set to Mid-Month or Coverage Days .

- Enter the required details in the **Proration Rules** section.
- If you want to define more than one proration rule for the fully-insured group policy plan, click the **Add (+)** icon and then repeat step 2.

Note: However, if you want to remove a proration rule of the fully-insured group policy plan, click the **Delete** (🗑️) icon corresponding to the proration rule.

- Click **Save**.

The proration rules are defined for the fully-insured group policy plan.

Related Topics

For more information on...	See...
How to define a plan for a fully-insured group policy	Defining a Plan for a Fully-Insured Group Policy
How to edit a plan of a fully-insured group policy	Editing a Plan of a Fully-Insured Group Policy on page 343

Associating a Pricing Rule Type with a Fully-Insured Group Policy Plan

You can define a pricing rule using a pricing rule type for a fully-insured group policy plan when the pricing rule type is associated with the fully-insured group policy plan. You can associate a pricing rule type with a fully-insured group policy plan either from the user interface or through a health care inbound message.

Prerequisites

To associate a pricing rule type with a fully-insured group policy plan, you should have:

- Pricing rule types defined in the application (where the pricing rule type category is set to **Age Based**, **Tier Based**, or **Pass-Through Billable Charge**)

Procedure

To associate a pricing rule type with a fully-insured group policy plan:

- Ensure that the **Pricing Rule Types** section is expanded when you are defining or editing a fully-insured group policy plan.

The **Pricing Rule Types** section contains the following field in a grid:

Field Name	Field Description	Mandatory (Yes or No)
Pricing Rule Type	Used to indicate the pricing rule type that you want to associate with the fully-insured group policy plan.	Yes (Conditional)
	<p>Note:</p> <p>The Search (🔍) icon appears corresponding to this field. On clicking the Search icon, the Pricing Rule Type Search window appears.</p> <p>On specifying the pricing rule type, the description of the pricing rule type appears corresponding to the Pricing Rule Type field.</p> <p>Here, you can only specify a pricing rule type where the pricing rule type category is set to Age Based, Tier Based, or Pass-Through Billable Charge.</p>	<p>Note: You must either specify the price item or associate at least one pricing rule type with the policy plan.</p>

- Enter the required details in the **Pricing Rule Types** section.
- If you want to associate more than one pricing rule type with the fully-insured group policy plan, click the **Add** (+) icon and then repeat step 2.

Note: However, if you want to dissociate a pricing rule type from the fully-insured group policy plan, click the **Delete** (🗑) icon corresponding to the pricing rule type.

- Click **Save**.

The pricing rule types are associated with the fully-insured group policy plan.

Related Topics

For more information on...	See...
How to define a plan for a fully-insured group policy	Defining a Plan for a Fully-Insured Group Policy
How to edit a plan of a fully-insured group policy	Editing a Plan of a Fully-Insured Group Policy on page 343

Defining a Characteristic for a Fully-Insured Group Policy Plan

Prerequisites

To define a characteristic for a fully-insured group policy plan, you should have:

- Characteristic types defined in the application (where the characteristic entity is set to **Policy Plan**).

Procedure

To define a characteristic for a fully-insured group policy plan:

- Ensure that the **Characteristics** section is expanded when you are defining or editing a fully-insured group policy plan.

The **Characteristics** section contains the following fields in a grid:

Field Name	Field Description	Mandatory (Yes or No)
Effective Date	Used to specify the date from when the characteristic is effective for the fully-insured group policy plan.	Yes (Conditional)
	Note: The effective date cannot be earlier than the policy plan start date and later than the policy plan end date.	Note: This field is required when you are defining a characteristic for the fully-insured group policy plan.
Characteristic Type	Used to indicate the characteristic type.	Yes (Conditional)
	Note: The list includes only those characteristic types where the characteristic entity is set to Policy Plan .	Note: This field is required when you are defining a characteristic for the fully-insured group policy plan.
Characteristic Value	Used to specify the value for the characteristic type.	Yes (Conditional)
	<p>Note:</p> <p>If you select a predefined characteristic type, the Search (🔍) icon appears corresponding to the Characteristic Value field. On clicking the Search icon, the Predefined Characteristic Search window appears.</p> <p>On specifying the value for a predefined characteristic type, the description of the characteristic value appears corresponding to the Characteristic Value field.</p>	Note: This field is required when you are defining a characteristic for the fully-insured group policy plan.

- Enter the required details in the **Characteristics** section.
- If you want to define more than one characteristic for the fully-insured group policy plan, click the **Add** (+) icon and then repeat step 2.

Note: However, if you want to remove a characteristic from the fully-insured group policy plan, click the **Delete** (🗑️) icon corresponding to the characteristic.

- Click **Save**.

The characteristics are defined for the fully-insured group policy plan.

Related Topics

For more information on...	See...
How to define a plan for a fully-insured group policy	Defining a Plan for a Fully-Insured Group Policy
How to edit a plan of a fully-insured group policy	Editing a Plan of a Fully-Insured Group Policy on page 343

Editing a Plan of a Fully-Insured Group Policy

Prerequisites

To edit a plan of a fully-insured group policy, you should have:

- Price items defined in the application

Procedure

To edit a plan of a fully-insured group policy:

1. Search for the fully-insured group policy in the **Policy** screen.
2. In the **Search Results** section, click the link in the **Policy Information** column corresponding to the policy whose details you want to edit.

The **Policy** screen appears.

3. Click the **Plan** tab.

The **Plan** tab appears.

4. In the **Plans** zone, click the **Edit** (✎) icon in the **Edit** column corresponding to the policy plan whose details you want to edit.

The **Policy Plan** screen appears. It contains the following sections:

- **Main** - Used to specify the basic details about the fully-insured group policy plan.
- **Pricing Rule Types** - Used to associate the pricing rule types with the fully-insured group policy plan.
- **Proration Rules** - Used to define the proration rules for the fully-insured group policy plan.
- **Characteristics** - Used to define the characteristics for the fully-insured group policy plan.

The **Main** section contains the following fields:

Field Name	Field Description	Mandatory (Yes or No)
Plan Information	Displays information about the fully-insured group policy plan.	Not applicable
Policy Information	Indicates the fully-insured group policy for which the policy plan is created.	Not applicable
Price Item	Used to indicate the price item which you want to directly associate with the fully-insured group policy plan.	Yes (Conditional)
	<p>Note:</p> <p>The Search (🔍) icon appears corresponding to this field. On clicking the Search icon, the Price Item Search window appears.</p> <p>On specifying the price item, the description of the price item appears corresponding to the Price Item field.</p>	<p>Note: You must either specify the price item or associate at least one pricing rule type with the policy plan.</p>
Plan Number	Used to specify the plan number.	Yes
Plan Name	Used to specify the description for the fully-insured group policy plan.	No
Benefit Type	Used to indicate the type of health insurance plan. The valid values are: <ul style="list-style-type: none"> • Commercial • Medicare Affiliated 	No

Field Name	Field Description	Mandatory (Yes or No)
Start Date	Used to specify the date from when the fully-insured group policy plan is effective.	Yes
	Note: The fully-insured group policy plan start date cannot be earlier than the policy start date and later than the policy end date. The fully-insured group policy plan start date cannot be later than the policy plan end date.	
End Date	Used to specify the date till when the fully-insured group policy plan is effective.	No
	Note: The fully-insured group policy plan end date cannot be earlier than the policy start date and later than the policy end date. The fully-insured group policy plan end date cannot be earlier than the policy plan start date.	

Tip: Alternatively, you can edit the details of a fully-insured group policy plan by clicking the **Edit** button in the **Policy Plan** zone of the **Policy Plan** screen.

- Modify the required details in the **Main** section.
- Associate the pricing rule types with the fully-insured group policy plan, if required.

Note: You must associate at least one pricing rule type with the policy plan when the price item is not specified in the fully-insured group policy plan.

- Define, edit, or remove the proration rules of the fully-insured group policy plan, if required.
- Define, edit, or remove characteristics of the fully-insured group policy plan, if required.
- Click **Save**.

The changes made to the fully-insured group policy plan are saved.

Related Topics

For more information on...	See...
How to search for a fully-insured group policy	Searching for a Policy on page 307
Policy screen	Policy (Used for Viewing) on page 314
Plans zone	Plans on page 322
Policy Plan screen	Policy Plan (Used for Viewing) on page 347
Policy Plan zone	Policy Plan on page 347
How to associate a pricing rule type with a fully-insured group policy plan	Associating a Pricing Rule Type with a Fully-Insured Group Policy Plan on page 341

For more information on...	See...
How to define a proration rule for a fully-insured group policy plan	Defining a Proration Rule for a Fully-Insured Group Policy Plan on page 338
How to define a characteristic for a fully-insured group policy plan	Defining a Characteristic for a Fully-Insured Group Policy Plan on page 342

Viewing the Log of a Policy

Procedure

To view the log of a policy:

1. Search for the policy in the **Policy** screen.
2. In the **Search Results** section, click the link in the **Policy Information** column corresponding to the policy whose details you want to view.
The **Policy** screen appears.
3. Click the **Log** tab.
The **Log** tab appears.
4. View the complete trail of actions performed on the policy in the **Policy Log** zone.

Related Topics

For more information on...	See...
How to search for a policy	Searching for a Policy on page 307
Policy screen	Policy (Used for Viewing) on page 314
Policy Log zone	Policy Log on page 324
How to add a log entry for a policy	Adding a Log Entry for a Policy on page 346

Adding a Log Entry for a Policy

Procedure

To add a log entry for a policy:

1. Search for the policy in the **Policy** screen.
2. In the **Search Results** section, click the link in the **Policy Information** column corresponding to the policy for which you want to add a log entry.
The **Policy** screen appears.
3. Click the **Log** tab.
The **Log** tab appears.
4. Click the **Add Log Entry** link in the upper right corner of the **Policy Log** zone.

The **Add Policy Log** window appears. It contains the following fields:

Field Name	Field Description	Mandatory (Yes or No)
Policy Information	Displays information about the policy.	Not applicable

Field Name	Field Description	Mandatory (Yes or No)
Log Details	Used to specify additional comments for the policy.	Yes

- Enter the comments in the **Log Details** field.
- Click **Save**.

The log entry is added in the **Policy Log** zone.

Related Topics

For more information on...	See...
How to search for a policy	Searching for a Policy on page 307
Policy screen	Policy (Used for Viewing) on page 314
Policy Log zone	Policy Log on page 324

Policy Plan (Used for Viewing)

The **Policy Plan** screen allows you to:

- View the details of a fully-insured group policy plan
- View the characteristics of a fully-insured group policy plan
- Add and edit a fully-insured group policy plan
- Add a membership to a fully-insured group policy plan

It contains the following zones:

- [Policy Plan](#) on page 347
- [Plan Characteristics](#) on page 349
- [Memberships](#) on page 323

Policy Plan

The **Policy Plan** zone displays the details of the policy plan. It contains the following sections:

- Main** - Displays the basic information about the policy plan. It contains the following fields:

Field Name	Field Description
Plan Information	Displays information about the policy plan.
Policy Information	Displays information about the policy. Note: It has a link. On clicking the link, the Policy screen appears where you can view the details of the respective policy.
Price Item Information	Indicates the price item to which the policy plan is directly associated. Note: It has a link. On clicking the link, the Price Item screen appears where you can view the details of the respective price item.
Plan Number	Displays the plan number.
Plan Name	Displays the description of the policy plan.

Field Name	Field Description
Benefit Type	Indicates the type of health insurance plan. The valid values are: <ul style="list-style-type: none"> • Commercial • Medicare Affiliated
	Note: This field appears when the benefit type is set to COBRA or Medicare Affiliated .
Start Date	Displays the date from when the policy plan is effective.
End Date	Displays the date till when the policy plan is effective.

- **Pricing Rule Types** - Lists the pricing rule types which are associated with the policy plan. It contains the following column:

Column Name	Column Description
Pricing Rule Type	Indicates the pricing rule type which is associated with the policy plan.
	Note: It has a link. On clicking the link, the Pricing Rule Type screen appears where you can view the details of the respective pricing rule type.

- **Record Actions** - This section contains the following buttons:

Button Name	Button Description
Edit	Used to edit the details of the policy plan.

- **Record Information** - This section contains the following field:

Field Name	Field Description
Business Object	Indicates the business object using which the policy plan is created. In addition, a context menu appears corresponding to this field which helps in navigating to other screens in the application.
	Note: It has a link. On clicking the link, the Business Object screen appears where you can view the details of the respective business object.

- **Proration Rules** - Lists the proration rules defined for the policy plan. It contains the following columns:

Column Name	Column Description
Effective Date	Displays the date from when the proration rule is effective for the policy plan.
Proration Event Type	Indicates the event when the membership premium should be prorated. The valid values are: <ul style="list-style-type: none"> • Enrollment • Termination • New Born • Same Month Enrollment and Termination

Column Name	Column Description
Proration Type	Indicates how the membership premium should be prorated. The valid values are: <ul style="list-style-type: none"> • Daily • Mid-Month • Full Month • Waiver • Coverage Days • Enrollment • Termination
Number of Days	Displays the number of days using which the cutoff date is calculated.
	Note: The data appears in this column when the proration type is set to Mid-Month or Coverage Days .
Membership Type	Indicates the type of membership. The valid values are: <ul style="list-style-type: none"> • COBRA • Medicare • Retiree

You can define a new policy plan by clicking the **Add** link in the upper right corner of this zone.

Related Topics

For more information on...	See...
How to define a plan for a fully-insured group policy	Defining a Plan for a Fully-Insured Group Policy
How to edit a plan of a fully-insured group policy	Editing a Plan of a Fully-Insured Group Policy on page 343

Plan Characteristics

The **Plan Characteristics** zone lists the characteristics of the fully-insured group policy plan. It contains the following columns:

Column Name	Column Description
Effective Date	Displays the date from when the characteristic is effective for the policy plan.
Characteristic Type	Indicates the characteristic type.
Characteristic Value	Displays the value of the characteristic type.
Description	Displays the description of the characteristic value.
	Note: The data appears in this column when the type of characteristic value is set to Predefined Value .

You can filter the list using the **Effective Date** field available in the **Filter** area. By default, the **Filter** area is hidden. You can view the **Filter** area by clicking the **Filters** (∨) icon in the upper right corner of this zone.

Memberships

The **Memberships** zone lists the memberships which are defined for the policy plan. It contains the following columns:

Column Name	Column Description
Start Date	Displays the date from when the membership is effective.
End Date	Displays the date till when the membership is effective.
Membership Information	Displays information about the membership.
	Note: It has a link. On clicking the link, the Membership screen appears where you can view the details of the respective membership.
Enrolled Members	Displays the number of members who have enrolled in the policy plan.
Status	Indicates the status of the membership. The valid values are: <ul style="list-style-type: none"> • Active • Inactive • Terminated
Membership Type	Indicates the type of membership. The valid values are: <ul style="list-style-type: none"> • COBRA • Medicare • Retiree
Benefits	On clicking the Benefits () icon, the Benefit screen appears where you can view the Medicare benefits of the member persons who belong to the membership.
	Note: The Benefits icon appears when a Medicare benefit is defined for a member person who belongs to the membership.
Membership ID	Displays the membership ID.

Note: Pagination is used to display limited number of records in this zone. You can use the navigation links, such as **Previous** and **Next** to navigate between pages.

You can define a new membership by clicking the **Add** link in the upper right corner of this zone.

By default, the **Memberships** zone does not appear in the **Plan** tab. It appears when you click the **Broadcast** () icon corresponding to the policy plan in the **Plans** zone.

You can filter the list using various search criteria (such as, **External Membership ID**, **Effective From**, **Person Name**, **Effective Till**, and **Status**) available in the **Filter** area. By default, the **Filter** area is hidden. You can view the **Filter** area by clicking the **Filters** () icon in the upper right corner of this zone.

You can change the layout of this zone. For more information on how to change the layout, see [Changing the Layout](#) on page 3414

Related Topics

For more information on...	See...
How to define a membership for a fully-insured group policy plan	Defining a Membership for a Fully-Insured Group Policy Plan on page 359

Membership (Used for Searching)

The **Membership** screen allows you to search for an individual or group membership using various search criteria. It also allows you to define an individual or group membership. It contains the following zone:

- [Search Membership](#) on page 351

Through this screen, you can navigate to the following screen:

- [Membership \(Used for Viewing\)](#) on page 363

Search Membership

The **Search Membership** zone allows you to search for an individual or group membership using various search criteria. It contains the following two sections:

- **Search Criteria** - The **Search Criteria** section contains the following fields:

Field Name	Field Description	Mandatory (Yes or No)
Search By	Used to indicate whether you want to search for a membership using the policy plan, membership, or member person details. The valid values are: <ul style="list-style-type: none"> • Membership Details • Policy Plan Details • Person Details • Health Plan Details 	Yes
	Note: By default, Membership Details option is selected.	
Membership ID	Used to search a particular membership.	No
	Note: This field appears when the Membership Details option is selected from the Search By list.	
External Membership ID	Used to search a membership with a particular external membership ID.	No
	Note: This field appears when the Membership Details option is selected from the Search By list.	
Start Date	Used to search memberships which are effective from a particular date.	No
	Note: This field appears when the Membership Details option is selected from the Search By list.	

Field Name	Field Description	Mandatory (Yes or No)
End Date	Used to search memberships which are effective till a particular date.	No
	Note: This field appears when the Membership Details option is selected from the Search By list.	
Status	Used to search memberships with a particular status. The valid values are: <ul style="list-style-type: none"> • Active • Inactive • Terminated 	No
	Note: This field appears when the Membership Details option is selected from the Search By list.	
Membership Type	Used to search memberships of a particular type. The valid values are: <ul style="list-style-type: none"> • COBRA • Medicare 	No
	Note: If you want to search for an active employee coverage membership, you must leave this field blank. This field appears when the Membership Details or Policy Plan Details or Person Details , or Health Plan Details option is selected from the Search By list.	
Benefit Type	Used to search memberships where a member person has availed for a particular type of benefit. The valid values are: <ul style="list-style-type: none"> • Commercial • Medicare Affiliated 	No
	Note: This field appears when the Membership Details or Person Details option is selected from the Search By list.	
Benefit Sub Type	Used to search memberships where a member person has availed for a particular Medicare benefit.	No
	Note: This field appears when the Membership Details or Person Details option is selected from the Search By list. The list includes only those benefit types which are defined through the Benefit Sub Type screen.	

Field Name	Field Description	Mandatory (Yes or No)
Membership Identifier Type	Used to search memberships which are associated with a membership identifier type.	Yes (Conditional)
	<p>Note:</p> <p>This field appears when the Membership Details option is selected from the Search By list.</p> <p>You can only search individual memberships, if you are specifying the membership identifier type.</p>	<p>Note: This field is required when you are searching for a membership using a membership identifier type.</p>
Membership Identifier	Used to search memberships with a particular identifier.	Yes (Conditional)
	<p>Note:</p> <p>This field appears when the Membership Details option is selected from the Search By list.</p> <p>You can only search individual memberships, if you are specifying the membership identifier.</p>	<p>Note: This field is required when you are searching for a membership using a membership identifier.</p>
Characteristic Type	Used to search memberships for which a particular characteristic type is defined.	Yes (Conditional)
	<p>Note:</p> <p>This field appears when the Membership Details or Person Details option is selected from the Search By list.</p> <p>The list includes only those characteristic types where the characteristic entity is set to Membership.</p>	<p>Note: This field is required when you are searching for a membership using a characteristic.</p>
Characteristic Value	Used to search memberships with a particular characteristic value.	Yes (Conditional)
	<p>Note:</p> <p>This field appears when the characteristic type is selected.</p> <p>If you select a predefined characteristic type, the Search  icon appears corresponding to the Characteristic Value field. On clicking the Search icon, the Predefined Characteristic Search window appears.</p> <p>On specifying the value for a predefined characteristic type, the description of the characteristic value appears corresponding to the Characteristic Value field.</p>	<p>Note: This field is required when you are searching for a membership using a characteristic.</p>

Field Name	Field Description	Mandatory (Yes or No)
Policy ID	Used to search memberships which belong to plans of a particular policy.	No
	<p>Note:</p> <p>The Search (🔍) icon appears corresponding to this field. On clicking the Search icon, the Policy Search window appears.</p> <p>This field appears when the Policy Plan Details option is selected from the Search By list.</p>	
Price Item	Used to search memberships which belong to plans where a particular price item is directly associated.	No
	<p>Note:</p> <p>The Search (🔍) icon appears corresponding to this field. On clicking the Search icon, the Price Item Search window appears.</p> <p>This field appears when the Policy Plan Details or Membership Details option is selected from the Search By list.</p>	
Plan ID	Used to search memberships of a particular plan.	No
	<p>Note:</p> <p>The Search (🔍) icon appears corresponding to this field. On clicking the Search icon, the Policy Plan Search window appears.</p> <p>This field appears when the Policy Plan Details option is selected from the Search By list.</p>	
Person Name	Used to search memberships where a particular person is included as a member person.	No
	<p>Note: This field appears when the Person Details option is selected from the Search By list.</p>	
Relationship Type	Used to search memberships where the member persons are related using a particular relationship type.	No
	<p>Note:</p> <p>This field appears only when the Person Details option is selected from the Search By list.</p> <p>The list includes only those contract relationship types which are already defined in the system.</p>	
Person Identifier Type	Used to indicate the person identifier type.	No
	<p>Note: This field appears when the Person Details option is selected from the Search By list.</p>	

Field Name	Field Description	Mandatory (Yes or No)
Person Identifier	Used to search memberships in which a particular person is added.	No
	Note: This field appears when the Person Details option is selected from the Search By list.	
Health Plan	Used to search memberships associated with a health plan.	No
	Note: The Search (🔍) icon appears corresponding to this field. On clicking the Search icon, the Health Plan Search window appears. This field appears when the Health Plan Details option is selected from the Search By list. You can only search individual memberships, if you are specifying a health plan.	

Note: You must specify at least one search criterion while searching for a membership.

- **Search Results** - On clicking the **Search** button, the search results appear based on the specified search criteria. The **Search Results** section contains the following columns:

Column Name	Column Description
Membership Information	Displays information about the membership.
	Note: It has a link. On clicking the link, the Membership Information screen appears where you can view the details of the respective membership.
Policy Information	Indicates the policy of the plan to which the membership is added.
	Note: It has a link. On clicking the link, the Policy screen appears where you can view the details of the respective policy. This column appears when the Membership Details or Policy Plan Details , or Person Details option is selected from the Search By list.
Price Item Information	Indicates the price item which is directly associated with the plan to which the membership belongs.
	Note: It has a link. On clicking the link, the Price Item screen appears where you can view the details of the respective price item. This column appears when the Membership Details or Policy Plan Details , or Person Details option is selected from the Search By list.

Column Name	Column Description
Health Plan	Indicates the health plan to which the membership is associated.
	<p>Note:</p> <p>This column appears when the Membership Details or Person Details, or Health Plan Details option is selected from the Search By list.</p> <p>This column appears only when you are searching for an individual membership.</p>
Start Date	Displays the date from when the membership is effective.
End Date	Displays the date till when the membership is effective.
Status	<p>Indicates the status of the membership. The valid values are:</p> <ul style="list-style-type: none"> • Active • Inactive • Terminated
Person Information	Indicates the person who is added to the membership. In addition, this column has a context menu which helps in navigating to other screens in the application.
	<p>Note:</p> <p>It has a link. On clicking the link, the Person screen appears where you can view the details of the respective person.</p> <p>This column appears when the Person Details option is selected from the Search By list.</p>

Column Name	Column Description						
Main Subscriber	<p>This column displays different data depending on whether you search for a membership using the policy plan, membership, or person details. The following table describes this column:</p> <table border="1"> <thead> <tr> <th>If you search for a membership using...</th> <th>Then...</th> </tr> </thead> <tbody> <tr> <td>The Policy Plan Details or Membership Details option</td> <td> <p>The Main Subscriber column displays the information about the person who is the main subscriber of the membership. In addition, this column has a context menu which helps in navigating to other screens in the application.</p> <p>Note: It has a link. On clicking the link, the Person screen appears where you can view the details of the respective person.</p> </td> </tr> <tr> <td>The Person Details option</td> <td> <p>The Main Subscriber column indicates whether the person is the main subscriber of the membership. The valid values are:</p> <ul style="list-style-type: none"> • Yes • No </td> </tr> </tbody> </table>	If you search for a membership using...	Then...	The Policy Plan Details or Membership Details option	<p>The Main Subscriber column displays the information about the person who is the main subscriber of the membership. In addition, this column has a context menu which helps in navigating to other screens in the application.</p> <p>Note: It has a link. On clicking the link, the Person screen appears where you can view the details of the respective person.</p>	The Person Details option	<p>The Main Subscriber column indicates whether the person is the main subscriber of the membership. The valid values are:</p> <ul style="list-style-type: none"> • Yes • No
If you search for a membership using...	Then...						
The Policy Plan Details or Membership Details option	<p>The Main Subscriber column displays the information about the person who is the main subscriber of the membership. In addition, this column has a context menu which helps in navigating to other screens in the application.</p> <p>Note: It has a link. On clicking the link, the Person screen appears where you can view the details of the respective person.</p>						
The Person Details option	<p>The Main Subscriber column indicates whether the person is the main subscriber of the membership. The valid values are:</p> <ul style="list-style-type: none"> • Yes • No 						
Membership Type	<p>Indicates the type of membership. The valid values are:</p> <ul style="list-style-type: none"> • COBRA • Medicare 						
Benefits	<p>On clicking the Benefits (🔗) icon, the Benefit screen appears where you can view the Medicare benefits of the member persons who belong to the membership.</p> <p>Note: The Benefits icon appears when a Medicare benefit is defined for a member person who belongs to the membership.</p>						

Note: Pagination is used to display limited number of records in the **Search Results** section. You can use the navigation links, such as **Previous** and **Next** to navigate between pages.

Related Topics

For more information on...	See...
How to search for a membership	Searching for a Membership on page 357
How to view the details of a membership	Viewing the Membership Details on page 358

Searching for a Membership

Prerequisites

To search for a membership, you should have:

- Membership types, membership identifier, and membership identifier types defined in the application
- Health plan defined in the application

Note: You must define a health plan only when you want to search individual memberships.

- Benefit types and benefit sub types defined in the application
- Person, person identifier, and person identifier types defined in the application
- Price item, policy, and policy plan defined in the application
- Contract relationship types defined in the application
- Characteristic types defined in the application (where the characteristic entity is set to **Membership**)

Procedure

To search for a membership:

1. Click the **Menu** link in the **Application** toolbar.
A list appears.
2. From the **Main** menu, select **Customer Management** and then click **Membership**.
A sub-menu appears.
3. Click the **Search** option from the **Membership** sub-menu
The **Membership** screen appears.
4. Enter the search criteria in the **Search Membership** zone.

Note: ORMB search engine supports wildcard search, where you can substitute the percentage (%) symbol as a stand in for any word or letter in a search criteria. You can use the ‘%’ wildcard character in all input fields except the date and ID fields. The ‘%’ wildcard character is suffixed automatically at the end of the partial search criteria. Therefore, you may or may not specify the wildcard character at the end of the partial search criteria. However, you have to prefix the wildcard character manually wherever required.

5. Click **Search**.

A list of memberships that meet the search criteria appears in the **Search Results** section.

Related Topics

For more information on...	See...
Membership screen	Membership (Used for Searching) on page 351
Search Membership zone	Search Membership on page 351

Viewing the Membership Details

Procedure

To view the details of a membership:

1. Search for the membership in the **Membership** screen.
2. In the **Search Results** section, click the link in the **Membership Information** column corresponding to the membership whose details you want to view.
The **Membership** screen appears.
3. Ensure that the **Main** tab is selected.
4. View the details of the membership in the **Membership** zone.

Related Topics

For more information on...	
How to search for a membership	Searching for a Membership on page 357
Membership screen	Membership (Used for Viewing) on page 363
Membership zone	Membership on page 363

Defining a Membership for a Fully-Insured Group Policy Plan**Prerequisites**

To define a membership for a fully-insured group policy plan, you should have:

- Plans defined in the policy
- Persons defined in the application
- Contract relationship types defined in the application

Procedure

To define a membership for a fully-insured group policy plan:

1. Do either of the following:

If you want to...	Then...
Define a membership for a fully-insured group policy plan from the Policy screen	<ol style="list-style-type: none"> 1. Search for the fully-insured group policy in the Policy screen. 2. In the Search Results section, click the link in the Policy Information column corresponding to the policy whose details you want to edit. The Policy screen appears. 3. Click the Plan tab. The Plan tab appears. 4. In the Plans zone, click the Broadcast (📡) icon corresponding to the policy plan for which you want to define a membership. The Memberships zone appears. 5. Click the Add link in the upper right corner of the Memberships zone.
Define a membership for a fully-insured group policy plan from the Membership screen	<ol style="list-style-type: none"> 1. Click the Menu link in the Application toolbar. A list appears. 2. From the Main menu, select Customer Management and then click Membership. A sub menu appears. 3. Click the Add option from the Membership sub-menu.

The **Membership** screen appears. It contains the following sections:

- **Main** - Used to specify the basic details about the membership.
- **Characteristics** - Used to define the characteristics for the membership.

The **Main** section contains the following fields:

Field Name	Field Description	Mandatory (Yes or No)
Plan ID	<p>Used to indicate the policy plan for which you want to define the membership.</p> <p>Note:</p> <p>The Search (🔍) icon appears corresponding to this field. On clicking the Search icon, the Policy Plan Search window appears.</p> <p>On specifying the policy plan, the description of the policy plan appears corresponding to the Plan field.</p> <p>If you navigate to the Membership screen from the Policy screen, the data automatically appears in this field. You can change the plan, if required.</p>	Yes
Start Date	<p>Used to specify the date from when the membership is effective for a fully-insured group policy plan.</p> <p>Note:</p> <p>The membership start date cannot be later than the membership end date.</p> <p>The membership start date cannot be earlier than the policy plan start date or later than policy plan end date.</p>	Yes
End Date	<p>Used to specify the date till when the membership is effective for a fully-insured group policy plan.</p> <p>Note:</p> <p>The membership end date cannot be earlier than the membership start date.</p> <p>The membership end date cannot be earlier than the policy plan start date or later than policy plan end date.</p>	Yes
Membership Type	<p>Used to indicate the type of membership. The valid values are:</p> <ul style="list-style-type: none"> • COBRA • Medicare <p>Note: If you want to define an active employee coverage membership, you must leave this field blank.</p>	No

Field Name	Field Description	Mandatory (Yes or No)
Main Subscriber	Used to indicate the person who is the main subscriber of the membership.	Yes
	Note: The Search (🔍) icon appears corresponding to this field. On clicking the Search icon, the Person Search window appears. On specifying the person, the description of the person appears corresponding to the Main Subscriber field.	
Relationship Type	Used to indicate how the main subscriber is related to the membership.	Yes
External Membership ID	Used to specify the external membership ID.	No
	Note: Here, you need to specify a membership ID which is maintained in the external source system.	

Tip: Alternatively, you can access this screen by clicking the **Add** button in the **Page Title** area of the **Membership** screen.

2. Enter the required details in the **Main** section.
3. Define characteristics for the membership, if required.
4. Click **Save**.

The membership is defined for the fully-insured group policy plan. The status of the membership and the main subscriber is set to **Active**.

Related Topics

For more information on...	See...
How to search for a fully-insured group policy	Searching for a Policy on page 307
Policy screen	Policy (Used for Viewing) on page 314
Plans zone	Plans on page 322
Memberships zone	Memberships on page 323
Membership screen	Membership (Used for Searching) on page 351
How to define a characteristic for a membership	Defining a Characteristic for a Membership on page 361

Defining a Characteristic for a Membership

Prerequisites

To define a characteristic for a membership, you should have:

- Characteristic types defined in the application (where the characteristic entity is set to **Membership**)

Procedure

To define a characteristic for a membership:

1. Ensure that the **Characteristics** section is expanded when you are defining or editing a membership.

The **Characteristics** section contains the following fields in a grid:

Field Name	Field Description	Mandatory (Yes or No)
Effective Date	Used to specify the date from when the characteristic is effective for the membership.	Yes (Conditional)
	Note: The effective date cannot be earlier than the membership start date and later than the membership end date.	Note: This field is required when you are defining a characteristic for the membership.
Characteristic Type	Used to indicate the characteristic type.	Yes (Conditional)
	Note: The list includes only those characteristic types where the characteristic entity is set to Membership	Note: This field is required when you are defining a characteristic for the membership.
Characteristic Value	Used to specify the value for the characteristic type.	Yes (Conditional)
	<p>Note:</p> <p>If you select a predefined characteristic type, the Search (🔍) icon appears corresponding to the Characteristic Value field. On clicking the Search icon, the Predefined Characteristic Search window appears.</p> <p>On specifying the value for a predefined characteristic type, the description of the characteristic value appears corresponding to the Characteristic Value field.</p>	Note: This field is required when you are defining a characteristic for the membership.

2. Enter the required details in the **Characteristics** section.
3. If you want to define more than one characteristic for the membership, click the **Add** (+) icon and then repeat step 2.

Note: However, if you want to remove a characteristic from the membership, click the **Delete** (🗑️) icon corresponding to the characteristic.

4. Click **Save**.

The characteristics are defined for the membership.

Related Topics

For more information on...	See...
How to define a membership for a fully-insured group policy plan	Defining a Membership for a Fully-Insured Group Policy Plan on page 359
How to edit a membership of a fully-insured group policy plan	Editing a Membership of a Fully-Insured Group Policy Plan on page 376

Membership (Used for Viewing)

The **Membership** screen allows you to:

- View the details of a membership
- Edit the details of a membership
- Inactivate a membership
- Inactivate a member person
- Add or remove a person from a membership
- View the other plans of the main subscriber
- Associate or disassociate a contract from a membership
- View the billable charges created for a membership
- View the bill segments generated for a membership billable charge
- View the timeline details of a membership billable charge
- Viewing the pricing calculation details of a timeline
- View the log of a membership
- Add a log entry for a membership

It consists of the following tabs:

- [Membership - Main](#) on page 363
- [Membership - Contracts and Charges](#) on page 369
- [Membership - Log](#) on page 375

Membership - Main

The **Main** tab displays information about the membership. It also lists the persons which are included in the membership and other plans (within or across policies) where the main subscriber is associated. It contains the following zones:

- [Membership](#) on page 363
- [Membership Characteristics](#) on page 366
- [Member Persons](#) on page 366
- [Member Person Characteristics](#) on page 368
- [Other Plans of Main Subscriber](#) on page 368

Membership

The **Membership** zone displays the details of the membership. It contains the following sections:

- **Main** - Displays basic information about the membership. It contains the following fields:

Field Name	Field Description
Membership Information	Displays information about the membership.

Field Name	Field Description
Policy Information	Displays information about the policy.
	Note: It has a link. On clicking the link, the Policy screen appears where you can view the details of the policy.
Plan Information	Indicates the policy plan for which the membership is defined.
	Note: It has a link. On clicking the link, the Policy Plan screen appears where you can view the details of the respective policy plan.
Status	Indicates the status of the membership. The valid values are: <ul style="list-style-type: none"> • Active • Inactive • Terminated
Start Date	Displays the date from when the membership is effective.
End Date	Displays the date till when the membership is effective.
Membership Type	Indicates the type of membership. The valid values are: <ul style="list-style-type: none"> • COBRA • Medicare
External Membership ID	Displays the corresponding membership ID which is maintained in the external source system.

Field Name	Field Description																																													
Paid Through Date	<p data-bbox="570 205 1466 268">Indicates the term end date of the last fully or partially paid term. The system considers the term to be fully paid when the threshold limit is met.</p> <p data-bbox="570 296 1466 327">Note:</p> <p data-bbox="570 344 1466 375">This field appears when the paid through date is calculated at the membership level.</p> <p data-bbox="570 392 1466 485">The paid through date is calculated while freezing or canceling a payment or adjustment depending on whether the required algorithm is attached to the respective system event:</p> <table border="1" data-bbox="570 506 1466 762"> <thead> <tr> <th data-bbox="578 512 829 560">Entity</th> <th data-bbox="829 512 1167 560">System Event</th> <th data-bbox="1167 512 1466 560">Algorithm</th> </tr> </thead> <tbody> <tr> <td data-bbox="578 560 829 609">Customer Class</td> <td data-bbox="829 560 1167 609">Payment Freeze</td> <td data-bbox="1167 560 1466 609">C1-PSPTDCAL</td> </tr> <tr> <td data-bbox="578 609 829 657">Customer Class</td> <td data-bbox="829 609 1167 657">Payment Cancellation</td> <td data-bbox="1167 609 1466 657">C1-PXPTDCAL</td> </tr> <tr> <td data-bbox="578 657 829 705">Adjustment Type</td> <td data-bbox="829 657 1167 705">Adjustment Freeze</td> <td data-bbox="1167 657 1466 705">C1-ADPTDCAL</td> </tr> <tr> <td data-bbox="578 705 829 753">Adjustment Type</td> <td data-bbox="829 705 1167 753">Adjustment Cancellation</td> <td data-bbox="1167 705 1466 753">C1-AXPTDCAL</td> </tr> </tbody> </table> <p data-bbox="570 779 1466 842">The following table indicates when the paid through date is calculated at the policy and/or membership level:</p> <table border="1" data-bbox="570 863 1466 1881"> <thead> <tr> <th data-bbox="578 869 794 1041">If the Paid Through Date Calculation Level parameter is set to...</th> <th data-bbox="794 869 1109 1041">If the following characteristics are defined for the bill charge or adjustment...</th> <th data-bbox="1109 869 1466 1041">Then...</th> </tr> </thead> <tbody> <tr> <td data-bbox="578 1041 794 1125">P</td> <td data-bbox="794 1041 1109 1125">C1-POLID</td> <td data-bbox="1109 1041 1466 1125">Paid through date is calculated at the policy level</td> </tr> <tr> <td data-bbox="578 1125 794 1209">P</td> <td data-bbox="794 1125 1109 1209">C1-MPID</td> <td data-bbox="1109 1125 1466 1209">Paid through date is calculated at the policy level</td> </tr> <tr> <td data-bbox="578 1209 794 1293">P</td> <td data-bbox="794 1209 1109 1293">C1-POLID and C1-MPID</td> <td data-bbox="1109 1209 1466 1293">Paid through date is calculated at the policy level</td> </tr> <tr> <td data-bbox="578 1293 794 1398">M</td> <td data-bbox="794 1293 1109 1398">C1-POLID</td> <td data-bbox="1109 1293 1466 1398">Paid through date is not calculated at the membership level</td> </tr> <tr> <td data-bbox="578 1398 794 1482">M</td> <td data-bbox="794 1398 1109 1482">C1-MPID</td> <td data-bbox="1109 1398 1466 1482">Paid through date is calculated at the membership level</td> </tr> <tr> <td data-bbox="578 1482 794 1566">M</td> <td data-bbox="794 1482 1109 1566">C1-POLID and C1-MPID</td> <td data-bbox="1109 1482 1466 1566">Paid through date is calculated at the membership level</td> </tr> <tr> <td data-bbox="578 1566 794 1650">P, M</td> <td data-bbox="794 1566 1109 1650">C1-POLID</td> <td data-bbox="1109 1566 1466 1650">Paid through date is calculated at the policy level</td> </tr> <tr> <td data-bbox="578 1650 794 1755">P, M</td> <td data-bbox="794 1650 1109 1755">C1-MPID</td> <td data-bbox="1109 1650 1466 1755">Paid through date is calculated at both the policy and membership levels</td> </tr> <tr> <td data-bbox="578 1755 794 1881">P, M</td> <td data-bbox="794 1755 1109 1881">C1-POLID and C1-MPID</td> <td data-bbox="1109 1755 1466 1881">Paid through date is calculated at both the policy and membership levels</td> </tr> </tbody> </table>	Entity	System Event	Algorithm	Customer Class	Payment Freeze	C1-PSPTDCAL	Customer Class	Payment Cancellation	C1-PXPTDCAL	Adjustment Type	Adjustment Freeze	C1-ADPTDCAL	Adjustment Type	Adjustment Cancellation	C1-AXPTDCAL	If the Paid Through Date Calculation Level parameter is set to...	If the following characteristics are defined for the bill charge or adjustment...	Then...	P	C1-POLID	Paid through date is calculated at the policy level	P	C1-MPID	Paid through date is calculated at the policy level	P	C1-POLID and C1-MPID	Paid through date is calculated at the policy level	M	C1-POLID	Paid through date is not calculated at the membership level	M	C1-MPID	Paid through date is calculated at the membership level	M	C1-POLID and C1-MPID	Paid through date is calculated at the membership level	P, M	C1-POLID	Paid through date is calculated at the policy level	P, M	C1-MPID	Paid through date is calculated at both the policy and membership levels	P, M	C1-POLID and C1-MPID	Paid through date is calculated at both the policy and membership levels
Entity	System Event	Algorithm																																												
Customer Class	Payment Freeze	C1-PSPTDCAL																																												
Customer Class	Payment Cancellation	C1-PXPTDCAL																																												
Adjustment Type	Adjustment Freeze	C1-ADPTDCAL																																												
Adjustment Type	Adjustment Cancellation	C1-AXPTDCAL																																												
If the Paid Through Date Calculation Level parameter is set to...	If the following characteristics are defined for the bill charge or adjustment...	Then...																																												
P	C1-POLID	Paid through date is calculated at the policy level																																												
P	C1-MPID	Paid through date is calculated at the policy level																																												
P	C1-POLID and C1-MPID	Paid through date is calculated at the policy level																																												
M	C1-POLID	Paid through date is not calculated at the membership level																																												
M	C1-MPID	Paid through date is calculated at the membership level																																												
M	C1-POLID and C1-MPID	Paid through date is calculated at the membership level																																												
P, M	C1-POLID	Paid through date is calculated at the policy level																																												
P, M	C1-MPID	Paid through date is calculated at both the policy and membership levels																																												
P, M	C1-POLID and C1-MPID	Paid through date is calculated at both the policy and membership levels																																												

- **Record Actions** - This section contains the following buttons:

Button Name	Button Description
Edit	Used to edit the details of the membership.
Inactivate	Used to inactivate the membership.

- **Record Information** - This section contains the following fields:

Field Name	Field Description
Business Object	Indicates the business object using which the membership is created. In addition, this column has a context menu which helps in navigating to other screens in the application. Note: It has a link. On clicking the link, the Business Object screen appears where you can view the details of the respective business object.
Status Date/Time	Displays the date and time when the membership status is updated
Create Date/Time	Displays the date and time when the membership is created.

Related Topics

For more information on...	See...
How to edit a membership of a fully-insured group policy plan	Editing a Membership of a Fully-Insured Group Policy Plan on page 376
How to inactivate a membership	Inactivating a Membership on page 380

Membership Characteristics

The **Membership Characteristics** zone lists the characteristics of the membership. It contains the following columns:

Column Name	Column Description
Effective Date	Displays the date from when the characteristic is effective for the membership.
Characteristic Type	Indicates the characteristic type.
Characteristic Value	Displays the value of the characteristic type.
Description	Displays the description of the characteristic value. Note: The data appears in this column when the type of characteristic value is set to Predefined Value .

You can filter the list using the **Effective Date** field available in the **Filter** area. By default, the **Filter** area is hidden. You can view the **Filter** area by clicking the **Filters** (∨) icon in the upper right corner of this zone.

Member Persons

The **Member Persons** zone lists the persons who are added to the membership. It contains the following columns:

Column Name	Column Description
Start Date	Displays the date from when the person is added to the membership.
End Date	Displays the date till when the person is added to the membership.

Column Name	Column Description
Person Information	Indicates the person who is added to the membership. In addition, it has the context menu which helps in navigating to other screens in the application.
	Note: It has a link. On clicking the link, the Person screen appears where you can view the details of the respective person.
Relationship Type	Indicates how the person is related to the main subscriber.
Main Subscriber	Indicates whether the person is the main subscriber of the membership. The valid values are: <ul style="list-style-type: none"> • Yes • No
Financially Responsible	Indicates whether the person is financially responsible for the membership. The valid values are: <ul style="list-style-type: none"> • Yes • No
Status	Indicates the status of the person in the membership. The valid values are: <ul style="list-style-type: none"> • Active • Inactive
Member	Indicates whether the person is a member or a non-member in the membership. The valid values are: <ul style="list-style-type: none"> • Yes • No
External Medicare Beneficiary ID	Displays the Medicare beneficiary identifier of the person who has availed the Medicare benefit.
Date of Birth	Displays the date when the person was born.
Edit	On clicking the Edit (✎) icon, the Member Person screen appears where you can edit the membership details of the person.

Note:

By default, the member persons which are in the **Active** status are listed in the **Member Persons** zone.

You can add a person to the membership by clicking the **Add Person** link in the upper right corner of this zone.

On clicking the **Broadcast** (📡) icon corresponding to a member person, the **Member Person Characteristics** zone appears where you can view the characteristics of the respective member person.

You can filter the list using the **Status** field available in the **Filter** area. By default, the **Filter** area is hidden. You can view the **Filter** area by clicking the **Filters** (🔍) icon in the upper right corner of this zone.

You can change the layout of this zone. For more information on how to change the layout, see [Changing the Layout](#) on page 3414.

Related Topics

For more information on...	See...
How to add a person to a membership	Adding a Person to a Membership on page 377
How to edit the membership details of a person	Editing the Membership Details of a Person on page 382
How to inactivate a member person of a membership	Inactivating a Member Person on page 381
How to view the characteristics of a member person	Viewing the Characteristics of a Member Person on page 388
Member Person Characteristics zone	Member Person Characteristics on page 368

Member Person Characteristics

The **Member Person Characteristics** zone lists the characteristics of the member person who is added to the membership. It contains the following columns:

Column Name	Column Description
Effective Date	Displays the date from when the characteristic is effective for the member person.
Characteristic Type	Indicates the characteristic type.
Characteristic Value	Displays the value of the characteristic type.
Description	Displays the description of the characteristic value.
	Note: The data appears in this column when the type of characteristic value is set to Predefined Value .

By default, the **Member Person Characteristics** zone does not appear in the **Main** tab. It appears when you click the **Broadcast** (📡) icon corresponding to the member person in the **Member Persons** zone.

You can change the layout of this zone. For more information on how to change the layout, see [Changing the Layout](#) on page 3414.

Other Plans of Main Subscriber

The **Other Plans of Main Subscriber** zone lists the additional memberships of the main subscriber. These memberships may belong to different plans within or across the policies. It contains the following columns:

Column Name	Column Description
Start Date	Displays the date from when the main subscriber is added to the membership.
End Date	Displays the date till when the main subscriber is added to the membership.
Plan Number	Indicates the fully-insured group policy plan for which the membership is created.
Price Item	Indicates the price item to which the policy plan is associated.
Membership Information	Displays information about the membership.
	Note: It has a link. On clicking the link, the Membership screen appears where you can view the details of the respective membership.

Column Name	Column Description
Last Billed Coverage	Indicates the last bill segment generated for the membership which is in the Frozen status. In addition, a context menu appears corresponding to this column which helps in navigating to other screens in application.
	Note: It has a link. On clicking the link, the Bill Segment screen appears where you can view the details of the respective bill segment.

Related Topics

For more information on...	See...
How to add a person to a membership	Adding a Person to a Membership on page 377
How to edit the membership details of a person	Editing the Membership Details of a Person on page 382
How to remove a person from a membership	Removing a Person from a Membership
How to inactivate a member person of a membership	Inactivating a Member Person on page 381

Membership - Contracts and Charges

The **Contracts and Charges** tab lists the following:

- Contracts associated with the membership
- Billable charges created for the membership
- Bill segments generated for each billable charge
- Timeline generated for each billable charge
- Premium calculated for each eligible member person when an age based pricing is used during the membership premium calculation
- Premium calculated for the membership when a tier based pricing is used during the membership premium calculation

It contains the following zones:

- [Membership Contracts](#) on page 369
- [Billable Charges](#) on page 370
- [Bill Segment Details](#) on page 372
- [Billable Charge Timeline Details](#) on page 373
- [Pricing Calculation Details](#) on page 373

Membership Contracts

The **Membership Contracts** zone lists the contracts which are associated with the membership. It contains the following columns:

Column Name	Column Description
Start Date	Displays the date from when the contract is associated with the membership.
End Date	Displays the date till when the contract is associated with the membership.

Column Name	Column Description
Bill To	Indicates the entity against whom the corresponding charges are billed. The valid values are: <ul style="list-style-type: none"> Federal State Group Individual
Contract ID	Displays the contract ID. Note: It has a link. On clicking the link, the Contract screen appears where you can view the details of the respective contract.
Account Information	Indicates the account for which the contract is created. In addition, this column has a context menu which helps in navigating to other screens in the application. Note: It has a link. On clicking the link, the Account screen appears where you can view the details of the respective account.
Delete	On clicking the Delete (🗑️) icon, you can disassociate the contract from the membership.
Edit	On clicking the Edit (🔗) icon, the Associate Contract with Membership screen appears where you can edit the contract association details of the membership.

Note: Pagination is used to display limited number of records in this zone. You can use the navigation links, such as **Previous** and **Next** to navigate between pages.

You can associate a contract with the membership by clicking the **Add Contract** link in the upper-right corner of this zone.

You can filter the list using the **Bill To** field available in the **Filter** area. By default, the **Filter** area is hidden. You can view the **Filter** area by clicking the **Filters** (🔍) icon in the upper-right corner of this zone.

Related Topics

For more information on...	See...
How to associate a contract with a membership	Associating a Contract with a Membership on page 384
How to edit the contract association details of a membership	Editing the Contract Association Details of a Membership on page 386
How to disassociate a contract from a membership	Disassociating a Contract from a Membership on page 385

Billable Charges

The **Billable Charges** zone lists the one-time or recurring billable charges which are created for the membership. It contains the following columns:

Column Name	Column Description
Start Date	Displays the start date of the billable charge.
End Date	Displays the end date of the billable charge.

Column Name	Column Description
Bill Period	Indicates the intervals at which the recurring bill segments must be created for the billable charge.
Price Item Information	Indicates the price item for which the billable charge is created. Note: It has a link. On clicking the link, the Price Item screen appears where you can view the details of the respective price item.
Account ID	Indicates the account for which the billable charge is created. Note: It has a link. On clicking the link, the Account screen appears where you can view the details of the respective account.
Contract ID	Indicates the contract against which the billable charge is created. Note: It has a link. On clicking the link, the Contract screen appears where you can view the details of the respective contract.
Billable Charge Information	Displays information about the billable charge. Note: It has a link. On clicking the link, the Billable Charge screen appears where you can view the details of the respective billable charge.
Amount	Displays the billable charge amount.
Status	Indicates the status of the billable charge. The valid values are: <ul style="list-style-type: none"> • Billable • Cancelled
Last Billed Coverage	Indicates the last bill segment generated for the billable charge which is in the Frozen status. In addition, a context menu appears corresponding to this column which helps in navigating to other screens in application. Note: It has a link. On clicking the link, the Bill Segment screen appears where you can view the details of the respective bill segment.

Note: Pagination is used to display limited number of records in this zone. You can use the navigation links, such as **Previous** and **Next** to navigate between pages.

On clicking the **Broadcast** (📡) icon corresponding to a billable charge, the **Bill Segment Details** and **Billable Charge Timeline Details** zones appear.

Note: On clicking the **Broadcast** (📡) icon, the **Billable Charge Timeline Details** zone appears when the timeline details are available for the respective billable charge.

You can filter the list using various search criteria (such as, **Price Item**, **Start Date**, **Contract ID**, **End Date** and **Status**) available in the **Filter** area. By default, the **Filter** area is hidden. You can view the **Filter** area by clicking the **Filters** (🔍) icon in the upper right corner of this zone.

Related Topics

For more information on...	See...
How to view the billable charges created for a membership	Viewing the Billable Charges Created for a Membership on page 388
Bill Segment Details zone	Bill Segment Details on page 372
Billable Charge Timeline Details zone	Billable Charge Timeline Details on page 373

Bill Segment Details

The **Bill Segment Details** zone lists all bill segments which are generated for the billable charge. It contains the following columns:

Column Name	Column Description
Start Date	Displays the start date of the bill segment.
End Date	Displays the end date of the bill segment.
Bill Segment Details	Displays information about the bill segment. In addition, this column has a context menu which helps in navigating to other screens in the application. Note: It has a link. On clicking the link, the Billable Segment screen appears where you can view the details of the respective bill segment.
Amount	Displays the bill segment amount.
Status	Indicates the status of the bill segment. The valid values are: <ul style="list-style-type: none"> • Incomplete • Error • Freezable • Pending Cancel • Canceled • Frozen
Bill Information	Indicates the bill in which the bill segment is created. In addition, this column has a context menu which helps in navigating to other screens in the application. Note: It has a link. On clicking the link, the Bill screen appears where you can view the details of the respective bill.

Note: Pagination is used to display limited number of records in this zone. You can use the navigation links, such as **Previous** and **Next** to navigate between pages.

By default, the **Bill Segment Details** zone does not appear in the **Contracts and Charges** tab of the **Membership** screen. It appears when you click the **Broadcast** (📡) icon corresponding to a billable charge in the **Billable Charges** zone.

You can filter the list using various search criteria (such as, **Start Date**, **Status**, and **End Date**) available in the **Filter** area. By default, the **Filter** area is hidden. You can view the **Filter** area by clicking the **Filters** (🔍) icon in the upper right corner of this zone.

Related Topics

For more information on...	See...
How to view the billable segments generated for a billable charge	Viewing the Bill Segments Generated for a Billable Charge on page 389
Billable Charges zone	Billable Charges on page 370

Billable Charge Timeline Details

The **Billable Charge Timeline Details** zone lists the timelines which are derived during the membership premium calculation. It appears when the timeline details are available for the billable charge. It contains the following columns:

Column Name	Column Description
Start Date	Displays the start date of the timeline.
End Date	Displays the end date of the timeline.
Amount	Displays the premium amount calculated for the timeline.
Pricing Rule Information	Indicates the pricing rule using which the premium amount is calculated. Note: It has a link. On clicking the link, the Pricing Rule screen appears where you can view the details of the respective pricing rule.
Pricing Rule Type	Indicates the pricing rule type using which the pricing rule is created. Note: It has a link. On clicking the link, the Pricing Rule Type screen appears where you can view the details of the respective pricing rule type.

Note: Pagination is used to display limited number of records in this zone. You can use the navigation links, such as **Previous** and **Next** to navigate between pages.

By default, the **Billable Charge Timeline Details** zone does not appear in the **Contracts and Charges** tab of the **Membership** screen. It appears when you click the **Broadcast** (📢) icon corresponding to a billable charge in the **Billable Charges** zone.

On clicking the **Broadcast** (📢) icon corresponding to a timeline, the **Pricing Calculation Details** zone appears.

You can filter the list using various search criteria (such as, **Start Date** and **End Date**) available in the **Filter** area. By default, the **Filter** area is hidden. You can view the **Filter** area by clicking the **Filters** (🔍) icon in the upper right corner of this zone.

Related Topics

For more information on...	See...
How to view the timeline details of a membership billable charge	Viewing the Timeline Details of a Membership Billable Charge on page 389
Billable Charges zone	Billable Charges on page 370
Pricing Calculation Details zone	Pricing Calculation Details on page 373
How the timeline is derived during the membership premium calculation	Membership Premium Calculation on page 3132

Pricing Calculation Details

The **Pricing Calculation Details** zone indicates how the amount is calculated for the timeline. If the age based pricing is used during the membership premium calculation, this zone lists the premium calculated for each eligible member of

the membership. It also displays the base fee and modifier fee which are applicable for each eligible member. However, if the tier based pricing is used during the membership premium calculation, this zone lists the premium calculated at the membership level. It contains the following columns:

Column Name	Column Description
Entity Information	If the age based pricing is used during the membership premium calculation, this column indicates the eligible member for whom the premium amount is calculated. However, if the tier based pricing is used during the membership premium calculation, this column indicates the main subscriber of the membership.
Description on Bill	Displays the description of the rate component for which the price component is created in the age based or tier based pricing.
Pricing Parameter	Indicates the pricing eligibility criteria which is satisfied while deriving the base fee.
Amount	Displays the base fee or applicable modifier fee.
Proration Factor	Indicates the proration factor which is derived using the proration rules defined for the fully-insured group policy plan. Note: The data appears in this column when the proration rule for the respective event is defined for the fully-insured group policy plan.
Distributed Amount	Displays the premium amount which is calculated for the non-skip billing periods. Note: The data appears in this column when the 9/10 Billing (Skip Months) feature is enabled for the account. If the age based pricing is used during the membership premium calculation, this column displays the distributed amount for the eligible member. However, if the tier based pricing is used during the membership premium calculation, this column displays the distributed amount for the membership.
No. of Billing Periods	Indicates the number of the non-skip billing periods of the account. Note: The data appears in this column when the 9/10 Billing (Skip Months) feature is enabled for the account.
Total Contract Period Amount	Displays the premium which should be paid for the entire contract period (in other words, total premium for the skip and non-skip billing periods). Note: The data appears in this column when the 9/10 Billing (Skip Months) feature is enabled for the account. If the age based pricing is used during the membership premium calculation, this column displays the total contract period amount for the eligible member. However, if the tier based pricing is used during the membership premium calculation, this column displays the total contract period amount for the membership.
Total Amount	If the age based pricing is used during the membership premium calculation, this column displays the sum total of the base fee and modifier fee (if any) for the eligible member. However, if the tier based pricing is used during the membership premium calculation, this column displays the base fee applicable for the membership.

By default, the **Pricing Calculation Details** zone does not appear in the **Contracts and Charges** tab of the **Membership** screen. It appears when you click the **Broadcast** (📡) icon corresponding to a timeline in the **Billable Charge Timeline Details** zone.

Related Topics

For more information on...	See...
How to view the pricing calculation details of a timeline	Viewing the Pricing Calculation Details of a Timeline on page 390
Premium Proration Rules	Premium Proration Rules on page 3128

Membership - Log

The **Log** tab contains the following zone:

- [Membership Log](#) on page 375

Membership Log

The **Membership Log** zone lists the complete trail of actions performed on the membership. It contains the following columns:

Column Name	Column Description
Creation Date Time	Displays the date and time when the action was performed on the membership.
Details	Displays the details about the action performed on the membership.
User	Indicates the user who has performed the action on the membership.
Log Type	Indicates the type of log.
Related Object	Indicates the object or entity which is generated when the action is performed on the membership.
	Note: It contains a link. On clicking the link, the screen appears where you can view the details of the respective related object.
Status Reason	Indicates the reason why the status of the membership is changed.
	Note: At present, no data appears in this column. The implementation team can build the custom logic to meet the business requirements.

Note: You can manually add a log entry for the membership by clicking the **Add Log Entry** link in the upper right corner of the **Membership Log** zone.

Related Topics

For more information on...	See...
How to view the log of a membership	Viewing the Log of a Membership on page 390
How to add a log entry for a membership	Adding a Log Entry for a Membership on page 391

Editing a Membership of a Fully-Insured Group Policy Plan

Procedure

To edit a membership of a fully-insured group policy plan:

1. Search for the membership in the **Membership** screen.
2. In the **Search Results** section, click the link in the **Membership Information** column corresponding to the membership whose details you want to edit.

The **Membership** screen appears.

3. Ensure that the **Main** tab is selected.
4. Click the **Edit** button in the **Membership** zone.

The **Membership** screen appears. It contains the following sections:

- **Main** - Used to specify the basic details about the membership.
- **Characteristics** - Used to define the characteristics for the membership.

The **Main** section contains the following fields:

Field Name	Field Description	Mandatory (Yes or No)
Membership Information	Displays information about the membership.	Not applicable
Plan Information	Indicates the policy plan for which the membership is defined.	Not applicable
Start Date	Used to specify the date from when the membership is effective for a fully-insured group policy plan. Note: The membership start date cannot be later than the membership end date. The membership start date cannot be earlier than the policy plan start date or later than policy plan end date.	Yes
End Date	Used to specify the date till when the membership is effective for a fully-insured group policy plan. Note: The membership end date cannot be earlier than the membership start date. The membership end date cannot be earlier than the policy plan start date or later than policy plan end date.	Yes
Membership Type	Used to indicate the type of membership. The valid values are: <ul style="list-style-type: none"> • COBRA • Medicare 	No

Field Name	Field Description	Mandatory (Yes or No)
External Membership ID	Used to specify the external membership ID.	No
	Note: Here, you need to specify a membership ID which is maintained in the external source system.	

5. Modify the required details in the **Main** section.
6. Define, edit, or remove characteristics of the membership, if required.
7. Click **Save**.

The changes made to the membership are saved.

Related Topics

For more information on...	See...
How to search for a membership	Searching for a Membership on page 357
Membership screen	Membership (Used for Viewing) on page 363
Membership zone	Membership on page 363
How to define a characteristic for a membership	Defining a Characteristic for a Membership on page 361

Adding a Person to a Membership

The system enables you to add a member person to a membership when the membership is in the **Active** status. However, you can only add a member person in the **Active** status and not in the **Inactive** status.

Prerequisites

To add a person to a membership, you should have:

- Required persons defined in the application
- Contract relationship types defined in the application

Procedure

To add a person to a membership:

1. Search for the membership in the **Membership** screen.
2. In the **Search Results** section, click the link in the **Membership Information** column corresponding to the membership to which you want to add a person.

The **Membership** screen appears.

3. Ensure that the **Main** tab is selected.
4. Click the **Add Person** link in the upper right corner of the **Member Persons** zone.

The **Member Person** screen appears. It contains the following sections:

- **Main** - Used to specify the basic membership details of the person.
- **Characteristics** - Used to define the characteristics for the member person.

The **Main** section contains the following fields:

Field Name	Field Description	Mandatory (Yes or No)
Membership Information	Indicates the membership to which you want to add a person.	Not applicable
Person ID	Used to indicate the person whom you want to add to the membership. Note: The Search (🔍) icon appears corresponding to this field. On clicking the Search icon, the Person Search window appears.	Yes
Relationship Type	Used to indicate how the person is related to the main subscriber. Note: The list includes only those contract relationship types which are already defined in the system.	Yes
Financially Responsible	Used to indicate whether the person is financially responsible for the membership.	No
Main Subscriber	Used to indicate whether the person is the main subscriber of the membership.	No
Member	Used to indicate whether the person is a member or a non-member in the membership.	No
Start Date	Used to specify the date from when you want to add the person to the membership. Note: The member person start date cannot be later than the member person end date. The member person start date cannot be earlier than the membership start date or later than the membership end date.	Yes
End Date	Used to specify the date till when you want to add the person to the membership. Note: The member person end date cannot be earlier than the member person start date. The member person end date cannot be earlier than the membership start date or later than the membership end date.	No
External Medicare Beneficiary ID	Used to specify the Medicare beneficiary identifier of the person who has availed the Medicare benefit.	No

Field Name	Field Description	Mandatory (Yes or No)
Member Person Status	Used to indicate the status of the person in the membership. The valid values are: <ul style="list-style-type: none"> Active Inactive 	Yes
	Note: By default, the Active option is selected.	

- Enter the required details in the **Main** section.
- Define the characteristics for the member person, if required.
- Click **Save**.

The person is added to the membership.

Related Topics

For more information on...	See...
How to search for a membership	Searching for a Membership on page 357
Membership screen	Membership (Used for Viewing) on page 363
Member Persons zone	Member Persons on page 366
How to define a characteristic for a member person	Defining a Characteristic for a Member Person on page 379

Defining a Characteristic for a Member Person

Prerequisites

To define a characteristic for a member person, you should have:

- Characteristic types defined in the application (where the characteristic entity is set to **Membership Person**)

Procedure

To define a characteristic for a member person:

- Ensure that the **Characteristics** section is expanded when you are adding a person to a membership or editing the membership details of a person.

The **Characteristics** section contains the following fields in a grid:

Field Name	Field Description	Mandatory (Yes or No)
Effective Date	Used to indicate the date from when the characteristic is effective for the member person.	Yes (Conditional)
		Note: This field is required when you are defining a characteristic for the member person.

Field Name	Field Description	Mandatory (Yes or No)
Characteristic Type	Used to indicate the characteristic type.	Yes (Conditional)
	Note: The list includes only those characteristic types where the characteristic entity is set to Membership Person .	Note: This field is required when you are defining a characteristic for the member person.
Characteristic Value	Used to specify the value for the characteristic type.	Yes (Conditional)
	<p>Note:</p> <p>If you select a predefined characteristic type, the Search (🔍) icon appears corresponding to the Characteristic Value field. On clicking the Search icon, the Predefined Characteristic Search window appears.</p> <p>On specifying the value for a predefined characteristic type, the description of the characteristic value appears corresponding to the Characteristic Value field.</p>	Note: This field is required when you are defining a characteristic for the member person.

- Enter the required details in the **Characteristics** section.
- If you want to define more than one characteristic for the member person, click the **Add (+)** icon and then repeat step 2.

Note: However, if you want to remove a characteristic from the member person, click the **Delete** (🗑️) icon corresponding to the characteristic.

- Click **Save**.

The characteristics are defined for the member person.

Related Topics

For more information on...	See...
How to add a person to a membership	Adding a Person to a Membership on page 377
How to edit the membership details of a person	Editing the Membership Details of a Person on page 382

Inactivating a Membership

There are two ways in which you can inactivate the membership from the user interface:

- On clicking the **Inactivate** button
- On inactivating the main subscriber of the membership

Procedure

To inactivate a membership:

- Search for the membership in the **Membership** screen.
- In the **Search Results** section, click the link in the **Membership Information** column corresponding to the membership that you want to inactivate.

The **Membership** screen appears.

3. Ensure that the **Main** tab is selected.
4. Click the **Inactivate** button in the **Membership** zone.

The status of the membership is changed to **Inactive**.

Related Topics

For more information on...	See...
How to search for a membership	Searching for a Membership on page 357
Membership screen	Membership (Used for Viewing) on page 363
Membership zone	Membership on page 363

Inactivating a Member Person

The system enables you to inactivate a member person of a membership. If the member person is the main subscriber, the system automatically inactivates the membership and all other member persons which are included in the membership. It also does the following:

- Cancels the billable charges which are created for the membership
- Cancels the corresponding bill segments (if any)

If an audit event exists for the membership which is inactivated, the **BO_STATUS_CD** column corresponding to the record in the **C1_AUDIT_EVENT**, **C1_AUDIT_EVENT_LOG**, and **CI_PRCE_CALC** tables is set to **INVALID**. If a repricing entity detail record exists for the membership in the **PENDING** or **ERROR** status, then the **BO_STATUS_CD** column corresponding to the record in the **CI_REPRC_ENTITY_DTL** table is set to **COMPLETE**. If a repricing request exists for the membership in the **PENDING** or **ERROR** status, then the **BO_STATUS_CD** column corresponding to the record in the **CI_REPRC_REQ_DTL** table is set to **COMPLETE**.

Procedure

To inactivate a member person of a membership:

1. Search for the membership in the **Membership** screen.
2. In the **Search Results** section, click the link in the **Membership Information** column corresponding to the membership whose details you want to edit.

The **Membership** screen appears.

3. Ensure that the **Main** tab is selected.
4. In the **Member Persons** zone, click the **Edit** (✎) icon in the **Edit** column corresponding to the member person whom you want to inactivate.

The **Add/Edit Member Person** screen appears.

5. Select the **Inactive** option from the **Membership Person Status** list.

The status of the member person is changed to **Inactive**.

Related Topics

For more information on...	See...
How to search for a membership	Searching for a Membership on page 357
Membership screen	Membership (Used for Viewing) on page 363
Member Persons zone	Member Persons on page 366

Editing the Membership Details of a Person

Prerequisites

To edit the membership details of a person, you should have:

- Contract relationship types defined in the application

Procedure

To edit the membership details of a person:

1. Search for the membership in the **Membership** screen.
2. In the **Search Results** section, click the link in the **Membership Information** column corresponding to the membership whose details you want to edit.

The **Membership** screen appears.

3. Ensure that the **Main** tab is selected.
4. In the **Member Persons** zone, click the **Edit** (✎) icon in the **Edit** column corresponding to the member person whose details you want to edit.

The **Member Person** screen appears. It contains the following sections:

- **Main** - Used to specify the basic membership details of the person.
- **Characteristics** - Used to define the characteristics for the member person.

The **Main** section contains the following fields:

Field Name	Field Description	Mandatory (Yes or No)
Membership Information	Indicates the membership to which the person is added.	Not applicable
Person ID	Indicates the person who is added to the membership.	Not applicable
Relationship Type	Used to indicate how the person is related to the main subscriber.	Yes
	Note: The list includes only those contract relationship types which are already defined in the system.	
Financially Responsible	Used to indicate whether the person is financially responsible for the membership.	No
Main Subscriber	Used to indicate whether the person is the main subscriber of the membership.	No
Member	Used to indicate whether the person is a member or a non-member in the membership.	No

Field Name	Field Description	Mandatory (Yes or No)
Start Date	Used to specify the date from when you want to add the person to the membership.	Yes
	<p>Note:</p> <p>The member person start date cannot be later than the member person end date.</p> <p>The member person start date cannot be earlier than the membership start date or later than the membership end date.</p>	
End Date	Used to specify the date till when you want to add the person to the membership.	No
	<p>Note:</p> <p>The member person end date cannot be earlier than the member person start date.</p> <p>The member person end date cannot be earlier than the membership start date or later than the membership end date.</p>	
External Medicare Beneficiary ID	Used to specify the Medicare beneficiary identifier of the person who has availed the Medicare benefit.	No
Member Person Status	Used to indicate the status of the person in the membership. The valid values are: <ul style="list-style-type: none"> • Active • Inactive 	Yes
	<p>Note:</p> <p>If you inactivate a member person who is the main subscriber, the system automatically inactivates the membership and all other member persons which are included in the membership.</p> <p>You cannot change the status of the member person to Active when the membership is in the Inactive status.</p>	

5. Modify the required details in the **Main** section.
6. Define, edit, or remove the characteristics from the member person, if required.
7. Click **Save**.

The changes made to the membership details of the person are saved.

Related Topics

For more information on...	See...
How to search for a membership	Searching for a Membership on page 357
Membership screen	Membership (Used for Viewing) on page 363
Member Persons zone	Member Persons on page 366

For more information on...	See...
How to define a characteristic for a member person	Defining a Characteristic for a Member Person on page 379
How to inactivate a member person of a membership	Inactivating a Member Person on page 381

Associating a Contract with a Membership

Prerequisites

To associate a contract with a membership, you should have:

- Contracts defined in the application
- Values defined for the **BILL_TO_TYPE_FLG** lookup field

Procedure

To associate a contract with a membership:

1. Search for the membership in the **Membership** screen.
2. In the **Search Results** section, click the link in the **Membership Information** column corresponding to the membership to which you want to associate a contract.

The **Membership** screen appears.

3. Click the **Contracts and Charges** tab.

The **Contracts and Charges** tab appears.

4. Click the **Add Contract** link in the upper right corner of the **Membership Contracts** zone.

The **Associate Contract with Membership** screen appears. It contains the following section:

- **Main** - Used to associate a contract with the membership. It contains the following fields:

Field Name	Field Description	Mandatory (Yes or No)
Membership Information	Indicates the membership to which you want to associate a contract.	Not applicable
Contract ID	Used to indicate the contract that you want to associate with the membership.	Yes
	Note: The Search (🔍) icon appears corresponding to the Contract ID field. On clicking the Search icon, the Contract Search window appears.	

Field Name	Field Description	Mandatory (Yes or No)
Bill To	Used to indicate the entity against whom the corresponding charges should be billed. The valid values are: <ul style="list-style-type: none"> Federal State Group Individual <p>Note: You cannot associate multiple contracts with the membership using the same bill to option. For example, you cannot associate C1 and C2 with M1 by selecting the Group option from the Bill To field.</p>	Yes
Start Date	Used to specify the date from when you want to associate the contract with the membership. <p>Note: The start date cannot be later than end date. The start date cannot be earlier than the membership start date or later than the membership end date.</p>	Yes
End Date	Used to specify the date till when you want to associate the contract with the membership. <p>Note: The end date cannot be earlier than the start date. The end date cannot be earlier than the membership start date or later than the membership end date.</p>	No

5. Enter the required details in the **Main** section.

6. Click **Save**.

The contract is associated with the membership.

Related Topics

For more information on...	See...
How to search for a membership	Searching for a Membership on page 357
Membership screen	Membership (Used for Viewing) on page 363
Membership Contracts zone	Membership Contracts on page 369

Disassociating a Contract from a Membership

Procedure

To disassociate a contract from a membership:

1. Search for the membership in the **Membership** screen.

- In the **Search Results** section, click the link in the **Membership Information** column corresponding to the membership from which you want to disassociate the contract.

The **Membership** screen appears.

- Click the **Contract & Charges** tab.

The **Contract & Charges** tab appears.

- In the **Membership Contracts** zone, click the **Delete** (🗑️) icon in the **Delete** column corresponding to the contract that you want to disassociate from the membership.

A message appears confirming whether you want to disassociate the contract from the membership.

- Click **OK**.

The contract is disassociated from the membership.

Related Topics

For more information on...	See...
How to search for a membership	Searching for a Membership on page 357
Membership screen	Membership (Used for Viewing) on page 363
Membership Contracts zone	Membership Contracts on page 369

Editing the Contract Association Details of a Membership

Prerequisites

To edit the contract association details of a membership, you should have:

- Contracts defined in the application
- Values defined for the **BILL_TO_TYPE_FLG** lookup field

Procedure

To edit the contract association details of a membership:

- Search for the membership in the **Membership** screen.
- In the **Search Results** section, click the link in the **Membership Information** column corresponding to the membership whose contract details you want to edit.

The **Membership** screen appears.

- Click **Contracts and Charges** tab.

The **Contracts and Charges** tab appears.

- In the **Membership Contracts** zone, click the **Edit** (✎) icon in the **Edit** column corresponding to the contract whose association details you want to edit.

The **Associate Contract with Membership** screen appears. It contains the following section:

- Main** - Used to associate a contract with the membership. It contains the following fields:

Field Name	Field Description	Mandatory (Yes or No)
Membership Information	Indicates the membership to which you want to associate a contract.	Not applicable

Field Name	Field Description	Mandatory (Yes or No)
Contract ID	Used to indicate the contract that you want to associate with the membership.	Yes
	Note: The Search (🔍) icon appears corresponding to the Contract ID field. On clicking the Search icon, the Contract Search window appears.	
Bill To	Used to indicate the entity against whom the corresponding charges should be billed. The valid values are: <ul style="list-style-type: none"> • Federal • State • Group • Individual 	Yes
	Note: You cannot associate multiple contracts with the membership using the same bill to option. For example, you cannot associate C1 and C2 with M1 by selecting the Group option from the Bill To field.	
Start Date	Used to specify the date from when you want to associate the contract with the membership.	Yes
	Note: The start date cannot be later than end date. The start date cannot be earlier than the membership start date or later than the membership end date.	
End Date	Used to specify the date till when you want to associate the contract with the membership.	No
	Note: The end date cannot be earlier than the start date. The end date cannot be earlier than the membership start date or later than the membership end date.	

5. Modify the required details in the **Main** section.

6. Click **Save**.

The changes made to the membership are saved.

Related Topics

For more information on...	See...
How to search for a membership	Searching for a Membership on page 357
Membership screen	Membership (Used for Viewing) on page 363

For more information on...	See...
Membership Contracts zone	Membership Contracts on page 369

Viewing the Characteristics of a Member Person

Procedure

To view the characteristics of a member person in a membership:

1. Search for the membership in the **Membership** screen.
2. In the **Search Results** section, click the link in the **Membership Information** column corresponding to the membership whose details you want to view.
The **Membership** screen appears.
3. Ensure that the **Main** tab is selected.
4. In the **Member Persons** zone, click the **Broadcast** () icon corresponding to the member person whose characteristics you want to view.
The **Member Person Characteristics** zone appears.
5. View the characteristics of the member person in the **Member Person Characteristics** zone.

Related Topics

For more information on...	See...
How to search for a membership	Searching for a Membership on page 357
Membership screen	Membership (Used for Viewing) on page 363
Member Persons zone	Member Persons on page 366
Member Person Characteristics zone	Member Person Characteristics on page 368

Viewing the Billable Charges Created for a Membership

Procedure

To view the billable charges created for a membership:

1. Search for the membership in the **Membership** screen.
2. In the **Search Results** section, click the link in the **Membership Information** column corresponding to the membership whose details you want to view.
The **Membership** screen appears.
3. Click the **Contracts and Charges** tab.
The **Contracts and Charges** tab appears.
4. View the billable charges created for the membership in the **Billable Charges** zone.

Related Topics

For more information on...	See...
How to search for a membership	Searching for a Membership on page 357
Membership screen	Membership (Used for Viewing) on page 363
Billable Charges zone	Billable Charges on page 370

Viewing the Bill Segments Generated for a Billable Charge

Procedure

To view the bill segments generated for a billable charge:

1. Search for the membership in the **Membership** screen.
2. In the **Search Results** section, click the link in the **Membership Information** column corresponding to the membership whose details you want to view.
The **Membership** screen appears.
3. Click the **Contracts and Charges** tab.
The **Contracts and Charges** tab appears.
4. In the **Billable Charges** zone, click the **Broadcast** () icon corresponding to the billable charge whose bill segments you want to view.
The **Bill Segment Details** and **Billable Charge Timeline Details** zones appear.
5. View the bill segments generated for the billable charge in the **Bill Segment Details** zone.

Related Topics

For more information on...	
How to search for a membership	Searching for a Membership on page 357
Membership screen	Membership (Used for Viewing) on page 363
Billable Charges zone	Billable Charges on page 370
Bill Segment Details zone	Bill Segment Details on page 372
Billable Charge Timeline Details zone	Billable Charge Timeline Details on page 373

Viewing the Timeline Details of a Membership Billable Charge

Procedure

To view the timeline details of a membership billable charge:

1. Search for the membership in the **Membership** screen.
2. In the **Search Results** section, click the link in the **Membership Information** column corresponding to the membership whose details you want to view.
The **Membership** screen appears.
3. Click the **Contracts and Charges** tab.
The **Contracts and Charges** tab appears.
4. In the **Billable Charges** zone, click the **Broadcast** () icon corresponding to the billable charge whose timeline details you want to view.
The **Bill Segment Details** and **Billable Charge Timeline Details** zones appear.
5. View the timeline details of the billable charge in the **Billable Charge Timeline Details** zone.

Related Topics



For more information on...	
How to search for a membership	Searching for a Membership on page 357

For more information on...	
Membership screen	Membership (Used for Viewing) on page 363
Billable Charges zone	Billable Charges on page 370
Bill Segment Details zone	Bill Segment Details on page 372
Billable Charge Timeline Details zone	Billable Charge Timeline Details on page 373

Viewing the Pricing Calculation Details of a Timeline

Procedure

To view the pricing calculation details of a timeline:

1. Search for the membership in the **Membership** screen.
2. In the **Search Results** section, click the link in the **Membership Information** column corresponding to the membership whose details you want to view.
The **Membership** screen appears.
3. Click the **Contracts and Charges** tab.
The **Contracts and Charges** tab appears.
4. In the **Billable Charges** zone, click the **Broadcast** () icon corresponding to the billable charge whose timeline details you want to view.
The **Bill Segment Details** and **Billable Charge Timeline Details** zones appear.
5. In the **Billable Charge Timeline Details** zone, click the **Broadcast** () icon corresponding to the timeline whose pricing calculation details you want to view.
6. View the base fee and modifier fee (if any) applicable for each eligible member or membership in the **Pricing Calculation Details** zone.

Related Topics

For more information on...	
How to search for a membership	Searching for a Membership on page 357
Membership screen	Membership (Used for Viewing) on page 363
Billable Charges zone	Billable Charges on page 370
Bill Segment Details zone	Bill Segment Details on page 372
Billable Charge Timeline Details zone	Billable Charge Timeline Details on page 373
Pricing Calculation Details zone	Pricing Calculation Details on page 373

Viewing the Log of a Membership

Procedure

To view the log of a membership:

1. Search for the membership in the **Membership** screen.
2. In the **Search Results** section, click the link in the **Membership Information** column corresponding to the membership whose details you want to view.
The **Membership** screen appears.

3. Click the **Log** tab.

The **Log** tab appears.

4. View the complete trail of actions performed on the membership in the **Membership Log** zone.

Related Topics

For more information on...	See...
How to search for a membership	Searching for a Membership on page 357
Membership screen	Membership (Used for Viewing) on page 363
Membership Log zone	Membership Log on page 375
How to add a log entry for a membership	Adding a Log Entry for a Membership on page 391

Adding a Log Entry for a Membership

Procedure

To add a log entry for a membership:

1. Search for the membership in the **Membership** screen.
2. In the **Search Results** section, click the link in the **Membership Information** column corresponding to the membership for which you want to add a log entry.

The **Membership** screen appears.

3. Click the **Log** tab.

The **Log** tab appears.

4. Click the **Add Log Entry** link in the upper right corner of the **Membership Log** zone.

The **Add Membership Log** window appears. It contains the following fields:

Field Name	Field Description	Mandatory (Yes or No)
Membership Information	Displays information about the membership.	Not applicable
Log Details	Used to specify additional comments for the membership.	Yes

5. Enter the comments in the **Log Details** field.
6. Click **Save**.

The log entry is added in the **Membership Log** zone.

Related Topics

For more information on...	See...
How to search for a membership	Searching for a Membership on page 357
Membership screen	Membership (Used for Viewing) on page 363
Membership Log zone	Membership Log on page 375

Chapter

5

Self-Funded Group Health Insurance

Topics:

- [Pre-requisites](#)
- [Self-Funded Policy](#)
- [Self-Funded Policy Status Transition](#)
- [Algorithms Used in C1-ASOPolicy](#)
- [Policy \(Used for Searching\)](#)
- [Policy \(Used for Viewing\)](#)

Self-funded group health insurance, also known as Administrative Services Only (ASO), is a self insurance arrangement whereby an employer provides health or disability benefits to employees using the company's own funds. A self-insured employer will set up a special trust fund to earmark money (corporate and employee contributions) to pay incurred claims. It is also commonly known as self-funded employee health insurance.

In the self-funded group health plan, employers operate their own health plan. However, in the fully-insured group health plan, the employer contracts an insurance company to cover the employees and dependents. Employers choose to self-insure because it allows them to save the profit margin that an insurance company adds to its premium for a fully-insured group health plan. However, self-insuring exposes the company to much larger risk when more claims than expected must be paid.

Oracle Revenue Management and Billing (ORMB) supports the following types of self-funding approach:

- **Fully Self-Funded** - In the fully self-funded approach, the employer retains all the risk and bears the claim costs irrespective of any limit.
- **Partially Self-Funded** - In the partially self-funded approach, the employer purchases reinsurance or stop loss coverage to pass the risk to insurance company.

Oracle Revenue Management and Billing (ORMB) provides specialized methodologies for calculating claim amount with or without markups, enrollment fees, claim fees, specific stop-loss credits, aggregate stop-loss credits, non-recurring or recurring flat fees for covered services, network discounts, and fixed or enrollment based premium funds. Once the charges are calculated, the system bills the amount to the employer (known as the parent customer in ORMB) or to its logical designed billing entities (known as the bill groups in ORMB).

Oracle Revenue Management and Billing (ORMB) enables you to use the pricing methodologies and the billing engine for the self-funded group health insurance business. To design the pricing and billing models for the self-funded group health insurance business, you need to create the following entities in ORMB:

- Parent Customer
- Bill Groups
- Bill Group's Account
- Self-Funded Policy
- Price Items (for each covered service in the policy)

- Pricing Rule Types
- Pricing Rules

Pre-requisites

To set the billing system for a self-funded group customer, you need to do the following:

- Define the required policy types in the system.
- Define the required policy person roles in the system.
- Define the values for the **RUNOUT_ADM_OPT_FLG** lookup field.
- Define the required characteristic types where the characteristic entity is set to **Policy Type**.
- Define the required characteristic types where the characteristic entity is set to **Policy**.
- Define the required parameter values in the following algorithm which is attached to the **C1-ASOPolicy** business object:
 - C1-ASOBOPOSP
- Define the required parameter values in the following algorithm which is used in the lifecycle of the **C1-ASOPolicy** business object:
 - C1-ASOPOLMOA
- Set the values for the following option types in the **C1-ASOBLLNG** feature configuration:
 - Parent Customer Policy Person Role
 - Bill Group Policy Person Role
- Set the values for the following option types in the **C1-PERSTYPE** feature configuration:
 - Bill Group Person Type
 - Parent Person Type
- Set the batch control type of the **Policy Periodic Monitor (C1-POLPR)** batch to **Timed** and define the following attributes:
 - Time Interval
 - Timer Active
 - User ID
 - Batch Language
 - Email Address

Related Topics

For more information on...	See...
How to setup the C1-ASOBLLNG feature configuration	Setting the C1-ASOBLLNG Feature Configuration on page 3421

Self-Funded Policy

You can create a self-funded policy using a policy type where the policy category is set to **Self-Funded**. The policy type indicates the business object using which the self-funded policy should be created in the system.

As per the self-funded health insurance business, the system enables you to create a self-funded policy for a bill group where the parent customer is the policy holder. You can create or edit a self-funded policy from the **Policy** screen. In addition, you can create or edit a self-funded policy through a customer registration object or a health care inbound

message. If the self-funded policy information is given for a bill group in a health care inbound message, the system does the following:

- Associates the bill group with the policy using the policy person role which is specified in the **Bill Group Policy Person Role** option type of the **C1-ASOBLNG** feature configuration
- Associates the parent customer with the policy using the policy person role which is specified in the **Parent Customer Policy Person Role** option type of the **C1-ASOBLNG** feature configuration

A self-funded policy encapsulates the following information:

- **Policy Persons** – While creating a self-funded policy, you need to associate the person who is the main customer of the policy. While associating a person with a self-funded policy, you need to specify the policy person role which indicates the role of the person in the policy. For example, whether the person associated with the policy is the policy holder, broker, or underwriter. You can associate multiple persons with a self-funded policy using the same or different policy person role. However, at a time, only one person can be the main customer of the policy.
- **Policy Contracts** – The system creates a contract for a self-funded policy when the policy is created either from the user interface or through an inbound message. For more information, refer to [Self-Funded Policy Contract Creation](#) on page 399.

On defining a self-funded policy, the status of the policy is set to **Pending**. You can then edit, delete or activate a policy. Once a self-funded policy is activated, you can renew the policy whenever required.

Note: If a self-funded policy is created through a customer registration object or a health care inbound message, the status of the policy is set to **Pending**.

In a self-funded policy, you can specify the policy period as well as the runout period. Here, the policy period means the period between the policy start and end dates when the policy is active. And, the runout period means the period between the runout start and end dates when the policy is no more active. Note that the system sets the runout start date to the policy end date + 1 Day when you specify the runout end date.

The system enables you to create a self-funded policy for the following contract types which are used in the self-funded health insurance business:

Contract Type	Policy (Example)	Policy Period (i.e. Period when Policy will be in the Active Status)	Runout Period (i.e. Period when Policy will be in the Runout Status)	Comments
12/12 (Claims Incurred and Paid During the Policy Period)	P1	01-01-2019 to 12-31-2019	-	Here, you will not specify the runout end date for the self-funded policy (i.e. P1).
12/15 (Claims Incurred During the Policy Period and Paid During the Policy and Runout Periods)	P2	01-01-2019 to 12-31-2019	01-01-2020 to 03-31-2020	Here, the runout period is derived when you set the runout end date of the self-funded policy (i.e. P2) to 03-31-2020.

Contract Type	Policy (Example)	Policy Period (i.e. Period when Policy will be in the Active Status)	Runout Period (i.e. Period when Policy will be in the Runout Status)	Comments
12/18 (Claims Incurred During the Policy Period and Paid During the Policy and Runout Periods)	P3	01-01-2019 to 12-31-2019	01-01-2020 to 06-30-2020	Here, the runout period is derived when you set the runout end date of the self-funded policy (i.e. P3) to 06-30-2020.
15/12 (Claims Incurred Three Months Prior to the Policy Start Date and During the Policy Period and Paid During the Policy Period)	P4	01-01-2019 to 12-31-2019	-	Here, you will not specify the runout end date for the self-funded policy (i.e. P4).

The system enables you to offer different pricing for different policy periods, such as active, runout, and post runout.

Self-Funded Policy Activation

A self-funded policy can be activated manually from the user interface or through the **Policy Periodic Monitor (C1-POLPR)** batch. You can activate a self-funded policy by clicking the **Activate** button in the **Policy** screen. On clicking the **Activate** button, the system checks whether the To Do created for the **Pending** status is completed. If the To Do created for the **Pending** status is not completed, it completes the To Do and then changes the status of the self-funded policy from **Pending** to **In Force/Active**.

Note: The status of the policy is not changed from **Pending** to **In Force/Active** until the system date is later than or equal to the policy start date.

On executing the **Policy Periodic Monitor (C1-POLPR)** batch, the system does the following:

- If the self-funded policy is in the **Pending** status and the policy start date - X days is earlier than or equal to the system date, it creates a To Do using the To Do type which is specified in the **To Do Type for Pending Status** parameter (of an algorithm created using the **C1-ASOPOLMOA** algorithm type).
- If the start date of the self-funded policy is earlier than or equal to the system date and the To Do created using the To Do type specified in the **To Do Type for Pending Status** parameter is completed, it changes the status of the self-funded policy from **Pending** to **In Force/Active**.

You can define pricing rules using the pricing rule types of the following categories for a self-funded policy of a bill group which is in the **Active** status:

- Claim
- Specific Stop-Loss
- Aggregate Stop-Loss
- Retention Type Claim Based
- Retention Type Enrollment Based
- Ancillary
- Flat Fees
- Level Funded

Transition of Self-Funded Policy to Runout Status

A self-funded policy can be transitioned to the **Runout** status from the user interface or through the **Policy Periodic Monitor (C1-POLPR)** batch. You can transition a self-funded policy to the **Runout** status by clicking the **Runout** button in the **Policy** screen. On clicking the **Runout** button, the system checks whether the To Do created for the **In Force/Active** status is completed. If the To Do created for the **In Force/Active** status is not completed, it completes the To Do and then changes the status of the self-funded policy from **In Force/Active** to **Runout**.

Note: The status of the policy is not changed from **In Force/Active** to **Runout** when either of the following condition is met:

- The runout end date is not specified.
- The system date is earlier than or equal to the policy end date.
- The policy is renewed.

On executing the **Policy Periodic Monitor (C1-POLPR)** batch, the system does the following:

- If the self-funded policy is in the **In Force/Active** status and the policy end date - X days is earlier than or equal to the system date, it creates a To Do using the To Do type which is specified in the **To Do Type for Active Status** parameter (of an algorithm created using the **C1-ASOPOLMOA** algorithm type).
- If the end date of the self-funded policy is earlier than or equal to the system date and the To Do created using the To Do type specified in the **To Do Type for Active Status** parameter is completed, it changes the status of the self-funded policy from **In Force/Active** to **Runout**.

You can define pricing rules using the pricing rule types of the following categories for a self-funded policy of a bill group which is in the **Runout** status:

- Claim
- Specific Stop-Loss
- Aggregate Stop-Loss
- Retention Type Claim Based
- Ancillary
- Flat Fees
- Level Funded

Transition of Self-Funded Policy to Post Runout Status

A self-funded policy can be transitioned to the **Post Runout** status only through the **Policy Periodic Monitor (C1-POLPR)** batch. On executing the **Policy Periodic Monitor (C1-POLPR)** batch, the system does the following:

- If the self-funded policy is in the **Runout** status and the runout end date - X days is earlier than or equal to the system date, it creates a To Do using the To Do type which is specified in the **To Do Type for Runout Status** parameter (of an algorithm created using the **C1-ASOPOLMOA** algorithm type).
- If the runout end date of the self-funded policy is earlier than or equal to the system date and the To Do created using the To Do type specified in the **To Do Type for Runout Status** parameter is completed, it changes the status of the self-funded policy from **Runout** to **Post Runout**.

You can define pricing rules using the pricing rule types of the following categories for a self-funded policy of a bill group which is in the **Post Runout** status:

- Claim
- Specific Stop-Loss
- Aggregate Stop-Loss

- Retention Type Claim Based
- Ancillary

Self-Funded Policy Renewal

You can renew a self-funded policy which is associated with a bill group. However, note that you can renew a self-funded policy only when it is in the **In Force/Active** status and which is not yet renewed. You can renew a self-funded policy only from the user interface and not through a health care inbound message.

On renewing a self-funded policy, a new policy is created in the **Pending** status. The renewal date is stamped in the base policy. The information from the base policy is copied to the renewed policy. The start date of the renewed policy is set to the base policy's end date plus one day. For example, if the base policy's end date is 12-31-2018, then by default, the renewed policy's start date is set to 01-01-2019.

While renewing a self-funded policy, you cannot disassociate persons (from the renewed policy) who are associated with the base policy using a policy person role which is specified in the **Bill Group Policy Person Role** or **Parent Customer Policy Person Role** option type of the **C1-ASOBLLNG** feature configuration.

While renewing a self-funded policy, the system enables you to copy the following pricing rules of the base policy and thereby create new pricing rules for the renewed policy:

- Claim
- Retention Type Claim Based
- Retention Type Enrollment Based
- Recurring Flat Fees
- Ancillary

While copying a pricing rule, the start and end dates of the new pricing rule are set to the renewed policy's start and end dates, respectively. If there are multiple pricing rules which are created using the same pricing rule type and are effective for the different date range, the system copies only one pricing rule from the base policy with the latest date range.

Once a policy is renewed, you cannot edit the base policy's end date or manually change the status of the base policy to **Runout**. The system automatically changes the status of the base policy to **Runout** when the status of the latest renewed policy is changed to **Runout**.

Self-Funded Policy Contract Creation

The system automatically creates contracts when a self-funded policy is created either from the user interface or through a health care inbound message. It creates a contract for a self-funded policy on each account of the bill group. It creates a contract using the contract type which is specified in the **Contract Type** parameter of an algorithm which is created using the **C1-ASOBOPOSP** algorithm type. Let us assume that the **Contract Type** parameter in the **C1-ASOBOPOSP** algorithm is set to CT1. Now, when you create the self-funded policies named P1 and P2 for BG1 and P11, P12, and P13 for BG2 through a health care inbound message, the system will create the following contracts on the respective accounts:

Bill Group	Account	Contract
BG1	A1	C1 (for P1 using the CT1 contract type)
		C2 (for P2 using the CT1 contract type)
	A2	C3 (for P1 using the CT1 contract type)
		C4 (for P2 using the CT1 contract type)
BG2	A4	C11 (for P11 using the CT1 contract type)

Bill Group	Account	Contract
		C12 (for P12 using the CT1 contract type)
		C13 (for P13 using the CT1 contract type)
		A5
	A5	C14 (for P11 using the CT1 contract type)
		C15 (for P12 using the CT1 contract type)
		C16 (for P13 using the CT1 contract type)
	A6	C17 (for P11 using the CT1 contract type)
		C18 (for P12 using the CT1 contract type)
		C19 (for P13 using the CT1 contract type)

The following figure graphically represents the above example:

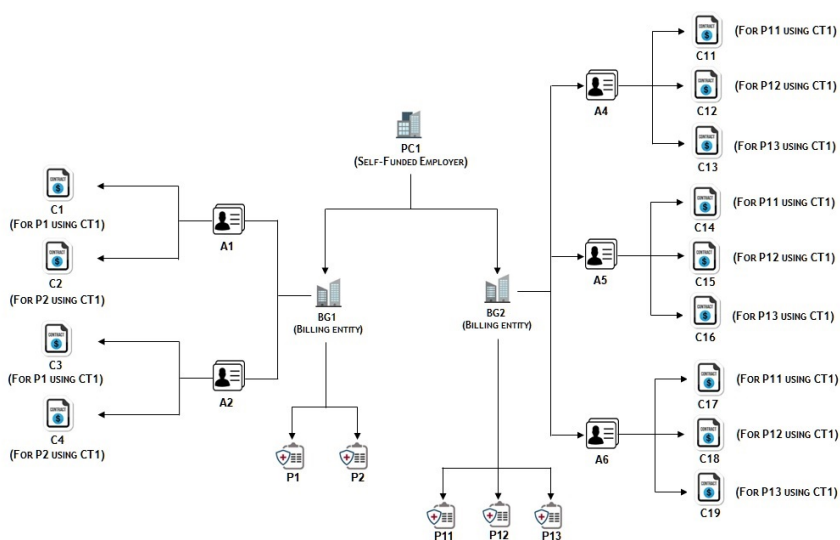

You can also specify comma-separated values for the **Contract Type** parameter. The system will then create a contract using each contract type for each self-funded policy on each account of the bill group. Let us assume that the **Contract Type** parameter in the **C1-ASOBOPOSP** algorithm is set to CT1 , CT2. Now, when you create the self-funded policies named P1 and P2 for BG1 and P11 and P12 for BG2 through a health care inbound message, the system will create the following contracts on the respective accounts:

Bill Group	Account	Contract
BG1	A1	C1 (for P1 using the CT1 contract type)
		C2 (for P1 using the CT2 contract type)
		C3 (for P2 using the CT1 contract type)
		C4 (for P2 using the CT2 contract type)
	A2	C5 (for P1 using the CT1 contract type)

Bill Group	Account	Contract
		C6 (for P1 using the CT2 contract type)
		C7 (for P2 using the CT1 contract type)
		C8 (for P2 using the CT2 contract type)
BG2	A11	C11 (for P11 using the CT1 contract type)
		C12 (for P11 using the CT2 contract type)
		C13 (for P12 using the CT1 contract type)
		C14 (for P12 using the CT2 contract type)
	A12	C15 (for P11 using the CT1 contract type)
		C16 (for P11 using the CT2 contract type)
		C18 (for P12 using the CT1 contract type)
		C19 (for P12 using the CT2 contract type)

The following figure graphically represents the above example:

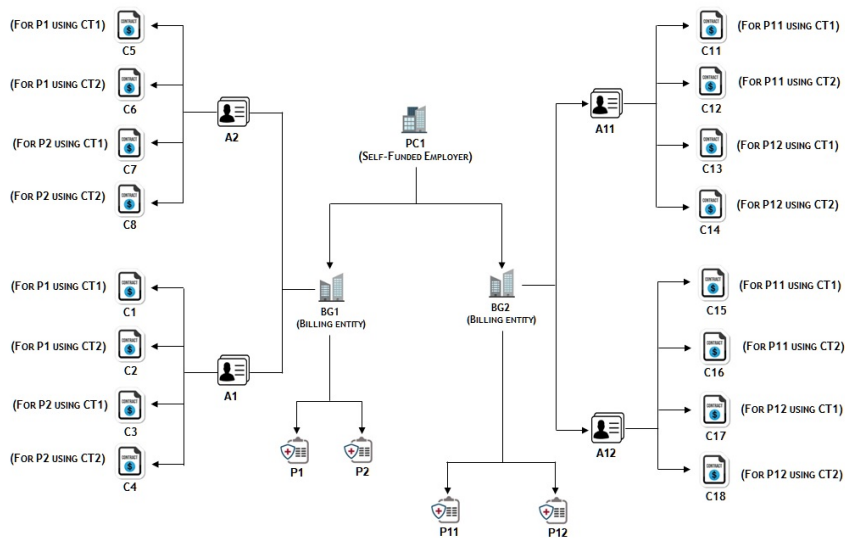

Self-Funded Policy Status Transition

The following figure graphically indicates how a self-funded policy moves from one status to another in its lifecycle:

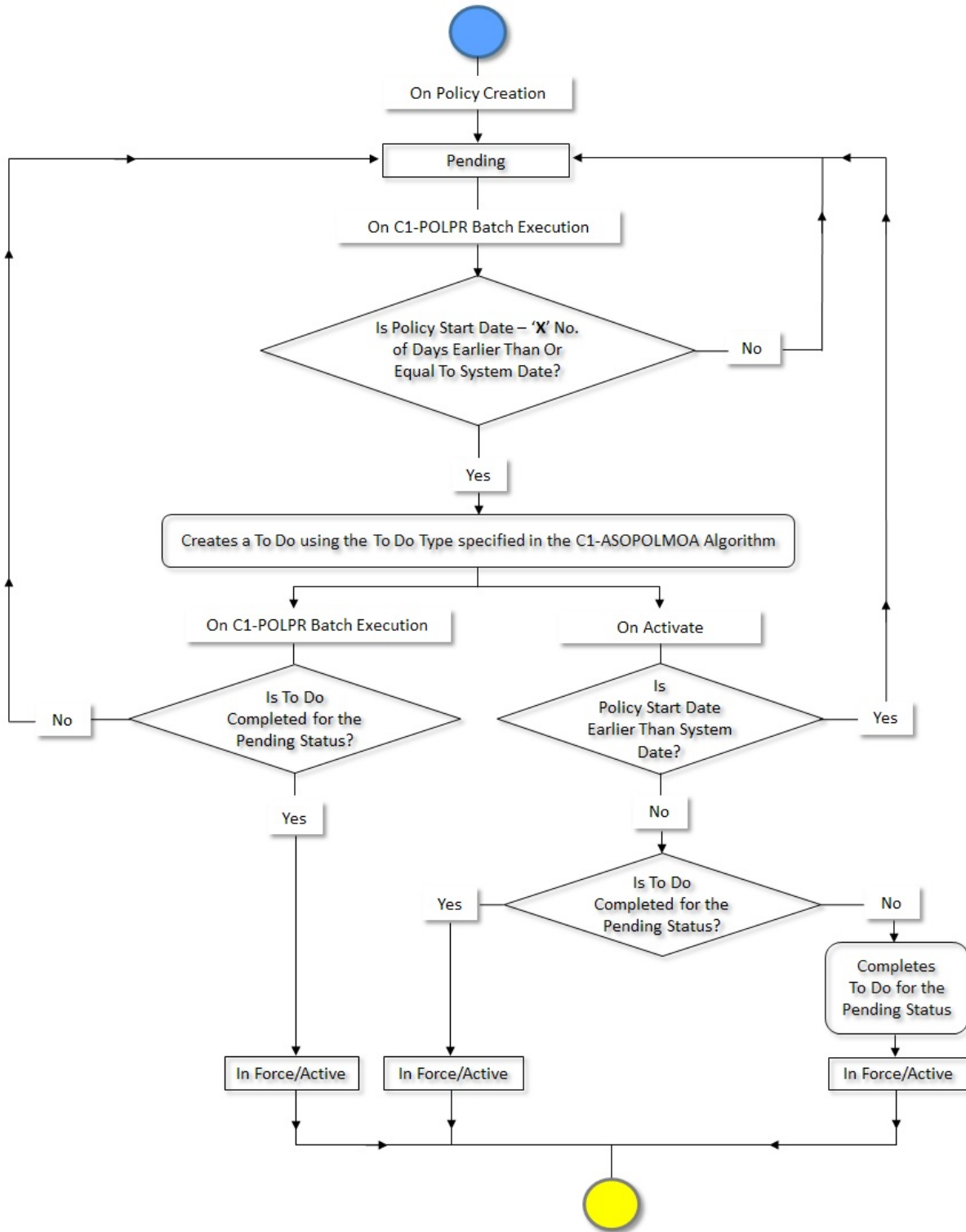

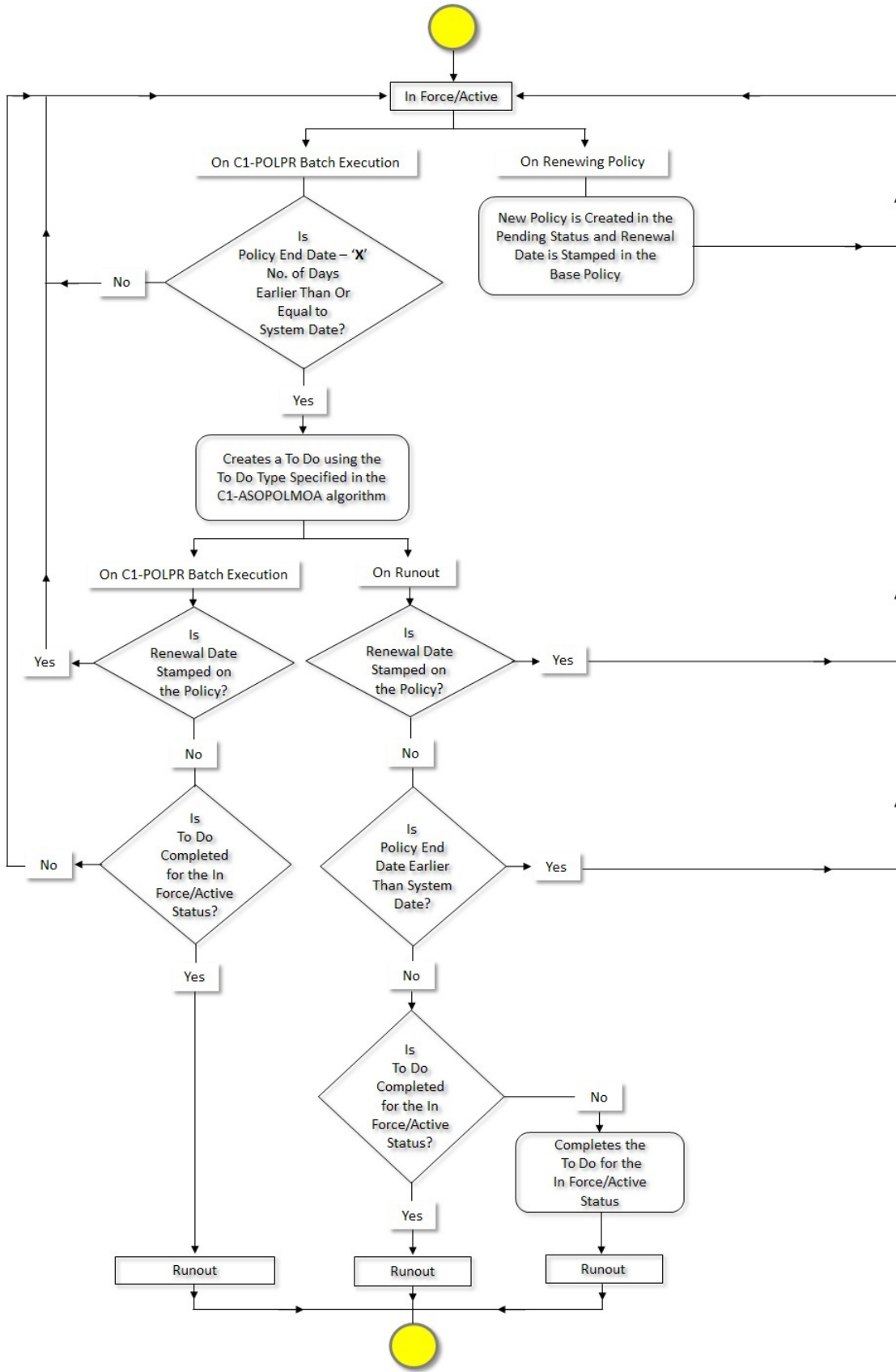

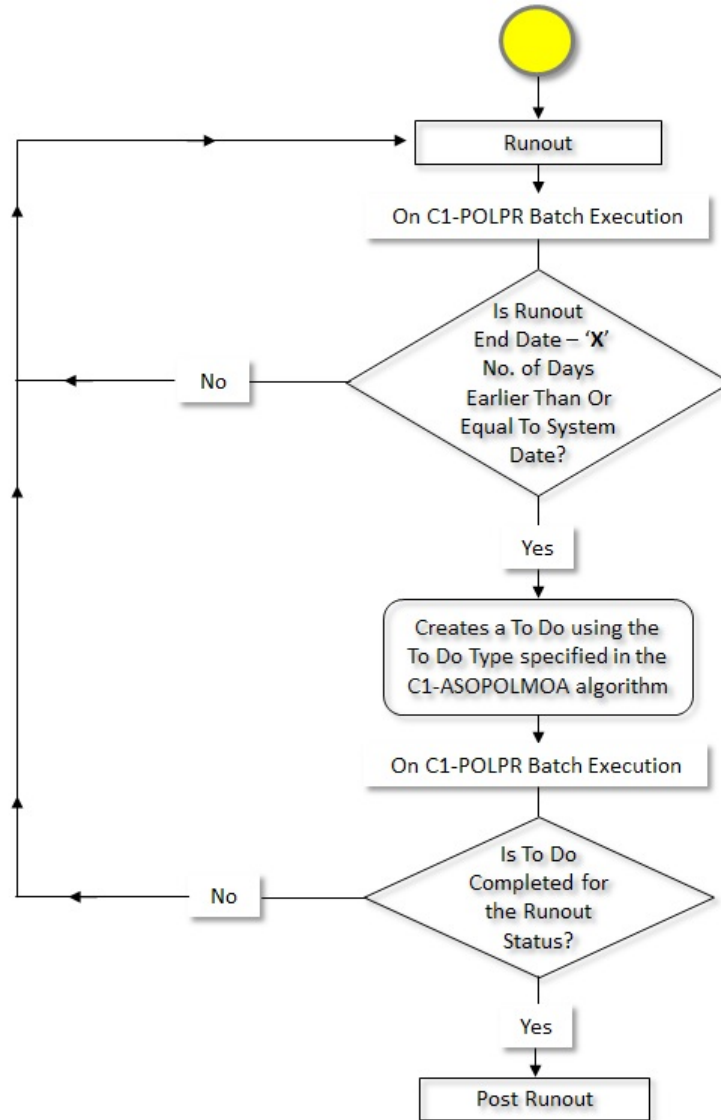

Algorithms Used in C1-ASOPolicy

The following table lists the algorithms which are attached to the **C1-ASOPolicy** business object:

System Event	Algorithm	Algorithm Type	Description
Validation	C1-ASOPOLVAL	C1-ASOPOLVAL	Refer to C1-ASOPOLVAL on page 405.
Post-Processing	C1-ASOBOPOSP	C1-ASOPOLPOS	Refer to C1-ASOBOPOSP on page 406.

System Event	Algorithm	Algorithm Type	Description
	C1-ASOPRUCPY	C1-ASOPRUCPY	Refer to C1-ASOPRUCPY on page 406.

The following table lists the algorithms which are used in the lifecycle of the **C1-ASOPolicy** business object:

Status	System Event	Algorithm	Algorithm Type	Description
Pending	Monitor	C1-ASOPOLMOA	C1-ASOPOLMOA	Refer to C1-ASOPOLMOA on page 406.
	Enter	C1-ASOPOLREN	C1-ASOPOLREN	Refer to C1-ASOPOLREN on page 407.
	Exit	C1-ASOPCKTD	C1-ASOPCKTD	Refer to C1-ASOPCKTD on page 407.
In Force/ Active	Monitor	C1-ASOPOLMOA	C1-ASOPOLMOA	Refer to C1-ASOPOLMOA on page 406.
	Exit	C1-ASOPCKTD	C1-ASOPCKTD	Refer to C1-ASOPCKTD on page 407.
Runout	Monitor	C1-ASOPOLMOA	C1-ASOPOLMOA	Refer to C1-ASOPOLMOA on page 406.
	Exit	C1-ASOPCKTD	C1-ASOPCKTD	Refer to C1-ASOPCKTD on page 407.
Post Runout	-	-	-	-

C1-ASOPOLVAL

This algorithm validates a self-funded policy throughout its lifecycle. It checks the following:

- The policy end date is not earlier than the policy start date.
- The runout end date is later than the policy end date.
- The runout end date is later than the system date while editing the policy which is in the **Runout** status.
- The runout end date is not removed when the policy is in the **Runout** or **Post Runout** status.
- The policy end date is not modified when the policy is in the **Runout** status.
- The policy end date is not set to a date which is later than or equal to the start date of a pricing rule which is defined for the **Runout** status.
- The runout end date is not set to a date which is later than or equal to the start date of a pricing rule which is defined for the **Post Runout** status.
- The runout end date is not set to a date which is earlier than the end date of a pricing rule which is defined for the **Runout** status.
- The policy is not edited when it is in the **Post Runout** status.
- The policy start date is not modified when the policy is in the **In Force/Active**, **Runout**, or **Post Runout** status.
- The policy person end date is not earlier than the policy person start date.

- The policy person role is specified while associating a person with the policy.
- One of the policy persons is set as the main customer of the policy.
- The policy end date is not changed when the policy is renewed.

C1-ASOBOPOSP

This algorithm is invoked when you create a self-funded policy either from the user interface or through an inbound message. It creates a contract of the specified contract type for the self-funded policy on each account of the bill group. For example, if you create a self-funded policy named P1 for a bill group who has two accounts - A1 and A2, the system will create two contracts for P1 - one on the A1 account and another on the A2 account.

It contains the following parameter:

- **Contract Type** - Used to indicate the contract type whose contract you want to create for the self-funded policy on each account of the bill group. You can also specify comma-separated values for this parameter. It will then create a contract of each contract type for the self-funded policy on each account of the bill group.

C1-ASOPRUCPY

This algorithm is invoked when the **Copy Pricing Rules** option is selected while renewing a self-funded policy. It copies the following pricing rules of the base policy and creates new pricing rules for the renewed policy:

- Claim
- Retention Type Claim Based
- Retention Type Enrollment Based
- Recurring Flat Fees
- Ancillary

While copying a pricing rule, the start and end dates of the new pricing rule are set to the renewed policy's start and end dates, respectively. If there are multiple pricing rules which are created using the same pricing rule type and are effective for the different date range, the system copies only one pricing rule from the base policy with the latest date range.

C1-ASOPOLMOA

This algorithm is invoked when the **Policy Periodic Monitor (C1-POLPR)** batch is executed. It does the following:

- If the self-funded policy is in the **Pending** status and the policy start date - X days is earlier than or equal to the system date, it creates a To Do using the To Do type which is specified in the **To Do Type for Pending Status** parameter.
- If the start date of the self-funded policy is earlier than or equal to the system date and the To Do created using the To Do type specified in the **To Do Type for Pending Status** parameter is completed, it changes the status of the self-funded policy from **Pending** to **In Force/Active**.
- If the self-funded policy is in the **In Force/Active** status and the policy end date - X days is earlier than or equal to the system date, it creates a To Do using the To Do type which is specified in the **To Do Type for Active Status** parameter.
- If the end date of the self-funded policy is earlier than or equal to the system date and the To Do created using the To Do type specified in the **To Do Type for Active Status** parameter is completed, it changes the status of the self-funded policy from **In Force/Active** to **Runout**.
- If the self-funded policy is in the **Runout** status and the runout end date - X days is earlier than or equal to the system date, it creates a To Do using the To Do type which is specified in the **To Do Type for Runout Status** parameter.

- If the runout end date of the self-funded policy is earlier than or equal to the system date and the To Do created using the To Do type specified in the **To Do Type for Runout Status** parameter is completed, it changes the status of the self-funded policy from **Runout** to **Post Runout**.

It contains the following parameters:

- **To Do Type for Pending Status** - Used to indicate the To Do type using which you want to create the To Do, X days prior to the policy start date.
- **To Do Type for Active Status** - Used to indicate the To Do type using which you want to create the To Do, X days prior to the policy end date.
- **To Do Type for Runout Status** - Used to indicate the To Do type using which you want to create the To Do, X days prior to the runout end date.
- **X Days** - Used to specify the number of days prior to which you want to create a To Do for the self-funded policy.

All these parameters are mandatory.

C1-ASOPOLREN

This algorithm is invoked when you renew a self-funded policy. Once the new policy is created in the **Pending** status, it stamps the renewal date on the base policy.

C1-ASOPCKTD

This algorithm is invoked when you click the **Activate** and **Runout** buttons in the **Policy** screen. On clicking the **Activate** button, it checks whether the To Do created for the **Pending** status is completed. If the To Do created for the **Pending** status is not completed, it completes the To Do and then changes the status of the self-funded policy from **Pending** to **In Force/Active**.

Similarly, on clicking the **Runout** button, it checks whether the To Do created for the **In Force/Active** status is completed. If the To Do created for the **In Force/Active** status is not completed, it completes the To Do and then changes the status of the self-funded policy from **In Force/Active** to **Runout**.

It also validates the following:

- The status of the policy is not changed from **Pending** to **In Force/Active** until the system date is later than or equal to the policy start date.
- The status of the policy is not changed from **In Force/Active** to **Runout** when the runout end date is not specified.
- The status of the policy is not changed from **In Force/Active** to **Runout** until the system date is later than the policy end date.
- The status of the policy is not changed to **Runout** if it is renewed.

In addition, it also changes the status of the base policies to **Runout** when the status of the latest renewed policy is changed to **Runout**.

Policy (Used for Searching)

The **Policy** screen allows you to search for a policy using various search criteria. It also allows you to define a policy. It contains the following zone:

- [Search Policy](#) on page 303

Through this screen, you can navigate to the following screen:

- [Policy \(Used for Viewing\)](#) on page 314

Search Policy

The **Search Policy** zone allows you to search for a policy using various search criteria. It contains the following two sections:

- **Search Criteria** - The **Search Criteria** section contains the following fields:

Field Name	Field Description	Mandatory (Yes or No)
Search By	Used to indicate whether you want to search for a policy using the policy or person details. The valid values are: <ul style="list-style-type: none"> • Policy Date/Policy Type/Status • Source System/Policy Number/Description • Person Name/Person Identifier • Policy Characteristics 	Yes
	Note: By default, the Policy Date/Policy Type/Status option is selected.	
Policy Type	Used to search policies which are created using a particular policy type.	No
	Note: This field appears when the Policy Date/Policy Type/Status option is selected from the Search By list.	
Start Date	Used to search policies which are effective from a particular date.	No
	Note: This field appears when the Policy Date/Policy Type/Status option is selected from the Search By list.	
Status	Used to search policies with a particular status. The valid values are: <ul style="list-style-type: none"> • In Force/Active • Canceled • Pending Cancellation • Pending • Pending Reinstatement • Pending Termination • Post Runout • Reinstated • Runout • Terminated 	No
	Note: This field appears when the Policy Date/Policy Type/Status option is selected from the Search By list.	

Field Name	Field Description	Mandatory (Yes or No)
End Date	Used to search policies which are effective till a particular date.	No
	Note: This field appears when the Policy Date/Policy Type/Status option is selected from the Search By list.	
Source System	Used to search policies which originated from a particular external system.	No
	Note: This field appears when the Source System/Policy Number/Description option is selected from the Search By list.	
Policy Number	Used to search a policy with a particular policy number.	No
	Note: This field appears when the Source System/Policy Number/Description option is selected from the Search By list.	
Description	Used to search policies with a particular description.	No
	Note: This field appears when the Source System/Policy Number/Description option is selected from the Search By list.	
Person Name	Used to search policies to which a particular person is associated.	No
	Note: This field appears when the Person Name/Person Identifier option is selected from the Search By list.	
Person Identifier Type	Used to indicate the person identifier type.	Yes (Conditional)
	Note: This field appears when the Person Name/Person Identifier option is selected from the Search By list.	Note: If you specify the person identifier as a search criteria, you have to select the person identifier type.
Person Identifier	Used to search policies to which a person is associated.	Yes (Conditional)
	Note: This field appears when the Person Name/Person Identifier option is selected from the Search By list.	Note: If you specify the person identifier type as a search criteria, you have to specify the person identifier.

Field Name	Field Description	Mandatory (Yes or No)
Characteristic Type	Used to search policies for which a particular characteristic type is defined.	Yes (Conditional) Note: This field is required when you are searching for a policy using a characteristic.
	Note: This field appears when the Policy Characteristics option is selected from the Search By list. The list includes only those characteristic types where the characteristic entity is set to Policy .	
Characteristic Value	Used to search policies with a particular characteristic value.	Yes (Conditional) Note: This field is required when you are searching for a policy using a characteristic.
	Note: This field appears when the characteristic type is selected. If you select a predefined characteristic type, the Search (🔍) icon appears corresponding to the Characteristic Value field. On clicking the Search icon, the Predefined Characteristic Search window appears. On specifying the value for a predefined characteristic type, the description of the characteristic value appears corresponding to the Characteristic Value field.	

Note: You must specify at least one search criterion while searching for a policy.

- **Search Results** - On clicking the **Search** button, the search results appear based on the specified search criteria. The **Search Results** section contains the following columns:

Column Name	Column Description
Policy Number	Displays the policy number.
Policy Information	Displays additional information about the policy.
	Note: It has a link. On clicking the link, the Policy screen appears where you can view the details of the respective policy.
Source System	Indicates the external system from where the policy is originated.
Description	Displays the description of the policy.
Start Date	Displays the date from when the policy is effective.
End Date	Displays the date till when the policy is effective.

Column Name	Column Description						
Status	<p>Indicates the status of the policy. If the policy is created using the C1-POLICY business object, the valid values are:</p> <ul style="list-style-type: none"> • Pending • In Force/Active • Pending Cancellation • Canceled • Pending Reinstatement • Reinstated • Pending Termination • Terminated <p>However, if the policy is created using the C1-ASOPolicy business object, the valid values are:</p> <ul style="list-style-type: none"> • Pending • In Force/Active • Runout • Post Runout 						
Main Customer	<p>This column displays different data depending on whether you search for a policy using the policy or person details. The following table describes this column:</p> <table border="1" data-bbox="574 1037 1455 1717"> <thead> <tr> <th data-bbox="574 1037 1019 1085">If you search for a policy using...</th> <th data-bbox="1019 1037 1455 1085">Then...</th> </tr> </thead> <tbody> <tr> <td data-bbox="574 1085 1019 1465"> <p>The Policy Date/Policy Type/Status, Source System/Policy Number/Description, or Policy Characteristics option</p> </td> <td data-bbox="1019 1085 1455 1465"> <p>The Main Customer column displays the name of the person who is the main customer of the policy. In addition, this column has a context menu which helps in navigating to other screens in the application.</p> <div data-bbox="1024 1304 1450 1451" style="border: 1px solid black; padding: 5px;"> <p>Note: It has a link. On clicking the link, the Person screen appears where you can view the details of the respective person.</p> </div> </td> </tr> <tr> <td data-bbox="574 1465 1019 1717"> <p>The Person Name/Person Identifier option</p> </td> <td data-bbox="1019 1465 1455 1717"> <p>The Main Customer column indicates whether the person is the main customer of the policy. The valid values are:</p> <ul style="list-style-type: none"> • Yes • No </td> </tr> </tbody> </table>	If you search for a policy using...	Then...	<p>The Policy Date/Policy Type/Status, Source System/Policy Number/Description, or Policy Characteristics option</p>	<p>The Main Customer column displays the name of the person who is the main customer of the policy. In addition, this column has a context menu which helps in navigating to other screens in the application.</p> <div data-bbox="1024 1304 1450 1451" style="border: 1px solid black; padding: 5px;"> <p>Note: It has a link. On clicking the link, the Person screen appears where you can view the details of the respective person.</p> </div>	<p>The Person Name/Person Identifier option</p>	<p>The Main Customer column indicates whether the person is the main customer of the policy. The valid values are:</p> <ul style="list-style-type: none"> • Yes • No
If you search for a policy using...	Then...						
<p>The Policy Date/Policy Type/Status, Source System/Policy Number/Description, or Policy Characteristics option</p>	<p>The Main Customer column displays the name of the person who is the main customer of the policy. In addition, this column has a context menu which helps in navigating to other screens in the application.</p> <div data-bbox="1024 1304 1450 1451" style="border: 1px solid black; padding: 5px;"> <p>Note: It has a link. On clicking the link, the Person screen appears where you can view the details of the respective person.</p> </div>						
<p>The Person Name/Person Identifier option</p>	<p>The Main Customer column indicates whether the person is the main customer of the policy. The valid values are:</p> <ul style="list-style-type: none"> • Yes • No 						

Column Name	Column Description
Person Information	Indicates the person who is associated with the policy. In addition, this column has a context menu which helps in navigating to other screens in the application.
	<p>Note:</p> <p>It has a link. On clicking the link, the Person screen appears where you can view the details of the respective person.</p> <p>This column appears when the Person Name/Person Identifier option is selected from the Search By list.</p>
Policy Person Role	Indicates the role using which the person is associated with the policy.
	<p>Note: This column appears when the Person Name/Person Identifier option is selected from the Search By list.</p>

Note: Pagination is used to display limited number of records in the **Search Results** section. You can use the navigation links, such as **Previous** and **Next** to navigate between pages.

Related Topics

For more information on...	See...
How to search for a policy	Searching for a Policy on page 307
How to define a policy	Defining a Policy on page 308
How to view the details of a policy	Viewing the Policy Details on page 308

Searching for a Policy

Prerequisites

To search for a policy, you should have:

- Policy types and person identifier types defined in the application
- Values defined for the **C1-SourceSystemLookup** extendable lookup
- Characteristic types defined in the application (where the characteristic entity is set to **Policy**)

Procedure

To search for a policy:

1. Click the **Menu** link in the **Application** toolbar.
A list appears.
2. From the **Main** menu, select **Customer Management** and then click **Policy**.
A sub-menu appears.
3. Click the **Search** option from the **Policy** sub-menu.
The **Policy** screen appears.
4. Enter the search criteria in the **Search Policy** zone.

Note: ORMB search engine supports wildcard search, where you can substitute the percentage (%) symbol as a stand in for any word or letter in a search criteria. You can use the ‘%’ wildcard character in all input fields except the date and ID fields. The ‘%’ wildcard character is suffixed automatically at the end of the partial search criteria. Therefore, you may or may not specify the wildcard character at the end of the partial search criteria. However, you have to prefix the wildcard character manually wherever required.

5. Click **Search**.

A list of policies that meet the search criteria appears in the **Search Results** section.

Related Topics

For more information on...	See...
Policy screen	Policy (Used for Viewing) on page 314
Search Policy zone	Search Policy on page 303

Viewing the Policy Details

Procedure

To view the details of a policy:

1. Search for the policy in the **Policy** screen.
2. In the **Search Results** section, click the link in the **Policy Information** column corresponding to the policy whose details you want to view.

The **Policy** screen appears.

3. Ensure that the **Main** tab is selected.
4. View the details of the policy in the **Policy** zone.

Related Topics

For more information on...	See...
How to search for a policy	Searching for a Policy on page 307
Policy screen	Policy (Used for Viewing) on page 314
Policy zone	Policy on page 315

Defining a Policy

Oracle Revenue Management and Billing enables you to define a policy for the fully-insured and self-funded health insurance business. You can define a fully-insured group policy using a policy type where the policy category is set to **Fully-Insured Group** or **Fully-Insured Individual**. However, you can define a self-funded policy using a policy type where the policy category is set to **Self-Funded**.

Note: At present, the **Fully-Insured Individual** policy category is not supported in the system.

Prerequisites

To define a policy, you should have:

- Policy types defined in the application
- Values defined for the **C1-SourceSystemLookup** extendable lookup

Note: This prerequisite is applicable only when you want to define a fully-insured group policy.

- Values defined for the **RUNOUT_ADM_OPT_FLG** lookup field

Note: This prerequisite is applicable when you want to define a self-funded policy.

Procedure

To define a policy:

1. Click the **Menu** link in the **Application** toolbar.
A list appears.
2. From the **Main** menu, select **Customer Management** and then click **Policy**.
A sub-menu appears.
3. Click the **Add** option from the **Policy** sub-menu.

The **Select Policy Type** screen appears. It contains the following field:

Field Name	Field Description	Mandatory (Yes or No)
Policy Type	Used to indicate the policy type using which you want to create a policy. Note: If you want to create a fully-insured group policy, you must select a policy type where the policy category is set to Fully-Insured Group or Fully-Insured Individual . However, if you want to create a self-funded policy, you must select a policy type where the policy category is set to Self-Funded .	Yes

Tip: Alternatively, you can access this screen by clicking the **Add** button in the **Page Title** area of the **Policy** screen.

4. Select the required policy type from the respective field.
5. Click **OK**.

The **Policy** screen appears. It contains the following sections:

- **Main** - Used to specify the basic details about the policy.
- **Persons** - Used to associate persons with the policy.
- **Characteristics** - Used to define the characteristics for the policy.

The **Main** section contains the following fields:

Field Name	Field Description	Mandatory (Yes or No)
Policy Type	Indicates the policy type using which you are defining the policy.	Not applicable
Policy Number	Used to specify the policy number.	Yes
Description	Used to specify the description for the policy.	Yes

Field Name	Field Description	Mandatory (Yes or No)
Source System	Used to indicate the external system from where the policy is originated.	Yes
	Note: This field appears when you are defining a policy using a policy type where the policy category is set to Fully-Insured Group or Fully-Insured Individual .	
Start Date	Used to specify the date from when the policy is effective.	Yes
	Note: The policy start date cannot be later than the policy end date.	
End Date	Used to specify the date till when the policy is effective.	Yes
	Note: The policy end date cannot be earlier than the policy start date.	
Runout End Date	Used to specify the date when the runout period of the self-funded policy ends.	No
	Note: The runout end date cannot be earlier than or equal to the policy end date. This field appears when you are defining a policy using a policy type where the policy category is set to Self-Funded .	
Runout Administration Fees	Used to indicate whether the administration fees must be charged when the claim transaction for the self-funded policy is processed in the runout period. The valid values are: <ul style="list-style-type: none"> • None • Percentage of Claim 	No
	Note: At present, this field is used only for the informational purposes and is not considered during the billable charge creation for the claim transactions which are received in the runout period of the policy. This field appears when you are defining a policy using a policy type where the policy category is set to Self-Funded .	

Field Name	Field Description	Mandatory (Yes or No)
Advance Level Funding Eligibility	Indicates whether the self-funded policy is eligible for advance billing feature of level funding.	Not applicable
	<p>Note:</p> <p>This is a read-only field. By default, the value is set to No. You can edit the advance level funding eligibility only through a health care inbound message.</p> <p>This field appears when you are defining a policy using a policy type where the policy category is set to Self-Funded.</p>	

6. Enter the required details in the **Main** section.
7. Associate the required persons with the policy.

Note: While defining a policy, you must associate a person who is the main customer of the policy.

8. Define the characteristics for the policy, if required.
9. Click **Save**.

The policy is defined and its status is set to **Pending**.

Related Topics

For more information on...	See...
Policy screen	Policy (Used for Viewing) on page 314
How to associate a person with a policy	Associating a Person with a Policy on page 311
How to define a characteristic for a policy	Defining a Characteristic for a Policy on page 313

Associating a Person with a Policy

Prerequisites

To associate a person with a policy, you should have:

- Required persons defined in the application
- Required policy person roles defined in the application

Procedure

To associate a person with a policy:

1. Ensure that the **Persons** section is expanded when you are defining or editing a policy.

The **Persons** section contains the following fields in a grid:

Field Name	Field Description	Mandatory (Yes or No)
Person	Used to indicate the person that you want to associate with the policy.	Yes
	<p>Note:</p> <p>The Search (🔍) icon appears corresponding to this field. On clicking the Search icon, the Person Search window appears.</p> <p>On specifying the person ID, the person name appears corresponding to the Person field.</p>	
Sequence	Used to specify the sequence number for the associated person.	Yes
Policy Person Role	Used to indicate the role of a person in the policy.	Yes
Main Customer	Used to indicate whether the person is the main customer of the policy.	Yes (Conditional)
	<p>Note: At a time, only one person can be the main customer of the policy.</p>	
Start Date	Used to specify the date from when the person is associated with the policy.	Yes
	<p>Note:</p> <p>The start date cannot be later than the end date.</p> <p>The start date cannot be earlier than the policy start date and later than the policy end date.</p>	
End Date	Used to specify the date till when the person is associated with the policy.	No
	<p>Note:</p> <p>The end date cannot be earlier than the start date.</p> <p>The end date cannot be earlier than the policy start date and later than the policy end date. This validation is done when the policy is transition to the status which is not specified in the Skip Status for Policy Person End Date Validation parameter of the C1-POLBOVAL algorithm. For example, if you set the Skip Status for Policy Person End Date Validation parameter of the C1-POLBOVAL algorithm to TERMINATED, the system will not perform this validation when the status of the policy is changed to Terminated.</p>	

2. Enter the required details in the **Persons** section.

Note: While associating the persons with a policy, you must always ensure that one person is the main customer of the policy.

- If you want to associate more than one person with the policy, click the **Add (+)** icon and then repeat step 2.

Note: However, if you want to dissociate a person from the policy, click the **Delete (🗑)** icon corresponding to the person.

- Click **Save**.

The persons are associated with the policy.

Related Topics

For more information on...	See...
How to define a policy	Defining a Policy on page 308
How to edit a policy	Editing a Policy on page 325

Defining a Characteristic for a Policy

Prerequisites

To define a characteristic for a policy, you should have:

- Characteristic types defined in the application (where the characteristic entity is set to **Policy**)

Procedure

To define a characteristic for a policy:

- Ensure that the **Characteristics** section is expanded when you are defining or editing a policy.

The **Characteristics** section contains the following fields in a grid:

Field Name	Field Description	Mandatory (Yes or No)
Effective Date	Used to specify the date from when the characteristic is effective for the policy.	Yes (Conditional)
	Note: The effective date cannot be earlier than the policy start date and later than the policy end date.	Note: This field is required when you are defining a characteristic for the policy.
Characteristic Type	Used to indicate the characteristic type.	Yes (Conditional)
	Note: The list includes only those characteristic types where the characteristic entity is set to Policy .	Note: This field is required when you are defining a characteristic for the policy.

Field Name	Field Description	Mandatory (Yes or No)
Characteristic Value	Used to specify the value for the characteristic type.	Yes (Conditional)
	<p>Note:</p> <p>If you select a predefined characteristic type, the Search (🔍) icon appears corresponding to the Characteristic Value field. On clicking the Search icon, the Predefined Characteristic Search window appears.</p> <p>On specifying the value for a predefined characteristic type, the description of the characteristic value appears corresponding to the Characteristic Value field.</p>	<p>Note: This field is required when you are defining a characteristic for the policy.</p>

- Enter the required details in the **Characteristics** section.
- If you want to define more than one characteristic for the policy, click the **Add** (+) icon and then repeat step 2.

Note: However, if you want to remove a characteristic from the policy, click the **Delete** (🗑️) icon corresponding to the characteristic.

- Click **Save**.

The characteristics are defined for the policy.

Related Topics

For more information on...	See...
How to define a policy	Defining a Policy on page 308
How to edit a policy	Editing a Policy on page 325

Policy (Used for Viewing)

The **Policy** screen allows you to:

- View the details of a fully-insured group or self-funded policy
- Edit the details of a fully-insured group or self-funded policy
- Activate a fully-insured group or self-funded policy
- Add or edit plans in a fully-insured group policy
- Add memberships to a fully-insured group policy plan
- Initiate the termination process for a fully-insured group policy
- Terminate a fully-insured group policy
- Initiate the cancellation process for a fully-insured group policy
- Cancel a fully-insured group policy
- Initiate the reinstatement process for a fully-insured group policy
- Reinstate a fully-insured group policy
- View the log of a fully-insured group or self-funded policy

- Add a log entry for a fully-insured group or self-funded policy

It consists of the following tabs:

- [Policy - Main](#) on page 315
- [Policy - Plan](#) on page 322
- [Policy - Log](#) on page 324

Policy - Main

The **Main** tab displays information about the policy. It contains the following zones:

- [Policy](#) on page 315
- [Policy Characteristics](#) on page 321

Policy

The **Policy** zone displays the details of the fully-insured group or self-funded policy. It contains the following sections:

- **Main** - Displays basic information about the policy. It contains the following fields:

Field Name	Field Description
Base Policy Information	Displays information about the base policy.
	Note: This field appears when you are viewing the details of a renewed policy which is created using a policy type where the policy category is set to Self-Funded .
Policy Information	Displays information about the policy.
Policy Type	Indicates the policy type using which the policy is created.
	Note: It has a link. On clicking the link, the Policy Type screen appears where you can view the details of the respective policy type.
Status	<p>Indicates the status of the policy. If the policy is created using the C1-POLICY business object, the valid values are:</p> <ul style="list-style-type: none"> • Pending • In Force/Active • Pending Cancellation • Canceled • Pending Reinstatement • Reinstated • Pending Termination • Terminated <p>However, if the policy is created using the C1-ASOPolicy business object, the valid values are:</p> <ul style="list-style-type: none"> • Pending • In Force/Active • Runout • Post Runout

Field Name	Field Description
Status Reason	Indicates the reason why the policy is terminated.
	<p>Note:</p> <p>It has a link. On clicking the link, the Status Reason screen appears where you can view the details of the respective termination reason.</p> <p>This field appears when you are viewing the details of a terminated or reinstated policy which is created using a policy type where the policy category is set to Fully-Insured Group or Fully-Insured Individual.</p>
Policy Number	Displays the policy number.
Description	Displays the description of the policy.
Source System	Indicates the external system from where the policy is originated.
Start Date	Displays the date from when the policy is effective.
End Date	Displays the date till when the policy is effective.
Renewal Date	Displays the date when the policy is renewed.
	Note: This field appears when you are viewing the details of a policy which is renewed.

Field Name	Field Description																													
Paid Through Date	Indicates the term end date of the last fully or partially paid term. The system considers the term to be fully paid when the threshold limit is met.																													
	<p>Note:</p> <p>This field appears when the following conditions are met:</p> <ul style="list-style-type: none"> When you are viewing the details of a policy which is created using a policy type where the policy category is set to Fully-Insured Group or Fully-Insured Individual. When the paid through date is calculated at the policy level. 																													
	The paid through date is calculated while freezing or canceling a payment or adjustment depending on whether the required algorithm is attached to the respective system event:																													
	<table border="1"> <thead> <tr> <th>Entity</th> <th>System Event</th> <th>Algorithm</th> </tr> </thead> <tbody> <tr> <td>Customer Class</td> <td>Payment Freeze</td> <td>C1-PSPTDCAL</td> </tr> <tr> <td>Customer Class</td> <td>Payment Cancellation</td> <td>C1-PXPTDCAL</td> </tr> <tr> <td>Adjustment Type</td> <td>Adjustment Freeze</td> <td>C1-ADPTDCAL</td> </tr> <tr> <td>Adjustment Type</td> <td>Adjustment Cancellation</td> <td>C1-AXPTDCAL</td> </tr> </tbody> </table>	Entity	System Event	Algorithm	Customer Class	Payment Freeze	C1-PSPTDCAL	Customer Class	Payment Cancellation	C1-PXPTDCAL	Adjustment Type	Adjustment Freeze	C1-ADPTDCAL	Adjustment Type	Adjustment Cancellation	C1-AXPTDCAL														
	Entity	System Event	Algorithm																											
Customer Class	Payment Freeze	C1-PSPTDCAL																												
Customer Class	Payment Cancellation	C1-PXPTDCAL																												
Adjustment Type	Adjustment Freeze	C1-ADPTDCAL																												
Adjustment Type	Adjustment Cancellation	C1-AXPTDCAL																												
The following table indicates when the paid through date is calculated at the policy and/or membership level:																														
<table border="1"> <thead> <tr> <th>If the Paid Through Date Calculation Level parameter is set to...</th> <th>If the following characteristics are defined for the billable charge or adjustment...</th> <th>Then...</th> </tr> </thead> <tbody> <tr> <td>P</td> <td>C1-POLID</td> <td>Paid through date is calculated at the policy level</td> </tr> <tr> <td>P</td> <td>C1-MPID</td> <td>Paid through date is calculated at the policy level</td> </tr> <tr> <td>P</td> <td>C1-POLID and C1-MPID</td> <td>Paid through date is calculated at the policy level</td> </tr> <tr> <td>M</td> <td>C1-POLID</td> <td>Paid through date is not calculated at the membership level</td> </tr> <tr> <td>M</td> <td>C1-MPID</td> <td>Paid through date is calculated at the membership level</td> </tr> <tr> <td>M</td> <td>C1-POLID and C1-MPID</td> <td>Paid through date is calculated at the membership level</td> </tr> <tr> <td>P, M</td> <td>C1-POLID</td> <td>Paid through date is calculated at the policy level</td> </tr> <tr> <td>P, M</td> <td>C1-MPID</td> <td>Paid through date is calculated at both the policy and membership levels</td> </tr> <tr> <td>P, M</td> <td>C1-POLID and C1-MPID</td> <td>Paid through date is calculated at both the policy and membership levels</td> </tr> </tbody> </table>	If the Paid Through Date Calculation Level parameter is set to...	If the following characteristics are defined for the billable charge or adjustment...	Then...	P	C1-POLID	Paid through date is calculated at the policy level	P	C1-MPID	Paid through date is calculated at the policy level	P	C1-POLID and C1-MPID	Paid through date is calculated at the policy level	M	C1-POLID	Paid through date is not calculated at the membership level	M	C1-MPID	Paid through date is calculated at the membership level	M	C1-POLID and C1-MPID	Paid through date is calculated at the membership level	P, M	C1-POLID	Paid through date is calculated at the policy level	P, M	C1-MPID	Paid through date is calculated at both the policy and membership levels	P, M	C1-POLID and C1-MPID	Paid through date is calculated at both the policy and membership levels
If the Paid Through Date Calculation Level parameter is set to...	If the following characteristics are defined for the billable charge or adjustment...	Then...																												
P	C1-POLID	Paid through date is calculated at the policy level																												
P	C1-MPID	Paid through date is calculated at the policy level																												
P	C1-POLID and C1-MPID	Paid through date is calculated at the policy level																												
M	C1-POLID	Paid through date is not calculated at the membership level																												
M	C1-MPID	Paid through date is calculated at the membership level																												
M	C1-POLID and C1-MPID	Paid through date is calculated at the membership level																												
P, M	C1-POLID	Paid through date is calculated at the policy level																												
P, M	C1-MPID	Paid through date is calculated at both the policy and membership levels																												
P, M	C1-POLID and C1-MPID	Paid through date is calculated at both the policy and membership levels																												

Field Name	Field Description
Runout End Date	Displays the date when the runout period of the self-funded policy ends.
	Note: This field appears when you are viewing the details of a policy which is created using a policy type where the policy category is set to Self-Funded .
Runout Administration Fees	Indicates whether the administration fees must be charged when the claim transaction for the self-funded policy is processed in the runout period. The valid values are: <ul style="list-style-type: none"> • None • Percentage of Claim
	Note: This field appears when you are viewing the details of a policy which is created using a policy type where the policy category is set to Self-Funded .
Advance Level Funding Eligibility	Indicates whether the self-funded policy is eligible for advance billing feature of level funding.
	Note: This field appears when you are viewing the details of a policy which is created using a policy type where the policy category is set to Self-Funded .

- **Persons** - Lists the persons which are associated with the policy. It contains the following columns:

Column Name	Column Description
Person Information	Indicates the person who is associated with the policy. In addition, this column has a context menu which helps in navigating to other screens in the application.
	Note: It has a link. On clicking the link, the Person screen appears where you can view the details of the respective person.
Sequence	Displays the sequence number of the associated person.
Policy Person Role	Indicates the role of the person in the policy.
Main Customer	Indicates whether the person is the main customer of the policy.
Start Date	Displays the date from when the person is associated with the policy.
End Date	Displays the date till when the person is associated with the policy.

- **Record Actions** - This section contains the following buttons:

Button Name	Button Description						
Edit	<p>Used to edit the details of the fully-insured group or self-funded policy.</p> <p>Note: The Edit button appears only when a policy of the respective category is in either of the following status:</p> <table border="1" data-bbox="521 401 1463 968"> <thead> <tr> <th data-bbox="521 401 907 449">Policy Category</th> <th data-bbox="907 401 1463 449">Status</th> </tr> </thead> <tbody> <tr> <td data-bbox="521 449 907 804">Fully-Insured Group or Fully-Insured Individual</td> <td data-bbox="907 449 1463 804"> <ul style="list-style-type: none"> • In Force/Active • Canceled • Pending Cancellation • Pending • Pending Reinstatement • Pending Termination • Terminated </td> </tr> <tr> <td data-bbox="521 804 907 968">Self-Funded</td> <td data-bbox="907 804 1463 968"> <ul style="list-style-type: none"> • In Force/Active • Pending • Runout </td> </tr> </tbody> </table>	Policy Category	Status	Fully-Insured Group or Fully-Insured Individual	<ul style="list-style-type: none"> • In Force/Active • Canceled • Pending Cancellation • Pending • Pending Reinstatement • Pending Termination • Terminated 	Self-Funded	<ul style="list-style-type: none"> • In Force/Active • Pending • Runout
Policy Category	Status						
Fully-Insured Group or Fully-Insured Individual	<ul style="list-style-type: none"> • In Force/Active • Canceled • Pending Cancellation • Pending • Pending Reinstatement • Pending Termination • Terminated 						
Self-Funded	<ul style="list-style-type: none"> • In Force/Active • Pending • Runout 						
Activate	<p>Used to activate the fully-insured group or self-funded policy.</p> <p>Note: The Activate button appears when a policy of the respective category is in either of the following status:</p> <table border="1" data-bbox="521 1213 1463 1444"> <thead> <tr> <th data-bbox="521 1213 954 1262">Policy Category</th> <th data-bbox="954 1213 1463 1262">Status</th> </tr> </thead> <tbody> <tr> <td data-bbox="521 1262 954 1377">Fully-Insured Group or Fully-Insured Individual</td> <td data-bbox="954 1262 1463 1377"> <ul style="list-style-type: none"> • Pending • Pending Termination </td> </tr> <tr> <td data-bbox="521 1377 954 1444">Self-Funded</td> <td data-bbox="954 1377 1463 1444"> <ul style="list-style-type: none"> • Pending </td> </tr> </tbody> </table>	Policy Category	Status	Fully-Insured Group or Fully-Insured Individual	<ul style="list-style-type: none"> • Pending • Pending Termination 	Self-Funded	<ul style="list-style-type: none"> • Pending
Policy Category	Status						
Fully-Insured Group or Fully-Insured Individual	<ul style="list-style-type: none"> • Pending • Pending Termination 						
Self-Funded	<ul style="list-style-type: none"> • Pending 						
Initiate Cancellation	<p>Used to initiate the cancellation process for the fully-insured group policy.</p> <p>Note: The Initiate Cancellation button appears when the fully-insured group policy is in the In Force/Active status.</p>						
Cancel	<p>Used to cancel the fully-insured group policy.</p> <p>Note: The Cancel button appears when the fully-insured group policy is in the Pending Cancellation status.</p>						

Button Name	Button Description
Initiate Termination	Used to initiate the termination process for the fully-insured group policy.
	Note: The Initiate Termination button appears when the fully-insured group policy is in the In Force/Active status.
Terminate	Used to terminate the fully-insured group policy.
	Note: The Terminate button appears when the fully-insured group policy is in the In Force/Active, Pending Reinstatement, or Pending Termination status.
Initiate Reinstatement	Used to initiate the reinstatement process for the terminated policy.
	Note: The Initiate Reinstatement button appears when the fully-insured group policy is in the Terminated status.
Reinstate	Used to reinstate the terminated policy.
	Note: The Reinstate button appears when the fully-insured group policy is in the Pending Reinstatement or Terminated status.
Runout	Used to transition the self-funded policy to the Runout status.
	<p>Note:</p> <p>The Runout button appears when the self-funded policy is in the In Force/Active status. You cannot transition a self-funded policy to the Runout status when:</p> <ul style="list-style-type: none"> • The self-funded policy is renewed. • The runout end date is not specified. • The policy end date is earlier than the system date.

- **Record Information** - This section contains the following fields:

Field Name	Field Description
Business Object	Indicates the business object using which the policy is created. In addition, a context menu appears corresponding to this field which helps in navigating to other screens in the application.
	Note: It has a link. On clicking the link, the Business Object screen appears where you can view the details of the respective business object.
Status Date/Time	Displays the date and time when the policy status is updated.
Create Date/Time	Displays the date and time when the policy is created.

- **Termination Information** - Displays the termination details of the fully-insured group policy. It appears when the policy is in the **Pending Termination** status. It contains the following fields:

Field Name	Field Description
Terminate Date	Displays the date when you want to terminate the policy.

Field Name	Field Description
Terminate Reason	Indicates the reason why the termination process is initiated for the policy. Note: It has a link. On clicking the link, the Status Reason screen appears where you can view the details of the respective termination reason.

- **Reinstate Information** - Displays the reinstatement details of the terminated policy. It appears when the policy is in the **Pending Reinstatement** status. It contains the following fields:

Field Name	Field Description
Reinstate Reason	Indicates the reason why you want to reinstate the fully-insured group policy. Note: It has a link. On clicking the link, the Status Reason screen appears where you can view the details of the respective reinstatement reason.

Related Topics

For more information on...	See...
How to edit a policy	Editing a Policy on page 325
How to activate a policy	Activating a Policy on page 325
How to initiate a cancellation request for a fully-insured group policy	Initiating the Cancellation Process for a Fully-Insured Group Policy on page 329
How to cancel a fully-insured group policy	Canceling a Fully-Insured Group Policy on page 329
How to initiate a termination request for a fully-insured group policy	Initiating the Termination Process for a Fully-Insured Group Policy on page 330
How to terminate a fully-insured group policy	Terminating a Fully-Insured Group Policy on page 331
How to initiate a reinstatement request for a fully-insured group policy	Initiating the Reinstatement Process for a Fully-Insured Group Policy on page 331
How to reinstate a fully-insured group policy	Reinstating a Fully-Insured Group Policy on page 332

Policy Characteristics

The **Policy Characteristics** zone lists the characteristics of the fully-insured group or self-funded policy. It contains the following columns:

Column Name	Column Description
Effective Date	Displays the date from when the characteristic is effective for the policy.
Characteristic Type	Indicates the characteristic type.
Characteristic Value	Displays the value of the characteristic type.

Column Name	Column Description
Description	Displays the description of the characteristic value.
	Note: The data appears in this column when the type of characteristic value is set to Predefined Value .

You can filter the list using the **Effective Date** field available in the **Filter** area. By default, the **Filter** area is hidden. You can view the **Filter** area by clicking the **Filters** () icon in the upper right corner of this zone.

Policy - Plan

The **Plan** tab lists the plans defined for the policy and memberships defined for each policy plan. It contains the following zones:

- [Plans](#) on page 322
- [Memberships](#) on page 323

Plans

The **Plans** zone lists the plans which are defined in the policy. It contains the following columns:

Column Name	Column Description
Plan Information	Displays information about the policy plan. In addition, a context menu appears corresponding to this column which helps in navigating to other screens in the application.
	Note: It has a link. On clicking the link, the Policy Plan screen appears where you can view the details of the respective policy plan.
Price Item Information	Indicates the price item to which the policy plan is directly associated.
	Note: It has a link. On clicking the link, the Price Item screen appears where you can view the details of the respective price item.
Plan Number	Displays the plan number.
Plan Name	Displays the description of the policy plan.
Benefit Type	Indicates the type of health insurance plan. The valid values are: <ul style="list-style-type: none"> • Commercial • Medicare Affiliated
Start Date	Displays the date from when the policy plan is effective.
End Date	Displays the date till when the policy plan is effective.
Edit	On clicking the Edit () icon, the Plan screen appears where you can edit the details of the policy plan.

Note: Pagination is used to display limited number of records in this zone. You can use the navigation links, such as **Previous** and **Next** to navigate between pages.

You can define a new policy plan by clicking the **Add** link in the upper-right corner of this zone. On clicking the **Broadcast** () icon corresponding to a policy plan, the **Memberships** zone appears.

Note: Ideally, you define plans in a policy which is created using a policy type where the policy category is set to **Fully-Insured Group** or **Fully-Insured Individual**.

You can filter the list using various search criteria (such as, **Price Item**, **Plan Number**, and **Effective From**) available in the **Filter** area. By default, the **Filter** area is hidden. You can view the **Filter** area by clicking the **Filters** (🔍) icon in the upper-right corner of this zone.

Related Topics

For more information on...	See...
How to define a plan for a fully-insured group policy	Defining a Plan for a Fully-Insured Group Policy
How to edit a plan of a fully-insured group policy	Editing a Plan of a Fully-Insured Group Policy on page 343
Memberships zone	Memberships on page 323
How to view the plans of a fully-insured group policy	Viewing the Plans of a Fully-Insured Group Policy on page 333
How to view the memberships of a fully-insured group policy plan	Viewing the Membership Details of a Fully-Insured Group Policy Plan on page 335

Memberships

The **Memberships** zone lists the memberships which are defined for the policy plan. It contains the following columns:

Column Name	Column Description
Start Date	Displays the date from when the membership is effective.
End Date	Displays the date till when the membership is effective.
Membership Information	Displays information about the membership. Note: It has a link. On clicking the link, the Membership screen appears where you can view the details of the respective membership.
Enrolled Members	Displays the number of members who have enrolled in the policy plan.
Status	Indicates the status of the membership. The valid values are: <ul style="list-style-type: none"> • Active • Inactive • Terminated
Membership Type	Indicates the type of membership. The valid values are: <ul style="list-style-type: none"> • COBRA • Medicare • Retiree

Column Name	Column Description
Benefits	On clicking the Benefits () icon, the Benefit screen appears where you can view the Medicare benefits of the member persons who belong to the membership. Note: The Benefits icon appears when a Medicare benefit is defined for a member person who belongs to the membership.
Membership ID	Displays the membership ID.

Note: Pagination is used to display limited number of records in this zone. You can use the navigation links, such as **Previous** and **Next** to navigate between pages.

You can define a new membership by clicking the **Add** link in the upper right corner of this zone.

By default, the **Memberships** zone does not appear in the **Plan** tab. It appears when you click the **Broadcast** () icon corresponding to the policy plan in the **Plans** zone.

You can filter the list using various search criteria (such as, **External Membership ID**, **Effective From**, **Person Name**, **Effective Till**, and **Status**) available in the **Filter** area. By default, the **Filter** area is hidden. You can view the **Filter** area by clicking the **Filters** () icon in the upper right corner of this zone.

You can change the layout of this zone. For more information on how to change the layout, see [Changing the Layout](#) on page 3414

Related Topics

For more information on...	See...
How to define a membership for a fully-insured group policy plan	Defining a Membership for a Fully-Insured Group Policy Plan on page 359

Policy - Log

The **Log** tab contains the following zone:

- [Policy Log](#) on page 324

Policy Log

The **Policy Log** zone lists the complete trail of actions performed on the policy. It contains the following columns:

Column Name	Column Description
Creation Date Time	Displays the date and time when the action was performed on the policy.
Details	Displays the details about the action performed on the policy.
User	Indicates the user who has performed the action on the policy.
Log Type	Indicates the type of log.
Related Object	Indicates the object or entity which is created when the action is performed on the policy. Note: It contains a link. On clicking the link, the screen appears where you can view the details of the respective related object.
Status Reason	Indicates the reason why the status of the policy is changed.

Note: You can manually add a log entry for the policy by clicking the **Add Log Entry** link in the upper right corner of the **Policy Log** zone.

Related Topics

For more information on...	See...
How to view the log of a policy	Viewing the Log of a Policy on page 346
How to add a log entry for a policy	Adding a Log Entry for a Policy on page 346

Activating a Policy

Procedure

To activate a policy:

1. Search for the policy in the **Policy** screen.
2. In the **Search Results** section, click the link in the **Policy Information** column corresponding to the policy that you want to activate.

The **Policy** screen appears.

3. Ensure that the **Main** tab is selected.
4. Click the **Activate** button in the **Policy** zone.

The status of the policy is changed to **In Force/Active**.

Note:

The **Activate** button appears only when a policy of the respective category is in either of the following status:

Policy Category	Status
Fully-Insured Group or Fully-Insured Individual	<ul style="list-style-type: none"> • Pending • Pending Termination
Self-Funded	<ul style="list-style-type: none"> • Pending

Related Topics

For more information on...	See...
How to search for a policy	Searching for a Policy on page 307
Policy screen	Policy (Used for Viewing) on page 314
Policy zone	Policy on page 315

Editing a Policy

Prerequisites

To edit a policy, you should have:

- Values defined for the **C1-SourceSystemLookup** extendable lookup

Note: This prerequisite is applicable only when you want to define a fully-insured group policy.

- Values defined for the **RUNOUT_ADM_OPT_FLG** lookup field

Note: This prerequisite is applicable when you want to define a self-funded policy.

Procedure

To edit a policy:

1. Search for the policy in the **Policy** screen.
2. In the **Search Results** section, click the link in the **Policy Information** column corresponding to the policy whose details you want to edit.

The **Policy** screen appears.

3. Ensure that the **Main** tab is selected.
4. Click the **Edit** button in the **Policy** zone.

The **Policy** screen appears. It contains the following sections:

- **Main** - Used to specify the basic details about the policy.
- **Persons** - Used to associate persons with the policy.
- **Characteristics** - Used to define the characteristics for the policy.

The **Main** section contains the following fields:

Field Name	Field Description	Mandatory (Yes or No)
Policy Information	Displays information about the policy.	Not applicable
Policy Type	Indicates the policy type using which the policy is defined.	Not applicable
Status	Indicates the status of the policy. The valid values are: <ul style="list-style-type: none"> • Pending • In Force/Active • Runout • Post Runout 	Not applicable
	Note: This field appears when you are editing a policy which is created using a policy type where the policy category is set to Self-Funded .	
Policy Number	Used to specify the policy number.	Yes
Description	Used to specify the description for the policy.	Yes
Source System	Used to indicate the external system from where the policy is originated.	Yes
	Note: This field appears when you are editing a policy which is created using a policy type where the policy category is set to Fully-Insured Group or Fully-Insured Individual .	

Field Name	Field Description	Mandatory (Yes or No)
Start Date	Used to specify the date from when the policy is effective.	Yes
	<p>Note:</p> <p>The policy start date cannot be later than the policy end date.</p> <p>You cannot change the start date of a self-funded policy when it is in the In Force/Active, Runout, or Post Runout status.</p>	
End Date	Used to specify the date till when the policy is effective.	Yes
	<p>Note:</p> <p>The policy end date cannot be earlier than the policy start date.</p> <p>You cannot change the end date when the self-funded policy is in the Runout status.</p> <p>You cannot set the end date of a self-funded policy to a date which is later than or equal to the start date of a pricing rule which is defined for the Runout status.</p> <p>You cannot change the end date when the policy is renewed.</p>	
Runout End Date	Used to specify the date when the runout period of the self-funded policy ends.	No
	<p>Note:</p> <p>This field appears when you are editing a policy which is created using a policy type where the policy category is set to Self-Funded.</p> <p>The runout end date cannot be earlier than or equal to the policy end date.</p> <p>The runout end date cannot be earlier than or equal to the system date when the policy is in the Runout status.</p> <p>You cannot remove the runout end date when the policy is in the Runout or Post Runout status.</p> <p>You cannot set the runout end date to a date which is later than or equal to the start date of a pricing rule which is defined for the Post Runout status.</p> <p>You cannot set the runout end date to a date which is earlier than the end date of a pricing rule which is defined for the Runout status.</p>	

Field Name	Field Description	Mandatory (Yes or No)
Runout Administration Fees	<p>Used to indicate whether the administration fees must be charged when the claim transaction for the self-funded policy is processed in the runout period. The valid values are:</p> <ul style="list-style-type: none"> • None • Percentage of Claim 	No
	<p>Note:</p> <p>At present, this field is used only for the informational purposes and is not considered during the billable charge creation for the claim transactions which are received in the runout period of the policy.</p> <p>This field appears when you are editing a policy which is created using a policy type where the policy category is set to Self-Funded.</p>	

Note:	
The Edit button appears when a policy of the respective category is in either of the following status:	
Policy Category	Status
Fully-Insured Group or Fully-Insured Individual	<ul style="list-style-type: none"> • In Force/Active • Canceled • Pending Cancellation • Pending • Pending Reinstatement • Pending Termination • Terminated
Self-Funded	<ul style="list-style-type: none"> • In Force/Active • Pending • Runout

5. Modify the required details in the **Main** section.
6. Associate the persons with the policy, if required.

Note: While editing a policy, you must ensure that one person is associated as the main customer of the policy.

7. Define, edit, or remove characteristics of the policy, if required.
8. Click **Save**.

The changes made to the policy are saved.

Related Topics

For more information on...	See...
How to search for a policy	Searching for a Policy on page 307
Policy screen	Policy (Used for Viewing) on page 314
Policy zone	Policy on page 315
How to associate a person with a policy	Associating a Person with a Policy on page 311
How to define a characteristic for a policy	Defining a Characteristic for a Policy on page 313

Manually Changing the Status of a Self-Funded Policy to Runout

Prerequisites

To manually change the status of a self-funded policy to **Runout**, you should have:

- Runout end date specified in the self-funded policy.

Procedure

To manually change the status of a self-funded policy to **Runout**:

1. Search for the self-funded policy in the **Policy** screen.
2. In the **Search Results** section, click the link in the **Policy Information** column corresponding to the self-funded policy whose status you want to change.

The **Policy** screen appears.

3. Ensure that the **Main** tab is selected.
4. Click the **Runout** button in the **Policy** zone.

The status of the self-funded policy is changed to **Runout**.

Note:

The **Runout** button appears when the self-funded policy is in the **In Force/Active** status.

You cannot transition a self-funded policy to the **Runout** status when:

- The self-funded policy is renewed.
- The runout end date is not specified.
- The policy end date is earlier than the system date.

Related Topics

For more information on...	See...
How to search for a self-funded policy	Searching for a Policy on page 307
Policy screen	Policy (Used for Viewing) on page 314
Policy zone	Policy on page 315

Renewing a Self-Funded Policy of a Bill Group

Oracle Revenue Management and Billing enables you to renew a self-funded policy which is associated with a bill group. However, note that you can renew a self-funded policy when it is in the **In Force/Active** status and is not yet renewed. For more information, see [Self-Funded Policy Renewal](#) on page 399.

Procedure

To renew a self-funded policy of a bill group:

1. Search for the bill group who is associated with the self-funded policy (which you want to renew) in the **Customer 360° View** screen.
2. In the **Search Results** section, click the **View** () icon corresponding to the bill group whose details you want to view.

The **Person** tab appears in the **Customer 360° Information** screen.

3. Click the **Pricing Information** tab.

The **Pricing Information** tab appears.

4. In the **Bill Group Self-Funded Policy Information** zone, click the **Renew** () icon in the **Renew** column corresponding to the self-funded policy which you want to renew.

The **Policy** screen appears. It contains the following sections:

- **Main** - Used to specify basic details about the renewed policy.
- **Persons** - Used to associate or disassociate persons from the renewed policy.

Note: You cannot disassociate persons who are associated with the base policy using a policy person role which is specified in the **Bill Group Policy Person Role** or **Parent Customer Policy Person Role** option type of the **C1-ASOBLNG** feature configuration.

- **Characteristics** - Used to define the characteristics for the renewed policy.

The **Main** section contains the following fields:

Field Name	Field Description	Mandatory (Yes or No)
Base Policy Information	Indicates the policy which you want to renew.	Not applicable
Policy Type	Indicates the policy type using which the base policy is created.	Not applicable
Policy Number	Used to specify the policy number of the renewed policy.	Yes
Description	Used to specify the description for the renewed policy.	Yes

Field Name	Field Description	Mandatory (Yes or No)
Start Date	Used to specify the date from when the renewed policy is effective.	Yes
	<p>Note:</p> <p>By default, the start date is set to the base policy's end date plus one day. For example, if the base policy's end date is 12-31-2018, then by default, the renewed policy's start date is set to 01-01-2019.</p> <p>The start date cannot be later than the end date.</p> <p>The start date cannot be earlier than or equal to the base policy's end date.</p>	
End Date	Used to specify the date till when the renewed policy is effective.	Yes
	<p>Note: The end date cannot be earlier than the start date.</p>	
Runout End Date	Used to specify the date when the runout period of the renewed policy ends.	No
	<p>Note: The runout end date cannot be earlier than or equal to the renewed policy's end date.</p>	
Runout Administration Fees	<p>Used to indicate whether the administration fees must be charged when the claim transaction for the policy is processed in the runout period. The valid values are:</p> <ul style="list-style-type: none"> • None • Percentage of Claim 	No
	<p>Note: At present, this field is used only for the informational purposes and is not considered during the billable charge creation for the claim transactions which are received in the runout period of the policy.</p>	

Field Name	Field Description	Mandatory (Yes or No)
Copy Pricing Rules	<p>Used to indicate whether you want to copy the pricing rules of the base policy to the renewed policy. If you select the Copy Pricing Rules option, the system copies the following pricing rules of the base policy:</p> <ul style="list-style-type: none"> • Claim • Retention Type Claim Based • Retention Type Enrollment Based • Recurring Flat Fees • Ancillary <p>Note:</p> <p>While copying a pricing rule, the start and end dates of the new pricing rule are set to the renewed policy's start and end dates, respectively.</p> <p>If there are multiple pricing rules which are created using the same pricing rule type and are effective for the different date range, the system copies only one pricing rule from the base policy with the latest date range.</p>	No
Copy Advance Level Funding Eligibility	<p>Used to indicate whether you want to copy the advance level funding eligibility value of the base policy to the renewed policy.</p> <p>Note:</p> <p>If the Copy Advance Level Funding Eligibility option is set to Y in the base policy, the system activates the renewed self-funded policy on the policy renewal even if the renewed policy's start date is later than the system date.</p> <p>This field appears only when you want to renew a self-funded policy.</p>	No

Note: The **Renew** icon appears when the policy is in the **In Force/Active** status and it is not yet renewed.

5. Enter the required details in the **Main** section.
6. Associate or disassociate persons from the renewed policy, if required.
7. Define, edit, or remove characteristics of the renewed policy, if required.
8. Click **Save**.

The renewed policy is created in the **Pending** status. The renewal date is stamped corresponding to the base policy in the **Bill Group Self-Funded Policy Information** zone.

Related Topics

For more information on...	See...
How to search for a person	Searching for a Person on page 648

For more information on...	See...
Customer 360° Information screen	Customer 360° Information on page 659
Pricing Information tab	Customer 360° Information - Pricing Information on page 693
Bill Group Self-Funded Policy Information zone	Bill Group Self-Funded Policy Information on page 701
How to associate a person with a policy	Associating a Person with a Policy on page 311
How to define a characteristic for a policy	Defining a Characteristic for a Policy on page 313
How to setup the C1-ASOBLNG feature configuration	Setting the C1-ASOBLNG Feature Configuration on page 3421

Viewing the Log of a Policy

Procedure

To view the log of a policy:

1. Search for the policy in the **Policy** screen.
2. In the **Search Results** section, click the link in the **Policy Information** column corresponding to the policy whose details you want to view.

The **Policy** screen appears.

3. Click the **Log** tab.

The **Log** tab appears.

4. View the complete trail of actions performed on the policy in the **Policy Log** zone.

Related Topics

For more information on...	See...
How to search for a policy	Searching for a Policy on page 307
Policy screen	Policy (Used for Viewing) on page 314
Policy Log zone	Policy Log on page 324
How to add a log entry for a policy	Adding a Log Entry for a Policy on page 346

Adding a Log Entry for a Policy

Procedure

To add a log entry for a policy:

1. Search for the policy in the **Policy** screen.
2. In the **Search Results** section, click the link in the **Policy Information** column corresponding to the policy for which you want to add a log entry.

The **Policy** screen appears.

3. Click the **Log** tab.

The **Log** tab appears.

4. Click the **Add Log Entry** link in the upper right corner of the **Policy Log** zone.

The **Add Policy Log** window appears. It contains the following fields:

Field Name	Field Description	Mandatory (Yes or No)
Policy Information	Displays information about the policy.	Not applicable
Log Details	Used to specify additional comments for the policy.	Yes

5. Enter the comments in the **Log Details** field.

6. Click **Save**.

The log entry is added in the **Policy Log** zone.

Related Topics

For more information on...	See...
How to search for a policy	Searching for a Policy on page 307
Policy screen	Policy (Used for Viewing) on page 314
Policy Log zone	Policy Log on page 324

Chapter

6

Individual Health Insurance

Topics:

- [Individual Membership](#)
- [Individual Membership Termination](#)
- [Individual Membership Renewal](#)
- [Automatic Contract Creation for Individual Membership](#)
- [Rate Guarantee for Individual Membership](#)
- [Late Setup Notification](#)
- [Individual Membership Preference](#)
- [Binder Payment for Individual Membership](#)
- [Membership Status Reason Preference](#)

Individual health insurance is a coverage that an individual purchase on its own, on an individual or family basis, as opposed to obtaining through an employer. An individual can buy a generic, Medicare, Medicaid, or CHIP health insurance plan from a health insurance payer or from an insurance exchange.

A health insurance payer and insurance exchange sells different plans from the health products to an individual. A health product is a discrete package of health insurance coverage benefits that are offered using a particular product network type (such as health maintenance organization, preferred provider organization, exclusive provider organization, point of service, or indemnity) within a service area.

A health product can include multiple health benefit plans which may cover medical expenses, hospitalization, doctor and hospital visits, prescription drugs, wellness care, etc. A health benefit plan can be a primary or add-on plan. A primary health benefit plan is a standalone plan, which is sold directly. For example, Medical Insurance is a primary health insurance plan.

An add-on plan is also known as supplemental plan. An add-on plan can be an ancillary or rider plan. An add-on plan is not a standalone plan and hence it is not sold directly. For example, the Dental, Vision, Accidental Death, Disability, Critical Illness, Long-Term Care, and Life Insurance plans can be sold as add-on health insurance plans.

Oracle Revenue Management and Billing enables you to create and edit the following entities for a fully-insured individual business:

- Health Products
- Health Plans
- Individual Memberships
- Member Persons
- Medicare or Other Benefits
- Accounts
- Contracts
- Price Items (offered as services)
- Pricing Rule Types
- Pricing Rules
- Price Assignments
- Billable Charges

Two new business objects named **C1-HealthcareProduct** and **C1-HealthPlan** are introduced in this release. The **C1-HealthcareProduct** business object

enables you to create a health product. You can define and edit a health product through a health product and plan inbound message. While defining a health product, you need to specify the following details – product type, product sub type, product category, product LOB, product LOB category, start date, end date, status, etc. A health product can be a bundled or non-bundled product. A bundled product means it includes one or more health products. You can define characteristics for a health product. A health product should be associated with a division (i.e. service area). You can associate a health product to one or more divisions and one division can have one or more health products.

The **C1-HealthPlan** business object enables you to create a health plan for a health product. You can define and edit a health plan through a health product and plan inbound message. While defining a health plan, you need to specify the following details – health product, start date, end date, status, etc. In addition, you need to indicate whether the health plan is a charitable plan, standard plan, grandfather plan, qualified from exchange, ancillary plan, rider plan, add-on plan, etc. You can define characteristics for a health plan.

A health product can have one or more health plans. On inactivating a health product, the system will not automatically inactivate the respective health plans. An individual can subscribe for one or more health plans. The system creates an individual membership for each subscribed health plan. An individual membership can have one or more member persons. One member person in an individual membership must be the main subscriber. You can add one or more dependent persons in the individual membership. One member person in an individual membership should be financially responsible for the individual membership. For more information, see the [Individual Memberships](#) section.

If an individual subscribe for an add-on health plan along with a primary health plan, the system enables you to indirectly link a primary health plan with an add-on health plan by associating the primary individual membership with the add-on individual membership. At present, you can associate only one add-on individual membership with the primary individual membership. The system creates the billable charges for both primary and add-on individual memberships independently.

On terminating the primary individual membership, the system provides a facility to automatically terminate the individual membership on the add-on health plan. For more information, see the [Individual Membership Termination](#) on page 445 section. However, on canceling, reinstating, or renewing a primary individual membership, the system does not automatically cancel, reinstate, or renew the individual membership on the add-on health plan. To cancel, reinstate, or renew an individual membership on the add-on health plan, the system must receive the required information for the individual membership from the enrollment system.

Individual Membership

Oracle Revenue Management and Billing enables you to create and edit individual memberships from the user interface and through a health care inbound message or membership repricing inbound web service. Note that the user interface for adding and editing individual memberships is not yet well-designed and should only be used by the presales and sales teams for learning and demo purposes and not by the customers.

A new business object for individual membership named **C1-IndMembership** is introduced in this release. While creating an individual membership through a health care inbound message, you need to specify the following details:

- **Health Plan** - Used to indicate the health plan for which the main subscriber has enrolled.
- **Member Person Status** - Used to indicate the main subscriber or dependent person's status.
- **Status Reason** - Used to indicate the reason why you want to change the status of the main subscriber or dependent person.
- **Auto Renew** - Used to indicate whether the individual membership should be automatically renewed.
- **Contract Period** - Used to indicate the period (in months) for which the individual membership should be automatically renewed.
- **Membership Renewal Date** - Used to indicate the date when the individual membership should be renewed. It is required for manual renewal of the individual membership. In case of automatic renewal, the membership renewal date is calculated by the system.
- **Associated Membership Details** - Used to associate the individual membership with another individual membership which is created for the add-on health insurance plan.
- **Member Identifiers** - Used to specify one or more identifiers for the individual membership.
- **Exchange Details** - Used to indicate whether the individual membership is purchased from the exchange. If the individual membership is purchased from the exchange, you need to specify the exchange ID.
- **Binder Payment Details** - Used to indicate whether the binder payment is required for the individual membership. If so, you need to specify the following details:
 - Grace Days
 - Binder Liability Amount (if required)
 - Threshold Percentage (if required)
 - Hold Billing

For more information about the binder payments, see the [Binder Payment for Individual Membership](#) on page 457section.

Note: On creating an individual membership for a health plan, the membership category is set to **INDV**. However, on creating a group membership for a policy plan, the membership category is set to **GRUP**.

The following table lists the statuses introduced in the lifecycle of the **C1-IndMembership** business object:

Individual Membership Status	Description
Draft	An individual membership is created in the Draft status and then transitioned to either the Pending Effectuation or Active status as mentioned in the health care inbound message or membership repricing incoming message.

Individual Membership Status	Description
Pending Effectuation	<p>If the main subscriber status is set to Pending Effectuation, the system sets the status of the individual membership to Pending Effectuation. The system determines the individual membership status reason using the membership status reason preference which is specified in the Status Reason Mapping option type of the C1-ASOBLLNG feature configuration.</p> <p>The system monitors whether the binder payments (if required) are received for the individual membership in the Pending Effectuation status. If the binder payments are received, the status of the individual membership is not automatically transitioned to Active. The status of the individual membership is changed from Pending Effectuation to Active only when the main subscriber status update information is received through a health care inbound message or membership repricing inbound web service.</p>
Active	<p>If the main subscriber status is set to Active, the system sets the status of the individual membership to Active. The system determines the individual membership status reason using the membership status reason preference which is specified in the Status Reason Mapping option type of the C1-ASOBLLNG feature configuration.</p> <p>If the binder payments are not required for the individual membership, you can directly set the status of main subscriber to Active. In addition, if you want to reinstate the individual membership, you must set the status of main subscriber to Active. The system will then change the status of the individual membership from Terminated to Active. In case of reinstatement of the individual membership, the status of the dependent persons is not changed automatically from Inactive to Active unless the dependent person status update information is received through a health care inbound message or membership repricing inbound web service.</p>
Terminated	<p>If the main subscriber status is set to Inactive, the system sets the status of the individual membership to Terminated. The system determines the individual membership status reason using the membership status reason preference which is specified in the Status Reason Mapping option type of the C1-ASOBLLNG feature configuration.</p> <p>Once the status of the individual membership is set to Terminated, the system automatically changes the status of the dependent persons to Inactive. Note that while inactivating the dependent persons, the system only considers the dependent persons who are in the Active status. The system determines the dependent person status reason using the membership status reason preference. The system also updates the end date of the individual membership, main subscriber, and dependent persons. For more information, see the Individual Membership Termination section.</p>
Canceled	<p>If the main subscriber status is set to Canceled, the system sets the status of the individual membership to Canceled. The system determines the individual membership status reason using the membership status reason preference which is specified in the Status Reason Mapping option type of the C1-ASOBLLNG feature configuration.</p> <p>Once the status of the individual membership is set to Canceled, the system automatically changes the status of the dependent persons to Canceled. The system determines the dependent person status reason using the membership status reason preference.</p> <p>The system will also cancel the billable charges and bill segment (if any) created for the individual membership or financially responsible member person account.</p>

The system also enables you to change the status of a dependent person in the individual membership through a health care inbound message or membership repricing inbound web service. On changing the status of a member person to **Pending Effectuated** or **Active**, the system considers the member person during premium calculation.

On changing the status of the individual membership and member person, the system creates an audit event to trigger the repricing feature. The **C1-IndMembership** business object is configured for the entity audit framework. However, the repricing is triggered only when an active audit event type for the **C1-IndMembership** business object is created in the system.

The system creates appropriate log entries during the individual membership and member person status transition. You can view the status transition logs of individual membership in the **Log** tab of the **Membership (Used for Viewing)** screen. A new zone named **Member Person Log** is introduced in the **Main** tab of the **Membership (Used for Viewing)** screen. It enables you to view the log entries generated on the member person status transition.

You can define individual membership status reasons through the **Status Reason** screen. A new lookup field named **MEMB_PERS_STAT_RSN_FLG** is introduced in this release. Here, you can add the status reasons for the member person.

Individual Membership Termination

To terminate an individual membership, you need to change the status of the main subscriber to **Inactive** through a health care inbound message or membership repricing inbound web service. Along with the main subscriber status, you need to specify the status reason and end date for the main subscriber. If the end date is earlier than or equal to the inbound processing date, the system updates the status, status reason, and end date of the main subscriber and then changes the status of the individual membership to **Terminated**. The system determines the individual membership status reason using the membership status reason preference which is specified in the **Status Reason Mapping** option type of the **C1-ASOBLLNG** feature configuration.

Once the status of the individual membership is set to **Terminated**, the system automatically changes the status of the dependent persons to **Inactive**. Note that while inactivating the dependent persons, the system only considers the dependent persons who are in the **Active** status. The system determines the dependent person status reason using the membership status reason preference.

If the main subscriber end date is later than the inbound processing date, the system creates a record in the **CI_MEMBERSHIP_PROCESS** table with the **Pending** status. The system stores the following information in the record:

- Membership ID
- Member Person ID
- Whether the member person is a main subscriber
- Processing date (it is set to future dated end date of the member person)
- Required action (is set to **Terminate**)

A new batch named **C1-MEPRC** is introduced in this release. On the **C1-MEPRC** batch execution, the system checks whether there are any records in the **CI_MEMBERSHIP_PROCESS** table with the **Pending** status. If so, the system checks whether the processing date of the record is earlier than or equal to the system date. If so, the system determines the required action to be taken for the individual membership from the record. If the **MEMB_PROCESS_FLG** column of the record is set to **Terminate** and the **MAIN_CUST_SW** column is set to **N**, the system changes the status of the dependent person to **Inactive** and updates the end date of the dependent person.

However, if the **MEMB_PROCESS_FLG** column of the record is set to **Terminate** and the **MAIN_CUST_SW** column is set to **Y**, the system updates the status and end date of the main subscriber and then changes the status of the individual membership to **Terminated**. Once the status of the individual membership is set to **Terminated**, the system automatically changes the status of the dependent persons to **Inactive**. The system also updates the end date of the individual membership and dependent persons.

The system enables you to configure whether the individual membership on the add-on health insurance plan should be automatically terminated when the primary individual membership is terminated. If the **Cascade Associate**

Membership parameter in the **C1-MEMSTSUP** algorithm is set to **Y**, the system changes the status of the associated individual membership to **Terminated**. Once the status of the associated individual membership is set to **Terminated**, the system automatically changes the status of its main subscriber and dependent persons to **Inactive**. The system also updates the end date of the associated individual membership, its main subscriber and its dependent persons.

Once the required action is completed for the record in the **CI_MEMBERSHIP_PROCESS** table, the system changes the status of the record to **Complete**. However, if the system receives a reinstatement request for an individual membership before processing the termination request, the system changes the status of the record in the **CI_MEMBERSHIP_PROCESS** table to **Canceled**.

Individual Membership Renewal

Oracle Revenue Management and Billing enables you to renew an individual membership in the following two ways:

- Manually
- Automatically

While creating or editing an individual membership through a health care inbound message or membership repricing inbound web service, you must set the **Auto Renew** option for the individual membership to either **Y** or **N**.

If the **Auto Renew** option for an individual membership is set to **N**, you need to specify the following details in a health care inbound message or membership repricing incoming message:

- Membership renewal date
- Status, status reason, and end date of the main subscriber
- Status, status reason, and end date of the dependent person

The enrollment system can send the renewal information either during the enrollment period or after the enrollment period. Irrespective of when the renewal information is received, the membership renewal date must be set to the membership end date + 1. For example, if the enrollment period is from 01-01-2021 to 12-31-2021, then the system must receive the membership renewal date as 01-01-2022. On renewing an individual membership, the dependent person in the individual membership is not automatically activated unless the activation information is received for the dependent person from the enrollment system. The associated membership for an add-on health insurance plan is not automatically renewed unless the renewal information is received for the respective membership from the enrollment system.

If the **Auto Renew** option for an individual membership is set to **Y**, you need to specify the contract period for which the individual membership should be automatically renewed. The system then creates a record in the **CI_MEMBERSHIP_PROCESS** table with the **Pending** status. The system stores the following information in the record:

- Membership ID
- Main Subscriber ID
- Whether the member person is a main subscriber
- Processing date (it is set to the membership end date)
- Required action (is set to **Renew**)

On the **C1-MEPRC** batch execution, the system checks whether there are any records in the **CI_MEMBERSHIP_PROCESS** table with the **Pending** status. If so, the system checks whether the processing date of the record is earlier than or equal to the system date. If so, the system determines the required action to be taken for the individual membership from the record. If the **MEMB_PROCESS_FLG** column of the record is set to **Renew** and the **MAIN_CUST_SW** column is set to **Y**, the system calculates the renewal date and new end date for the individual membership.

The renewal date for the individual membership is set to membership end date + 1. For example, if the enrollment period is from 01-01-2021 to 12-31-2021, the system sets the renewal date to 01-01-2022 (i.e. 12-31-2021 + 1). The new membership end date is calculated using the renewal date and contract period. For example, if the renewal date is 01-01-2022 and contract period is 12 months, the system sets the end date of membership, main subscriber, and

dependent persons to 12-31-2022. The associated membership for an add-on health insurance plan is not automatically renewed during the individual membership renewal.

The automatic renewal request for an individual membership must be received during the enrollment period. If the automatic renewal request for an individual membership is received after the enrollment period, the system will not renew the individual membership automatically.

Once the membership end date is changed, the system will trigger the repricing feature and accordingly create or extend the billable charge for the renewed period.

Automatic Contract Creation for Individual Membership

Oracle Revenue Management and Billing automatically creates contracts for each account of the financially responsible member person when:

- Person is added to an individual membership
- Account is added for a financially responsible member person
- Health plan is added or edited in the system

In the former two scenarios, the system derives the individual membership where the person is financially responsible for the membership. Once the individual membership is derived, the system derives the health plan for which the individual membership is enrolled.

Once the health plan is derived, the system checks whether the pricing rule types are associated with the health plan. If a pricing rule type is associated with the health plan and the pricing rule type contains one or more price items, it creates a contract using a distinct contract type which is associated with each price item. Let us assume that PRT1 is associated with the health plan and it contains three price items - PI1, PI2, and PI3. Now, if the PI1 is associated with the CT1 contract type, PI2 is associated with the CT2 contract type, and PI3 is associated with the CT3 contract type, the system will create three contracts - C1 using CT1, C2 using CT2, and C3 using CT3. However, if the PI1 and PI3 are associated with the CT1 contract type and PI2 is associated with the CT2 contract type, the system will create two distinct contracts - C1 using CT1 and C2 using CT2.

If multiple pricing rule types are associated with the health plan and each pricing rule type contains multiple price items, it creates a contract using a distinct contract type which is associated with each price item of each pricing rule type.

The status of each contract is set to **Active**. The contract start date is set to the start date of the respective individual membership. If the same contract type is associated with the same or different price items on the same or different pricing rule types of different health plans, the contract start date is set to the start date of the earliest health plan. The default rate schedule specified on the respective contract type is added to the contract in the rate information and its effective date is set to the contract start date.

Note:

The system creates a contract using a contract type for an account only when the division to which the account and contract type belongs is same.

If a contract of a contract type is already present on the account, the system will not create a new contract. Instead, it will update the start date of the existing contract, if required.

Rate Guarantee for Individual Membership

At times, the insurance carriers provide rate guarantee health plans to a fully-insured individual wherein the insurance rate does not change for the rate guarantee period (i.e. lock-in period). Oracle Revenue Management and Billing enables you to configure guaranteed rate for one or more health insurance services offered to an individual person. Unless, there are some qualifying life events (QLE), the system will calculate the premium on the same rate for the next coverage period until the rate guarantee period is over.

The system enables you to maintain the rate guarantee details for each individual membership through a health care inbound message or through membership repricing inbound web service. It enables you to capture the following details:

- **Rate Guarantee Start Date** – Used to specify the date from when the rate guarantee is available for the individual membership.
- **Rate Guarantee End Date** – Used to specify the date till when the rate guarantee is available for the individual membership.
- **Rate Guarantee Status** – Used to indicate the status of the rate guarantee period. The valid values are - **Active** and **Inactive**.

You can send the rate guarantee details for an individual membership during enrollment (i.e. on membership creation), during coverage period, or during membership renewal. While sending the rate guarantee details of an individual membership, ensure that the active rate guarantee records do not have overlapping date range.

The system enables you to define the rate guarantee business rules. If the rate guarantee details are not specified for an individual membership during enrollment, the system derives the rate guarantee details for the individual membership through a rate guarantee business rule. The rate guarantee business rule indicates the following:

- **Rate Guarantee Applicability** – Used to indicate whether the rate guarantee is available for the individual membership.
- **Rate Guarantee Period** – Used to derive the rate guarantee start and end dates. The system sets the rate guarantee start date to the membership start date and the rate guarantee end date to the rate guarantee start date + rate guarantee period.

There might be situations wherein the rate guarantee details are received for an individual membership later during the coverage period or during membership renewal through a health care inbound message. In such scenarios, the system will then give precedence to the rate guarantee details which are received through a health care inbound message and will not derive the rate guarantee details from the rate guarantee business rule which is stamped against the individual membership.

A new column named **Rate Guarantee** is available in the **Price Items** section while defining or editing an age based or tier based pricing rule type. While creating a charge for an individual membership, the system checks whether the **Rate Guarantee** option is selected for the price item in the respective pricing rule type and whether the billable charge timeline falls within the rate guarantee period. If so, the system derives the rate guarantee pricing rule for the price items where the **Rate Guarantee** option is selected.

The system stores the pricing rule which is effective for such price items on the rate guarantee start date as the rate guarantee pricing rule. Until the rate guarantee period is over, the system considers the rate guarantee pricing rule for the individual membership during premium calculation. This ensures that the same rate is charged for a health insurance service even when the rate has increased for the health insurance service in the system.

The Entity Audit framework is configured for the Rate Guarantee feature. The system will create audit events when the rate guarantee records are added or updated for an individual membership.

Late Setup Notification

Oracle Revenue Management and Billing enables you to create a To Do notification when the details to include a member person in a group or individual membership is received in ORMB beyond the late setup threshold days from the member person start date. This notification can help the billing analyst to take appropriate actions, such as giving premium waiver to the member person if required.

To enable this feature, you need to set the following option types in the **C1-ASOBLLNG** feature configuration:

- **Monitor Late Setup** – Used to indicate whether you want to enable the late setup notification feature. The valid values are – **Y** and **N**. By default, the value is set to **N**.
- **Late Setup Threshold in Days** – Used to indicate the number of threshold days for late setup notification. This option type is required when the **Monitor Late Setup** option type is set to **Y**. The value must be greater than zero.

For example, if the system receives the information to add a member person with the start date as **01-15-2021** to an individual membership on **02-15-2021** and the late setup threshold days in the **C1-ASOBLNG** feature configuration is set to **15**. In this case, the number of days between the member person start date and member person creation date is greater than late setup threshold days, and therefore a To Do is created using the To Do type which is specified in the **C1-LATESET** algorithm attached to the group or individual membership business object, respectively.

To implement this business requirement, the system stores the member person creation date (which was not done in the previous releases) while adding a member person to a group or individual membership. A new batch named **C1-LSUB** is introduced in this release. It derives the creation date for all member persons in the existing group and individual memberships and stamps it against the corresponding record in the **CRE_DTTM** column of the **CI_MEMBERSHIP_PER** table. This batch must be executed only once after upgrading to Oracle Revenue Management and Billing Version 3.1.0.0.0. For more information, refer to *Oracle Revenue Management and Billing Version 3.1.0.0.0 Upgrade Guide*.

Individual Membership Preference

The Individual Membership Preference enables you to set the attributes which are used during the creation of an individual membership. While deriving the details for an individual membership, the system uses the following attributes from the individual membership preference:

- Health Plan Characteristics

You can define, edit, delete, and copy an individual membership preference through the **Field Mapping** screen.

Searching for an Individual Membership Preference

Prerequisites

To search for an individual membership preference, you should have:

- Values defined in the **FIELD_CAT_FLG** lookup field

Procedure

To search for an individual membership preference:

1. Click the **Admin** link in the **Application** toolbar.
A list appears.
2. From the **Admin** menu, select **F** and then click **Field Mapping**.
A sub-menu appears.
3. Click the **Search** option from the **Field Mapping** sub-menu.
The **Field Mapping** screen appears.
4. Select the **Individual Membership** option from the **Preference Category** list.
5. Enter the additional search criteria in the **Search Field Mapping** zone.

Note: ORMB search engine supports wildcard search, where you can substitute the percentage (%) symbol as a stand in for any word or letter in a search criteria. You can use the ‘%’ wildcard character in all input fields except the date and ID fields. The ‘%’ wildcard character is suffixed automatically at the end of the partial search criteria. Therefore, you may or may not specify the wildcard character at the end of the partial search criteria. However, you have to prefix the wildcard character manually wherever required.

6. Click **Search**.

A list of individual membership preferences that meet the search criteria appears in the **Search Results** section.

Viewing the Individual Membership Preference Details

Procedure

To view the details of an individual membership preference:

1. Search for the individual membership preference in the **Field Mapping** screen.
2. In the **Search Results** section, click the **Broadcast** () icon corresponding to the individual membership preference whose details you want to view. The **Field Mapping** zone appears.
3. View the details of the individual membership preference in the **Field Mapping** zone.

Related Topics

For more information on...	See...
How to search for an individual membership preference	Searching for an Individual Membership Preference on page 449

Defining an Individual Membership Preference

Prerequisites

To define an individual membership preference, you should have:

- Values defined in the **FIELD_CAT_FLG** and **FIELD_NAME_FLG** lookup fields
- Required characteristic type defined for the health plan in the application.

Procedure

To define an individual membership preference:

1. Click the **Admin** link in the **Application** toolbar.
A list appears.
2. From the **Admin** menu, select **F** and then click **Field Mapping**.
A sub-menu appears.
3. Click the **Add** option from the **Field Mapping** sub-menu.

The **Select Business Object** screen appears. It contains the following field:

Field Name	Field Description	Mandatory (Yes or No)
Field Mapping Business Object	Used to indicate the business object using which you want to create the billing preference. The valid values are: <ul style="list-style-type: none"> • Field Mapping • Medicare Plan Benefit Package • Membership Status Reason Mapping 	Yes

Note: Alternatively, you can access the **Select Business Object** screen by clicking the **Add** button in the **Page Title** area of the **Field Mapping** screen.

4. Select the **Field Mapping** option from the **Field Mapping Business Object** list.
5. Click **OK**.

The **Field Mapping** screen appears. It contains the following sections:

- **Main** - Used to specify basic details of the billing preference. It contains the following fields:

Field Name	Field Description	Mandatory (Yes or No)
Preference	Used to specify the individual membership preference.	Yes
Description	Used to specify the description for the individual membership preference.	Yes
Detailed Description	Used to specify additional information about the individual membership preference.	No
Status	Used to indicate the status of the billing preference. The valid values are: <ul style="list-style-type: none"> • Active • Inactive 	Yes

- **Preference Category** - This section contains the following field:

Field Name	Field Description	Mandatory (Yes or No)
Preference Category	Used to indicate the category to which the preference belongs. The valid values are: <ul style="list-style-type: none"> • Billing • Binder Payment • Geographic Rating Area • Individual Membership • Medicare • Medicare Plan Benefit • Member Reconciliation • Member Relationship and Subscription Tier • Membership Status Reason • Statement Construct 	Yes

- **Preference Settings** - Used to set the attributes in the individual membership preference. It contains the following fields in a grid:

Field Name	Field Description	Mandatory (Yes or No)
Attribute	Used to indicate the attribute which you want to set in the individual membership preference. The valid values are: <ul style="list-style-type: none"> • Health Plan Characteristics - Used when you want to derive the health plan ID for an individual membership. 	Yes (Conditional)
		Note: This field is required while setting an attribute in the individual membership preference.

Field Name	Field Description	Mandatory (Yes or No)				
Value	<p>Used to specify the attribute value. The attribute value that you can specify varies depending on the attribute you want to set in the billing preference:</p> <table border="1"> <thead> <tr> <th>If the attribute is set to...</th> <th>Then, this field is...</th> </tr> </thead> <tbody> <tr> <td>Health Plan Characteristics</td> <td> <p>Used to specify the characteristic type which indicates the plan ID of the health plan. This characteristic type is defined for a health plan. The system uses this plan ID to create a health plan specific contract. The system then uses this characteristic type to determine the account of the financial responsible person for whom the billable charges should be generated.</p> <p>Note: The list includes only those characteristics which are already defined in the system.</p> </td> </tr> </tbody> </table>	If the attribute is set to...	Then, this field is...	Health Plan Characteristics	<p>Used to specify the characteristic type which indicates the plan ID of the health plan. This characteristic type is defined for a health plan. The system uses this plan ID to create a health plan specific contract. The system then uses this characteristic type to determine the account of the financial responsible person for whom the billable charges should be generated.</p> <p>Note: The list includes only those characteristics which are already defined in the system.</p>	<p>Yes (Conditional)</p> <p>Note: This field is required while setting an attribute in the individual membership preference.</p>
If the attribute is set to...	Then, this field is...					
Health Plan Characteristics	<p>Used to specify the characteristic type which indicates the plan ID of the health plan. This characteristic type is defined for a health plan. The system uses this plan ID to create a health plan specific contract. The system then uses this characteristic type to determine the account of the financial responsible person for whom the billable charges should be generated.</p> <p>Note: The list includes only those characteristics which are already defined in the system.</p>					
Entity Type	<p>Used to indicate the type of entity for which the attribute is applicable. The valid values are:</p> <ul style="list-style-type: none"> Account Billable Charge <p>Note: At present, this data is stored for informational purposes only and is not considered in the business logic. If required, you can add more entity types to the MAP_ENTITY_FLG lookup field.</p>	No				

Note: While defining an individual membership preference, you must set at least one attribute in the individual membership preference.

6. Select the **Individual Membership** option from the **Preference Category** list.
7. Enter the required details in the **Main** section.
8. Select the required attribute and value from the respective fields.
9. If you want to set more than one attribute in the individual membership preference, click the **Add (+)** icon and then repeat step 8.

Note: However, if you want to remove an attribute from the individual membership preference, click the **Delete** (🗑️) icon corresponding to the attribute.

10. Click Save.

The individual membership preference is defined.

Editing an Individual Membership Preference

Prerequisites

To edit an individual membership preference, you should have:

- Values defined in the **FIELD_CAT_FLG** and **FIELD_NAME_FLG** lookup fields
- Required characteristic type defined for the health plan in the application.

Procedure

To edit an individual membership preference:

1. Search for an individual membership preference in the **Field Mapping** screen.
2. In the **Search Results** section, click the **Edit** (✎) icon in the **Edit** column corresponding to the individual membership preference whose details you want to edit.

The **Field Mapping** screen appears. It contains the following sections:

- **Main** - Used to specify basic details of the individual membership preference. It contains the following fields:

Field Name	Field Description	Mandatory (Yes or No)
Preference	Displays the individual membership preference.	Not applicable
Description	Used to specify the description for the individual membership preference.	Yes
Detailed Description	Used to specify additional information about the individual membership preference.	No
Status	Used to indicate the status of the individual membership preference. The valid values are: <ul style="list-style-type: none"> • Active • Inactive 	Yes
Preference Category	Indicates the category to which the preference belongs. The valid value is: <ul style="list-style-type: none"> • Individual Membership 	Not applicable

- **Preference Settings** - Used to set the attributes in the individual membership preference. It contains the following fields in a grid:

Field Name	Field Description	Mandatory (Yes or No)				
Attribute	Used to indicate the attribute which you want to set in the individual membership preference. The valid values are: <ul style="list-style-type: none"> Health Plan Characteristics - Used when you want to derive the additional information of a health plan for an individual membership. 	Yes (Conditional) Note: This field is required while setting an attribute in the individual membership preference.				
Value	Used to specify the attribute value. The attribute value that you can specify varies depending on the attribute you want to set in the individual membership preference: <table border="1" data-bbox="639 646 1182 982"> <thead> <tr> <th>If the attribute is set to...</th> <th>Then, this field is...</th> </tr> </thead> <tbody> <tr> <td>Health Plan Characteristics</td> <td>Used to specify the health plan characteristics. Note: The list includes only those characteristics which are already defined in the system.</td> </tr> </tbody> </table>	If the attribute is set to...	Then, this field is...	Health Plan Characteristics	Used to specify the health plan characteristics. Note: The list includes only those characteristics which are already defined in the system.	Yes (Conditional) Note: This field is required while setting an attribute in the individual membership preference.
If the attribute is set to...	Then, this field is...					
Health Plan Characteristics	Used to specify the health plan characteristics. Note: The list includes only those characteristics which are already defined in the system.					
Entity Type	Used to indicate the type of entity for which the attribute is applicable. The valid values are: <ul style="list-style-type: none"> Account Billable Charge Note: At present, this data is stored for informational purposes only and is not considered in the business logic. If required, you can add more entity types to the MAP_ENTITY_FLG lookup field.	No				

Note: Alternatively, you can edit the details of an individual membership by clicking the **Edit** button in the **Field Mapping** zone.

3. Modify the required details in the **Main** section.
4. Define, edit, or remove the attribute from the individual membership, if required.

Note: You must set at least one attribute in an individual membership preference.

5. Click **Save**.

The changes made to the individual membership are saved.

Related Topics

For more information on...	See...
How to search for an individual membership preference	Searching for an Individual Membership Preference on page 449

Copying an Individual Membership Preference

Instead of creating an individual membership preference from scratch, you can create a new individual membership preference using an existing individual membership preference. This is possible through copying an individual membership preference. On copying an individual membership preference, the details including the attributes are copied to the new individual membership preference. You can then edit the details, if required.

Prerequisites

To copy an individual membership preference, you should have:

- Individual membership preference (whose copy you want to create) defined in the application
- Values defined in the **FIELD_CAT_FLG** and **FIELD_NAME_FLG** lookup fields
- Required characteristic type defined for the health plan in the application.

Procedure

To copy an individual membership preference:

1. Search for the individual membership preference in the **Field Mapping** screen.
2. In the **Search Results** section, click the **Duplicate**  icon in the **Duplicate** column corresponding to the individual membership preference whose copy you want to create.

The **Field Mapping** screen appears. It contains the following sections:

- **Main** - Used to specify basic details of the individual membership preference. It contains the following fields:

Field Name	Field Description	Mandatory (Yes or No)
Preference	Used to specify the individual membership preference.	Yes
Description	Used to specify the description for the individual membership preference.	Yes
Detailed Description	Used to specify additional information about the individual membership preference.	No
Status	Used to indicate the status of the billing preference. The valid values are: <ul style="list-style-type: none"> • Active • Inactive 	Yes
Preference Category	Indicates the category to which the preference belongs. The valid values are: <ul style="list-style-type: none"> • Individual Membership 	Not applicable

- **Preference Settings** - Used to set the attributes in the individual membership preference. It contains the following fields in a grid:

Field Name	Field Description	Mandatory (Yes or No)				
Attribute	Used to indicate the attribute which you want to set in the individual membership preference. The valid values are: <ul style="list-style-type: none"> Health Plan Characteristics - Used when you want to derive the additional information of a health plan for an individual membership. 	Yes (Conditional) Note: This field is required while setting an attribute in the individual membership preference.				
Value	Used to specify the attribute value. The attribute value that you can specify varies depending on the attribute you want to set in the billing preference: <table border="1" data-bbox="639 611 1182 951"> <thead> <tr> <th>If the attribute is set to...</th> <th>Then, this field is...</th> </tr> </thead> <tbody> <tr> <td>Health Plan Characteristics</td> <td>Used to specify the health plan characteristics. Note: The list includes only those characteristics which are already defined in the system.</td> </tr> </tbody> </table>	If the attribute is set to...	Then, this field is...	Health Plan Characteristics	Used to specify the health plan characteristics. Note: The list includes only those characteristics which are already defined in the system.	Yes (Conditional) Note: This field is required while setting an attribute in the individual membership preference.
If the attribute is set to...	Then, this field is...					
Health Plan Characteristics	Used to specify the health plan characteristics. Note: The list includes only those characteristics which are already defined in the system.					
Entity Type	Used to indicate the type of entity for which the attribute is applicable. The valid values are: <ul style="list-style-type: none"> Account Billable Charge Note: At present, this data is stored for informational purposes only and is not considered in the business logic. If required, you can add more entity types to the MAP_ENTITY_FLG lookup field.	No				

Note: While defining an individual membership preference, you must set at least one attribute in the individual membership preference.

- Enter the required details in the **Main** section.
- Define, edit, or remove the attribute from the individual membership preference, if required.
- Click **Save**.

The new individual membership preference is defined.

Related Topics

For more information on...	See...
How to search for an individual membership preference	Searching for an Individual Membership Preference on page 449

Deleting an Individual Membership Preference

Procedure

To delete an individual membership preference:

1. Search for the individual membership preference in the **Field Mapping** screen.
2. In the **Search Results** section, click the **Delete** (🗑️) icon in the **Delete** column corresponding to the individual membership preference that you want to delete.

A message appears confirming whether you want to delete the individual membership preference.

Tip: Alternatively, you can delete an individual membership preference by clicking the **Delete** button in the **Field Mapping** zone.

3. Click **OK**.

The individual membership preference is deleted.

Related Topics

For more information on...	See...
How to search for an individual membership preference	Searching for an Individual Membership Preference on page 449

Binder Payment for Individual Membership

On enrolling for an individual health insurance plan, the financial responsible member person needs to pay first month's premium often called as binder payment to complete the enrollment process. The individual membership enrollment is effectuated when the binder payment is received. The binder payment should be received by the billing system and not by the enrollment system. The binder payment is not required during individual membership renewal and reinstatement.

Few health insurance payers send bills to collect the binder payment, whereas few do not send bills to collect the binder payment. In other words, the bill generation process for individual membership is kept on hold by some health insurance payers until the binder payment is received.

Oracle Revenue Management and Billing enables you to create binder payments for an individual membership. For more information on how to create a binder payment, see the [Binder Payment Creation](#) section. While creating an individual membership through a health care inbound message or through a membership repricing inbound web service, you must set the **Binder Payment Applicability** option for the individual membership to either **Y** or **N**. You can set the **Binder Payment Applicability** option to **Y** only when the following conditions are met:

- Individual membership status is set to the value specified in the **Membership Status Code for Pending Effectuation** attribute of the binder payment preference.
- Membership status reason is set to the value specified in the **Membership Status Reason when Awaiting Binder Payment** attribute of the binder payment preference.

The system considers the binder payment preference which is specified in the **Binder Payment Field Mapping** option type of the **C1-ASOBLLNG** feature configuration.

If the **Binder Payment Applicability** option is set to **Y** for an individual membership, it means that the system should monitor whether the binder payment is received before activating the individual membership. On receiving the binder payment for the individual membership, the system only changes the membership and its member persons' status reason and not the membership and its member person' status. The membership and its member persons' status is changed only when the system receives the main subscriber's status update information from the enrollment system through a health care inbound message. However, if the **Binder Payment Applicability** option is set to **N** for an individual membership,

it means that binder payment is not required for activating the individual membership. For more information about the binder payment monitor process, see the [Binder Payment Monitoring](#) section.

If the **Binder Payment Applicability** option is set to **Y** for an individual membership, you need to specify the following binder payment details through a health care inbound message:

- **Grace Days** – Used to calculate the grace date for the individual membership.
- **Binder Liability Amount** – Used to specify the binder liability amount. This data is required when the **Consider Binder Liability Amount** attribute is set to **Y** in the binder payment preference.
- **Threshold Percentage** – Used to specify the threshold percentage using which the threshold amount should be calculated.
- **Hold Billing** – Used to indicate whether you want to hold the bill generation process for the individual membership until the binder payment is received.

The system facilitates you to validate binder payment against the threshold amount. If the **Consider Binder Liability Amount** attribute is set to **Y** in the binder payment preference, the system calculates the threshold amount for the binder payment using the binder liability amount and threshold percentage. For example, if the binder liability amount is set to 50 and threshold percentage is set to 20, the system sets the threshold amount to 10 (i.e. $(50*20)/100$). The system can receive one or more binder payments for an individual membership. If the **Consider Binder Liability Amount** attribute is set to **Y**, the system must receive the binder payments whose sum is equal to or greater than the threshold amount. However, if the **Consider Binder Liability Amount** attribute is set to **N**, the system does not calculate the threshold amount for the binder payment. In such case, the system must receive a binder payment with the amount greater than zero.

On editing the binder liability amount and threshold percentage for an individual membership, the system recalculates the threshold amount for the binder payment. On creating a billable charge for an individual membership where the **Hold Billing** option is set to **Y**, the system will set the bill after date in the billable charge to a far future date (i.e. 12-31-2099).

Prerequisites

To setup the binder payment process, you need to do the following:

- Define the binder payment identification characteristic type for the payment in the system.
- Define the required status reason for the membership in the system.
- Define the required configurations for the following binder payment fields in the system.
 - Binder Payment Applicability
 - Hold Billing
 - Threshold Percentage
 - Grace Days
- Define the binder payment field mapping preference in the system.
- Values defined for binder payment in the **FIELD_CAT_FLG** lookup field
- Set the values for the following option types in the **C1-ASOBLLNG** feature configuration:
 - Binder Payment Field Mapping
- Attach an algorithm of the **C1-THRSHDAMT** algorithm type to the **Post-Processing** system event of the **C1-IndMembership** business object.
- Attach an algorithm of the **C1-BNDRH** algorithm type to the **Enter** system event of the **C1-IndMembership** business object where the status is **Active**.
- Attach an algorithm of the **C1-FICRETBC** algorithm type to the **Billable Charge Creation Post Processing** system event of the **Fully Insured Age Based** and **Fully Insured Tier Based** pricing rule type.

- Attach an algorithm of the **C1-BNFTODO** algorithm type and attach it as a soft parameter in the **C1-BPMNT** batch.
- Define the values in the parameter of the **C1-CCPYTSADS** algorithm.
- Lockbox tender types defined in the **C1_LBX_TENDER_TYPE** lookup field.
- Lockbox record type, lockbox reference identification qualifier, and lockbox remittance identification types defined in the **C1_LBX_820_RECORD_TYPE**, **C1_LBX_REF_IDQ_LKP**, and **C1_LBX_RMR_ID_TYPE** lookup fields respectively.

Algorithms Used in Binder Payment

The following table lists the algorithms which are used in the binder payment:

Algorithm	Algorithm Type	Description
C1-THRSHDAMT	C1-THRSHDAMT	Refer to CI-THRSHDAMT on page 464
C1-BNDRH	C1-BNDRH	Refer to CI-BNDRH on page 459
C1-FICRETBC	C1-FICRETBC	Refer to CI-FICRETBC on page 462
C1-CCPYTSADS	C1-CCPYTSADS	Refer to CI-CCPYTSADS on page 460
C1-BNFTODO	C1-BNFTODO	Refer to CI-BNFTODO on page 460

C1-BNDRH

This algorithm is invoked during the membership activation process. It checks whether the binder payment is received for the membership. If the binder payment is received, the membership status is changed from **Pending Effectuation** to **Active**.

Note: At present, this algorithm is invoked only during the membership enrollment and not for membership reinstatement, where the membership status is changed from **Terminated** to **Active**.

This algorithm is invoked using the following scenario:

If...	Then...
The membership is in the Active status and the binder payment attributes like the Consider Binder Liability Amount Flag is configured as N along with the Membership Status Reason when Binder Payment Received is configured as Binder Payment Received in the Field Mapping screen	<p>The system checks whether the hold billing switch in the CI_MEMBERSHIP table contains any value. If any value exists, the system releases the billable charges which are kept on hold for the membership. In addition, the system performs the following operations:</p> <ul style="list-style-type: none"> • Retrieves the account (of the financial responsible person) for the membership. • Retrieves the non-binder payment contracts for the accounts from the CI_SA table. • Retrieves the billable charges present on the non-binder payment contracts where the membership ID is stamped as a characteristic. • Checks whether the bill after date of each billable charge contains a future date. If the bill after date contains a future date then it is changed to the system date minus one.

C1-BNFTODO

This algorithm is invoked from the **C1-BNDMNTR** binder payment monitoring batch, specifically for creating a To Do. This algorithm considers the following scenarios:

Scenario	System Behavior
The binder payment is received within the grace days	The algorithm creates a To Do and updates either the membership or corresponding member's status reason to Binder Payment Received .
The binder payment is not received within the grace days	The algorithm creates a To Do and updates either the membership or corresponding member's status reason to Binder Payment not Received .
The Consider Binder Liability Amount Flag attribute is set to Y and the binder payment amount is received.	The algorithm retrieves the value of the To Do Type for Binder Payment Received attribute from the Field Mapping screen and creates the To Do with the message, Binder Payment of Amount [%1] Received for Membership with Binder Payment Identifier [%2] and Health Plan [%3]
The Consider Binder Liability Amount Flag attribute is set to N and at least a single binder payment is received.	The algorithm retrieves the value of the To Do Type for Binder Payment Received attribute from the Field Mapping screen and creates the To Do with the message, Binder Payment of Amount [%1] Received for Membership with Binder Payment Identifier [%2] and Health Plan [%3]
The Consider Binder Liability Amount Flag attribute is set to Y and the binder payment is not received.	The algorithm retrieves the value of the To Do Type for Binder Payment Not Received attribute from the Field Mapping screen and creates the To Do with the message, Binder Payment of expected amount [%1] not received for Membership with Binder Payment Identifier [%2] and Health Plan [%3]
The Consider Binder Liability Amount Flag attribute is set to N and not even a single binder payment is received.	The algorithm retrieves the value of the To Do Type for Binder Payment Not Received attribute from the Field Mapping screen and creates the To Do with the message, Binder Payment is not received for Membership with Binder Payment Identifier [%1] and Health Plan [%2]

Note:

- [%1] refers to the total payment amount, comprising of all the payments made till date.
- [%2] refers to the binder payment identifier.
- [%3] refers to the specific health plan.

The **Consider Binder Liability Amount Flag** attribute is configured in the **Field Mapping** screen whereas the **To Do Creation** process happens when the **C1-BNFTODO** algorithm is attached as a soft parameter on the **C1-BNDMNTR** batch.

C1-CCPYTSADS

This algorithm is invoked when it is attached to the **Payment Tender Staging Distribution** system event of the customer class to which the account belongs. In addition, it checks whether the payment received is the first payment for the account. If the payment happens to be the first payment for the account, the payment is applied against the binder contract, which is created using the contract type specified in the payment distribution algorithm of the **Binder Payment** match type.

This algorithm introduces the following new parameters which are used for individual binder payment functionality:

- **Check Binder Payment For Individual** - Used when you want to transfer the payment to the binder contract. The valid values are:
 - **Y**
 - **N**

- **Membership Status Reason** - Used to notify the status reason of the binder payment for the membership. The valid value is:
 - **Awaiting Binder Payment**
- **Exchange Assigned Subscriber Number Characteristic** - Used while creating payment staging characteristic.
- **Exchange Assigned Subscriber Number Id Type** - Used when you want to identify the membership from the membership identifier (**CI_MEMBERSHIP_IDENTIFIER**) table.

This algorithm considers the following scenarios:

If...	Then...
The Check Promise To Pay parameter is set to Y	The algorithm checks whether there is an active promise to pay for the account. If an active promise to pay exists, the payment is applied against the contract which is created using the contract type specified in the payment distribution algorithm of the On Account match type.
The Check Payment Agreement Request parameter is set to Y	The algorithm checks whether there is an active payment agreement request for the account. If an active payment agreement exists, the payment is applied against the contract which is created using the contract type specified in the payment distribution algorithm of the On Account match type.
The Check Promise To Pay and Check Payment Agreement Request parameters are set to N	The payment is applied to the account's unpaid bills in the order of the due date. If the payment amount is greater than the sum total of the account's billed balance plus the overpayment threshold amount, the entire payment amount is applied against the excess credit contract of the account.
The payment amount is greater than the account's billed balance, but less than the sum total of the account's billed balance plus the overpayment threshold amount	The payment is first applied against the unpaid bills of the account and the overpayment amount is then applied against the excess credit contract of the account.
The Check Binder Payment for Individual parameter is set to Y	The algorithm retrieves the membership by using the binder payment identification value which is received in the payment characteristics from the EDI 820 file.
The Membership Status Code for Pending Effectuation attribute is set to Pending Effectuation and the Membership Status Reason Hold / Awaiting Binder Payment attribute is set to Awaiting Binder Payment in the Field Mapping screen	<p>The algorithm performs the following steps:</p> <ol style="list-style-type: none"> 1. Retrieves the Binder Contract Type attribute and its value from the Field Mapping screen. 2. If the contract information is not found in the Binder Contract Type attribute then a new contract Id of the type Binder Contract is created on the account. If the contract information is found, the contract Id of the account is retrieved using the Binder Contract Type attribute. 3. Creates a payment staging record using the Binder Payment Match Type soft parameter and the value as the binder contract Id of the account, retrieved using the Binder Contract Type attribute. 4. Stores the binder payment identification value as a characteristic on the payment.

If...	Then...
<p>If the Membership Status Code for Pending Effectuation attribute is not Pending Effectuation and the Membership Status Reason Hold / Awaiting Binder Payment attribute is not Awaiting Binder Payment in the Field Mapping screen</p>	<p>The algorithm performs the following steps:</p> <ol style="list-style-type: none"> 1. The payment is applied against the bill. 2. The binder payment identification value is added as a characteristic on the payment when the payment is received from the EDI 820 file against the bill Id. 3. The already existing soft parameters related to binder payment are removed and the binder related parameters are retrieved from the Field Mapping screen.

It contains the following parameters:

- **Check Binder Payment** - Used when you want to check whether the payment is the first payment for the account and the tender used for the payment is not an automatic payment. The valid values are:
 - Y
 - N
- **Check Promise To Pay** - Used when you want to check whether there is an active promise to pay for the account. The valid values are:
 - Y
 - N
- **Check Payment Agreement Request** - Used when you want to check whether there is an active payment agreement request for the account. The valid values are:
 - Y
 - N
- **Overpayment Threshold Amount** - Used to specify the overpayment threshold amount.
- **Bill Match Type** - Used to specify the match type using which you want to apply the payment against the unpaid bills of the account.
- **Binder Payment Match Type** - Used to specify the match type using which you want to apply the first non-automatic payment against the contract of the account.
- **On Account Match Type** - Used to specify the match type using which you want to apply the payment against the contract of the account.
- **Payment Review Reason Characteristic Type** - Used to specify the characteristic type which you want to use to store the payment reason.
- **Payment Review Reason for Active Promise To Pay** - Used to specify the characteristic value that must be specified when there is an active promise to pay for the account.
- **Payment Review Reason for Active Payment Agreement Request** - Used to specify the characteristic value that must be specified when there is an active payment agreement request for the account.
- **Payment Review Reason for Overpayment** - Used to specify the characteristic value that must be specified when the payment amount is greater than the sum total of account's billed balance plus overpayment threshold amount.
- **Excess Credit Contract Type** - Used to specify the contract type using which the excess credit contract should be created if it does not exist for the account.

C1-FICRETBC

Prerequisites

- Define the values for the option types **CTME (Characteristic Type For Membership Id)** and **PRSQ (Proration SQI)** in the **C1-ASOBLNG** feature configuration.
- Define the price item which is passed (as a billable charge data) through a health care inbound message.
- Define the pass-through billable charge pricing rule type on the policy plan.

This algorithm is invoked to create SQI (Service Quantity Identifier) based billable charges for fully-insured services. This algorithm creates the following set of SQI based billable charges:

- **Pre-calculated Premium Amount** - SQI based billable charges which are created for pre-calculated premium amount received through a healthcare inbound message.
- **Calculated Premium Amount** - Price items for which the SQI based billable charges are created using the pricing rules defined on the policy plan level.

This algorithm also performs the following operations:

- Creation of the new billable charges.
- Cancellation of the existing billable charges.
- End Date modification of the existing billable charges.

This algorithm is invoked in the following scenarios:

If...	Then...
A billable charge exists for a specific date range where the Billable Charge Status field is set to Billable option which is yet to be processed with the same start date, price item, and membership information	The algorithm modifies only the end date information of that specific billable charge.
The membership is in the Pending Effectuation status and the status reason is Awaiting Binder Payment , where the status reason is mapped with the attribute value of the Membership Status Reason Hold / Awaiting Binder Payment attribute field in Field Mapping screen	The algorithm retrieves the values of the binder payment applicability and hold billing switch from the CI_MEMBERSHIP table. If the binder payment applicability and the hold billing switch is set to Y , the algorithm updates the bill after date information on the billable charge to 31-Dec-2099 .
The billable charge for a particular price item and membership appear in the proposed date range and either of them have a different start date or amount	The algorithm cancels the billable charge.

Note:

Billable charges which are created or updated for calculated charges, are updated accordingly in the **PriceCalculationDetail** entity in the **CI_PRCE_CALC** table. Further, those billable charge entries are marked as **Completed**. The Pricing rule type corresponding to the price item (during the processing of the inbound billable charge information) is fetched from the **PricingRuleTypePriceitem** entity in the **C1_PRC_RULE_TYPE_PRICEITEM** table on the first found basis.

The inbound billable charge information is processed as per the latest billable charge data. Once the inbound message is invoked, the algorithm assumes the following conditions:

- The billable charge line characteristics are not available.
- Every billable charge line has the same currency code.

In the case of modification or cancellation of the existing billable charges, its corresponding bill segments go through the following conditions:

- If the billable charge end date is updated, the algorithm checks for all the bill segments where the date range exceeds the billable charge end date. If the date range exceeds the billable charge end date, then only those billable charges are either canceled or deleted based on the status of the bill segment.
- If the billable charge is canceled, then all the bill segments within that billable charge are either canceled or deleted based on the status of the bill segment.

Finally, the billable charges are stamped with the following information:

- Price Item
- SQI (derived from the **C1-ASOBLLNG** feature configuration)
- Pass-through billable charge entries in the **MEMO ONLY** state.
- Aggregated amount is stamped as service quantity.
- Additional information, if any...

It contains the following parameter:

- **Bill To Type Flag** - This flag is used when the **Contract ID** is added in the **MEMBERSHIP_SA** table.

C1-THRSHDAMT

This algorithm is invoked when the membership is in the **Pending Effectuation** status and the status reason is **Awaiting Binder Payment**, as per the binder payment preference configuration done in the **Field Mapping** screen. It monitors or checks the memberships from whom the binder payment is yet to be received.

This algorithm's behavior is shown as follows:

Scenario	System Behavior
If the BINDER_PAY_APPL_SW field (also known as the Binder Payment Applicability flag) from the CI_MEMBERSHIP table is set to Y	The algorithm retrieves the BINDER LIABILITY_AMT from the CI_MEMBERSHIP table.
If the Consider Binder Liability Amount Flag is set to Y , and the Binder Liability Amount is blank or the Binder Liability Amount is less than zero	The algorithm generates an error, Binder Liability Amount can't be blank or less than zero if the Consider Liability Amount is Y.

Scenario	System Behavior
If the BINDER_LIABILITY_AMT field from the CI_MEMBERSHIP table is not blank and greater than zero	<p>The algorithm calculates the threshold amount using the following formula,</p> $\text{CI_MEMBERSHIP.THRESHOLD_AMT} = \frac{\text{CI_MEMBERSHIP.BINDER_LIABILITY_AMT}}{(\text{CI_MEMBERSHIP.BINDER_PAY_THRES \%})}$ <p>For example, Let's assume that the binder liability amount is \$100 and binder payment threshold percentage is 90%. The algorithm uses the above formula to derive the threshold amount which is $\\$100 * 90\% = 90$. The calculated threshold amount is added in the CI_MEMBERSHIP.THRESHOLD_AMT field for the membership which is in Pending Effectuation status where the status reason is Awaiting Binder Payment.</p>

Note: The threshold amount is updated whenever the binder liability amount or binder threshold percentage value changes for the membership which is in the **Pending Effectuation** status.

Binder Payment Creation

Oracle Revenue Management and Billing considers a payment as a binder payment when a characteristic is defined for the payment using the characteristic type specified in the **Binder Payment Identification Characteristics Type** attribute of the binder payment preference. The system considers the binder payment preference which is specified in the **Binder Payment Field Mapping** option type of the **C1-ASOBLNG** feature configuration. This type of characteristic must be defined when the binder payment is created. It stores the membership identifier to indicate the individual membership for which the binder payment is received.

You can create a binder payment through the following features or interfaces:

- Payment Web Service
- Payment Upload
- Payment Upload Staging
- Payment Request
- Payment Event
- EDI 820 File Upload

While creating a payment through any of the above mechanism except the latter one, you need to ensure that the binder payment identification characteristic is defined for the payment. However, in case of EDI 820 File Upload, the system will extract the data stored in the NM1 tag and store it in the payment characteristics staging table. This is done when the **C1-PUPSG** batch is executed.

You can view the binder payments received for the membership or financial responsible member person's account through the **Payment Event Summary** and **Customer 360° Information** screens.

Binder Payment Monitoring

A new batch named **C1-BPMNT** is introduced to monitor the binder payments for the individual memberships. It checks whether there are any individual memberships where:

- Individual membership status is set to the value specified in the **Membership Status Code for Pending Effectuation** attribute of the binder payment preference.
- Membership status reason is set to the value specified in the **Membership Status Reason when Awaiting Binder Payment** attribute of the binder payment preference.

Note: The batch considers the binder payment preference which is specified in the **Binder Payment Field Mapping** option type of the **C1-ASOBLNG** feature configuration.

If so, the batch checks whether the **Binder Payment Applicability** option is set to **Y** for the individual membership. If so, the system calculates grace date using the membership start date and grace days. If the grace date is equal to or earlier than system date, the batch derives the account for the individual membership. While deriving the account for the individual membership, the system checks whether the characteristic types specified in the **Account Identifier Type Char Type** and **Account Identifier Value Char Type** option types of the **C1-ASOBLNG** feature configuration are defined for the individual membership. If so, the system derives the account using these characteristics defined for the individual membership. If these characteristics are not defined for the individual membership, the system derives the account of financially responsible member person. The system checks whether a payment with the binder payment identification characteristic exists against any contract of the account. If so, the system derives the value from the **Binder Payment Identification ID Type** attribute of the binder payment preference. The system then checks whether the binder payments are received for the individual membership using the values from the following:

- Binder Payment Identification Characteristic
- Binder Payment Identification ID Type attribute of the binder payment preference

If the binder payments are received for the individual membership, the system does the following:

If the Consider Binder Liability Amount set to...	Then...
Y	<p>The system validates whether the sum of binder payments is equal to or greater than the threshold amount. If so, the system does the following:</p> <ul style="list-style-type: none"> • Creates a To Do using the To Do type which is specified in the To Do Type for Binder Payment Received attribute of the binder payment preference. • Updates the membership status reason to the value specified in the Membership Status Reason when Binder Payment Received attribute of the binder payment preference. • Updates the member person status reason using the membership status reason preference which is specified in the Status Reason Mapping option type of the C1-ASOBLNG feature configuration. • Changes the bill after date of the billable charges when the Hold Billing option for the individual membership is set to Y.

If the Consider Binder Liability Amount set to...	Then...
N	<p>The system does not validate the binder payment against the threshold amount. If the binder payment amount is greater than zero, the system does the following:</p> <ul style="list-style-type: none"> • Creates a To Do using the To Do type which is specified in the To Do Type for Binder Payment Received attribute of the binder payment preference. • Updates the membership status reason to the value specified in the Membership Status Reason when Binder Payment Received attribute of the binder payment preference. • Updates the member person status reason using the membership status reason preference which is specified in the Status Reason Mapping option type of the C1-ASOBLLNG feature configuration. <p>Note: In this case, the system does not update the bill after date of the billable charges when the Hold Billing option for the individual membership is set to Y. The system updates the bill after date of the billable charges when the status of the individual membership is changed to Active through a health care inbound message.</p>

If the grace date is later than the system date, the batch does the following irrespective of whether the **Consider Binder Liability Amount** attribute is set to **Y** or **N**:

- Creates a To Do using the To Do type which is specified in the **To Do Type for Binder Payment Not Received** attribute of the binder payment preference.
- Updates the membership status reason to the value specified in the **Membership Status Reason when Binder Payment Not Received** attribute of the binder payment preference.
- Updates the member person status reason using the membership status reason preference which is specified in the **Status Reason Mapping** option type of the **C1-ASOBLLNG** feature configuration.

Binder Payment Preference

The Binder Payment Preference enables you to set the attributes which are used during binder payment creation and monitoring. While deriving the binder payment details for a membership, the system uses the following attributes from the binder payment preference:

- Binder Contract Type
- Binder Payment Identification Characteristics Type
- Binder Payment Identification ID Type
- Consider Binder Liability Amount
- Membership Status Code for Active
- Membership Status Code for Pending Effectuation
- Membership Status Reason on Activating Membership
- Membership Status Reason when Awaiting Binder Payment
- Membership Status Reason when Binder Payment Not Received
- Membership Status Reason when Binder Payment Received
- To Do Type for Binder Payment Not Received

- To Do Type for Binder Payment Received

For more information about these attributes, see [Defining a Binder Payment Preference](#) on page 469.

The system considers the binder payment preference which is specified in the **Binder Payment Field Mapping** option type of the **C1-ASOBLNG** feature configuration. You can define, edit, delete, and copy a binder payment preference through the **Field Mapping** screen.

Related Topics

For more information on...	See...
How to setup the C1-ASOBLNG feature configuration	Setting the C1-ASOBLNG Feature Configuration on page 3421

Searching for a Binder Payment Preference

Prerequisites

To search for a binder payment preference, you should have:

- Values defined in the **FIELD_CAT_FLG** lookup field

Procedure

To search for a binder payment preference:

1. Click the **Admin** link in the **Application** toolbar.
A list appears.
2. From the **Admin** menu, select **F** and then click **Field Mapping**.
A sub-menu appears.
3. Click the **Search** option from the **Field Mapping** sub-menu.
The **Field Mapping** screen appears.
4. Select the **Binder Payment** option from the **Preference Category** list.
5. Enter the additional search criteria in the **Search Field Mapping** zone.

Note: ORMB search engine supports wildcard search, where you can substitute the percentage (%) symbol as a stand in for any word or letter in a search criteria. You can use the ‘%’ wildcard character in all input fields except the date and ID fields. The ‘%’ wildcard character is suffixed automatically at the end of the partial search criteria. Therefore, you may or may not specify the wildcard character at the end of the partial search criteria. However, you have to prefix the wildcard character manually wherever required.

6. Click **Search**.

A list of binder payment preferences that meet the search criteria appears in the **Search Results** section.

Viewing the Binder Payment Preference Details

Procedure

To view the details of a binder payment preference:

1. Search for the binder payment preference in the **Field Mapping** screen.
2. In the **Search Results** section, click the **Broadcast** (📡) icon corresponding to the binder payment preference whose details you want to view.
The **Field Mapping** zone appears.
3. View the details of the binder payment preference in the **Field Mapping** zone.

Related Topics

For more information on...	See...
How to search for a binder payment preference	Searching for a Binder Payment Preference on page 468
Field Mapping zone	Field Mapping

Defining a Binder Payment Preference**Prerequisites**

To define a binder payment preference, you should have:

- Values defined for the **Binder Payment Field Mapping** option type in the **C1-ASOBLLNG** feature configuration.
- Values defined in the **FIELD_CAT_FLG** lookup field

Procedure

To define a binder payment preference:

1. Click the **Admin** link in the **Application** toolbar.
A list appears.
2. From the **Admin** menu, select **F** and then click **Field Mapping**.
A sub-menu appears.
3. Click the **Add** option from the **Field Mapping** sub-menu.

The **Select Business Object** screen appears. It contains the following field:

Field Name	Field Description	Mandatory (Yes or No)
Field Mapping Business Object	Used to indicate the business object using which you want to create a binder payment preference. The valid values are: <ul style="list-style-type: none"> • Field Mapping • Medicare Plan Benefit Package • Membership Status Reason Mapping 	Yes

Note: Alternatively, you can access the **Select Business Object** screen by clicking the **Add** button in the **Page Title** area of the **Field Mapping** screen.

4. Select the **Field Mapping** option from the **Field Mapping Business Object** list.
5. Click **OK**.

The **Field Mapping** screen appears. It contains the following sections:

- **Main** - Used to specify basic details of the binder payment preference. It contains the following fields:

Field Name	Field Description	Mandatory (Yes or No)
Preference	Used to specify the binder payment preference.	Yes
Description	Used to specify the description for the binder payment preference.	Yes

Field Name	Field Description	Mandatory (Yes or No)
Detailed Description	Used to specify additional information about the binder payment preference.	No
Status	Used to indicate the status of the binder payment preference. The valid values are: <ul style="list-style-type: none"> Active Inactive 	Yes

- **Preference Category** - This section contains the following field:

Field Name	Field Description	Mandatory (Yes or No)
Preference Category	Used to indicate the category to which the preference belongs. The valid values are: <ul style="list-style-type: none"> Billing Binder Payment Geographic Rating Area Individual Membership Medicare Medicare Plan Benefit Member Reconciliation Member Relationship and Subscription Tier Member Status Reason Preferences Statement Construct 	Yes
	Note: You must select Binder Payment option as the preference category while creating a binder payment preference.	

- **Preference Settings** - Used to set the attributes in the binder payment preference.

Field Name	Field Description	Mandatory (Yes or No)
Attribute	<p>Used to indicate the attribute which you want to set in the binder payment preference. The valid values are:</p> <ul style="list-style-type: none"> • Binder Contract Type - Used when you want to identify the binder contract in the binder payment preference. • Consider Binder Liability Amount Flag - Used when you want to set the consider binder liability amount flag once the binder payment is received in the binder payment preference. • Binder Payment Identification Characteristics Type - Used when you want to identify the membership for whom the payment is received in the binder payment preference. • Binder Payment Identification ID Type - Used when you want to identify the membership type in the binder payment preference. • Membership Status Code for Active - Used when you want to define the status code when the membership is in the Active status in the binder payment preference. • Membership Status Code for Pending Effectuation - Used when you want to define the status code when the membership is in the Pending Effectuation status in the binder payment preference. • Membership Status Reason on Activating Membership - Used when you want to define the status reason code once the binder payment is received and the membership status is changed to Active for the binder payment preference. • Membership Status Reason Hold/Awaiting Binder Payment - Used when you want to define the status reason code as Hold/Awaiting Binder Payment when the binder payment is not yet received for the membership in the binder payment preference. • Membership Status Reason when Binder Payment Not Received - Used when you want to define the status reason code as Binder Payment Not Received when the binder payment is not received for the membership in the binder payment preference. • Membership Status Reason when Binder Payment Received - Used when you want to define the status reason code as Binder Payment Received when the binder payment is received for the membership in the binder payment preference. • To Do Type for Binder Payment Not Received - Used when you want to specify a To Do type when the binder payment is not received for the membership in the binder payment preference. • To Do Type for Binder Payment Received - Used when you want to specify a To Do type when the binder payment is received for the membership in the binder payment preference. 	<p>Yes (Conditional)</p> <div style="border: 1px solid black; padding: 5px; margin-top: 10px;"> <p>Note: This field is required while defining the settings for a binder payment preference.</p> </div>

Field Name	Field Description	Mandatory (Yes or No)														
Value	Used to specify the attribute value. The list varies depending on the attribute you want to set in the binder payment preference:	Yes (Conditional) Note: This field is required while defining the settings for a binder payment preference.														
	<table border="1"> <thead> <tr> <th>If the attribute is set to...</th> <th>Then...</th> </tr> </thead> <tbody> <tr> <td>Consider Binder Liability Amount Flag</td> <td> The list includes the following values: <ul style="list-style-type: none"> • Yes (Y) • No (N) </td> </tr> <tr> <td colspan="2">Note:</td> </tr> <tr> <td colspan="2"> <table border="1"> <thead> <tr> <th>If the value is...</th> <th>Then...</th> </tr> </thead> <tbody> <tr> <td>Yes (Y)</td> <td>The system considers binder liability amount to calculate the threshold amount.</td> </tr> <tr> <td>No (N)</td> <td>The system does not calculate the threshold amount.</td> </tr> </tbody> </table> </td> </tr> </tbody> </table>		If the attribute is set to...	Then...	Consider Binder Liability Amount Flag	The list includes the following values: <ul style="list-style-type: none"> • Yes (Y) • No (N) 	Note:		<table border="1"> <thead> <tr> <th>If the value is...</th> <th>Then...</th> </tr> </thead> <tbody> <tr> <td>Yes (Y)</td> <td>The system considers binder liability amount to calculate the threshold amount.</td> </tr> <tr> <td>No (N)</td> <td>The system does not calculate the threshold amount.</td> </tr> </tbody> </table>		If the value is...	Then...	Yes (Y)	The system considers binder liability amount to calculate the threshold amount.	No (N)	The system does not calculate the threshold amount.
	If the attribute is set to...		Then...													
Consider Binder Liability Amount Flag	The list includes the following values: <ul style="list-style-type: none"> • Yes (Y) • No (N) 															
Note:																
<table border="1"> <thead> <tr> <th>If the value is...</th> <th>Then...</th> </tr> </thead> <tbody> <tr> <td>Yes (Y)</td> <td>The system considers binder liability amount to calculate the threshold amount.</td> </tr> <tr> <td>No (N)</td> <td>The system does not calculate the threshold amount.</td> </tr> </tbody> </table>		If the value is...	Then...	Yes (Y)	The system considers binder liability amount to calculate the threshold amount.	No (N)	The system does not calculate the threshold amount.									
If the value is...	Then...															
Yes (Y)	The system considers binder liability amount to calculate the threshold amount.															
No (N)	The system does not calculate the threshold amount.															
Binder Payment Identification ID Type	The list includes only those binder payment identification ID types which are already defined in the system.															
Entity Type	<p>Used to indicate the type of entity for which the attribute is applicable. The valid values are:</p> <ul style="list-style-type: none"> • Account • Billable Charge <p>Note: At present, this data is stored for informational purposes only and is not considered in the business logic. If required, you can add more entity types to the MAP_ENTITY_FLG lookup field.</p>	No														

Note: While defining a binder payment preference, you must set at least one attribute in the binder payment preference.

6. Select the **Binder Payment** option from the **Preference Category** list.
7. Enter the required details in the **Main** section.
8. Select the required attribute and value from the respective fields.

9. If you want to set more than one attribute in the binder payment preference, click the **Add (+)** icon and then repeat step 8.

Note: However, if you want to remove an attribute from the binder payment preference, click the **Delete (🗑)** icon corresponding to the attribute.

10. Click **Save**.

The binder payment preference is defined.

Editing a Binder Payment Preference

Prerequisites

To edit a binder payment preference, you should have:

- Values defined for **Binder Payment Field Mapping** option type in the **C1-ASOBLNG** feature configuration.
- Values defined in the **FIELD_CAT_FLG** lookup field

Procedure

To edit a binder payment preference:

1. Search for the binder payment preference in the **Field Mapping** screen.
2. In the **Search Results** section, click the **Edit (✎)** icon in the **Edit** column corresponding to the binder payment preference whose details you want to edit.

The **Field Mapping** screen appears. It contains the following sections:

- **Main** - Used to specify basic details of the binder payment preference. It contains the following fields:

Field Name	Field Description	Mandatory (Yes or No)
Preference	Displays the binder payment preference.	Not applicable
Description	Used to specify the description for the binder payment preference.	Yes
Detailed Description	Used to specify additional information about the preference.	No
Status	Used to indicate the status of the binder payment preference. The valid values are: <ul style="list-style-type: none"> • Active • Inactive 	Yes
Preference Category	Indicates the feature for which the preference is designed. The valid value is: <ul style="list-style-type: none"> • Binder Payment 	Not applicable

- **Preference Settings** - Used to define the settings for the member reconciliation preference.

Field Name	Field Description	Mandatory (Yes or No)
Attribute	<p>Used to indicate the attribute which you want to set in the binder payment preference. The valid values are:</p> <ul style="list-style-type: none"> • Binder Contract Type - Used when you want to identify the binder contract in the binder payment preference. • Consider Binder Liability Amount Flag - Used when you want to set the consider binder liability amount flag once the binder payment is received in the binder payment preference. • Binder Payment Identification Characteristics Type - Used when you want to identify the membership for whom the payment is received in the binder payment preference. • Binder Payment Identification ID Type - Used when you want to identify the membership type in the binder payment preference. • Membership Status Code for Active - Used when you want to define the status code when the membership is in the Active status in the binder payment preference. • Membership Status Code for Pending Effectuation - Used when you want to define the status code when the membership is in the Pending Effectuation status in the binder payment preference. • Membership Status Reason on Activating Membership - Used when you want to define the status reason code once the binder payment is received and the membership status is changed to Active for the binder payment preference. • Membership Status Reason Hold/Awaiting Binder Payment - Used when you want to define the status reason code as Hold/Awaiting Binder Payment when the binder payment is not yet received for the membership in the binder payment preference. • Membership Status Reason when Binder Payment Not Received - Used when you want to define the status reason code as Binder Payment Not Received when the binder payment is not received for the membership in the binder payment preference. • Membership Status Reason when Binder Payment Received - Used when you want to define the status reason code as Binder Payment Received when the binder payment is received for the membership in the binder payment preference. • To Do Type for Binder Payment Not Received - Used when you want to specify a To Do type when the binder payment is not received for the membership in the binder payment preference. • To Do Type for Binder Payment Received - Used when you want to specify a To Do type when the 	<p>Yes (Conditional)</p> <p>Note: This field is required while editing the settings for a binder payment preference.</p>

Field Name	Field Description	Mandatory (Yes or No)														
Value	Used to specify the attribute value. The list varies depending on the attribute you want to set in the binder payment preference:	Yes (Conditional)														
	<table border="1"> <thead> <tr> <th>If the attribute is set to...</th> <th>Then...</th> </tr> </thead> <tbody> <tr> <td>Consider Binder Liability Amount Flag</td> <td> The list includes the following values: <ul style="list-style-type: none"> • Yes (Y) • No (N) </td> </tr> <tr> <td colspan="2">Note:</td> </tr> <tr> <td colspan="2"> <table border="1"> <thead> <tr> <th>If the value is...</th> <th>Then...</th> </tr> </thead> <tbody> <tr> <td>Yes (Y)</td> <td>The system considers binder liability amount to calculate the threshold amount.</td> </tr> <tr> <td>No (N)</td> <td>The system does not calculate the threshold amount.</td> </tr> </tbody> </table> </td> </tr> </tbody> </table>	If the attribute is set to...	Then...	Consider Binder Liability Amount Flag	The list includes the following values: <ul style="list-style-type: none"> • Yes (Y) • No (N) 	Note:		<table border="1"> <thead> <tr> <th>If the value is...</th> <th>Then...</th> </tr> </thead> <tbody> <tr> <td>Yes (Y)</td> <td>The system considers binder liability amount to calculate the threshold amount.</td> </tr> <tr> <td>No (N)</td> <td>The system does not calculate the threshold amount.</td> </tr> </tbody> </table>		If the value is...	Then...	Yes (Y)	The system considers binder liability amount to calculate the threshold amount.	No (N)	The system does not calculate the threshold amount.	Note: This field is required while editing the settings for a binder payment preference.
	If the attribute is set to...	Then...														
Consider Binder Liability Amount Flag	The list includes the following values: <ul style="list-style-type: none"> • Yes (Y) • No (N) 															
Note:																
<table border="1"> <thead> <tr> <th>If the value is...</th> <th>Then...</th> </tr> </thead> <tbody> <tr> <td>Yes (Y)</td> <td>The system considers binder liability amount to calculate the threshold amount.</td> </tr> <tr> <td>No (N)</td> <td>The system does not calculate the threshold amount.</td> </tr> </tbody> </table>		If the value is...	Then...	Yes (Y)	The system considers binder liability amount to calculate the threshold amount.	No (N)	The system does not calculate the threshold amount.									
If the value is...	Then...															
Yes (Y)	The system considers binder liability amount to calculate the threshold amount.															
No (N)	The system does not calculate the threshold amount.															
Binder Payment Identification ID Type	The list includes only those binder payment identification ID types which are already defined in the system.															
Entity Type	Used to indicate the type of entity for which the attribute is applicable. The valid values are: <ul style="list-style-type: none"> • Account • Billable Charge 	No														
	Note: At present, this data is stored for informational purposes only and is not considered in the business logic. If required, you can add more entity types to the MAP_ENTITY_FLG lookup field.															

Tip: Alternatively, you can edit the details of a binder payment preference by clicking the **Edit** button in the **Field Mapping** zone.

3. Modify the required details in the **Main** section.
4. Define, edit, or remove the attribute from the binder payment preference, if required.

Note: You must set at least one attribute in a binder payment preference.

5. Click **Save**.

The changes made to the binder payment preference are saved.

Related Topics

For more information on...	See...
How to search for a binder payment preference	Searching for a Binder Payment Preference on page 468
Field Mapping screen	Field Mapping

Copying a Binder Payment Preference

Instead of creating a binder payment preference from scratch, you can create a new binder payment preference using an existing binder payment preference. This is possible through copying a binder payment preference. On copying a binder payment preference, the details including the attributes are copied to the new binder payment preference. You can then edit the details, if required.

Prerequisites

To copy a binder payment preference, you should have:

- Binder Payment preference (whose copy you want to create) defined in the application
- Values defined for **Binder Payment Field Mapping** option type in the **C1-ASOBLNG** feature configuration.
- Values defined in the **FIELD_CAT_FLG** lookup field

Procedure

To copy a binder payment preference:

1. Search for the binder payment preference in the **Field Mapping** screen.
2. In the **Search Results** section, click the **Duplicate** (📄) icon in the **Duplicate** column corresponding to the binder payment preference whose copy you want to create.
3. Click **OK**.

The **Field Mapping** screen appears. It contains the following sections:

- **Main** - Used to specify basic details of the binder payment preference. It contains the following fields:

Field Name	Field Description	Mandatory (Yes or No)
Preference	Used to specify the binder payment preference.	Yes
Description	Used to specify the description for the binder payment preference.	Yes
Detailed Description	Used to specify additional information about the binder payment preference.	No
Status	Used to indicate the status of the binder payment preference. The valid values are: <ul style="list-style-type: none"> • Active • Inactive 	Yes
Preference Category	Indicates the feature for which the preference is designed. The valid values is: <ul style="list-style-type: none"> • Binder Payment 	Not applicable

- **Preference Settings** - Used to set the attributes in the binder payment preference.

Field Name	Field Description	Mandatory (Yes or No)
Attribute	<p>Used to indicate the attribute which you want to set in the binder payment preference. The valid values are:</p> <ul style="list-style-type: none"> • Binder Contract Type - Used when you want to identify the binder contract in the binder payment preference. • Consider Binder Liability Amount Flag - Used when you want to set the consider binder liability amount flag once the binder payment is received in the binder payment preference. • Binder Payment Identification Characteristics Type - Used when you want to identify the membership for whom the payment is received in the binder payment preference. • Binder Payment Identification ID Type - Used when you want to identify the membership type in the binder payment preference. • Membership Status Code for Active - Used when you want to define the status code when the membership is in the Active status in the binder payment preference. • Membership Status Code for Pending Effectuation - Used when you want to define the status code when the membership is in the Pending Effectuation status in the binder payment preference. • Membership Status Reason on Activating Membership - Used when you want to define the status reason code once the binder payment is received and the membership status is changed to Active for the binder payment preference. • Membership Status Reason Hold/Awaiting Binder Payment - Used when you want to define the status reason code as Hold/Awaiting Binder Payment when the binder payment is not yet received for the membership in the binder payment preference. • Membership Status Reason when Binder Payment Not Received - Used when you want to define the status reason code as Binder Payment Not Received when the binder payment is not received for the membership in the binder payment preference. • Membership Status Reason when Binder Payment Received - Used when you want to define the status reason code as Binder Payment Received when the binder payment is received for the membership in the binder payment preference. • To Do Type for Binder Payment Not Received - Used when you want to specify a To Do type when the binder payment is not received for the membership in the binder payment preference. • To Do Type for Binder Payment Received - Used when you want to specify a To Do type when the 	<p>Yes (Conditional)</p> <div style="border: 1px solid black; padding: 5px; margin-top: 10px;"> <p>Note: This field is required while defining the settings for a binder payment preference.</p> </div>

Field Name	Field Description	Mandatory (Yes or No)														
Value	Used to specify the attribute value. The list varies depending on the attribute you want to set in the binder payment preference:	Yes (Conditional)														
	<table border="1"> <thead> <tr> <th>If the attribute is set to...</th> <th>Then...</th> </tr> </thead> <tbody> <tr> <td>Consider Binder Liability Amount Flag</td> <td> The list includes the following values: <ul style="list-style-type: none"> • Yes (Y) • No (N) </td> </tr> <tr> <td colspan="2">Note:</td> </tr> <tr> <td colspan="2"> <table border="1"> <thead> <tr> <th>If the value is...</th> <th>Then...</th> </tr> </thead> <tbody> <tr> <td>Yes (Y)</td> <td>The system considers binder liability amount to calculate the threshold amount.</td> </tr> <tr> <td>No (N)</td> <td>The system does not calculate the threshold amount.</td> </tr> </tbody> </table> </td> </tr> </tbody> </table>	If the attribute is set to...	Then...	Consider Binder Liability Amount Flag	The list includes the following values: <ul style="list-style-type: none"> • Yes (Y) • No (N) 	Note:		<table border="1"> <thead> <tr> <th>If the value is...</th> <th>Then...</th> </tr> </thead> <tbody> <tr> <td>Yes (Y)</td> <td>The system considers binder liability amount to calculate the threshold amount.</td> </tr> <tr> <td>No (N)</td> <td>The system does not calculate the threshold amount.</td> </tr> </tbody> </table>		If the value is...	Then...	Yes (Y)	The system considers binder liability amount to calculate the threshold amount.	No (N)	The system does not calculate the threshold amount.	Note: This field is required while defining the settings for a binder payment preference.
	If the attribute is set to...	Then...														
Consider Binder Liability Amount Flag	The list includes the following values: <ul style="list-style-type: none"> • Yes (Y) • No (N) 															
Note:																
<table border="1"> <thead> <tr> <th>If the value is...</th> <th>Then...</th> </tr> </thead> <tbody> <tr> <td>Yes (Y)</td> <td>The system considers binder liability amount to calculate the threshold amount.</td> </tr> <tr> <td>No (N)</td> <td>The system does not calculate the threshold amount.</td> </tr> </tbody> </table>		If the value is...	Then...	Yes (Y)	The system considers binder liability amount to calculate the threshold amount.	No (N)	The system does not calculate the threshold amount.									
If the value is...	Then...															
Yes (Y)	The system considers binder liability amount to calculate the threshold amount.															
No (N)	The system does not calculate the threshold amount.															
Binder Payment Identification ID Type	The list includes only those binder payment identification ID types which are already defined in the system.															
Entity Type	Used to indicate the type of entity for which the attribute is applicable. The valid values are: <ul style="list-style-type: none"> • Account • Billable Charge • Membership • Payment 	No														

Note: While defining a binder payment preference, you must set at least one attribute in the binder payment preference.

Tip: Alternatively, you can copy a binder payment preference by clicking the **Duplicate** button in the **Field Mapping** zone.

4. Enter the required details in the **Main** section.
5. Define, edit, or remove the attribute from the binder payment preference, if required.
6. Click **Save**.

The new binder payment preference is created.

Related Topics

For more information on...	See...
How to search for a binder payment preference	Searching for a Binder Payment Preference on page 468
Field Mapping screen	Field Mapping

Deleting a Binder Payment Preference

Procedure

To delete a binder payment preference:

1. Search for the binder payment preference in the **Field Mapping** screen.
2. In the **Search Results** section, click the **Delete** (🗑️) icon in the **Delete** column corresponding to the binder payment preference that you want to delete.

A message appears confirming whether you want to delete the binder payment preference.

Tip: Alternatively, you can delete a binder payment preference by clicking the **Delete** button in the **Field Mapping** zone.

3. Click **OK**.

The binder payment preference is deleted.

Related Topics

For more information on...	See...
How to search for a binder payment preference	Searching for a Binder Payment Preference on page 468

Membership Status Reason Preference

The Membership Status Reason preference enables you to map a member person status and status reason with an individual membership status reason. This mapping is used during:

- **Membership Status Transition** - When the member person status and status reason are received through a health care inbound message or membership repricing inbound web service
- **Member Person Status Transition** - When the binder payment is monitored for the individual membership

The system enables you to define, edit, delete, and copy a membership status reason preference through the **Field Mapping** screen. You can derive the member person status and member person status reason mapping attributes from the values specified in the **MEMBER_PER_STATUS_FLG** and **MEMB_PERS_STAT_RSN_FLG** lookup fields, where as the mapping attributes of the membership status reason can be derived from the **Status Reason** screen.

The system determines the individual membership status reason using the membership status reason preference which is specified in the **Status Reason Mapping** option type of the **C1-ASOBLNG** feature configuration.

Searching for a Membership Status Reason Preference

Prerequisites

To search for a membership status reason preference, you should have:

- Values defined in the **FIELD_CAT_FLG** lookup field

Procedure

To search for a membership status reason preference:

1. Click the **Admin** link in the **Application** toolbar.
A list appears.
2. From the **Admin** menu, select **F** and then click **Field Mapping**.
A sub-menu appears.
3. Click the **Search** option from the **Field Mapping** sub-menu.
The **Field Mapping** screen appears.
4. Select the **Membership Status Reason** option from the **Preference Category** list.
5. Enter the additional search criteria in the **Search Field Mapping** zone.

Note: ORMB search engine supports wildcard search, where you can substitute the percentage (%) symbol as a stand in for any word or letter in a search criteria. You can use the ‘%’ wildcard character in all input fields except the date and ID fields. The ‘%’ wildcard character is suffixed automatically at the end of the partial search criteria. Therefore, you may or may not specify the wildcard character at the end of the partial search criteria. However, you have to prefix the wildcard character manually wherever required.

6. Click **Search**.

A list of membership status reason preferences that meet the search criteria appears in the **Search Results** section.

Viewing the Membership Status Reason Preference Details**Procedure**

To view the details of a membership status reason preference:

1. Search for the membership status reason preference in the **Field Mapping** screen.
2. In the **Search Results** section, click the **Broadcast** () icon corresponding to the membership status reason whose details you want to view.
The **Field Mapping** zone appears.
3. View the details of the membership status reason in the **Field Mapping** zone.

Related Topics

For more information on...	See...
How to search for a membership status reason preference	Searching for a Membership Status Reason Preference on page 480

Defining a Membership Status Reason Preference**Prerequisites**

To define a membership status reason preference, you should have:

- Values defined in the **MEMBER_PER_STATUS_FLG** and **MEMB_PERS_STAT_RSN_FLG** lookup field
- Membership status reason defined in the application.

Procedure

To define a membership status reason preference:

1. Click the **Admin** link in the **Application** toolbar.

A list appears.

- From the **Admin** menu, select **F** and then click **Field Mapping**.

A sub-menu appears.

- Click the **Add** option from the **Field Mapping** sub-menu.

The **Select Business Object** screen appears. It contains the following field:

Field Name	Field Description	Mandatory (Yes or No)
Field Mapping Business Object	Used to indicate the business object using which you want to create the billing preference. The valid values are: <ul style="list-style-type: none"> Field Mapping Medicare Plan Benefit Package Membership Status Reason Mapping 	Yes

Note: Alternatively, you can access the **Select Business Object** screen by clicking the **Add** button in the **Page Title** area of the **Field Mapping** screen.

- Select the **Membership Status Reason Mapping** option from the **Field Mapping Business Object** list.
- Click **OK**.

The **Membership Status Reason Mapping** screen appears. It contains the following sections:

- Main** - Used to specify basic details of the membership status reason preference. It contains the following fields:

Field Name	Field Description	Mandatory (Yes or No)
Preference	Used to specify the membership status reason preference.	Yes
Description	Used to specify the description for the membership status reason preference.	Yes

- Status Reason Mapping** - Used to create the mappings in the membership status reason preference. It contains the following fields in a grid:

Field Name	Field Description	Mandatory (Yes or No)
Member Person Status	Used to indicate the status of the person in the membership. The valid values are: <ul style="list-style-type: none"> Active Canceled Inactive Pending Effectuation 	Yes (Conditional)
	Note: This list includes only those statuses which are defined in the MEMBER_PER_STATUS_FLG lookup field.	Note: This field is required while creating a mapping in the membership status reason preference.

Field Name	Field Description	Mandatory (Yes or No)
Member Person Status Reason	<p>Used to indicate the reason why the status of the member person is changed. The valid values are:</p> <ul style="list-style-type: none"> • Awaiting Binder Payment • Binder Payment Not Received • Binder Payment Received • Binder payment notification send to upstream • Member is added by mistake • Employee Left organization • New Enrollment • Membership is re-instated • Spouse legally separated • Membership is Terminated <p>Note: This list includes only those status reasons which are defined in the MEMB_PERS_STAT_RSN_FLG lookup field.</p>	<p>Yes (Conditional)</p> <p>Note: This field is required while creating a mapping in the membership status reason preference.</p>
Membership Status Reason	<p>Used to indicate the reason why the status of the membership is changed.</p> <p>Note: You must specify a membership status reason which is already defined in the system.</p>	<p>Yes (Conditional)</p> <p>Note: This field is required while creating a mapping in the membership status reason preference.</p>

Note: While defining a membership status reason preference, you must create at least one mapping in the membership status reason preference.

6. Enter the required details in the **Main** section.
7. Select the required status reason mapping from the respective fields.
8. If you want to set more than one status reason mapping in the membership status reason preference, click the **Add (+)** icon and then repeat step 8.

Note: However, if you want to remove a status reason mapping from the membership status reason preference, click the **Delete (🗑)** icon corresponding to the status reason mapping.

9. Click **Save**.

The membership status reason preference is defined.

Editing a Membership Status Reason Preference

Prerequisites

To edit a membership status reason preference, you should have:

- Values defined in the **MEMBER_PER_STATUS_FLG** and **MEMB_PERS_STAT_RSN_FLG** lookup field
- Membership status reason defined in the application.

Procedure

To edit a membership status reason preference:

1. Search for the membership status reason preference in the **Field Mapping** screen.
2. In the **Search Results** section, click the **Edit** (✎) icon in the **Edit** column corresponding to the membership status reason preference whose details you want to edit.

The **Membership Status Reason Mapping** screen appears. It contains the following sections:

- **Main** - Used to specify basic details of the membership status reason preference. It contains the following fields:

Field Name	Field Description	Mandatory (Yes or No)
Preference	Displays the membership status reason preference.	Not applicable
Description	Used to specify the description for the membership status reason preference.	Yes

- **Status Reason Mapping** - Used to create or edit the mappings in the membership status reason preference. It contains the following fields in a grid:

Field Name	Field Description	Mandatory (Yes or No)
Member Person Status	Used to indicate the status of the person in the membership. The valid values are: <ul style="list-style-type: none"> • Active • Canceled • Inactive • Pending Effectuation 	Yes (Conditional)
	<p>Note: This list includes only those statuses which are defined in the MEMBER_PER_STATUS_FLG lookup field.</p>	

Field Name	Field Description	Mandatory (Yes or No)
Member Person Status Reason	<p>Used to indicate the reason why the status of the member person is changed. The valid values are:</p> <ul style="list-style-type: none"> • Awaiting Binder Payment • Binder Payment Not Received • Binder Payment Received • Binder payment notification send to upstream • Member is added by mistake • Employee Left organization • New Enrollment • Membership is re-instated • Spouse legally separated • Membership is Terminated <p>Note: This list includes only those status reasons which are defined in the MEMB_PERS_STAT_RSN_FLG lookup field.</p>	<p>Yes (Conditional)</p> <p>Note: This field is required while editing a mapping in the membership status reason preference.</p>
Membership Status Reason	<p>Used to indicate the reason why the status of the membership is changed.</p> <p>Note: You must specify a membership status reason which is already defined in the system.</p>	<p>Yes (Conditional)</p> <p>Note: This field is required while editing a mapping in the membership status reason preference.</p>

Tip: Alternatively, you can edit the details of a membership status reason preference by clicking the **Edit** button in the **Field Mapping** zone.

3. Modify the required details in the **Main** section.
4. Define, edit, or remove the status reason mapping from the membership status reason preference, if required.

Note: You must create at least one status reason mapping in a membership status reason preference.

5. Click **Save**.

The changes made to the membership status reason preference are saved.

Related Topics

For more information on...	See...
How to search for a membership status reason preference	Searching for a Membership Status Reason Preference on page 480

Copying a Membership Status Reason Preference

Instead of creating a membership status reason preference from scratch, you can create a new membership status reason preference using an existing membership status reason preference. This is possible through copying a membership status reason preference. On copying a membership status reason preference, the details including the attributes are copied to the new membership status reason preference. You can then edit the details, if required.

Prerequisites

To copy a membership status reason preference, you should have:

- Membership status reason preference (whose copy you want to create) defined in the application
- Values defined in the **MEMBER_PER_STATUS_FLG** and **MEMB_PERS_STAT_RSN_FLG** lookup field
- Membership status reason defined in the application.

Procedure

To copy a membership status reason preference:

1. Search for the membership status reason preference in the **Field Mapping** screen.
2. In the **Search Results** section, click the **Duplicate**  icon in the **Duplicate** column corresponding to the membership status reason preference whose copy you want to create.

The **Membership Status Reason Mapping** screen appears. It contains the following sections:

- **Main** - Used to specify basic details of the membership status reason preference. It contains the following fields:

Field Name	Field Description	Mandatory (Yes or No)
Preference	Used to specify the membership status reason preference.	Yes
Description	Used to specify the description for the membership status reason preference.	Yes

- **Status Reason Mapping** - Used to create the mappings in the membership status reason preference. It contains the following fields in a grid:

Field Name	Field Description	Mandatory (Yes or No)
Member Person Status	Used to indicate the status of the person in the membership. The valid values are: <ul style="list-style-type: none"> • Active • Canceled • Inactive • Pending Effectuation 	Yes (Conditional)
	<p>Note: This list includes only those statuses which are defined in the MEMBER_PER_STATUS_FLG lookup field.</p>	<p>Note: This field is required while creating a mapping in the membership status reason preference.</p>

Field Name	Field Description	Mandatory (Yes or No)
Member Person Status Reason	<p>Used to indicate the reason why the status of the member person is changed. The valid values are:</p> <ul style="list-style-type: none"> • Awaiting Binder Payment • Binder Payment Not Received • Binder Payment Received • Binder payment notification send to upstream • Member is added by mistake • Employee Left organization • New Enrollment • Membership is re-instated • Spouse legally separated • Membership is Terminated <p>Note: This list includes only those status reasons which are defined in the MEMB_PERS_STAT_RSN_FLG lookup field.</p>	<p>Yes (Conditional)</p> <p>Note: This field is required while creating a mapping in the membership status reason preference.</p>
Membership Status Reason	<p>Used to indicate the reason why the status of the membership is changed.</p> <p>Note: You must specify a membership status reason which is already defined in the system.</p>	<p>Yes (Conditional)</p> <p>Note: This field is required while creating a mapping in the membership status reason preference.</p>

Note: While defining a membership status reason preference, you must create at least one mapping in the membership status reason preference.

3. Enter the required details in the **Main** section.
4. Define, edit, or remove the mapping from the membership status reason preference, if required.
5. Click **Save**.

The new membership status reason preference is defined.

Related Topics

For more information on...	See...
How to search for a membership status reason preference	Searching for a Membership Status Reason Preference on page 480

Deleting a Membership Status Reason Preference

Procedure

To delete a membership status reason preference:

1. Search for the membership status reason in the **Field Mapping** screen.
2. In the **Search Results** section, click the **Delete** (🗑️) icon in the **Delete** column corresponding to the membership status reason preference that you want to delete.

A message appears confirming whether you want to delete the membership status reason preference.

Tip: Alternatively, you can delete a membership status reason preference by clicking the **Delete** button in the **Field Mapping** zone.

3. Click **OK**.

The membership status reason preference is deleted.

Related Topics

For more information on...	See...
How to search for a membership status reason preference	Searching for a Membership Status Reason Preference on page 480

Chapter 7

Customer Registration

Topics:

- [Customer Registration \(Without Approval\) Status Transition](#)
- [Customer Registration \(With Approval\) Status Transition](#)
- [Customer Registration Template](#)
- [Customer Registration Type](#)
- [Customer Registration \(Used for Searching\)](#)
- [Customer Registration \(Used for Viewing\)](#)

Until now, you were able to create person, account, policy, and policy plan from the different screens. Now, ORMB provides the ability to create a person, multiple accounts for the person, multiple policies for the person, and multiple policy plans for the policy from the same user interface. A new object named **Customer Registration** is introduced in this release. Through a customer registration object, you can create person, accounts, policies, and policy plans at the same time from the same interface. Before creating a customer registration object, you need to create the following:

- Customer Registration Template
- Customer Registration Type

While creating a customer registration object, you need to specify the following:

- A customer registration type using which the customer registration object should be created
- A source system from the customer information is received
- A type of person that you want to create through the customer registration object

Once you specify the above details, the **Customer Registration** screen appears with a set of pages and sections which are added in the respective person template. The default values for the fields, characteristic types, identifier types, and phone types are shown as specified in the person template. In addition, the field values, characteristic types, characteristic values, identifier types, identifier values, phone types, and phone numbers are disabled as specified in the person template. On the Accounts page, you can view one row for each account template which is added in the customer registration type. You can then edit the row and thereby create an account for the person. You can create multiple accounts for the person using the same or different template.

Note:

You cannot create sort records and derivation and pricing parameters for the bill group from the **Customer Registration** screen. You can only create these from the **Customer 360° Information** screen or using the health care inbound message.

The system creates effective dated address using the address business object which is specified in the customer registration type. By default, the account override address is effective from the date when the customer registration object is created in the system.

On the **Policies** page, you can view one row for each policy template which is added in the customer registration type. You can then edit the row and thereby

create a policy for the person. You can create multiple policies for the person using the same or different template. On clicking the **Add** icon corresponding to the policy row, you can view one row for each policy plan template which is added in the customer registration type. You can then edit the row and thereby create a policy plan for the policy.

On clicking the **View/Edit** icon or the **Add New Account** button in the **Accounts** page, the **Customer Registration - Add Account** screen appears with a set of pages and sections which are added in the respective account template. The default values for the fields, characteristic types, and identifier types are shown as specified in the account template. In addition, the field values, characteristic types, characteristic values, identifier types, and identifier values are disabled as specified in the account template.

On clicking the **View/Edit** icon or the **Add New Policy** button in the **Policies** page, you need to specify a policy type. The policy type indicates the category to which the policy belongs (i.e. whether it is Self Funded, Fully-Insured Group, or Fully-Insured Individual) and the policy business object using which the policy should be created. Once you specify a policy type, the **Policy** screen appears with a set of sections which are added in the respective policy template. The default values for the fields and characteristic types are shown as specified in the policy template. In addition, the field values, characteristic types, and characteristic values are disabled as specified in the policy template. You can create one or more policies for the person using the same or different policy type.

On clicking the **View/Edit** icon or the **Add New Plan** button corresponding to a policy plan row in the **Policies** page, the **Plan** screen appears with a set of sections which are added in the respective policy plan template. The default values for the fields and characteristic types are shown as specified in the policy plan template. In addition, the field values, characteristic types, and characteristic values are disabled as specified in the policy plan template.

You can save the person, account, policy, and policy plan details as and when you are entering the data by clicking the **Save as Draft** button. On clicking the **Save as Draft** button, the system creates a customer registration object in the Draft status. The status of the policies which are created through the customer registration object is set to Pending. Once the person, account, policy, and policy plan details are specified, you can click the **Validate and Save** button. The system then validates the information. You can edit, delete, or submit a customer registration object when it is in the **Draft** status. On submitting a customer registration object, the person, accounts, policies, and policy plans are created in the system. Finally, the status of the customer registration object is changed to the following depending on the type of person:

Person Type	Status
Parent Customer	Parent Customer Approved
Bill Group	Bill Group Approved
Any Other Person Type Other Than Parent Customer and Bill Group	Complete

You can optionally configure the approval process for the customer registration. If the **Approval Required** option is selected in the customer registration type, the status of the customer registration object is changed to **Approval In Progress** on submitting it. A To Do using the approval To Do type is created and assigned to the users with the approval To Do role. The approver can

then review the customer registration object and accordingly approve, reject, or request the submitter to resubmit the customer registration object for approval. On approving a customer registration object, the person, accounts, policies, and policy plans are created in the system. Finally, the status of the customer registration object is changed to the following depending on the type of person:

Person Type	Status
Parent Customer	Parent Customer Approved
Bill Group	Bill Group Approved
Any Other Person Type Other Than Parent Customer and Bill Group	Complete

If the approver rejects a customer registration object due to some reason, the status of the customer registration object is changed to **Rejected**. However, if the approver requests the submitter to resubmit a customer registration object for approval after making the required changes, the status of the customer registration object is changed to **Draft**. The submitter can then make the required changes and resubmit the customer registration object for approval.

The system provides the following two options while defining a customer registration type:

- Manual Billing Hierarchy and Pricing-** Used when you want to inform the user to create the billing hierarchy and pricing for the parent customer manually. In other words, you want the user to create the required bill groups for the parent customer, the bill group's accounts, pricing rules, bill group sorting information, and bill group derivation and pricing parameters. If this option is selected, a To Do is created using the **Billing Hierarchy and Pricing To Do** type and assigned to the users with the **Billing Hierarchy and Pricing To Do** role. This feature can be used only for customer registration objects where the person type is set to **Parent Customer**. Once the billing hierarchy and pricing is created for the parent customer, the user must complete the corresponding To Do which is created using the **Billing Hierarchy and Pricing To Do** type. On executing the **Customer Registration Monitor (C1-CUSRG)** batch, the system considers all customer registration objects which are in the **Parent Customer Approved** or **Pending Pricing Correction** status. It checks whether the corresponding To Do (if any) created using the **Billing Hierarchy and Pricing To Do** type is completed. If so, it changes the status of the customer registration object to the following depending on whether the **Final Approval Required** option is selected:

Final Approval Required (Yes or No)	Status
Yes	Pending Final Approval
No	Complete

- Final Approval Required-** Used to indicate whether the final approval is required once the approver at the first level approves the customer registration object. Ideally, the final approval is required when the **Manual Billing Hierarchy and Pricing** option is selected. This ensures that the information related to the following entities is created and verified before the customer registration object moves to the **Complete** status:
 - Bill Group

- Bill Group's Accounts
- Bill Group's Sorting Records
- Bill Group's Derivation and Pricing Parameters
- Pricing Rules for the Policy Plans

If this option is selected, a To Do is created using the **Final Approval To Do** type and assigned to the users with the **Final Approval To Do** role. This feature can be used only for customer registration objects where the person type is set to **Parent Customer**. Once the user with the **Final Approval To Do** role approves the customer registration object, the status of the customer registration object is changed to **Complete**.

If the approver requests the submitter to resubmit a customer registration object for approval, the status of the customer registration object is changed to **Pending Pricing Correction**.

Note: The system enables you to create maximum 10 accounts and 5 policies for a person and maximum 10 policy plans for a policy through a customer registration object from the user interface.

Once the status of a customer registration object is changed to **Complete** or **Bill Group Approved**, the system changes the status of the policies created through the customer registration object to **In Force/Active**. In addition, the status of the pricing rules which are created for such policies' policy plans is set to **Active**.

You can also create a customer registration object using the **File Upload Interface** utility through an inbound message. On creating an inbound message using the **File Upload Interface** utility, the status of the inbound message is set to **Pending**. Once the inbound message is processed, a customer registration object is created in the following status depending on the person type:

Person Type	Status
Parent Customer	Complete
Bill Group	Bill Group Approved
Any Other Person Type Other Than Parent Customer and Bill Group	Complete

Note: The above status transition is mentioned based on the assumption that the data uploaded through the **File Upload Interface** utility will be pre-approved and does not require any approval in the system.

At present, only the XML format is supported for creating a customer registration object using the File Upload Interface utility through an inbound message. To implement the Customer Registration feature, the following new screens are introduced in this release:

- Customer Registration Template
- Customer Registration Type
- Customer Registration

Customer Registration (Without Approval) Status Transition

The following figure graphically indicates how a customer registration moves from one status to another when the approval process is not configured in the respective customer registration type:

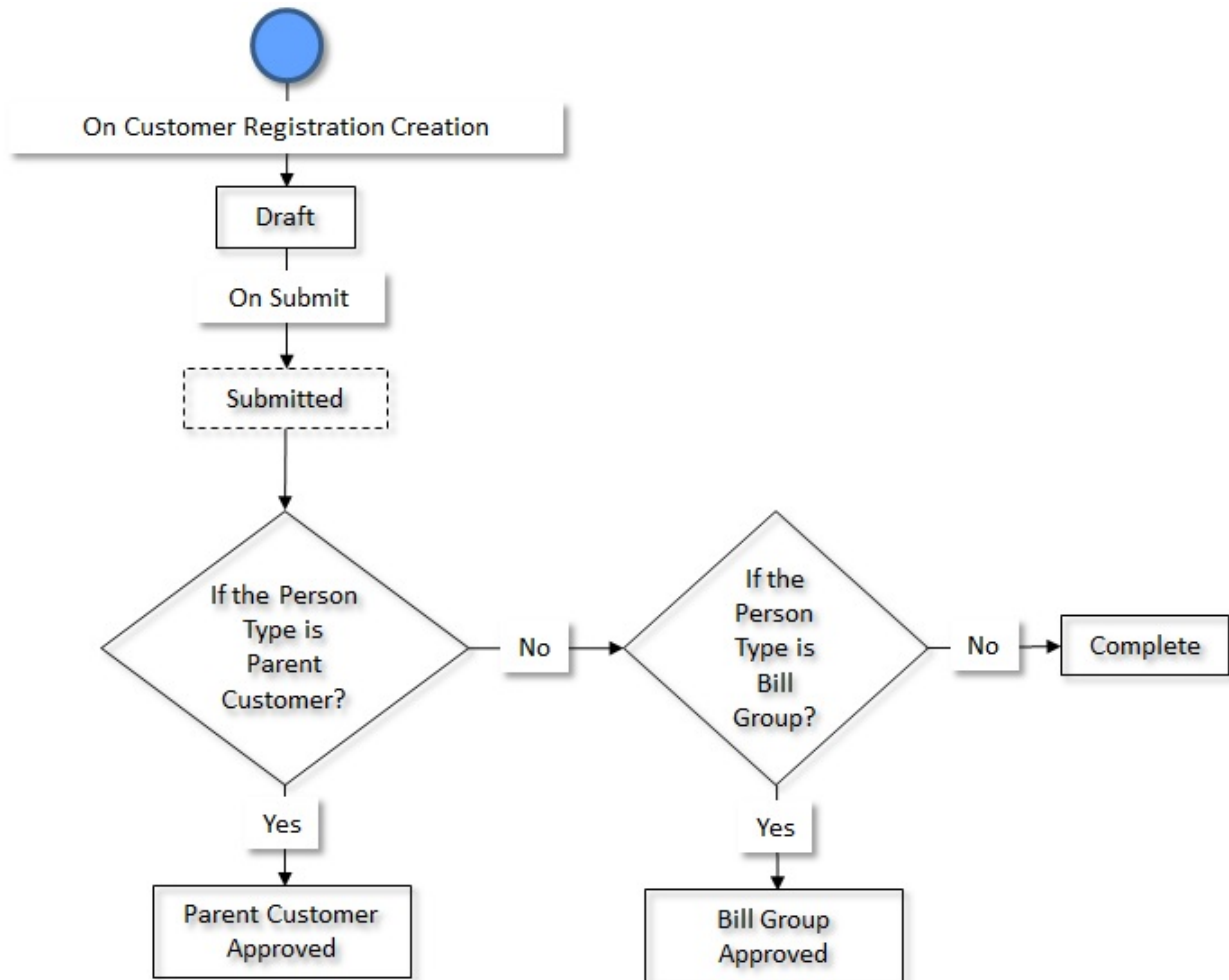

Customer Registration (With Approval) Status Transition

The following figure graphically indicates how a customer registration moves from one status to another when the approval process is configured in the respective customer registration type:

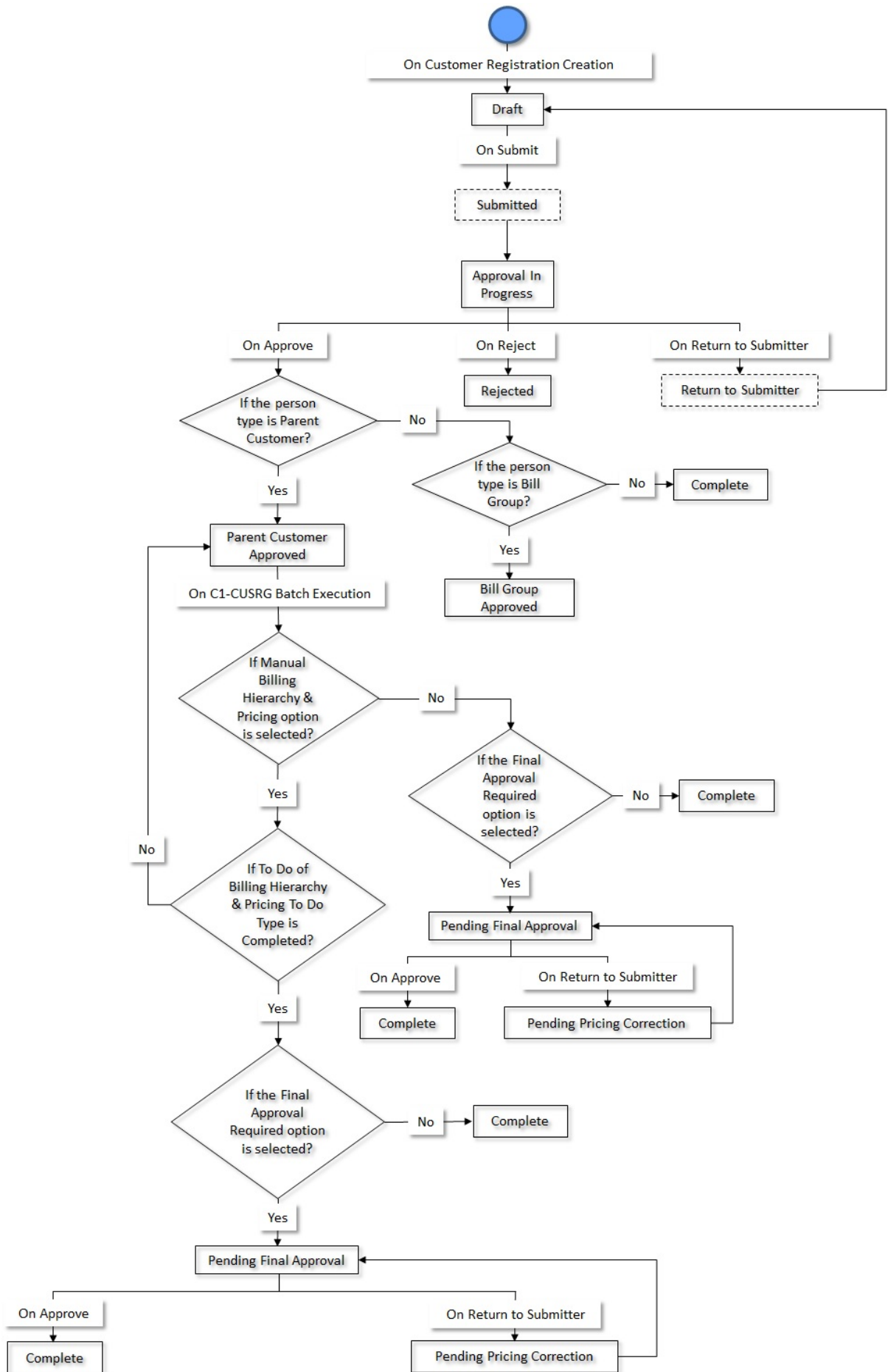

Customer Registration Template

A customer registration template encapsulates the following information:

- List of pages that should appear when you create a person, account, policy, or policy plan using the respective customer registration template
- List of sections that should appear in each page
- Field or characteristic attributes, such as:
 - Default value for a field or characteristic type
 - Default value for a person or account identifier type or phone type
 - Primary identifier type for a person or account
 - Mandatory field in each section
 - Enable or disable the field value, identifier type, identifier value, characteristic type, characteristic value, phone type, or phone number

You can create multiple customer registration templates for person, account, policy and policy plan. Depending on whether you are creating a customer registration template for person, account, policy or policy plan, you can include the following pages and define field or characteristic attributes for the following sections:

Template Category	Template Page	Template Section
Person	Main	Person Main
		Person Names
		Person Identifiers
		Person Phones
	Contact Information	Person Address
		Person Email
	Accounts	-
	Person Hierarchy	Person Hierarchy – Main
		Person Hierarchy – Characteristics
	Person Characteristics	Person Characteristics
	Policies	Policies
		Parent Policies
	Registration Characteristics	Customer Registration Characteristics
Account	Main	Account Information

Template Category	Template Page	Template Section
		Account Identifiers
	Auto Pay	Account Autopay
	Persons	Main
		Account Address Override Information
	Bill Routing	
Account Characteristics	Account Characteristics	
Policy	Policy – Main	Policy Main
		Policy Persons
		Policy Characteristics
Policy Plan	Plan	Plan - Main
		Plan - Characteristics

Search Customer Registration Template

The **Search Customer Registration Template** zone allows you to search for a customer registration template using various search criteria. It contains the following sections:

- **Search Criteria** - The **Search Criteria** section contains the following fields:

Field Name	Field Description	Mandatory (Yes or No)
Search By	<p>Used to indicate whether you want to search for customer registration templates using the banking template or the healthcare template details. The valid values are:</p> <ul style="list-style-type: none"> • Banking Template - Used to indicate whether you want to search for customer registration templates created using the C1-CustomerRegistrationTmplBK business object. • Healthcare Template - Used to indicate whether you want to search for customer registration templates created using the C1-CustomerRegistrationTmplHC business object. <p>Note: By default, the Banking Template option is selected.</p>	Yes
Template	Used to search for a particular template.	No

Field Name	Field Description	Mandatory (Yes or No)
Description	Used to search for customer registration templates having a particular description.	No
Template Category	Used to search for customer registration templates which belong to a particular category. The valid values are: <ul style="list-style-type: none"> Account Person Policy Policy Plan 	No
	Note: The Policy and Policy Plan options appear when you select the Healthcare Template option from the Search By list.	

Note: You must specify at least one search criterion while searching for a customer registration template.

- **Search Results** - On clicking the **Search** button, the search results appear based on the specified search criteria. The **Search Results** section contains the following columns:

Column Name	Column Description
Template	Displays the customer registration template.
Description	Displays the description of the customer registration template.
Template Category	Displays the category to which the customer registration template belongs. The valid values are: <ul style="list-style-type: none"> Account Person Policy Policy Plan
Edit	On clicking the Edit (✎) icon, the Customer Registration Template screen appears where you can edit the details of the customer registration template.
Duplicate	On clicking the Duplicate (📄) icon, the Customer Registration Template screen appears where you can define a new customer registration template using an existing customer registration template.
Delete	On clicking the Delete (🗑) icon, you can delete the customer registration template. <p>Note: You can delete a customer registration template when a customer registration is not yet defined using the customer registration template.</p>

On clicking the **Broadcast** (📡) icon corresponding to a customer registration template, the **Customer Registration Template** zone appears with the details of the respective customer registration template.

By default, the **Filter** area is hidden. You can view the **Filter** area by clicking the **Filters** (🔍) icon in the upper right corner of this zone.

Note: Pagination is used to display limited number of records in the **Search Results** section. You can use the navigation links, such as **Previous** and **Next** to navigate between pages.

Related Topics

For more information on...	See...
How to search for a customer registration template	Searching for a Customer Registration Template on page 499
Customer Registration Template zone	Customer Registration Template on page 498

Customer Registration Template

The **Customer Registration Template** zone displays the details of the customer registration template. It also allows you to edit, copy, and delete the customer registration template. It contains the following sections

- **Main** - Displays the basic information about the customer registration template. It contains the following fields:

Field Name	Field Description
Template	Displays the customer registration template.
Template Category	Indicates the category for which the customer registration template is created in the system. The valid values are: <ul style="list-style-type: none"> • Account • Person • Policy • Policy Plan <p>Note: The Policy and Policy Plan template categories appear when the customer registration template is created using the C1-CustomerRegistrationTmplHC business object.</p>
Description	Displays the description of the customer registration template.
Detailed Description	Displays additional information about the customer registration template.

- **Template Pages** - The **Template Pages** section lists the template pages, template sections added for a particular template category in a customer registration template. It contains the following columns:

Column Name	Column Description
Template Page	Indicates the template page which is added for the template category.
Template Section	Indicates the template section which is defined for the template page.

- **Record Actions** - The **Record Actions** section contains the following buttons:

Button Name	Button Description
Edit	Used to edit the details of the customer registration template.
Delete	Used to delete the customer registration template. <p>Note: You can delete a customer registration template when a customer registration is not yet created using the customer registration template.</p>

Button Name	Button Description
Duplicate	Used to create a new customer registration template using an existing customer registration template.

- **Record Information** - The **Record Information** section contains the following field:

Field Name	Field Description
Business Object	Indicates the business object using which the customer registration template is created in the system. In addition, a context menu appears corresponding to this field which helps in navigating to other screens in the application.
	Note: It has a link. On clicking the link, the Business Object screen appears where you can view the details of the respective business object.

By default, the **Customer Registration Template** zone does not appear in the **Customer Registration Template** screen. It appears when you click the **Broadcast** () icon corresponding to the customer registration template in the **Search Customer Registration Template** zone.

Related Topics

For more information on...	See...
How to define a customer registration template	Defining a Customer Registration Template on page 500
How to edit a customer registration template	Editing a Customer Registration Template on page 513
How to copy a customer registration template	Copying a Customer Registration Template on page 515
How to delete a customer registration template	Deleting a Customer Registration Template on page 516
How to view the details of a customer registration template	Viewing the Customer Registration Template Details on page 500
Customer Registration Template screen	Customer Registration Template on page 495
Search Customer Registration Template zone	Search Customer Registration Template on page 496

Searching for a Customer Registration Template

Prerequisites

To search for a customer registration template, you should have:

- Customer registration template business objects defined in the application
- Customer registration templates defined in the application
- Customer registration templates associated with the template categories

Procedure

To search for a customer registration template:

1. Click the **Admin** link in the **Application** toolbar.
A list appears.
2. From the **Admin** menu, select **C** and then click **Customer Registration Template**.
A sub-menu appears.
3. Click the **Search** option from the **Customer Registration Template** sub-menu.

The **Customer Registration Template** screen appears.

- Enter the search criteria in the **Search Customer Registration Template** zone.

Note: ORMB search engine supports wildcard search, where you can substitute the percentage (%) symbol as a stand in for any word or letter in a search criteria. You can use the ‘%’ wildcard character in all input fields except the date and ID fields. The ‘%’ wildcard character is suffixed automatically at the end of the partial search criteria. Therefore, you may or may not specify the wildcard character at the end of the partial search criteria. However, you have to prefix the wildcard character manually wherever required.

- Click **Search**.

A list of customer registration templates that meet the search criteria appears in the **Search Results** section.

Related Topics

For more information on...	See...
Customer Registration Template screen	Customer Registration Template on page 495
Search Customer Registration Template zone	Search Customer Registration Template on page 496

Viewing the Customer Registration Template Details

Procedure

To view the details of a customer registration template:

- Search for the customer registration template in the **Customer Registration Template** screen.
- In the **Search Results** section, click the **Broadcast** () icon corresponding to the customer registration template whose details you want to view.

The **Customer Registration Template** zone appears.

- View the details of the customer registration template in the **Customer Registration Template** zone.

Related Topics

For more information on...	See...
How to search for a customer registration template	Searching for a Customer Registration Template on page 499
Search Customer Registration Template zone	Search Customer Registration Template on page 496
Customer Registration Template zone	Customer Registration Template on page 498

Defining a Customer Registration Template

Prerequisites

To define a customer registration template, you should have:

- Customer registration template business objects defined in the application
- Template categories defined in the application
- Template pages and sections defined in the application

Procedure

To define a customer registration template:

- Click the **Admin** link in the **Application** toolbar.

A list appears.

- From the **Admin** menu, select **C** and then click **Customer Registration Template**.

A sub-menu appears.

- Click the **Add** option from the **Customer Registration Template** sub-menu.

The **Select Business Object** screen appears. It contains the following field:

Field Name	Field Description	Mandatory (Yes or No)
Customer Registration Template Business Object	Used to indicate the business object using which you want to define the customer registration template. The valid values are: <ul style="list-style-type: none"> Customer Registration Template - Banking - Used to indicate that you want to define a customer registration template using the C1-CustomerRegistrationTmplBK business object. Customer Registration Template - Health Care - Used to indicate that you want to define a customer registration template using the C1-CustomerRegistrationTmplHC business object. 	Yes

Tip: Alternatively, you can access the **Select Business Object** screen by clicking the **Add** button in the **Page Title** area of the **Customer Registration Template** screen.

- Select the required customer registration template business object from the respective field.
- Click **OK**.

The **Customer Registration Template for Banking** or the **Customer Registration Template for Healthcare** screen appears depending upon the selected business object. It contains the following sections:

- Main** - Used to specify basic details about the customer registration template.
- Template Pages** - Used to add template pages and its related sections for the customer registration template.
- Main** - The **Main** section contains the following fields:

Field Name	Field Description	Mandatory (Yes or No)
Template	Used to specify the customer registration template.	Yes

Field Name	Field Description	Mandatory (Yes or No)
Template Category	Used to indicate the category for which you want to define the customer registration template. The valid values are: <ul style="list-style-type: none"> • Account • Person • Policy • Policy Plan 	Yes
	Note: The Policy and Policy Plan options appear when you are defining a customer registration template using the CI-CustomerRegistrationTmplHC business object.	
Business Object	Indicates the business object using which you want to define the customer registration template.	Not applicable
Description	Used to specify the description for the customer registration template.	Yes
Detailed Description	Used to specify additional information about the customer registration template.	No

6. Enter the required details in the **Main** section.
7. Add the template pages and template sections for the customer registration template in the **Template Pages** section.
8. Set the field attributes for the template sections in the **Template Pages** section.
9. Click **Save**.

The customer registration template is defined.

Related Topics

For more information on...	See...
Customer Registration Template screen	Customer Registration Template on page 495
How to add the pages and sections in a customer registration template	Adding the Pages and Sections in a Customer Registration Template on page 502
How to set the field attributes for a template section	Setting the Field Attributes for a Template Section on page 508

Adding the Pages and Sections in a Customer Registration Template

Prerequisites

To add a page and its related sections in a customer registration template, you should have:

- Template categories defined in the application
- Template pages and sections defined in the application

Procedure

To define a customer registration template:

1. Ensure that the **Template Pages** section is expanded when you are defining, editing, or copying a customer registration template.

The **Template Pages** section contains the following fields:

Field Name	Field Description	Mandatory (Yes or No)						
Template Page	Used to indicate the page which you want to add in a customer registration template for a particular template category.	Yes (Conditional) Note: This field is required while adding pages and sections in a customer registration template.						
Template Section	Used to indicate the section and its field attributes which you want to define for a particular page in a customer registration template. Note: On clicking the Add (+) icon, the following columns appear: <table border="1" data-bbox="609 913 1104 1344"> <thead> <tr> <th>Column Name</th> <th>Column Description</th> </tr> </thead> <tbody> <tr> <td>Template Section</td> <td>Used to indicate the section for a particular page.</td> </tr> <tr> <td>Field Attributes</td> <td>Used to define the field attributes of a section. Note: On clicking the Add (+) icon, you can define the field attributes for the section.</td> </tr> </tbody> </table>	Column Name	Column Description	Template Section	Used to indicate the section for a particular page.	Field Attributes	Used to define the field attributes of a section. Note: On clicking the Add (+) icon, you can define the field attributes for the section.	Yes (Conditional) Note: This field is required while adding pages and sections in a customer registration template.
Column Name	Column Description							
Template Section	Used to indicate the section for a particular page.							
Field Attributes	Used to define the field attributes of a section. Note: On clicking the Add (+) icon, you can define the field attributes for the section.							

The following table shows the pages and sections which you can add for a particular template category.

Template Category	Template Pages		Template Sections	
	Template Page	Mandatory (Yes or No)	Template Section	Mandatory (Yes or No)
Account	Auto Pay	No	Account Autopay	No
	Account Characteristics	No	Account Characteristics	No

Template Category	Template Pages		Template Sections	
	Template Page	Mandatory (Yes or No)	Template Section	Mandatory (Yes or No)
	Credit Ratings	No	Credit Rating	No
	<div style="border: 1px solid black; padding: 5px;"> <p>Note: This template page appears when you are defining, editing, or copying a customer registration template which is created using the C1-Customer Registration TmplBK business object.</p> </div>			
	Main	Yes	Account Identifiers	Yes
			Account Information	Yes
			Account Address Override Information	No
	Persons	Yes	Bill Routing	Yes
			Main	Yes
Person	Accounts	No	-	-
	Contact Information	No	Person Address	No
			Person Email	No

Template Category	Template Pages		Template Sections	
	Template Page	Mandatory (Yes or No)	Template Section	Mandatory (Yes or No)
	Deal Information	No	Deal-Main	No
	<div style="border: 1px solid black; padding: 5px;"> <p>Note: This template page appears when you are defining, editing, or copying a customer registration template which is created using the C1-Customer Registration TmplBK business object.</p> </div>			
	Main	Yes	Person Identifiers	Yes
			Person Main	Yes
			Person Names	Yes
			Person Phones	No
	Person Characteristics	No	Person Characteristics	No
	Person Hierarchy	No	Person Hierarchy-Characteristics	No
Person Hierarchy-Main			No	

Template Category	Template Pages		Template Sections	
	Template Page	Mandatory (Yes or No)	Template Section	Mandatory (Yes or No)
	Policies	No	Parent Policy	No
	<p>Note: This template page appears only when you are defining, editing, or copying a customer registration template which is created using the</p> <p>C1-Customer Registration TmplHC business object.</p>		Policies	No
	Registration Characteristics	No	Customer Registration Characteristics	No
Policy	Policy-Main	Yes	Policy Characteristics	No
			Policy-Main	Yes
			Policy Persons	No
<p>Note: This template category appears only when you are defining, editing, or copying a customer registration template which is created using the</p> <p>C1-CustomerRegistration TmplHC business object.</p>				

Template Category	Template Pages		Template Sections	
	Template Page	Mandatory (Yes or No)	Template Section	Mandatory (Yes or No)
Policy Plan Note: This template category appears when you are defining, editing, or copying a customer registration template which is created using the C1-CustomerRegistration TmplHC business object.	Plan	Yes	Plan-Characteristics	No
			Plan-Main	Yes

- Enter the required details in the **Template Pages** section.
- Set the field attributes for the template section, if required.
- If you want to add more than one page or section for the customer registration template, click the **Add (+)** icon and then repeat step 2.

Note: However, if you want to remove a page or section from the customer registration template, click the **Delete** (🗑️) icon corresponding to the page or section.

- Click **Save**.

The pages and sections are added in the customer registration template.

Note:

You can add all the template pages available for a particular template category by clicking the **Select All** check box in the upper left corner of the **Template Pages** section.

You cannot edit or delete a template page or section if a customer registration is already defined using the customer registration template.

Related Topics

For more information on...	See...
Customer Registration Template screen	Customer Registration Template on page 495
How to define a customer registration template	Defining a Customer Registration Template on page 500
How to set the field attributes for a template section	Setting the Field Attributes for a Template Section on page 508
How to edit a customer registration template	Editing a Customer Registration Template on page 513
How to copy a customer registration template	Copying a Customer Registration Template on page 515

Setting the Field Attributes for a Template Section

Prerequisites

To set the field attributes for a template section, you should have:





- Template pages and sections associated with the template category
- Fields for the sections defined in the application

Procedure

To set the field attributes for a template section:

1. Ensure that the **Template Pages** section is expanded when you are defining, editing, or copying a customer registration template.

The **Template Pages** section contains the following fields:

Field Name	Field Description	Mandatory (Yes or No)						
Template Page	Used to indicate the page which you want to add in a customer registration template for a particular template category.	Yes (Conditional) Note: This field is required while adding pages and sections in a customer registration template.						
Template Section	Used to indicate the section and its field attributes which you want to define for a particular page in a customer registration template. Note: On clicking the Add  icon, the following columns appear: <table border="1" data-bbox="625 1186 1112 1659"> <thead> <tr> <th>Column Name</th> <th>Column Description</th> </tr> </thead> <tbody> <tr> <td>Template Section</td> <td>Used to indicate the section for a particular page.</td> </tr> <tr> <td>Field Attributes</td> <td>Used to define the field attributes of a section. Note: On clicking the Add  icon, you can define the field attributes for the section.</td> </tr> </tbody> </table>	Column Name	Column Description	Template Section	Used to indicate the section for a particular page.	Field Attributes	Used to define the field attributes of a section. Note: On clicking the Add  icon, you can define the field attributes for the section.	Yes (Conditional) Note: This field is required while adding pages and sections in a customer registration template.
Column Name	Column Description							
Template Section	Used to indicate the section for a particular page.							
Field Attributes	Used to define the field attributes of a section. Note: On clicking the Add  icon, you can define the field attributes for the section.							

2. Select the template page and template section from the respective columns.
3. Click the **Add**  icon in the **Field Attributes** column corresponding to the template section whose field attributes you want to set.

It contains the following fields in a grid:

Field Name	Field Description	Mandatory (Yes or No)
Sequence	Used to specify the sequence of the field attribute.	Yes (Conditional)
		Note: This field is required while setting the field attributes for a template section.
Field	Used to indicate the field for which you want to set attributes.	Yes (Conditional)
	<p>Note:</p> <p>The Search (🔍) icon appears corresponding to this field. On clicking the Search icon, the Field Search window appears.</p> <p>On specifying the field, the description of the field appears corresponding to the field.</p>	<p>Note: This field is required while setting the field attributes for a template section.</p>
Default Field Value	Used to indicate the default value for the field in the template section.	Yes (Conditional)
	<p>Note:</p> <p>On specifying a field, the Search (🔍) icon appears corresponding to the Default Field Value field. On clicking the Search icon, a window appears depending on the field that you have selected.</p> <p>On specifying the default field value, the description of the default field value appears corresponding to the default field value.</p>	<p>Note: This field is required while setting the field attributes for a template section.</p>
Required	Used to indicate whether the field is mandatory in the template section.	Yes (Conditional)
	<p>Note: By default, the check box in the Required column is disabled. It is enabled when you specify the field in the Field column.</p>	<p>Note: This field is required while setting the field attributes for a template section.</p>
Disable Field Value	Used to indicate whether the field is disabled in the template section.	Yes (Conditional)
	<p>Note: By default, the check box in the Disable Field Value column is disabled. It is enabled when you specify the field in the Field column.</p>	<p>Note: This field is required while setting the field attributes for a template section.</p>

Field Name	Field Description	Mandatory (Yes or No)
Identifier Type	Used to indicate the type of identifier for which you want to set attributes.	Yes (Conditional)
	<p>Note:</p> <p>On specifying a field, the Search (🔍) icon appears corresponding to the Identifier Type field. On clicking the Search icon, the Search Zone for Person Identifier window appears.</p> <p>On specifying the identifier type, the description of the identifier type appears corresponding to the Identifier Type field.</p>	<p>Note: This field is required while setting the field attributes for a template section.</p>
Identifier Value	Used to specify the value for the identifier type for which you want to set attributes.	Yes (Conditional)
	<p>Note: By default, this field is disabled. It is enabled when you specify the identifier type in the Identifier Type column.</p>	<p>Note: This field is required while setting the field attributes for a template section.</p>
Primary ID	Used to indicate whether the identifier type and identifier value are primary or not.	Yes (Conditional)
	<p>Note: By default, the check box in the Primary ID field is disabled. It is enabled when you specify the identifier type in the Identifier Type column.</p>	<p>Note: This field is required while setting the field attributes for a template section.</p>
Disable Identifier Type	Used to indicate whether the identifier type is disabled in the template section.	Yes (Conditional)
	<p>Note: By default, the check box in the Disable Identifier Type column is disabled. It is enabled when you specify the identifier type in the Identifier Type column.</p>	<p>Note: This field is required while setting the field attributes for a template section.</p>
Disable Identifier Value	Used to indicate whether the identifier value is disabled in the template section.	Yes (Conditional)
	<p>Note: By default, the check box in the Disable Identifier Value column is disabled. It is enabled when you specify the identifier value in the Identifier Value column.</p>	<p>Note: This field is required while setting the field attributes for a template section.</p>

Field Name	Field Description	Mandatory (Yes or No)
Name Type	Used to indicate the type of name for which you want to set attributes.	Yes (Conditional)
	<p>Note:</p> <p>On specifying a field, the Search (🔍) icon appears corresponding to the Name Type field. On clicking the Search icon, the Search Zone for Person Name Type window appears.</p> <p>On specifying the name type, the description of the name type appears corresponding to the Name Type field.</p>	<p>Note: This field is required while setting the field attributes for a template section.</p>
Name	Used to specify the name of the person.	Yes (Conditional)
	<p>Note: By default, this field is disabled. It is enabled when you specify the name type in the Name Type column.</p>	<p>Note: This field is required while setting the field attributes for a template section.</p>
Disable Name Type	Used to indicate whether the name type is disabled in the template section.	Yes (Conditional)
	<p>Note: By default, the check box in the Disable Name Type column is disabled. It is enabled only when you specify the name type in the Name Type column.</p>	<p>Note: This field is required while setting the field attributes for a template section.</p>
Disable Name	Used to indicate whether the specified name of the person is disabled in the template section.	Yes (Conditional)
	<p>Note: By default, the check box in the Disable Name column is disabled. It is enabled when you specify the name in the Name column.</p>	<p>Note: This field is required while setting the field attributes for a template section.</p>
Phone Type	Used to specify the type of phone for which you want to set attributes.	Yes (Conditional)
	<p>Note:</p> <p>On specifying a field, the Search (🔍) icon appears corresponding to the Phone Type field. On clicking the Search icon, the Search Zone for Phone Type window appears.</p> <p>On specifying the phone type, the description of the phone type appears corresponding to the Phone Type field.</p>	<p>Note: This field is required while setting the field attributes for a template section.</p>

Field Name	Field Description	Mandatory (Yes or No)
Phone Number	Used to specify the phone number.	Yes (Conditional)
	Note: By default, this field is disabled. It is enabled when you specify the phone type in the Phone Type column.	Note: This field is required while setting the field attributes for a template section.
Disable Phone Type	Used to indicate whether the phone type is disabled in the template section.	Yes (Conditional)
	Note: By default, the check box in the Disable Phone Type column is disabled. It is enabled when you specify the phone type in the Phone Type column.	Note: This field is required while setting the field attributes for a template section.
Disable Phone Number	Used to indicate whether the specified phone number is disabled in the template section.	Yes (Conditional)
	Note: By default, the check box in the Disable Phone Number column is disabled. It is enabled when you specify the phone number in the Phone Number column.	Note: This field is required while setting the field attributes for a template section.
Characteristic Information	Used to indicate the characteristic type and characteristic value for which you want to set attributes.	Yes (Conditional)
	<p>Note:</p> <p>On specifying the characteristic type, the characteristic value field appears in the Characteristic Information column.</p> <p>On specifying a predefined characteristic type, the Search (🔍) icon appears corresponding to the characteristic value field. On clicking the Search icon, the Predefined Characteristic Search window appears.</p> <p>On specifying the value for a predefined characteristic type, the description of the characteristic value appears corresponding to the characteristic value field..</p>	Note: This field is required while setting the field attributes for a template section.
Disable Characteristic Type	Used to indicate whether the characteristic type is disabled in the template section.	Yes (Conditional)
	Note: By default, the check box in the Disable Characteristic Type column is disabled. It is enabled when you specify the characteristic type in the Characteristic Type column.	Note: This field is required while setting the field attributes for a template section.

Field Name	Field Description	Mandatory (Yes or No)
Disable Characteristic Value	Used to indicate whether the characteristic is disabled in the template section.	Yes (Conditional)
	Note: By default, the check box in the Disable Characteristic Value column is disabled. It is enabled when you specify the characteristic value in the Characteristic Value column.	Note: This field is required while setting the field attributes for a template section.

- Enter the required details in the **Template Pages** section.
- If you want to set more than one field attribute for the template section, click the **Add (+)** icon and then repeat step 2.

Note: However, if you want to remove a field attribute from the template section, click the **Delete (🗑)** icon corresponding to the field.

- Click **Save**.

The field attributes are set for the template section.

Related Topics

For more information on...	See...
Customer Registration Template screen	Customer Registration Template on page 495
How to define a customer registration template	Defining a Customer Registration Template on page 500
How to edit a customer registration template	Editing a Customer Registration Template on page 513
How to copy a customer registration template	Copying a Customer Registration Template on page 515

Editing a Customer Registration Template

Prerequisites

To edit a customer registration template, you should have:

- Template categories defined in the application
- Template pages and sections defined in the application

Procedure

To edit a customer registration template:

- Search for the customer registration template in the **Customer Registration Template** screen.
- In the **Search Results** section, click the **Edit (✎)** icon in the **Edit** column corresponding to the customer registration template whose details you want to edit.

The **Customer Registration Template for Banking** or the **Customer Registration Template for Healthcare** screen appears depending upon the business object using which the customer registration template is defined. It contains the following sections:

- **Main** - Used to specify basic details about the customer registration template.
- **Template Pages** - Used to add template pages and its related sections for the customer registration template.
- **Main** - The **Main** section contains the following fields:

Field Name	Field Description	Mandatory (Yes or No)
Template	Displays the customer registration template.	Not applicable
Template Category	Used to indicate the category for which you want to define the customer registration template. The valid values are: <ul style="list-style-type: none"> • Account • Person • Policy • Policy Plan 	Yes
	Note: The Policy and Policy Plan options appear when you are defining a customer registration template using the C1-CustomerRegistrationTmplHC business object.	
Business Object	Indicates the business object using which the customer registration template is defined in the system.	Not applicable
Description	Used to specify the description for the customer registration template.	Yes
Detailed Description	Used to specify additional information about the customer registration template.	No

Tip: Alternatively, you can edit the details of a customer registration template by clicking the **Edit** button in the **Customer Registration Template** zone.

3. Modify the details in the **Main** section, if required.
4. Add, edit, or remove the template pages and template sections from the customer registration template, if required.
5. Add, edit, or remove the field attributes from the template section, if required.
6. Click **Save**.

The changes made to the customer registration template are saved.

Note: You can edit a customer registration template only when a customer registration it is not yet defined using the customer registration template.

Related Topics

For more information on...	See...
Search Customer Registration Template zone	Search Customer Registration Template on page 496
Customer Registration Template screen	Customer Registration Template on page 495
Customer Registration Template zone	Customer Registration Template on page 498
How to add the pages and sections in a customer registration template	Adding the Pages and Sections in a Customer Registration Template on page 502

For more information on...	See...
How to set the field attributes for a template section	Setting the Field Attributes for a Template Section on page 508

Copying a Customer Registration Template

Instead of creating a customer registration template from scratch, you can create a new customer registration template using an existing customer registration template. This is possible through copying a customer registration template. On copying a customer registration template, the details including the template pages, template sections, and field attributes for the template sections are copied to the new customer registration template. You can then edit the details, if required.

Prerequisites

To copy a customer registration template, you should have:

- Customer registration template (whose copy you want to create) defined in the application
- Template categories defined in the application
- Template pages and sections defined in the application

Procedure

To copy a customer registration template:

1. Search for the customer registration template in the **Customer Registration Template** screen.
2. In the **Search Results** section, click the **Duplicate** () icon in the **Duplicate** column corresponding to the customer registration template whose copy you want to create.

The **Customer Registration Template for Banking** or the **Customer Registration Template for Healthcare** screen appears depending upon the business object using which the customer registration template whose copy you want to create is defined. It contains the following sections:

- **Main** - Used to specify basic details about the customer registration template.
- **Template Pages** - Used to add template pages and its related sections for the customer registration template.
- **Main** - The **Main** section contains the following fields:

Field Name	Field Description	Mandatory (Yes or No)
Template	Used to specify the customer registration template.	Yes

Field Name	Field Description	Mandatory (Yes or No)
Template Category	Used to indicate the category for which you want to define the customer registration template. The valid values are: <ul style="list-style-type: none"> • Account • Person • Policy • Policy Plan 	Yes
	Note: The Policy and Policy Plan options appear when you are defining a customer registration template using the CI-CustomerRegistrationTmplHC business object.	
Business Object	Indicates the business object using which the customer registration template is defined in the system.	Not applicable
Description	Used to specify the description for the customer registration template.	Yes
Detailed Description	Used to specify additional information about the customer registration template.	No

Tip: Alternatively, you can copy a customer registration template by clicking the **Duplicate** button in the **Customer Registration Template** zone.

3. Enter the required details in the **Main** section.
4. Add, edit, or remove the template pages and template sections from the customer registration template, if required.
5. Add, edit, or remove the field attributes from the template section, if required.
6. Click **Save**.

The new customer registration template is defined.

Related Topics

For more information on...	See...
Search Customer Registration Template zone	Search Customer Registration Template on page 496
Customer Registration Template screen	Customer Registration Template on page 495
Customer Registration Template zone	Customer Registration Template on page 498
How to add the pages and sections in a customer registration template	Adding the Pages and Sections in a Customer Registration Template on page 502
How to set the field attributes for a template section	Setting the Field Attributes for a Template Section on page 508

Deleting a Customer Registration Template

Procedure

To delete a Customer Registration Template:

1. Search for the customer registration template in the **Customer Registration Template** screen.
2. In the **Search Results** section, click the **Delete** (🗑️) icon in the **Delete** column corresponding to the customer registration template that you want to delete.

A message appears confirming whether you want to delete the customer registration template.

3. Click **OK**.

The customer registration template is deleted.

Note: You can delete a customer registration template when a customer registration is not yet created using the customer registration template.

Tip: Alternatively, you can delete a customer registration template by clicking the **Delete** button in the **Customer Registration Template** zone.

Related Topics

For more information on...	See...
Customer Registration Template screen	Customer Registration Template on page 495
Search Customer Registration Template zone	Search Customer Registration Template on page 496
Customer Registration Template zone	Customer Registration Template on page 498

Customer Registration Type

A customer registration type encapsulates the following information:



- Users with a particular access group can only create a customer registration object using the customer registration type
- Whether the customer registration type can be used to create a customer registration object from the user interface, through the inbound message, or through the **File Upload Interface** utility
- Whether the approval is required when you create, edit, or delete a customer registration object
- Whether the final level approval is required once the approver at the first level approves the customer registration object
- Whether a To Do should be created indicating that the users have to manually create the billing hierarchy and pricing for the parent customer.
- The business objects using which the person, account, policy plan, membership, and address should be created when a customer registration object is created using the customer registration type
- A customer registration template which indicates the pages and sections that should appear when you are creating a customer registration object using the customer registration type. You can specify one customer registration template for person and one or more customer registration templates for account, policy, and policy plan.
- Information, such as person names, person identifiers, person phones, person characteristics, person addresses, person hierarchy, accounts, account identifiers, account characteristics, account auto pay information, account persons, account bill routing information, policies, policy plans, policy characteristics, or policy plan characteristics, which should be copied when you create a copy of a customer registration object which is created using the customer registration type.

Related Topics

For more information on...	See...
Customer Registration Type List zone	Customer Registration Type List on page 518
Customer Registration Type zone	Customer Registration Type on page 519
How to search for a customer registration type	Searching for a Customer Registration Type on page 525
How to view the details of a customer registration type	Viewing the Customer Registration Type Details on page 545
How to define a customer registration type	Defining a Customer Registration Type on page 526
How to edit a customer registration type	Editing a Customer Registration Type on page 539
How to copy a customer registration type	Copying a Customer Registration Type on page 542
How to delete a customer registration type	Deleting a Customer Registration Type on page 544

Customer Registration Type List

The **Customer Registration Type List** zone lists the customer registration types that are already defined in the system. It contains the following columns:

Column Name	Column Description
Customer Registration Type	Displays the customer registration type.
Description	Displays the description of the customer registration type.
Edit	On clicking the Edit () icon, the Customer Registration Type screen appears where you can edit the details of the customer registration type.
Duplicate	On clicking the Duplicate () icon, the Customer Registration Type screen appears where you can define a new customer registration type using an existing customer registration type.
Delete	On clicking the Delete () icon, you can delete the customer registration type.
	Note: You can delete a customer registration type when a customer registration is not yet defined using the customer registration type.

You can filter the list using various search criteria (such as, **Customer Registration Type** and **Description**) available in the **Filter** area. By default, the **Filter** area is hidden. You can view the **Filter** area by clicking the **Filters** () icon in the upper right corner of this zone.

On clicking the **Broadcast** () icon corresponding to a customer registration type, the **Customer Registration Type** zone appears with the details of the respective customer registration type.

Note: Pagination is used to display limited number of records in this zone. You can use the navigation links, such as **Previous** and **Next** to navigate between pages.

Related Topics

For more information on...	See...
How to view the details of a customer registration type	Viewing the Customer Registration Type Details on page 545
How to edit a customer registration type	Editing a Customer Registration Type on page 539

For more information on...	See...
How to copy a customer registration type	Copying a Customer Registration Type on page 542
How to delete a customer registration type	Deleting a Customer Registration Type on page 544

Customer Registration Type

The **Customer Registration Type** zone displays the details of the customer registration type. It contains the following sections:

- **Main** - Displays the basic information about the customer registration type. It contains the following fields:

Field Name	Field Description
Customer Registration Type	Displays the customer registration type.
Description	Displays the description of the customer registration type.
Customer Registration Business Object	<p>Indicates the business object using which the customer registration is created in the system. In addition, a context menu appears corresponding to this field which helps in navigating to other screens in the application. The valid values are:</p> <ul style="list-style-type: none"> • Customer Registration - Banking - Indicates customer registration is created using the C1-CustomerRegistrationBanking business object. • Customer Registration - Health Care - Indicates customer registration is created using the C1-CustomerRegistrationHC business object. <p>Note: It has a link. On clicking the link, the Business Object screen appears where you can view the details of the respective business object.</p>
Detailed Description	Displays additional information about the customer registration type.
Status	<p>Indicates the status of the customer registration type. The valid values are:</p> <ul style="list-style-type: none"> • Active • Inactive <p>Note: You cannot change the status of a customer registration type to Inactive when the corresponding customer registration is in a status other than Processed or Rejected.</p>
Access Group	<p>Displays the user group that can access the customer registration created using the customer registration type.</p> <p>Note: It has a link. On clicking the link, the Access Group screen appears where you can view the details of the respective access group.</p>
Registration Source	<p>Indicates the source through which the customer registration is created using the customer registration type. The valid values are:</p> <ul style="list-style-type: none"> • File Upload • Inbound Message • Manual

- **Additional Data** - Displays additional information about the customer registration type. It contains the following fields:

Field Name	Field Description
Approval Required	Indicates whether approval is required while creating the customer registration using the customer registration type.
Approval To Do Type	Indicates that the To Do entry of the specified To Do type is created when you submit the customer registration for approval.
	<p>Note:</p> <p>This field appears when the Approval Required check box is selected.</p> <p>It has a link. On clicking the link, the To Do Type screen appears with the details of the respective To Do type.</p>
Approval To Do Role	Indicates that users with the specified To Do role can only approve, reject, or resubmit the customer registration for approval.
	<p>Note:</p> <p>This field appears when the Approval Required check box is selected.</p> <p>It has a link. On clicking the link, the To Do Role screen appears with the details of the respective To Do role.</p>
Submitter To Do Type	Indicates the To Do entry of the specified To Do type is created when the customer registration is resubmitted by the approver.
	<p>Note:</p> <p>It has a link. On clicking the link, the To Do Type screen appears where you can view the details of the respective To Do type.</p>
Submitter To Do Role	Indicates the users with the specified To Do role for whom the To Do task is created when the customer registration is resubmitted by the approver.
	<p>Note:</p> <p>It has a link. On clicking the link, the To Do Role screen appears where you can view the details of the respective To Do role.</p>
Final Approval Required	Indicates whether the final approval is required once the approver at the first level approves the customer registration.
	<p>Note:</p> <p>This field appears when the Customer Registration Type is created using the C1-CustRegTypeHealthCare business object.</p> <p>The final approval is required when the Manual Billing Hierarchy and Pricing option check box is selected.</p>

Field Name	Field Description
Final Approval To Do Type	<p data-bbox="630 212 1468 275">Indicates that the To Do entry of the specified To Do type is created when you submit the customer registration for final approval.</p> <p data-bbox="630 296 1468 478">Note: It has a link. On clicking the link, the To Do Type screen appears with the details of the respective To Do type. This field appears when the Final Approval Required check box is selected.</p>
Final Approval To Do Role	<p data-bbox="630 510 1468 573">Indicates that users with the specified To Do role can only approve or resubmit the customer registration for final approval.</p> <p data-bbox="630 594 1468 777">Note: It has a link. On clicking the link, the To Do Role screen appears where you can view the details of the respective To Do role. This field appears when the Final Approval Required check box is selected.</p>
Manual Billing Hierarchy and Pricing	<p data-bbox="630 810 1468 947">Indicates whether the required bill groups for the parent customer, the bill group's accounts, pricing rules, bill group sorting information, and bill group derivation and pricing parameters are created manually by the user while defining the customer registration.</p> <p data-bbox="630 968 1468 1188">Note: This field appears when the Customer Registration Type is created using the C1-CustRegTypeHealthCare business object. This feature is used only for customer registration objects where the person type is set to Parent Customer.</p>
Billing Hierarchy and Pricing To Do Type	<p data-bbox="630 1209 1468 1272">Indicates the To Do entry of the specified To Do type is created for the user to define or edit the billing hierarchy and pricing for the parent customer manually.</p> <p data-bbox="630 1293 1468 1514">Note: It has a link. On clicking the link, the To Do Type screen appears with the details of the respective To Do type. This field appears when the Manual Billing Hierarchy and Pricing check box is selected.</p>
Billing Hierarchy and Pricing To Do Role	<p data-bbox="630 1545 1468 1608">Indicates users with the specified To Do role can only define or edit the billing hierarchy and pricing for the parent customer manually.</p> <p data-bbox="630 1629 1468 1829">Note: It has a link. On clicking the link, the To Do Role screen appears where you can view the details of the respective To Do role. This field appears when the Manual Billing Hierarchy and Pricing check box is selected.</p>

Field Name	Field Description
Person Business Object	Indicates the business object using which the person is created while defining the customer registration.
	Note: It has a link. On clicking the link, the Business Object screen appears where you can view the details of the respective business object.
Account Business Object	Indicates the business object using which the account is created while defining the customer registration.
	Note: It has a link. On clicking the link, the Business Object screen appears where you can view the details of the respective business object.
Policy Plan Business Object	Indicates the business object using which the policy plan is created while defining the customer registration.
	Note: It has a link. On clicking the link, the Business Object screen appears where you can view the details of the respective business object. This field appears when the Customer Registration Type is created using the C1-CustRegTypeHealthCare business object.
Benefits Business Object	Indicates the business object using which the benefit is created while defining the customer registration.
	Note: It has a link. On clicking the link, the Business Object screen appears where you can view the details of the respective business object.
Membership Business Object	Indicates the business object using which the membership is created while defining the customer registration.
	Note: It has a link. On clicking the link, the Business Object screen appears where you can view the details of the respective business object. This field appears when the Customer Registration Type is created using the C1-CustRegTypeHealthCare business object.
Address Business Object	Indicates the business object using which the address is created while defining the customer registration.
	Note: It has a link. On clicking the link, the Business Object screen appears where you can view the details of the respective business object.
Statement Construct Business Object	Indicates the business object using which the statement construct is created while defining the customer registration.
	Note: It has a link. On clicking the link, the Business Object screen appears where you can view the details of the respective business object.

- **Characteristics** - Lists the characteristics defined for the customer registration type. It contains the following columns:

Column Name	Column Description
Characteristic Type	Indicates the characteristic type.
Characteristic Value	Displays the value of the characteristic type.

- **Customer Registration Templates** - Lists the templates that are associated with the customer registration type for creating a customer registration. It contains the following columns:

Column Name	Column Description
Sequence	Displays the sequence of the customer registration template.
Template Category	Indicates the category to which the customer registration template belongs. The valid values are: <ul style="list-style-type: none"> • Person • Account • Policy • Policy Plan <p>Note: The Policy and Policy Plan template categories appear when the Customer Registration Type is created using the C1-CustRegTypeHealthCare business object.</p>
Template	Displays the customer registration template associated with the customer registration type. <p>Note: It has a link. On clicking the link, the Customer Registration Template screen appears where you can view the details of the respective customer registration template.</p>

- **Record Actions** - The **Record Actions** section contains the following buttons:

Button Name	Button Description
Edit	Used to edit the details of the customer registration type.
Delete	Used to delete the customer registration type. <p>Note: You can delete a customer registration type when a customer registration is not yet defined using the customer registration type.</p>
Duplicate	Used to create a new customer registration type using an existing customer registration type.

- **Record Information** - The **Record Information** section contains the following field:

Field Name	Field Description
Business Object	Indicates the business object using which the customer registration type is created in the system. In addition, a context menu appears corresponding to this field which helps in navigating to other screens in the application. <p>Note: It has a link. On clicking the link, the Business Object screen appears where you can view the details of the respective business object.</p>

- **Copy Customer Registration Details** - Enables you to specify the type of information you want to copy while defining a customer registration using an existing customer registration. It contains the following fields:

Column Name	Column Description
Person Names	Indicates whether you want to copy the person details while copying a customer registration.
Accounts	Indicates whether you want to copy the account details while copying a customer registration.
Person Identifiers	Indicates whether you want to copy the person identifier details while copying a customer registration.
Account Identifiers	Indicates whether you want to copy the account identifier details while copying a customer registration.
Person Phones	Indicates whether you want to copy the phone details of the person while copying a customer registration.
Account Characteristics	Indicates whether you want to copy the characteristic details of the account while copying a customer registration.
Person Characteristics	Indicates whether you want to copy the characteristic details of the person while copying a customer registration.
Account Auto Pay Information	Indicates whether you want to copy the automatic payment details of the account while copying a customer registration.
Person Addresses	Indicates whether you want to copy the address details of the person while copying a customer registration.
Account Persons	Indicates whether you want to copy the details of the persons related to the account while copying a customer registration.
Person Hierarchy	Indicates whether you want to copy the person hierarchy details while copying a customer registration.
Account Override Address	Indicates whether you want to copy the account override address details while copying a customer registration.
Bill Routing Information	Indicates whether you want to copy the bill routing details of the account while copying a customer registration.
Credit Rating History	Indicates whether you want to copy the credit rating history details while copying a customer registration.
Policies	Indicates whether you want to copy the policy details while copying a customer registration. Note: This field appears when the Customer Registration Type is created using the C1-CustRegTypeHealthCare business object.
Policy Plans	Indicates whether you want to copy the policy plan details while copying a customer registration. Note: This field appears only when the Customer Registration Type is created using the C1-CustRegTypeHealthCare business object.

Column Name	Column Description
Policy Characteristics	Indicates whether you want to copy the policy characteristic details while copying a customer registration.
	Note: This field appears when the Customer Registration Type is created using the C1-CustRegTypeHealthCare business object.
Policy Plan Characteristics	Indicates whether you want to copy the policy plan characteristic details while copying a customer registration.
	Note: This field appears when the Customer Registration Type is created using the C1-CustRegTypeHealthCare business object.

By default, the **Customer Registration Type** zone does not appear in the **Customer Registration Type** screen. It appears when you click the **Broadcast** (📡) icon corresponding to a customer registration type in the **Customer Registration Type List** zone.

Related Topics

For more information on...	See...
How to define a customer registration type	Defining a Customer Registration Type on page 526
How to edit a customer registration type	Editing a Customer Registration Type on page 539
How to copy a customer registration type	Copying a Customer Registration Type on page 542
How to delete a customer registration type	Deleting a Customer Registration Type on page 544
How to view the details of a customer registration type	Viewing the Customer Registration Type Details on page 545

Searching for a Customer Registration Type

Prerequisites

To search for a customer registration type, you should have:

- Customer registration types defined in the application

Procedure

To search for a customer registration type:

1. Click the **Admin** link in the **Application** toolbar.
A list appears.
2. From the **Admin** menu, select **C** and then click **Customer Registration Type**.
A sub-menu appears.
3. Click the **Search** option from the **Customer Registration Type** sub-menu.

The **Customer Registration Type** screen appears with a list of customer registration types in the **Customer Registration Type List** zone.

4. Click the **Filters** (🔍) icon in the title bar of the **Customer Registration Type List** zone.

It contains the following fields:

Field Name	Field Description	Mandatory (Yes or No)
Customer Registration Type	Used to search for a particular customer registration type.	No
Description	Used to search for customer registration types having a particular description.	No

- Enter the search criteria in the **Customer Registration Type List** zone.

Note: ORMB search engine supports wildcard search, where you can substitute the percentage (%) symbol as a stand in for any word or letter in a search criteria. You can use the ‘%’ wildcard character in all input fields except the date and ID fields. The ‘%’ wildcard character is suffixed automatically at the end of the partial search criteria. Therefore, you may or may not specify the wildcard character at the end of the partial search criteria. However, you have to prefix the wildcard character manually wherever required.

- Click **Search**.

A list of customer registration types that meet the search criteria appears in the **Search Results** section.

Related Topics

For more information on...	See...
Customer Registration Type screen	Customer Registration Type on page 517
Customer Registration Type zone	Customer Registration Type on page 519

Defining a Customer Registration Type

Prerequisites

To define a customer registration type, you should have:

- Customer registration type business objects defined in the application
- Customer registration business objects defined in the application
- Access groups defined in the application
- Registration sources defined in the application
- Statement construct business object defined in the application
- Benefit business object defined in the application
- Person, account, policy plan, membership, and address business objects defined in the application

Note: The policy plan and membership business objects are required when you are defining a customer registration type using the **C1-CustRegTypeHealthCare** business object.

- Approval To Do types and To Do roles defined in the application
- Billing hierarchy and pricing To Do types and To Do roles defined in the application

Note: The billing hierarchy and pricing To Do types and To Do roles are required when you are defining a customer registration type using the **C1-CustRegTypeHealthCare** business object.

- Characteristic types defined in the application
- Template categories defined in the application

Procedure

To define a customer registration type:

1. Click the **Admin** link in the **Application** toolbar.
A list appears.
2. From the **Admin** menu, select **C** and then click **Customer Registration Type**.
A sub-menu appears.
3. Click the **Add** option from the **Customer Registration Type** sub-menu.

The **Select Business Object** screen appears. It contains the following field:

Field Name	Field Description	Mandatory (Yes or No)
Customer Registration Type Business Object	Used to indicate the business object using which you want to create the customer registration type. The valid values are: <ul style="list-style-type: none"> • Customer Registration Type - Banking • Customer Registration Type - Healthcare 	Yes

Tip: Alternatively, you can access the **Select Business Object** screen by clicking the **Add** button in the **Page Title** area of the **Customer Registration Type** screen.

Note: The **Select Business Object** screen appears when there are multiple customer registration type business objects defined in the application. If there is only one customer registration type business object defined in the application, the **Customer Registration Type** screen appears.

4. Select the required customer registration business object from the respective field.
5. Click **OK**.

The **Customer Registration Type** screen appears. It contains the following sections:

- **Main** - Used to specify basic details about the customer registration type.
- **Additional Data** - Used to define additional information about the customer registration type.
- **Characteristics** - Used to define a list characteristics for the customer registration type.
- **Customer Registration Templates** - Used to associate templates with the customer registration type.
- **Copy Customer Registration Details** - Used to specify the type of information you want to copy while defining a customer registration using an existing customer registration.
- **Main** - The **Main** section contains the following fields:

Field Name	Field Description	Mandatory (Yes or No)
Customer Registration Type	Used to specify the customer registration type.	Yes
Business Object	Indicates the business object using which you want to create the customer registration type.	Not applicable
Description	Used to specify the description for the customer registration type.	Yes

Field Name	Field Description	Mandatory (Yes or No)
Customer Registration Business Object	Used to indicate the business object using which you want to create the customer registration in the system.	Yes
Detailed Description	Used to specify additional information about the customer registration type.	No
Status	Used to indicate the status of the customer registration type. <ul style="list-style-type: none"> Active Inactive 	Yes
Access Group	Used to specify the user group that can access the customer registration created using the customer registration type.	Yes
	<p>Note:</p> <p>The Search (🔍) icon appears corresponding to the Access Group field. On clicking the Search icon, the Access Group Search window appears.</p> <p>On specifying the access group, the description of the access group appears corresponding to the Access Group field.</p>	
Registration Source	Used to indicate the source through which you want to create the customer registration in the system. The valid values are: <ul style="list-style-type: none"> File Upload Inbound Message Manual 	Yes

- Enter the required details in the **Main** section.
- Define additional information about the customer registration type in the **Additional Data** section.
- Define a list of characteristics for the customer registration type in the **Characteristics** section.
- Associate customer registration templates with the customer registration type in the **Customer Registration Templates** section
- Specify the type of information you want to copy while defining a customer registration using an existing customer registration in the **Copy Customer Registration Details** section.
- Click **Save**.

The customer registration type is defined.

Related Topics

For more information on...	See...
Customer Registration Type screen	Customer Registration Type on page 517

For more information on...	See...
How to define additional data for a customer registration type	Defining Additional Data for a Customer Registration Type on page 529
How to define a characteristic for a customer registration type	Defining a Characteristic for a Customer Registration Type on page 533
How to associate a customer registration template with a customer registration type	Associating a Customer Registration Template with a Customer Registration Type on page 534
How to set an attribute to define a customer registration using the existing customer registration	Setting Attributes to Define a Customer Registration Using the Existing Customer Registration on page 536

Defining Additional Data for a Customer Registration Type

Prerequisites

To define additional data for a customer registration type, you should have:

- Person, account, policy plan, membership, and address business objects defined in the application

Note: The policy plan and membership business objects are required when you are defining, editing, or copying a customer registration type which is created using the **C1-CustRegTypeHealthCare** business object.

- Approval To Do types and To Do roles defined in the application
- Billing hierarchy and pricing To Do types and To Do roles defined in the application

Note: The billing hierarchy and pricing To Do types and To Do roles are required when you are defining, editing, or copying a customer registration type which is created using the **C1-CustRegTypeHealthCare** business object.

Procedure

To define additional data for a customer registration type:

1. Ensure that the **Additional Data** section is expanded when you are defining, editing, or copying a customer registration type.

The **Additional Data** section contains the following fields:

Field Name	Field Description	Mandatory (Yes or No)
Approval Required	Used to indicate whether approval is required while creating the customer registration using the customer registration type.	Yes (Conditional)
		Note: This field is required for approving the customer registration which is created using the customer registration type.

Field Name	Field Description	Mandatory (Yes or No)
Approval To Do Type	Used to indicate the To Do entry of the specified To Do type is created when you submit the customer registration for approval.	Yes (Conditional)
	<p>Note:</p> <p>The Search (🔍) icon appears corresponding to the Approval To Do Type field. On clicking the Search icon, the To Do Type Search window appears.</p> <p>On specifying the To Do type, the description of the To Do type appears corresponding to the Approval To Do Type field.</p> <p>This field appears when the Approval Required check box is selected.</p>	<p>Note: This field is required for approving the customer registration which is created using the customer registration type.</p>
Approval To Do Role	Used to indicate the users with the specified To Do role can approve, reject, or resubmit the customer registration for approval.	Yes (Conditional)
	<p>Note:</p> <p>This field appears when the Approval Required check box is selected.</p>	<p>Note: This field is required for approving the customer registration which is created using the customer registration type.</p>
Submitter To Do Type	Used to indicate the To Do entry of the specified To Do type is created when the customer registration is resubmitted by the approver.	Yes (Conditional)
	<p>Note:</p> <p>The Search (🔍) icon appears corresponding to the Submitter To Do Type field. On clicking the Search icon, the To Do Type Search window appears.</p> <p>On specifying the To Do type, the description of the To Do type appears corresponding to the Submitter To Do Type field.</p>	<p>Note: This field is required for resubmitting the customer registration for approval.</p>
Submitter To Do Role	Used to indicate the users with the specified To Do role for whom the To Do task is created when the customer registration is resubmitted by the approver.	Yes (Conditional)
		<p>Note: This field is required for resubmitting the customer registration for approval.</p>

Field Name	Field Description	Mandatory (Yes or No)
Final Approval Required	Used to indicate whether final approval is required once the approver at the first level approves the customer registration.	Yes (Conditional)
	<p>Note:</p> <p>This field appears when you are defining, editing, or copying a Customer Registration Type using the C1-CustRegTypeHealthCare business object.</p> <p>The final approval is required when the Manual Billing Hierarchy and Pricing option check box is selected.</p>	<p>Note: This field is required for approving the customer registration which is created using the customer registration type.</p>
Final Approval To Do Type	Used to indicate the To Do entry of the specified To Do type is created when you submit the customer registration for final approval.	Yes (Conditional)
	<p>Note:</p> <p>The Search (🔍) icon appears corresponding to the Final Approval To Do Type field. On clicking the Search icon, the To Do Type Search window appears.</p> <p>On specifying the To Do type, the description of the To Do type appears corresponding to the Final Approval To Do Type field.</p> <p>This field appears when the Final Approval Required check box is selected.</p>	<p>Note: This field is required for final approval of the customer registration.</p>
Final Approval To Do Role	Used to indicate the users with the specified To Do role can only approve or resubmit the customer registration for final approval.	Yes (Conditional)
	<p>Note: This field appears when the Final Approval Required check box is selected.</p>	<p>Note: This field is required for final approval of the customer registration.</p>
Manual Billing Hierarchy and Pricing	Used to indicate whether the required bill groups for the parent customer, the bill group's accounts, pricing rules, bill group sorting information, and bill group derivation and pricing parameters are created manually by the user while defining the customer registration.	Yes (Conditional)
	<p>Note:</p> <p>The Manual Billing Hierarchy and Pricing option can be used only for customer registrations where the person type is set to Parent Customer.</p> <p>This field appears when you are defining, editing, or copying a Customer Registration Type using the C1-CustRegTypeHealthCare business object.</p>	<p>Note: This field is required for creating the billing hierarchy and pricing for the parent customer manually.</p>

Field Name	Field Description	Mandatory (Yes or No)
Billing Hierarchy and Pricing To Do Type	Used to indicate the To Do entry of the specified To Do type is created for the user to define or edit the billing hierarchy and pricing for the parent customer manually.	Yes (Conditional)
	<p>Note:</p> <p>The Search (🔍) icon appears corresponding to the Billing Hierarchy and Pricing To Do Type field. On clicking the Search icon, the To Do Type Search window appears.</p> <p>On specifying the To Do type, the description of the To Do type appears corresponding to the Billing Hierarchy and Pricing To Do Type field.</p> <p>This field appears when the Manual Billing Hierarchy and Pricing check box is selected.</p>	<p>Note: This field is required for creating the billing hierarchy and pricing for the parent customer manually.</p>
Billing Hierarchy and Pricing To Do Role	Used to indicate the users with the specified To Do role can only define or edit the billing hierarchy and pricing for the parent customer manually.	Yes (Conditional)
	<p>Note: This field appears when the Manual Billing Hierarchy and Pricing check box is selected.</p>	<p>Note: This field is required for creating the billing hierarchy and pricing for the parent customer manually.</p>
Person Business Object	Used to indicate the business object using which the customer registration for a person is created using the customer registration type.	Yes
Account Business Object	Used to indicate the business object using which the customer registration for an account is created using the customer registration type.	Yes
Policy Plan Business Object	Used to indicate the business object using which the customer registration for a policy plan is created using the customer registration type.	Yes
	<p>Note: This field appears when you are defining, editing, or copying a Customer Registration Type using the C1-CustRegTypeHealthCare business object.</p>	

Field Name	Field Description	Mandatory (Yes or No)
Membership Business Object	Used to indicate the business object using which the customer registration for a membership is created using the customer registration type. Note: The Membership Business Object is required for creating customer registrations through an Inbound Message . This field appears when you are defining, editing, or copying a Customer Registration Type using the C1-CustRegTypeHealthCare business object.	Yes
Benefits Business Object	Used to indicate the business object using which the customer registration for a benefit is created using the customer registration type.	No
Address Business Object	Used to indicate the business object using which the customer registration for an address is created using the customer registration type.	Yes
Statement Construct Business Object	Used to indicate the business object using which the customer registration for a statement construct is created using the customer registration type.	Yes

- Enter the required details in the **Additional Data** section.
- Click **Save**.

The additional data for the customer registration type is defined.

Related Topics

For more information on...	See...
How to define a customer registration type	Defining a Customer Registration Type on page 526
How to edit a customer registration type	Editing a Customer Registration Type on page 539
How to copy a customer registration type	Copying a Customer Registration Type on page 542

Defining a Characteristic for a Customer Registration Type

Prerequisites

To define a characteristic for a customer registration type, you should have:

- Characteristic types defined in the application (where the characteristic entity is set to **Customer Registration Type**)

Procedure

To define a characteristic for a customer registration type:

- Ensure that the **Characteristics** section is expanded when you are defining, editing, or copying a customer registration type.

The **Characteristics** section contains the following fields:

Field Name	Field Description	Mandatory (Yes or No)
Characteristic Type	Used to indicate the characteristic type.	Yes (Conditional)
	Note: The list includes only those characteristic types where the characteristic entity is set to Customer Registration Type .	Note: This field is required when you are defining a characteristic for the customer registration type.
Characteristic Value	Used to specify the value for the characteristic type.	Yes (Conditional)
	Note: If you select a predefined characteristic type, the Search (🔍) icon appears corresponding to the Characteristic Value field. On clicking the Search icon, the Predefined Characteristic Search window appears. On specifying the value for a predefined characteristic type, the description of the characteristic value appears corresponding to the Characteristic Value field.	Note: This field is required when you are defining a characteristic for the customer registration type.

- Enter the required details in the **Characteristics** section.
- If you want to define more than one characteristic for the customer registration type, click the **Add** (+) icon and then repeat step 2.

Note: However, if you want to remove a characteristic from the customer registration type, click the **Delete** (🗑️) icon corresponding to the characteristic.

- Click **Save**.

The characteristic is defined for the customer registration type.

Related Topics

For more information on...	See...
How to define a customer registration type	Defining a Customer Registration Type on page 526
How to edit a customer registration type	Editing a Customer Registration Type on page 539
How to copy a customer registration type	Copying a Customer Registration Type on page 542

Associating a Customer Registration Template with a Customer Registration Type

Prerequisites

To associate a customer registration template with a customer registration type, you should have:

- Template categories defined in the application
- Customer registration templates associated to the template categories

Procedure

To associate a customer registration template with a customer registration type:

1. Ensure that the **Customer Registration Templates** section is expanded when you are defining, editing, or copying a customer registration type.

The **Customer Registration Templates** section contains the following fields:

Field Name	Field Description	Mandatory (Yes or No)
Sequence	Used to specify the sequence for the customer registration template.	Yes (Conditional) Note: This field is required when you are associating a customer registration template with a customer registration type.
Template Category	Used to indicate the category to which the customer registration template belongs. The valid values are: <ul style="list-style-type: none"> • Person • Account • Policy • Policy Plan Note: The Policy and Policy Plan template categories appear when you are defining, editing, or copying a Customer Registration Type using the C1-CustRegTypeHealthCare business object. You can associate only one person template category and multiple account, policy, and policy plan template categories with the customer registration type.	Yes (Conditional) Note: This field is required when you are associating a customer registration template with a customer registration type.
Template	Used to specify the customer registration template which you want to associate with the customer registration type. Note: The Search (🔍) icon appears corresponding to the Template field. On clicking the Search icon, the Customer Registration Template Search window appears. On specifying the template, the description of the template appears corresponding to the Template field.	Yes (Conditional) Note: This field is required when you are associating a customer registration template with a customer registration type.

2. Enter the required details in the **Customer Registration Templates** section.
3. If you want to define more than one template for the customer registration type, click the **Add** (+) icon and then repeat step 2.

Note: However, if you want to remove a template from the customer registration type, click the **Delete** (🗑️) icon corresponding to the customer registration template.

4. Click **Save**.

The customer registration template is associated with the customer registration type.

Related Topics

For more information on...	See...
How to define a customer registration type	Defining a Customer Registration Type on page 526
How to edit a customer registration type	Editing a Customer Registration Type on page 539
How to copy a customer registration type	Copying a Customer Registration Type on page 542

Setting Attributes to Define a Customer Registration Using the Existing Customer Registration

Prerequisites

To set an attribute for defining a customer registration using the existing customer registration, you should have:

- **Person** attributes defined in the application
- **Account** attributes defined in the application
- **Policy** attributes defined in the application

Note: The **Policy** attributes are required when you are defining a customer registration type using the **C1-CustRegTypeHealthCare** business object.

- **Policy Plan** attributes defined in the application

Note: The **Policy Plan** attributes are required when you are defining a customer registration type using the **C1-CustRegTypeHealthCare** business object.

Procedure

To set an attribute for defining a customer registration using the existing customer registration:

1. Ensure that the **Copy Customer Registration Details** section is expanded when you are defining, editing, or copying a customer registration type.

The **Copy Customer Registration Details** section contains the following fields:

Field Name	Field Description	Mandatory (Yes or No)
Person Names	Used to indicate whether you want to copy the person details while copying a customer registration.	No
Accounts	Used to indicate whether you want to copy the account details while copying a customer registration.	No
Person Identifiers	Used to indicate whether you want to copy the person identifier details while copying a customer registration.	No

Field Name	Field Description	Mandatory (Yes or No)
Account Identifiers	Used to indicate whether you want to copy the account identifier details while copying a customer registration.	No
	Note: The check box of this field is enabled when the Accounts check box is selected in the Copy Customer Registration Details section.	
Person Phones	Used to indicate whether you want to copy the phone details of the person while copying a customer registration.	No
Account Characteristics	Used to indicate whether you want to copy the characteristic details of the account while copying a customer registration.	No
	Note: The check box of this field is enabled when the Accounts check box is selected in the Copy Customer Registration Details section.	
Person Characteristics	Used to indicate whether you want to copy the characteristic details of the person while copying a customer registration.	No
Account Auto pay Information	Used to indicate whether you want to copy the automatic payment details of the account while copying a customer registration.	No
	Note: The check box of this field is enabled when the Accounts check box is selected in the Copy Customer Registration Details section.	
Person Addresses	Used to indicate whether you want to copy the address details of the person while copying a customer registration.	No
Account Persons	Used to indicate whether you want to copy the details of the persons related to the account while copying a customer registration.	No
	Note: The check box of this field is enabled when the Accounts check box is selected in the Copy Customer Registration Details section.	
Person Hierarchy	Used to indicate whether you want to copy the person hierarchy details while copying a customer registration.	No

Field Name	Field Description	Mandatory (Yes or No)
Account Override Address	Used to indicate whether you want to copy the account override address details while copying a customer registration.	No
	Note: The check box of this field is enabled when the Accounts check box is selected in the Copy Customer Registration Details section.	
Bill Routing Information	Used to indicate whether you want to copy the bill routing details of the account while copying a customer registration.	No
	Note: The check box of this field is enabled when the Accounts check box is selected in the Copy Customer Registration Details section.	
Credit Rating History	Used to indicate whether you want to copy the credit rating history details while copying a customer registration.	No
	Note: The check box of this field is enabled when the Accounts check box is selected in the Copy Customer Registration Details section.	
Policies	Used to indicate whether you want to copy the policy details while copying a customer registration.	No
	Note: This field appears only when you are defining, editing, or copying a Customer Registration Type using the C1-CustRegTypeHealthCare business object.	
Policy Plans	Used to indicate whether you want to copy the policy plan details while copying a customer registration.	No
	Note: This field appears when you are defining, editing, or copying a Customer Registration Type using the C1-CustRegTypeHealthCare business object. The check box of this field is enabled only when the Policies check box is selected in the Copy Customer Registration Details section.	

Field Name	Field Description	Mandatory (Yes or No)
Policy Characteristics	Used to indicate whether you want to copy the policy characteristic details while copying a customer registration.	No
	<p>Note:</p> <p>This field appears when you are defining, editing, or copying a Customer Registration Type using the C1-CustRegTypeHealthCare business object.</p> <p>The check box of this field is enabled only when the Policies check box is selected in the Copy Customer Registration Details section.</p>	
Policy Plan Characteristics	Used to indicate whether you want to copy the policy plan characteristic details while copying a customer registration.	No
	<p>Note:</p> <p>This field appears when you are defining, editing, or copying a Customer Registration Type using the C1-CustRegTypeHealthCare business object.</p> <p>The check box of this field is enabled when the Policy Plans check box is selected in the Copy Customer Registration Details section.</p>	

2. Select the required attributes in the **Copy Customer Registration Details** section.
3. Click **Save**.

The attributes are set for defining a customer registration using the existing customer registration.

Related Topics

For more information on...	See...
How to define a customer registration type	Defining a Customer Registration Type on page 526
How to edit a customer registration type	Editing a Customer Registration Type on page 539
How to copy a customer registration type	Copying a Customer Registration Type on page 542

Editing a Customer Registration Type

Prerequisites

To edit a customer registration type, you should have:

- Customer registration business objects defined in the application
- Access groups defined in the application
- Registration sources defined in the application

- Statement construct business object defined in the application
- Benefit business object defined in the application
- Person, account, policy plan, membership, and address business objects defined in the application

Note: The policy plan and membership business objects are required when you are editing a customer registration type which is created using the **C1-CustRegTypeHealthCare** business object.

- Approval To Do types and To Do roles defined in the application
- Billing hierarchy and pricing To Do types and To Do roles defined in the application

Note: The billing hierarchy and pricing To Do types and To Do roles are required when you are editing a customer registration type which is created using the **C1-CustRegTypeHealthCare** business object.

- Characteristic types defined in the application
- Template categories defined in the application

Procedure

To edit a customer registration type:

1. Search for the customer registration type in the **Customer Registration Type List** zone of the **Customer Registration Type** screen.
2. In the **Search Results** section, click the **Edit** (✎) icon in the **Edit** column corresponding to the customer registration type whose details you want to edit.

The **Customer Registration Type** screen appears. It contains the following sections:

- **Main** - Used to specify basic details about the customer registration type.
- **Additional Data** - Used to define additional information about the customer registration type.
- **Characteristics** - Used to define a list characteristics for the customer registration type.
- **Customer Registration Templates** - Used to associate templates with the customer registration type.
- **Copy Customer Registration Details** - Used to specify the type of information you want to copy while defining a customer registration using an existing customer registration.
- **Main** - The **Main** section contains the following fields:

Field Name	Field Description	Mandatory (Yes or No)
Customer Registration Type	Displays the customer registration type.	Not applicable
Business Object	Indicates the business object using which the customer registration type is created in the system.	Not applicable
Description	Used to specify the description for the customer registration type.	Yes
Customer Registration Business Object	Used to indicate the business object using which you want to create the customer registration in the system.	Yes
Detailed Description	Used to specify additional information about the customer registration type.	No

Field Name	Field Description	Mandatory (Yes or No)
Status	Used to indicate the status of the customer registration type. <ul style="list-style-type: none"> Active Inactive 	Yes
Access Group	Used to specify the user group that can access the customer registration created using the customer registration type. <p>Note:</p> <p>The Search (🔍) icon appears corresponding to the Access Group field. On clicking the Search icon, the Access Group Search window appears.</p> <p>On specifying the access group, the description of the access group appears corresponding to the Access Group field.</p>	Yes
Registration Source	Used to indicate the source through which you want to create the customer registration in the system. The valid values are: <ul style="list-style-type: none"> File Upload Inbound Message Manual 	Yes

Tip: Alternatively, you can edit the details of a customer registration type by clicking the **Edit** button in the **Customer Registration Type** zone.

- Modify the required details in the **Main** section, if required.
- Modify additional information about the customer registration type in the **Additional Data** section, if required.
- Define, edit, or remove characteristics of the customer registration type in the **Characteristics** section, if required.
- Associate or disassociate customer registration templates from the customer registration type in the **Customer Registration Templates** section, if required.
- Specify the type of information you want to copy while defining a customer registration using an existing customer registration in the **Copy Customer Registration Details** section, if required.
- Click **Save**.

The changes made to the customer registration type are saved.

Related Topics

For more information on...	See...
How to search for a customer registration type	Searching for a Customer Registration Type on page 525
Customer Registration Type List zone	Customer Registration Type List on page 518
Customer Registration Type screen	Customer Registration Type on page 517

For more information on...	See...
Customer Registration Type zone	Customer Registration Type on page 519
How to define additional data for a customer registration type	Defining Additional Data for a Customer Registration Type on page 529
How to define a characteristic for a customer registration type	Defining a Characteristic for a Customer Registration Type on page 533
How to associate a customer registration template with a customer registration type	Associating a Customer Registration Template with a Customer Registration Type on page 534
How to set an attribute to define a customer registration using the existing customer registration	Setting Attributes to Define a Customer Registration Using the Existing Customer Registration on page 536

Copying a Customer Registration Type

Instead of creating a customer registration type from scratch, you can create a new customer registration type using an existing customer registration type. This is possible through copying a customer registration type. On copying a customer registration type, the details including the additional data, characteristics, customer registration templates, and attributes set to define a customer registration from the existing customer registration are copied to the new customer registration type. You can then edit the details, if required.

Prerequisites

To copy a customer registration type, you should have:

- Customer registration type (whose copy you want to create) defined in the application
- Customer registration business objects defined in the application
- Access groups defined in the application
- Registration sources defined in the application
- Statement construct business object defined in the application
- Benefit business object defined in the application
- Person, account, policy plan, membership, and address business objects defined in the application

Note: The policy plan and membership business objects are required when you are copying a customer registration type which is created using the **C1-CustRegTypeHealthCare** business object.

- Approval To Do types and To Do roles defined in the application
- Billing hierarchy and pricing To Do types and To Do roles defined in the application

Note: The billing hierarchy and pricing To Do types and To Do roles are required when you are copying a customer registration type which is created using the **C1-CustRegTypeHealthCare** business object.

- Characteristic types defined in the application
- Template categories defined in the application

Procedure

To copy a customer registration type:

1. Search for a customer registration type in the **Customer Registration Type List** zone of the **Customer Registration Type** screen.
2. In the **Search Results** section, click the **Duplicate**  icon in the **Duplicate** column corresponding to the customer registration type whose copy you want to create.

The **Customer Registration Type** screen appears. It contains the following sections:

- **Main** - Used to specify basic details about the customer registration type.
- **Additional Data** - Used to define additional information about the customer registration type.
- **Characteristics** - Used to define a list characteristics for the customer registration type.
- **Customer Registration Templates** - Used to associate templates with the customer registration type.
- **Copy Customer Registration Details** - Used to specify the type of information you want to copy while defining a customer registration using an existing customer registration.
- **Main** - The **Main** section contains the following fields:

Field Name	Field Description	Mandatory (Yes or No)
Customer Registration Type	Used to specify the customer registration type.	Yes
Business Object	Indicates the business object using which you want to create the customer registration type.	Not applicable
Description	Used to specify the description for the customer registration type.	Yes
Customer Registration Business Object	Used to indicate the business object using which you want to create the customer registration in the system.	Yes
Detailed Description	Used to specify additional information about the customer registration type.	No
Status	Used to indicate the status of the customer registration type. <ul style="list-style-type: none"> • Active • Inactive 	Yes
Access Group	Used to specify the user group that can access the customer registration created using the customer registration type. <div style="border: 1px solid black; padding: 5px; margin-top: 10px;"> <p>Note:</p> <p>The Search (🔍) icon appears corresponding to the Access Group field. On clicking the Search icon, the Access Group Search window appears.</p> <p>On specifying the access group, the description of the access group appears corresponding to the Access Group field.</p> </div>	Yes

Field Name	Field Description	Mandatory (Yes or No)
Registration Source	Used to indicate the source through which you want to create the customer registration in the system. The valid values are: <ul style="list-style-type: none"> File Upload Inbound Message Manual 	Yes

Tip: Alternatively, you can copy a customer registration type by clicking the **Duplicate** button in the **Customer Registration Type** zone.

- Enter the required details in the **Main** section.
- Enter additional information about the customer registration type in the **Additional Data** section.
- Define, edit, or remove characteristics of the customer registration type in the **Characteristics** section.
- Associate or disassociate customer registration templates from the customer registration type in the **Customer Registration Templates** section.
- Specify the type of information you want to copy while defining a customer registration using an existing customer registration in the **Copy Customer Registration Details** section.
- Click **Save**.

The new customer registration type is defined.

Related Topics

For more information on...	See...
How to search for a customer registration type	Searching for a Customer Registration Type on page 525
Customer Registration Type List zone	Customer Registration Type List on page 518
Customer Registration Type screen	Customer Registration Type on page 517
Customer Registration Type zone	Customer Registration Type on page 519
How to define additional data for a customer registration type	Defining Additional Data for a Customer Registration Type on page 529
How to define a characteristic for a customer registration type	Defining a Characteristic for a Customer Registration Type on page 533
How to associate a customer registration template with a customer registration type	Associating a Customer Registration Template with a Customer Registration Type on page 534
How to set an attribute to define a customer registration using the existing customer registration	Setting Attributes to Define a Customer Registration Using the Existing Customer Registration on page 536

Deleting a Customer Registration Type

Procedure

To delete a Customer Registration Type:

- Search for the customer registration type in the **Customer Registration Type List** zone of the **Customer Registration Type** screen.

- In the **Customer Registration Type List** zone, click the **Delete** () icon in the **Delete** column corresponding to the customer registration type that you want to delete.

A message appears confirming whether you want to delete the customer registration type.

- Click **OK**.

The customer registration type is deleted.

Note: You can delete a customer registration type when a customer registration is not yet defined using the customer registration type.

Tip: Alternatively, you can delete a customer registration type by clicking the **Delete** button in the **Customer Registration Type** zone.

Related Topics

For more information on...	See...
How to search for a customer registration type	Searching for a Customer Registration on page 556
Customer Registration Type List zone	Customer Registration Type List on page 518
Customer Registration Type screen	Customer Registration Type on page 517
Customer Registration Type zone	Customer Registration Type on page 519

Viewing the Customer Registration Type Details

Procedure

To view the details of a customer registration type:

- Search for the customer registration type in the **Customer Registration Type List** zone of the **Customer Registration Type** screen.
- In the **Search Results** section, click the **Broadcast** () icon corresponding to the customer registration type whose details you want to view.

The **Customer Registration Type** zone appears.

- View the details of the customer registration type in the **Customer Registration Type** zone.

Related Topics

For more information on...	See...
How to search for a customer registration type	Searching for a Customer Registration on page 556
Customer Registration Type List zone	Customer Registration Type List on page 518
Customer Registration Type screen	Customer Registration Type on page 517
Customer Registration Type zone	Customer Registration Type on page 519

Customer Registration (Used for Searching)

The **Customer Registration** screen allows you to search for a customer registration using various search criteria. It contains the following zone:

- [Search Customer Registration](#) on page 546

For more information on...	See...
How to view the details of a customer registration	Viewing the Customer Registration Details on page 557
How to define a customer registration	Defining a Customer Registration on page 558
How to copy a customer registration	Copying a Customer Registration on page 599

Search Customer Registration

The **Search Customer Registration** zone allows you to search for a customer registration using various search criteria. It contains the following two sections:

- **Search Criteria** - The **Search Criteria** section contains the following fields:

Field Name	Field Description	Mandatory (Yes or No)
Search By	<p>Used to indicate whether you want to search for a customer registration using the customer registration details. The valid values are:</p> <ul style="list-style-type: none"> • Registration Details <div style="border: 1px solid black; padding: 2px; margin: 5px 0;">Note: This option appears when you have access to the C1CREGSR application service.</div> • Person Details <div style="border: 1px solid black; padding: 2px; margin: 5px 0;">Note: This option appears when you have access to the C1CREGSR application service.</div> • Inbound Message Details <div style="border: 1px solid black; padding: 2px; margin: 5px 0;">Note: This option appears when you have access to the C1CTRGHC application service.</div> • File Upload Details <div style="border: 1px solid black; padding: 2px; margin: 5px 0;">Note: This option appears when you have access to the C1CREGSR application service.</div> <div style="border: 1px solid black; padding: 2px; margin-top: 5px;">Note: By default, the Registration Details option is selected.</div>	Yes
Customer Registration ID	<p>Used to search for a particular customer registration.</p> <div style="border: 1px solid black; padding: 2px; margin-top: 5px;">Note: This field appears when you select the Registration Details option from the Search By list.</div>	Yes (Conditional)
		<div style="border: 1px solid black; padding: 2px;">Note: This field is required for searching customer registrations using the customer registration details.</div>

Field Name	Field Description	Mandatory (Yes or No)
Created From	Used to search customer registrations which are created from a particular date onwards.	Yes (Conditional)
	Note: This field appears when you select the Registration Details or Inbound Message Details options from the Search By list.	Note: This field is required for searching customer registrations using the customer registration or inbound message details.
User ID	Used to search customer registration of a particular user.	Yes (Conditional)
	<p>Note:</p> <p>The Search (🔍) icon appears corresponding to the User ID field. On clicking the Search icon, the User Search window appears where you can search for a particular user.</p> <p>This field appears when you select the Registration Details or Inbound Message Details options from the Search By list.</p>	Note: This field is required for searching customer registrations using the customer registration or inbound message details.
Created To	Used to search customer registrations which are created till a particular date.	Yes (Conditional)
	Note: This field appears when you select the Registration Details or Inbound Message Details options from the Search By list.	Note: This field is required for searching customer registrations using the customer registration or inbound message details.

Field Name	Field Description	Mandatory (Yes or No)
Status	<p>Used to search customer registrations with a particular status. The valid values are:</p> <ul style="list-style-type: none"> • Approval In Progress • Bill Group Approved • Complete • Draft • Draft for Update • Parent Customer Approved • Pending Final Approval • Pending Pricing Correction • Rejected 	Yes (Conditional)
		<p>Note: This field is required for searching customer registrations using the customer registration or inbound message details.</p>
	<p>Note: The values listed above appear when the Registration Details option is selected from the Search By list.</p>	
	<ul style="list-style-type: none"> • Pending • Processed • Rejected • Voided 	
	<p>Note: These values listed above appear when the Inbound Message Details option is selected from the Search By list.</p>	
<p>Note: The Status field appears when you select the Registration Details or Inbound Message Details options from the Search By list.</p>		
Customer Registration Type	<p>Used to search customer registrations which are created using a particular customer registration type.</p>	Yes (Conditional)
	<p>Note: This field appears only when the Registration Details option is selected from the Search By list.</p>	<p>Note: This field is required for searching customer registrations using the customer registration details.</p>
Division	<p>Used to search customer registrations which belong to a particular division.</p>	Yes (Conditional)
	<p>Note:</p> <p>This field appears when the Person Details option is selected from the Search By list.</p> <p>You can view only those divisions to which you have access in the Division list.</p>	<p>Note: This field is required for searching customer registrations using the person details.</p>

Field Name	Field Description	Mandatory (Yes or No)
Person Name	Used to search customer registrations of persons with a particular name.	Yes (Conditional)
	Note: This field appears when the Person Details option is selected from the Search By list and the Advanced Search link available in the upper right corner of the Search Customer Registration zone is clicked.	Note: This field is required for searching customer registrations using the person details.
Person Type	Used to search customer registrations of persons which belong to a particular person type. The valid values are: <ul style="list-style-type: none"> • Bill Group • Broker • Business • Group • Parent Customer • Person 	Yes (Conditional)
	Note: This field appears when the Person Details option is selected from the Search By list and the Advanced Search link available in the upper right corner of the Search Customer Registration zone is clicked.	Note: This field is required for searching customer registrations using the person details.
Address	Used to search customer registrations of persons from a particular address.	Yes (Conditional)
	Note: This field appears when the Person Details option is selected from the Search By list and the Advanced Search link available in the upper right corner of the Search Customer Registration zone is clicked.	Note: This field is required for searching customer registrations using the person details.
City	Used to search customer registrations from a particular city.	Yes (Conditional)
	Note: This field appears when the Person Details option is selected from the Search By list and the Advanced Search link available in the upper right corner of the Search Customer Registration zone is clicked.	Note: This field is required for searching customer registrations using the person details.

Field Name	Field Description	Mandatory (Yes or No)
Phone Number	Used to search for a customer registration of a person having a particular phone number.	Yes (Conditional)
	Note: This field appears when the Person Details option is selected from the Search By list and the Advanced Search link available in the upper right corner of the Search Customer Registration zone is clicked.	Note: This field is required for searching customer registrations using the person details.
Person ID	Used to search customer registration of a particular person.	Yes (Conditional)
	Note: This field appears when the Person Details option is selected from the Search By list.	Note: This field is required for searching customer registrations using the person details.
Person Identifier Type	Used to indicate the person identifier type using which you want to search for customer registrations.	Yes (Conditional)
	Note: This field appears when the Person Details option is selected from the Search By list.	Note: If you enter the person identifier as a search criteria, you have to select the person identifier type. This field is required for searching customer registrations using the person details.
Person Identifier	Used to specify the value of the person identifier type using which you want to search for customer registrations.	Yes (Conditional)
	Note: This field appears when the Person Details option is selected from the Search By list.	Note: If you specify the person identifier type as a search criteria, you have to enter the person identifier. This field is required for searching customer registrations using the person details.

Field Name	Field Description	Mandatory (Yes or No)
Characteristic Type	Used to search customer registrations of persons with a particular characteristic type.	Yes (Conditional)
	<p>Note:</p> <p>The list includes only those characteristic types where the characteristic entity is set to Customer Registration.</p> <p>This field appears when the Person Details option is selected from the Search By list and the Advanced Search link available in the upper right corner of the Search Customer Registration zone is clicked.</p>	<p>Note: This field is required for searching customer registrations using the person details.</p>
Characteristic Value	Used to specify the value of the characteristic type using which you want to search customer registrations of persons.	Yes (Conditional)
	<p>Note:</p> <p>If you select a predefined characteristic type, the Search (🔍) icon appears corresponding to the Characteristic Value field. On clicking the Search icon, the Predefined Characteristic Search window appears.</p> <p>On specifying the value for a predefined characteristic type, the description of the characteristic value appears corresponding to the Characteristic Value field.</p> <p>This field appears when the Person Details option is selected from the Search By list and the Advanced Search link available in the upper right corner of the Search Customer Registration zone is clicked.</p>	<p>Note: This field is required for searching customer registrations using the person details.</p>
Inbound Message ID	Used to search for a customer registration which was created through a particular inbound message.	Yes (Conditional)
	<p>Note: This field appears only when the Inbound Message Details option is selected from the Search By list.</p>	<p>Note: This field is required for searching customer registrations using the inbound message details.</p>
Source System	Used to search customer registrations whose information is received from a particular external system.	Yes (Conditional)
	<p>Note: This field appears when the Inbound Message Details option is selected from the Search By list.</p>	<p>Note: This field is required for searching customer registrations using the inbound message details.</p>

Field Name	Field Description	Mandatory (Yes or No)
External Source ID	Used to search for a customer registrations whose information is received from a particular external source system.	Yes (Conditional)
	Note: This field appears when the Inbound Message Details option is selected from the Search By list.	Note: This field is required for searching customer registrations using the inbound message details.
External Transaction ID	Used to search for a customer registration which is created as a result of a particular transaction in the external source system.	Yes (Conditional)
	Note: This field appears when the Inbound Message Details option is selected from the Search By list.	Note: This field is required for searching customer registrations using the inbound message details.
External Batch ID	Used to search customer registrations which are created through an external batch job.	Yes (Conditional)
	Note: This field appears when the Inbound Message Details option is selected from the Search By list.	Note: This field is required for searching customer registrations using the inbound message details.
Inbound Message Type	Used to search customer registrations which are created using a particular inbound message type.	Yes (Conditional)
	Note: This field appears when the Inbound Message Details option is selected from the Search By list.	Note: This field is required for searching customer registrations using the inbound message details.
Request Id	Used to search customer registrations which are created from a particular file uploaded through the File Upload Interface utility.	Yes (Conditional)
	Note: This field appears when the File Upload Details option is selected from the Search By list.	Note: This field is required for searching customer registrations using the file upload details.
File Name	Used to search customer registrations created from uploading a file with a particular name.	Yes (Conditional)
	Note: This field appears when the File Upload Details option is selected from the Search By list.	Note: This field is required for searching customer registrations using the file upload details.

Field Name	Field Description	Mandatory (Yes or No)
File Status	Used to search customer registrations created from the uploaded files having a particular status. The valid values are: <ul style="list-style-type: none"> • Approval Pending • Completed • Error • Pending • Rejected 	Yes (Conditional)
	Note: This field appears when the File Upload Details option is selected from the Search By list.	Note: This field is required for searching customer registrations using the file upload details.
File Request Type	Used to search customer registrations which are created from the uploaded files with a particular file request type.	Yes (Conditional)
	Note: This field appears when the File Upload Details option is selected from the Search By list.	Note: This field is required for searching customer registrations using the file upload details.

Note: You must specify at least one search criterion while searching for a customer registration. One more search criterion is required when you are searching for a customer registration using the division and/or person type.

- **Search Results** - On clicking the **Search** button, the search results appear based on the specified search criteria. The **Search Results** section contains the following columns:

Column Name	Column Description
Creation Date Time	Displays the date and time when the customer registration is created in the system.
Customer Registration Information	Displays the concatenated string of information about the customer registration. Note: It has a link. On clicking the link, the Customer Registration screen appears where you can view the details of the respective customer registration.

Column Name	Column Description
Status	<p>Indicates the status of the customer registration. The valid values are:</p> <ul style="list-style-type: none"> • Approval In Progress • Bill Group Approved • Complete • Draft • Draft for Update • Parent Customer Approved • Pending Final Approval • Pending Pricing Correction • Rejected
	<p>Note: The values listed above appear when the Registration Details option is selected from the Search By list.</p>
	<ul style="list-style-type: none"> • Pending • Processed • Rejected • Voided
	<p>Note: These values listed above appear when the Inbound Message Details option is selected from the Search By list.</p>
	<p>Note: This column appears only when the Registration Details, Person Details, or Inbound Message Details options are selected from the Search By list.</p>
Request Id	<p>Displays the request Id generated while uploading a file through the File Upload Interface utility for creating the customer registration object.</p>
	<p>Note: This column appears when the File Upload Details option is selected from the Search By list.</p>
Created By	<p>Displays the user who has created the customer registration.</p>
	<p>Note: This column appears when the Registration Details, Person Details, or Inbound Message Details options are selected from the Search By list.</p>
Inbound Message Information	<p>Displays the concatenated string of information about the inbound message.</p>
	<p>Note:</p> <p>It has a link. On clicking the link, the Inbound Message screen appears where you can view the details of the respective inbound message.</p> <p>This column appears when the Inbound Message Details option is selected from the Search By list.</p>

Column Name	Column Description
File ID	Displays the file which is uploaded for creating the customer registration through the File Upload Interface utility.
	Note: This column appears when the File Upload Details option is selected from the Search By list.
Copy	On clicking the Copy () icon, the Customer Registration screen appears where you can define a new customer registration using an existing customer registration.
	Note: This column appears when the Registration Details option is selected from the Search By list.
Person Name	Displays the name of the person for whom the customer registration is defined in the system.
	Note: This column appears when the Person Details option is selected from the Search By list.
Inbound Message Type	Indicates the inbound message type using which the inbound message is created in the system.
	Note: This column appears when the Inbound Message Details option is selected from the Search By list.
File Name	Displays the name of the file which is uploaded for creating the customer registration through the File Upload Interface utility.
	Note: This column appears when the File Upload Details option is selected from the Search By list.
Primary Person Identifier Type	Indicates the primary identifier type associated with the person.
	Note: This column appears when the Person Details option is selected from the Search By list.
Source System	Indicates the source system from where the inbound message is received for creating the customer registration.
	Note: This column appears when the Inbound Message Details option is selected from the Search By list.
Request Type	Indicates the request type using which the file is uploaded through the File Upload Interface utility for creating the customer registration.
	Note: This column appears only when the File Upload Details option is selected from the Search By list.
Primary Person Identifier	Displays the primary person identifier.
	Note: This column appears when the Person Details option is selected from the Search By list.

Note: Pagination is used to display limited number of records in the **Search Results** section. You can use the navigation links, such as **Previous** and **Next** to navigate between pages.

Related Topics

For more information on...	See...
How to search for a customer registration	Searching for a Customer Registration on page 556
Customer Registration screen	Customer Registration (Used for Searching) on page 545

Searching for a Customer Registration

Prerequisites

To search for a customer registration, you should have:

- Customer registration business objects defined in the application
- Customer registration statuses and customer registration types defined in the application
- Divisions associated with the access group to which the user belongs
- Person types and person identifier types defined in the application
- Characteristic types defined in the application (where the characteristic entity is set to **Customer Registration**)
- Inbound message statuses, inbound message types, and source systems defined in the application.
- File statuses and file request types defined in the application.

Procedure

To search for a customer registration:

- 1.** Click the **Menu** link in the **Application** toolbar.
A list appears.
- 2.** From the **Main** menu, select **Customer Management** and then click **Customer Registration**.
A sub-menu appears.
- 3.** Click the **Search** option from the **Customer Registration** sub-menu.
The **Customer Registration** screen appears.
- 4.** Enter the search criteria in the **Search Customer Registration** zone.

Note:

You must specify at least one search criterion while searching for a customer registration object. One more search criterion is required when you are searching for a customer registration using the division and/or person type.

The criteria are grouped as indicated by line separators between the criteria. Each group is independent from the other, and only one group is used at a time for searching. If you enter criteria in more than one group, the criteria from the former group is used for searching. For example, if you enter the person name (in the second criteria group) and person identifier (in the fourth criteria group), the system searches using the person name instead of the person identifier.

You must specify the division when you are searching for a customer registration of a person using the city.

You must specify division and/or any other criteria in the second group when you are searching for a customer registration using the person type.

If you have specified any other search criterion along with the person ID, the system ignores the additional search criterion and searches for the customer registration using the person ID.

ORMB search engine supports wildcard search, where you can substitute the percentage (%) symbol as a stand in for any word or letter in a search criteria. You can use the ‘%’ wildcard character in all input fields except the date and ID fields. The ‘%’ wildcard character is suffixed automatically at the end of the partial search criteria. Therefore, you may or may not specify the wildcard character at the end of the partial search criteria. However, you have to prefix the wildcard character manually wherever required.

The **Advanced Search** link appears in the right side of the **Search Customer Registration** zone. On clicking the **Advanced Search** link, additional fields appear in the zone which help you to refine the search.

If you select a predefined characteristic type, the **Search** (🔍) icon appears corresponding to the **Characteristic Value** field. On clicking the **Search** icon, you can search for a predefined characteristic value.

5. Click **Search**.

A list of customer registrations that meet the search criteria appears in the **Search Results** section.

Related Topics

For more information on...	See...
Customer Registration screen	Customer Registration (Used for Viewing) on page 608
Customer Registration zone	Customer Registration on page 609

Viewing the Customer Registration Details**Procedure**

To view the details of a customer registration:

1. Search for the customer registration in the **Customer Registration** screen.
2. In the **Search Results** section, click the link in the **Customer Registration Information** column corresponding to the customer registration whose details you want to view:

The **Customer Registration** screen appears.

3. Ensure that the **Main** tab is selected.
4. View the details of the customer registration in the **Customer Registration** zone.

Related Topics

For more information on...	See...
How to search for a customer registration	Searching for a Customer Registration on page 556
Customer Registration screen	Customer Registration (Used for Viewing) on page 608
Customer Registration zone	Customer Registration on page 609

Defining a Customer Registration

Prerequisites

To define a customer registration, you should have:

- Customer registration types, source systems, and person types defined in the application
- Divisions, customer segments, customer tiers, and access groups defined in the application
- Name types, phone types, and person identifier types defined in the application
- Address type codes and countries defined in the application
- Characteristic types defined in the application (where the characteristic entity is set to **Customer Registration**)
- Relationship types defined in the application
- Customer class, invoice currencies, account categories, bill cycles, accrual cycles, account identifier types, auto pay source codes, auto pay methods, auto pay route types, account relationship types, bill formats, address sources, bill route types, and collection class defined in the application

Note: The collection class is required when you are defining a customer registration using the **C1-CustomerRegistrationBanking** business object.

- Deal review frequencies and currency codes defined in the application

Note: These prerequisites are required when you are defining a customer registration using the **C1-CustomerRegistrationBanking** business object.

- Policy types and policy person roles defined in the application.

Note: These prerequisites are required when you are defining a customer registration using the **C1-CustomerRegistrationHC** business object.

Procedure

To define a customer registration:

1. Click the **Menu** link in the **Application** toolbar.
A list appears.
2. From the **Main** menu, select **Customer Management** and then click **Customer Registration**.
A sub-menu appears.
3. Click the **Add** option from the **Customer Registration** sub-menu.

The **Add Customer Registration** screen appears. It contains the following fields:

Field Name	Field Description	Mandatory (Yes or No)
Customer Registration Type	Used to indicate the customer registration type using which you want to define the customer registration.	Yes

Field Name	Field Description	Mandatory (Yes or No)
Source System	Used to indicate the external system from where the customer registration information is received.	No
Person Type	Used to indicate the type of person for whom you want to define the customer registration.	Yes

Tip: Alternatively, you can access the **Add Customer Registration** screen by clicking the **Add** button in the **Page Title** area of the **Customer Registration** screen.

4. Select the required **Customer Registration Type** from the respective field.
5. Select the required **Source System** from the respective field, if required.
6. Select the required **Person Type** from the respective field.
7. Click **OK**.

The **Customer Registration** screen appears. It contains the following pages:

- **Main** - Used to specify basic information about the person.
- **Contact** - Used to specify the contact information about the person.
- **Person Characteristics** - Used to define a list of characteristics for the person.
- **Hierarchy** - Used to define the person to person relationship for the person
- **Accounts** - Used to add the account details of the person.
- **Deal** - Used to specify information about the deals created for the person.

Note: This page appears only when you are defining a customer registration using the **C1-CustomerRegistrationBanking** business object.

- **Policies** - Used to specify the policy details of the person.

Note: This page appears when you are defining a customer registration using the **C1-CustomerRegistrationHC** business object.

- **Registration Characteristics** - Used to define a list of characteristics for the customer registration.

The **Main** page contains the following sections:

- **Main** - Used to specify basic details about the person.
- **Person Name** - Used to add the person names for customer registration.
- **Person Phones** - Used to add the person phone details for customer registration.
- **Person IDs** - Used to add the person identifiers for customer registration.

The **Main** section contains the following fields:

Field Name	Field Description	Mandatory (Yes or No)
Person Type	Indicates the person type using which you want to define the customer registration for the person.	Not applicable
Date of Birth	Used to specify the date when the person was born.	Yes

Field Name	Field Description	Mandatory (Yes or No)
Division	Used to indicate the division to which the person belongs.	Yes
	Note: You can view only those divisions to which you have access in the Division list.	
Person Since Date	Used to specify the date from when the person is the main customer.	Yes
Customer Segment	Used to indicate the customer segment to which the person belongs.	Yes
	Note: This field appears when you are defining a customer registration using the C1-CustomerRegistrationBanking business object.	
Customer Tier	Used to indicate the customer tier of the customer segment to which the person belongs.	Yes
	Note: This field appears when you are defining a customer registration using the C1-CustomerRegistrationBanking business object.	
Access Group	Used to indicate the user group that can access the customer registration.	Yes
	Note: The Search (🔍) icon appears corresponding to the Access Group field. On clicking the Search icon, the Access Group Search window appears. On specifying the access group, the description of the access group appears corresponding to the Access Group field.	

8. Enter the required details in the **Main** section.
9. Add the names of the person in the **Person Names** section.
10. Add the phone details for the person in the **Person Phones** section.
11. Add the identifier details for the person in the **Person IDs** section.
12. Define the addresses of the person in the **Contact** page, if required.
13. Define a list of characteristics for the person in the **Person Characteristics** page, if required.
14. Define the person to person relationship for the person in the **Hierarchy** page, if required.
15. Add the account details of the person in the **Accounts** page, if required.
16. Add information about the deals created for the person in the **Deal** page, if required.

Note: This page appears when you are defining a customer registration using the **C1-CustomerRegistrationBanking** business object.

17. Add the policy details of the person in the **Policies** page, if required.

Note: This page appears when you are defining a customer registration using the **C1-CustomerRegistrationHC** business object.

18. Define a list of characteristics for the customer registration in the **Registration Characteristics** page, if required.

19. Click **Validate and Save**.

The customer registration is defined.

Related Topics

For more information on...	See...
Customer Registration screen	Customer Registration (Used for Viewing) on page 608
How to add name of a person for customer registration	Adding the Names of a Person on page 561
How to add the phone details of a person for customer registration	Adding the Phone Details of a Person on page 562
How to add the identifier details of a person for customer registration	Adding the Identifier Details of a Person on page 563
How to add the contact details of a person for customer registration	Adding the Contact Details of a Person on page 564
How to define a characteristic for a person	Defining a Characteristic for a Person on page 567
How to define the hierarchy of a person	Defining a Person to Person Relationship for a Person on page 568
How to add an account for a person	Adding an Account for a Person on page 571
How to add a deal information for a person	Adding the Deal Information for a Person
How to add a policy for a person	Defining a Policy on page 583
How to define a characteristic for a customer registration	Defining a Characteristic for a Customer Registration on page 594

Adding the Names of a Person

Prerequisites

To add the names of a person, you should have:

- Name types defined in the application.

Procedure

To add the names of a person:

1. Ensure that the **Person Names** section is expanded in the **Main** page when you are defining, editing, or copying a customer registration.

The **Person Names** section contains the following columns:

Column Name	Column Description	Mandatory (Yes or No)
Name Type	Used to indicate the type of name which you want to add for the customer registration.	Yes (Conditional)
	Note: The list includes only those name types where the name type entity is set to Customer Registration .	Note: This field is required when you are adding a name for customer registration.
Name	Used to specify the name of the person.	Yes (Conditional)
		Note: This field is required when you are adding a name for customer registration.

- Enter the required details in the **Person Names** section.
- If you want to add more than one person name for the customer registration, click the **Add (+)** icon and then repeat step 2.

Note: However, if you want to remove a person name from the customer registration, click the **Delete (🗑)** icon corresponding to the person name.

- Click **Validate and Save**.

The names are added for the person.

Related Topics

For more information on...	See...
How to define a customer registration	Defining a Customer Registration on page 558
How to edit a customer registration	Editing the Customer Registration Details on page 626
How to copy a customer registration	Copying a Customer Registration on page 599

Adding the Phone Details of a Person

Prerequisites

To add the phone details of a person, you should have:

- Phone types defined in the application.

Procedure

To add the phone details of a person:

- Ensure that the **Person Phones** section is expanded in the **Main** page when you are defining, editing, or copying a customer registration.

The **Person Phones** section contains the following columns:

Column Name	Column Description	Mandatory (Yes or No)
Phone Type	Used to indicate the type of the phone which you want to add for the person. The valid values are: <ul style="list-style-type: none"> • Business • Business Phone • Fax • Home • Mobile 	Yes (Conditional)
		Note: This field is required when you are adding the phone details of a person.
Phone Number	Used to specify the phone number.	Yes (Conditional)
		Note: This field is required when you are adding the phone details of a person.
Extension	Used to specify the extension value of the phone number.	Yes (Conditional)
		Note: This field is required when you are adding the phone details of a person.
Phone Format	Displays the format in which the phone number is specified for the person.	Not applicable

- Enter the required details in the **Person Phones** section.
- If you want to add more than one person phone for the customer registration, click the **Add (+)** icon and then repeat step 2.

Note: However, if you want to remove a person phone from the customer registration, click the **Delete (🗑)** icon corresponding to the person phone.

- Click **Validate and Save**.

The phone details are added for the person.

Related Topics

For more information on...	See...
How to define a customer registration	Defining a Customer Registration on page 558
How to edit a customer registration	Editing the Customer Registration Details on page 626
How to copy a customer registration	Copying a Customer Registration on page 599

Adding the Identifier Details of a Person

Prerequisites

To add the identifier details of a person, you should have:

- Person identifier types defined in the application.

Procedure

To add the identifier details of a person:

1. Ensure that the **Person IDs** section is expanded in the **Main** page when you are defining, editing, or copying a customer registration.

The **Person IDs** section contains the following columns:

Column Name	Column Description	Mandatory (Yes or No)
Primary ID	Used to indicate whether the person identifier is primary or not.	Yes (Conditional) Note: This field is required while adding the identifier details of a person.
Person Identifier Type	Used to indicate the identifier type which you want to add for the person. Note: The list includes only those person identifier types where the person identifier type entity is set to Customer Registration .	Yes (Conditional) Note: This field is required while adding the identifier details of a person.
Person Identifier	Used to specify the value of the person identifier type.	Yes (Conditional) Note: This field is required while adding the identifier details of a person.
Identifier Format	Displays the format in which the person identifier is specified for the person.	Not applicable

2. Enter the required details in the **Person IDs** section.
3. If you want to add more than one person identifier for the person, click the **Add (+)** icon and then repeat step 2.

Note: However, if you want to remove a person identifier from the person, click the **Delete (🗑)** icon corresponding to the person identifier.

4. Click **Validate and Save**.

The identifier details are added for the person.

Related Topics

For more information on...	See...
How to define a customer registration	Defining a Customer Registration on page 558
How to edit a customer registration	Editing the Customer Registration Details on page 626
How to copy a customer registration	Copying a Customer Registration on page 599

Adding the Contact Details of a Person

Prerequisites

To add the contact details of a person, you should have:

- Address type codes and countries defined in the application.

Procedure

To add the contact details of a person:

1. Ensure that the **Person Addresses** section in the **Contact** page is expanded when you are defining, editing, or copying a customer registration.

The **Person Addresses** section contains the following fields:

Field Name	Field Description	Mandatory (Yes or No)
Address Type Code	Used to indicate the type of address that you want to add for the person.	Yes
	Note: The list includes only those address type codes where the address type code entity is set to Customer Registration .	
Effective Date	Used to specify the date from when the address is effective for the person.	Yes
Season	Used to specify the season for which the address is effective for the person.	Yes (Conditional)
	Note: This field appears when you select the Person Seasonal option from the Address Type Code field.	Note: This field is required while adding the seasonal contact details of a person.
Country	Used to indicate the country where the person is located.	Yes
	Note: The list includes only those countries which are already defined in the system. On selecting a country, only those address fields which are set as Optional while defining the country appear in the Person Addresses section. Also, the labels of the address fields will change depending on the business label which is defined for the respective address field in the Country screen.	
Address 1	Used to specify the first line of the address. It may contain details, such as house number and apartment name.	No
Address 2	Used to specify the second line of the address. It may contain details, such as street name.	No
City	Used to specify the city name.	No
Address 3	Used to specify the third line of the address. It may contain the landmark details.	No

Field Name	Field Description	Mandatory (Yes or No)
County	Used to specify the county name.	No
State	Used to indicate the state where the city or county is located.	No
	Note: The states listed in this field change depending on the country that you have selected.	
Province	Used to specify the location within the country where the person is located.	No
Address 4	Used to specify the fourth line of the address.	No
Postal	Used to specify the postal or zip code of the address.	No
House Type	Used to indicate the type of the house.	No
	Note: The list includes only those values which are defined in the HOUSE_TYPE lookup field.	
In City Limit	Used to indicate whether the address is within the city limit. The valid values are: <ul style="list-style-type: none"> • Yes • No 	No
Geographic Code	Used to specify the geographic code of the address.	No

Note: The above mentioned fields appear in the **Person Addresses** section when the respective data is available for the person.

In addition, the **Person Addresses** section contains the following fields:

Field Name	Field Description	Mandatory (Yes or No)
Override Mailing Name - Name1	Used to specify the name using which you want to override the person's mailing name.	Yes (Conditional)
		Note: This field is required while overriding the persons contact name.
Override Mailing Name - Name2	Used to specify the name using which you want to override the person's override mailing name 1.	Yes (Conditional)
		Note: This field is required while overriding the persons Override Mailing Name - Name1 .

Field Name	Field Description	Mandatory (Yes or No)
Override Mailing Name - Name3	Used to specify the name using which you want to override the person's override mailing name 2.	Yes (Conditional) Note: This field is required while overriding the persons Override Mailing Name - Name2 .
Email Address	Used to specify the email address of the person.	No

- Enter the required details in the **Person Addresses** section.
- If you want to add more than one contact details of the person, click the **Add (+)** icon in the upper right corner of this section and then repeat step 2.

Note: However, if you want to remove the contact details of the person, click the **Delete (🗑)** icon in the upper right corner of this section.

- Click **Validate and Save**.

The contact details are added for the person.

Related Topics

For more information on...	See...
How to define a customer registration	Defining a Customer Registration on page 558
How to edit a customer registration	Editing the Customer Registration Details on page 626
How to copy a customer registration	Copying a Customer Registration on page 599

Defining a Characteristic for a Person

Prerequisites

To define a characteristic for a person, you should have:

- Characteristic types defined in the application (where the characteristic entity is set to **Customer Registration**)

Procedure

To define a characteristic for a person:

- Ensure that the **Characteristics** section is expanded in the **Person Characteristics** page when you are defining, editing, or copying a customer registration.

The **Characteristics** section contains the following columns:

Field Name	Field Description	Mandatory (Yes or No)
Effective Date	Used to specify the date from when the characteristic is effective for the person.	Yes (Conditional) Note: This field is required while defining a characteristic for the person.

Field Name	Field Description	Mandatory (Yes or No)
Characteristic Type	Used to indicate the characteristic type.	Yes (Conditional)
	Note: The list includes only those characteristic types where the characteristic entity is set to Customer Registration .	Note: This field is required while defining a characteristic for the person.
Characteristic Value	Used to specify the value for the characteristic type.	Yes (Conditional)
	Note: If you select a predefined characteristic type, the Search (🔍) icon appears corresponding to the Characteristic Value field. On clicking the Search icon, the Predefined Characteristic Search window appears. On specifying the value for a predefined characteristic type, the description of the characteristic value appears corresponding to the Characteristic Value field.	Note: This field is required while defining a characteristic for the person.

- Enter the required details in the **Characteristics** section.
- If you want to define more than one characteristic for the person, click the **Add** (+) icon and then repeat step 2.

Note: However, if you want to remove a characteristic from the person, click the **Delete** (🗑️) icon corresponding to the characteristic.

- Click **Validate and Save**.

The characteristic is defined for the person.

Related Topics

For more information on...	See...
How to define a customer registration	Defining a Customer Registration on page 558
How to edit a customer registration	Editing the Customer Registration Details on page 626
How to copy a customer registration	Copying a Customer Registration on page 599

Defining a Person to Person Relationship for a Person

Prerequisites

To define a person to person relationship for a person, you should have:

- Relationship types defined in the application (where the relationship entity is set to **Customer Registration**)

Procedure

To define a person to person relationship for a person:

- Ensure that the **Related Person Information** section is expanded in the **Hierarchy** page when you are defining, editing, or copying a customer registration.

The **Related Person Information** section contains the following columns:

Column Name	Column Description	Mandatory (Yes or No)
Related Person ID	Used to indicate the person with whom you want to define the person to person relationship of the main customer.	Yes (Conditional)
	<p>Note:</p> <p>The Search (🔍) icon appears corresponding to the Related Person ID field. On clicking the Search icon, the Person Search window appears.</p> <p>On specifying the person, the description of the person appears corresponding to the Related Person ID field.</p>	<p>Note: This field is required while defining a person to person relationship for a person.</p>
Parent/Child	Used to indicate whether the related person is a parent or a child. The valid values are:	Yes (Conditional)
	<ul style="list-style-type: none"> • Parent • Child 	<p>Note: This field is required while defining a person to person relationship for a person.</p>
Relationship Type	Used to indicate the person to person relationship type.	Yes (Conditional)
	<p>Note: The list includes only those relationship types where the relationship entity is set to Customer Registration.</p>	<p>Note: This field is required while defining a person to person relationship for a person.</p>
Start Date	Used to indicate the date from when the person to person relationship is effective.	Yes (Conditional)
	<p>Note: The start date cannot be later than the end date.</p>	<p>Note: This field is required while defining a person to person relationship for a person.</p>
End Date	Used to indicate the date till when the person to person relationship is effective.	No
	<p>Note: The end date cannot be earlier than the start date.</p>	
Financial Relationship	Used to indicate whether the related person is financially responsible or not.	Yes (Conditional)
		<p>Note: This field is required while defining a person to person relationship for a person.</p>
Characteristics	On clicking the Add (+) icon, you can define a list of characteristics for the person to person relationship.	No

2. Enter the required details in the **Related Person Information** section.

- If you want to define more than one person to person relationship for the person, click the **Add (+)** icon and then repeat step 2.

Note: However, if you want to remove a person to person relationship from the person, click the **Delete (🗑)** icon corresponding to the related person.

- Click **Validate and Save**.

The person to person relationship is defined for the person.

Related Topics

For more information on...	See...
How to define a customer registration	Defining a Customer Registration on page 558
How to edit a customer registration	Editing the Customer Registration Details on page 626
How to copy a customer registration	Copying a Customer Registration on page 599

Defining a Characteristic for a Person to Person Relationship

Prerequisites

To define a characteristic for a person to person relationship, you should have:

- Characteristic types defined in the application (where the characteristic entity is set to **Person Relationship**)

Procedure

To define a characteristic for a person to person relationship:

- Ensure that the **Related Person Information** section is expanded in the **Hierarchy** page when you are defining, editing, or copying a customer registration.
- Click the **Add (+)** icon in the **Characteristics** column corresponding to the related person.

The following columns appear in the **Related Person Information** section.

Column Name	Column Description	Mandatory (Yes or No)
Effective Date	Used to specify the date from when the characteristic is effective for the person to person relationship.	Yes (Conditional)
		Note: This field is required while defining a characteristic for the person to person relationship.
Characteristic Type	Used to indicate the characteristic type. Note: The list includes only those characteristic types where the characteristic entity is set to Person Relationship .	Yes (Conditional)
		Note: This field is required while defining a characteristic for the person to person relationship.

Column Name	Column Description	Mandatory (Yes or No)
Characteristic Value	Used to specify the value for the characteristic type.	Yes (Conditional)
	<p>Note:</p> <p>If you select a predefined characteristic type, the Search (🔍) icon appears corresponding to the Characteristic Value field. On clicking the Search icon, the Predefined Characteristic Search window appears.</p> <p>On specifying the value for a predefined characteristic type, the description of the characteristic value appears corresponding to the Characteristic Value field.</p>	<p>Note: This field is required while defining a characteristic for the person to person relationship.</p>

- Enter the required details in the **Related Person Information** section.
- If you want to define more than one characteristic for the person to person relationship, click the **Add** (+) icon and then repeat step 2.

Note: However, if you want to remove a characteristic from the person to person relationship, click the **Delete** (🗑️) icon corresponding to the characteristic.

- Click **Validate and Save**.

The characteristic is defined for the person to person relationship.

Related Topics

For more information on...	See...
How to define a customer registration	Defining a Customer Registration on page 558
How to edit a customer registration	Editing the Customer Registration Details on page 626
How to copy a customer registration	Copying a Customer Registration on page 599
How to define a person to person relationship for a person	Defining a Person to Person Relationship for a Person on page 568

Adding an Account for a Person

Prerequisites

To add the account for a person, you should have:

- Customer class, divisions, currencies, account categories, access groups, accrual cycles, and bill cycles defined in the application
- Account identifier types defined in the application
- Auto pay source codes, auto pay methods, and auto pay route types defined in the application
- Account relationship types defined in the application
- Address sources, bill formats, and bill route types defined in the application
- Characteristic types defined in the application (where the characteristic entity is set to **Account**)
- Collection class defined in the application

Note: The collection class is required when you are defining a customer registration using the **C1-CustomerRegistrationBanking** business object.

Procedure

To add an account for a person:

1. Ensure that the **Accounts** section is expanded in the **Accounts** page when you are adding, editing, or removing an account of a person.

The **Accounts** section contains the following columns:

Column Name	Column Description	Mandatory (Yes or No)
Sequence No.	Displays the sequence number of the account.	Not applicable
Template	Displays the account template using which the account is added for the person.	Not applicable
Customer Class	Indicates the customer class to which the account belongs.	Not applicable
Division	Indicates the division to which the account belongs.	Not applicable
Primary Identifier Type	Indicates the primary identifier type using which the account is added for the person.	Not applicable
Identifier Value	Displays the value of the primary identifier type.	Not applicable
Account Information	Displays the concatenated string of information about the account that is added for the person.	Not applicable
View / Edit	On clicking the View / Edit (✎) icon, you can view or edit the details of the account.	Not applicable

Note: No information appears in the above columns if an account is not yet added for the person.

2. Click the **Add New Account** button in the **Accounts** section.

The **Customer Registration - Add Account** screen appears. It contains the following pages:

- **Main** - Used to specify basic information about the account.
- **Auto Pay** - Used to add the automatic payment details of the account.
- **Persons** - Used to associate a person to the account.
- **Account Characteristics** - Used to define a list of characteristics for the account.
- **Credit Ratings** - Used to add the credit rating details for the account.

Note: This page appears when you are defining a customer registration using the **C1-CustomerRegistrationBanking** business object.

The **Main** page contains the following sections:

- **Main** - Used to specify basic details about the account.
- **Account Identifiers** - Used to add the identifier details for the account.

The **Main** section contains the following fields:

Field Name	Field Description	Mandatory (Yes or No)
Customer Class	Used to indicate the customer class to which the account belongs.	Yes
Division	Used to indicate the division to which the account belongs. Note: You can only view those divisions to which you have access in the Division list.	Yes
Set Up Date	Used to specify the date from when the account is configured for the person. Note: By default, the current date appears in this field.	Yes
Invoice Currency	Used to indicate the currency which you want to use for generating the invoice of the account. Note: The list includes only those currencies which are defined in the system.	Yes
Account Category	Used to indicate the category to which the account belongs. The valid values are: <ul style="list-style-type: none"> • Invoice Account • Settlement Account • Usage Account Note: The list includes only those values which are present in the ACCT_USAGE_FLG lookup field.	Yes
Access Group	Used to indicate the user group that can access the account for the person. Note: The Search (🔍) icon appears corresponding to the Access Group field. On clicking the Search icon, the Access Group Search window appears. On specifying the access group, the description of the access group appears corresponding to the Access Group field.	Yes

Field Name	Field Description	Mandatory (Yes or No)
Exclude Accrual	Used to indicate whether the account is eligible for accrual.	No
	Note: By default, the account is eligible for accrual if the division to which the account belongs is eligible for accrual. If you do not want the account to be eligible for accrual, you must select the Exclude Accrual check box. On selecting the Exclude Accrual check box, the Accrual Cycle field is disabled.	
Accrual Cycle	Used to indicate the accrual cycle of the account in the division.	No
	Note: The Search (🔍) icon appears corresponding to the Accrual Cycle field. On clicking the Search icon, the Accrual Cycle Search for Cust Reg window appears. On specifying the accrual cycle, the description of the accrual cycle appears corresponding to the Accrual Cycle field. This field is disabled when you click the Exclude Accrual check box.	
Product	Used to indicate the product for which the account is enrolled.	Yes (Conditional)
	Note: The Search (🔍) icon appears corresponding to the Product field. On clicking the Search icon, the Search Product window appears.	
Eligible for Repricing	Used to indicate whether the account is eligible for repricing when the account attributes (defined as parameters in the system) are changed.	No
	Note: Only accounts where the person and child person are the main customers are considered for repricing. The system creates the repricing request for the account irrespective of whether the account is eligible for repricing or not.	
Bill Cycle	Used to indicate the bill cycle for the account.	No

Field Name	Field Description	Mandatory (Yes or No)
Bill Lead Days	Used to specify the number of days which is used to derive the cut-off date for advance billing.	Yes
	Note: In case you don't want to bill the account in advance, you must specify 0 in this field.	
Comments	Used to specify additional information about the account.	No

3. Enter the required details in the **Main** section.
4. Add, edit, or remove the identifier details of the account in the **Account Identifiers** section.
5. Add, edit, or remove the automatic payment details of the account in the **Auto Pay** page, if required.
6. Associate or disassociate persons from the account in the **Persons** page, if required.
7. Define, edit, or remove characteristics of the account in the **Account Characteristics** page, if required.
8. Add, edit, or remove the credit rating details of the account in the **Credit Ratings** page, if required.
9. Click **Validate and Save**.

The account is added for the person.

Related Topics

For more information on...	See...
How to define a customer registration	Defining a Customer Registration on page 558
How to edit a customer registration	Editing the Customer Registration Details on page 626
How to copy a customer registration	Copying a Customer Registration on page 599
How to add the identifier details of an account	Adding the Identifier Details of an Account on page 575
How to add the automatic payment details of an account	Adding the Automatic Payment Details of an Account on page 576
How to associate a person to an account	Associating a Person to an Account on page 579
How to define a characteristic for an account	Defining a Characteristic for an Account on page 582
How to add the credit rating details for an account	Adding the Credit Rating Details for an Account

Adding the Identifier Details of an Account

Prerequisites

To add the identifier details of an account, you should have:

- Account identifier types defined in the application.

Procedure

To add the identifier details of an account:

1. Ensure that the **Account Identifiers** section is expanded in the **Customer Registration - Add Account** screen when you are adding or editing the account of a person.

The **Account Identifiers** section contains the following columns:

Column Name	Column Description	Mandatory (Yes or No)
Primary ID	Used to indicate whether the account identifier is primary or not.	Yes
Account Identifier Type	Used to indicate the identifier type for the account.	Yes (Conditional) Note: This field is required while adding an account identifier.
Primary Account Identifier	Used to specify the primary account identifier for the account identifier type.	Yes (Conditional) Note: This field is required while adding an account identifier.

Note: You must specify at least one primary identifier while adding an account for a person.

2. Enter the required details in the **Account Identifiers** section.
3. If you want to add more than one account identifier for the account, click the **Add (+)** icon and then repeat step 2.

Note: However, if you want to remove an account identifier from the account, click the **Delete (🗑)** icon corresponding to the account identifier type.

4. Click **Validate and Save**.

The identifier details are added for the account.

Related Topics

For more information on...	See...
How to define a customer registration	Defining a Customer Registration on page 558
How to edit a customer registration	Editing the Customer Registration Details on page 626
How to copy a customer registration	Copying a Customer Registration on page 599
How to add an account for a person	Adding an Account for a Person on page 571
How to edit the account details of a person	Editing the Account Details of a Person on page 596

Adding the Automatic Payment Details of an Account

Prerequisites

To add the automatic payment details of an account, you should have:

- Auto pay source codes, auto pay methods, and auto pay route types defined in the application

Procedure

To add the automatic payment details of an account:

1. Ensure that the **Auto Pay** page is expanded in the **Customer Registration - Add Account** screen when you are adding or editing the account of a person.

The **Auto Pay** page contains the following fields:

Field Name	Field Description	Mandatory (Yes or No)
Defer Auto Pay Date	Used to indicate the date till when you want to hold the automatic payment process of the account.	Yes (Conditional)
		Note: This field is required while adding the automatic payment details of the account
Rule Based Auto Pay	Used to indicate whether the automatic payment is rule based.	Yes (Conditional)
		Note: This field is required while adding the automatic payment details of the account
Start Date	Used to indicate the date from when the automatic payment is effective for the account.	Yes (Conditional)
		Note: This field is required while adding the automatic payment details of the account
End Date	Used to indicate the date till when the automatic payment is effective for the account.	No
		Note: The end date cannot be earlier than the start date.
Percentage	Used to specify the contribution of payment amount in percentage within multiple Auto Pay IDs (i.e for Auto Pay Source Codes) having the same priority.	Yes (Conditional)
		Note: This field is required while adding the automatic payment details of the account
Priority	Used to specify the order in which the automatic payment option is considered for the effective date range.	Yes (Conditional)
		Note: This field is required while adding the automatic payment details of the account

Field Name	Field Description	Mandatory (Yes or No)
Auto Pay Source Code	Used to indicate the financial institution that receives the automatic payment request.	Yes (Conditional)
	<p>Note:</p> <p>The Search (🔍) icon appears corresponding to the Auto Pay Source Code field. On clicking the Search icon, the Auto Pay Source Search window appears.</p> <p>On specifying the auto pay source code, the description of the auto pay source code appears corresponding to the Auto Pay Source Code field.</p>	<p>Note: This field is required while adding the automatic payment details of the account</p>
Auto Pay Method	Used to indicate the method using which you want the system to process the automatic payment for the account. The valid values are:	Yes (Conditional)
	<ul style="list-style-type: none"> • Direct Debit • Payment Advice 	<p>Note: This field is required while adding the automatic payment details of the account</p>
Auto Pay Route Type	Used to indicate when and how the automatic payment request of the account is routed to the financial institution.	Yes (Conditional)
	<p>Note:</p> <p>The Search (🔍) icon appears corresponding to the Auto Pay Route Type field. On clicking the Search icon, the Auto Pay Route Type Search window appears.</p> <p>On specifying the auto pay route type, the description of the auto pay route type appears corresponding to the Auto Pay Route Type field.</p>	<p>Note: This field is required while adding the automatic payment details of the account</p>
Account Number	Used to specify the account number for which you want to add the automatic payment details.	Yes (Conditional)
		<p>Note: This field is required while adding the automatic payment details of the account</p>
Expires On	Used to specify the month and year of expiry for the automatic payment of the account.	Yes (Conditional)
		<p>Note: This field is required while adding the automatic payment details of the account</p>

Field Name	Field Description	Mandatory (Yes or No)
Name	Used to specify the account name for which you want to add the automatic payment details.	Yes (Conditional) Note: This field is required while adding the automatic payment details of the account
Maximum Withdrawal Amount	Used to specify the maximum amount which can be withdrawn from the account through the automatic payment method.	Yes (Conditional) Note: This field is required while adding the automatic payment details of the account
Comments	Used to specify additional information about the automatic payment for the account.	No

- Enter the required details in the **Auto Pay** page.
- If you want to add more than one automatic payment details of the account, click the **Add (+)** icon and then repeat step 2.

Note: However, if you want to remove an automatic payment detail from the account, click the **Delete (🗑)** icon.

- Click **Validate and Save**.

The automatic payment details are added for the account.

Related Topics

For more information on...	See...
How to define a customer registration	Defining a Customer Registration on page 558
How to edit a customer registration	Editing the Customer Registration Details on page 626
How to copy a customer registration	Copying a Customer Registration on page 599
How to add an account for a person	Adding an Account for a Person on page 571
How to edit the account details of a person	Editing the Account Details of a Person on page 596

Associating a Person to an Account

Prerequisites

To associate a person to an account, you should have:

- Account relationship types defined in the application

Procedure

To associate a person to an account:

- Ensure that the **Persons** page is expanded in the **Customer Registration - Add Account** screen when you are adding or editing the account of a person.

The **Persons** page contains the following fields:

Field Name	Field Description	Mandatory (Yes or No)
Person ID	Used to indicate the person you want to associate with the account.	Yes (Conditional)
	<p>Note:</p> <p>The Search (🔍) icon appears corresponding to the Person ID field. On clicking the Search icon, the Person Search window appears.</p> <p>On specifying the person, the concatenated string of information about the person appears below the Person ID field.</p>	<p>Note: This field is required while associating a person to an account.</p>
Person Name	Displays the name of the person.	Not applicable
Main Customer	Used to indicate whether the associated person is the main customer of the account.	No
Financially Responsible	Used to indicate whether the associated person is financially responsible for the account's debt.	No
Account Relationship Type	Used to indicate the relationship of the associated person with the main account.	Yes (Conditional)
		<p>Note: This field is required while associating a person to an account.</p>

Note: By default, the details of the main customer appears in the **Persons** page. Click the **Add** (+) icon to associate a new person to the account.

- Enter the required details in the **Persons** page.
- Add the bill routing information of the person in the **Bill Routing Information** section, if required.
- If you want to associate more than one person to the account, click the **Add** (+) icon and then repeat step 2.

Note: However, if you want to remove a person from the account, click the **Delete** (🗑️) icon.

- Click **Validate and Save**.

The person is added to the account.

Related Topics

For more information on...	See...
How to define a customer registration	Defining a Customer Registration on page 558
How to edit a customer registration	Editing the Customer Registration Details on page 626
How to copy a customer registration	Copying a Customer Registration on page 599
How to add an account for a person	Adding an Account for a Person on page 571
How to edit the account details of a person	Editing the Account Details of a Person on page 596

Adding the Bill Routing Information for an Account

Prerequisites

To add the bill routing information for an account, you should have:

- Bill formats, address sources, and bill route types defined in the application

Procedure

To add the bill routing information for an account:

1. Ensure that **Bill Routing Information** section is expanded in the **Persons** page when you are adding or editing the account of a person.

The **Bill Routing Information** section contains the following fields:

Field Name	Field Description	Mandatory (Yes or No)
Receives Copy of Bill	Used to indicate whether you want the person to receive a copy of the account's bill.	Yes (Conditional)
	Note: By default, the Receives Copy of Bill check box is selected if the person is the main customer of the account.	Note: This field is required while adding the bill routing information for an account.
Bill Format	Used to indicate the format in which you want the person to receive the account's bill. The valid values are: <ul style="list-style-type: none"> • Detailed • Summary 	Yes (Conditional)
	Note: By default, this field is disabled. It is enabled only when the Receives Copy of Bill check box is selected.	Note: This field is required while adding the bill routing information for an account.
Address Source	Used to indicate the address where you want to mail the account's bill. The valid values are: <ul style="list-style-type: none"> • Account Override • Main • Multiple Account Override • Person 	Yes (Conditional)
	Note: If you select the Address Source as Account Override , the Account Override Address section appears in the Persons page where you can add the account override address of the person.	Note: This field is required while adding the bill routing information for an account.
Number of Bill Copies	Used to specify the number of copies of the account's bill you want the person to receive.	Yes (Conditional)
	Note: By default, this field is disabled. It is enabled when the Receives Copy of Bill check box is selected.	Note: This field is required while adding the bill routing information for an account.

Field Name	Field Description	Mandatory (Yes or No)
Bill Route Type	Used to indicate how the account's bill is sent to the person.	Yes (Conditional)
	Note: By default, this field is disabled. It is enabled when the Receives Copy of Bill check box is selected.	Note: This field is required while adding the bill routing information for an account.
Receives Notification	Used to indicate whether you want the person to receive notifications about the account's bill.	Yes (Conditional)
	Note: By default, the Receives Notification check box is selected if the person is the main customer of the account.	Note: This field is required while adding the bill routing information for an account.

- Enter the required details in the **Bill Routing Information** section.
- If you want to add more than one bill routing information for the account, click the **Add (+)** icon and then repeat step 2.

Note: However, if you want to remove a bill routing information from the account, click the **Delete (🗑)** icon.

- Click **Validate and Save**.

The bill routing information is added for the account.

Related Topics

For more information on...	See...
How to define a customer registration	Defining a Customer Registration on page 558
How to edit a customer registration	Editing the Customer Registration Details on page 626
How to copy a customer registration	Copying a Customer Registration on page 599
How to add an account for a person	Adding an Account for a Person on page 571
How to edit the account details of a person	Editing the Account Details of a Person on page 596
How to associate a person to an account	Associating a Person to an Account on page 579

Defining a Characteristic for an Account

Prerequisites

To define a characteristic for an account, you should have:

- Characteristic types defined in the application (where the characteristic entity is set to **Account**)

Procedure

To define a characteristic for an account:

- Ensure that the **Characteristics** section is expanded in the **Account Characteristics** page when you are adding or editing the account of a person.

The **Characteristics** section contains the following columns:

Column Name	Column Description	Mandatory (Yes or No)
Effective Date	Used to specify the date from when the characteristic is effective for the account.	Yes (Conditional)
		Note: This field is required while defining a characteristic for an account.
Characteristic Type	Used to indicate the characteristic type.	Yes (Conditional)
		Note: This field is required while defining a characteristic for an account.
Characteristic Value	Used to specify the value for the characteristic type.	Yes (Conditional)
		Note: This field is required while defining a characteristic for an account.
	<p>Note:</p> <p>If you select a predefined characteristic type, the Search (🔍) icon appears corresponding to the Characteristic Value field. On clicking the Search icon, the Predefined Characteristic Search window appears.</p> <p>On specifying the value for a predefined characteristic type, the description of the characteristic value appears corresponding to the Characteristic Value field.</p>	

- Enter the required details in the **Characteristics** section.
- If you want to define more than one characteristic for the account, click the **Add** (+) icon and then repeat step 2.

Note: However, if you want to remove a characteristic from the account, click the **Delete** (🗑️) icon corresponding to the characteristic.

- Click **Validate and Save**.

The characteristic is defined for the account.

Related Topics

For more information on...	See...
How to define a customer registration	Defining a Customer Registration on page 558
How to edit a customer registration	Editing the Customer Registration Details on page 626
How to copy a customer registration	Copying a Customer Registration on page 599
How to add an account for a person	Adding an Account for a Person on page 571
How to edit the account details of a person	Editing the Account Details of a Person on page 596

Defining a Policy

Prerequisites

To define a policy, you should have:

- Policy types defined in the application.
- Source systems defined in the application.
- Policy person roles defined in the application.
- Characteristic types defined in the application (where the characteristic entity is set to **Policy**)

Procedure

To define a policy:

1. Ensure that the **Policies & Plans** section is expanded in the **Policies** page when you are defining, editing, or removing a policy from the person.

The **Policies & Plans** section contains the following columns:

Column Name	Column Description	Mandatory (Yes or No)
Sequence No.	Displays the sequence number of the policy.	Not applicable
Template	Indicates the policy template using which the policy is defined for the person.	Not applicable
Policy Type	Indicates the policy type using which the policy is defined for the person.	Not applicable
Policy Number	Displays the policy number.	Not applicable
View / Edit	On clicking the View / Edit (✎) icon, you can view or edit the details of the policy.	Not applicable
Policy Plans	On clicking the Add (+) icon, you can add policy plans for the policy.	Not applicable

Note: No information appears in the above columns if a policy is not yet defined for the person.

2. Click the **Add New Policy** button in the **Policies & Plans** section.

The **Select Policy Type** screen appears. It contains the following field:

Field Name	Field Description	Mandatory (Yes or No)
Policy Type	Used to indicate the policy type using which you want to define a policy.	Yes
	Note: If you want to create a fully-insured group policy, you must select a policy type where the policy category is set to Fully-Insured Group or Fully-Insured Individual . However, if you want to create a self-funded policy, you must select a policy type where the policy category is set to Self-Funded .	

3. Select the required policy type from the **Policy Type** field.
4. Click **OK**.

The **Policy** screen appears. It contains the following sections:

- **Main** - Used to specify the basic details about the policy.
- **Persons** - Used to associate persons with the policy.

- **Characteristics** - Used to define the characteristics for the policy.

The **Main** section contains the following fields:

Field Name	Field Description	Mandatory (Yes or No)
Policy Type	Indicates the policy type using which you are defining the policy.	Not applicable
Policy Number	Used to specify the policy number.	Yes
Description	Used to specify the description for the policy.	Yes
Source System	Used to indicate the external system from where the policy is originated.	Yes
	Note: This field is enabled when you are defining a policy using a policy type where the policy category is set to Fully-Insured Group or Fully-Insured Individual .	
Start Date	Used to specify the date from when the policy is effective.	Yes
	Note: The policy start date cannot be later than the policy end date.	
End Date	Used to specify the date till when the policy is effective.	Yes
	Note: The policy end date cannot be earlier than the policy start date.	
Policy Person Role	Used to indicate the role of the person for whom you are defining the policy.	Yes

Note: The **Policies** page appears when you are defining, editing, or copying a customer registration which is created using the **C1-CustomerRegistrationHC** business object.

5. Enter the required details in the **Main** section.
6. Define characteristics for the policy in the **Characteristics** section, if required.
7. Associate persons to the policy in the **Persons** section, if required.
8. Click **Validate and Save**.

The policy is defined for the person.

Related Topics

For more information on...	See...
How to define a customer registration	Defining a Customer Registration on page 558
How to edit a customer registration	Editing the Customer Registration Details on page 626
How to copy a customer registration	Copying a Customer Registration on page 599
How to edit the policy details	Editing the Policy Details on page 603
How to define a characteristic for a policy	Defining a Characteristic for a Policy on page 588

For more information on...	See...
How to associate a person to a policy	Associating a Person to a Policy on page 586
How to add a plan in a policy	Adding a Plan in a Policy on page 589

Associating a Person to a Policy

Prerequisites

To associate a person to a policy, you should have:

- Policy person roles defined in the application

Procedure

To associate a person to a policy:

1. Ensure that the **Persons** section is expanded in the **Policy** screen when you are defining or editing a policy.

The **Persons** section contains the following columns:

Column Name	Column Description	Mandatory (Yes or No)
Person	Used to indicate the person that you want to associate to the policy.	Yes (Conditional)
	<p>Note:</p> <p>The Search (🔍) icon appears corresponding to the Person field. On clicking the Search icon, the Person Search window appears.</p> <p>On specifying the person, the concatenated string of information about the person appears corresponding to the Person field separated by a comma (,).</p>	<p>Note: This field is required when you are associating a person to the policy.</p>
Sequence	Used to specify the sequence number for the associated person.	Yes (Conditional)
		<p>Note: This field is required when you are associating a person to the policy.</p>
Policy Person Role	Used to indicate the role of the associated person in the policy.	Yes (Conditional)
		<p>Note: This field is required when you are associating a person to the policy.</p>

Column Name	Column Description	Mandatory (Yes or No)
Main Customer	Used to indicate whether the associated person is the main customer of the policy.	Yes (Conditional)
	<p>Note:</p> <p>At a time, only one person can be the main customer of the policy.</p> <p>You must select this option while associating a person who is the main customer of the policy.</p>	<p>Note: This field is required when you are associating a person to the policy.</p>
Start Date	Used to specify the date from when the person is associated to the policy.	Yes (Conditional)
	<p>Note:</p> <p>The start date cannot be later than the end date.</p> <p>The start date cannot be earlier than the policy start date and later than the policy end date.</p>	<p>Note: This field is required when you are associating a person to the policy.</p>
End Date	Used to specify the date till when the person is associated to the policy.	No
	<p>Note:</p> <p>The end date cannot be earlier than the start date.</p> <p>The end date cannot be earlier than the policy start date and later than the policy end date.</p>	

- Enter the required details in the **Persons** section.
- If you want to associate more than one person to the policy, click the **Add (+)** icon and then repeat step 2.

Note: However, if you want to remove a person from the person, click the **Delete (🗑)** icon corresponding to the person.

- Click **Validate and Save**.

The person is associated to the policy.

Related Topics

For more information on...	See...
How to define a customer registration	Defining a Customer Registration on page 558
How to edit a customer registration	Editing the Customer Registration Details on page 626
How to copy a customer registration	Copying a Customer Registration on page 599
How to define a policy	Defining a Policy on page 583
How to edit the policy details	Editing the Policy Details on page 603

Defining a Characteristic for a Policy

Prerequisites

To define a characteristic for a policy, you should have:

- Characteristic types defined in the application (where the characteristic entity is set to **Policy**)

Procedure

To define a characteristic for a policy:

1. Ensure that the **Characteristics** section is expanded in the **Policy** screen when you are defining or editing a policy.

The **Characteristics** section contains the following columns:

Column Name	Column Description	Mandatory (Yes or No)
Effective Date	Used to specify the date from when the characteristic is effective for the policy.	Yes (Conditional)
		Note: This field is required when defining a characteristic for the policy.
Characteristic Type	Used to indicate the characteristic type.	Yes (Conditional)
		Note: This field is required when defining a characteristic for the policy.
Characteristic Value	Used to specify the value for the characteristic type.	Yes (Conditional)
		Note: This field is required when defining a characteristic for the policy.
	<p>Note:</p> <p>If you select a predefined characteristic type, the Search (🔍) icon appears corresponding to the Characteristic Value field. On clicking the Search icon, the Predefined Characteristic Search window appears.</p> <p>On specifying the value for a predefined characteristic type, the description of the characteristic value appears corresponding to the Characteristic Value field.</p>	

2. Enter the required details in the **Characteristics** section.
3. If you want to define more than one characteristic for the policy, click the **Add** (+) icon and then repeat step 2.

Note: However, if you want to remove a characteristic from the policy, click the **Delete** (🗑️) icon corresponding to the characteristic.

4. Click **Validate and Save**.

The characteristic is defined for the policy.

Related Topics

For more information on...	See...
How to define a customer registration	Defining a Customer Registration on page 558
How to edit a customer registration	Editing the Customer Registration Details on page 626
How to copy a customer registration	Copying a Customer Registration on page 599
How to define a policy	Defining a Policy on page 583
How to edit the policy details	Editing the Policy Details on page 603

Adding a Plan in a Policy

Prerequisites

To add a plan in a policy, you should have:

- Policy plan templates defined in the application.
- Policy plan business objects defined in the application.
- Pricing rule types defined in the application.
- Characteristic types defined in the application (where the characteristic entity is set to **Policy Plan**)

Procedure

To add a plan in a policy:

1. Ensure that the **Policies & Plans** section is expanded in the **Policies** page when you are adding, editing, or removing a policy plan from a policy.
2. Click the **Add**  icon in the **Policy Plans** column corresponding to the policy in which you want to add a policy plan.

The following columns appear in the **Policies & Plans** section:

Column Name	Column Description	Mandatory (Yes or No)
Sequence No.	Displays the sequence number of the policy plan.	Not applicable
Template	Indicates the policy plan template using which the policy plan is added in the policy.	Not applicable
Plan Number	Displays the policy plan number.	Not applicable
Price Item	Displays the price item that is associated with the policy plan.	Not applicable
View / Edit	On clicking the View / Edit  icon, you can view or edit the details of the policy plan.	Not applicable

Note: No information appears in the above columns if a plan is not yet added in the policy.

3. Click the **Add New Plan** button in the **Policies & Plans** section.

The **Select Policy Plan Template** screen appears. It contains the following fields:

Field Name	Field Description	Mandatory (Yes or No)
Template	Used to indicate the template using which you want to define the policy plan for the policy.	Yes
	Note: By default, the Policy Plan - Healthcare option is selected.	
Business Object	Used to indicate the business object using which you want to define the policy plan for the policy.	Yes
	Note: By default, the Policy Plan option is selected.	

4. Select the required template and business object from the respective fields.
5. Click **OK**.

The **Plan** screen appears. It contains the following sections:

- **Main** - Used to specify the basic details about the policy plan.
- **Pricing Rule Types** - Used to associate the pricing rule types with the policy plan.
- **Characteristics** - Used to define the characteristics for the policy plan.

The **Main** section contains the following fields:

Field Name	Field Description	Mandatory (Yes or No)
Price Item	Used to indicate the price item which you want to directly associate with the policy plan.	Yes
	<p>Note:</p> <p>The Search (🔍) icon appears corresponding to the Price Item field. On clicking the Search icon, the Price Item Search window appears.</p> <p>On the specifying the price item, the concatenated string of information about the price item appears corresponding to the Price Item field separated by a comma (,).</p>	
Plan Number	Used to specify the policy plan number.	Yes
Plan Name	Used to specify the description for the policy plan.	No

Field Name	Field Description	Mandatory (Yes or No)
Start Date	Used to specify the date from when the policy plan is effective for the policy.	Yes
	Note: The policy plan start date cannot be earlier than the policy start date and later than the policy end date. The policy plan start date cannot be later than the policy plan end date.	
End Date	Used to specify the date till when the policy plan is effective for the policy.	No
	Note: The policy plan end date cannot be earlier than the policy start date and later than the policy end date. The policy plan end date cannot be earlier than the policy plan start date.	

6. Enter the required details in the **Main** section.
7. Associate the pricing rule types with the policy plan in the **Pricing Rule Types** section, if required.
8. Define the characteristics for the policy plan in the **Characteristics** section, if required.
9. Click **Validate and Save**.

The policy plan is added in the policy.

Related Topics

For more information on...	See...
How to define a customer registration	Defining a Customer Registration on page 558
How to edit a customer registration	Editing the Customer Registration Details on page 626
How to copy a customer registration	Copying a Customer Registration on page 599
How to define a policy	Defining a Policy on page 583
How to edit the policy details	Editing the Policy Details on page 603
How to associate a pricing rule type with a policy plan	Associating a Pricing Rule Type with a Policy Plan on page 591
How to define a characteristic for a policy plan	Defining a Characteristic for a Policy Plan on page 592

Associating a Pricing Rule Type with a Policy Plan

Prerequisites

To associate a pricing rule type with a policy plan, you should have:

- Pricing rule types defined in the application.

Procedure

To associate a pricing rule type with a policy plan:

1. Ensure that the **Pricing Rule Types** section is expanded in the **Plan** screen when you are adding or editing a policy plan of a policy.

The **Pricing Rule Types** section contains the following field in a grid:

Field Name	Field Description	Mandatory (Yes or No)
Pricing Rule Type	Used to indicate the pricing rule type that you want to associate with the policy plan.	Yes (Conditional)
	<p>Note:</p> <p>The Search (🔍) icon appears corresponding to the Pricing Rule Type field. On clicking the Search icon, the Pricing Rule Type Search window appears.</p> <p>On specifying the pricing rule type, the description of the pricing rule type appears corresponding to the Pricing Rule Type field.</p>	<p>Note: This field is required while associating a pricing rule type with the policy plan.</p>

2. Enter the required details in the **Pricing Rule Types** section.
3. If you want to associate more than one pricing rule type with the policy plan, click the **Add** (+) icon and then repeat step 2.

Note: However, if you want to remove a pricing rule type from the policy plan, click the **Delete** (🗑️) icon corresponding to the pricing rule type.

4. Click **Validate and Save**.

The pricing rule type is associated with the policy plan.

Related Topics

For more information on...	See...
How to define a customer registration	Defining a Customer Registration on page 558
How to edit a customer registration	Editing the Customer Registration Details on page 626
How to copy a customer registration	Copying a Customer Registration on page 599
How to define a policy	Defining a Policy on page 583
How to edit the policy details	Editing the Policy Details on page 603
How to add a policy plan in a policy	Adding a Plan in a Policy on page 589
How to edit the policy plan details	Editing the Policy Plan Details on page 606

Defining a Characteristic for a Policy Plan

Prerequisites

To define a characteristic for a policy plan, you should have:

- Characteristic types defined in the application (where the characteristic entity is set to **Policy Plan**)

Procedure

To define a characteristic for a policy plan:

1. Ensure that the **Characteristics** section is expanded in the **Plan** screen when you are adding or editing a policy plan of a policy.

The **Characteristics** section contains the following columns:

Column Name	Column Description	Mandatory (Yes or No)
Effective Date	Used to specify the date from when the characteristic is effective for the policy plan.	Yes (Conditional)
		Note: This field is required while defining a characteristic for the policy plan.
Characteristic Type	Used to indicate the characteristic type. Note: The list includes only those characteristic types where the characteristic entity is set to Customer Registration .	Yes (Conditional)
		Note: This field is required while defining a characteristic for the policy plan.
Characteristic Value	Used to specify the value for the characteristic type. Note: If you select a predefined characteristic type, the Search (🔍) icon appears corresponding to the Characteristic Value field. On clicking the Search icon, the Predefined Characteristic Search window appears. On specifying the value for a predefined characteristic type, the description of the characteristic value appears corresponding to the Characteristic Value field.	Yes (Conditional)
		Note: This field is required while defining a characteristic for the policy plan.

2. Enter the required details in the **Characteristics** section.
3. If you want to define more than one characteristic for the policy plan, click the **Add** (+) icon and then repeat step 2.

Note: However, if you want to remove a characteristic from the policy plan, click the **Delete** (🗑️) icon corresponding to the characteristic.

4. Click **Validate and Save**.

The characteristic is defined for the policy plan.

Related Topics

For more information on...	See...
How to define a customer registration	Defining a Customer Registration on page 558
How to edit a customer registration	Editing the Customer Registration Details on page 626
How to copy a customer registration	Copying a Customer Registration on page 599
How to define a policy	Defining a Policy on page 583
How to edit the policy details	Editing the Policy Details on page 603

For more information on...	See...
How to add a policy plan in a policy	Adding a Plan in a Policy on page 589
How to edit the policy plan details	Editing the Policy Plan Details on page 606

Defining a Characteristic for a Customer Registration

Prerequisites

To define a characteristic for a customer registration, you should have:

- Characteristic types defined in the application (where the characteristic entity is set to **Customer Registration**)

Procedure

To define a characteristic for a customer registration:

1. Ensure that the **Characteristics** section is expanded in the **Registration Characteristics** page when you are defining, editing, or copying a customer registration.

The **Characteristics** section contains the following columns:

Column Name	Column Description	Mandatory (Yes or No)
Effective Date	Used to specify the date from when the characteristic is effective for the customer registration.	Yes (Conditional)
		Note: This field is required while defining a characteristic for a customer registration.
Characteristic Type	Used to indicate the characteristic type.	Yes (Conditional)
		Note: The list includes only those characteristic types where the characteristic entity is set to Customer Registration . Note: This field is required while defining a characteristic for a customer registration.
Characteristic Value	Used to specify the value for the characteristic type.	Yes (Conditional)
		Note: This field is required while defining a characteristic for a customer registration. Note: If you select a predefined characteristic type, the Search (🔍) icon appears corresponding to the Characteristic Value field. On clicking the Search icon, the Predefined Characteristic Search window appears. On specifying the value for a predefined characteristic type, the description of the characteristic value appears corresponding to the Characteristic Value field.

2. Enter the required details in the **Characteristics** section.
3. If you want to define more than one characteristic for the customer registration, click the **Add** (+) icon and then repeat step 2.

Note: However, if you want to remove a characteristic from the customer registration, click the **Delete** (🗑️) icon corresponding to the characteristic.

4. Click **Validate and Save**.

The characteristic is defined for the customer registration.

Related Topics

For more information on...	See...
How to define a customer registration	Defining a Customer Registration on page 558
How to edit a customer registration	Editing the Customer Registration Details on page 626
How to copy a customer registration	Copying a Customer Registration on page 599

Viewing the Details of an Account

Procedure

To view the details of an account:

1. Search for the customer registration in the **Customer Registration** screen.
2. In the **Search Results** section, click the link in the **Customer Registration Information** column corresponding to the customer registration whose account details you want to view.

The **Main** tab appears in the **Customer Registration** screen.

3. Ensure that the **Account Information** zone is expanded in the **Main** tab.
4. Click the **View** () icon corresponding to the account whose details you want to view.

The **Account** tab appears.

5. View the details of the account in the **Account Information** zone.

Related Topics

For more information on...	See...
How to search for a customer registration	Searching for a Customer Registration on page 556
Customer Registration screen	Customer Registration (Used for Viewing) on page 608
Customer Registration - Main tab	Customer Registration - Main on page 609
Customer Registration - Account tab	Customer Registration - Account on page 618
Account Information zone	Account Information on page 618

Viewing the Details of a Statement Construct

Procedure

To view the details of a statement construct:

1. Search for the customer registration in the **Customer Registration** screen.
2. In the **Search Results** section, click the link in the **Customer Registration Information** column corresponding to the customer registration whose statement construct details you want to view.

The **Main** tab appears in the **Customer Registration** screen.

3. Ensure that the **Statement Construct** zone is expanded in the **Main** tab.
4. View the details of the statement construct in the **Statement Construct** zone.

Related Topics

For more information on...	See...
How to search for a customer registration	Searching for a Customer Registration on page 556
Customer Registration screen	Customer Registration (Used for Viewing) on page 608
Customer Registration - Main tab	Customer Registration - Main on page 609
Customer Registration - Account tab	Customer Registration - Account on page 618
Statement Construct zone	Statement Constructs on page 616

Editing the Account Details of a Person

Prerequisites

To edit the account details of a person, you should have:

- Customer class, divisions, currencies, access groups, accrual cycles, and bill cycles defined in the application
- Account identifier types defined in the application
- Auto pay source codes, auto pay methods, and auto pay route types defined in the application
- Account relationship types defined in the application
- Address sources, bill formats, and bill route types defined in the application
- Characteristic types defined in the application (where the characteristic entity is set to **Account**)
- Collection class defined in the application

Note: The collection class is required when you are defining a customer registration using the **C1-CustomerRegistrationBanking** business object.

Procedure

To edit the account details of a person:

1. Search for the customer registration in the **Customer Registration** screen.
2. In the **Search Results** section, click the link in the **Customer Registration Information** column corresponding to the customer registration whose account details you want to edit.
The **Main** tab appears in the **Customer Registration** screen.
3. Click the **Edit** button in the **Customer Registration** zone.
The **Main** page appears in the **Customer Registration** screen.
4. Ensure that the **Accounts** section is expanded in the **Accounts** page.
5. Click the **Edit** (✎) icon in the **View / Edit** column corresponding to the account whose details you want to edit.

The **Customer Registration - Add Account** screen appears. It contains the following pages:

- **Main** - Used to specify basic information about the account.
- **Auto Pay** - Used to add the automatic payment details of the account.
- **Persons** - Used to associate a person to the account.
- **Account Characteristics** - Used to define a list of characteristics for the account.
- **Credit Ratings** - Used to add the credit rating details for the account.

Note: This page appears when you are defining a customer registration using the **C1-CustomerRegistrationBanking** business object.

The **Main** page contains the following sections:

- **Main** - Used to specify basic details about the account.
- **Account Identifiers** - Used to add the identifier details for the account.

The **Main** section contains the following fields:

Field Name	Field Description	Mandatory (Yes or No)
Customer Class	Used to indicate the customer class to which the account belongs.	Yes
Division	Used to indicate the division to which the account belongs. Note: You can only view those divisions to which you have access in the Division list.	Yes
Set Up Date	Displays the date from when the account is configured for the person.	Not applicable
Invoice Currency	Used to indicate the currency which you want to use for generating the invoice of the account. Note: The list includes only those currencies which are defined in the system.	Yes
Account Category	Displays the category to which the account belongs. The valid values are: <ul style="list-style-type: none"> • Invoice Account • Settlement Account • Usage Account Note: The list includes only those values which are present in the ACCT_USAGE_FLG lookup field.	Not applicable
Access Group	Used to indicate the user group that can access the account for the person. Note: The Search (🔍) icon appears corresponding to the Access Group field. On clicking the Search icon, the Access Group Search window appears. On specifying the access group, the description of the access group appears corresponding to the Access Group field.	Yes

Field Name	Field Description	Mandatory (Yes or No)
Exclude Accrual	Used to indicate whether the account is eligible for accrual.	No
	Note: By default, the account is eligible for accrual if the division to which the account belongs is eligible for accrual. If you do not want the account to be eligible for accrual, you must select the Exclude Accrual check box. On selecting the Exclude Accrual check box, the Accrual Cycle field is disabled.	
Accrual Cycle	Used to indicate the accrual cycle of the account in the division.	No
	Note: The Search (🔍) icon appears corresponding to the Accrual Cycle field. On clicking the Search icon, the Accrual Cycle Search for Cust Reg window appears. On specifying the accrual cycle, the description of the accrual cycle appears corresponding to the Accrual Cycle field. This field is disabled when you click the Exclude Accrual check box.	
Product	Used to indicate the product for which the account is enrolled.	Yes (Conditional)
	Note: The Search (🔍) icon appears corresponding to the Product field. On clicking the Search icon, the Search Product window appears.	
Eligible for Repricing	Used to indicate whether the account is eligible for repricing when the account attributes (defined as parameters in the system) are changed.	No
	Note: Only accounts where the person and child person are the main customers are considered for repricing. The system creates the repricing request for the account irrespective of whether the account is eligible for repricing or not.	
Bill Cycle	Used to indicate the bill cycle for the account.	No

Field Name	Field Description	Mandatory (Yes or No)
Bill Lead Days	Used to specify the number of days which is used to derive the cut-off date for advance billing.	Yes
	Note: In case you don't want to bill the account in advance, you must specify 0 in this field.	
Comments	Used to specify additional information about the account.	No

6. Modify the required details of the account in the **Main** page.
7. Add, edit, or remove the identifier details of the account in the **Account Identifiers** section.
8. Add, edit, or remove the automatic payment details of the account in the **Auto Pay** page, if required.
9. Associate or disassociate persons from the account in the **Persons** page, if required.
10. Define, edit, or remove characteristics of the account in the **Account Characteristics** page, if required.
11. Add, edit, or remove the credit rating details of the account in the **Credit Ratings** page, if required.
12. Click **Validate and Save**.

The changes made to the account are saved.

Related Topics

For more information on...	See...
How to search for a customer registration	Searching for a Customer Registration on page 556
Customer Registration screen	Customer Registration (Used for Viewing) on page 608
Customer Registration zone	Customer Registration on page 609
How to add an account for a person	Adding an Account for a Person on page 571
How to add the identifier details of an account	Adding the Identifier Details of an Account on page 575
How to add the automatic payment details of an account	Adding the Automatic Payment Details of an Account on page 576
How to associate a person to an account	Associating a Person to an Account on page 579
How to define a characteristic for an account	Defining a Characteristic for an Account on page 582
How to add the credit rating details for an account	Adding the Credit Rating Details for an Account

Copying a Customer Registration

Instead of creating a customer registration from scratch, you can create a new customer registration using an existing customer registration. This is possible through copying a customer registration. On copying a customer registration, the details including the characteristics are copied to the new customer registration. You can then edit the details, if required.

Prerequisites

To copy a customer registration, you should have:

- Customer registration (whose copy you want to create) defined in the application
- Divisions, customer segments, customer tiers, and access groups defined in the application
- Name types, phone types, and person identifier types defined in the application

- Address type codes and countries defined in the application
- Characteristic Types defined in the application
- Relationship types defined in the application
- Customer class, invoice currencies, account categories, bill cycles, accrual cycles, account identifier types, auto pay source codes, auto pay methods, auto pay route types, account relationship types, bill formats, address sources, bill route types, and collection class defined in the application

Note: The collection class is required when you are copying a customer registration which is created using the **C1-CustomerRegistrationBanking** business object.

- Deal review frequencies and currency codes defined in the application

Note: These prerequisites are required when you are copying a customer registration which is created using the **C1-CustomerRegistrationBanking** business object.

- Policy types and policy person roles defined in the application.

Note: These prerequisites are required when you are copying a customer registration which is created using the **C1-CustomerRegistrationHC** business object.

Procedure

To copy a customer registration:

1. Search for the customer registration in the **Customer Registration** screen.
2. Click the **Copy** () icon in the **Copy** column corresponding to the customer registration whose copy you want to create.

The **Customer Registration** screen appears. It contains the following pages:

- **Main** - Used to specify basic information about the person.
- **Contact** - Used to specify the contact information about the person.
- **Person Characteristics** - Used to define a list of characteristics for the person.
- **Hierarchy** - Used to define the person to person relationship for the person
- **Accounts** - Used to add the account details of the person.
- **Deal** - Used to specify information about the deals created for the person.

Note: This page appears only when you are defining a customer registration using the **C1-CustomerRegistrationBanking** business object.

- **Policies** - Used to specify the policy details of the person.

Note: This page appears when you are defining a customer registration using the **C1-CustomerRegistrationHC** business object.

- **Registration Characteristics** - Used to define a list of characteristics for the customer registration.

The **Main** page contains the following sections:

- **Main** - Used to specify basic details about the person.
- **Person Name** - Used to add the person names for customer registration.
- **Person Phones** - Used to add the person phone details for customer registration.
- **Person IDs** - Used to add the person identifiers for customer registration.

The **Main** section contains the following fields:

Field Name	Field Description	Mandatory (Yes or No)
Person Type	Indicates the person type using which you want to define the customer registration for the person.	Not applicable
Date of Birth	Used to specify the date when the person was born.	No
Division	Used to indicate the division to which the person belongs.	Not applicable
Person Since Date	Used to specify the date from when the person is the main customer.	No
Customer Segment	Used to indicate the customer segment to which the person belongs.	No
	Note: This field appears when you are defining a customer registration using the C1-CustomerRegistrationBanking business object.	
Customer Tier	Used to indicate the customer tier of the customer segment to which the person belongs.	No
	Note: This field appears when you are defining a customer registration using the C1-CustomerRegistrationBanking business object.	
Access Group	Used to indicate the user group that can access the customer registration.	No
	Note: The Search (🔍) icon appears corresponding to the Access Group field. On clicking the Search icon, the Access Group Search window appears.	

3. Enter the required details in the **Main** section.
4. Add or remove the names of the person in the **Person Names** section.
5. Add or remove the phone details for the person in the **Person Phones** section.
6. Add, edit, or remove the identifier details for the person in the **Person IDs** section.
7. Define, edit, or remove the addresses of the person in the **Contact** page, if required.
8. Define, edit, or remove characteristics of the person in the **Person Characteristics** page, if required.
9. Define, edit, or remove the person to person relationship for the person in the **Hierarchy** page, if required.
10. Add, edit, or remove the account details of the person in the **Accounts** page, if required.
11. Add, edit, or remove information about the deals created for the person in the **Deal** page, if required.

Note: This page appears when you are defining a customer registration using the **C1-CustomerRegistrationBanking** business object.

12. Add, edit, or remove the policy details of the person in the **Policies** page, if required.

Note: This page appears when you are defining a customer registration using the **C1-CustomerRegistrationHC** business object.

13. Define, edit, or remove characteristics of the customer registration in the **Registration Characteristics** page, if required.

14. Click **Validate and Save**.

The new customer registration is defined.

Related Topics

For more information on...	See...
How to search for a customer registration	Searching for a Customer Registration on page 556
Search Customer Registration zone	Search Customer Registration on page 546
How to add name of a person for customer registration	Adding the Names of a Person on page 561
How to add the phone details of a person for customer registration	Adding the Phone Details of a Person on page 562
How to add the identifier details of a person for customer registration	Adding the Identifier Details of a Person on page 563
How to add the contact details of a person for customer registration	Adding the Contact Details of a Person on page 564
How to define a characteristic for a person	Defining a Characteristic for a Person on page 567
How to define the hierarchy of a person	Defining a Person to Person Relationship for a Person on page 568
How to add an account for a person	Adding an Account for a Person on page 571
How to add a deal information for a person	Adding the Deal Information for a Person
How to add a policy for a person	Defining a Policy on page 583
How to define a characteristic for a customer registration	Defining a Characteristic for a Customer Registration on page 594

Viewing the Parent Policies

Procedure

To view the parent policies:

1. Search for the customer registration in the **Customer Registration** screen.
2. In the **Search Results** section, click the link in the **Customer Registration Information** column corresponding to the customer registration whose parent policies you want to view.

The **Main** tab appears in the **Customer Registration** screen.

3. Ensure that the **Parent Policies** zone is expanded in the **Main** tab.
4. View the parent policies in the **Parent Policies** zone.

Related Topics

For more information on...	See...
How to search for a customer registration	Searching for a Customer Registration on page 556
Customer Registration screen	Customer Registration (Used for Viewing) on page 608
Customer Registration - Main tab	Customer Registration - Main on page 609
Parent Policies zone	Parent Policies on page 617

Viewing the Details of a Policy

Procedure

To view the details of a policy:

1. Search for the customer registration in the **Customer Registration** screen.
2. In the **Search Results** section, click the link in the **Customer Registration Information** column corresponding to the customer registration whose policy details you want to view.

The **Main** tab appears in the **Customer Registration** screen.

3. Ensure that the **Policies** zone is expanded in the **Main** tab.
4. Click the **View** () icon corresponding to the policy whose details you want to view.

The **Policy** tab appears in the **Customer Registration** screen.

5. View the details of the policy in the **Policy Information** zone.

Related Topics

For more information on...	See...
How to search for a customer registration	Searching for a Customer Registration on page 556
Customer Registration screen	Customer Registration (Used for Viewing) on page 608
Customer Registration - Main tab	Customer Registration - Main on page 609
Policies zone	Policies on page 617
Customer Registration - Policy tab	Customer Registration - Policy on page 622
Policy Information zone	Policy Information on page 622

Editing the Policy Details

Prerequisites

To edit the policy details, you should have:

- Source systems defined in the application.
- Policy person roles defined in the application.
- Characteristic types defined in the application (where the characteristic entity is set to **Policy**)

Procedure

To edit the policy details:

1. Search for the customer registration in the **Customer Registration** screen.

- In the **Search Results** section, click the link in the **Customer Registration Information** column corresponding to the customer registration whose policy details you want to edit.

The **Main** tab appears in the **Customer Registration** screen.

- Click the **Edit** button in the **Customer Registration** zone.

The **Main** page appears in the **Customer Registration** screen.

- Ensure that the **Policies & Plans** section is expanded in the **Policies** page.

- Click the **Edit**() icon in the **View / Edit** column corresponding to the policy whose details you want to edit.

The **Policy** screen appears. It contains the following sections:

- **Main** - Used to specify the basic details about the policy.
- **Persons** - Used to associate persons with the policy.
- **Characteristics** - Used to define the characteristics for the policy.

The **Main** section contains the following fields:

Field Name	Field Description	Mandatory (Yes or No)
Policy Type	Indicates the policy type using which the policy is defined in the system.	Not applicable
Policy Number	Used to specify the policy number.	Yes
Description	Used to specify the description for the policy.	Yes
Source System	Used to indicate the external system from where the policy is originated. Note: This field is enabled when you are defining a policy using a policy type where the policy category is set to Fully-Insured Group or Fully-Insured Individual .	Yes
Start Date	Used to specify the date from when the policy is effective. Note: The policy start date cannot be later than the policy end date.	Yes
End Date	Used to specify the date till when the policy is effective. Note: The policy end date cannot be earlier than the policy start date.	Yes
Policy Person Role	Used to indicate the role of the person for whom you are defining the policy.	Yes

Note: The **Policies** page appears when you are defining, editing, or copying a customer registration which is created using the **C1-CustomerRegistrationHC** business object.

- Modify the required details in the **Main** section.
- Define, edit, or remove characteristics of the policy in the **Characteristics** section, if required.
- Associate or disassociate persons from the policy in the **Persons** section, if required.

9. Click **Validate and Save**.

The changes made to the policy are saved.

Related Topics

For more information on...	See...
How to search for a customer registration	Searching for a Customer Registration on page 556
Customer Registration screen	Customer Registration (Used for Viewing) on page 608
Customer Registration zone	Customer Registration on page 609
How to define a policy	Defining a Policy on page 583
How to define a characteristic for a policy	Defining a Characteristic for a Policy on page 588
How to associate a person to a policy	Associating a Person to a Policy on page 586
How to add a plan in a policy	Adding a Plan in a Policy on page 589

Viewing the Details of a Policy Plan

Procedure

To view the details of a policy plan:

1. Search for the customer registration in the **Customer Registration** screen.
2. In the **Search Results** section, click the link in the **Customer Registration Information** column corresponding to the customer registration whose policy plan details you want to view.
The **Main** tab appears in the **Customer Registration** screen.
3. Ensure that the **Policies** zone is expanded in the **Main** tab.
4. Click the **View** (🔗) icon corresponding to the policy whose policy plan details you want to view.
The **Policy** tab appears in the **Customer Registration** screen.
5. Ensure that the **Plans** zone is expanded in the **Policy** tab.
6. Click the **View** (🔗) icon corresponding to the policy plan whose details you want to view.
The **Plan Information** tab appears in the **Customer Registration** screen.
7. View the details of the policy plan in the **Plan Information** zone.

Related Topics

For more information on...	See...
How to search for a customer registration	Searching for a Customer Registration on page 556
Customer Registration screen	Customer Registration (Used for Viewing) on page 608
Customer Registration - Main tab	Customer Registration - Main on page 609
Policies zone	Policies on page 617
Customer Registration - Policy tab	Customer Registration - Policy on page 622
Plans zone	Plans on page 623
Plan Information tab	Customer Registration - Plan Information on page 624
Plan Information zone	Plan Information on page 624

Editing the Policy Plan Details

Prerequisites

To edit the policy plan details, you should have:

- Pricing rule types defined in the application.
- Characteristic types defined in the application (where the characteristic entity is set to **Policy Plan**)

Procedure

To edit the policy plan details:

1. Search for the customer registration in the **Customer Registration** screen.
2. In the **Search Results** section, click the link in the **Customer Registration Information** column corresponding to the customer registration whose policy plan details you want to edit.

The **Main** page appears in the **Customer Registration** screen.

3. Ensure that the **Policies & Plans** section is expanded in the **Policies** page.
4. Click the **Add**  icon in the **Policy Plans** column corresponding to the policy whose plan details you want to edit.

The following columns appear in the **Policies & Plans** section:

Column Name	Column Description	Mandatory (Yes or No)
Sequence No.	Displays the sequence number of the policy plan.	Not applicable
Template	Indicates the policy plan template using which the policy is added in the policy.	Not applicable
Plan Number	Displays the policy plan number.	Not applicable
Price Item	Displays the price item that is associated with the policy plan.	Not applicable
View / Edit	On clicking the View / Edit  icon, you can view or edit the details of the policy plan.	Not applicable

Note: No information appears in the above columns if a plan is not yet added in the policy.

5. Click the **Edit**  icon in the **View / Edit** column corresponding to the policy plan whose details you want to edit.

The **Plan** screen appears. It contains the following sections:

- **Main** - Used to specify the basic details about the policy plan.
- **Pricing Rule Types** - Used to associate the pricing rule types with the policy plan.
- **Characteristics** - Used to define the characteristics for the policy plan.

The **Main** section contains the following fields:

Field Name	Field Description	Mandatory (Yes or No)
Price Item	Used to indicate the price item which you want to directly associate with the policy plan.	Yes
	<p>Note:</p> <p>The Search (🔍) icon appears corresponding to the Price Item field. On clicking the Search icon, the Price Item Search window appears.</p> <p>On the specifying the price item, the concatenated string of information about the price item appears corresponding to the Price Item field separated by a comma (,).</p>	
Plan Number	Used to specify the policy plan number.	Yes
Plan Name	Used to specify the description for the policy plan.	No
Start Date	Used to specify the date from when the policy plan is effective for the policy.	Yes
	<p>Note:</p> <p>The policy plan start date cannot be earlier than the policy start date and later than the policy end date.</p> <p>The policy plan start date cannot be later than the policy plan end date.</p>	
End Date	Used to specify the date till when the policy plan is effective for the policy.	No
	<p>Note:</p> <p>The policy plan end date cannot be earlier than the policy start date and later than the policy end date.</p> <p>The policy plan end date cannot be earlier than the policy plan start date.</p>	

6. Modify the required details in the **Main** section.
7. Associate or disassociate pricing rule types from the policy plan in the **Pricing Rule Types** section, if required.
8. Define, edit, or remove characteristics of the policy plan in the **Characteristics** section, if required.
9. Click **Validate and Save**.

The changes made to the policy plan are saved.

Related Topics

For more information on...	See...
How to search for a customer registration	Searching for a Customer Registration on page 556
Customer Registration screen	Customer Registration (Used for Viewing) on page 608
Customer Registration zone	Customer Registration on page 609
How to define a policy	Defining a Policy on page 583
How to add a plan in a policy	Adding a Plan in a Policy on page 589
How to associate a pricing rule type with a policy plan	Associating a Pricing Rule Type with a Policy Plan on page 591
How to define a characteristic for a policy plan	Defining a Characteristic for a Policy Plan on page 592

Customer Registration (Used for Viewing)

The **Customer Registration** screen allows you to:

- Define a customer registration
- View the details of a customer registration
- Edit the details of a customer registration
- Delete a customer registration
- Submit a customer registration for processing
- Approve or reject a customer registration
- Request the submitter to resubmit a customer registration for approval
- View the log of a customer registration
- Add a log entry for a customer registration

It contains the following tabs:

- [Customer Registration - Main](#) on page 609
- [Customer Registration - Account](#) on page 618
- [Customer Registration - Policy](#) on page 622

Note: This tab appears when the customer registration is created using the **C1-CustomerRegistrationHC** business object.

- [Customer Registration - Plan Information](#) on page 624

Note: This tab appears when the customer registration is created using the **C1-CustomerRegistrationHC** business object.

- [Customer Registration - Log](#) on page 625

For more information on...	See...
How to define a customer registration	Defining a Customer Registration on page 558
How to view the details of a customer registration	Viewing the Customer Registration Details on page 557
How to edit a customer registration	Editing the Customer Registration Details on page 626
How to delete a customer registration	Deleting a Customer Registration

For more information on...	See...
How to submit a customer registration	Submitting a Customer Registration on page 629
How to approve a customer registration	Approving a Customer Registration on page 629
How to reject a customer registration	Rejecting a Customer Registration on page 630
How to request to resubmit a customer registration for approval	Requesting to Resubmit a Customer Registration for Approval on page 632
How to view the log of a customer registration	Viewing the Log of a Customer Registration on page 633
How to add a log entry for a customer registration	Adding a Log Entry for a Customer Registration on page 634

Customer Registration - Main

The **Main** tab displays information about the customer registration. It also displays information about the accounts, policies, and parent policies of the person in a customer registration. It contains the following zones:

- [Customer Registration](#) on page 609
- [Bill Group Information](#) on page 614

Note: This zone appears when the customer registration is created using the **C1-CustomerRegistrationHC** business object.

- [Account Information](#) on page 618
- [Statement Constructs](#) on page 616
- [Policies](#) on page 617

Note: This zone appears when the customer registration is created using the **C1-CustomerRegistrationHC** business object.

- [Parent Policies](#) on page 617

Note: This zone appears when the customer registration is created using the **C1-CustomerRegistrationHC** business object.

Customer Registration

The **Customer Registration** zone displays the details of the customer registration. It contains of the following sections:

- **Main** - Displays the basic information about the customer registration. It contains the following fields:

Field Name	Field Description
Customer Registration Information	Displays the concatenated string of information about the customer registration separated by a comma (.).
Customer Registration Type	Indicates the customer registration type using which the customer registration is defined in the system.

Field Name	Field Description
Status	<p>Indicates the status of the customer registration. The valid values are:</p> <ul style="list-style-type: none"> • Approval in Progress • Bill Group Approved <div style="border: 1px solid black; padding: 5px; margin: 5px 0;"> <p>Note: This status appears when you are viewing the details of a customer registration which is created using the C1-CustomerRegistrationHC business object.</p> </div> <ul style="list-style-type: none"> • Complete • Draft • Draft For Update • Parent Customer Approved <div style="border: 1px solid black; padding: 5px; margin: 5px 0;"> <p>Note: This status appears only when you are viewing the details of a customer registration which is created using the C1-CustomerRegistrationHC business object.</p> </div> <ul style="list-style-type: none"> • Pending Final Approval <div style="border: 1px solid black; padding: 5px; margin: 5px 0;"> <p>Note: This status appears when you are viewing the details of a customer registration which is created using the C1-CustomerRegistrationHC business object.</p> </div> <ul style="list-style-type: none"> • Pending Pricing Correction <div style="border: 1px solid black; padding: 5px; margin: 5px 0;"> <p>Note: This status appears only when you are viewing the details of a customer registration which is created using the C1-CustomerRegistrationHC business object.</p> </div> <ul style="list-style-type: none"> • Rejected
Source System	Indicates the external system from where the customer registration information is received.
Person Information	<p>Displays the concatenated string of information about the main customer for whom the customer registration is created in the system. In addition, a context menu appears corresponding to this field which helps in navigating to other screens in the application.</p> <div style="border: 1px solid black; padding: 5px; margin-top: 5px;"> <p>Note: It has a link. On clicking the link, the Person screen appears where you can view the details of the respective person.</p> </div>
Registration Source	<p>Indicates the source through which the customer registration is created using the customer registration type. The valid values are:</p> <ul style="list-style-type: none"> • File Upload • Inbound Message • Manual
Registration Source ID	Displays the source ID of the customer registration.

- **Record Actions** - The **Record Actions** section contains the following buttons:

Button Name	Button Description
Edit	Used to edit the details of the customer registration.
Delete	Used to delete the customer registration.
Submit	Used to submit the customer registration for validation and processing.
Duplicate	Used to create a new customer registration using an existing customer registration.
Approve	Used to approve the customer registration.
Reject	Used to reject the customer registration.
Return To Submitter	Used to request the submitter to resubmit the customer registration for approval.

- **Record Information** - The **Record Information** section contains the following fields:

Field Name	Field Description
Business Object	Indicates the business object using which the customer registration is created. In addition, a context menu appears corresponding to this field which helps in navigating to other screens in the application. Note: It has a link. On clicking the link, the Business Object screen appears where you can view the details of the respective business object.
Status Date/Time	Displays the date and time when the customer registration status is updated.
Create Date/Time	Displays the date and time when the customer registration is created.

- **Person Details** - Displays information about the main customer for whom the customer registration is created in the system. It contains the following fields:

Field Name	Field Description
Person Type	Indicates the person type of the main customer for whom the customer registration is defined in the system.
Date of Birth	Displays the date when the person was born.
Division	Indicates the division to which person belongs.
Person Since Date	Displays specify the date from when the person is the main customer.
Access Group	Indicates the user group that can access the customer registration. Note: It has a link. On clicking the link, the Access Group screen appears where you can view the details of the respective access group.

In addition, the **Person Details** section contains the following sub-sections:

- **Person Names** - Lists the primary and non-primary names of the person. It contains the following columns:

Column Name	Column Description
Name Type	Indicates the type of the name.
Name	Displays the name of the person.

- **Person Characteristics** - Lists the characteristics defined for the person. It contains the following columns:

Column Name	Column Description
Effective Date	Indicates the date from when the characteristic is effective for the person.
Characteristic Type	Indicates the characteristic type.
Characteristic value	Displays the value for the characteristic type.

- **Person Phones** - Lists the phone details of the person. It contains the following columns:

Column Name	Column Description
Phone Type	Indicates the type of the phone. The valid values are: <ul style="list-style-type: none"> • Business • Business Phone • Fax • Home • Mobile
Phone Number	Displays the phone number.
Extension	Displays the extension value of the phone number.
Phone Format	Displays the format in which the phone number is specified for the person.

- **Person IDs** - Lists the identifier details of the person. It contains the following columns:

Column Name	Column Description
Primary ID	Indicates whether the person identifier is primary or not.
Person Identifier Type	Indicates the identifier type of the person.
Person Identifier	Displays the value of the person identifier type.

- **Person Addresses** - Displays the contact information of the person. It contains the following fields:

Field Name	Field Description
Address Type	Indicates the type of the address.
Effective Date	Displays the date from when the address is effective for the person.
Country	Indicates the country where the person is located.
Address 1	Displays the first line of the address. It may contain details, such as house number and apartment name.
Address 2	Displays the second line of the address. It may contain details, such as street name.
City	Displays the city name.
Address 3	Displays the third line of the address. It may contain the landmark details.
County	Displays the county name.

Field Name	Field Description
State	Indicates the state where the city or county is located.
Province	Displays the location within the country where the person is located.
Address 4	Displays the fourth line of the address.
Postal	Displays the postal or zip code of the address.
House Type	Indicates the type of the house.
In City Limit	Indicates whether the address is within the city limit. The valid values are: <ul style="list-style-type: none"> • Yes • No
Geographic Code	Displays the geographic code of the address.

Note:

The above mentioned fields appear in the **Person Addresses** section when the respective data is available for the person.

Also, the labels of the address fields will change depending on the business label which is defined for the respective address field in the **Country** screen.

- **Override Mailing Name** - Lists the overriding mailing names for the person. It contains the following columns:

Column Name	Column Description
Override Mailing Name - Name1	Displays the name using which you want to override the person's mailing name.
Override Mailing Name - Name2	Displays the name using which you want to override the person's override mailing name 1.
Override Mailing Name - Name3	Displays the name using which you want to override the person's override mailing name 2.
Email Address	Displays the email address of the person.

- **Related Person Information** - Lists the persons that are related to the main customer. It contains the following columns:

Column Name	Column Description
Related Person Information	Displays the concatenated string of information about the related person separated by a comma (.). In addition, a context menu appears corresponding to this field which helps in navigating to other screens in the application. <div style="border: 1px solid black; padding: 5px; margin-top: 10px;"> <p>Note: It has a link. On clicking the link, the Person Information screen appears where you can view the details of the respective person.</p> </div>

Column Name	Column Description
Parent/Child	Indicates whether the related person is a parent or a child. The valid values are: <ul style="list-style-type: none"> • Parent • Child
Relationship Type	Indicates the person to person relationship type.
Start Date	Indicates indicate the date from when the person to person relationship is effective.
End Date	Indicates the date till when the person to person relationship is effective.
Financial Relationship	Indicates whether the related person is financially responsible or not.
Characteristics	On clicking the Add  icon, you can view the list of characteristics of the related person.

- **Registration Characteristics** - Lists the characteristics of the customer registration. It contains the following columns:

Column Name	Column Description
Effective Date	Indicates the date from when the characteristic is effective for the customer registration.
Characteristic Type	Indicates the characteristic type.
Characteristic value	Displays the value for the characteristic type.

Related Topics

For more information on...	See...
How to define a customer registration	Defining a Customer Registration on page 558
How to edit a customer registration	Editing the Customer Registration Details on page 626
How to copy a customer registration	Copying a Customer Registration on page 599
How to delete a customer registration	Deleting a Customer Registration
How to view the details of a customer registration	Viewing the Customer Registration Details on page 557

Bill Group Information

The **Bill Group Information** zone lists the bill groups that are defined for the person where the person is the parent customer. It contains of the following columns:

Column Name	Column Description
Customer Registration Information	Displays the concatenated string of information about the bill group in a customer registration which is defined for the person. Note: It has a link. On clicking the link, the Customer Registration screen appears where you can view the details of the respective bill group.
Name	Displays the primary name of the bill group.

Column Name	Column Description
Relationship Type	Indicates the relationship type using which the bill group is defined for the person.
Status	Indicates the status of the bill group.

Note:

The **Bill Group Information** zone appears when you are viewing the details of a customer registration which is created using the **C1-CustomerRegistrationHC** business object and if a bill group is defined for the person where the person type is set to **Parent Customer**.

Pagination is used to display limited number of records in this zone. You can use the navigation links, such as **Previous** and **Next** to navigate between pages.

Related Topics

For more information on...	See...
How to view the details of a customer registration	Viewing the Customer Registration Details on page 557

Account Information

The **Account Information** zone lists the accounts added for the person in the customer registration. It contains of the following columns:

Column Name	Column Description
Sequence	Displays the sequence number of the account.
Template	Indicates the account template using which the account is added for the person.
Customer Class	Indicates the customer class to which the account belongs.
Division	Indicates the division to which the account belongs.
Primary Identifier Type	Indicates the primary identifier type using which the account is added for the person.
Identifier Value	Displays the value of the primary identifier type.

On clicking the **View** () icon corresponding to an account, the **Account** tab appears where you can view the details of the respective account.

Note:

No information appears in the **Account Information** zone if an account is not yet added for the person.

Pagination is used to display limited number of records in this zone. You can use the navigation links, such as **Previous** and **Next** to navigate between pages.

Related Topics

For more information on...	See...
How to add an account for a person	Adding an Account for a Person on page 571
How to view the details of an account	Viewing the Details of an Account on page 595

For more information on...	See...
How to view the details of a customer registration	Viewing the Customer Registration Details on page 557

Statement Constructs

The **Statement Constructs** zone lists the statement constructs added for the person in the customer registration. It contains of the following columns:

Column Name	Column Description
Person Identifier	Displays the person identifier associated with the statement construct.
Person Identifier Type	Indicates the person identifier type associated with the statement construct.
Statement Construct Identifier	Displays the statement construct identifier defined for the statement construct.
Statement Address Source	Indicates the address where you want to email the statement construct.
Statement Cycle	Indicates the statement construct cycle for the person.
Statement Route Type	Indicates how the statement constructs must be sent to the person.
Status	Indicates the status of the statement construct. The valid values are: <ul style="list-style-type: none"> Active Inactive
Number of Copies	Displays the number of copies of the statement construct you want the person to receive.
Statement Format	Indicates the format of the statement construct. The valid values are: <ul style="list-style-type: none"> Detail Summary
Description	Displays the description of the statement construct.
Number of Accounts and Contracts	Indicates the accounts and contracts added in the statement construct.

Note:

No information appears in the **Statement Constructs** zone if the statement construct is not yet added for the person.

Pagination is used to display limited number of records in this zone. You can use the navigation links, such as **Previous** and **Next** to navigate between pages.

Related Topics

For more information on...	See...
How to add an account for a person	Adding an Account for a Person on page 571
How to view the statement construct details of a person	Viewing the Details of a Statement Construct on page 595
How to view the details of a customer registration	Viewing the Customer Registration Details on page 557

Policies

The **Policies** zone lists the policies defined for the person in the customer registration. It contains the following columns:

Column Name	Column Description
Sequence	Displays the sequence number of the policy.
Template	Indicates the policy template using which the policy is defined for the person.
Policy Type	Indicates the policy type using which the policy is defined for the person.
Policy Number	Displays the policy number.

On clicking the **View** () icon corresponding to a policy, the **Policy** tab appears where you can view the details of the respective policy.

Note:

No information appears in the **Policies** zone if a policy is not yet defined for the person.

Pagination is used to display limited number of records in this zone. You can use the navigation links, such as **Previous** and **Next** to navigate between pages.

The **Policies** zone appears when you are viewing the details of a customer registration which is created using the **C1-CustomerRegistrationHC** business object.

Parent Policies

The **Parent Policies** zone lists the policies of the parent persons which are associated to the main customer through the **Hierarchy** page of the **Customer Registration** screen. It contains the following columns:

Column Name	Column Description
Sequence	Indicates the sequence number.
Policy Number	Displays the policy number.
Person Information	Indicates the information of a person.
Policy ID	Displays the policy identification number.
Link/Unlink	Indicates whether policy is linked or unlinked.
Start Date	Indicates the start date of policy.
End Date	Indicates the end date of policy.
Policy Person Role	Indicates the role of the policy person.

Note:

No information appears in the **Parent Policies** zone if a policy is not yet defined for the parent person associated to the main customer through the **Hierarchy** page of the **Customer Registration** screen..

Pagination is used to display limited number of records in this zone. You can use the navigation links, such as **Previous** and **Next** to navigate between pages.

The **Parent Policies** zone appears when you are viewing the details of a customer registration which is created using the **C1-CustomerRegistrationHC** business object.

Related Topics

For more information on...	See...
How to view the details of a customer registration	Viewing the Customer Registration Details on page 557

Customer Registration - Account

The **Account** tab displays information about the account of the person in a customer registration. It contains the following zone:

- [Account Information](#) on page 618

Account Information

The **Account Information** zone displays information about the account added for the person in the customer registration. It contains the following sections:

- **Main** - Displays the basic information about the account. It contains the following fields:

Field Name	Field Description
Account Information	Displays the concatenated string of information about the account separated by a comma (.). In addition, a context menu appears corresponding to this field which helps in navigating to other screens in the application. Note: It has a link. On clicking the link, the Account screen appears where you can view the details of the respective account.
Customer Class	Indicates the customer class to which the account belongs.
Division	Indicates the division to which the account belongs.
Set Up Date	Displays the date from when the account is configured for the person.
Invoice Currency	Indicates the currency which is used for generating the invoice of the account.
Account Category	Indicates the category to which the account belongs. The valid values are: <ul style="list-style-type: none"> • Invoice Account • Settlement Account • Usage Account
Access Group	Indicates the user group that can access the account for the person.
Exclude Accrual	Indicates whether the account is eligible for accrual.
Eligible for Repricing	Indicates whether the account is eligible for repricing when the account attributes (defined as parameters in the system) are changed.
Product	Indicates the product for which the account is enrolled.
Bill Cycle	Indicates the billing cycle for the account.
Bill Lead Days	Displays the number of days which is used to derive the cut-off date for advance billing.
Comments	Displays additional information about the account.

- **Account Identifiers** - Lists the identifiers details of the account. It contains the following columns:

Column Name	Column Description
Primary ID	Indicates whether the account identifier is primary or not.
Account Identifier Type	Indicates the identifier type for the account.
Primary Account Identifier	Displays the primary account identifier for the account identifier type.

- **Account Characteristics** - Lists the characteristics of the account. It contains the following columns:

Column Name	Column Description
Effective Date	Displays the date from when the characteristic is effective for the account.
Characteristic Type	Indicates the characteristic type.
Characteristic Value	Displays the value for the characteristic type.

- **Auto Pay Details** - Displays the automatic payment details of the account. It contains the following fields:

Field Name	Field Description
Defer Auto Pay Date	Displays the date till when you want to hold the automatic payment process of the account.
Rule Based Auto Pay	Indicates whether the automatic payment is rule based.
Start Date	Displays the date from when the automatic payment is effective for the account.
End Date	Displays the date till when the automatic payment is effective for the account.
Percentage	Displays the contribution of payment amount in percentage within multiple Auto Pay IDs (i.e for Auto Pay Source Codes) having the same priority.
Priority	Displays the order in which the automatic payment option is considered for the effective date range.
Auto Pay Source Code	Indicates the financial institution that receives the automatic payment request.
Auto Pay Route Type	Indicates when and how the automatic payment request of the account is routed to the financial institution.
Account Number	Displays the account number for which the automatic payment is defined.
Expires On	Displays the month and year of expiry for the automatic payment of the account.
Name	Displays the account name for which the automatic payment is defined.
Maximum Withdrawal Amount	Displays the maximum amount which can be withdrawn from the account through the automatic payment method.
Comments	Displays additional information about the automatic payment for the account.

- **Account Credit Rating** - Displays the credit rating details of the account. It contains the following fields:

Field Name	Field Description
Collection Class	Indicates how the account's debt is reviewed by the credit and collections processes (i.e., the account debt monitor and the write-off monitor).
Postpone Credit Review Until	Displays the date till when you want to postpone the account's debt review by the credit and collections processes (i.e., the account debt monitor and the write-off monitor).
Last Credit Review Date	Displays the last review date of the account's debt by the account debt monitor.
Current Credit Rating	Displays the current credit rating.
Current Cash Only Score	Displays the current cash only score.
Start Date	Displays the date from when the credit rating transaction affects the account's credit rating and cash-only score.
End Date	Displays the date till when the credit rating transaction affects the account's credit rating and cash-only score.
Affect Credit Rating By	Displays the effect of the credit rating transaction on the account's credit score.
Affect Cash-Only Score By	Displays the effect of the credit rating transaction on the account's cash-only score.
Comments	Displays additional information about the credit rating for the account.

Note: The **Account Credit Rating** section appears when you are viewing the details of a customer registration which is created using the **C1-CustomerRegistrationBanking** business object.

- **Account Persons** - Displays the details of the persons associated to the account. It contains the following fields:

Field Name	Field Description
Person ID	Indicates the person associated to the account.
Person Name	Displays the name of the person associated to the account.
Main Customer	Indicates whether the associated person is the main customer of the account.
Financially Responsible	Indicates whether the associated person is financially responsible for the account's debt.
Account Relationship Type	Indicates the relationship of the associated person with the main account.

- **Account Override Address** - Displays the overridden address of the account. It contains the following fields:

Column Name	Column Description
Country	Indicates the country where the account main customer is located.
Address 1	Displays the first line of the address. It may contain details, such as house number and apartment name.
Address 2	Displays the second line of the address. It may contain details, such as street name.
Address 3	Displays the third line of the address. It may contain the landmark details.

Column Name	Column Description
Address 4	Displays the fourth line of the address.
City	Displays the city name.
County	Displays the county name.
State	Indicates the state where the city or county is located.
Province	Displays the location within the country where the person is located.
Postal	Displays the postal or zip code of the address.
House Type	Indicates the type of the house.
In City Limit	Indicates whether the address is within the city limit. The valid values are: <ul style="list-style-type: none"> • Yes • No
Geographic Code	Displays the geographic code of the address.

Note:

The above mentioned fields appear in the **Account Override Address** section when the respective data is available for the person.

Also, the labels of the address fields will change depending on the business label which is defined for the respective address field in the **Country** screen.

- **Bill Routing Information** - Displays the bill routing information of the account. It contains the following fields:

Field Name	Field Description
Receives Copy of Bill	Indicates whether you want the person to receive a copy of the account's bill.
Bill Format	Indicates the format in which you want the person to receive the account's bill. The valid values are: <ul style="list-style-type: none"> • Detailed • Summary
Address Source	Indicates the address where you want the person to receive the account's bill. The valid values are: <ul style="list-style-type: none"> • Account Override • Main • Multiple Account Override • Person
Number of Bill copies	Displays the number of copies of the account's bill you want the person to receive.
	Note: This field appears when the Receives Copy of Bill check box is selected.

Field Name	Field Description
Bill Route Type	Indicates how the account's bill is sent to the person.
	Note: This field appears when the Receives Copy of Bill check box is selected.
Receives Notification	Indicates whether you want the person to receive notifications about the account's bill.
	Note: By default, the Receives Notification check box is selected if the person is the main customer of the account.

Related Topics

For more information on...	See...
How to add an account for a person	Adding an Account for a Person on page 571
How to view the details of an account	Viewing the Details of an Account on page 595
How to view the details of a customer registration	Viewing the Customer Registration Details on page 557

Customer Registration - Policy

The **Policy** tab displays information about the policy and policy plans defined for the person in a customer registration. It contains the following zones:

- [Policy Information](#) on page 622
- [Plans](#) on page 623

Note: The **Policy** tab appears in the **Customer Registration** screen when you are viewing the details of a customer registration which is created using the **C1-CustomerRegistrationHC** business object.

Policy Information

The **Policy Information** zone displays information about the policy defined for the person in a customer registration. It contains of the following sections:

- **Main** - Displays the basic information about the policy. It contains the following fields:

Field Name	Field Description
Policy Information	Displays the concatenated string of information about the policy separated by a comma (,).
	Note: It has a link. On clicking the link, the Policy screen appears where you can view the details of the respective policy.
Source System	Indicates the external system from where the policy is originated.
Start Date	Displays the date from when the policy is effective.
Policy Type	Indicates the policy type using which the policy is defined in the system.
End Date	Displays the date till when the policy is effective.
Policy Number	Displays the policy number.

Field Name	Field Description
Policy Person Role	Indicates the role of the person for whom the policy is defined in the system.

- **Persons** - Lists the persons associated to the policy. It contains the following columns:

Column Name	Column Description
Person Information	Displays the person who is associated to the policy. In addition, a context menu appears corresponding to this field which helps in navigating to other screens in the application. Note: It has a link. On clicking the link, the Person screen appears where you can view the details of the respective person.
Sequence	Displays the order in which the person is associated to the policy.
Policy Person Role	Indicates the role of the associated person in the policy.
Main Customer	Indicates whether the associated person is the main customer of the policy.
Start Date	Displays the date from when the person is associated to the policy.
End Date	Displays the date till when the person is associated to the policy.

- **Characteristics** - Lists the characteristics defined for the policy. It contains the following columns:

Column Name	Column Description
Effective Date	Displays the date from when the characteristic is effective for the policy.
Characteristic Type	Indicates the characteristic type.
Characteristic Value	Displays the value for the characteristic type.

Plans

The **Plans** zone lists the plans that are added in a policy. It contains the following columns:

Column Name	Column Description
Sequence	Displays the sequence number of the policy plan.
Template	Indicates the policy plan template using which the policy plan is added in the policy.
Policy Plan Number	Displays the policy plan number.
Price Item	Displays the price item that is associated with the policy plan.

On clicking the **View** () icon corresponding to a policy plan, the **Plan Information** tab appears where you can view the details of the respective policy plan.

Note:

No information appears in the **Plans** zone if a plan is not yet added in the policy.

Pagination is used to display limited number of records in this zone. You can use the navigation links, such as **Previous** and **Next** to navigate between pages.

Related Topics

For more information on...	See...
How to add a plan in a policy	Adding a Plan in a Policy on page 589
How to view the details of a policy plan	Viewing the Details of a Policy Plan on page 605
How to view the details of a customer registration	Viewing the Customer Registration Details on page 557

Customer Registration - Plan Information

The **Plan Information** tab displays information about the policy plan that is added in a policy. It contains the following zone:

- [Plan Information](#) on page 624

Note: The **Plan Information** tab appears in the **Customer Registration** screen when you are viewing the details of a customer registration which is created using the **C1-CustomerRegistrationHC** business object.

Plan Information

The **Plan Information** zone displays information about the policy plan that is added in a policy. It contains of the following sections:

- **Main** - Displays the basic information about the policy plan. It contains the following fields:

Field Name	Field Description
Plan Information	Displays the concatenated string of information about the policy plan separated by a comma (.). In addition, a context menu appears corresponding to this field which helps in navigating to other screens in the application. Note: It has a link. On clicking the link, the Policy Plan screen appears where you can view the details of the respective policy plan.
Plan Number	Displays the policy plan number.
Price Item	Indicates the price item that is associated with the policy plan. Note: It has a link. On clicking the link, the Price Item screen appears where you can view the details of the respective price item.
Start Date	Displays the date from when the policy plan is effective for the policy.
End Date	Displays the date till when the policy plan is effective for the policy.

- **Pricing Rule Types** - Lists the pricing rule types that are associated with the policy plan. It contains the following column:

Column Name	Column Description
Pricing Rule Types	Displays the pricing rule type that is associate with the policy plan. Note: It has a link. On clicking the link, the Pricing Rule Type screen appears where you can view the details of the respective pricing rule type.

- **Characteristics** - Lists the characteristics defined for the policy plan. It contains the following columns:

Column Name	Column Description
Effective Date	Displays the date from when the characteristic is effective for the policy plan.
Characteristic Type	Indicates the characteristic type.
Characteristic Value	Displays the value for the characteristic type.

Related Topics

For more information on...	See...
How to add a plan in a policy	Adding a Plan in a Policy on page 589
How to view the details of a policy plan	Viewing the Details of a Policy Plan on page 605
How to view the details of a customer registration	Viewing the Customer Registration Details on page 557

Customer Registration - Log

The **Log** tab allows you to view the complete trail of actions performed on the customer registration. It also allows you to manually add a log entry for the customer registration. It contains the following zone:

- [Customer Registration Log](#) on page 625

Customer Registration Log

The **Customer Registration Log** zone lists the complete trail of actions performed on the customer registration. It contains the following columns:

Column Name	Column Description
Date/Time	Displays the date and time when the action was performed on the customer registration due to which the log is created in the system.
Details	Displays the details of the actions performed on the customer registration.
User	Indicates the user who has performed the action on the customer registration.
Log Type	Indicates the type of log using which the action is performed on the customer registration.
Related Object	Indicates the object or entity which is created when the action is performed on the customer registration. Note: At present, no data appears in this column. The implementation team can build the custom logic to meet the business requirements.
Status Reason	Indicates the reason why the action is performed on the customer registration.

Note: You can manually add a log entry for the customer registration by clicking the **Add Log Entry** link in the upper right corner of the this zone.

Related Topics

For more information on...	See...
How to view the log of a customer registration	Viewing the Log of a Customer Registration on page 633

For more information on...	See...
How to add a log entry for a customer registration	Adding a Log Entry for a Customer Registration on page 634
Customer Registration - Log tab	Customer Registration - Log on page 625

Editing the Customer Registration Details

Prerequisites

To define a customer registration, you should have:

- Divisions, customer segments, customer tiers, and access groups defined in the application
- Name types, phone types, and person identifier types defined in the application
- Address type codes and countries defined in the application
- Characteristic types defined in the application (where the characteristic entity is set to **Customer Registration**)
- Relationship types defined in the application
- Customer class, invoice currencies, account categories, bill cycles, accrual cycles, account identifier types, auto pay source codes, auto pay methods, auto pay route types, account relationship types, bill formats, address sources, bill route types, and collection class defined in the application

Note: The collection class is required when you are editing a customer registration which is created using the **C1-CustomerRegistrationBanking** business object.

- Deal review frequencies and currency codes defined in the application

Note: These prerequisites are required when you are editing a customer registration which is created using the **C1-CustomerRegistrationBanking** business object.

- Policy types and policy person roles defined in the application.

Note: These prerequisites are required when you are editing a customer registration which is created using the **C1-CustomerRegistrationHC** business object.

Procedure

To edit a customer registration:

1. Search for the customer registration in the **Customer Registration** screen.
2. In the **Search Results** section, click the link in the **Customer Registration Information** column corresponding to the customer registration whose details you want to edit.

The **Main** tab appears in the **Customer Registration** screen.

3. Click the **Edit** button in the **Customer Registration** zone.

The **Customer Registration** screen appears. It contains the following pages:

- **Main** - Used to specify basic information about the person.
- **Contact** - Used to specify the contact information about the person.
- **Person Characteristics** - Used to define a list of characteristics for the person.
- **Hierarchy** - Used to define the person to person relationship for the person
- **Accounts** - Used to add the account details of the person.
- **Deal** - Used to specify information about the deals created for the person.

Note: This page appears only when you are editing a customer registration which is created using the **C1-CustomerRegistrationBanking** business object.

- **Policies** - Used to specify the policy details of the person.

Note: This page appears when you are editing a customer registration which is created using the **C1-CustomerRegistrationHC** business object.

- **Registration Characteristics** - Used to define a list of characteristics for the customer registration.

The **Main** page contains the following sections:

- **Main** - Used to specify basic details about the person.
- **Person Name** - Used to add the person names for customer registration.
- **Person Phones** - Used to add the person phone details for customer registration.
- **Person IDs** - Used to add the person identifiers for customer registration.

The **Main** section contains the following fields:

Field Name	Field Description	Mandatory (Yes or No)
Person Type	Indicates the person type using which you want to define the customer registration for the person.	Not applicable
Date of Birth	Used to specify the date when the person was born.	Yes
Division	Used to indicate the division to which the person belongs. Note: You can view only those divisions to which you have access in the Division list.	Yes
Person Since Date	Used to specify the date from when the person is the main customer.	Yes
Customer Segment	Used to indicate the customer segment to which the person belongs. Note: This field appears when you are editing a customer registration which is created using the C1-CustomerRegistrationBanking business object.	Yes
Customer Tier	Used to indicate the customer tier of the customer segment to which the person belongs. Note: This field appears when you are editing a customer registration which is created using the C1-CustomerRegistrationBanking business object.	Yes

Field Name	Field Description	Mandatory (Yes or No)
Access Group	Used to indicate the user group that can access the customer registration.	Yes
	<p>Note:</p> <p>The Search (🔍) icon appears corresponding to the Access Group field. On clicking the Search icon, the Access Group Search window appears.</p> <p>On specifying the access group, the description of the access group appears corresponding to the Access Group field.</p>	

4. Modify the required details in the **Main** section.
5. Add, edit, or remove the names of the person in the **Person Names** section.
6. Add, edit, or remove the phone details of the person in the **Person Phones** section.
7. Add or remove the identifier details of the person in the **Person IDs** section.
8. Define, edit, or remove the address of the person in the **Contact** page, if required.
9. Define, edit, or remove characteristics of the person in the **Person Characteristics** page, if required.
10. Define, edit, or remove the person to person relationship for the person in the **Hierarchy** page, if required.
11. Add, edit, or remove the account details of the person in the **Accounts** page, if required.
12. Add, edit, or remove information about the deals created for the person in the **Deal** page, if required.

Note: This page appears when you are editing a customer registration which is created using the **C1-CustomerRegistrationBanking** business object.

13. Add, edit, or remove the policy details of the person in the **Policies** page, if required.

Note: This page appears when you are editing a customer registration which is created using the **C1-CustomerRegistrationHC** business object.

14. Define, edit, or remove characteristics of the customer registration in the **Registration Characteristics** page, if required.
15. Click **Validate and Save**.

The changes made to the customer registration are saved.

Related Topics

For more information on...	See...
How to search for a customer registration	Searching for a Customer Registration on page 556
Customer Registration - Main tab	Customer Registration - Main on page 609
Customer Registration screen	Customer Registration (Used for Viewing) on page 608
Customer Registration zone	Customer Registration on page 609
How to add name of a person for customer registration	Adding the Names of a Person on page 561

For more information on...	See...
How to add the phone details of a person for customer registration	Adding the Phone Details of a Person on page 562
How to add the identifier details of a person for customer registration	Adding the Identifier Details of a Person on page 563
How to add the contact details of a person for customer registration	Adding the Contact Details of a Person on page 564
How to define a characteristic for a person	Defining a Characteristic for a Person on page 567
How to define the hierarchy of a person	Defining a Person to Person Relationship for a Person on page 568
How to add an account for a person	Adding an Account for a Person on page 571
How to add a deal information for a person	Adding the Deal Information for a Person
How to add a policy for a person	Defining a Policy on page 583
How to define a characteristic for a customer registration	Defining a Characteristic for a Customer Registration on page 594

Submitting a Customer Registration

Procedure

To submit a customer registration:

1. Search for the customer registration in the **Customer Registration** screen.
2. In the **Search Results** section, click the link in the **Customer Registration Information** column corresponding to the customer registration that you want to submit.

The **Main** tab appears in the **Customer Registration** screen.

3. Click the **Submit** button in the **Customer Registration** zone.

Note: The **Submit** button appears only when the customer registration is in the **Draft** status.

Related Topics

For more information on...	See...
How to search for a customer registration	Searching for a Customer Registration on page 556
Customer Registration screen	Customer Registration (Used for Viewing) on page 608
Customer Registration zone	Customer Registration on page 609

Approving a Customer Registration

You can view the number of customer registrations which are pending for an approval in the **Customer Registration** screen. The approver can review, and accordingly approve, reject, or ask the submitter to resubmit the customer registration based on the observations.

Note: The system will not allow you to approve, reject or resubmit a customer registration submitted by you.

Procedure

To approve a customer registration:

1. Do either of the following:

If you want to...	Then...
Approve a customer registration through the Customer Registration screen	<ol style="list-style-type: none"> 1. Search for the customer registration in the Customer Registration screen. 2. In the Search Results section, click the link in the Customer Registration ID column corresponding to the customer registration which you want to review.
Approve a customer registration from the To Do List screen	<ol style="list-style-type: none"> 1. Click the Menu link in the Application toolbar. A list appears. 2. From the Main menu, select To Do and then click To Do List. The To Do Type for User Search window appears. 3. Enter C1-CustomerRegistration in the To Do Type field. 4. Click the Search button corresponding to the To Do Type field. 5. Click Search. The To Do Type Search screen appears.

The **Customer Registration** screen appears.

2. Review the details in the **Customer Registration** screen.
3. If the information in the customer registration is accurate, then click the **Approve** button in the **Customer Registration** zone.

Note: The **Approve** button appears when:

- The status of customer registration is in the **Approval In Progress**.
- A user with the approval To Do role is reviewing the customer registration.

Related Topics

For more information on...	See...
How to search for a customer registration	Searching for a Customer Registration on page 556
Customer Registration screen	Customer Registration (Used for Viewing) on page 608
Customer Registration zone	Customer Registration on page 609

Rejecting a Customer Registration

Prerequisites

To reject a customer registration, you should have:

- Reasons defined for the **Rejected** status of the **C1-CustomerRegistration** business object in the **Status Reason** screen

Note: The system will not allow you to approve, reject or resubmit a customer registration submitted by you.

Procedure

To reject a customer registration:

- Do either of the following:

If you want to...	Then...
Reject a customer registration through the Customer Registration screen	<ol style="list-style-type: none"> Search for the customer registration in the Customer Registration screen. In the Search Results section, click the link in the Customer Registration Information column corresponding to the customer registration which you want to review.
Reject a customer registration from the To Do List screen	<ol style="list-style-type: none"> Click the Menu link in the Application toolbar. A list appears. From the Main menu, select To Do and then click To Do List. The To Do Type for User Search window appears. Enter C1-CustomerRegistration in the To Do Type field. Click the Search button corresponding to the To Do Type field. The To Do List screen appears. Select the Open option from the Filter by list to view all unassigned To Dos. Click the link in the Message column corresponding to the To Do of the customer registration that you want to review.

The **Customer Registration** screen appears.

- Review the details in the **Customer Registration** screen.
- If the information in the customer registration is incorrect, then click the **Reject** button in the **Customer Registration** zone.

The **Reject Customer Registration** window appears. It contains following fields:

Field Name	Field Description	Mandatory (Yes or No)
Status Reason	Used to indicate the reason why you want to reject the customer registration.	Yes
	Note: The list includes only those reasons which are defined for the Rejected status of the C1-CustomerRegistration business object in the Status Reason screen.	
Comments	Used to specify additional information while rejecting the customer registration.	No

Note: The **Reject** button appears when:

- The customer registration is in the **Approval In Progress** status.
- A user with the approval To Do role is reviewing the customer registration.

4. Select the reason for rejection of the customer registration from the **Status Reason** field.
5. Click **Save**.

The status of the customer registration is changed to **Rejected**.

Related Topics

For more information on...	See...
How to search for a customer registration	Searching for a Customer Registration on page 556
Customer Registration screen	Customer Registration (Used for Viewing) on page 608
Customer Registration zone	Customer Registration on page 609

Requesting to Resubmit a Customer Registration for Approval

Procedure

To initiate a resubmission request for a customer registration:

1. Do either of the following:

If you want to...	Then...
Request the submitter to resubmit a customer registration through the Customer Registration screen	<ol style="list-style-type: none"> 1. Search for the customer registration in the Customer Registration screen. 2. In the Search Results section, click the link in the Customer Registration ID column corresponding to the customer registration which you want to review.
Request the submitter to resubmit a customer registration from the To Do List screen	<ol style="list-style-type: none"> 1. Click the Menu link in the Application toolbar. A list appears. 2. From the Main menu, select To Do and then click To Do List.

If you want to...	Then...
	<p>The To Do Type for User Search window appears.</p> <ol style="list-style-type: none"> 3. Enter C1-CustomerRegistration in the To Do Type field. 4. Click the Search button corresponding to the To Do Type field. <p>The To Do List screen appears.</p> <ol style="list-style-type: none"> 5. Select the Open option from the Filter by list to view all unassigned To Dos. 6. Click the link in the Message column corresponding to the To Do of the customer registration that you want to review.

The **Customer Registration** screen appears.

2. Review the details in the **Customer Registration** screen.
3. If the information in the customer registration is incomplete and you want the submitter to make the required changes and resubmit the customer registration for approval, then click the **Re Submit** button in the **Customer Registration** zone.

The **Resubmit Customer Registration** window appears. It contains the following field:

Field Name	Field Description	Mandatory (Yes or No)
Comments	Used to specify the changes which the submitter should make in the customer registration before resubmitting it for approval.	Yes

Note: The **Re Submit** button appears when:

- The customer registration is in the **Approval In Progress** status.
- A user with the approval To Do role is reviewing the customer registration.

4. Enter the comments in the respective field and then click **Save**.

A To Do is created using the submitter To Do type and assigned to all users with a submitter To Do role specified in the customer registration type. In addition, the status of the customer registration is changed to **Draft**.

Related Topics

For more information on...	See...
How to search for a customer registration	Searching for a Customer Registration on page 556
Customer Registration screen	Customer Registration (Used for Viewing) on page 608
Customer Registration zone	Customer Registration on page 609

Viewing the Log of a Customer Registration

Procedure

To view the log of a customer registration:

1. Search for the customer registration in the **Customer Registration** screen.
2. In the **Search Results** section, click the link in the **Customer Registration Information** column corresponding to the customer registration whose log you want to view.

The **Main** tab appears in the **Customer Registration** screen.

3. Click the **Log** tab.

The **Log** tab appears.

4. View the complete trail of actions performed on the customer registration in the **Customer Registration Log** zone.

Related Topics

For more information on...	See...
How to search for a customer registration	Searching for a Customer Registration on page 556
Customer Registration - Main tab	Customer Registration - Main on page 609
Customer Registration screen	Customer Registration (Used for Viewing) on page 608
Customer Registration - Log tab	Customer Registration - Log on page 625
Customer Registration Log zone	Customer Registration Log on page 625

Adding a Log Entry for a Customer Registration

Procedure

To add a log entry for a customer registration:

1. Search for the customer registration in the **Customer Registration** screen.
2. In the **Search Results** section, click the link in the **Customer Registration Information** column corresponding to the customer registration for which you want to add a log entry.

The **Main** tab appears in the **Customer Registration** screen.

3. Click the **Log** tab.

The **Log** tab appears.

4. Click the **Add Log Entry** link in the upper right corner of the **Customer Registration Log** zone.

The **Add Request Log** screen appears. It contains the following fields:

Field Name	Field Description	Mandatory (Yes or No)
Request Information	Displays the concatenated string of information about the customer registration separated by a comma (,).	Not applicable
Log Details	Used to specify the reason for adding a log entry for the customer registration.	Yes

5. Enter the required details in the **Log Details** field.
6. Click **Save**.

The log entry is added for the **Customer Registration Log** zone.

Related Topics

For more information on...	See...
How to search for a customer registration	Searching for a Customer Registration on page 556
Customer Registration - Main tab	Customer Registration - Main on page 609
Customer Registration screen	Customer Registration (Used for Viewing) on page 608
Customer Registration - Log tab	Customer Registration - Log on page 625
Customer Registration Log zone	Customer Registration Log on page 625

Chapter

8

Customer 360° View

Topics:

- [Prerequisites](#)
- [Customer 360° View](#)
- [Customer 360° Information](#)
- [Bill Information](#)

Oracle Revenue Management and Billing provides a new screen named **Customer 360° View** which enables you to quickly view in-depth information about the person. This screen can be used to view the 360° information of a person who is associated with the fully-insured group or self-funded policy. It provides the following information:

- Basic details, characteristics, child persons, person hierarchy, person billing hierarchy, and the customer contacts of the person.
- Customer registration objects through which the bill groups are created for a parent customer.
- List of accounts to which the parent customer and its bill groups are associated.
- Basic details, characteristics, administrative contracts, automatic payment options, billing and adjustment summary, financial and collections summary, and unpaid bills of the person's account.
- Consolidated view of the transactions (such as, billing, payment, payment cancellation, adjustment, adjustment cancellation, automatic payments sent to the auto clearing house for review, refund, write off, excess credit, and reconciliation) which are carried out for the person's account.
- List of policies to which the parent customer or bill group is associated. The system lists those policies where the policy category is set to **Self-Funded** and **Fully Insured Group**.
- Basic details, related persons, and policy plans in the person's policy.
- Basic and in-depth details of the pricing rules which are defined for a parent customer who is associated with the fully-insured group or self-funded policy.
- Basic and in-depth details of the pricing rules which are defined for a self-funded policy of a bill group.
- Basic details of the pricing groups which are defined for a bill group who is associated with the self-funded policy.
- Basic and in-depth details of the pricing rules which are defined for a fully-insured group policy.
- Basic and in-depth details of the pricing rules which are defined for a fully-insured group policy plan.
- Basic and in-depth details of the pricing rules which are defined for the states where the fully-insured group policy and its plans and memberships are issued.

- Basic details of the approval transactions which are created while defining, editing, and deleting the pricing rules for the self-funded or fully-insured group business.
- Basic details of the bill, adjustments which are swept onto the bill, activities (such as, payment, offset, refund, write off, or transfer) through which the bill is settled, high-level summary and details of the bill segments which are included in the bill, active hold requests due to which the bill is kept on hold, offset requests through which the bill is offset against another bill, and refund and write off requests through which the bill or its bill segment is either refunded or written off.

In other words, this feature allows you to drill-down to see or act on all current and historical revenue management and billing details. This allows you to professionally and efficiently handle customer inquiries and complaints at the first point of contact, raising your customer service from previously unattainable levels and reducing the associated time and cost.

Prerequisites

To setup the **Customer 360° View** feature, you need to do the following:

- Define the required divisions, customer classes, person types, person identifier types, account identifier types, policy types, and policy person roles in the system
- Define values for the **C1-SourceSystemLookup** extendable lookup
- Define the required characteristic types where the characteristic entity is set to **Person**
- Define the required characteristic types where the characteristic entity is set to **Account**
- Define the required characteristic types where the characteristic entity is set to **Policy**
- Define values for the **Administrative Contract Type** and **On Account Contract Type** option types in the **C1_CMO** feature configuration

Note: This prerequisite is not required when you are viewing the 360° information of a person who is associated with the self-funded policy.

- Define values for **Premium Amount SQI** and **Coverage End Date SQI** option types in the **C1-BILLADJSQ** feature configuration

Note: This prerequisite is not required when you are viewing the 360° information of a person who is associated with the self-funded policy.

- Define value for the **Person Relationship Type** option type in the **C1-ASOBLNG** feature configuration

Related Topics

For more information on...	See...
How to setup the C1_CMO feature configuration	Setting the C1_CMO Feature Configuration on page 3445
How to setup the C1-ASOBLNG feature configuration	Setting the C1-ASOBLNG Feature Configuration on page 3421
How to setup the C1-BILLADJSQ feature configuration	Setting the C1-BILLADJSQ Feature Configuration on page 3443

Customer 360° View

The **Customer 360° View** screen allows you to search for a person, its accounts, and policies using various search criteria. It contains the following zone:

- [360° Search](#) on page 639

360° Search

The **360° Search** zone allows you to search for a person, account, and policy using various search criteria. It contains the following two sections:

- **Search Criteria** – The **Search Criteria** section contains the following fields:

Field Name	Field Description	Mandatory (Yes or No)
Search By	Used to indicate whether you want to search for a person, account, or policy. The valid values are: <ul style="list-style-type: none"> • Policy • Person • Account 	Yes
	Note: By default, the Policy option is selected.	
Policy Type	Used to search policies which are created using a particular policy type.	No
	Note: This field appears when the Policy option is selected from the Search By list.	
Source System	Used to search policies which were created in a particular external system.	No
	Note: This field appears when the Policy option is selected from the Search By list.	
Policy Number	Used to search a policy with a particular policy number.	No
	Note: This field appears when the Policy option is selected from the Search By list.	
Policy ID	Used to search a particular policy.	No
	Note: This field appears when the Policy option is selected from the Search By list.	
Policy Person Role	Used to search policies where a person is assigned a particular person role.	No
	Note: This field appears when the Policy option is selected from the Search By list.	

Field Name	Field Description	Mandatory (Yes or No)
Person Name	<p>Used to search a particular person using its primary or secondary name. If you specify the person name while searching for an account, the system searches all accounts where the person is the main customer. However, if you specify the person name while searching for a policy, the system searches all policies where the person is the main customer.</p>	<p>Yes (Conditional)</p> <p>Note: This field is required when you are searching for a policy using the policy person role.</p>
	<p>Note:</p> <p>This field appears when:</p> <ul style="list-style-type: none"> • The Policy or Person option is selected from the Search By list. • The Account option is selected from the Search By list and the Advanced Search link available in the right side of the 360° Search zone is clicked. 	
Status	<p>Used to search policies with a particular status. The valid values are:</p> <ul style="list-style-type: none"> • In Force/Active • Canceled • Pending Cancellation • Pending • Pending Reinstatement • Pending Termination • Post Runout • Reinstated • Runout • Terminated 	No
	<p>Note: This field appears when the Policy option is selected from the Search By list.</p>	
Start Date	<p>Used to search policies which are effective from a particular date.</p> <p>Note: This field appears when the Policy option is selected from the Search By list and the Advanced Search link available in the right side of the 360° Search zone is clicked.</p>	No

Field Name	Field Description	Mandatory (Yes or No)
End Date	Used to search policies which are effective till a particular date.	No
	Note: This field appears when the Policy option is selected from the Search By list and the Advanced Search link available in the right side of the 360° Search zone is clicked.	
Characteristic Type	Used to search persons, accounts, or policies with a particular type of characteristic.	No
	Note: This field appears when the Advanced Search link available in the right side of the 360° Search zone is clicked.	
Characteristic Value	Used to search persons, accounts, or policies with a particular characteristic.	Yes (Conditional)
	Note: This field appears when you are searching for a person, account, or policy using the characteristic type. On specifying the value for a predefined characteristic type, the description of the characteristic value appears corresponding to the Characteristic Value field.	
Division	Used to search persons or accounts which belong to a particular division.	No
	Note: This field appears when the Person or Account option is selected from the Search By list.	
Customer Class	Used to search accounts or persons' whose accounts belong to a particular customer class.	No
	Note: This field appears when the Person or Account option is selected from the Search By list.	
Person ID	Used to search a particular person.	No
	Note: This field appears when the Person option is selected from the Search By list.	
Person Identifier Type	Used to indicate the person identifier type based on which you want to search for a person.	Yes (Conditional)
	Note: This field appears when the Person option is selected from the Search By list.	

Field Name	Field Description	Mandatory (Yes or No)
Person Identifier	Used to search a person with a particular identifier.	Yes (Conditional)
	Note: This field appears when the Person option is selected from the Search By list.	Note: If you specify the person identifier type as a search criteria, you have to enter the person identifier.
Person Type	Used to search persons of a particular type. The valid values are: <ul style="list-style-type: none"> • Business • Bill Group • Group • Broker • Person • Parent Customer 	No
	Note: This field appears when the Person option is selected from the Search By list and the Advanced Search link available in the right side of the 360° Search zone is clicked.	
Address	Used to search persons with a particular address or accounts' whose main customer has a particular address.	No
	Note: This field appears when the Person or Account option is selected from the Search By list and the Advanced Search link available in the right side of the 360° Search zone is clicked.	
City	Used to search persons who belong to a particular city or accounts' whose main customer belongs to a particular city.	No
	Note: This field appears when the Person or Account option is selected from the Search By list and the Advanced Search link available in the right side of the 360° Search zone is clicked.	

Field Name	Field Description	Mandatory (Yes or No)
Skip Months	Used to search accounts for which the skip months are defined through a billing preference.	No
	<p>Note:</p> <p>You can set the billing preference for an account through a characteristic type which is specified in the Bill Cycle Rule Code option type of the C1-ASOBLNG feature configuration. The system enables you to define, edit, delete, and copy a billing preference through the Field Mapping screen. For more information, see Defining a Billing Preference.</p> <p>This field appears when the Account option is selected from the Search By list and the Advanced Search link available in the right side of the 360° Search zone is clicked.</p>	
Phone Number	Used to search a person with a particular phone number or accounts' whose main customer has a particular phone number.	No
	<p>Note: This field appears when the Person or Account option is selected from the Search By list and the Advanced Search link available in the right side of the 360° Search zone is clicked.</p>	
Account ID	Used to search a particular account.	No
	<p>Note: This field appears when the Account option is selected from the Search By list.</p>	
Account Identifier Type	Used to indicate the account identifier type based on which you want to search for an account.	Yes (Conditional)
	<p>Note: This field appears when the Account option is selected from the Search By list.</p>	
Account Identifier	Used to search an account with a particular identifier.	Yes (Conditional)
	<p>Note: This field appears when the Account option is selected from the Search By list.</p>	

Note:

You must specify at least one search criterion while searching for a person, account, or policy. One more search criterion is required when you are searching for a person or account using the division and/or customer class. Similarly, one more search criterion is required when you are searching for a policy using the policy type and/or source system.

If you have specified any other search criterion along with the person ID, account ID, or policy ID, the system ignores the additional search criterion and searches using the person ID, account ID, or policy ID, respectively.

- **Search Results** – On clicking the **Search** button, the search results appear based on the specified search criteria. The **Search Results** section contains the following columns:

Column Name	Column Description
Policy Information	Displays information about the policy.
	<p>Note:</p> <p>It has a link. On clicking the link, the Policy screen appears where you can view the details of the respective policy.</p> <p>This column appears when the Policy option is selected from the Search By list.</p>
Main Customer	Indicates the main customer of the policy or account.
	<p>Note: This column appears when the Policy or Account option is selected from the Search By list.</p>
Source System	Displays the name of the external system in which the policy was created.
	<p>Note: This column appears when the Policy option is selected from the Search By list.</p>
Policy Number	Displays the policy number.
	<p>Note: This column appears when the Policy option is selected from the Search By list.</p>
Start Date	Displays the date from when the policy is effective.
	<p>Note: This column appears when the Policy option is selected from the Search By list.</p>
End Date	Displays the date till when the policy is effective.
	<p>Note: This column appears when the Policy option is selected from the Search By list.</p>

Column Name	Column Description
Status	<p>Indicates the status of the policy. The valid values are:</p> <ul style="list-style-type: none"> • In Force/Active • Canceled • Pending Cancellation • Pending • Pending Reinstatement • Pending Termination • Post Runout • Reinstated • Runout • Terminated <p>Note: This column appears when the Policy option is selected from the Search By list.</p>
Person Information	<p>Displays information about the person. In addition, this column has a context menu which helps in navigating to other screens in the application.</p> <p>Note: It has a link. On clicking the link, the Person screen appears where you can view the details of the respective person. This column appears when the Person option is selected from the Search By list.</p>
Person Name	<p>Displays the name of the person.</p> <p>Note: This column appears when the Person option is selected from the Search By list.</p>
Person Type	<p>Indicates the type of the person. The valid values are:</p> <ul style="list-style-type: none"> • Business • Bill Group • Group • Broker • Person • Parent Customer <p>Note: This column appears when the Person option is selected from the Search By list.</p>
Primary Person Identifier Type	<p>Indicates the primary identifier type associated with the person.</p> <p>Note: This column appears when the Person option is selected from the Search By list.</p>

Column Name	Column Description
Primary Person Identifier	Displays the primary person identifier.
	Note: This column appears when the Person option is selected from the Search By list.
Account Information	Displays information about the account. In addition, this column has a context menu which helps in navigating to other screens in the application.
	Note: It has a link. On clicking the link, the Account screen appears where you can view the details of the respective account. This column appears when the Account option is selected from the Search By list.
Division	Indicates the division to which the account belongs.
	Note: This column appears when the Account option is selected from the Search By list.
Customer Class	Indicates the customer class to which the account belongs.
	Note: This column appears when the Account option is selected from the Search By list.
Primary Account Identifier Type	Indicates the primary identifier type associated with the account.
	Note: This column appears when the Account option is selected from the Search By list.
Primary Account Identifier	Displays the primary account identifier.
	Note: This column appears when the Account option is selected from the Search By list.
Current Balance	Displays the total amount of funds in the account.
	Note: This column appears when the Account option is selected from the Search By list.
Also Known As	Displays the non-primary names of the person separated by semi-colon (;).
	Note: This column appears when the Person option is selected from the Search By list.

Note:

You can view the 360° information of the person, account, or policy by clicking the **View** () icon corresponding to the record in the **Search Results** section.

Pagination is used to display limited number of records in the **Search Results** section. You can use the navigation links, such as **Previous** and **Next** to navigate between pages.

Related Topics

For more information on...	See...
How to search for a person	Searching for a Person on page 648
How to search for an account	Searching for an Account on page 649
How to search for a policy	Searching for a Policy on page 650
How to view the 360° information of a person	Viewing the 360° Information of a Person on page 651
How to view the 360° information of an account	Viewing the 360° Information of an Account on page 653
How to view the 360° information of a policy	Viewing the 360° Information of a Policy on page 655

Searching for a Person

Prerequisites

To search for a person, you should have:

- Divisions, customer classes, person types, and person identifier types defined in the application
- Characteristic types defined in the application (where the characteristic entity is set to **Person**)

Procedure

To search for a person:

1. Click the **Menu** link in the **Application** toolbar.
A list appears.
2. From the **Main** menu, click **Customer Management** and then click **Customer 360° View**.
The **Customer 360° View** screen appears.
3. Select the **Person** option from the **Search By** list to indicate that you want to search for a person.
4. Enter the required search criteria in the **360° Search** zone.

Note:

You must specify at least one search criterion while searching for a person. One more search criterion is required when you are searching for a person using the division and/or customer class.

The criteria are grouped as indicated by line separators between the criteria. Each group is independent from the other, and only one group is used at a time for searching. If you enter criteria in more than one group, the criteria from the former group is used for searching. For example, if you enter the person name (in the second criteria group) and person identifier (in the fourth criteria group), the system searches using the person name instead of the person identifier.

You must specify division and/or customer class when you are searching for a person using the city.

You must specify division, customer class, or any other criteria in the second group when you are searching for a person using the person type.

If you have specified any other search criterion along with the person ID, the system ignores the additional search criterion and searches for the person using the person ID.

ORMB search engine supports wildcard search, where you can substitute the percentage (%) symbol as a stand in for any word or letter in a search criteria. The ‘%’ wildcard character is suffixed automatically at the end of the partial search criteria. Therefore, you may or may not specify the wildcard character at the end of the partial search criteria. However, you have to prefix the wildcard character manually wherever required.

The **Advanced Search** link appears in the right side of the **360° Search** zone. On clicking the **Advanced Search** link, additional fields appear in the zone which help you to refine the search.

If you select a predefined characteristic type, the **Search** (🔍) icon appears corresponding to the **Characteristic Value** field. On clicking the **Search** icon, you can search for a predefined characteristic value.

5. Click **Search**.

A list of persons that meet the search criteria appears in the **Search Results** section.

Related Topics

For more information on...	See...
Customer 360° View screen	Customer 360° View on page 639
360° Search zone	360° Search on page 639

Searching for an Account

Prerequisites

To search for an account, you should have:

- Divisions, customer classes, and account identifier types defined in the application
- Characteristic types defined in the application (where the characteristic entity is set to **Account**)

Procedure

To search for an account:

1. Click the **Menu** link in the **Application** toolbar.
A list appears.
2. From the **Main** menu, click **Customer Management** and then click **Customer 360° View**.
The **Customer 360° View** screen appears.
3. Select the **Account** option from the **Search By** list to indicate that you want to search for an account.

- Enter the required search criteria in the **360° Search** zone.

Note:

You must specify at least one search criterion while searching for an account. One more search criterion is required when you are searching for an account using the division and/or customer class.

The criteria are grouped as indicated by line separators between the criteria. Each group is independent from the other, and only one group is used at a time for searching. If you enter criteria in more than one group, the criteria from the former group is used for searching. For example, if you enter the person name (in the fourth criteria group) and account identifier (in the third criteria group), the system searches using the account identifier instead of the person name.

You must specify division and/or customer class when you are searching for an account using the city.

If you have specified any other search criterion along with the account ID, the system ignores the additional search criterion and searches for the account using the account ID.

ORMB search engine supports wildcard search, where you can substitute the percentage (%) symbol as a stand in for any word or letter in a search criteria. The '%' wildcard character is suffixed automatically at the end of the partial search criteria. Therefore, you may or may not specify the wildcard character at the end of the partial search criteria. However, you have to prefix the wildcard character manually wherever required.

The **Advanced Search** link appears in the right side of the **360° Search** zone. On clicking the **Advanced Search** link, additional fields appear in the zone which help you to refine the search.

If you select a predefined characteristic type, the **Search** (🔍) icon appears corresponding to the **Characteristic Value** field. On clicking the **Search** icon, you can search for a predefined characteristic value.

- Click **Search**.

A list of accounts that meet the search criteria appears in the **Search Results** section.

Related Topics

For more information on...	See...
Customer 360° View screen	Customer 360° View on page 639
360° Search zone	360° Search on page 639

Searching for a Policy**Prerequisites**

To search for a policy, you should have:

- Policy types and policy person roles defined in the application
- Values defined for the **C1-SourceSystemLookup** extendable lookup
- Characteristic types defined in the application (where the characteristic entity is set to **Policy**)

Procedure

To search for a policy:

- Click the **Menu** link in the **Application** toolbar.
A list appears.
- From the **Main** menu, click **Customer Management** and then click **Customer 360° View**.
The **Customer 360° View** screen appears.
- Select the **Policy** option from the **Search By** list to indicate that you want to search for a policy.

- Enter the required search criteria in the **360° Search** zone.

Note:

You must specify at least one search criterion while searching for a policy. One more search criterion is required when you are searching for a policy using the policy type and/or source system.

If you have specified any other search criterion along with the policy ID, the system ignores the additional search criterion and searches for the policy using the policy ID.

You must specify the person name when you are searching for a policy using the policy person role.

ORMB search engine supports wildcard search, where you can substitute the percentage (%) symbol as a stand in for any word or letter in a search criteria. The '%' wildcard character is suffixed automatically at the end of the partial search criteria. Therefore, you may or may not specify the wildcard character at the end of the partial search criteria. However, you have to prefix the wildcard character manually wherever required.

The **Advanced Search** link appears in the right side of the **360° Search** zone. On clicking the **Advanced Search** link, additional fields appear in the zone which help you to refine the search.

If you select a predefined characteristic type, the **Search** (🔍) icon appears corresponding to the **Characteristic Value** field. On clicking the **Search** icon, you can search for a predefined characteristic value.

- Click **Search**.

A list of policies that meet the search criteria appears in the **Search Results** section.

Related Topics

For more information on...	See...
Customer 360° View screen	Customer 360° View on page 639
360° Search zone	360° Search on page 639

Viewing the 360° Information of a Person**Prerequisites**

To view the 360° information of a person, you should have:

- Value defined for the **Person Relationship Type** option type in the **C1-ASOBLLNG** feature configuration

Procedure

To view the 360° information of a person:

- Search for the person in the **Customer 360° View** screen.
- In the **Search Results** section, click the **View** (🔗) icon corresponding to the person whose details you want to view.

The **Person** tab appears in the **Customer 360° Information** screen. It contains the following zones:

- [Person Information](#) on page 665
- [Person Characteristics](#) on page 666
- [Child Persons](#) on page 667
- [Person Hierarchy](#) on page 667

Note: The **Person Hierarchy** zone does not appear when you are viewing the 360° information of a person whose person type is set to **Parent Customer**.

- [Person Billing Hierarchy](#) on page 668

Note: The **Person Billing Hierarchy** zone appears when you are viewing the 360° information of a person whose person type is set to **Parent Customer**.

- [Bill Group Derivation and Pricing Parameters](#) on page 671

Note: The **Bill Group Derivation and Pricing Parameters** zone appears when you are viewing the 360° information of a person whose person type is set to **Parent Customer**.

- [Bill Group Sorting](#) on page 673

Note: The **Bill Group Sorting** zone appears when you are viewing the 360° information of a person whose person type is set to **Parent Customer**.

- [Customer Contacts](#) on page 674
- [Bill Groups Created Via Customer Registration](#) on page 675

Note: The **Bill Groups Created Via Customer Registration** zone appears when you are viewing the 360° information of a person whose person type is set to **Parent Customer**.

3. View the basic details of the person in the **Person Information** zone.
4. View the characteristics of the person in the **Person Characteristics** zone.
5. View the child persons included in the person's hierarchy in the **Child Persons** zone.
6. View the accounts and policies where the person is the main customer and memberships where the person is the main subscriber in the **Person Hierarchy** zone.
7. View the parent customer's accounts and policies and its bill groups' accounts and policies in the **Person Billing Hierarchy** zone.
8. View the derivation and pricing parameters defined for the bill group and sort ID combinations in the **Bill Group Derivation and Pricing Parameters** zone.
9. View the sort IDs defined for the bill groups in the **Bill Group Sorting** zone.
10. View how and when the person was contacted in the **Customer Contacts** zone.
11. View the customer registration objects through which the bill groups are created for the parent customer in the **Bill Groups Created Via Customer Registration** zone.
12. If required, you can view the details of the account to which the person is associated in the **Account** tab.

Note:

If you are viewing the 360° information of a parent customer, the following zones appear in the **Account** tab when you click the **Broadcast** () icon corresponding to the account in the [Account List](#) on page 676 zone:

- [Account Information](#) on page 677
- [Auto Pay Details](#) on page 680
- [Account Characteristics](#) on page 679
- [Account Financial and Collections Summary](#) on page 681
- [Open Bills](#) on page 682
- [Billed Vs Paid](#) on page 684
- [Timeline](#) on page 686
- [Trial Bills](#) on page 689

13. If required, you can view the details of the policy to which the person is associated in the **Policy** tab.

14. If required, you can view the pricing information of the parent customer or its bill groups in the **Pricing Information** tab.

Related Topics

For more information on...	See...
How to search for a person	Searching for a Person on page 648
Customer 360° Information screen	Customer 360° Information on page 659
Person tab	Customer 360° Information - Person on page 663
Account tab	Customer 360° Information - Account on page 675
Policy tab	Customer 360° Information - Policy on page 689
Pricing Information tab	Customer 360° Information - Pricing Information on page 693
How to view the pricing information of a parent customer	Viewing the Pricing Information of a Parent Customer on page 655
How to view the pricing information of a bill group	Viewing the Pricing Information of a Bill Group on page 657
How to setup the C1-ASOBLNG feature configuration	Setting the C1-ASOBLNG Feature Configuration on page 3421

Viewing the 360° Information of an Account

Prerequisites

To view the 360° information of an account, you should have:

- Value defined for the **Person Relationship Type** option type in the **C1-ASOBLNG** feature configuration
- Values defined for the **Administrative Contract Type** and **On Account Contract Type** option types in the **C1_CMO** feature configuration
- Values defined for the **Premium Amount SQI** and **Coverage End Date SQI** option types in the **C1-BILLADJSQ** feature configuration

Note: The latter two prerequisites are not required when you are viewing the 360° information of a person who is associated with the self-funded policy.

Procedure

To view the 360° information of an account:

1. Search for the account in the **Customer 360° View** screen.
2. In the **Search Results** section, click the **View** () icon corresponding to the account whose details you want to view.

The **Account** tab appears in the **Customer 360° Information** screen. It contains the following zones:

- [Account List](#) on page 676

Note: The **Account List** zone appears when you are viewing the 360° information of a person whose person type is set to **Parent Customer**.

- [Account Information](#) on page 677

- [Auto Pay Details](#) on page 680
- [Account Characteristics](#) on page 679
- [Administrative Contracts](#) on page 680

Note: The **Administrative Contracts** zone appears when you are viewing the 360° information of a person whose person type is neither **Parent Customer** nor **Bill Group**.

- [Account Financial and Collections Summary](#) on page 681
- [Billing and Adjustment Summary](#) on page 681

Note: The **Billing and Adjustment Summary** zone appears when you are viewing the 360° information of a person whose person type is neither **Parent Customer** nor **Bill Group**.

- [Open Bills](#) on page 682
 - [Billed Vs Paid](#) on page 684
 - [Timeline](#) on page 686
 - [Trial Bills](#) on page 689
3. View the accounts of the parent customer and its bill groups in the **Account List** zone.
 4. View the basic details of the account in the **Account Information** zone.
 5. View the automatic payment options defined for the account in the **Auto Pay Details** zone.
 6. View the characteristics of the account in the **Account Characteristics** zone.
 7. View the account's contracts which should be monitored closely for various administrative reasons in the **Administrative Contracts** zone.
 8. View the financial and collection details of the account in the **Account Financial and Collections Summary** zone.
 9. View the billing and adjustment summary of the account in the **Billing and Adjustment Summary** zone.
 10. View the unpaid bills of the account in the **Open Bills** zone.
 11. View various transactions of the account, such as bills, payments, adjustments, reconciliations, and so on, in the **Billed Vs Paid** zone.
 12. View the number of customer contacts, bills, and payments created for the account in a particular month in the **Timeline** zone.
 13. View the trial bills which are created for the account in the **Trial Bills** zone.

Related Topics

For more information on...	See...
How to search for an account	Searching for an Account on page 649
Customer 360° Information screen	Customer 360° Information on page 659
Account tab	Customer 360° Information - Account on page 675
How to setup the C1_CMO feature configuration	Setting the C1_CMO Feature Configuration on page 3445
How to setup the C1-ASOBLNG feature configuration	Setting the C1-ASOBLNG Feature Configuration on page 3421
How to setup the C1-BILLADJSQ feature configuration	Setting the C1-BILLADJSQ Feature Configuration on page 3443

Viewing the 360° Information of a Policy

Procedure

To view the 360° information of a policy:

1. Search for the policy in the **Customer 360° View** screen.
2. In the **Search Results** section, click the **View** () icon corresponding to the policy whose details you want to view.

The **Policy** tab appears in the **Customer 360° Information** screen. It contains the following zones:

- [Policy List](#) on page 691

Note: The **Policy List** zone appears when there is more than one policy associated with the person.

- [Policy Information](#) on page 692
- [Policy Persons](#) on page 692
- [Policy Plans](#) on page 693

Note: The **Policy Plans** zone appears when you are viewing the 360° information of a person who is associated with the fully-insured group policy.

3. View the list of policies associated with the person in the **Policy List** zone.
4. View the basic details of the policy in the **Policy Information** zone.
5. View the persons associated with the policy in the **Policy Persons** zone.
6. View the plans defined in the policy in the **Policy Plans** zone.

Related Topics

For more information on...	See...
How to search for a policy	Searching for a Policy on page 650
Customer 360° Information screen	Customer 360° Information on page 659
Policy tab	Customer 360° Information - Policy on page 689

Viewing the Pricing Information of a Parent Customer

Prerequisites

To view the pricing information of a parent customer, you should have:

- Value defined for the **Person Relationship Type** option type in the **C1-ASOBLLNG** feature configuration

Procedure

To view the pricing information of a parent customer:

1. Search for a person whose person type is set to **Parent Customer** in the **Customer 360° View** screen.
2. In the **Search Results** section, click the **View** () icon corresponding to the person whose details you want to view.

The **Person** tab appears in the **Customer 360° Information** screen.

3. Click the **Pricing Information** tab.

The **Pricing Information** tab appears. It contains the following zones:

- [Parent Customer Pricing Rules](#) on page 696

Note: The **Parent Customer Pricing Rules** zone appears when you are viewing 360° information of a parent customer or bill group who is associated with the self-funded policy.

- [Bill Group Self-Funded Policy Pricing Rule Summary](#) on page 699

Note: The **Bill Group Self-Funded Policy Pricing Rule Summary** zone appears when you are viewing 360° information of a parent customer who is associated with the self-funded policy.

- [Bill Group Self-Funded Policy Information](#) on page 701

Note: The **Bill Group Self-Funded Policy Information** zone appears when you are viewing 360° information of a parent customer or bill group who is associated with the self-funded policy.

- [Bill Group Self-Funded Policy Pricing Rules](#) on page 702

Note: The **Bill Group Self-Funded Policy Pricing Rules** zone appears when you are viewing 360° information of a parent customer or bill group who is associated with the self-funded policy.

- [Fully-Insured Pricing Rules](#) on page 708

Note: The **Fully-Insured Pricing Rules** zone appears when you are viewing 360° information of a parent customer or bill group who is associated with the fully-insured group policy.

- [Pricing Rule Summary](#) on page 709

Note: The **Pricing Rule Summary** zone appears when you are viewing 360° information of a parent customer who is associated with the fully-insured group policy.

- [Pricing Rule Approval Transactions](#) on page 710

Note: The **Pricing Rule Approval Transactions** zone appears when you are viewing 360° information of a parent customer or bill group who is associated with the fully-insured group or self-funded policy.

4. Do either of the following:

If you are viewing 360° information of...	Then...
A parent customer who is associated with a self-funded policy	<ol style="list-style-type: none"> 1. View the pricing rules which are defined for the parent customer in the Parent Customer Pricing Rules zone. 2. View the list of pricing rules which are defined for the self-funded policies of the bill groups in a tree structure in the Bill Group Self-Funded Policy Pricing Rule Summary zone. 3. View the details of the policies to which a bill group is associated in the Bill Group Self-Funded Policy Information zone. 4. View the details of the pricing rules which are defined for a policy of a bill group in the Bill Group Self-Funded Policy Pricing Rules zone. 5. View the details of the pricing groups which are defined for a bill group in the Bill Group Pricing Groups zone.

If you are viewing 360° information of...	Then...
	<ol style="list-style-type: none"> 6. View the approval transactions which are created while defining, editing, or deleting a pricing rule of the parent customer and its bill groups in the Pricing Rule Approval Transactions zone.
A parent customer who is associated with a fully-insured group policy	<ol style="list-style-type: none"> 1. View the pricing rules which are defined for different entities (such as parent customer, fully-insured group policy, policy plan, and state of issue) in the Fully-Insured Pricing Rules zone. 2. View the list of pricing rules which are defined for the parent customer, fully-insured group policies, and policy plans in a tree structure in the Pricing Rule Summary zone. 3. View the approval transactions which are created while defining, editing, or deleting a pricing rule for different entities in the Pricing Rule Approval Transactions zone.

Related Topics

For more information on...	See...
How to search for a person	Searching for a Person on page 648
Customer 360° Information screen	Customer 360° Information on page 659
Pricing Information tab	Customer 360° Information - Pricing Information on page 693
How to setup the C1-ASOBLNG feature configuration	Setting the C1-ASOBLNG Feature Configuration on page 3421

Viewing the Pricing Information of a Bill Group

Prerequisites

To view the pricing information of a bill group, you should have:

- Value defined for the **Person Relationship Type** option type in the **C1-ASOBLNG** feature configuration

Procedure

To view the pricing information of a bill group:

1. Search for a person whose person type is set to **Bill Group** in the **Customer 360° View** screen.
2. In the **Search Results** section, click the **View** (🔗) icon corresponding to the person whose details you want to view.

The **Person** tab appears in the **Customer 360° Information** screen.

3. Click the **Pricing Information** tab.

The **Pricing Information** tab appears. It contains the following zones:

- [Parent Customer Pricing Rules](#) on page 696

<p>Note: The Parent Customer Pricing Rules zone appears when you are viewing 360° information of a parent customer or bill group who is associated with the self-funded policy.</p>

- [Parent Customer Pricing Rule Summary](#) on page 700

Note: The **Parent Customer Pricing Rule Summary** zone appears when you are viewing 360° information of a bill group who is associated with the self-funded policy.

- [Bill Group Self-Funded Policy Information](#) on page 701

Note: The **Bill Group Self-Funded Policy Information** zone appears when you are viewing 360° information of a parent customer or bill group who is associated with the self-funded policy.

- [Bill Group Self-Funded Policy Pricing Rules](#) on page 702

Note: The **Bill Group Self-Funded Policy Pricing Rules** zone appears when you are viewing 360° information of a parent customer or bill group who is associated with the self-funded policy.

- [Bill Group Pricing Groups](#) on page 707

Note: The **Bill Group Pricing Groups** zone appears when you are viewing 360° information of a bill group who is associated with the self-funded policy.

- [Fully-Insured Pricing Rules](#) on page 708

Note: The **Fully-Insured Pricing Rules** zone appears when you are viewing 360° information of a parent customer or bill group who is associated with the fully-insured group policy.

- [Pricing Rule Approval Transactions](#) on page 710

Note: The **Pricing Rule Approval Transactions** zone appears when you are viewing 360° information of a parent customer or bill group who is associated with the fully-insured group or self-funded policy.

4. Do either of the following:

If you are viewing 360° information of...	Then...
A bill group who is associated with a self-funded policy	<ol style="list-style-type: none"> 1. View the pricing rules which are defined for the parent customer in the Parent Customer Pricing Rules zone. 2. View the information about the parent customer and its pricing rules in a tree structure in the Parent Customer Pricing Rule Summary zone. 3. View the details of the policies to which the bill group is associated in the Bill Group Self-Funded Policy Information zone. 4. View the details of the pricing rules which are defined for a policy of the bill group in the Bill Group Self-Funded Policy Pricing Rules zone. 5. View the details of the pricing groups which are defined for the bill group in the Bill Group Pricing Groups zone. 6. View the approval transactions which are created while defining, editing, or deleting the pricing rules of the bill group in the Pricing Rule Approval Transactions zone.
A bill group who is associated with a fully-insured group policy	<ol style="list-style-type: none"> 1. View the pricing rules which are defined for different entities (such as parent customer, fully-insured group policy, policy

If you are viewing 360° information of...	Then...
	<p>plan, and state of issue) in the Fully-Insured Pricing Rules zone.</p> <p>2. View the approval transactions which are created while defining, editing, or deleting a pricing rule for different entities in the Pricing Rule Approval Transactions zone.</p>

Related Topics

For more information on...	See...
How to search for a person	Searching for a Person on page 648
Customer 360° Information screen	Customer 360° Information on page 659
Pricing Information tab	Customer 360° Information - Pricing Information on page 693
How to setup the C1-ASOBLLNG feature configuration	Setting the C1-ASOBLLNG Feature Configuration on page 3421

Customer 360° Information

The following table provides information about the **Customer 360° Information** screen:

If you are viewing the 360° information of...	Then
A parent customer who is associated with the self-funded policy	<p>The Customer 360° Information screen allows you to view:</p> <ul style="list-style-type: none"> • Basic details, characteristics, child persons, billing hierarchy, and customer contacts of the parent customer. • Sort IDs of all effective child persons whose person type is set to Bill Group and who are related to the parent customer using a relationship type which is specified in the Person Relationship Type option type of the C1-ASOBLNG feature configuration. • Derivation and pricing parameters defined for the bill group and sort ID combinations. • Customer registration objects through which the bill groups are created for the parent customer. • Accounts of all effective child persons whose person type is set to Bill Group and who are related to the parent customer using a relationship type which is specified in the Person Relationship Type option type of the C1-ASOBLNG feature configuration. • Basic details, characteristics, automatic payment options, financial and collections summary, and unpaid bills of a particular bill group's account. • List of self-funded policies to which the parent customer's bill groups are associated. • Basic details and policy persons of a self-funded policy where the parent customer is the policy holder. • Basic details of the pricing rules which are defined for the parent customer. • Summarized tree view listing each bill group of the parent customer and the bill groups' self-funded policies and pricing rules. • Basic details of the self-funded policies which are associated with each bill group of the parent customer. • Basic details of the pricing rules which are defined for the self-funded policies of each bill group. • Basic details of the active pricing groups which are defined for each bill group. • Basic information about the approval transactions which are created while defining, editing, and deleting the parent customer's and bill groups' pricing rules.

If you are viewing the 360° information of...	Then
A bill group who is associated with the self-funded policy	<p>The Customer 360° Information screen allows you to view:</p> <ul style="list-style-type: none">• Basic details, characteristics, child persons, billing hierarchy, and customer contacts of the bill group.• Basic details, characteristics, automatic payment options, financial and collections summary, and unpaid bills of the bill group’s account.• List of self-funded policies to which the bill group is associated.• Basic details and policy persons of a self-funded policy.• Summarized tree view listing the parent customer and pricing rules which are defined for the parent customer.• Basic details of the self-funded policies which are associated with the bill group.• Basic details of the pricing rules which are defined for the self-funded policies of the bill group.• Basic details of the active pricing groups which are defined for the bill group.• Basic information about the approval transactions which are created while defining, editing, and deleting the pricing rules of the bill group.

If you are viewing the 360° information of...	Then
A parent customer who is associated with the fully-insured group policy	<p>The Customer 360° Information screen allows you to view:</p> <ul style="list-style-type: none"> • Basic details, characteristics, child persons, billing hierarchy, and customer contacts of the parent customer. • Sort IDs of all effective child persons whose person type is set to Bill Group and who are related to the parent customer using a relationship type which is specified in the Person Relationship Type option type of the C1-ASOBLLNG feature configuration. • Derivation and pricing parameters defined for the bill group and sort ID combinations. • Customer registration objects through which the bill groups are created for the parent customer. • List of the parent customer's and bill groups' accounts. Note that the system lists the accounts of all effective child persons whose person type is set to Bill Group and who are related to the parent customer using a relationship type which is specified in the Person Relationship Type option type of the C1-ASOBLLNG feature configuration. • Basic details, characteristics, automatic payment options, financial and collections summary, and unpaid bills of the parent customer's or bill group's account. • List of fully-insured group policies to which the parent customer or its bill groups are associated. • Basic details, policy persons, and policy plans of a fully-insured group policy to which the parent customer or its bill group is associated. • Basic details of the pricing rules which are defined for different entities (such as parent customer, fully-insured group policy, policy plan, and state of issue). • Summarized tree view listing the pricing rules which are defined for the parent customer, fully-insured group policies, and policy plans. • Basic information about the approval transactions which are created while defining, editing, and deleting the pricing rules for different entities.

If you are viewing the 360° information of...	Then
A bill group who is associated with the fully-insured group policy	<p>The Customer 360° Information screen allows you to view:</p> <ul style="list-style-type: none"> • Basic details, characteristics, child persons, billing hierarchy, and customer contacts of the bill group. • Basic details, characteristics, automatic payment options, financial and collections summary, and unpaid bills of the bill group's account. • List of fully-insured group policies to which the bill group is associated. • Basic details, policy persons, and policy plans of the fully-insured group policy. • Basic details of the pricing rules which are defined for different entities (such as parent customer, fully-insured group policy, policy plan, and state of issue). • Basic information about the approval transactions which are created while defining, editing, and deleting the pricing rules for different entities.
A person whose person type is neither Parent Customer nor Bill Group	<p>The Customer 360° Information screen allows you to view:</p> <ul style="list-style-type: none"> • Basic details, characteristics, child persons, billing hierarchy, and customer contacts of the person. • Basic details, characteristics, automatic payment options, administrative contracts, financial and collections summary, billing and adjustment summary, and unpaid bills of the person's account. • List of policies to which the person is associated. • Basic details, policy persons, and policy plans of a policy.

This screen consists of the following tabs:

- [Customer 360° Information - Person](#) on page 663
- [Customer 360° Information - Account](#) on page 675
- [Customer 360° Information - Policy](#) on page 689
- [Customer 360° Information - Pricing Information](#) on page 693

Note: If a person does not have an account or policy, the data does not appear in the **Account** or **Policy** tab, respectively. And, if the pricing rules are not defined for the parent customer, fully-insured group or self-funded policy, fully-insured group policy plan, or state of issue, the data does not appear in the **Pricing Information** tab.

Customer 360° Information - Person

The following table provides information about the **Person** tab:

If you are viewing the 360° information of...	Then...
A parent customer who is associated with the self-funded or fully-insured group policy	The Person tab displays the following: <ul style="list-style-type: none"> • Basic details, characteristics, child persons, billing hierarchy, and customer contacts of the parent customer. • Sort IDs of all effective child persons whose person type is set to Bill Group and who are related to the parent customer using a relationship type which is specified in the Person Relationship Type option type of the C1-ASOBLNG feature configuration. • Derivation and pricing parameters defined for the bill group and sort ID combinations. • Customer registration objects through which the bill groups are created for the parent customer.
A bill group who is associated with the fully-insured group or self-funded policy	The Person tab displays the basic details, characteristics, child persons, billing hierarchy, and customer contacts of the bill group.
A person whose person type is neither Parent Customer nor Bill Group	The Person tab displays the basic details, characteristics, child persons, billing hierarchy, and customer contacts of the person.

It contains the following zones:

- [Person Information](#) on page 665
- [Person Characteristics](#) on page 666
- [Child Persons](#) on page 667
- [Person Hierarchy](#) on page 667

Note: The **Person Hierarchy** zone does not appear when you are viewing the 360° information of a person whose person type is set to **Parent Customer**.

- [Person Billing Hierarchy](#) on page 668

Note: The **Person Billing Hierarchy** zone appears when you are viewing the 360° information of a person whose person type is set to **Parent Customer**.

- [Bill Group Derivation and Pricing Parameters](#) on page 671

Note: The **Bill Group Derivation and Pricing Parameters** zone appears when you are viewing the 360° information of a person whose person type is set to **Parent Customer**.

- [Bill Group Sorting](#) on page 673

Note: The **Bill Group Sorting** zone appears when you are viewing the 360° information of a person whose person type is set to **Parent Customer**.

- [Customer Contacts](#) on page 674
- [Bill Groups Created Via Customer Registration](#) on page 675

Note: The **Bill Groups Created Via Customer Registration** zone appears when you are viewing the 360° information of a person whose person type is set to **Parent Customer**.

Related Topics

For more information on...	See...
How to view the 360° information of a person	Viewing the 360° Information of a Person on page 651
How to setup the C1-ASOBLNG feature configuration	Setting the C1-ASOBLNG Feature Configuration on page 3421

Person Information

The **Person Information** zone displays the details of the person. It contains the following sections:

- **Main** - Displays the basic information about the person. It contains the following fields:

Field Name	Field Description
Person Information	Displays information about the person. In addition, a context menu appears corresponding to this field which helps in navigating to other screens in the application. Note: It has a link. On clicking the link, the Person screen appears where you can view the details of the person.
Person Type	Indicates the type of the person. The valid values are: <ul style="list-style-type: none"> • Business • Bill Group • Group • Broker • Person • Parent Customer
Date of Birth	Displays the date when the person was born. Note: This field appears when the respective data is available for the person.

- **Person Names** - Lists the primary and non-primary names of the person. It contains the following columns:

Column Name	Column Description
Name Type	Indicates the type of the name.
Person Name	Displays the name of the person.

- **Person Identifiers** - Lists various types of identification associated with the person. It contains the following columns:

Column Name	Column Description
Person Identifier Type	Indicates the person identifier type.
Person Identifier	Displays the value of the person identifier type.

- **Contact Information** - Displays the contact details of the person. It contains the following fields:

Field Name	Field Description
Country	Indicates the country where the person is located.

Field Name	Field Description
Address 1	Displays the first line of the person's address. It may contain details, such as house number and apartment name.
Address 2	Displays the second line of the person's address. It may contain details, such as street name.
Address 3	Displays the third line of the person's address. It may contain the landmark details.
Address 4	Displays the fourth line of the person's address.
House Type	Indicates the type of the house.
Number 1	Displays the numeric information, if any, related to the address.
Number 2	Displays the numeric information, if any, related to the address.
In City Limit	Indicates whether the person resides within the city limit or not. The valid values are: <ul style="list-style-type: none"> • Yes • No
City	Displays the city where the person is located.
Geographic Code	Displays the geographic code of the address.
County	Displays the county where the person is located.
State	Indicates the state where the city or county is located.
Postal	Displays the postal or zip code of the address.
Email ID	Displays the e-mail ID of the person.

Note: The above mentioned fields appear in the **Contact Information** section when the respective data is available for the person.

- **Phone Details** – Lists the phone details of the person. It contains the following columns:

Column Name	Column Description
Phone Type	Indicates the type of the phone number.
Phone Number	Displays the phone number of the person.
Extension	Displays the telephone extension number (if any).

Person Characteristics

The **Person Characteristics** zone lists the characteristics of the person. It contains the following columns:

Column Name	Column Description
Effective Date	Displays the date from when the characteristic is effective for the person.
Characteristic Type	Indicates the characteristic type.
Characteristic Value	Displays the value of the characteristic type.

Column Name	Column Description
Description	Displays the description of the characteristic value.
	Note: The data appears in this column when the type of characteristic value is set to Predefined Value or Foreign Key Value .

You can filter the list using the **Characteristic Type** field available in the **Filter** area. By default, the **Filter** area is hidden. You can view the **Filter** area by clicking the **Filters** (∨) icon in the upper right corner of this zone.

Child Persons

The **Child Persons** zone lists the child persons included in the person's hierarchy. It contains the following columns:

Column Name	Column Description
Child Person Information	Displays information about the child person.
	Note: It has a link. On clicking the link, the Person screen appears where you can view the details of the child person.
Relationship Type	Indicates how the child person is related to the parent person.
Start Date	Displays the date from when the child person is related to the parent person.
End Date	Displays the date till when the child person is related to the parent person.

Note: Pagination is used to display limited number of records in this zone. You can use the navigation links, such as **Previous** and **Next** to navigate between pages.

You can view the 360° information of a child person by clicking the **View** (🔗) icon corresponding to the child person in this zone.

You can create a new child person through the **Customer Registration** feature by clicking the **Add** link in the upper right corner of this zone. While adding a child person to a parent person, the child person is related to the parent person using the relationship type which is specified in the **Person Relationship Type** option type of the **C1-ASOBLLNG** feature configuration.

You can filter the list using the **Person Relationship Type** field available in the **Filter** area. By default, the **Filter** area is hidden. You can view the **Filter** area by clicking the **Filters** (∨) icon in the upper right corner of this zone.

Related Topics

For more information on...	See...
How to setup the C1-ASOBLLNG feature configuration	Setting the C1-ASOBLLNG Feature Configuration on page 3421

Person Hierarchy

The **Person Hierarchy** zone lists the following in a tree structure:

- Information string of accounts where the person is the main customer
- Information string of policies where the person is associated
- Information string of membership where the person is the main subscriber
- Information string of the parent persons

It does not appear when you are viewing the 360° information of a person whose person type is set to **Parent Customer**. It contains the following column:

Column Name	Column Description												
Hierarchy	<p>Displays information about the person, account, policy, membership, and parent person in a tree structure. Each node in the tree structure has a link. The following table indicates the information string that appears in various scenarios:</p> <table border="1" data-bbox="597 411 1464 1446"> <thead> <tr> <th data-bbox="597 411 1032 464">If...</th> <th data-bbox="1032 411 1464 464">Then...</th> </tr> </thead> <tbody> <tr> <td data-bbox="597 464 1032 674">The person is the main customer of an account</td> <td data-bbox="1032 464 1464 674">The account information string appears. It has a link. On clicking the link, the 360° information of the account appears in the Account tab of the Customer 360° Information screen.</td> </tr> <tr> <td data-bbox="597 674 1032 852">The person is associated with a policy</td> <td data-bbox="1032 674 1464 852">The policy information string appears. It has a link. On clicking the link, the 360° information of the policy appears in the Policy tab of the Customer 360° Information screen.</td> </tr> <tr> <td data-bbox="597 852 1032 1062">The person is the main subscriber in a membership</td> <td data-bbox="1032 852 1464 1062">The membership information string appears. It has a link. On clicking the link, the Membership Information screen appears where you can view the details of the respective membership.</td> </tr> <tr> <td data-bbox="597 1062 1032 1241">The person is associated with a policy and is the main subscriber in a membership of its policy plan</td> <td data-bbox="1032 1062 1464 1241">The policy information string appears. It has a link. On clicking the link, the 360° information of the policy appears in the Policy tab of the Customer 360° Information screen.</td> </tr> <tr> <td data-bbox="597 1241 1032 1446">The person has a parent person</td> <td data-bbox="1032 1241 1464 1446">The person information string appears. It has a link. On clicking the link, the 360° information of the person appears in the Person tab of the Customer 360° Information screen.</td> </tr> </tbody> </table>	If...	Then...	The person is the main customer of an account	The account information string appears. It has a link. On clicking the link, the 360° information of the account appears in the Account tab of the Customer 360° Information screen.	The person is associated with a policy	The policy information string appears. It has a link. On clicking the link, the 360° information of the policy appears in the Policy tab of the Customer 360° Information screen.	The person is the main subscriber in a membership	The membership information string appears. It has a link. On clicking the link, the Membership Information screen appears where you can view the details of the respective membership.	The person is associated with a policy and is the main subscriber in a membership of its policy plan	The policy information string appears. It has a link. On clicking the link, the 360° information of the policy appears in the Policy tab of the Customer 360° Information screen.	The person has a parent person	The person information string appears. It has a link. On clicking the link, the 360° information of the person appears in the Person tab of the Customer 360° Information screen.
If...	Then...												
The person is the main customer of an account	The account information string appears. It has a link. On clicking the link, the 360° information of the account appears in the Account tab of the Customer 360° Information screen.												
The person is associated with a policy	The policy information string appears. It has a link. On clicking the link, the 360° information of the policy appears in the Policy tab of the Customer 360° Information screen.												
The person is the main subscriber in a membership	The membership information string appears. It has a link. On clicking the link, the Membership Information screen appears where you can view the details of the respective membership.												
The person is associated with a policy and is the main subscriber in a membership of its policy plan	The policy information string appears. It has a link. On clicking the link, the 360° information of the policy appears in the Policy tab of the Customer 360° Information screen.												
The person has a parent person	The person information string appears. It has a link. On clicking the link, the 360° information of the person appears in the Person tab of the Customer 360° Information screen.												

Person Billing Hierarchy

The following table lists the information which appears in the **Person Billing Hierarchy** zone:

If you are viewing the 360° information of a...	Then...
Parent Customer	<p>The following information appears in a tree structure:</p> <ul style="list-style-type: none"> • Information string of each policy to which the parent customer is associated. • Information string of each account where the parent customer is the main customer. • Information string of each effective child person whose person type is set to Bill Group) and who is related to the parent customer using a relationship type which is specified in the Person Relationship Type option type of the C1-ASOBLNG feature configuration • Information string of each policy to which the bill group is associated. • Information string of each account where the bill group is the main customer.
Bill Group	<p>The following information appears in a tree structure:</p> <ul style="list-style-type: none"> • Information string of each account where the bill group is the main customer. • Information string of each policy to which the bill group is associated. • Information string of the parent person

It appears when you are viewing the 360° information of a person whose person type is set to **Parent Customer**. It contains the following column:

Column Name	Column Description												
Hierarchy	If you are viewing the 360° information of a parent customer, the following table indicates the information string that appears in various scenarios:												
	<table border="1"> <thead> <tr> <th>If...</th> <th>Then...</th> </tr> </thead> <tbody> <tr> <td>The parent customer is associated with a policy</td> <td>The policy information string appears. It has a link. On clicking the link, the 360° information of the policy appears in the Policy tab of the Customer 360° Information screen.</td> </tr> <tr> <td>The parent customer is the main customer of an account</td> <td>The account information string appears. It has a link. On clicking the link, the 360° information of the account appears in the Account tab of the Customer 360° Information screen.</td> </tr> <tr> <td>The parent customer has a bill group</td> <td>The person information string appears. It has a link. On clicking the link, the 360° information of the bill group appears in the Person tab of the Customer 360° Information screen.</td> </tr> <tr> <td>A bill group is the main customer of an account</td> <td>The account information string appears. It has a link. On clicking the link, the 360° information of the account appears in the Account tab of the Customer 360° Information screen.</td> </tr> <tr> <td>A bill group is associated with a policy</td> <td>The policy information string appears. It has a link. On clicking the link, the 360° information of the policy appears in the Policy tab of the Customer 360° Information screen.</td> </tr> </tbody> </table>	If...	Then...	The parent customer is associated with a policy	The policy information string appears. It has a link. On clicking the link, the 360° information of the policy appears in the Policy tab of the Customer 360° Information screen.	The parent customer is the main customer of an account	The account information string appears. It has a link. On clicking the link, the 360° information of the account appears in the Account tab of the Customer 360° Information screen.	The parent customer has a bill group	The person information string appears. It has a link. On clicking the link, the 360° information of the bill group appears in the Person tab of the Customer 360° Information screen.	A bill group is the main customer of an account	The account information string appears. It has a link. On clicking the link, the 360° information of the account appears in the Account tab of the Customer 360° Information screen.	A bill group is associated with a policy	The policy information string appears. It has a link. On clicking the link, the 360° information of the policy appears in the Policy tab of the Customer 360° Information screen.
	If...	Then...											
	The parent customer is associated with a policy	The policy information string appears. It has a link. On clicking the link, the 360° information of the policy appears in the Policy tab of the Customer 360° Information screen.											
	The parent customer is the main customer of an account	The account information string appears. It has a link. On clicking the link, the 360° information of the account appears in the Account tab of the Customer 360° Information screen.											
	The parent customer has a bill group	The person information string appears. It has a link. On clicking the link, the 360° information of the bill group appears in the Person tab of the Customer 360° Information screen.											
	A bill group is the main customer of an account	The account information string appears. It has a link. On clicking the link, the 360° information of the account appears in the Account tab of the Customer 360° Information screen.											
	A bill group is associated with a policy	The policy information string appears. It has a link. On clicking the link, the 360° information of the policy appears in the Policy tab of the Customer 360° Information screen.											
	However, if you are viewing the 360° information of a bill group, the following table indicates the information string that appears in various scenarios:												
	<table border="1"> <thead> <tr> <th>If...</th> <th>Then...</th> </tr> </thead> <tbody> <tr> <td>The bill group is the main customer of an account</td> <td>The account information string appears. It has a link. On clicking the link, the 360° information of the account appears in the Account tab of the Customer 360° Information screen.</td> </tr> <tr> <td>The bill group is associated with a policy</td> <td>The policy information string appears. It has a link. On clicking the link, the 360° information of the policy appears in the Policy tab of the Customer 360° Information screen.</td> </tr> <tr> <td>The bill group has a parent person</td> <td>The person information string appears. It has a link. On clicking the link, the 360° information of the parent customer appears in the Person tab of the Customer 360° Information screen.</td> </tr> </tbody> </table>	If...	Then...	The bill group is the main customer of an account	The account information string appears. It has a link. On clicking the link, the 360° information of the account appears in the Account tab of the Customer 360° Information screen.	The bill group is associated with a policy	The policy information string appears. It has a link. On clicking the link, the 360° information of the policy appears in the Policy tab of the Customer 360° Information screen.	The bill group has a parent person	The person information string appears. It has a link. On clicking the link, the 360° information of the parent customer appears in the Person tab of the Customer 360° Information screen.				
	If...	Then...											
	The bill group is the main customer of an account	The account information string appears. It has a link. On clicking the link, the 360° information of the account appears in the Account tab of the Customer 360° Information screen.											
	The bill group is associated with a policy	The policy information string appears. It has a link. On clicking the link, the 360° information of the policy appears in the Policy tab of the Customer 360° Information screen.											
The bill group has a parent person	The person information string appears. It has a link. On clicking the link, the 360° information of the parent customer appears in the Person tab of the Customer 360° Information screen.												

Related Topics

For more information on...	See...
How to setup the C1-ASOBLNG feature configuration	Setting the CI-ASOBLNG Feature Configuration on page 3421

Bill Group Derivation and Pricing Parameters

An employer may have different bill groups. Each bill group will handle the claim and enrollment transactions of employees based on the employee attributes, such as location, employment status, employment department, and so on.

Oracle Revenue Management and Billing allows you to define the derivation and pricing parameters, such as source system, parameter 1, parameter 2, parameter 3, and parameter 4 for the bill group and sort ID combination. These parameters are used to derive the bill group against which the claim and enrollment transactions should be billed in the system. For example, if you want bill group 1 to handle claim and enrollment transactions of employees who reside in the western location of city and belong to grade A and whose transactions are received from the X system, you need to define the derivation and pricing parameters for bill group 1 where the source system is set to X, parameter 1 is set to Western, and parameter 2 is set to Grade A. Similarly, if you want bill group 2 to handle claim and enrollment transactions of employees who reside in the eastern location of city and belong to grade A and whose transactions are received from the X system, you need to define the derivation and pricing parameters for bill group 2 where the source system is set to X, parameter 1 is set to Eastern, and parameter 2 is set to Grade A.

Note: In the above examples, the bill group is derived based on the specified attributes when the source system, parameter 1, and parameter 2 are mapped to the appropriate transaction fields in the pricing rule type using which the pricing rules are defined for the bill group.

You can also define criteria for a rule in a pricing group using the parameters, such as source system, parameter 1, parameter 2, parameter 3, and parameter 4. If a pricing rule is defined for a bill group using a pricing group, you can define more than one price in the pricing rule which is offered based on the attributes of the employees.

The derivation and pricing parameters for the bill group and sort ID combination are effective from a particular date. However, the effective date must fall within the date range defined for the sort ID of the bill group.

The **Bill Group Derivation and Pricing Parameters** zone lists the derivation and pricing parameters defined for all effective child persons whose person type is set to **Bill Group** and who are related to the parent customer using a relationship type which is specified in the **Person Relationship Type** option type of the **C1-ASOBLLNG** feature configuration. It appears when you are viewing the 360° information of a person whose person type is set to **Parent Customer**.

You can define and edit the derivation and pricing parameters for a bill group (who is effective child person of the parent customer) and sort ID combination through this zone. You can also upload the derivation and pricing parameters for one or more bill group and sort ID combinations at the same time using the **Upload Request** feature. You can upload the derivation and pricing parameters for a bill group and sort ID combination either from this zone or from the **Upload Request** screen. While creating an upload request for the derivation and pricing parameters, you need to specify the parent customer whose bill groups' derivation and pricing parameters you want to upload. Once the upload request is processed, the derivation and pricing parameters are defined for the bill group and sort ID combination in the system.

This zone contains the following columns:

Column Name	Column Description
Bill Group Information	Indicates the parent customer's bill group for whom the derivation and pricing parameters are defined. In addition, a context menu appears corresponding to this column which helps in navigating to other screens in the application. Note: It has a link. On clicking the link, the Person screen appears where you can view the details of the respective bill group (i.e. person).
Bill Group ID	Displays the bill group ID (i.e. person ID).
Source System	Indicates the source system from where the claim and enrollment transactions are received.
Parameter 1	Indicates the employee attribute based on which you want to derive the bill group.
Parameter 2	Indicates the employee attribute based on which you want to derive the bill group.

Column Name	Column Description
Parameter 3	Indicates the employee attribute based on which you want to derive the bill group.
Parameter 4	Indicates the employee attribute based on which you want to derive the bill group.
Sort ID	Indicates the sort ID of the bill group.
Effective Date	Displays the date from when the derivation and pricing parameters are effective for the bill group and sort ID combination.
Status	Indicates the status of the derivation and pricing parameters defined for the bill group and sort ID combination. The valid values are: <ul style="list-style-type: none"> Active Inactive

In addition, it contains the following buttons:

Button Name	Button Description
Edit	Used to edit the derivation and pricing parameters of a bill group and sort ID combination.

If you want to edit the derivation and pricing parameters of all bill group and sort ID combinations, you need to select the check box corresponding to the column header in this zone, and then click the **Edit** button. However, if you want to edit the derivation and pricing parameters of one or more bill group and sort ID combination, you need to select the check box corresponding to the bill group and sort ID combination, and then click the **Edit** button.

Note:

Pagination is used to display limited number of records in this zone. You can use the navigation links, such as **Previous** and **Next** to navigate between pages.

If you select the check box corresponding to the column header in this zone, the system considers only those records which are present on the respective page for editing.

You can define the derivation and pricing parameters for a bill group (who is effective child person of the parent customer) and sort ID combination by clicking the **Add** link in the upper right corner of this zone. You can also upload the derivation and pricing parameters for one or more bill group (who is effective child person of the parent customer) and sort ID combinations by clicking the **Upload** link in the upper right corner of this zone.

You can filter the list using various search criteria (such as, **Parameter 1, Parameter 2, Parameter 3, Parameter 4, Bill Group ID, Sort ID, Status, and Bill Group Name**) available in the **Filter** area. By default, the **Filter** area is hidden. You can view the **Filter** area by clicking the **Filters** (🔍) icon in the upper right corner of this zone.

You can change the layout of this zone. For more information on how to change the layout, see [Changing the Layout](#) on page 3414.

Related Topics

For more information on...	See...
How to define the derivation and pricing parameters for a bill group and sort ID combination	Defining the Derivation and Pricing Parameters for a Bill Group and Sort ID Combination on page 717
How to edit the derivation and pricing parameters of a bill group and sort ID combination	Editing the Derivation and Pricing Parameters of a Bill Group and Sort ID Combination on page 719
How to create an upload request for the derivation and pricing parameters from the Bill Group Derivation and Pricing Parameters zone	Creating a Bill Group Derivation and Pricing Parameters Upload Request on page 721

For more information on...	See...
How to create an upload request for the derivation and pricing parameters from the Upload Request screen	Creating an Upload Request on page 1982
How to setup the C1-ASOBLLNG feature configuration	Setting the C1-ASOBLLNG Feature Configuration on page 3421

Bill Group Sorting

Oracle Revenue Management and Billing allows you to define unique sort IDs for a bill group in a given date range. In future, the sort ID will be used to club transactions based on certain parameters and present them in the bill in the ascending or descending order. It may also be used to sort data while generating various reports.

The **Bill Group Sorting** zone lists the sort IDs defined for all effective child persons whose person type is set to **Bill Group** and who are related to the parent customer using a relationship type which is specified in the **Person Relationship Type** option type of the **C1-ASOBLLNG** feature configuration. It appears when you are viewing the 360° information of a person whose person type is set to **Parent Customer**.

You can define, edit, and delete a sort ID of a bill group (who is effective child person of the parent customer) through this zone. You can also upload a set of sort IDs for one or more bill groups (who are effective child persons of the parent customer) at the same time using the **Upload Request** feature. You can upload the sort IDs for bill groups either from this zone or from the **Upload Request** screen. While creating an upload request for bill group sort IDs, you need to specify the parent customer whose bill groups' sort IDs you want to upload. Once the upload request is processed, the sort ID is defined for the respective bill group in the system.

This zone contains the following columns:

Column Name	Column Description
Bill Group Information	Indicates the parent customer's bill group for whom the sort ID is defined. In addition, a context menu appears corresponding to this column which helps in navigating to other screens in the application. Note: It has a link. On clicking the link, the Person screen appears where you can view the details of the respective bill group (i.e. person).
Bill Group ID	Displays the bill group ID (i.e. person ID).
Sort ID	Displays the sort ID.
Description	Displays the description of the sort ID.
Start Date	Displays the date from when the sort ID is effective for the bill group.
End Date	Displays the date till when the sort ID is effective for the bill group.

In addition, it contains the following buttons:

Button Name	Button Description
Edit	Used to edit the details of a bill group's sort ID.
Delete	Used to delete a bill group's sort ID. Note: You can delete a bill group's sort ID when the derivation and pricing parameters are not yet defined for the bill group and sort ID combination.

If you want to edit or delete all sort IDs of effective bill groups, you need to select the check box corresponding to the column header in this zone, and then accordingly click the **Edit** or **Delete** button. However, if you want to edit or delete

one or more sort IDs of effective bill groups, you need to select the check box corresponding to the bill group and sort ID combination, and then accordingly click the **Edit** or **Delete** button.

Note:

Pagination is used to display limited number of records in this zone. You can use the navigation links, such as **Previous** and **Next** to navigate between pages.

If you select the check box corresponding to the column header in this zone, the system considers only those records which are present on the respective page for editing or deleting.

You can define a sort ID for a bill group (who is effective child person of the parent customer) by clicking the **Add** link in the upper right corner of this zone. You can also upload a set of sort IDs for one or more bill groups (who are effective child persons of the parent customer) by clicking the **Upload** link in the upper right corner of this zone.

You can filter the list using the **Bill Group Name** field available in the **Filter** area. By default, the **Filter** area is hidden.

You can view the **Filter** area by clicking the **Filters** (∨) icon in the upper right corner of this zone.

You can change the layout of this zone. For more information on how to change the layout, see [Changing the Layout](#) on page 3414.

Related Topics

For more information on...	See...
How to define a sort ID for a bill group	Defining a Sort ID for a Bill Group on page 711
How to edit a sort ID of a bill group	Editing a Sort ID of a Bill Group on page 713
How to delete a sort ID of a bill group	Deleting a Sort ID of a Bill Group on page 714
How to create an upload request for bill group sort ID from the Bill Group Sorting zone	Creating a Bill Group Sorting Upload Request on page 715
How to create an upload request for bill group sort ID from the Upload Request screen	Creating an Upload Request on page 1982
How to setup the C1-ASOBLLNG feature configuration	Setting the C1-ASOBLLNG Feature Configuration on page 3421

Customer Contacts

The **Customer Contacts** zone displays information about how and when the person was contacted. It contains the following columns:

Column Name	Column Description
Contact Date	Displays the date when the person was contacted.
Customer Contact Information	Displays information about the customer contact. Note: It has a link. On clicking the link, the Customer Contact screen appears where you can view the details of the customer contact.
Contact Type	Indicates how the person was contacted.
Comments	Displays additional information about the customer contact.

You can filter the list using various search criteria (such as, **On or Before Contact Date**, **Contact Class**, **Contact Type**, and **Show Open Contacts Only**) available in the **Filter** area. By default, the **Filter** area is hidden. You can view the **Filter** area by clicking the **Filters** (∨) icon in the upper right corner of this zone.

Bill Groups Created Via Customer Registration

The **Bill Groups Created Via Customer Registration** zone lists the customer registration objects through which the parent customer's bill groups are created in the system. It appears when you are viewing the 360° information of a person whose person type is set to **Parent Customer**. It contains the following columns:

Column Name	Column Description
Customer Registration Information	Indicates the customer registration object through which the bill group is created. Note: It has a link. On clicking the link, the Customer Registration screen appears where you can view the details of the respective customer registration object.
Person Name	Displays the name of the bill group.
Person Relationship Type	Indicates how the bill group is related to the parent customer.
Status	Indicates the status of the customer registration object. The valid value is: <ul style="list-style-type: none"> Bill Group Approved

Note: Pagination is used to display limited number of records in this zone. You can use the navigation links, such as **Previous** and **Next** to navigate between pages.

You can filter the list using the **Person Relationship Type** field available in the **Filter** area. By default, the **Filter** area is hidden. You can view the **Filter** area by clicking the **Filters** () icon in the upper right corner of this zone.

Customer 360° Information - Account

The following table provides information about the **Account** tab:

If you are viewing the 360° information of...	Then...
A parent customer who is associated with the self-funded or fully-insured group policy	The Account tab displays the following: <ul style="list-style-type: none"> List of the parent customer's and bill groups' accounts. Note that the system lists the accounts of all effective child persons whose person type is set to Bill Group and who are related to the parent customer using a relationship type which is specified in the Person Relationship Type option type of the C1-ASOBLLNG feature configuration. Basic details, characteristics, automatic payment options, financial and collections summary, and unpaid bills of the parent customer's or bill group's account.
A bill group who is associated with the fully-insured group or self-funded policy	The Account tab displays the basic details, characteristics, automatic payment options, financial and collections summary, and unpaid bills of the bill group's account. Note: If the bill group has multiple accounts, the system, by default, picks and displays the details of any one of its account.

If you are viewing the 360° information of...	Then...
A person whose person type is neither Parent Customer nor Bill Group	The Account tab displays the basic details, characteristics, automatic payment options, administrative contracts, financial and collections summary, billing and adjustment summary, and unpaid bills of the person's account.
	Note: If the person has multiple accounts, the system, by default, picks and displays the details of any one of its account.

It contains the following zones:

- [Account List](#) on page 676

Note: The **Account List** zone appears when you are viewing the 360° information of a person whose person type is set to **Parent Customer**.

- [Account Information](#) on page 677
- [Auto Pay Details](#) on page 680
- [Account Characteristics](#) on page 679
- [Administrative Contracts](#) on page 680

Note: The **Administrative Contracts** zone appears when you are viewing the 360° information of a person whose person type is neither **Parent Customer** nor **Bill Group**.

- [Account Financial and Collections Summary](#) on page 681
- [Billing and Adjustment Summary](#) on page 681

Note: The **Billing and Adjustment Summary** zone appears when you are viewing the 360° information of a person whose person type is neither **Parent Customer** nor **Bill Group**.

- [Open Bills](#) on page 682
- [Billed Vs Paid](#) on page 684
- [Timeline](#) on page 686
- [Trial Bills](#) on page 689

Related Topics

For more information on...	See...
How to view the 360° information of an account	Viewing the 360° Information of an Account on page 653
How to setup the C1-ASOBLNG feature configuration	Setting the C1-ASOBLNG Feature Configuration on page 3421

Account List

The **Account List** zone lists the accounts of the parent customer and its bill groups. Note that the system lists the accounts of all effective child persons whose person type is set to **Bill Group** and who are related to the parent customer using a relationship type which is specified in the **Person Relationship Type** option type of the **C1-ASOBLNG** feature configuration. It appears when you are viewing the 360° information of a person whose person type is set to **Parent Customer**. It contains the following columns:

Column Name	Column Description
Person Name	Indicates the person who is linked to the account.

Column Name	Column Description
Account Information	Displays information about the account. In addition, a context menu appears corresponding to this column which helps in navigating to other screens in the application.
	Note: It has a link. On clicking the link, the Account screen appears where you can view the details of the respective account.
Person Type	Indicates the type of the person. The valid values are: <ul style="list-style-type: none"> • Business • Bill Group • Group • Broker • Person • Parent Customer
Person's Mailing Address	Displays the mailing address of the person.
Person ID	Displays the person ID.

Note: Pagination is used to display limited number of records in this zone. You can use the navigation links, such as **Previous** and **Next** to navigate between pages.

On clicking the **Broadcast** (🔊) icon corresponding to an account, the following zones appear in the **Account** tab:

- Account Information
- Auto Pay Details
- Account Financial and Collections Summary
- Account Characteristics
- Open Bills
- Billed Vs Paid
- Timeline

You can filter the list using various search criteria (such as, **Person Name**, **Account ID**, and **Person Type**) available in the **Filter** area. By default, the **Filter** area is hidden. You can view the **Filter** area by clicking the **Filters** (🔍) icon in the upper right corner of this zone.

Related Topics

For more information on...	See...
How to setup the C1-ASOBLNG feature configuration	Setting the CI-ASOBLNG Feature Configuration on page 3421

Account Information

The **Account Information** zone displays the details of the account. It contains the following sections:

- **Main** – Displays the basic information about the account. It contains the following fields:

Field Name	Field Description
Account Information	Displays information about the account. In addition, a context menu appears corresponding to this field which helps in navigating to other screens in the application.
	Note: It has a link. On clicking the link, the Account screen appears where you can view the details of the respective account.
Management Group	Indicates the account management group to which the account belongs.
	Note: It has a link. On clicking the link, the Account Management Group screen appears where you can view the details of the respective account management group. This field appears when the respective data is available for the account.

- **Contact Information** – Displays the contact details of the account’s main customer. It contains the following fields:

Field Name	Field Description
Address Source	Indicates which address should be used to route the account’s bills and/or quotes via the postal service.
Country	Indicates the country where the main customer is located.
Address 1	Displays the first line of the main customer’s address. It may contain details, such as house number and apartment name.
Address 2	Displays the second line of the main customer’s address. It may contain details, such as street name.
Address 3	Displays the third line of the main customer’s address. It may contain the landmark details.
Address 4	Displays the fourth line of the main customer’s address.
House Type	Indicates the type of the house.
Number 1	Displays the numeric information, if any, related to the address.
Number 2	Displays the numeric information, if any, related to the address.
In City Limit	Indicates whether the main customer resides within the city limit or not. The valid values are: <ul style="list-style-type: none"> • Yes • No
City	Displays the city where the main customer is located.
Geographic Code	Displays the geographic code of the address.
County	Displays the county where the main customer is located.
State	Indicates the state where the city or county is located.
Postal	Displays the postal or zip code of the address.

Note: The above mentioned fields except **Address Source** appear in the **Contact Information** section when the address source of the main customer is set to **Account Override** and the respective data is available for the account.

- **Account Identifiers** – Lists various types of identification associated with the account. It contains the following columns:

Column Name	Column Description
Account Identifier Type	Indicates the account identifier type.
Account Identifier	Displays the value of the account identifier type.

- **Billing** – Displays the billing information of the account. It contains the following fields:

Field Name	Field Description
Bill Cycle	Indicates the bill cycle of the account. Note: It has a link. On clicking the link, the Bill Cycle screen appears where you can view the details of the respective bill cycle. This field appears when the respective data is available for the account.
Bill After Date	Displays the date when the billing should be resumed for the account. Note: This field appears when the respective data is available for the account.
Skip Months	Indicates the months separated by comma for which billing should be skipped for the account. Note: The system derives the skip months for an account using the billing preference. You can set the billing preference for an account through a characteristic type which is specified in the Bill Cycle Rule Code option type of the C1-ASOBLLNG feature configuration. The system enables you to define, edit, delete, and copy a billing preference through the Field Mapping screen. For more information, see Defining a Billing Preference .

Account Characteristics

The **Account Characteristics** zone lists the characteristics of the account. It contains the following columns:

Column Name	Column Description
Effective Date	Displays the date from when the characteristic is effective for the account.
Characteristic Type	Indicates the characteristic type.
Characteristic Value	Displays the value of the characteristic type.
Description	Displays the description of the characteristic value. Note: The data appears in this column when the type of characteristic value is set to Predefined Value or Foreign Key Value .

You can filter the list using the **Characteristic Type** field available in the **Filter** area. By default, the **Filter** area is hidden. You can view the **Filter** area by clicking the **Filters** (∨) icon in the upper right corner of this zone.

Administrative Contracts

The **Administrative Contracts** zone lists the account's contracts which should be monitored closely for various administrative reasons. It appears when you are viewing the 360° information of a person whose person type is neither **Parent Customer** nor **Bill Group**. It contains the following columns:

Column Name	Column Description
Contract ID	Displays the contract ID.
	Note: It has a link. On clicking the link, the Contract screen appears where you can view the details of the respective contract.
Contract Type	Indicates the type of the contract.
Currency	Indicates the currency in which the contract balance is maintained.
Current Balance	Displays the current balance on the contract.

Note:

Pagination is used to display limited number of records in this zone. You can use the navigation links, such as **Previous** and **Next** to navigate between pages.

The data appears in this zone when you have defined the value for the **Administrative Contract Type** option type in the **C1_CMO** feature configuration.

Related Topics

For more information on...	See...
How to setup the C1_CMO feature configuration	Setting the C1_CMO Feature Configuration on page 3445

Auto Pay Details

The **Auto Pay Details** zone lists the automatic payment options defined for the account. It contains the following columns:

Column Name	Column Description
Start Date	Displays the date from when the automatic payment option is effective.
End Date	Displays the date till when the automatic payment option is effective.
Auto Pay Source Code	Indicates the source of funds used to make the automatic payment. For example, debit or credit card.
Last Four Digits of Card	Displays the last four digits of the debit or credit card.
	Note: The data appears in this column when the external type of the auto pay source code's tender type is set to Credit Card Withdrawal .
Percentage	Indicates the percentage of automatic payment that must be made through the automatic payment option.
Priority	Indicates the order in which the automatic payment option should be considered for the effective date range.

Note: Pagination is used to display limited number of records in this zone. You can use the navigation links, such as **Previous** and **Next** to navigate between pages.

Account Financial and Collections Summary

The **Account Financial and Collections Summary** zone displays the financial and collection details of the account. It contains the following fields:

Field Name	Field Description
Collection Class	Indicates the collection class to which the account belongs.
Current Credit Rating	Indicates the account's credit rating which is effective on the current date.
Last Credit Review Date	Displays the date when the account's debt was last reviewed.
Last Payment Date	Displays the date when the last payment was made for the account. Note: The system considers the last payment which is in the Frozen status.
Last Payment Amount	Displays the amount of the last payment. Note: The system considers the last payment which is in the Frozen status.
Current Balance	Displays the current balance of the account.
Payoff Balance	Displays the payoff balance of the account.
Account on Hold	Indicates whether the account is on hold or not. The valid values are: <ul style="list-style-type: none"> • Yes • No
Account on Promise to Pay	Indicates whether any promise to pay is scheduled for the account on the current or future date. The valid values are: <ul style="list-style-type: none"> • Yes • No
Account on Payment Arrangement	Indicates whether any payment arrangement exists for the account. The valid values are: <ul style="list-style-type: none"> • Yes • No
Account on Payment Agreement	Indicates whether any active payment agreement request exists for the account. The valid values are: <ul style="list-style-type: none"> • Yes • No

Billing and Adjustment Summary

The **Billing and Adjustment Summary** zone displays the billing and adjustment summary of the account. It appears when you are viewing the 360° information of a person whose person type is neither **Parent Customer** nor **Bill Group**. It contains the following sections:

- **Quote Billed Balance** – Displays information about the account's billed balance. It contains the following fields:

Field Name	Field Description
Past Due Billed Balance	Displays the sum of open financial transactions of the account that are listed on a bill with a past due date.
Future Due Billed Balance	Displays the sum of open financial transactions of the account that are listed on a bill with a future due date.
Quote Billed Balance	Displays the sum of past due billed balance and future due billed balance.

- **Future Adjustments and Retroactivity** – Displays information about the account’s future adjustments and retro activities. It contains the following fields:

Field Name	Field Description
Future Adjustments	Displays the sum of adjustment financial transactions of the account which are swept onto the next bill.
Future Retro Terms (Credits)	Displays the sum of canceled bill segment financial transactions of the account which are presented on the next bill.
Future Retro Adds (Debits)	Displays the sum of membership premium billable charges which are not yet billed to the account. Note: The data appears in this field when the values are defined for the Premium Amount SQI and Coverage End Date SQI option types in the C1-BILLADJSQ feature configuration.
Future Balance with Adjustments & Debits/Credits	Displays the sum of quote billed balance, future adjustments, future retro terms (credits), and future retro adds (debits).

Related Topics

For more information on...	See...
How to setup the C1-BILLADJSQ feature configuration	Setting the C1-BILLADJSQ Feature Configuration on page 3443

Open Bills

The **Open Bills** zone lists the unpaid bills of the account. By default, the bills where the unpaid amount is greater than zero are listed in this zone. It contains the following columns:

Column Name	Column Description										
Bill Date	<p>Displays the date when the bill was generated.</p> <p>Note: The data in this column is presented in a different color depending on the age bucket in which the bill's days past due falls. The following table lists the color used for presentation in various age buckets:</p> <table border="1"> <thead> <tr> <th>Age Bucket</th> <th>Color</th> </tr> </thead> <tbody> <tr> <td>Age 0 to 30 DPD</td> <td>Black</td> </tr> <tr> <td>Age 31 to 60 DPD</td> <td>Green</td> </tr> <tr> <td>Age 61 to 90 DPD</td> <td>Orange</td> </tr> <tr> <td>Age > 90 DPD</td> <td>Red</td> </tr> </tbody> </table>	Age Bucket	Color	Age 0 to 30 DPD	Black	Age 31 to 60 DPD	Green	Age 61 to 90 DPD	Orange	Age > 90 DPD	Red
Age Bucket	Color										
Age 0 to 30 DPD	Black										
Age 31 to 60 DPD	Green										
Age 61 to 90 DPD	Orange										
Age > 90 DPD	Red										
Bill ID	<p>Displays the bill ID.</p> <p>Note: It has a link. On clicking the link, the Bill screen appears where you can view the details of the respective bill.</p>										
Due Date	Displays the date when the bill is due for payment.										
Bill Amount	Displays the bill amount.										
Bill Status	<p>Indicates the status of the bill. The valid values are:</p> <ul style="list-style-type: none"> • Pending • Complete 										
Unpaid Amount	Displays the unpaid amount of the bill.										
Age Bucket	<p>Indicates the age bucket in which the bill's days past due falls. The valid values are:</p> <ul style="list-style-type: none"> • Age 0 to 30 DPD • Age 31 to 60 DPD • Age 61 to 90 DPD • Age > 90 DPD 										
Days Past Due	Displays the number of days past after the due date.										
Overdue Process Information	<p>Indicates the overdue process which is initiated for the bill and is currently in the Active status. In addition, this column has a context menu which helps in navigating to other screens in the application.</p> <p>Note: It has a link. On clicking the link, the Overdue Process screen appears where you can view the details of the respective overdue process.</p>										
Payment Agreement Request Information	<p>Indicates the active payment agreement request in which the bill is included.</p> <p>Note: It has a link. On clicking the link, the Payment Agreement Request screen appears where you can view the details of the respective payment agreement request.</p>										

You can view additional information about the bill by clicking the **View** () icon corresponding to the bill in the **Open Bills** zone.

You can filter the list using various search criteria (such as, **On or Before Bill Date** and **Show All Bills**) available in the **Filter** area. By default, the **Filter** area is hidden. You can view the **Filter** area by clicking the **Filters** () icon in the upper right corner of this zone.

Note: If you select the **Show All Bills** option, the system lists all bills where the unpaid amount is greater than or equal to zero.

Related Topics

For more information on...	See...
How to view the details of a bill	Viewing the Bill Details on page 728

Billed Vs Paid

The **Billed Vs Paid** zone lists the following transactions of the account:

- Bills which are created for the account

Note: The system lists the bills which are created for the account either manually from the user interface or automatically through the batches. It also lists the bills which are created for the account through a manual or automatic invoice request.

- Any excess credit which is made for the account
- Payments which are created or canceled for the account
- Adjustments which are created or canceled for the account
- Refund or Write Off adjustments which are created or canceled for the account
- Payment transfer to the reconciliation contract of the account
- Payment transfer from the reconciliation contract to the payor account's contract
- Reconciliations through which the account's bill segments are reconciled
- Automatic payments sent to the auto clearing house for review before freezing them

Note: The excess credit information for the account appears when you have defined the value for the **On Account Contract Type** option type in the **C1_CMO** feature configuration. Accordingly, the excess credit information (if any) on the respective contracts is listed in this zone.

It contains the following columns:

Column Name	Column Description
Due Date	Displays the date when the bill is due for payment.
	Note: The data appears in this column when the transaction type is set to Bill .
Bill ID	Displays the bill ID.
	Note: It has a link. On clicking the link, the Bill screen appears where you can view the details of the respective bill.
	The data appears in this column when the transaction type is set to Bill .

Column Name	Column Description																						
Transaction Date	<p>The following table indicates the date that appears depending on the type of the transaction:</p> <table border="1" data-bbox="548 296 1464 1010"> <thead> <tr> <th data-bbox="548 296 894 344">If the transaction type is...</th> <th data-bbox="894 296 1464 344">Then...</th> </tr> </thead> <tbody> <tr> <td data-bbox="548 344 894 392">Bill</td> <td data-bbox="894 344 1464 392">Date when the bill is generated for the account</td> </tr> <tr> <td data-bbox="548 392 894 441">Payment</td> <td data-bbox="894 392 1464 441">Date when the payment is made for the account</td> </tr> <tr> <td data-bbox="548 441 894 489">Adjustment</td> <td data-bbox="894 441 1464 489">Date when the adjustment is created for the account</td> </tr> <tr> <td data-bbox="548 489 894 537">Payment Cancellation</td> <td data-bbox="894 489 1464 537">Date when the payment is canceled for the account</td> </tr> <tr> <td data-bbox="548 537 894 627">Adjustment Cancellation</td> <td data-bbox="894 537 1464 627">Date when the adjustment is canceled for the account</td> </tr> <tr> <td data-bbox="548 627 894 676">Excess Credit (overpayment)</td> <td data-bbox="894 627 1464 676">Date when the excess credit is made for the account</td> </tr> <tr> <td data-bbox="548 676 894 766">Reconciliation Contract</td> <td data-bbox="894 676 1464 766">Date when the payment is transferred to the reconciliation contract of the account</td> </tr> <tr> <td data-bbox="548 766 894 856">Reconciliation Contract - Returned</td> <td data-bbox="894 766 1464 856">Date when the payment made to the reconciliation contract of the account is canceled</td> </tr> <tr> <td data-bbox="548 856 894 926">Payment Transfer</td> <td data-bbox="894 856 1464 926">Date when the pay instruction for the account is reconciled</td> </tr> <tr> <td data-bbox="548 926 894 1010">Payment Transfer Cancellation</td> <td data-bbox="894 926 1464 1010">Date when the reconciliation is canceled</td> </tr> </tbody> </table> <p>Note: The data does not appear in this column for automatic payments which are sent to the auto clearing house for review.</p>	If the transaction type is...	Then...	Bill	Date when the bill is generated for the account	Payment	Date when the payment is made for the account	Adjustment	Date when the adjustment is created for the account	Payment Cancellation	Date when the payment is canceled for the account	Adjustment Cancellation	Date when the adjustment is canceled for the account	Excess Credit (overpayment)	Date when the excess credit is made for the account	Reconciliation Contract	Date when the payment is transferred to the reconciliation contract of the account	Reconciliation Contract - Returned	Date when the payment made to the reconciliation contract of the account is canceled	Payment Transfer	Date when the pay instruction for the account is reconciled	Payment Transfer Cancellation	Date when the reconciliation is canceled
If the transaction type is...	Then...																						
Bill	Date when the bill is generated for the account																						
Payment	Date when the payment is made for the account																						
Adjustment	Date when the adjustment is created for the account																						
Payment Cancellation	Date when the payment is canceled for the account																						
Adjustment Cancellation	Date when the adjustment is canceled for the account																						
Excess Credit (overpayment)	Date when the excess credit is made for the account																						
Reconciliation Contract	Date when the payment is transferred to the reconciliation contract of the account																						
Reconciliation Contract - Returned	Date when the payment made to the reconciliation contract of the account is canceled																						
Payment Transfer	Date when the pay instruction for the account is reconciled																						
Payment Transfer Cancellation	Date when the reconciliation is canceled																						
Transaction Type	<p>Indicates the type of the transaction. The valid values are:</p> <ul style="list-style-type: none"> • Bill • Payment • Adjustment • Payment Cancellation • Adjustment Cancellation • Excess Credit (overpayment) • Reconciliation Contract • Reconciliation Contract - Returned • Payment Transfer • Payment Transfer Cancellation 																						
Transaction Description	<p>Displays the description of the transaction.</p> <p>Note: The data appears in this column when the transaction type is set to Adjustment, Adjustment Cancellation, Reconciliation Contract - Returned, Payment Transfer, and Payment Transfer Cancellation. In addition, the data appears in this column when the automatic payments are sent to the auto clearing house for review before freezing them. The transaction description for such payments is set to Pending Payment.</p>																						

Column Name	Column Description
Transaction Amount	Displays the transaction amount.
Unpaid Amount	Displays the unpaid amount of the bill.
	Note: The data appears in this column when the transaction type is set to Bill .
Payment Date	Displays the date when the payment is created or canceled for the account.
	Note: The data appears in this column when the transaction type is set to Payment , Payment Cancellation , or Excess Credit (overpayment) .
Tender Type	Indicates the type of tender through which the payment was made.
Check Number/External Reference ID	Displays the check number or external reference ID.
Transaction ID	Displays the payment, adjustment, or reconciliation ID.
	Note: It has a link. On clicking the link, the Payment , Adjustment , or Reconciliation screen appears where you can view the details of the respective transaction.

The **View** (🔗) icon appears corresponding to a bill in this zone. On clicking the **View** (🔗) icon corresponding to a bill, the **Bill Information** screen appears where you can view the details of the respective bill.

You can filter the list using the **On or Before Due Date** field available in the **Filter** area. By default, the **Filter** area is hidden. You can view the **Filter** area by clicking the **Filters** (🔍) icon in the upper right corner of this zone.

You can change the layout of this zone. For more information on how to change the layout, see [Changing the Layout](#) on page 3414.

Related Topics

For more information on...	See...
How to setup the C1_CMO feature configuration	Setting the C1_CMO Feature Configuration on page 3445

Timeline

The **Timeline** zone displays the following information in a graphical form:

- Number of customer contacts which are created for the account's main customer in a particular month
- Number of bills which are created for the account in a particular month
- Number of payments which are created for the account in a particular month

It contains the following fields:

Field Name	Field Description	Mandatory (Yes or No)
Month	Used to indicate the month till when you want to display the above stated information.	Yes
	Note: By default, the current month appears in this field.	

Field Name	Field Description	Mandatory (Yes or No)
Year	Used to indicate the year till when you want to display the above stated information.	Yes
	Note: By default, the current year appears in this field.	

Depending on the month and year specified in the above fields, the data for the respective month and previous 11 months is presented in the grid. For example, if the Month and Year is set to April 2017, then the data for the May 2016, Jun 2016, Jul 2016, Aug 2016, Sep 2016, Oct 2016, Nov 2016, Dec 2016, Jan 2017, Feb 2017, Mar 2017, and Apr 2017 appears in the grid. To view the data for a different period, you must accordingly change the month and year and then click **Search** (🔍) icon.

You can use the **Previous 12 Months** (⏮), **Previous Month** (⏪), **Go To Today** (🕒), **Next Month** (⏩), and **Next 12 Months** (⏭) icons to change the values specified in the above mentioned fields.

The following table indicates the data and the manner in which the data is presented in the grid:

Row Name	Row Description						
Customer Contacts	<p>A small icon appears for each customer contact which is created for the account's main customer in the respective month. For example, if two customer contacts are created for the main customer in the month of Jan 2017 and one customer contact is created in the month of Feb 2017, then two icons appear in the Jan 2017 column and one icon appear in the Feb 2017 column. A text indicating the day of the month when the customer contact was created appears on the icon. The following table indicates the color in which the icon appears depending on the condition which is satisfied:</p> <table border="1"> <thead> <tr> <th>If the contact action on the customer contact type is...</th> <th>Then the icon appears in...</th> </tr> </thead> <tbody> <tr> <td>Set to Send Letter</td> <td>Red</td> </tr> <tr> <td>Set to Action Algorithm</td> <td>Yellow</td> </tr> </tbody> </table> <p>On clicking the icon, the corresponding customer contact information appears at the bottom of this zone. It has a link. On clicking the link, the Customer Contact screen appears where you can view the details of the respective customer contact.</p> <p>Note: You can change the color in which the text appears on the icon and the color in which the icon appears when the above stated conditions are met through the C1-TL-CC-EVT algorithm.</p>	If the contact action on the customer contact type is...	Then the icon appears in...	Set to Send Letter	Red	Set to Action Algorithm	Yellow
If the contact action on the customer contact type is...	Then the icon appears in...						
Set to Send Letter	Red						
Set to Action Algorithm	Yellow						

Row Name	Row Description										
Bills	<p>A small icon appears for each bill which is created for the account in the respective month. For example, if three bills are created for the account in the month of Jan 2017, two bills are created in the month of Feb 2017, and one bill is created in the month of Apr 2017, then three icons appear in the Jan 2017 column, two icons appear in the Feb 2017 column, and one icon appears in the Apr 2017 column. A text indicating the day of the month when the bill was due appears on the icon. You can either display the day of the due date or bill date on the icon depending on the requirement. The following table indicates the color in which the icon appears depending on the condition which is satisfied:</p> <table border="1" data-bbox="467 485 1461 737"> <thead> <tr> <th data-bbox="475 493 964 533">If the bill is...</th> <th data-bbox="969 493 1453 533">Then the icon appears in...</th> </tr> </thead> <tbody> <tr> <td data-bbox="475 539 964 579">Fully Matched</td> <td data-bbox="969 539 1453 579">Green</td> </tr> <tr> <td data-bbox="475 585 964 625">Unmatched</td> <td data-bbox="969 585 1453 625">Red</td> </tr> <tr> <td data-bbox="475 632 964 672">Credit Note</td> <td data-bbox="969 632 1453 672">Blue</td> </tr> <tr> <td data-bbox="475 678 964 718">Scheduled for billing in the next bill cycle</td> <td data-bbox="969 678 1453 718">Black</td> </tr> </tbody> </table> <p>On clicking the icon, the corresponding bill information appears at the bottom of this zone. It has a link. On clicking the link, the Bill screen appears where you can view the details of the respective bill.</p> <p>Note:</p> <p>If you want to display the day of the due date on the icon, you must set the Date To Use (D-Due Date, B-Bill Date) parameter in the C1-TL-OI-EVT algorithm to D. However, if you want to display the day of the bill date on the icon, you must set the Date To Use (D-Due Date, B-Bill Date) parameter in the C1-TL-OI-EVT algorithm to B.</p> <p>You can change the color in which the text appears on the icon and the color in which the icon appears when the above stated conditions are met through the C1-TL-OI-EVT algorithm.</p>	If the bill is...	Then the icon appears in...	Fully Matched	Green	Unmatched	Red	Credit Note	Blue	Scheduled for billing in the next bill cycle	Black
If the bill is...	Then the icon appears in...										
Fully Matched	Green										
Unmatched	Red										
Credit Note	Blue										
Scheduled for billing in the next bill cycle	Black										

Row Name	Row Description												
Payments	<p>A small icon appears for each payment which is created for the account in the respective month. For example, if one payment is created for the account in the month of Aug 2016, three payments are created in the month of Dec 2016, and four payments are created in the month of Mar 2017, then one icon appears in the Aug 2016 column, three icons appear in the Dec 2016 column, and four icons appear in the Mar 2017 column. A text indicating the day of the month when the payment was created appears on the icon. The following table indicates the color in which the icon appears depending on the status of the payment:</p> <table border="1"> <thead> <tr> <th>Status</th> <th>Color</th> </tr> </thead> <tbody> <tr> <td>Frozen</td> <td>Green</td> </tr> <tr> <td>Canceled</td> <td>Red</td> </tr> <tr> <td>Freezable</td> <td>Blue</td> </tr> <tr> <td>Error</td> <td>Red</td> </tr> <tr> <td>Incomplete</td> <td>Yellow</td> </tr> </tbody> </table> <p>On clicking the icon, the corresponding payment information appears at the bottom of this zone. It has a link. On clicking the link, the Payment screen appears where you can view the details of the respective payment.</p> <p>Note: You can change the color in which the text appears on the icon and the color in which the icon appears in the different status through the C1-TL-PY-EVT algorithm.</p>	Status	Color	Frozen	Green	Canceled	Red	Freezable	Blue	Error	Red	Incomplete	Yellow
Status	Color												
Frozen	Green												
Canceled	Red												
Freezable	Blue												
Error	Red												
Incomplete	Yellow												

Trial Bills

The **Trial Bills** zone lists the trial bills which are created for the account. It contains the following columns:

Column Name	Column Description
Creation Date	Displays the date when the trial bill is created.
Trial Bill Information	<p>Displays information about the trial bill.</p> <p>Note: It has a link. On clicking the link, the Trial Bill screen appears where you can view the details of the respective trial bill.</p>
Current Charges	Displays the trial bill amount.

Customer 360° Information - Policy

The following table provides information about the **Policy** tab:

If you are viewing the 360° information of...	Then...
A parent customer who is associated with the self-funded policy	<p>The Policy tab displays the following:</p> <ul style="list-style-type: none"> List of self-funded policies to which the parent customer's bill groups are associated. <div data-bbox="769 373 1468 453" style="border: 1px solid black; padding: 5px;"> <p>Note: The system lists only those policies of the bill groups where the parent customer is associated as a policy holder.</p> </div> <ul style="list-style-type: none"> Basic details and policy persons of a self-funded policy where the parent customer is the policy holder.
A parent customer who is associated with the fully-insured group policy	<p>The Policy tab displays the following:</p> <ul style="list-style-type: none"> List of fully-insured group policies to which the parent customer or its bill groups are associated. <div data-bbox="769 688 1468 768" style="border: 1px solid black; padding: 5px;"> <p>Note: The system lists only those policies of the bill groups where the parent customer is associated as a policy holder.</p> </div> <ul style="list-style-type: none"> Basic details, policy persons, and policy plans of a fully-insured group policy to which the parent customer or its bill group is associated.
A bill group who is associated with the self-funded policy	<p>The Policy tab displays the following:</p> <ul style="list-style-type: none"> List of self-funded policies to which the bill group is associated. Basic details and policy persons of a self-funded policy.
A bill group who is associated with the fully-insured group policy	<p>The Policy tab displays the following:</p> <ul style="list-style-type: none"> List of fully-insured group policies to which the bill group is associated. Basic details, policy persons, and policy plans of a fully-insured group policy.
A person whose person type is neither Parent Customer nor Bill Group	<p>The Policy tab displays the following:</p> <ul style="list-style-type: none"> List of fully-insured group or self-funded policies to which the person is associated. Basic details, policy persons, and policy plans of a self-funded or fully-insured group policy.

It contains the following zones:

- [Policy List](#) on page 691

Note: The **Policy List** zone appears when there is more than one policy associated with the person.

- [Policy Information](#) on page 692
- [Policy Persons](#) on page 692
- [Policy Plans](#) on page 693

Note: The **Policy Plans** zone appears when you are viewing the 360° information of a person who is associated with the fully-insured group policy.

Related Topics

For more information on...	See...
How to view the 360° information of a policy	Viewing the 360° Information of a Policy on page 655

Policy List

If you are viewing 360° information of a parent customer, the **Policy List** zone lists the policies to which the parent customer and its bill groups are associated. Note that the system lists the policies of all effective child persons whose person type is set to **Bill Group** and who are related to the parent customer using a relationship type which is specified in the **Person Relationship Type** option type of the **C1-ASOBLNG** feature configuration.

Note: The system lists only those policies of the bill groups where the parent customer is associated as a policy holder.

If you are viewing 360° information of a bill group, the **Policy List** zone lists the policies to which the bill group is associated. If you are viewing 360° information of a person who is neither a parent customer nor a bill group, the **Policy List** zone lists the policies to which the person is associated. This zone appears when there is more than one policy associated with the person. It contains the following columns:

Column Name	Column Description
Policy Number	Displays the policy number.
Policy Information	Displays information about the policy. Note: It has a link. On clicking the link, the Policy screen appears where you can view the details of the respective policy.
Policy Type	Indicates the type of the policy.
Status	Indicates the status of the policy.
Start Date	Displays the date from when the policy is effective.
End Date	Displays the date till when the policy is effective.

Note: Pagination is used to display limited number of records in this zone. You can use the navigation links, such as **Previous** and **Next** to navigate between pages.

On clicking the **Broadcast** (📡) icon corresponding to a policy, the following zones appear in the **Policy** tab:

- Policy Information
- Policy Persons
- Policy Plans

You can filter the list using various search criteria (such as, **Policy Number**, **Start Date**, **Policy Type**, **End Date**, and **Status**) available in the **Filter** area. By default, the **Filter** area is hidden. You can view the **Filter** area by clicking the **Filters** (🔍) icon in the upper right corner of this zone.

Related Topics

For more information on...	See...
How to setup the C1-ASOBLNG feature configuration	Setting the C1-ASOBLNG Feature Configuration on page 3421
Policy Information zone	Policy Information on page 692
Policy Persons zone	Policy Persons on page 692

For more information on...	See...
Policy Plans zone	<i>Policy Plans</i> on page 693

Policy Information

The **Policy Information** zone displays the details of the policy. It contains the following sections:

- **Main** – Displays the basic information about the policy. It contains the following fields:

Field Name	Field Description
Policy Information	Displays information about the policy. Note: It has a link. On clicking the link, the Policy screen appears where you can view the details of the respective policy.
Source System	Displays the name of the external system in which the policy is created.
Policy Number	Displays the policy number.
Status	Indicates the status of the policy.
Start Date	Displays the date from when the policy is effective.
End Date	Displays the date till when the policy is effective.
Runout End Date	Displays the date when the runout period of the policy ends. Note: This field appears when you are viewing the 360° information of a person who is associated with a self-funded policy.
Runout Administration Fees	Indicates whether the administration fees must be charged when the claim transaction for the policy is processed in the runout period. The valid values are: <ul style="list-style-type: none"> • None • Percentage of Claim Note: This field appears when you are viewing the 360° information of a person who is associated with a self-funded policy. At present, this field is used only for the information purposes and is not considered during the billable charge creation for the claim transactions which are received in the runout period of the policy.

- **Characteristics** – Lists the characteristics defined for the policy. It contains the following columns:

Column Name	Column Description
Effective Date	Displays the date from when the characteristic is effective for the policy.
Characteristic Type	Indicates the characteristic type.
Characteristic Value	Displays the value of the characteristic type.

Policy Persons

The **Policy Persons** zone lists the persons associated with the policy. It contains the following columns:

Column Name	Column Description
Person Name	Indicates the person who is associated with the policy.
Policy Person Role	Indicates the role of the person with respect to the policy.
Start Date	Displays the date from when the person is associated with the policy.
End Date	Displays the date till when the person is associated with the policy.

Note: Pagination is used to display limited number of records in this zone. You can use the navigation links, such as **Previous** and **Next** to navigate between pages.

You can view the 360° information of a policy person by clicking the **View** () icon corresponding to the person in the **Policy Persons** zone.

Policy Plans

The **Policy Plans** zone lists the plans defined in the policy. It appears when you are viewing the 360° information of a person who is associated with the fully-insured group policy. It contains the following columns:

Column Name	Column Description
Policy Plan Information	Displays information about the policy plan. In addition, this column has a context menu which helps in navigating to other screens in the application. Note: It has a link. On clicking the link, the Policy Plan screen appears where you can view the details of the respective policy plan.
Start Date	Displays the date from when the policy plan is effective.
End Date	Displays the date till when the policy plan is effective.
Plan Name	Indicates the plan to which the policy belongs.
Benefit Type	Indicates the benefit type of the policy plan. The valid values are: <ul style="list-style-type: none"> Commercial Medicare Affiliated
No. of Subscribers	Indicates the number of main subscribers in the policy plan.
No. of Members	Indicates the number of members in the policy plan.

Note: Pagination is used to display limited number of records in this zone. You can use the navigation links, such as **Previous** and **Next** to navigate between pages.

You can filter the list using various search criteria (such as, **Plan Start Date** and **Plan End Date**) available in the **Filter** area. By default, the **Filter** area is hidden. You can view the **Filter** area by clicking the **Filters** () icon in the upper right corner of this zone.

Customer 360° Information - Pricing Information

The following table provides information about the **Pricing Information** tab:

If you are viewing the 360° information of...	Then...
A parent customer who is associated with the self-funded policy	<p>The Pricing Information tab displays the following:</p> <ul style="list-style-type: none"> • Basic details of the pricing rules which are defined for the parent customer. • Summarized tree view listing each bill group of the parent customer and the bill groups' self-funded policies and pricing rules. • Basic details of the self-funded policies which are associated with each bill group of the parent customer. • Basic details of the pricing rules which are defined for the self-funded policies of each bill group. • Basic details of the active pricing groups which are defined for each bill group. • Basic information about the approval transactions which are created while defining, editing, and deleting the parent customer's and bill groups' pricing rules.
A bill group who is associated with the self-funded policy	<p>The Pricing Information tab displays the following:</p> <ul style="list-style-type: none"> • Summarized tree view listing the parent customer and pricing rules which are defined for the parent customer. • Basic details of the self-funded policies which are associated with the bill group. • Basic details of the pricing rules which are defined for the self-funded policies of the bill group. • Basic details of the active pricing groups which are defined for the bill group. • Basic information about the approval transactions which are created while defining, editing, and deleting the pricing rules of the bill group.
A parent customer who is associated with the fully-insured group policy	<p>The Pricing Information tab displays the following:</p> <ul style="list-style-type: none"> • Basic details of the pricing rules which are defined for different entities (such as parent customer, fully-insured group policy, policy plan, and state of issue). • Summarized tree view listing the pricing rules which are defined for the parent customer, fully-insured group policies, and policy plans. • Basic information about the approval transactions which are created while defining, editing, and deleting the pricing rules for different entities.

If you are viewing the 360° information of...	Then...
A bill group who is associated with the fully-insured group policy	The Pricing Information tab displays the following: <ul style="list-style-type: none"> • Basic details of the pricing rules which are defined for different entities (such as parent customer, fully-insured group policy, policy plan, and state of issue). • Basic information about the approval transactions which are created while defining, editing, and deleting the pricing rules for different entities.
A person whose person type is neither Parent Customer nor Bill Group	No data appears in the Pricing Information tab.

It contains the following zones:

- [Parent Customer Pricing Rules](#) on page 696

Note: The **Parent Customer Pricing Rules** zone appears when you are viewing 360° information of a parent customer or bill group who is associated with the self-funded policy.

- [Bill Group Self-Funded Policy Pricing Rule Summary](#) on page 699

Note: The **Bill Group Self-Funded Policy Pricing Rule Summary** zone appears when you are viewing 360° information of a parent customer who is associated with the self-funded policy.

- [Parent Customer Pricing Rule Summary](#) on page 700

Note: The **Parent Customer Pricing Rule Summary** zone appears when you are viewing 360° information of a bill group who is associated with the self-funded policy.

- [Bill Group Self-Funded Policy Information](#) on page 701

Note: The **Bill Group Self-Funded Policy Information** zone appears when you are viewing 360° information of a parent customer or bill group who is associated with the self-funded policy.

- [Bill Group Self-Funded Policy Pricing Rules](#) on page 702

Note: The **Bill Group Self-Funded Policy Pricing Rules** zone appears when you are viewing 360° information of a parent customer or bill group who is associated with the self-funded policy.

- [Bill Group Pricing Groups](#) on page 707

Note: The **Bill Group Pricing Groups** zone appears when you are viewing 360° information of a bill group who is associated with the self-funded policy.

- [Fully-Insured Pricing Rules](#) on page 708

Note: The **Fully-Insured Pricing Rules** zone appears when you are viewing 360° information of a parent customer or bill group who is associated with the fully-insured group policy.

- [Pricing Rule Summary](#) on page 709

Note: The **Pricing Rule Summary** zone appears when you are viewing 360° information of a parent customer who is associated with the fully-insured group policy.

- [Pricing Rule Approval Transactions](#) on page 710

Note: The **Pricing Rule Approval Transactions** zone appears when you are viewing 360° information of a parent customer or bill group who is associated with the fully-insured group or self-funded policy.



Related Topics

For more information on...	See...
How to view the pricing information of a parent customer	Viewing the Pricing Information of a Parent Customer on page 655
How to view the pricing information of a bill group	Viewing the Pricing Information of a Bill Group on page 657
How to setup the C1-ASOBLLNG feature configuration	Setting the C1-ASOBLLNG Feature Configuration on page 3421

Parent Customer Pricing Rules

The **Parent Customer Pricing Rules** zone lists the pricing rules which are defined for the parent customer. It appears when you are viewing 360° information of a parent customer or bill group who is associated with the self-funded policy. It contains the following columns:

Column Name	Column Description
Pricing Rule Type	Indicates the pricing rule type using which the pricing rule is created. Note: It has a link. On clicking the link, the Pricing Rule Type screen appears where you can view the details of the respective pricing rule type.
Pricing Rule Information	Displays information about the pricing rule. Note: It has a link. On clicking the link, the Pricing Rule screen appears where you can view the details of the respective pricing rule.
Price Item Information	Indicates the price item for which the pricing rule is created. Note: It has a link. On clicking the link, the Price Item screen appears where you can view the details of the respective price item.
Start Date	Displays the date from when the pricing rule is effective.
End Date	Displays the date till when the pricing rule is effective.
Status	Indicates the status of the pricing rule. The valid values are: <ul style="list-style-type: none"> • Active • Disaggregation Initiated • Inactive • Pending

Column Name	Column Description																		
Edit	On clicking the Edit () icon, the following screen appears where you can edit the details of the respective pricing rule:																		
	<table border="1"> <thead> <tr> <th>If you are editing...</th> <th>Then the following screen appears...</th> </tr> </thead> <tbody> <tr> <td>A claim pricing rule</td> <td>Claim Pricing Rule</td> </tr> <tr> <td>A specific stop-loss pricing rule</td> <td>Specific Stop-Loss (SSL) Pricing Rule</td> </tr> <tr> <td>An aggregate stop-loss pricing rule</td> <td>Aggregate Stop-Loss (ASL) Pricing Rule</td> </tr> <tr> <td>A retention type claim based pricing rule</td> <td>Retention Type Claim Based Pricing Rule</td> </tr> <tr> <td>A retention type enrollment based pricing rule</td> <td>Retention Type Enrollment Based Pricing Rule</td> </tr> <tr> <td>An ancillary pricing rule</td> <td>Ancillary Pricing Rule</td> </tr> <tr> <td>A discount arrangement pricing rule</td> <td>Discount Arrangement Pricing Rule</td> </tr> <tr> <td>A level funded pricing rule</td> <td>Level Funded (LF) Pricing Rule</td> </tr> </tbody> </table>	If you are editing...	Then the following screen appears...	A claim pricing rule	Claim Pricing Rule	A specific stop-loss pricing rule	Specific Stop-Loss (SSL) Pricing Rule	An aggregate stop-loss pricing rule	Aggregate Stop-Loss (ASL) Pricing Rule	A retention type claim based pricing rule	Retention Type Claim Based Pricing Rule	A retention type enrollment based pricing rule	Retention Type Enrollment Based Pricing Rule	An ancillary pricing rule	Ancillary Pricing Rule	A discount arrangement pricing rule	Discount Arrangement Pricing Rule	A level funded pricing rule	Level Funded (LF) Pricing Rule
	If you are editing...	Then the following screen appears...																	
	A claim pricing rule	Claim Pricing Rule																	
	A specific stop-loss pricing rule	Specific Stop-Loss (SSL) Pricing Rule																	
	An aggregate stop-loss pricing rule	Aggregate Stop-Loss (ASL) Pricing Rule																	
	A retention type claim based pricing rule	Retention Type Claim Based Pricing Rule																	
	A retention type enrollment based pricing rule	Retention Type Enrollment Based Pricing Rule																	
	An ancillary pricing rule	Ancillary Pricing Rule																	
	A discount arrangement pricing rule	Discount Arrangement Pricing Rule																	
A level funded pricing rule	Level Funded (LF) Pricing Rule																		
Delete	On clicking the Delete () icon, you can delete the pricing rule.																		
	Note: You can delete a pricing rule only when it is not yet used in the system.																		
Price List Information	Indicates the price list that contains the price item pricing which is created through the pricing rule.																		
	Note: It has a link. On clicking the link, the Price List screen appears where you can view the details of the respective price list.																		

Note: Pagination is used to display limited number of records in this zone. You can use the navigation links, such as **Previous** and **Next** to navigate between pages.

You can define a new pricing rule for the parent customer by clicking the **Add** link in the upper right corner of this zone.

You can filter the list using various search criteria (such as, **Price Item**, **Start Date**, **Pricing Rule Type**, **End Date**, and **Status**) available in the **Filter** area. By default, the **Filter** area is hidden. You can view the **Filter** area by clicking the **Filters** () icon in the upper right corner of this zone.

You can change the layout of this zone. For more information on how to change the layout, see [Changing the Layout](#) on page 3414.

Related Topics

For more information on...	See...
How to view the pricing rules defined for a parent customer	Viewing the Pricing Rules Defined for a Self-Funded Parent Customer on page 723
How to define a claim pricing rule for a parent customer	Defining a Claim Pricing Rule for a Parent Customer on page 2575
How to edit a claim pricing rule of a parent customer	Editing a Claim Pricing Rule of a Parent Customer on page 2582

For more information on...	See...
How to delete a claim pricing rule of a parent customer	Deleting a Claim Pricing Rule of a Parent Customer on page 2585
How to view the details of a claim pricing rule defined for a parent customer	Viewing a Claim Pricing Rule of a Parent Customer on page 2584
How to define a specific stop-loss pricing rule for a parent customer	Defining a Specific Stop-Loss Pricing Rule for a Parent Customer on page 2607
How to edit a specific stop-loss pricing rule of a parent customer	Editing a Specific Stop-Loss Pricing Rule of a Parent Customer on page 2615
How to delete a specific stop-loss pricing rule of a parent customer	Deleting a Specific Stop-Loss Pricing Rule of a Parent Customer on page 2619
How to view the details of a specific stop-loss pricing rule defined for a parent customer	Viewing a Specific Stop-Loss Pricing Rule of a Parent Customer on page 2618
How to define an aggregate stop-loss pricing rule for a parent customer	Defining an Aggregate Stop-Loss Pricing Rule for a Parent Customer on page 2643
How to edit an aggregate stop-loss pricing rule of a parent customer	Editing an Aggregate Stop-Loss Pricing Rule of a Parent Customer on page 2651
How to delete an aggregate stop-loss pricing rule of a parent customer	Deleting an Aggregate Stop-Loss Pricing Rule of a Parent Customer on page 2654
How to view the details of an aggregate stop-loss pricing rule defined for a parent customer	Viewing an Aggregate Stop-Loss Pricing Rule of a Parent Customer on page 2654
How to define a retention type claim based pricing rule for a parent customer	Defining a Retention Type Claim Based Pricing Rule for a Parent Customer on page 2677
How to edit a retention type claim based pricing rule of a parent customer	Editing a Retention Type Claim Based Pricing Rule of a Parent Customer on page 2681
How to delete a retention type claim based pricing rule of a parent customer	Deleting a Retention Type Claim Based Pricing Rule of a Parent Customer on page 2684
How to view the details of a retention type claim based pricing rule defined for a parent customer	Viewing a Retention Type Claim Based Pricing Rule of a Parent Customer on page 2695
How to define a retention type enrollment based pricing rule for a parent customer	Defining a Retention Type Enrollment Based Pricing Rule for a Parent Customer on page 2705
How to edit a retention type enrollment based pricing rule of a parent customer	Editing a Retention Type Enrollment Based Pricing Rule of a Parent Customer on page 2709
How to delete a retention type enrollment based pricing rule of a parent customer	Deleting a Retention Type Enrollment Based Pricing Rule of a Parent Customer on page 2712

For more information on...	See...
How to view the details of a retention type enrollment based pricing rule defined for a parent customer	Viewing a Retention Type Enrollment Based Pricing Rule of a Parent Customer on page 2724
How to define an ancillary pricing rule for a parent customer	Defining an Ancillary Pricing Rule for a Parent Customer on page 2804
How to edit an ancillary pricing rule of a parent customer	Editing an Ancillary Pricing Rule of a Parent Customer on page 2809
How to delete an ancillary pricing rule of a parent customer	Deleting an Ancillary Pricing Rule of a Parent Customer on page 2811
How to view the details of an ancillary pricing rule defined for a parent customer	Viewing an Ancillary Pricing Rule of a Parent Customer
How to define a discount arrangement pricing rule for a parent customer	Defining a Discount Arrangement Pricing Rule for a Parent Customer on page 2842
How to edit a discount arrangement pricing rule of a parent customer	Editing a Discount Arrangement Pricing Rule of a Parent Customer on page 2850
How to delete a discount arrangement pricing rule of a parent customer	Deleting a Discount Arrangement Pricing Rule of a Parent Customer on page 2852
How to view the details of a discount arrangement pricing rule defined for a parent customer	Viewing the Discount Arrangement Pricing Rule Details of a Parent Customer
How to define a level funded pricing rule for a parent customer	Defining a Level Funded Pricing Rule for a Parent Customer on page 2875
How to edit a level funded pricing rule of a parent customer	Editing a Level Funded Pricing Rule of a Parent Customer
How to delete a level funded pricing rule of a parent customer	Deleting a Level Funded Pricing Rule of a Parent Customer
How to view the details of a level funded pricing rule defined for a parent customer	Viewing the Details of a Level Funded Pricing Rule Defined for a Policy of a Parent Customer

Bill Group Self-Funded Policy Pricing Rule Summary

The **Bill Group Self-Funded Policy Pricing Rule Summary** zone lists the following in a tree structure:

- Information string of each effective child person whose person type is set to **Bill Group**) and who is related to the parent customer using a relationship type which is specified in the **Person Relationship Type** option type of the **C1-ASOBLNG** feature configuration
- Information string of each policy to which the bill group is associated.
- Information string of each pricing rule defined for the bill group.

It appears when you are viewing 360° information of a parent customer who is associated with the self-funded policy. It contains the following column:

Column Name	Column Description																						
Hierarchy	Displays information about the bill group, policy, and pricing rule in a tree structure. A pricing rule node has a link. On clicking the link, the following screen appears where you can edit the details of the respective pricing rule:																						
	<table border="1"> <thead> <tr> <th>On clicking...</th> <th>Then the following screen appears...</th> </tr> </thead> <tbody> <tr> <td>A claim pricing rule</td> <td>Claim Pricing Rule</td> </tr> <tr> <td>A specific stop-loss pricing rule</td> <td>Specific Stop-Loss (SSL) Pricing Rule</td> </tr> <tr> <td>An aggregate stop-loss pricing rule</td> <td>Aggregate Stop-Loss (ASL) Pricing Rule</td> </tr> <tr> <td>A retention type claim based pricing rule</td> <td>Retention Type Claim Based Pricing Rule</td> </tr> <tr> <td>A retention type enrollment based pricing rule</td> <td>Retention Type Enrollment Based Pricing Rule</td> </tr> <tr> <td>A one-time flat fee pricing rule</td> <td>Flat Fee Pricing Rule</td> </tr> <tr> <td>A bill period based recurring flat fee pricing rule</td> <td>Flat Fee Pricing Rule</td> </tr> <tr> <td>A frequency based recurring flat fee pricing rule</td> <td>Flat Fee Pricing Rule</td> </tr> <tr> <td>An ancillary pricing rule</td> <td>Ancillary Pricing Rule</td> </tr> <tr> <td>A level funded pricing rule</td> <td>Level Funded (LF) Pricing Rule</td> </tr> </tbody> </table>	On clicking...	Then the following screen appears...	A claim pricing rule	Claim Pricing Rule	A specific stop-loss pricing rule	Specific Stop-Loss (SSL) Pricing Rule	An aggregate stop-loss pricing rule	Aggregate Stop-Loss (ASL) Pricing Rule	A retention type claim based pricing rule	Retention Type Claim Based Pricing Rule	A retention type enrollment based pricing rule	Retention Type Enrollment Based Pricing Rule	A one-time flat fee pricing rule	Flat Fee Pricing Rule	A bill period based recurring flat fee pricing rule	Flat Fee Pricing Rule	A frequency based recurring flat fee pricing rule	Flat Fee Pricing Rule	An ancillary pricing rule	Ancillary Pricing Rule	A level funded pricing rule	Level Funded (LF) Pricing Rule
	On clicking...	Then the following screen appears...																					
	A claim pricing rule	Claim Pricing Rule																					
	A specific stop-loss pricing rule	Specific Stop-Loss (SSL) Pricing Rule																					
	An aggregate stop-loss pricing rule	Aggregate Stop-Loss (ASL) Pricing Rule																					
	A retention type claim based pricing rule	Retention Type Claim Based Pricing Rule																					
	A retention type enrollment based pricing rule	Retention Type Enrollment Based Pricing Rule																					
	A one-time flat fee pricing rule	Flat Fee Pricing Rule																					
	A bill period based recurring flat fee pricing rule	Flat Fee Pricing Rule																					
	A frequency based recurring flat fee pricing rule	Flat Fee Pricing Rule																					
	An ancillary pricing rule	Ancillary Pricing Rule																					
A level funded pricing rule	Level Funded (LF) Pricing Rule																						

Related Topics

For more information on...	See...
How to setup the C1-ASOBLNG feature configuration	Setting the C1-ASOBLNG Feature Configuration on page 3421

Parent Customer Pricing Rule Summary

The **Parent Customer Pricing Rule Summary** zone lists the following in a tree structure:

- Information string of an effective parent person whose person type is set to **Parent Customer**
- Information string of each pricing rule which is defined for the parent customer

It appears when you are viewing 360° information of a bill group who is associated with the self-funded policy. It contains the following column:

Column Name	Column Description																		
Hierarchy	Displays information about the parent customer and its pricing rules in a tree structure. A pricing rule node has a link. On clicking the link, the following screen appears where you can edit the details of the respective pricing rule:																		
	<table border="1"> <thead> <tr> <th>On clicking...</th> <th>Then the following screen appears...</th> </tr> </thead> <tbody> <tr> <td>A claim pricing rule</td> <td>Claim Pricing Rule</td> </tr> <tr> <td>A specific stop-loss pricing rule</td> <td>Specific Stop-Loss (SSL) Pricing Rule</td> </tr> <tr> <td>An aggregate stop-loss pricing rule</td> <td>Aggregate Stop-Loss (ASL) Pricing Rule</td> </tr> <tr> <td>A retention type claim based pricing rule</td> <td>Retention Type Claim Based Pricing Rule</td> </tr> <tr> <td>A retention type enrollment based pricing rule</td> <td>Retention Type Enrollment Based Pricing Rule</td> </tr> <tr> <td>An ancillary pricing rule</td> <td>Ancillary Pricing Rule</td> </tr> <tr> <td>A discount arrangement pricing rule</td> <td>Discount Arrangement Pricing Rule</td> </tr> <tr> <td>A level funded pricing rule</td> <td>Level Funded (LF) Pricing Rule</td> </tr> </tbody> </table>	On clicking...	Then the following screen appears...	A claim pricing rule	Claim Pricing Rule	A specific stop-loss pricing rule	Specific Stop-Loss (SSL) Pricing Rule	An aggregate stop-loss pricing rule	Aggregate Stop-Loss (ASL) Pricing Rule	A retention type claim based pricing rule	Retention Type Claim Based Pricing Rule	A retention type enrollment based pricing rule	Retention Type Enrollment Based Pricing Rule	An ancillary pricing rule	Ancillary Pricing Rule	A discount arrangement pricing rule	Discount Arrangement Pricing Rule	A level funded pricing rule	Level Funded (LF) Pricing Rule
	On clicking...	Then the following screen appears...																	
	A claim pricing rule	Claim Pricing Rule																	
	A specific stop-loss pricing rule	Specific Stop-Loss (SSL) Pricing Rule																	
	An aggregate stop-loss pricing rule	Aggregate Stop-Loss (ASL) Pricing Rule																	
	A retention type claim based pricing rule	Retention Type Claim Based Pricing Rule																	
	A retention type enrollment based pricing rule	Retention Type Enrollment Based Pricing Rule																	
	An ancillary pricing rule	Ancillary Pricing Rule																	
	A discount arrangement pricing rule	Discount Arrangement Pricing Rule																	
A level funded pricing rule	Level Funded (LF) Pricing Rule																		

Related Topics

For more information on...	See...
How to setup the C1-ASOBLNG feature configuration	Setting the C1-ASOBLNG Feature Configuration on page 3421

Bill Group Self-Funded Policy Information

The **Bill Group Self-Funded Policy Information** zone appears when you are viewing 360° information of a parent customer or bill group who is associated with the self-funded policy. If you are viewing the 360° information of a parent customer, the **Bill Group Self-Funded Policy Information** zone lists the policies to which each bill group of the parent customer is associated. However, if you are viewing the 360° information of a bill group, the **Bill Group Self-Funded Policy Information** zone lists the policies to which the bill group is associated. It contains the following columns:

Column Name	Column Description
Bill Group Information	Indicates the bill group to which the policy is associated.
	Note: It has a link. On clicking the link, the Person screen appears where you can view the details of the respective bill group (i.e. person).
Policy Information	Displays information about the policy.
	Note: It has a link. On clicking the link, the Policy screen appears where you can view the details of the respective policy.
Renew	On clicking the Renew  icon, the Policy screen appears where you can renew the policy.
	Note: The Renew icon appears when the policy is in the In Force/Active status and it is not yet renewed.

Column Name	Column Description
Policy Number	Displays the policy number.
Start Date	Displays the date from when the policy is effective.
End Date	Displays the date till when the policy is effective.
Status	Indicates the status of the policy. The valid values are: <ul style="list-style-type: none"> • Pending • In Force/Active • Runout • Post Runout
Runout End Date	Displays the date when the runout period of the policy ends.
Renewal Date	Displays the date when the policy is renewed.
	Note: The data appears in this column when the policy is renewed.

Note: Pagination is used to display limited number of records in this zone. You can use the navigation links, such as **Previous** and **Next** to navigate between pages.

On clicking the **Broadcast** (📡) icon corresponding to a bill group and policy combination, the **Bill Group Self-Funded Policy Pricing Rules** and **Bill Group Pricing Groups** zones appear.

You can filter the list using various search criteria (such as, **Bill Group Name**, **Policy Start Date**, and **Policy End Date**) available in the **Filter** area. By default, the **Filter** area is hidden. You can view the **Filter** area by clicking the **Filters** (🔍) icon in the upper right corner of this zone.



Related Topics

For more information on...	See...
Bill Group Self-Funded Policy Pricing Rules zone	Bill Group Self-Funded Policy Pricing Rules on page 702
Bill Group Pricing Groups zone	Bill Group Pricing Groups on page 707
How to view the pricing rules defined for a self-funded policy of a bill group	Viewing the Pricing Rules Defined for a Self-Funded Policy of a Bill Group on page 723
How to view the pricing groups of a bill group	Viewing the Pricing Groups of a Bill Group on page 724

Bill Group Self-Funded Policy Pricing Rules

The **Bill Group Self-Funded Policy Pricing Rules** zone lists the pricing rules which are defined for a policy of a bill group. It appears when you are viewing 360° information of a parent customer or bill group who is associated with the self-funded policy. It contains the following columns:

Column Name	Column Description
Pricing Rule Type	Indicates the pricing rule type using which the pricing rule is created.
	Note: It has a link. On clicking the link, the Pricing Rule Type screen appears where you can view the details of the respective pricing rule type.

Column Name	Column Description																						
Pricing Rule Information	Displays information about the pricing rule.																						
	Note: It has a link. On clicking the link, the Pricing Rule screen appears where you can view the details of the respective pricing rule.																						
Price Item Information	Indicates the price item for which the pricing rule is created.																						
	Note: It has a link. On clicking the link, the Price Item screen appears where you can view the details of the respective price item.																						
Start Date	Displays the date from when the pricing rule is effective.																						
End Date	Displays the date till when the pricing rule is effective.																						
Status	Indicates the status of the pricing rule. The valid values are: <ul style="list-style-type: none"> • Active • Disaggregation Initiated • Inactive • Pending 																						
Edit	On clicking the Edit () icon, the following screen appears where you can edit the details of the respective pricing rule:																						
	<table border="1"> <thead> <tr> <th>If you are editing...</th> <th>Then the following screen appears...</th> </tr> </thead> <tbody> <tr> <td>A claim pricing rule</td> <td>Claim Pricing Rule</td> </tr> <tr> <td>A specific stop-loss pricing rule</td> <td>Specific Stop-Loss (SSL) Pricing Rule</td> </tr> <tr> <td>An aggregate stop-loss pricing rule</td> <td>Aggregate Stop-Loss (ASL) Pricing Rule</td> </tr> <tr> <td>A retention type claim based pricing rule</td> <td>Retention Type Claim Based Pricing Rule</td> </tr> <tr> <td>A retention type enrollment based pricing rule</td> <td>Retention Type Enrollment Based Pricing Rule</td> </tr> <tr> <td>A one-time flat fee pricing rule</td> <td>Flat Fee Pricing Rule</td> </tr> <tr> <td>A bill period based recurring flat fee pricing rule</td> <td>Flat Fee Pricing Rule</td> </tr> <tr> <td>A frequency based recurring flat fee pricing rule</td> <td>Flat Fee Pricing Rule</td> </tr> <tr> <td>An ancillary pricing rule</td> <td>Ancillary Pricing Rule</td> </tr> <tr> <td>A level funded pricing rule</td> <td>Level Funded (LF) Pricing Rule</td> </tr> </tbody> </table>	If you are editing...	Then the following screen appears...	A claim pricing rule	Claim Pricing Rule	A specific stop-loss pricing rule	Specific Stop-Loss (SSL) Pricing Rule	An aggregate stop-loss pricing rule	Aggregate Stop-Loss (ASL) Pricing Rule	A retention type claim based pricing rule	Retention Type Claim Based Pricing Rule	A retention type enrollment based pricing rule	Retention Type Enrollment Based Pricing Rule	A one-time flat fee pricing rule	Flat Fee Pricing Rule	A bill period based recurring flat fee pricing rule	Flat Fee Pricing Rule	A frequency based recurring flat fee pricing rule	Flat Fee Pricing Rule	An ancillary pricing rule	Ancillary Pricing Rule	A level funded pricing rule	Level Funded (LF) Pricing Rule
	If you are editing...	Then the following screen appears...																					
	A claim pricing rule	Claim Pricing Rule																					
	A specific stop-loss pricing rule	Specific Stop-Loss (SSL) Pricing Rule																					
	An aggregate stop-loss pricing rule	Aggregate Stop-Loss (ASL) Pricing Rule																					
	A retention type claim based pricing rule	Retention Type Claim Based Pricing Rule																					
	A retention type enrollment based pricing rule	Retention Type Enrollment Based Pricing Rule																					
	A one-time flat fee pricing rule	Flat Fee Pricing Rule																					
	A bill period based recurring flat fee pricing rule	Flat Fee Pricing Rule																					
	A frequency based recurring flat fee pricing rule	Flat Fee Pricing Rule																					
	An ancillary pricing rule	Ancillary Pricing Rule																					
A level funded pricing rule	Level Funded (LF) Pricing Rule																						
Delete	On clicking the Delete () icon, you can delete the pricing rule.																						
	Note: You can delete a pricing rule only when it is not yet used in the system.																						
Pricing Group Information	Indicates the pricing group which is used while defining the pricing rule.																						

Column Name	Column Description
Price List Information	Indicates the price list that contains the price item pricing which is created through the pricing rule.
	Note: It has a link. On clicking the link, the Price List screen appears where you can view the details of the respective price list.

Note: Pagination is used to display limited number of records in this zone. You can use the navigation links, such as **Previous** and **Next** to navigate between pages.

By default, the **Bill Group Self-Funded Policy Pricing Rules** zone does not appear in the **Pricing** tab of the **Customer 360° Information** screen. It appears when you click the **Broadcast** (📡) icon corresponding to a bill group and policy combination in the **Bill Group Self-Funded Policy Information** zone.

You can define a new pricing rule for the bill group by clicking the **Add** link in the upper right corner of this zone.

You can filter the list using various search criteria (such as, **Price Item**, **Start Date**, **Pricing Rule Type**, **End Date**, and **Status**) available in the **Filter** area. By default, the **Filter** area is hidden. You can view the **Filter** area by clicking the **Filters** (🔍) icon in the upper right corner of this zone.

You can change the layout of this zone. For more information on how to change the layout, see [Changing the Layout](#) on page 3414.

Related Topics

For more information on...	See...
How to define a claim pricing rule for a policy of a bill group	Defining a Claim Pricing Rule for a Bill Group on page 2586
How to edit a claim pricing rule defined for a policy of a bill group	Editing a Claim Pricing Rule of a Bill Group on page 2592
How to delete a claim pricing rule defined for a policy of a bill group	Deleting a Claim Pricing Rule of a Bill Group on page 2595
How to view the details of a claim pricing rule defined for a policy of a bill group	Viewing a Claim Pricing Rule of a Bill Group on page 2594
How to define a claim pricing rule for a policy of a bill group using a pricing group	Defining a Claim Pricing Rule for a Bill Group Using a Pricing Group on page 2589
How to define a specific stop-loss pricing rule for a policy of a bill group	Defining a Specific Stop-Loss Pricing Rule for a Bill Group on page 2619
How to edit a specific stop-loss pricing rule defined for a policy of a bill group	Editing a Specific Stop-Loss Pricing Rule of a Bill Group on page 2629
How to delete a specific stop-loss pricing rule defined for a policy of a bill group	Deleting a Specific Stop-Loss Pricing Rule of a Bill Group on page 2631
How to view the details of a specific stop-loss pricing rule defined for a policy of a bill group	Viewing a Specific Stop-Loss Pricing Rule of a Bill Group on page 2630
How to define a specific stop-loss pricing rule for a policy of a bill group using a pricing group	Defining a Specific Stop-Loss Pricing Rule for a Bill Group Using a Pricing Group on page 2626



For more information on...	See...
How to define an aggregate stop-loss pricing rule for a policy of a bill group	Defining an Aggregate Stop-Loss Pricing Rule for a Bill Group on page 2655
How to edit an aggregate stop-loss pricing rule defined for a policy of a bill group	Editing an Aggregate Stop-Loss Pricing Rule of a Bill Group on page 2665
How to delete an aggregate stop-loss pricing rule defined for a policy of a bill group	Deleting an Aggregate Stop-Loss Pricing Rule of a Bill Group on page 2667
How to view the details of an aggregate stop-loss pricing rule defined for a policy of a bill group	Viewing an Aggregate Stop-Loss Pricing Rule of a Bill Group on page 2666
How to define an aggregate stop-loss pricing rule for a policy of a bill group using a pricing group	Defining an Aggregate Stop-Loss Pricing Rule for a Bill Group Using a Pricing Group on page 2662
How to define a retention type claim based pricing rule for a policy of a bill group	Defining a Retention Type Claim Based Pricing Rule for a Bill Group on page 2685
How to edit a retention type claim based pricing rule defined for a policy of a bill group	Editing a Retention Type Claim Based Pricing Rule of a Bill Group on page 2688
How to delete a retention type claim based pricing rule defined for a policy of a bill group	Deleting a Retention Type Claim Based Pricing Rule of a Bill Group on page 2691
How to view the details of a retention type claim based pricing rule defined for a policy of a bill group	Viewing a Retention Type Claim Based Pricing Rule of a Bill Group on page 2696
How to define a retention type claim based pricing rule for a policy of a bill group using a pricing group	Defining a Retention Type Claim Based Pricing Rule for a Bill Group Using a Pricing Group on page 2691
How to define a retention type enrollment based pricing rule for a policy of a bill group	Defining a Retention Type Enrollment Based Pricing Rule for a Bill Group on page 2712
How to edit a retention type enrollment based pricing rule defined for a policy of a bill group	Editing a Retention Type Enrollment Based Pricing Rule of a Bill Group on page 2716
How to delete a retention type enrollment based pricing rule defined for a policy of a bill group	Deleting a Retention Type Enrollment Based Pricing Rule of a Bill Group on page 2719
How to view the details of a retention type enrollment based pricing rule defined for a policy of a bill group	Viewing a Retention Type Enrollment Based Pricing Rule of a Bill Group on page 2725
How to define a retention type enrollment based pricing rule for a policy of a bill group using a pricing group	Defining a Retention Type Enrollment Based Pricing Rule for a Bill Group Using a Pricing Group on page 2720
How to define a one-time flat fees pricing rule for a policy of a bill group	Defining a One-Time Flat Fee Pricing Rule for a Bill Group on page 2735
How to edit a one-time flat fees pricing rule defined for a policy of a bill group	Editing a One-Time Flat Fee Pricing Rule of a Bill Group on page 2739

For more information on...	See...
How to delete a one-time flat fees pricing rule defined for a policy of a bill group	Deleting a One-Time Flat Fee Pricing Rule of a Bill Group on page 2741
How to view the details of a one-time flat fees pricing rule defined for a policy of a bill group	Viewing a One-Time Flat Fee Pricing Rule of a Bill Group on page 2740
How to define a bill period based recurring flat fees pricing rule for a policy of a bill group	Defining a Bill Period Based Recurring Flat Fee Pricing Rule for a Bill Group on page 2750
How to edit a bill period based recurring flat fees pricing rule defined for a policy of a bill group	Editing a Bill Period Based Recurring Flat Fee Pricing Rule of a Bill Group on page 2754
How to delete a bill period based recurring flat fees pricing rule defined for a policy of a bill group	Deleting a Bill Period Based Recurring Flat Fee Pricing Rule of a Bill Group on page 2756
How to view the details of a bill period based recurring flat fees pricing rule defined for a policy of a bill group	Viewing a Bill Period Based Recurring Flat Fee Pricing Rule of a Bill Group on page 2755
How to define a frequency based recurring flat fees pricing rule for a policy of a bill group	Defining a Frequency Based Recurring Flat Fee Pricing Rule for a Bill Group on page 2765
How to edit a frequency based recurring flat fees pricing rule defined for a policy of a bill group	Editing a Frequency Based Recurring Flat Fee Pricing Rule of a Bill Group on page 2768
How to delete a frequency based recurring flat fees pricing rule defined for a policy of a bill group	Deleting a Frequency Based Recurring Flat Fee Pricing Rule of a Bill Group on page 2771
How to view the details of a frequency based recurring flat fees pricing rule defined for a policy of a bill group	Viewing a Frequency Based Recurring Flat Fee Pricing Rule of a Bill Group on page 2770
How to define an ancillary pricing rule for a policy of a bill group	Defining an Ancillary Pricing Rule for a Bill Group on page 2812
How to edit an ancillary pricing rule defined for a policy of a bill group	Editing an Ancillary Pricing Rule of a Bill Group on page 2817
How to delete an ancillary pricing rule defined for a policy of a bill group	Deleting an Ancillary Pricing Rule of a Bill Group on page 2819
How to view the details of an ancillary pricing rule defined for a policy of a bill group	Viewing an Ancillary Pricing Rule of a Bill Group
How to define an ancillary pricing rule for a policy of a bill group using a pricing group	Defining an Ancillary Pricing Rule for a Bill Group Using a Pricing Group
How to define a level funded pricing rule for a policy of a bill group	Defining a Level Funded Pricing Rule for a Bill Group on page 2885
How to edit a level funded pricing rule defined for a policy of a bill group	Editing a Level Funded Pricing Rule of a Bill Group

For more information on...	See...
How to delete a level funded pricing rule defined for a policy of a bill group	Deleting a Level Funded Pricing Rule Defined for a Policy of a Bill Group
How to view the details of a level funded pricing rule defined for a policy of a bill group	Viewing the Details of a Level Funded Pricing Rule Defined for a Policy of a Bill Group
How to define a level funded pricing rule for a policy of a bill group using a pricing group	Defining a Level Funded Pricing Rule for a Bill Group on page 2885

Bill Group Pricing Groups

The **Bill Group Pricing Groups** zone lists the pricing groups which are defined for the bill group. By default, the active pricing groups are listed in this zone. It appears when you are viewing 360° information of a bill group who is associated with the self-funded policy. It contains the following columns:

Column Name	Column Description
Pricing Group	Indicates the pricing group which is created for the bill group.
Status	Indicates the status of the pricing group. The valid values are: <ul style="list-style-type: none"> • Active • Inactive
Edit	On clicking the Edit () icon, the Pricing Group screen appears where you can edit the details of the pricing group.
Delete	On clicking the Delete () icon, you can delete the pricing group.
	Note: You can delete a pricing group when it is not yet used while defining a pricing rule for the bill group.
Duplicate	On clicking the Duplicate () icon, the Pricing Group screen appears where you can define a new pricing group using an existing pricing group.
Associated Price Items	Indicates the price items whose pricing is defined using the pricing group.

Note: Pagination is used to display limited number of records in this zone. You can use the navigation links, such as **Previous** and **Next** to navigate between pages.

By default, the **Bill Group Pricing Groups** zone does not appear in the **Pricing** tab of the **Customer 360° Information** screen. It appears when you click the **Broadcast** () icon corresponding to a bill group in the **Bill Group Self-Funded Policy Information** zone.

You can define a new pricing group for the bill group by clicking the **Add** link in the upper right corner of this zone.

You can filter the list using the **Show All** field available in the **Filter** area. By default, the **Filter** area is hidden. You can view the **Filter** area by clicking the **Filters** () icon in the upper right corner of this zone.

Note: If you select the **Yes** option from the **Show All** list, the system lists both the active and inactive pricing groups in the **Bill Group Pricing Groups** zone.

You can change the layout of this zone. For more information on how to change the layout, see [Changing the Layout](#) on page 3414.

Related Topics

For more information on...	See...
How to define a pricing group for a bill group	Defining a Pricing Group for a Bill Group on page 2523
How to edit a pricing group of a bill group	Editing a Pricing Group of a Bill Group on page 2526
How to copy a pricing group of a bill group	Copying a Pricing Group of a Bill Group on page 2529
How to delete a pricing group of a bill group	Deleting a Pricing Group of a Bill Group on page 2529

Fully-Insured Pricing Rules

The **Fully-Insured Pricing Rules** zone appears when you are viewing 360° information of a parent customer or bill group who is associated with the fully-insured group policy. If you are viewing the 360° information of a parent customer, the **Fully-Insured Pricing Rules** zone lists:

- Age based or tier based pricing rules defined for the parent customer's or its bill groups' fully-insured group policy plans
- Additional charge pricing rules defined for the parent customer
- Additional charge pricing rules defined for the fully-insured group policies and policy plans of the parent customer and its bill groups
- Additional charge pricing rules defined for the states where the fully-insured group policy, its policy plans, and memberships are issued

However, if you are viewing the 360° information of a bill group, the **Fully-Insured Pricing Rules** zone lists:

- Age based or tier based pricing rules defined for the bill group's fully-insured group policy plans
- Additional charge pricing rules defined for the parent customer
- Additional charge pricing rules defined for the fully-insured group policies and policy plans of the parent customer and the bill group
- Additional charge pricing rules defined for the states where the fully-insured group policy, its policy plans, and memberships are issued

It contains the following columns:

Column Name	Column Description
Pricing Rule Type	Indicates the pricing rule type using which the pricing rule is created.
	Note: It has a link. On clicking the link, the Pricing Rule Type screen appears where you can view the details of the respective pricing rule type.
Pricing Rule Information	Displays information about the pricing rule.
	Note: It has a link. On clicking the link, the Pricing Rule screen appears where you can view the details of the respective pricing rule.
Price Item Information	Indicates the price item for which the pricing rule is created.
	Note: It has a link. On clicking the link, the Price Item screen appears where you can view the details of the respective price item.

Column Name	Column Description
Pricing Level	Indicates the level at which the pricing rule is defined. The valid values are: <ul style="list-style-type: none"> • Parent Customer • Plan • Policy • State
Entity Information	Indicates the fully-insured group policy, policy plan, parent customer, or state for which the pricing rule is defined.
Start Date	Displays the date from when the pricing rule is effective.
End Date	Displays the date till when the pricing rule is effective.
Price List Information	Indicates the price list that contains the price item pricing which is created through the pricing rule. Note: It has a link. On clicking the link, the Price List screen appears where you can view the details of the respective price list.

Note: Pagination is used to display limited number of records in this zone. You can use the navigation links, such as **Previous** and **Next** to navigate between pages.

You can filter the list using various search criteria (such as, **Price Item**, **Start Date**, **Pricing Rule Type**, **End Date**, **Status**, and **Pricing Level**) available in the **Filter** area. By default, the **Filter** area is hidden. You can view the **Filter** area by clicking the **Filters** (🔍) icon in the upper right corner of this zone.

Related Topics

For more information on...	See...
How to view the pricing rules defined for a fully-insured group policy	Viewing the Pricing Rules Defined for a Fully-Insured Group Policy on page 730
How to view the pricing rules defined for a parent customer	Viewing the Pricing Rules Defined for a Fully-Insured Parent Customer on page 731
How to view the pricing rules defined for a fully-insured policy plan	Viewing the Pricing Rules Defined for a Fully-Insured Group Policy Plan on page 729
How to view the pricing rules defined for a state where the fully-insured group policy, its policy plan, or membership is issued	Viewing the Pricing Rules Defined for the State of Issue on page 732

Pricing Rule Summary

The **Pricing Rule Summary** zone lists the following in a tree structure:

- Information string of the parent customer
- Information string of the pricing rule defined for the parent customer
- Information string of each fully-insured group policy where the parent customer is associated
- Information string of the pricing rule defined for the fully-insured group policy of the parent customer
- Information string of each plan defined for the fully-insured group policy of the parent customer
- Information string of the pricing rule defined for the fully-insured group policy plans

It appears when you are viewing 360° information of a parent customer who is associated with the fully-insured group policy. It contains the following column:

Column Name	Column Description
Hierarchy	Displays information about the parent customer, fully-insured group policies, policy plans, and pricing rules in a tree structure.

Pricing Rule Approval Transactions

The **Pricing Rule Approval Transactions** zone lists the following information:

If you are viewing the 360° information of...	Then...
A parent customer who is associated with the self-funded policy	The Pricing Rule Approval Transactions zone lists the approval transactions which are created while defining, editing, and deleting the parent customer's and bill groups' pricing rules.
A bill group who is associated with the self-funded policy	The Pricing Rule Approval Transactions zone lists the approval transactions which are created while defining, editing, and deleting the pricing rules of the bill group.
A parent customer who is associated with the fully-insured group policy	The Pricing Rule Approval Transactions zone lists the approval transactions which are created while defining, editing, and deleting the pricing rules of different entities (such as parent customer, fully-insured group policy, policy plans, and state of issue).
A bill group who is associated with the fully-insured group policy	The Pricing Rule Approval Transactions zone lists the approval transactions which are created while defining, editing, and deleting the pricing rules of different entities (such as parent customer, fully-insured group policy, policy plans, and state of issue).

It contains the following columns:

Column Name	Column Description
Submitted On	Displays the date and time when the approval transaction is created by the submitter.
Approval Transaction ID	Displays the approval transaction ID. Note: It has a link. On clicking the link, the Comparison: New versus Existing screen appears where you can review and accordingly approve, reject, or revert the changes.
Pricing Level	Indicates whether the approval transaction is created for a pricing rule which is defined at the parent customer or bill group level. The valid values are: <ul style="list-style-type: none"> Parent Customer Bill Group
Person Name	Indicates the person for whom the pricing rule is created.
Pricing Rule Type	Indicates the pricing rule type using which the pricing rule is created.
Price Item Information	Indicates the price item for which the pricing rule is created. Note: It has a link. On clicking the link, the Price Item screen appears where you can view the details of the respective price item.

Column Name	Column Description
Start Date	Displays the date from when the pricing rule is effective.
End Date	Displays the date till when the pricing rule is effective.
Approval Status	Indicates the status of the approval transaction. The valid values are: <ul style="list-style-type: none"> • Approved • Cancelled • Deleted • Inprocess • Pending • Rejected
Action	Indicates the type of action performed by the submitter on the pricing rule. The valid values are: <ul style="list-style-type: none"> • Add • Update • Delete
Submitted By	Indicates the user who has performed the action on the pricing rule.
Assigned To	Indicates the user to whom the approval transaction is manually assigned for review.
Approved/Rejected By	Indicates the user who has approved or rejected the approval transaction.

Note: Pagination is used to display limited number of records in this zone. You can use the navigation links, such as **Previous** and **Next** to navigate between pages.

You can filter the list using various search criteria (such as, **Status**, **Assigned To**, and **Price Item**) available in the **Filter** area. By default, the **Filter** area is hidden. You can view the **Filter** area by clicking the **Filters** () icon in the upper right corner of this zone.

Defining a Sort ID for a Bill Group

Prerequisites

To define a sort ID for a bill group, you should have:

- Effective child persons whose person type is set to **Bill Group** and who are related to the parent customer using a relationship type which is specified in the **Person Relationship Type** option type of the **C1-ASOBLNG** feature configuration

Procedure

To define a sort ID for a bill group:

1. Search for a person whose person type is set to **Parent Customer** in the **Customer 360° View** screen.
2. In the **Search Results** section, click the **View** () icon corresponding to the person whose details you want to view.

The **Person** tab appears in the **Customer 360° Information** screen.

3. Expand the **Bill Group Sorting** zone.

Note: The **Bill Group Sorting** zone appears when you are viewing the 360° information of a person whose person type is set to **Parent Customer**.

- Click the **Add** link in the upper right corner of the **Bill Group Sorting** zone.

The **Bill Group Sorting** screen appears. It contains the following field:

Field Name	Field Description
Parent Customer	Indicates the parent customer whose bill groups' sort IDs you want to define.

In addition, it contains the following fields in a grid:

Field Name	Field Description	Mandatory (Yes or No)
Bill Group Information	Used to indicate the bill group for whom you want to define the sort ID.	Yes
	Note: The values appear in this list when there are effective child persons whose person type is set to Bill Group and who are related to the parent customer using a relationship type which is specified in the Person Relationship Type parameter of the C1-ASOBLNG feature configuration.	
Description	Used to specify the description for the sort ID.	Yes
Sort ID	Used to specify the sort ID.	Yes
Start Date	Used to specify the date from when the sort ID is effective for the bill group.	Yes
	Note: The start date cannot be later than the end date.	
End Date	Used to specify the date till when the sort ID is effective for the bill group.	No
	Note: The end date cannot be earlier than the start date.	

- Enter the required details in the grid.
- If you want to define more than one sort ID for a bill group, click the **Add**  icon and then repeat step 5.

Note: However, if you want to remove a sort ID of a bill group, click the **Delete**  icon corresponding to the bill group and sort ID combination.

- Click **Save**.

A sort ID is defined for the bill group.

Related Topics

For more information on...	See...
How to search for a person	Searching for a Person on page 648
Customer 360° Information screen	Customer 360° Information on page 659
Person tab	Customer 360° Information - Person on page 663

For more information on...	See...
Bill Group Sorting zone	Bill Group Sorting on page 673
How to setup the C1-ASOBLNG feature configuration	Setting the C1-ASOBLNG Feature Configuration on page 3421

Editing a Sort ID of a Bill Group

Procedure

To edit a sort ID of a bill group:

1. Search for a person whose person type is set to **Parent Customer** in the **Customer 360° View** screen.
2. In the **Search Results** section, click the **View** (🔗) icon corresponding to the person whose details you want to view.

The **Person** tab appears in the **Customer 360° Information** screen.

3. Expand the **Bill Group Sorting** zone.

Note: The **Bill Group Sorting** zone appears when you are viewing the 360° information of a person whose person type is set to **Parent Customer**.

4. In the **Bill Group Sorting** zone, select the check box corresponding to the bill group and sort ID combination whose details you want to edit.

Note: If you want to edit all sort IDs of effective bill groups, you need to select the check box corresponding to the column header. In such case, the system considers only those records which are present on the respective page for editing.

5. Click **Edit**.

The **Bill Group Sorting** screen appears. It contains the following field:

Field Name	Field Description
Parent Customer	Indicates the parent customer whose bill groups' sort IDs you want to edit.

In addition, it contains the following fields in a grid:

Field Name	Field Description	Mandatory (Yes or No)
Bill Group Information	Indicates the bill group whose sort ID you want to edit.	Not applicable
Description	Used to specify the description for the sort ID.	Yes
Sort ID	Displays the sort ID.	Not applicable
Start Date	Used to specify the date from when the sort ID is effective for the bill group. Note: The start date cannot be later than the end date. The start date cannot be later than the effective date specified in the derivation and pricing parameters which are defined for the bill group and sort ID combination.	Yes

Field Name	Field Description	Mandatory (Yes or No)
End Date	Used to specify the date till when the sort ID is effective for the bill group.	No
	<p>Note:</p> <p>The end date cannot be earlier than the start date.</p> <p>The end date cannot be earlier than the effective date specified in the derivation and pricing parameters which are defined for the bill group and sort ID combination.</p>	

6. Modify the details of a bill group's sort ID, if required.
7. Click **Save**.

The changes made to the bill group's sort ID are saved.

Related Topics

For more information on...	See...
How to search for a person	Searching for a Person on page 648
Customer 360° Information screen	Customer 360° Information on page 659
Person tab	Customer 360° Information - Person on page 663
Bill Group Sorting zone	Bill Group Sorting on page 673

Deleting a Sort ID of a Bill Group

Procedure

To delete a sort ID of a bill group:

1. Search for a person whose person type is set to **Parent Customer** in the **Customer 360° View** screen.
2. In the **Search Results** section, click the **View** (🔗) icon corresponding to the person whose details you want to view.

The **Person** tab appears in the **Customer 360° Information** screen.

3. Expand the **Bill Group Sorting** zone.

Note: The **Bill Group Sorting** zone appears when you are viewing the 360° information of a person whose person type is set to **Parent Customer**.

4. In the **Bill Group Sorting** zone, select the check box corresponding to the bill group and sort ID combination that you want to delete.

Note: If you want to delete all sort IDs of effective bill groups, you need to select the check box corresponding to the column header. In such case, the system considers only those records which are present on the respective page for deleting.

5. Click **Delete**.

A message appears confirming whether you want to delete the bill group's sort ID.

Note: You can delete a bill group's sort ID when the derivation and pricing parameters are not yet defined for the bill group and sort ID combination.

6. Click **OK**.

The bill group's sort ID is deleted.

Related Topics

For more information on...	See...
How to search for a person	Searching for a Person on page 648
Customer 360° Information screen	Customer 360° Information on page 659
Person tab	Customer 360° Information - Person on page 663
Bill Group Sorting zone	Bill Group Sorting on page 673

Creating a Bill Group Sorting Upload Request

Procedure

To create a bill group sorting upload request:

1. Search for a person whose person type is set to **Parent Customer** in the **Customer 360° View** screen.
2. In the **Search Results** section, click the **View** () icon corresponding to the person whose details you want to view.

The **Person** tab appears in the **Customer 360° Information** screen.

3. Expand the **Bill Group Sorting** zone.

Note: The **Bill Group Sorting** zone appears when you are viewing the 360° information of a person whose person type is set to **Parent Customer**.

4. Click the **Upload** link in the upper right corner of the **Bill Group Sorting** zone.

The **Select Upload Request Type** screen appears. It contains the following field:

Field Name	Field Description	Mandatory (Yes or No)
Upload Request Type	Used to indicate the upload request type using which you want to create the upload request.	Yes
	Note: The list includes only those upload request types where the upload request business object with the Upload Type option type set to BG is selected.	

Note: The **Select Upload Request Type** screen appears when there are multiple upload request types where the upload request business object with the **Upload Type** option type set to **BG** is selected. If there is only one such upload request type defined in the application, the **Bill Group Sorting Upload Request** screen appears.

5. Select the required upload request type from the respective field.
6. Click **OK**.

The **Bill Group Sorting Upload Request** screen appears. It contains the following sections:

- **Main** – Used to specify basic details about the upload request.
- **Characteristics** – Used to define the characteristics for the upload request.

The **Main** section contains the following fields:

Field Name	Field Description	Mandatory (Yes or No)
Upload Request Type	Indicates the upload request type using which the bill group sorting upload request will be created.	Not applicable
Parent Customer	Used to indicate the person for whom you want to create the bill group sorting upload request. Note: By default, the parent customer's ID appears in this field. You can change the person, if required. The system allows you to create a bill group sorting upload request for a person whose person type is set to Parent Customer . The Search (🔍) icon appears corresponding to this field. On clicking the Search icon, the Person Search window appears.	Yes
File Name	Used to specify the name and path of the file that you want to upload. Note: You can also click the Browse button corresponding to this field to browse to the location where the file is available in the system.	Yes
Replace Existing File	Used to indicate whether you want to replace any existing file in the system. You must select this check box when you want to upload the same file once again.	No
Comments	Used to specify additional information about the upload request.	No

7. Click the **Browse** button corresponding to the **File Name** field.

The **Choose File to Upload** dialog box appears.

8. Browse to the location where the file that you want to upload is available in the system.
9. Click **Open**.

The file name along with the path appears in the **File Name** field.

10. Select the **Replace Existing File** check box depending on whether you want to upload the same file once again in the system.
11. Define characteristics for the upload request, if required.

12. Click Save.

A message appears indicating the number of records which are successfully uploaded. Then, a bill group sorting upload request is created in the **Draft** status. If the bill group ID is available in the record, the status of the record is set to **Pending**. However, if the system could not derive the bill group ID using the bill group identifier type and bill group identifier combination when the bill group ID is not specified in the record, the status of the record is set to **Invalid**.

Related Topics

For more information on...	See...
How to search for a person	Searching for a Person on page 648
Customer 360° Information screen	Customer 360° Information on page 659
Person tab	Customer 360° Information - Person on page 663
Bill Group Sorting zone	Bill Group Sorting on page 673
How to define a characteristic for an upload request	Defining a Characteristic for an Upload Request on page 1985

Defining the Derivation and Pricing Parameters for a Bill Group and Sort ID Combination

Prerequisites

To define the derivation and pricing parameters for a bill group and sort ID combination, you should have:

- Effective child persons whose person type is set to **Bill Group** and who are related to the parent customer using a relationship type which is specified in the **Person Relationship Type** option type of the **C1-ASOBLNG** feature configuration
- Sort ID defined for the bill group
- Values defined for the **C1-SourceSystemLookup** extendable lookup

Procedure

To define the derivation and pricing parameters for a bill group and sort ID combination:

1. Search for a person whose person type is set to **Parent Customer** in the **Customer 360° View** screen.
2. In the **Search Results** section, click the **View** (🔗) icon corresponding to the person whose details you want to view.

The **Person** tab appears in the **Customer 360° Information** screen.

3. Expand the **Bill Group Derivation and Pricing Parameters** zone.

Note: The **Bill Group Derivation and Pricing Parameters** zone appears when you are viewing the 360° information of a person whose person type is set to **Parent Customer**.

4. Click the **Add** link in the upper right corner of the **Bill Group Derivation and Pricing Parameters** zone.

The **Bill Group Derivation and Pricing Parameters** screen appears. It contains the following field:

Field Name	Field Description
Parent Customer	Indicates the parent customer whose bill groups' derivation and pricing parameters you want to define.

In addition, it contains the following fields in a grid:

Field Name	Field Description	Mandatory (Yes or No)
Source System	Used to indicate the source system from where the claim and enrollment transactions are received.	Yes
Parameter 1	Used to specify the employee attribute based on which you want to derive the bill group. Note: You must not specify the ampersand (&) character in this field.	Yes
Parameter 2	Used to specify the employee attribute based on which you want to derive the bill group. Note: You must not specify the ampersand (&) character in this field.	No
Parameter 3	Used to specify the employee attribute based on which you want to derive the bill group. Note: You must not specify the ampersand (&) character in this field.	No
Parameter 4	Used to specify the employee attribute based on which you want to derive the bill group. Note: You must not specify the ampersand (&) character in this field.	No
Effective Date	Used to specify the date from when the derivation and pricing parameters are effective for the bill group and sort ID combination. Note: The effective date must be within the date range of the sort ID defined for the bill group.	Yes
Status	Indicates the status of the derivation and pricing parameters for the bill group and sort ID combination. The valid values are: <ul style="list-style-type: none"> • Active • Inactive Note: By default, the value is set to Active .	Not applicable
Bill Group Information	Used to indicate the bill group for whom you want to define the derivation and pricing parameters. Note: The values appear in this list when there are effective child persons whose person type is set to Bill Group and who are related to the parent customer using a relationship type which is specified in the Person Relationship Type parameter of the C1-ASOBLNG feature configuration.	Yes

Field Name	Field Description	Mandatory (Yes or No)
Sort ID	Used to indicate the sort ID of the bill group for which you want to define the derivation and pricing parameters.	Yes
	Note: The Search (🔍) icon appears corresponding to this field. On clicking the Search icon, the Sort ID Search window appears.	

- Enter the required details in the grid.
- If you want to define the derivation and pricing parameters for more than one bill group and sort ID combination, click the **Add** (+) icon and then repeat step 5.

Note: However, if you want to remove the derivation and pricing parameters of a bill group and sort ID combination, click the **Delete** (🗑️) icon corresponding to the bill group and sort ID combination.

- Click **Save**.

The derivation and pricing parameters are defined for the bill group and sort ID combination.

Related Topics

For more information on...	See...
How to search for a person	Searching for a Person on page 648
Customer 360° Information screen	Customer 360° Information on page 659
Person tab	Customer 360° Information - Person on page 663
Bill Group Derivation and Pricing Parameters zone	Bill Group Derivation and Pricing Parameters on page 671
How to setup the C1-ASOBLNG feature configuration	Setting the C1-ASOBLNG Feature Configuration on page 3421

Editing the Derivation and Pricing Parameters of a Bill Group and Sort ID Combination

Procedure

To edit the derivation and pricing parameters of a bill group and sort ID combination:

- Search for a person whose person type is set to **Parent Customer** in the **Customer 360° View** screen.
- In the **Search Results** section, click the **View** (🔗) icon corresponding to the person whose details you want to view.

The **Person** tab appears in the **Customer 360° Information** screen.

- Expand the **Bill Group Derivation and Pricing Parameters** zone.

Note: The **Bill Group Derivation and Pricing Parameters** zone appears when you are viewing the 360° information of a person whose person type is set to **Parent Customer**.

- In the **Bill Group Derivation and Pricing Parameters** zone, select the check box corresponding to the bill group and sort ID combination whose details you want to edit.

Note: If you want to edit the derivation and pricing parameters of all bill group and sort ID combinations, you need to select the check box corresponding to the column header. In such case, the system considers only those records which are present on the respective page for editing.

5. Click **Edit**.

The **Bill Group Derivation and Pricing Parameters** screen appears. It contains the following field:

Field Name	Field Description
Parent Customer	Indicates the parent customer whose bill groups' derivation and pricing parameters you want to edit.

In addition, it contains the following fields in a grid:

Field Name	Field Description	Mandatory (Yes or No)
Source System	Indicates the source system from where the claim and enrollment transactions are received.	Not applicable
Parameter 1	Indicates the employee attribute based on which you want to derive the bill group.	Not applicable
Parameter 2	Indicates the employee attribute based on which you want to derive the bill group.	Not applicable
Parameter 3	Indicates the employee attribute based on which you want to derive the bill group.	Not applicable
Parameter 4	Indicates the employee attribute based on which you want to derive the bill group.	Not applicable
Effective Date	Displays the date from when the derivation and pricing parameters are effective for the bill group and sort ID combination.	Not applicable
Status	Used to indicate the status of the derivation and pricing parameters for the bill group and sort ID combination. The valid values are: <ul style="list-style-type: none"> Active Inactive 	Yes
Bill Group Information	Indicates the bill group for whom the derivation and pricing parameters are defined.	Not applicable
Sort ID	Indicates the sort ID of the bill group for which the derivation and pricing parameters are defined.	Not applicable

6. If required, you can inactivate the derivation and pricing parameters of a bill group and sort ID combination.

7. Click **Save**.

The changes made to the derivation and pricing parameters of a bill group and sort ID combination are saved.

Related Topics

For more information on...	See...
How to search for a person	Searching for a Person on page 648
Customer 360° Information screen	Customer 360° Information on page 659

For more information on...	See...
Person tab	Customer 360° Information - Person on page 663
Bill Group Derivation and Pricing Parameters zone	Bill Group Derivation and Pricing Parameters on page 671

Creating a Bill Group Derivation and Pricing Parameters Upload Request

Procedure

To create a bill group derivation and pricing parameters upload request:

1. Search for a person whose person type is set to **Parent Customer** in the **Customer 360° View** screen.
2. In the **Search Results** section, click the **View** (🔗) icon corresponding to the person whose details you want to view.

The **Person** tab appears in the **Customer 360° Information** screen.

3. Expand the **Bill Group Derivation and Pricing Parameters** zone.

Note: The **Bill Group Derivation and Pricing Parameters** zone appears when you are viewing the 360° information of a person whose person type is set to **Parent Customer**.

4. Click the **Upload** link in the upper right corner of the **Bill Group Derivation and Pricing Parameters** zone.

The **Select Upload Request Type** screen appears. It contains the following field:

Field Name	Field Description	Mandatory (Yes or No)
Upload Request Type	Used to indicate the upload request type using which you want to create the upload request.	Yes
	Note: The list includes only those upload request types where the upload request business object with the Upload Type option type set to BL is selected.	

Note: The **Select Upload Request Type** screen appears when there are multiple upload request types where the upload request business object with the **Upload Type** option type set to **BL** is selected. If there is only one such upload request type defined in the application, the **Bill Group Derivation and Pricing Parameters Upload Request** screen appears.

5. Select the required upload request type from the respective field.
6. Click **OK**.

The **Bill Group Derivation and Pricing Parameters Upload Request** screen appears. It contains the following sections:

- **Main** – Used to specify basic details about the upload request.
- **Characteristics** – Used to define the characteristics for the upload request.

The **Main** section contains the following fields:

Field Name	Field Description	Mandatory (Yes or No)
Upload Request Type	Indicates the upload request type using which the bill group derivation and pricing parameters upload request will be created.	Not applicable
Parent Customer	<p>Used to indicate the person for whom you want to create the bill group derivation and pricing parameters upload request.</p> <p>Note: By default, the parent customer's ID appears in this field. You can change the person, if required.</p> <p>The system allows you to create a bill group derivation and pricing parameters upload request for a person whose person type is set to Parent Customer.</p> <p>The Search (🔍) icon appears corresponding to this field. On clicking the Search icon, the Person Search window appears.</p>	Yes
File Name	<p>Used to specify the name and path of the file that you want to upload.</p> <p>Note: You can also click the Browse button corresponding to this field to browse to the location where the file is available in the system.</p>	Yes
Replace Existing File	Used to indicate whether you want to replace any existing file in the system. You must select this check box when you want to upload the same file once again.	No
Comments	Used to specify additional information about the upload request.	No

- Click the **Browse** button corresponding to the **File Name** field.

The **Choose File to Upload** dialog box appears.

- Browse to the location where the file that you want to upload is available in the system.

- Click **Open**.

The file name along with the path appears in the **File Name** field.

- Select the **Replace Existing File** check box depending on whether you want to upload the same file once again in the system.

- Define characteristics for the upload request, if required.

- Click **Save**.

A message appears indicating the number of records which are successfully uploaded. Then, a bill group derivation and pricing parameters upload request is created in the **Draft** status. If the bill group ID is available in the record, the status of the record is set to **Pending**. However, if the system could not derive the bill group ID using the bill

group identifier type and bill group identifier combination when the bill group ID is not specified in the record, the status of the record is set to **Invalid**.

Related Topics

For more information on...	See...
How to search for a person	Searching for a Person on page 648
Customer 360° Information screen	Customer 360° Information on page 659
Person tab	Customer 360° Information - Person on page 663
Bill Group Derivation and Pricing Parameters zone	Bill Group Derivation and Pricing Parameters on page 671
How to define a characteristic for an upload request	Defining a Characteristic for an Upload Request on page 1985

Viewing the Pricing Rules Defined for a Self-Funded Policy of a Bill Group

Procedure

To view the pricing rules defined for a self-funded policy of a bill group:

1. Search for the bill group whose is associated with the self-funded policy in the **Customer 360° View** screen.
2. In the **Search Results** section, click the **View** () icon corresponding to the bill group whose details you want to view.

The **Person** tab appears in the **Customer 360° Information** screen.

3. Click the **Pricing Information** tab.

The **Pricing Information** tab appears.

4. In the **Bill Group Self-Funded Policy Information** zone, click the **Broadcast** () icon corresponding to a bill group and policy combination whose details you want to view.

The **Bill Group Self-Funded Policy Pricing Rules** and **Bill Group Pricing Groups** zones appear.

5. View the pricing rules which are defined for the self-funded policy of the bill group in the **Bill Group Self-Funded Policy Pricing Rules** zone.

Related Topics

For more information on...	See...
How to search for a person	Searching for a Person on page 648
Customer 360° Information screen	Customer 360° Information on page 659
Pricing Information tab	Customer 360° Information - Pricing Information on page 693
Bill Group Self-Funded Policy Information zone	Bill Group Self-Funded Policy Information on page 701
Bill Group Self-Funded Policy Pricing Rules zone	Bill Group Self-Funded Policy Pricing Rules on page 702

Viewing the Pricing Rules Defined for a Self-Funded Parent Customer

Procedure

To view the pricing rules defined for a self-funded parent customer:

1. Search for the parent customer who is associated with the self-funded policy in the **Customer 360° View** screen.
2. In the **Search Results** section, click the **View** () icon corresponding to the parent customer whose details you want to view.
The **Person** tab appears in the **Customer 360° Information** screen.
3. Click the **Pricing Information** tab.
The **Pricing Information** tab appears.
4. View the pricing rules which are defined for the self-funded parent customer in the **Parent Customer Pricing Rules** zone.



Related Topics

For more information on...	See...
How to search for a person	Searching for a Person on page 648
Customer 360° Information screen	Customer 360° Information on page 659
Pricing Information tab	Customer 360° Information - Pricing Information on page 693
Parent Customer Pricing Rules zone	Parent Customer Pricing Rules on page 696

Viewing the Pricing Groups of a Bill Group

Procedure

To view the pricing groups of a bill group:

1. Search for the bill group whose is associated with the self-funded policy in the **Customer 360° View** screen.
2. In the **Search Results** section, click the **View** () icon corresponding to the bill group whose details you want to view.
The **Person** tab appears in the **Customer 360° Information** screen.
3. Click the **Pricing Information** tab.
The **Pricing Information** tab appears.
4. In the **Bill Group Self-Funded Policy Information** zone, click the **Broadcast** () icon corresponding to a bill group whose pricing groups you want to view.
The **Bill Group Self-Funded Policy Pricing Rules** and **Bill Group Pricing Groups** zones appear.
5. View the pricing groups which are defined for the bill group and are currently active in the **Bill Group Pricing Groups** zone.

Related Topics

For more information on...	See...
How to search for a person	Searching for a Person on page 648
Customer 360° Information screen	Customer 360° Information on page 659
Pricing Information tab	Customer 360° Information - Pricing Information on page 693
Bill Group Self-Funded Policy Information zone	Bill Group Self-Funded Policy Information on page 701
Bill Group Pricing Groups zone	Bill Group Pricing Groups on page 707

Renewing a Self-Funded Policy of a Bill Group

Oracle Revenue Management and Billing enables you to renew a self-funded policy which is associated with a bill group. However, note that you can renew a self-funded policy when it is in the **In Force/Active** status and is not yet renewed. For more information, see [Self-Funded Policy Renewal](#) on page 399.

Procedure

To renew a self-funded policy of a bill group:

1. Search for the bill group who is associated with the self-funded policy (which you want to renew) in the **Customer 360° View** screen.
2. In the **Search Results** section, click the **View** () icon corresponding to the bill group whose details you want to view.

The **Person** tab appears in the **Customer 360° Information** screen.

3. Click the **Pricing Information** tab.

The **Pricing Information** tab appears.

4. In the **Bill Group Self-Funded Policy Information** zone, click the **Renew** () icon in the **Renew** column corresponding to the self-funded policy which you want to renew.

The **Policy** screen appears. It contains the following sections:

- **Main** - Used to specify basic details about the renewed policy.
- **Persons** - Used to associate or disassociate persons from the renewed policy.

Note: You cannot disassociate persons who are associated with the base policy using a policy person role which is specified in the **Bill Group Policy Person Role** or **Parent Customer Policy Person Role** option type of the **C1-ASOBLNG** feature configuration.

- **Characteristics** - Used to define the characteristics for the renewed policy.

The **Main** section contains the following fields:

Field Name	Field Description	Mandatory (Yes or No)
Base Policy Information	Indicates the policy which you want to renew.	Not applicable
Policy Type	Indicates the policy type using which the base policy is created.	Not applicable
Policy Number	Used to specify the policy number of the renewed policy.	Yes
Description	Used to specify the description for the renewed policy.	Yes

Field Name	Field Description	Mandatory (Yes or No)
Start Date	Used to specify the date from when the renewed policy is effective.	Yes
	<p>Note:</p> <p>By default, the start date is set to the base policy's end date plus one day. For example, if the base policy's end date is 12-31-2018, then by default, the renewed policy's start date is set to 01-01-2019.</p> <p>The start date cannot be later than the end date.</p> <p>The start date cannot be earlier than or equal to the base policy's end date.</p>	
End Date	Used to specify the date till when the renewed policy is effective.	Yes
	<p>Note: The end date cannot be earlier than the start date.</p>	
Runout End Date	Used to specify the date when the runout period of the renewed policy ends.	No
	<p>Note: The runout end date cannot be earlier than or equal to the renewed policy's end date.</p>	
Runout Administration Fees	Used to indicate whether the administration fees must be charged when the claim transaction for the policy is processed in the runout period. The valid values are: <ul style="list-style-type: none"> • None • Percentage of Claim 	No
	<p>Note: At present, this field is used only for the informational purposes and is not considered during the billable charge creation for the claim transactions which are received in the runout period of the policy.</p>	

Field Name	Field Description	Mandatory (Yes or No)
Copy Pricing Rules	<p>Used to indicate whether you want to copy the pricing rules of the base policy to the renewed policy. If you select the Copy Pricing Rules option, the system copies the following pricing rules of the base policy:</p> <ul style="list-style-type: none"> • Claim • Retention Type Claim Based • Retention Type Enrollment Based • Recurring Flat Fees • Ancillary <p>Note:</p> <p>While copying a pricing rule, the start and end dates of the new pricing rule are set to the renewed policy's start and end dates, respectively.</p> <p>If there are multiple pricing rules which are created using the same pricing rule type and are effective for the different date range, the system copies only one pricing rule from the base policy with the latest date range.</p>	No
Copy Advance Level Funding Eligibility	<p>Used to indicate whether you want to copy the advance level funding eligibility value of the base policy to the renewed policy.</p> <p>Note:</p> <p>If the Copy Advance Level Funding Eligibility option is set to Y in the base policy, the system activates the renewed self-funded policy on the policy renewal even if the renewed policy's start date is later than the system date.</p> <p>This field appears only when you want to renew a self-funded policy.</p>	No

Note: The **Renew** icon appears when the policy is in the **In Force/Active** status and it is not yet renewed.

5. Enter the required details in the **Main** section.
6. Associate or disassociate persons from the renewed policy, if required.
7. Define, edit, or remove characteristics of the renewed policy, if required.
8. Click **Save**.

The renewed policy is created in the **Pending** status. The renewal date is stamped corresponding to the base policy in the **Bill Group Self-Funded Policy Information** zone.

Related Topics

For more information on...	See...
How to search for a person	Searching for a Person on page 648

For more information on...	See...
Customer 360° Information screen	Customer 360° Information on page 659
Pricing Information tab	Customer 360° Information - Pricing Information on page 693
Bill Group Self-Funded Policy Information zone	Bill Group Self-Funded Policy Information on page 701
How to associate a person with a policy	Associating a Person with a Policy on page 311
How to define a characteristic for a policy	Defining a Characteristic for a Policy on page 313
How to setup the C1-ASOBLNG feature configuration	Setting the C1-ASOBLNG Feature Configuration on page 3421

Viewing the Bill Details

Procedure

To view the details of a bill:

1. Search for the account, whose bill details you want to view, in the **Customer 360° View** screen.
2. In the **Search Results** section, click the **View** (🔗) icon corresponding to the account whose details you want to view.
The **Account** tab appears in the **Customer 360° Information** screen.
3. In the **Open Bills** zone, click the **View** (🔗) icon corresponding to the bill whose details you want to view.
The **Bill Information** screen appears.
4. View the basic details of the bill in the **Bill Information** zone.
5. View the adjustments which are swept onto the bill in the **Adjustments** zone.
6. View the activities, such as payment, transfer, offset, refund, or write off through which the bill is settled, in the **Settlement Activities** zone.
7. View the bill segment information, which is summarized based on the date range and price item combination, in the **Bill Segment Summary** zone.
8. View the details of the bill segments in the **Bill Segment Details** zone.
9. View the SQ details of the bill segment in the **SQ Details** zone.
10. View the calculation lines of the bill segment in the **Bill Segment Calculation Lines** zone.
11. View the transactions whose charges are billed through the bill segment in the **Transaction Details** zone.
12. View the calculation lines of all transaction legs (which are rated before billing) in the **Transaction Leg Calculation Lines** zone.
13. View the active hold requests due to which the bill is kept on hold in the **Hold Details** zone.
14. View the offset requests through which the bill is offset against another bill in the **Offset Details** zone.
15. View the refund and write off requests through which the bill or its bill segment is either refunded or written off in the **Refund and Write Off Details** zone.

Related Topics

For more information on...	See...
How to search for an account	Searching for an Account on page 649

For more information on...	See...
Customer 360° Information screen	Customer 360° Information on page 659
Account tab	Customer 360° Information - Account on page 675
Open Bills zone	Open Bills on page 682
Bill Information screen	Bill Information on page 732
Bill Information zone	Bill Information on page 733
Adjustments zone	Adjustments on page 733
Settlement Activities zone	Settlement Activities on page 734
Bill Segment Summary zone	Bill Segment Summary on page 734
Bill Segment Details zone	Bill Segment Details on page 735
SQ Details zone	SQ Details on page 736
Bill Segment Calculation Lines zone	Bill Segment Calculation Lines on page 737
Transaction Details zone	Transaction Details on page 737
Transaction Leg Calculation Lines zone	Transaction Leg Calculation Lines on page 738
Hold Details zone	Hold Details on page 739
Offset Details zone	Offset Details on page 740
Refund and Write Off Details zone	Refund and Write Off Details on page 740
How to view the SQ details of a bill segment	Viewing the SQ Details of a Bill Segment on page 741
How to view the calculation lines of a bill segment	Viewing the Calculation Lines of a Bill Segment on page 742
How to view the transactions whose charges are billed through a bill segment	Viewing the Transactions Whose Charges are Billed Through a Bill Segment on page 742
How to view the calculation lines of all legs of a transaction	Viewing the Calculation Lines of All Legs of a Transaction on page 743

Viewing the Pricing Rules Defined for a Fully-Insured Group Policy Plan

Procedure

To view the pricing rules defined for a fully-insured group policy plan:

1. Search for the fully-insured group policy in the **Customer 360° View** screen.
2. In the **Search Results** section, click the **View** () icon corresponding to the policy whose details you want to view.

The **Policy** tab appears in the **Customer 360° Information** screen.

3. Click the **Pricing Information** tab.

The **Pricing Information** tab appears.

Note:

By default, the **Fully-Insured Pricing Rules** zone lists the pricing rules which are defined for the following entities:

- Parent customer of the fully-insured group policy
- Fully-insured group policy
- Fully-insured group policy plans
- States where the fully-insured group policy and its policy plans and memberships are issued

4. Select the **Plan** option from the **Pricing Level** list in the **Fully-Insured Pricing Rules** zone.
5. Click **Search**.

The pricing rules (if any) defined for the policy plans of the fully-insured group policy are listed in the **Fully-Insured Pricing Rules** zone.

Related Topics

For more information on...	See...
How to search for a policy	Searching for a Policy on page 650
Customer 360° Information screen	Customer 360° Information on page 659
Pricing Information tab	Customer 360° Information - Pricing Information on page 693
Fully-Insured Pricing Rules zone	Fully-Insured Pricing Rules on page 708

Viewing the Pricing Rules Defined for a Fully-Insured Group Policy**Procedure**

To view the pricing rules defined for a fully-insured group policy:

1. Search for the fully-insured group policy in the **Customer 360° View** screen.
2. In the **Search Results** section, click the **View** () icon corresponding to the policy whose details you want to view.

The **Policy** tab appears in the **Customer 360° Information** screen.

3. Click the **Pricing Information** tab.

The **Pricing Information** tab appears.

Note:

By default, the **Fully-Insured Pricing Rules** zone lists the pricing rules which are defined for the following entities:

- Parent customer of the fully-insured group policy
- Fully-insured group policy
- Fully-insured group policy plans
- States where the fully-insured group policy and its policy plans and memberships are issued

4. Select the **Policy** option from the **Pricing Level** list in the **Fully-Insured Pricing Rules** zone.

5. Click **Search**.

The pricing rules (if any) defined for the fully-insured group policy are listed in the **Fully-Insured Pricing Rules** zone.

Related Topics

For more information on...	See...
How to search for a policy	Searching for a Policy on page 650
Customer 360° Information screen	Customer 360° Information on page 659
Pricing Information tab	Customer 360° Information - Pricing Information on page 693
Fully-Insured Pricing Rules zone	Fully-Insured Pricing Rules on page 708

Viewing the Pricing Rules Defined for a Fully-Insured Parent Customer

Procedure

To view the pricing rules defined for a fully-insured parent customer:

1. Search for the parent customer who is associated with the fully-insured group policy in the **Customer 360° View** screen.
2. In the **Search Results** section, click the **View** (🔗) icon corresponding to the parent customer whose details you want to view.
The **Person** tab appears in the **Customer 360° Information** screen.
3. Click the **Pricing Information** tab.
The **Pricing Information** tab appears.

Note:

By default, the **Fully-Insured Pricing Rules** zone lists the pricing rules which are defined for the following entities:

- Parent customer of the fully-insured group policy
- Fully-insured group policy
- Fully-insured group policy plans
- States where the fully-insured group policy and its policy plans and memberships are issued

4. Select the **Parent Customer** option from the **Pricing Level** list in the **Fully-Insured Pricing Rules** zone.
5. Click **Search**.

The pricing rules (if any) defined for the parent customer are listed in the **Fully-Insured Pricing Rules** zone.

Related Topics

For more information on...	See...
How to search for a person	Searching for a Person on page 648
Customer 360° Information screen	Customer 360° Information on page 659
Pricing Information tab	Customer 360° Information - Pricing Information on page 693

For more information on...	See...
Fully-Insured Pricing Rules zone	Fully-Insured Pricing Rules on page 708

Viewing the Pricing Rules Defined for the State of Issue

Procedure

To view the pricing rules defined for the states where the fully-insured group policy, its policy plans, and memberships are issued:

1. Search for the fully-insured group policy in the **Customer 360° View** screen.
2. In the **Search Results** section, click the **View** () icon corresponding to the policy whose details you want to view.

The **Policy** tab appears in the **Customer 360° Information** screen.

3. Click the **Pricing Information** tab.

The **Pricing Information** tab appears.

Note:

By default, the **Fully-Insured Pricing Rules** zone lists the pricing rules which are defined for the following entities:

- Parent customer of the fully-insured group policy
- Fully-insured group policy
- Fully-insured group policy plans
- States where the fully-insured group policy and its policy plans and memberships are issued

4. Select the **State** option from the **Pricing Level** list in the **Fully-Insured Pricing Rules** zone.
5. Click **Search**.

The pricing rules (if any) defined for the states, where the fully-insured group policy, its policy plans, and memberships are issued, are listed in the **Fully-Insured Pricing Rules** zone.

Related Topics

For more information on...	See...
How to search for a policy	Searching for a Policy on page 650
Customer 360° Information screen	Customer 360° Information on page 659
Pricing Information tab	Customer 360° Information - Pricing Information on page 693
Fully-Insured Pricing Rules zone	Fully-Insured Pricing Rules on page 708

Bill Information

The **Bill Information** screen allows you to view:

- Basic details of the bill
- Adjustments which are swept onto the bill
- Activities, such as payment, offset, refund, write off, or transfer through which the bill is settled

- High-level summary and details of the bill segments which are included in the bill
- Active hold requests due to which the bill is kept on hold
- Offset requests through which the bill is offset against another bill
- Refund and write off requests through which the bill or its bill segment is either refunded or written off

It contains the following zones:

- [Bill Information](#) on page 733
- [Adjustments](#) on page 733
- [Settlement Activities](#) on page 734
- [Bill Segment Summary](#) on page 734
- [Bill Segment Details](#) on page 735
- [SQ Details](#) on page 736
- [Bill Segment Calculation Lines](#) on page 737
- [Transaction Details](#) on page 737
- [Transaction Leg Calculation Lines](#) on page 738
- [Hold Details](#) on page 739
- [Offset Details](#) on page 740
- [Refund and Write Off Details](#) on page 740

Bill Information

The **Bill Information** zone displays the details of the bill. It contains the following section:

- **Main** - Displays the basic information about the bill. It contains the following fields:

Field Name	Field Description
Bill Information	<p>Displays information about the bill. In addition, a context menu appears corresponding to this field which helps in navigating to other screens in the application.</p> <p>Note: It has a link. On clicking the link, the Bill screen appears where you can view the details of the respective bill.</p>
Alternate Bill ID	<p>Displays the alternate bill ID.</p> <p>Note: This field appears only when the respective data is available for the bill.</p>
Account Information	<p>Indicates the account for which the bill is generated. In addition, a context menu appears corresponding to this field which helps in navigating to other screens in the application.</p> <p>Note: It has a link. On clicking the link, the Account screen appears where you can view the details of the respective account.</p>

Adjustments

The **Adjustments** zone lists the adjustments which are swept onto the bill. It contains the following columns:

Column Name	Column Description
Adjustment Information	Displays information about the adjustment.
	Note: It has a link. On clicking the link, the Adjustment screen appears where you can view the details of the respective adjustment.
Contract Information	Indicates the contract against which the adjustment is created. In addition, this column has a context menu which helps in navigating to other screens in the application.
	Note: It has a link. On clicking the link, the Contract screen appears where you can view the details of the respective contract.

Settlement Activities

You may settle a bill or its bill segment by making a payment, offsetting, refunding, writing off, or by reconciling against pay instructions. The **Settlement Activities** zone lists the activities related to the bill or its bill segment settlement. It contains the following columns:

Column Name	Column Description
Activity Date	Displays the date when the settlement activity was performed in the system.
Activity Type	Indicates the type of the settlement activity. The valid values are: <ul style="list-style-type: none"> • Payment • Offset • Refund • Write Off • Transfer
Amount	Indicates the amount settled through the activity.
Related Object Information	Displays additional information about the settlement activity.
Related Object ID	Indicates the payment, offset request, refund request, write off request, or reconciliation adjustment which is created during settlement.
	Note: It has a link. On clicking the link, the Payment, Offset Request, Refund Request, Write Off Request, or Adjustment screen appears where you can view the details of the respective activity.

Bill Segment Summary

The system groups the bill segments with the same date range and price item combination and then provides the summarized information for each combination in the **Bill Segment Summary** zone. It contains the following columns:

Column Name	Column Description
Start Date	Displays the start date of the bill segments.
End Date	Displays the end date of the bill segments.
Policy Number	Indicates the policy for which the bill segments are generated.
Price Item Description	Indicates the price item for which the bill segments are generated.

Column Name	Column Description
Amount	Displays the sum of the bill segment amount.
Unpaid Amount	Displays the sum of the unpaid amount of the bill segments.

Note: Pagination is used to display limited number of records in this zone. You can use the navigation links, such as **Previous** and **Next** to navigate between pages.

Bill Segment Details

The **Bill Segment Details** zone displays the details of the bill segments which are included in the bill. It contains the following columns:

Column Name	Column Description
Start Date	Displays the start date of the bill segment.
End Date	Displays the end date of the bill segment.
Policy Number	Indicates the policy for which the bill segment is generated.
Price Item Description	Displays the description of the price item.
Price Item	Indicates the price item for which the bill segment is generated.
Status	Indicates the status of the bill segment. The valid values are: <ul style="list-style-type: none"> • Incomplete • Error • Freezable • Pending Cancel • Frozen • Canceled
Amount	Displays the bill segment amount.
Billable Charge ID	Indicates the billable charge for which the bill segment is generated. <p>Note: It has a link. On clicking the link, the Billable Charge screen appears where you can view the details of the respective billable charge.</p>
Unpaid Amount	Displays the unpaid amount of the bill segment.
Price Item Parameters	Displays the concatenated string consisting of a list of parameters and their values based on which the price item pricing is defined.
External Membership ID	Indicates the membership for which the bill segment is generated.
Member's Primary Identifier	Displays the concatenated string consisting of member's primary identifier type and its value which are separated by a colon (:).
Member Name	Indicates the member for whom the bill segment is generated.
Plan Information	Indicates the plan to which the membership belongs. <p>Note: It has a link. On clicking the link, the Policy Plan screen appears where you can view the details of the respective policy plan.</p>

Column Name	Column Description
Auto Pay ID	Indicates the auto pay instruction through the automatic payment is created for the bill segment. Note: It has a link. On clicking the link, the Auto Pay Instruction screen appears where you can view the details of the respective auto pay instruction.
Bill Segment ID	Displays the bill segment ID. Note: It has a link. On clicking the link, the Bill Segment screen appears where you can view the details of the respective bill segment.

Note: Pagination is used to display limited number of records in this zone. You can use the navigation links, such as **Previous** and **Next** to navigate between pages.

On clicking the **View** () icon corresponding to a bill segment, the **Bill Segment** screen appears where you can view the additional details of the respective bill segment.

On clicking the **Broadcast** () icon corresponding to a bill segment, the **SQ Details**, **Bill Segment Calculation Lines**, and **Transaction Details** zones appear.

Note:

The **SQ Details** zone appears when the bill segment is generated for an SQI based billable charge.

The **Transaction Details** zone appears only when the bill segment is generated for a billable charge which is created through the transaction aggregation process.

You can filter the list using various search criteria (such as, **Start Date** and **End Date**) available in the **Filter** area. By default, the **Filter** area is hidden. You can view the **Filter** area by clicking the **Filters** () icon in the upper right corner of this zone.

Related Topics

For more information on...	See...
How to view the SQ details of a bill segment	Viewing the SQ Details of a Bill Segment on page 741
How to view the calculation lines of a bill segment	Viewing the Calculation Lines of a Bill Segment on page 742
How to view the transactions whose charges billed through a bill segment	Viewing the Transactions Whose Charges are Billed Through a Bill Segment on page 742

SQ Details

The **SQ Details** zone lists the service quantity identifiers (SQIs) used in the bill segment calculation. It appears when the bill segment is generated for an SQI based billable charge. It contains the following columns:

Column Name	Column Description
SQI	Indicates the service quantity identifier.
Billed Service Quantity	Displays the service quantity used by the rates engine for calculation. This amount differs from the initial service quantity when the rate's SQ rules manipulate the service quantity.

By default, the **SQ Details** zone does not appear in the **Bill Information** screen. It appears when you click the **Broadcast** (📡) icon corresponding to a bill segment in the **Bill Segment Details** zone.

Bill Segment Calculation Lines

The **Bill Segment Calculation Lines** zone lists the calculation lines of the bill segment. It contains the following columns:

Column Name	Column Description
Header Sequence	Indicates the sequence in which the calculation line is generated.
Sequence	Ideally, the sequence would be 1 unless multiple versions of the rate were effective during the bill period. If there is more than one effective rate version, there will be a separate set of calculation lines for each version applied. The lines that apply to the first part of the bill period would have a Sequence of 1, the lines for the next part of the bill period would have a Sequence of 2 and so on.
Description on Bill	Displays the summarized information about the charge that will be printed on the bill.
Amount	Displays the charge amount.
Distribution Code	Displays the distribution code which indicates the GL account to which the charge must be posted.
Service Quantity	Indicates the service quantity which is used for calculation.

Note: Pagination is used to display limited number of records in this zone. You can use the navigation links, such as **Previous** and **Next** to navigate between pages.

By default, the **Bill Segment Calculation Lines** zone does not appear in the **Bill Information** screen. It appears when you click the **Broadcast** (📡) icon corresponding to a bill segment in the **Bill Segment Details** zone.

Transaction Details

The **Transaction Details** zone lists the transactions whose charges are billed through the bill segment. It contains the following columns:

Column Name	Column Description
Transaction ID	Displays the transaction ID. Note: It has a link. On clicking the link, the Transaction Details screen appears where you can view the details of the respective transaction.
Transaction Date	Displays the date and time when the transaction was performed.
Transaction Volume	Displays the transaction volume.
Transaction Amount	Displays the transaction amount.
Transaction Currency	Displays the currency in which the transaction was performed.
Transaction Source	Displays the transaction source from where the transaction was received.
Transaction Record Type	Displays the record type of the transaction.
Initial Price Item	Indicates the price item to which the transaction is mapped.

Column Name	Column Description
Rule	Indicates the rule which was met while determining initial price item for the transaction.
	Note: It has a link. On clicking the link, the Rule screen appears where you can view the details of the respective rule.
Transaction Information	Displays information about the transaction.
	Note: It has a link. On clicking the link, the Transaction Details screen appears where you can view the details of the respective transaction.

By default, the **Transaction Details** zone does not appear in the **Bill Information** screen. It appears when you click the **Broadcast** (📡) icon corresponding to a bill segment in the **Bill Segment Details** zone.

On clicking the **Broadcast** (📡) icon corresponding to a transaction, the **Transaction Leg Calculation Lines** zone appears with the details of the respective transaction.

Related Topics

For more information on...	See...
How to view the calculation lines of all legs of a transaction	Viewing the Calculation Lines of All Legs of a Transaction on page 743

Transaction Leg Calculation Lines

The **Transaction Leg Calculation Lines** zone lists the calculation lines of all legs of the transaction which are rated before billing. It contains the following columns:

Column Name	Column Description
Transaction Calculation ID	Displays the transaction calculation ID.
Sequence	Indicates the sequence in which the calculation line was created. It is the sequence of the rate component which is used in the rate schedule.
Price Component ID	Indicates the price component which is used during calculation.
Rate	Indicates the rate which is used for the calculation.
SQI	Indicates the service quantity identifier (SQI) which is used in the calculation.
Billable Service Quantity	Indicates the service quantities used by the rates engine for calculation.
Calculated Amount	Displays the calculated charge amount which is rounded off (i.e. amount in precision). For example, 100. This amount appears in the invoice currency.
Precise Calculated Amount	Displays the calculated charge amount which is not rounded off (i.e. amount with precision and scale). For example, 98.67. This amount appears in the invoice currency.
Exempt Amount	Displays the amount of the calculated charge that the person does not have to pay due to tax exemption.
Base Amount	Displays the total amount derived from the cross-referenced line(s) that the current line then used to calculate the charge amount.
Pricing Amount	Displays the calculated charge amount which is not rounded off (i.e. amount with precision and scale). For example, 98.67. This amount appears in the pricing currency.

Column Name	Column Description
Exchange Rate	Indicates the exchange rate which is used when the invoice currency is different from the pricing currency.
Print	Indicates whether information about the calculation line must be printed on the person's bill. The valid values are: <ul style="list-style-type: none"> • Y • N
Description on Bill	Displays the summarized information about the charge that will be printed on the bill.
Distribution Code	Displays the distribution code which indicates the GL account to which the charge must be posted.
Pricing Currency	Indicates the currency in which the price item pricing is defined.
Aggregation Parameter Group ID	Indicates the aggregation parameter group using which the transaction legs are aggregated during calculation.

Note: Pagination is used to display limited number of records in this zone. You can use the navigation links, such as **Previous** and **Next** to navigate between pages.

By default, the **Transaction Leg Calculation Lines** zone does not appear in the **Bill Information** screen. It appears when you click the **Broadcast** () icon corresponding to a transaction in the **Transaction Details** zone.

Hold Details

The **Hold Details** zone lists the active hold requests due to which the bill is kept on hold. It contains the following columns:

Column Name	Column Description
Hold Request Information	Displays information about the hold request.
	Note: It has a link. On clicking the link, the Hold Request screen appears where you can view the details of the respective hold request.
Status	Indicates the status of the hold request.
Entity	Indicates the type of the entity. The valid values are: <ul style="list-style-type: none"> • Person • Account • Bill
Entity Information	Indicates the entity for which the hold request is created. In addition, this column has a context menu which helps in navigating to other screens in the application.
	Note: It has a link. On clicking the link, the Person , Account , or Bill screen appears where you can view the details of the respective entity.
Start Date	Displays the date from when the entity is kept on hold.
End Date	Displays the date till when the entity is kept on hold.

Note: Pagination is used to display limited number of records in this zone. You can use the navigation links, such as **Previous** and **Next** to navigate between pages.

Offset Details

The **Offset Details** zone lists the offset requests through which the bill is offset against another bill. It contains the following columns:

Column Name	Column Description
Offset Request Information	Displays information about the offset request.
	Note: It has a link. On clicking the link, the Offset Request screen appears where you can view the details of the respective offset request.
Offset Amount	Indicates the bill amount which is offset against another bill.
Creation Mode	Indicates the mode in which the offset request is created. The valid values are: <ul style="list-style-type: none"> • Automatic • Manual

Note: Pagination is used to display limited number of records in this zone. You can use the navigation links, such as **Previous** and **Next** to navigate between pages.

Refund and Write Off Details

The **Refund and Write Off Details** zone lists the refund and write off requests through which the bill or its bill segment is either refunded or written off. It contains the following columns:

Column Name	Column Description
Create Date/Time	Displays the date and time when the refund or write off request is created.
Refund/Write Off Request Information	Displays information about the refund or write off request.
	Note: It has a link. On clicking the link, the Refund Request or Write Off Request screen appears depending on whether the request is created for refund or write off.
Refund/Write Off Amount	Displays the total refund or write off amount.
Status	Indicates the status of the refund or write off request. The valid values are: <ul style="list-style-type: none"> • Approval In Progress • Cancelled • Deferred Processing • Draft • Processed • Rejected • Voided

Column Name	Column Description
Action	Indicates whether the request is created for refund or write off. The valid values are: <ul style="list-style-type: none"> • Refund • Write Off
Account Information	Indicates the account for which the refund or write off request is created. In addition, this column has a context menu which helps in navigating to other screens in the application. <p>Note: It has a link. On clicking the link, the Account screen appears where you can view the details of the respective account.</p>
Created By	Indicates the user who has created the refund or write off request.



Note: Pagination is used to display limited number of records in this zone. You can use the navigation links, such as **Previous** and **Next** to navigate between pages.

You can filter the list using the **Action** field available in the **Filter** area. By default, the **Filter** area is hidden. You can view the **Filter** area by clicking the **Filters** () icon in the upper right corner of this zone.

Viewing the SQ Details of a Bill Segment

Procedure

To view the SQ details of a bill segment:

1. Search for the account, whose bill details you want to view, in the **Customer 360° View** screen.
2. In the **Search Results** section, click the **View** () icon corresponding to the account whose details you want to view.
The **Account** tab appears in the **Customer 360° Information** screen.
3. In the **Open Bills** zone, click the **View** () icon corresponding to the bill whose details you want to view.
The **Bill Information** screen appears.
4. In the **Bill Segment Details** zone, click the **Broadcast** () icon corresponding to the bill segment whose details you want to view.

The **SQ Details**, **Bill Segment Calculation Lines**, and **Transaction Details** zones appear.

Note:

The **SQ Details** zone appears when the bill segment is generated for an SQI based billable charge.

The **Transaction Details** zone appears when the bill segment is generated for a billable charge which is created through the transaction aggregation process.

5. View the SQ details of the bill segment in the **SQ Details** zone.

Related Topics

For more information on...	See...
How to search for an account	Searching for an Account on page 649
Customer 360° Information screen	Customer 360° Information on page 659

For more information on...	See...
Account tab	Customer 360° Information - Account on page 675
Open Bills zone	Open Bills on page 682
Bill Information screen	Bill Information on page 732
Bill Segment Details zone	Bill Segment Details on page 735
SQ Details zone	SQ Details on page 736

Viewing the Calculation Lines of a Bill Segment

Procedure

To view the calculation lines of a bill segment:

1. Search for the account, whose bill details you want to view, in the **Customer 360° View** screen.
2. In the **Search Results** section, click the **View** (🔍) icon corresponding to the account whose details you want to view.

The **Account** tab appears in the **Customer 360° Information** screen.

3. In the **Open Bills** zone, click the **View** (🔍) icon corresponding to the bill whose details you want to view.

The **Bill Information** screen appears.

4. In the **Bill Segment Details** zone, click the **Broadcast** (📡) icon corresponding to the bill segment whose details you want to view.

The **SQ Details**, **Bill Segment Calculation Lines**, and **Transaction Details** zones appear.

Note:

The **SQ Details** zone appears when the bill segment is generated for an SQI based billable charge.

The **Transaction Details** zone appears when the bill segment is generated for a billable charge which is created through the transaction aggregation process.

5. View the calculation lines of the bill segment in the **Bill Segment Calculation Lines** zone.

Related Topics

For more information on...	See...
How to search for an account	Searching for an Account on page 649
Customer 360° Information screen	Customer 360° Information on page 659
Account tab	Customer 360° Information - Account on page 675
Open Bills zone	Open Bills on page 682
Bill Information screen	Bill Information on page 732
Bill Segment Details zone	Bill Segment Details on page 735
Bill Segment Calculation Lines zone	Bill Segment Calculation Lines on page 737

Viewing the Transactions Whose Charges are Billed Through a Bill Segment

Procedure

To view the transactions whose charges are billed through a bill segment:

1. Search for the account, whose bill details you want to view, in the **Customer 360° View** screen.
2. In the **Search Results** section, click the **View** () icon corresponding to the account whose details you want to view.

The **Account** tab appears in the **Customer 360° Information** screen.

3. In the **Open Bills** zone, click the **View** () icon corresponding to the bill whose details you want to view.

The **Bill Information** screen appears.

4. In the **Bill Segment Details** zone, click the **Broadcast** () icon corresponding to the bill segment whose details you want to view.

The **SQ Details**, **Bill Segment Calculation Lines**, and **Transaction Details** zones appear.

Note:

The **SQ Details** zone appears when the bill segment is generated for an SQI based billable charge.

The **Transaction Details** zone appears when the bill segment is generated for a billable charge which is created through the transaction aggregation process.

5. View the transactions whose charges are billed through the bill segment in the **Transaction Details** zone.

Related Topics

For more information on...	See...
How to search for an account	Searching for an Account on page 649
Customer 360° Information screen	Customer 360° Information on page 659
Account tab	Customer 360° Information - Account on page 675
Open Bills zone	Open Bills on page 682
Bill Information screen	Bill Information on page 732
Bill Segment Details zone	Bill Segment Details on page 735
Transaction Details zone	Transaction Details on page 737

Viewing the Calculation Lines of All Legs of a Transaction

Procedure

To view the calculation lines of all legs of a transaction:

1. Search for the account, whose bill details you want to view, in the **Customer 360° View** screen.
2. In the **Search Results** section, click the **View** () icon corresponding to the account whose details you want to view.

The **Account** tab appears in the **Customer 360° Information** screen.

3. In the **Open Bills** zone, click the **View** () icon corresponding to the bill whose details you want to view.

The **Bill Information** screen appears.

4. In the **Bill Segment Details** zone, click the **Broadcast** () icon corresponding to the bill segment whose details you want to view.

The **SQ Details**, **Bill Segment Calculation Lines**, and **Transaction Details** zones appear.

Note:

The **SQ Details** zone appears when the bill segment is generated for an SQI based billable charge.

The **Transaction Details** zone appears when the bill segment is generated for a billable charge which is created through the transaction aggregation process.

- In the **Transaction Details** zone, click the **Broadcast** () icon corresponding to the transaction whose calculation lines you want to view.

The **Transaction Leg Calculation Lines** zone appears.

- View the calculation lines of all legs which are rated before billing in the **Transaction Leg Calculation Lines** zone.

Related Topics

For more information on...	See...
How to search for an account	Searching for an Account on page 649
Customer 360° Information screen	Customer 360° Information on page 659
Account tab	Customer 360° Information - Account on page 675
Open Bills zone	Open Bills on page 682
Bill Information screen	Bill Information on page 732
Bill Segment Details zone	Bill Segment Details on page 735
Transaction Details zone	Transaction Details on page 737
Transaction Leg Calculation Lines zone	Transaction Leg Calculation Lines on page 738

Chapter 9

Pricing Management (Health Insurance Business)

Topics:

- [Prerequisites \(Health Insurance Business\)](#)
- [Pricing Methodologies and Pricing Variation Based on Parameters \(Health Insurance Business\)](#)
- [Parameter](#)
- [Price Item \(Health Insurance Business\)](#)
- [Price List](#)
- [Rate Definition](#)
- [Tiering Criterion](#)

Oracle Revenue Management and Billing allows you to define prices for premiums, various fees, credits, discounts, and taxes that are defined as price items. Price for the price item may vary based on various attributes, which are defined as parameters in the system. Parameter values are derived either from transaction attributes (for example, for calculating claim based fees for a self-funded customer, pricing may vary based on claim transaction's health coverage class) or based on a field or characteristic of entities (for example, for calculating premium, pricing may vary based on member person's characteristic; whether a smoker or non-smoker). The system also supports deriving the pricing parameter through an algorithm, thereby enabling the custom derivation based on requirements.

Based on the line of business and the type of charge, you can define standard pricing which is common for multiple customers (for example, pricing defined for a health plan is applicable for all the subscribers subscribing to the health plan) or customer-specific pricing (for example, for fully-insured group customer, the pricing is specific to the group and you can define the policy plan level pricing in the system to achieve this. For more information about the fully-insured pricing, see [Fully-Insured Pricing](#) on page 3013.

The system enables you to define pricing at various levels in a customer hierarchy (for example, for a self-funded group customer, the pricing can be defined at the bill group level as well as at the parent customer level). If pricing is defined at multiple levels for a customer, the precedence is given to the pricing based on the level while searching for the pricing. For example, if pricing is defined for a price item at the bill group level as well as the parent customer level, the bill group level pricing takes precedence over the parent customer level pricing. Also, the parent customer level pricing is inherited by all the bill groups.

The pricing is triggered based on the transactions to calculate various charges or credit amounts eligible for a transaction. For example, for a self-funded customer, claim amounts with additional fees and markups, claim based fees, stop loss is calculated for claim transactions, enrollment based retention fees are calculated based on enrollment transactions, and ancillary fees are calculated based on ancillary transactions. For more information about the self-funded pricing, see [Self-Funded Pricing](#) on page 2453.

Transaction Based Pricing is invoked using the **Transaction Feed Management** module which processes different types of transactions (for example, claim, capitation, ancillary, enrollment, etc.) using the configurable validation and mapping rules to invoke the eligible pricing rules. For more information about the transaction feed management, see [Transaction Feed Management](#) on page 1139.

Pricing can also be triggered **based on qualifying life events** (for example, premium is calculated when a new membership is added, or a new member

is added to an existing membership, or every time the plan pricing is revised, etc.). The entity audit framework enables you to define various events for which pricing should be revised. For example, **addition of a new membership, addition of a new member, updates to the plan pricing, or the membership attributes which you want to monitor for premium change, etc.** The system enables you to define the algorithms to price the eligible events by invoking pricing rules. For more information about the entity audit framework, see [Entity Audit](#) on page 3299.

Prerequisites (Health Insurance Business)

To setup the pricing management feature, you need to do the following:

- Define the required SQIs and divisions in the system.
- Define the required parameters in the system.
- Define the tiering setup for rate components in the system.
- Define the required price items in the system.

Pricing Methodologies and Pricing Variation Based on Parameters (Health Insurance Business)

The specialized pricing methodologies are required for pricing the fully-insured and self-funded customers. Therefore, an out of box pricing solution is provided to the fully-insured and self-funded customers through distinct pricing rule types.

Fully-Insured Pricing

Age Banded Premium Pricing

Age banded premium pricing is one of the methodologies for premium calculation. In this methodology, Premium calculation is done **by determining the premium of each member separately mainly based on the age band in which the member falls, and then aggregating** these to derive the overall premium amount for a membership.

Apart from member's age, premium of age banded plans can vary based upon **different parameters; be it member's attribute or plan level attribute or LOB specific attributes**. For example, pricing can vary by different population segment characteristics such as Employee Type (Retiree, COBRA and Active) and/or by different regions, Employee Status (Permanent/contractual) etc. Age-banded pricing may also vary by different modifiers such as Tobacco usage, Gender etc.

ORMB provides Out of Box Pricing Rule Type 'Age Banded'. Using the same you can define pricing rule to define age-banded plan pricing. Pricing variation can be defined based on the pricing eligibility parameters where the source can be defined as Membership characteristics or Member characteristics or Plan characteristics. User can set **base fee** for set of parameters and can also set the **percentage or flat amount to be added over the base fee for each modifiers**.

Age-banded premium calculation algorithm which is configured in Age-banded pricing rule type process the premium pricing for each membership, derive the premium amount for each member and then aggregates the amount to derive the overall premium amount for a membership. **Maximum number of eligible dependents and the order of selection of the dependents like oldest first or youngest first is also configurable at Plan or State level.**

Age Banded Example:

Demo Corporation has a Group policy for the employees the Monthly premium for the policy is rated as follows

Base Premium Rate

Age Band	Location/Rating Area	Base Premium
Up to 15 Years	North California	\$200
	South California	\$210
16 to 18 Years	North California	\$210
	South California	\$220

Age Band	Location/Rating Area	Base Premium
18 to 40 Years	North California	\$220
	South California	\$240
40 to 60 Years	North California	\$250
	South California	\$260
60+ Years	North California	\$280
	South California	\$290

On Top of the base premium, additional 2% premium will be charged if the member is smoker

State of California is configured with the following pricing rules :

Max. No of Eligible Dependents = 2

Order of Dependent Selection = Oldest first

New Born Gift Days = 30

Proration Rule Defined for the account : Mid Month i.e. Member joining before 15th will be charged the premium for the entire month

Example 1:

North California Based Employee John Doe, a 45 years old smoker who enrolled himself with his spouse Mary Doe (Age 40) and daughter Elsa Doe aged 13, son Bob Doe aged 10 and daughter Laura Doe aged 8 the premium will be calculated as follows:

Member	Reason	Premium Contribution
John Doe	Base Premium	\$250
	Smoker	\$5
Mary Doe	Base Premium	\$250
Elsa Doe	Base Premium	\$200
Bob Doe	Base Premium	\$200
Total Premium		\$905

Example 2 :

North California Based Employee John Doe a California based Employee is enrolled in to the plan along with his spouse Mary Doe, John enrolls his new born daughter Laura born on 3rd of July on 20th of July.

John's Premium for all the months till July will be calculated as follows

Member	Reason	Premium Contribution
John Doe	Base Premium	\$250
Mary Doe	Base Premium	\$250
Total Premium		\$500

With the new enrollment in the month of July, The premium for July and the following months will be recalculated, As the state of California has New Born Gift days = 30 days, the premium will be calculated as follows:

For the Month of July:

Member	Reason	Premium Contribution
John Doe	Base Premium	\$250
Mary Doe	Base Premium	\$250
Laura Doe	Base Premium	\$200
	New Born Waiver	-\$200
Total Premium		\$500

For Month of August:

Member	Reason	Premium Contribution
John Doe	Base Premium	\$250
Mary Doe	Base Premium	\$250
Laura Doe	Base Premium	\$200
Total Premium		\$700

Tiered Premium Pricing

Tiered based premium pricing is another methodology for premium calculation. In this methodology, Premium calculation is done by determining the **subscription tier** level for the membership directly to derive the premium amount for that membership.

Standard tier based pricing structure contains different tiers such as Employee only (E), Employee+ Spouse (ES), Family (F), Employee + Children (EC). A member can subscribe his/her dependents to a plan and fall into one of the tier. Tier-based premium varies based upon **membership tier level and different parameters**; parameters can be member's attribute or Plan level attribute or LOB specific attributes. For example, for a particular tier, pricing can vary by different population segment characteristics such as Employee Type (Retiree, COBRA and Active) and/or by different regions, Employee Status (Permanent/contractual) etc.

Like age-based pricing, tier-based pricing can be defined using pricing rule with tier-based pricing rule type You can set premium fee for set of parameters and tier level. Tier-based premium calculation algorithm which is configured in tier-based pricing rule type process the premium pricing for each membership based on the applicable rate for the parameters and tier value for that membership which is defined as membership characteristic.

Tier Based Pricing Example

Tier	Location/Rating Area	Premium
Employee Only	N. California	\$200
	S. California	\$210
Employee + Spouse	N. California	\$300
	S. California	\$310
Family	N. California	\$450

Tier	Location/Rating Area	Premium
	S. California	\$500

Example : North California Based Employee John Doe, a 45 years old smoker who enrolled himself with his spouse Mary Doe (Age 40) and daughter Elsa Doe aged 13 the premium charged will be \$450 per month.

State Level Configurations

Various state specific rules are defined in ORMB using state specific characteristics e.g. Gift Days to provide no additional premium when New Born is enrolled into the plan or various rules such as maximum dependents to be covered etc. The state and state characteristics can be defined state specific parameters. These parameters which define business rules may have overridden values at Plan or Membership levels. ORMB pricing calculation always checks for the parameters at membership and plan level first, if not found then the state level parameters are considered for the price calculations.

Premium Holiday and Proration

ORMB provides several options for correctly handling of proration; when a rate changes in middle of a billing period or when new Membership is added or terminated during the bill period. Configurable Proration Rule allows to define various options such as; mid-month proration where full premium is applicable if the membership starts before mid-coverage or proration based on covered days etc.

A configuration option can be set to handle special cases where proration is not to be applied even during a long or short bill period (e.g. when a flat charge is to be applied in full; even though the billing period is half of the standard period).

ORMB allows configuring or uploading the period for which premium holiday or waive off of premium needs to be given to the membership, based on which the premium is waived off, the rate configurations allow you to provide these details on the bill lines providing the required transparency to the customer.

Self-funded Pricing

ORMB provides you with a complete solution in terms of pricing, billing and revenue management to support ASO plans and also to provide risk coverage of offering self-funded plans through the stop loss or re-insurance services.

Claim Amount Processing

ORMB provides capability to calculate the final claim amount to be charged to the customer by summing up all the claim line items configured as billable for the customer. It also provides a facility to mark up or markdown these line items amounts as per customer specific pricing. You can also define the capping amounts per claim.

In order to support new '**Payments Integrity model**' ORMB enables you to define **the additional fees i.e. recovery fees / savings amounts** to be calculated as **flat or percentage based** on the claim charges and charge the same to the customers along with **Max / Min capping amounts**

ORMB allows you to define pricing rules, having different pricing strategy based on policy status e.g. **during the active policy period various chargeable items** like consumer driven health insurance charges, traditional health insurance charges, **are charged to the customer** whereas during **post runout period the entire claim amount will be written off.**

To enable easy configurations ORMB provides you a capability to define **claim templates** and with definition of multiple add-on fees and its usage with default pricing. Using a file upload utility or other custom process the claim transactions can be uploaded to ORMB.

Claim transactions contain information about the membership and details of various claim line items such as **ASO service provider charges, fee for network access, fee for non-network access, fee for collection services provided by external vendor, fee for hospital audit performed by external vendor,** and so on.

ORMB allows the ASO service provider to bill employers for claim amount and various additional fees based on the pricing defined. Claim pricing rules can be defined at the parent customer and bill group levels. Claim pricing rule enables you to define whether a particular claim line item should be billable to the customer or should be written off. Eligibility for billing can be defined based on rules using the transaction attributes.

Retention fee – Claim based

Retention fee is based upon claim amount either the percentage of claim or flat amount per claim transaction can also be calculated. ORMB provides you an ability to select the Claim line items eligible for claim based fees calculations. Claim based fees pricing can **vary based on either membership attributes or based on the claim transaction attributes** e.g. different claim based fees can be charged for claim with health coverage class as ‘Medical’ than that of the ‘Dental’

Retention fee – Enrollment based

In order to calculate fees / premium amount / various limits (e.g. ASL Limit based on the enrollments), ORMB provides out of box pricing rule type – retention fee – enrollment based. Enrollment based pricing rules can be defined at both customer or bill group level where, enrollment fees are defined as per member or per subscriber charges where **pricing variation can be provided based on parameters e.g. coverage tier or health coverage class(HCC) etc.** It also calculates the retention fee based upon enrollment count.

Flat and Recurring Fees

Ad-hoc one time fees (e.g. one time admin fees), recurring premium fees / charges e.g. charge the stop loss premium can be defined in ORMB using the flat and recurring fees pricing rule type. These types of charges are independent of no. of enrollments or claims and are charged as a flat fee per month over a period of time. ORMB provides flexibility to set up pricing rules for charging flat / one time fees or flat recurring fees with configurable recurring frequencies e.g. claim funds.

Ancillary fees

Ancillary service charges are basically an adjustments charge which are either pre-calculated charges which need to be included into the bill or to be calculated based on the utilization of the ancillary services Ancillary pricing rule can be defined at the parent customer and bill group levels. The ancillary in ORMB enables you to create an ancillary charge in either of the following ways:

- As **pass through charge without markup or markdown** (i.e. flat charge)
- As **pass through charge** where ORMB adds a **flat or percentage based markup or markdown** to charge the customer
- Or by creating a **rate based charge** using the rate defined in the ancillary pricing and the service quantity specified in the ancillary transaction. You can also apply markup or markdown to a rate based charge

Specific Stop Loss (SSL)

SSL is the form of excess risk coverage that provides protection for the **employer against a high claim on any one individual**. ORMB provides a pricing rule type – specific stop loss to support SSL calculations. SSL pricing rules are defined at two levels – parent level defines all the accumulation specific details which are common for all the bill groups and bill group – policy level pricing to define the limits and also **information about which charges are to be re-insured against SSL**. ORMB provides **complete flexibility** to define the **accumulation criteria** e.g. you can choose to calculate SSL only on the medical claims, out of network claim, etc. based on configurations. Ability to calculate and invoice the specific stop loss based on per subscriber or per member basis with a **facility to laser or excludes the subscribers / members**. ORMB’s flexible accumulation criteria definitions allow you to define SSL pricing for various types of policies -12/12 or 15/12 or 12/15 with ease. With ORMB you can choose the settlement frequency for the SSL

ORMB enables you to setup **SSL retrospectively or allow pricing updates by reprocessing**

Aggregated Stop Loss (ASL)

ORMB enables you to provide a **ceiling on the dollar amount of eligible expenses** that an employer would pay, **in total for all members or subscribers**, during a contract period. **ASL limit** can be configured **as either flat limit or based on the PSPM (Per subscriber per month) basis or enrollment based**. Similar to SSL, ASL pricing rules **enables to define eligibility rules for the transactions and claim line items** for the calculations of ASL. With ORMB you can choose the settlement frequency for the ASL. ORMB enables you to setup **ASL retrospectively or allow pricing updates by reprocessing**

Discount Arrangements Fees

ORMB discount arrangement pricing rule type enables to calculate and bill the discounts using two different methods – i.e: **discount share Fees** where discount amount to be charged to customer is calculated as percentage of the total

discount savings amount per claim and **discount guarantee** Fees where discount amount calculated based **on discount savings amount and guaranteed percentage of the covered amount**.

Pricing Rule type allows you to define maximum discount amount that can be charged per claim transaction and/or allow to configure the **minimum and maximum discount limit on the contract level**. It also allows defining the **rule based eligibility criteria to apply discount** and exclude few transactions based upon the parameters.

Level Funding Arrangements

ORMB level funding pricing rule type allows defining the required setup for monthly contribution mechanism which can be a **fixed monthly amount** or amount based upon enrollment **count**. ORMB enables you to collect the funds during **active policy period** to settle not only the claims and other fees during active period but also to take care of the **terminal liability** or the **claims and other fees during runout period**. ORMB also provides configurable setup to define the charges to be considered for settlement with specific criteria. ORMB enables to setup pricing rules for level funding products where the **claims, ancillary, retention based fees, discounts** can be settled against the level funded amounts.

ORMB has two variations of level funding based on the method to calculate premium fund. The portal enables you to define whether the price items included in the claim, retention type claim based, retention type enrollment based, ancillary, and discount pricing rule types are eligible for level funding. If the price items are eligible for level funding, you can then include them in the level funding pricing rule type indicating that the charges for these price items will not be included in the respective billable charge (for example, claim billable charge), but it would be settled against the funds billable charge. While adjusting such charges against the funds billable charge, there might be some **surplus or deficit** in funds at the time of settlement which is ideally at the end of year. In such case, the system enables to configure whether **a flat amount or percentage of surplus should be retained** by the ASO provider or whether a flat amount or percentage of deficit is offered as a discount to the self-funded employer. It allows you for different settlement options – **Close out – where the final settlement is done**. In case the customer is continuing for the next cycle with the payer you can provide an option to **Roll Forward the surplus funds to the next years funds**.

Level Funding Arrangements

ORMB level funding pricing rule type allows defining the required setup for monthly contribution mechanism which can be a **fixed monthly amount** or amount based upon enrollment **count**. ORMB enables you to collect the funds during **active policy period** to settle not only the claims and other fees during active period but also to take care of the **terminal liability** or the **claims and other fees during runout period**. ORMB also provides configurable setup to define the charges to be considered for settlement with specific criteria. ORMB enables to setup pricing rules for level funding products where the **claims, ancillary, retention based fees, discounts** can be settled against the level funded amounts.

ORMB has two variations of level funding based on the method to calculate premium fund. The portal enables you to define whether the price items included in the claim, retention type claim based, retention type enrollment based, ancillary, and discount pricing rule types are eligible for level funding. If the price items are eligible for level funding, you can then include them in the level funding pricing rule type indicating that the charges for these price items will not be included in the respective billable charge (for example, claim billable charge), but it would be settled against the funds billable charge. While adjusting such charges against the funds billable charge, there might be some **surplus or deficit** in funds at the time of settlement which is ideally at the end of year. In such case, the system enables to configure whether **a flat amount or percentage of surplus should be retained** by the ASO provider or whether a flat amount or percentage of deficit is offered as a discount to the self-funded employer. It allows you for different settlement options – **Close out – where the final settlement is done**. In case the customer is continuing for the next cycle with the payer you can provide an option to **Roll Forward the surplus funds to the next years funds**.

Parameter

The pricing for a price item may differ depending upon various transaction, person, account, or product attributes. Oracle Revenue Management and Billing provides a facility to define pricing for a price item based on multiple parameters. In addition, you can define the pricing, price list, and product eligibility criteria using one or more parameters.

Each parameter must be mapped to the following:

- **Source Entity** - Indicates the entity from where the parameter value is derived. A source entity can be account, person, product, transaction, service quantity identifier, or an algorithm.

- **Source Type** - Indicates the type of source from where the parameter value is derived. A source type can be field, characteristic, usage amount, or usage counter.
- **Source Type Code** - Indicates the source (such as, field, characteristic, usage amount, usage counter, SQL, or algorithm) from where the parameter value is derived.

The system allows you to define the following types of parameters:

- **Adhoc** - Used to store an adhoc value.
- **Predefined** - Used to store a predefined value. For example, you can create a parameter named **Country** where the value type is set to **Predefined** and the following predefined values are added in the parameter:

Parameter Value	Description
AUT	Austria
AUS	Australia
CAN	Canada
CHN	China

In such case, while defining the pricing for a price item using the **Country** parameter, you can use any one of the above mentioned parameter values.

Another example, you can create a parameter named **Health Coverage Class** where the value type is set to **Predefined** and the following predefined values are added in the parameter:

Parameter Value	Description
MEDICAL	Medical
DENTAL	Dental
VISION	Vision

In such case, while defining the pricing for a price item using the **Health Coverage Class** parameter, you can use any one of the above mentioned parameter values.

- **Reference** - Used to store a value which is already present in a table. For example, you can create a parameter named **Country** where the value type is set to **Reference** and the reference entity is set to **CI_COUNTRY_L** (i.e. where the description of all countries is stored). In such case, while defining the pricing for a price item using the **Country** parameter, you can specify a country which is present in the **CI_COUNTRY_L** table in the parameter value.

Parameter (Used for Searching)

The **Parameter** screen allows you to define, edit, delete and copy a parameter. It contains the following zone:

- [Search Parameter](#) on page 753

Search Parameter

The **Search Parameter** zone allows you to search for a parameter using various search criteria. It contains the following two sections:





- **Search Criteria** - The **Search Criteria** section contains the following fields:

Field Name	Field Description	Mandatory (Yes or No)
Parameter	Used to search a particular parameter.	No

Field Name	Field Description	Mandatory (Yes or No)
Value Type	Used to search parameters in which you can store a particular type of value. The valid values are: <ul style="list-style-type: none"> • Adhoc • Predefined • Reference 	No
Source Entity	Used to search parameters whose value is derived from a particular entity. The valid values are: <ul style="list-style-type: none"> • Account • Algorithm • Benefit • Membership • Membership Person • Person • Plan • Product • Service Quantity Identifier • State • Transaction 	No
Source Type	Used to search parameters whose value is derived from a particular type of source. The valid values are: <ul style="list-style-type: none"> • Characteristic • Field • Usage Amount • Usage Counter 	No
Description	Used to search parameters with a particular description.	No

- **Search Results** - On clicking the **Search** button, the search results appear based on the specified search criteria. The **Search Results** section contains the following columns:

Column Name	Column Description
Parameter	Displays the parameter name.
Value Type	Indicates the type of value that you can store in the parameter. The valid values are: <ul style="list-style-type: none"> • Adhoc • Predefined • Reference
Description	Displays the description of the parameter.

Column Name	Column Description
Source Entity	Indicates the entity from where the parameter value is derived. The valid values are: <ul style="list-style-type: none"> • Account • Algorithm • Benefit • Membership • Membership Person • Person • Plan • Product • Service Quantity Identifier • State • Transaction
Source Type	Indicates the type of source from where the parameter value is derived. The valid values are: <ul style="list-style-type: none"> • Characteristic • Field • Usage Amount • Usage Counter
View	On clicking the View () icon, the Parameter screen appears where you can view the details of the parameter.
Edit	On clicking the Edit () icon, the Parameter screen appears where you can edit the details of the parameter.
Delete	On clicking the Delete () icon, you can delete the parameter. <div style="border: 1px solid black; padding: 5px; margin-top: 5px;"> <p>Note:</p> <p>You can delete a parameter when the following conditions are met:</p> <ul style="list-style-type: none"> • It is not yet associated to any price item or price item bundle. • It is not yet used while defining the pricing, price list, or product eligibility criteria. </div>
Duplicate	On clicking the Duplicate () icon, the Parameter screen appears where you can define a new parameter using an existing parameter.

Note: Pagination is used to display limited number of records in the **Search Results** section. You can use the navigation links, such as **Previous** and **Next** to navigate between pages.

Related Topics

For more information on...	See...
How to search for a parameter	Searching for a Parameter on page 756
How to edit a parameter	Editing a Parameter on page 763
How to delete a parameter	Deleting a Parameter on page 770
How to copy a parameter	Copying a Parameter on page 771
How to view the details of a parameter	Viewing the Parameter Details on page 778

Searching for a Parameter

Procedure

To search for a parameter:

1. Click the **Admin** link in the **Application** toolbar.
A list appears.
2. From the **Admin** menu, select **P** and then click **Parameter**.
The **Parameter** screen appears.
3. Enter the search criteria in the **Search Parameter** zone.

Note: ORMB search engine supports wildcard search, where you can substitute the percentage (%) symbol as a stand in for any word or letter in a search criteria. You can use the ‘%’ wildcard character in all input fields except the date and ID fields. The ‘%’ wildcard character is suffixed automatically at the end of the partial search criteria. Therefore, you may or may not specify the wildcard character at the end of the partial search criteria. However, you have to prefix the wildcard character manually wherever required.

4. Click **Search**.
A list of parameters that meet the search criteria appears in the **Search Results** section.

Related Topics

For more information on...	See...
Parameter screen	Parameter (Used for Searching) on page 753
Search Parameter zone	Search Parameter on page 753

Defining a Parameter

Prerequisites

To define a parameter, you should have:

- Validation algorithm defined using the **C1_PPARM_VAL** algorithm type (in case you want to validate an adhoc parameter value)
- An algorithm defined using the **C1-PPARM-ENT** algorithm type (in case you want to use the algorithm while validating the pricing eligibility criteria)

Note:

A sample algorithm type named **C1_PPARM_VAL** is shipped with the product. At present, it allows you to specify any special characters except ampersand (&), comma (,), underscore (_), equal to (=), tilde (~), and semi-colon(;) in the parameter value.

A sample algorithm type named **C1-PPARM-ENT** is shipped with the product. At present, it returns a boolean value true. You can build custom logic in this algorithm which returns a value. This value can then be compared against the parameter value specified in the pricing eligibility criteria.

Procedure

To define a parameter:

1. Click the **Admin** link in the **Application** toolbar.

A list appears.

2. From the **Admin** menu, select **P** and then click **Parameter**.

The **Parameter** screen appears.

3. Click the **Add** button in the **Page Title** area of the **Parameter** screen.

The **Parameter** screen appears. It contains the following fields:

Field Name	Field Description	Mandatory (Yes or No)
Parameter	Used to specify the parameter name. Note: You cannot specify any special character except underscore (_) in the parameter name.	Yes
Source Entity	Used to indicate the entity from where the parameter value should be derived. The valid values are: <ul style="list-style-type: none"> • Account • Algorithm • Benefit • Membership • Membership Person • Person • Plan • Product Note: This option is not applicable for the health insurance business. <ul style="list-style-type: none"> • Service Quantity Identifier • State • Transaction 	Yes
Description	Used to specify the description for the parameter.	Yes

Field Name	Field Description	Mandatory (Yes or No)															
Source Type	<p>Used to indicate the type of source from where the parameter value should be derived. The valid values are:</p> <ul style="list-style-type: none"> • Characteristic • Field • Usage Amount • Usage Counter <p>Note:</p> <p>This field appears when the Account, Person, or Product option is selected from the Source Entity list.</p> <p>The Usage Amount and Usage Counter options do not appear in the Source Type list when the Product option is selected from the Source Entity list.</p>	Yes															
Value Type	<p>Used to indicate the type of value that you want to store in the parameter. The valid values are:</p> <ul style="list-style-type: none"> • Adhoc • Predefined • Reference 	Yes															
Source Type Code	<p>Used to indicate the source, such as field, characteristic, usage amount, usage counter, SQI, or algorithm, from where the parameter value should be derived.</p> <p>Note:</p> <p>This field does not appear when the Transaction option is selected from the Source Entity list.</p> <p>The following table indicates the values that are listed in the Source Type Code field depending on the source entity and source type combination:</p> <table border="1"> <thead> <tr> <th>Source Entity</th> <th>Source Type</th> <th>Source Type Code</th> </tr> </thead> <tbody> <tr> <td>Account</td> <td>Characteristic</td> <td>Lists all characteristics where the characteristic entity is set to Account.</td> </tr> <tr> <td>Account</td> <td>Field</td> <td>Lists all fields of the CI_ACCT table.</td> </tr> <tr> <td>Account</td> <td>Usage Amount</td> <td>Lists all values defined for the BAL_FLG lookup field.</td> </tr> <tr> <td>Account</td> <td>Usage Counter</td> <td>Lists all values defined for the CNT_FLG lookup field.</td> </tr> </tbody> </table>	Source Entity	Source Type	Source Type Code	Account	Characteristic	Lists all characteristics where the characteristic entity is set to Account .	Account	Field	Lists all fields of the CI_ACCT table.	Account	Usage Amount	Lists all values defined for the BAL_FLG lookup field.	Account	Usage Counter	Lists all values defined for the CNT_FLG lookup field.	Yes
Source Entity	Source Type	Source Type Code															
Account	Characteristic	Lists all characteristics where the characteristic entity is set to Account .															
Account	Field	Lists all fields of the CI_ACCT table.															
Account	Usage Amount	Lists all values defined for the BAL_FLG lookup field.															
Account	Usage Counter	Lists all values defined for the CNT_FLG lookup field.															

Field Name	Field Description	Mandatory (Yes or No)																																				
	<p data-bbox="483 260 548 289">Note:</p> <table border="1" data-bbox="483 310 1222 1602"> <thead> <tr> <th data-bbox="483 310 670 363">Source Entity</th> <th data-bbox="670 310 865 363">Source Type</th> <th data-bbox="865 310 1222 363">Source Type Code</th> </tr> </thead> <tbody> <tr> <td data-bbox="483 363 670 478">Person</td> <td data-bbox="670 363 865 478">Characteristic</td> <td data-bbox="865 363 1222 478">Lists all characteristics where the characteristic entity is set to Person.</td> </tr> <tr> <td data-bbox="483 478 670 562">Person</td> <td data-bbox="670 478 865 562">Field</td> <td data-bbox="865 478 1222 562">Lists all fields of the CI_PER table.</td> </tr> <tr> <td data-bbox="483 562 670 646">Person</td> <td data-bbox="670 562 865 646">Usage Amount</td> <td data-bbox="865 562 1222 646">Lists all values defined for the BAL_FLG lookup field.</td> </tr> <tr> <td data-bbox="483 646 670 730">Person</td> <td data-bbox="670 646 865 730">Usage Counter</td> <td data-bbox="865 646 1222 730">Lists all values defined for the CNT_FLG lookup field.</td> </tr> <tr> <td data-bbox="483 730 670 846">Benefit</td> <td data-bbox="670 730 865 846">Characteristic</td> <td data-bbox="865 730 1222 846">Lists all characteristics where the characteristic entity is set to Benefit.</td> </tr> <tr> <td data-bbox="483 846 670 930">Benefit</td> <td data-bbox="670 846 865 930">Field</td> <td data-bbox="865 846 1222 930">Lists all fields of the CI_BENEFITS table.</td> </tr> <tr> <td data-bbox="483 930 670 1045">Membership</td> <td data-bbox="670 930 865 1045">Characteristic</td> <td data-bbox="865 930 1222 1045">Lists all characteristics where the characteristic entity is set to Membership.</td> </tr> <tr> <td data-bbox="483 1045 670 1129">Membership</td> <td data-bbox="670 1045 865 1129">Field</td> <td data-bbox="865 1045 1222 1129">Lists all fields of the CI_MEMBERSHIP table.</td> </tr> <tr> <td data-bbox="483 1129 670 1245">Membership Person</td> <td data-bbox="670 1129 865 1245">Characteristic</td> <td data-bbox="865 1129 1222 1245">Lists all characteristics where the characteristic entity is set to Membership Person.</td> </tr> <tr> <td data-bbox="483 1245 670 1360">Membership Person</td> <td data-bbox="670 1245 865 1360">Field</td> <td data-bbox="865 1245 1222 1360">Lists all fields of the CI_MEMBERSHIP_PER table.</td> </tr> <tr> <td data-bbox="483 1360 670 1602">Product</td> <td data-bbox="670 1360 865 1602">Characteristic</td> <td data-bbox="865 1360 1222 1602"> Lists all characteristics where the characteristic entity is set to Product. <div data-bbox="873 1476 1214 1581" style="border: 1px solid black; padding: 5px;"> <p data-bbox="873 1476 1214 1581">Note: This option is not applicable for the health insurance business.</p> </div> </td> </tr> </tbody> </table>	Source Entity	Source Type	Source Type Code	Person	Characteristic	Lists all characteristics where the characteristic entity is set to Person .	Person	Field	Lists all fields of the CI_PER table.	Person	Usage Amount	Lists all values defined for the BAL_FLG lookup field.	Person	Usage Counter	Lists all values defined for the CNT_FLG lookup field.	Benefit	Characteristic	Lists all characteristics where the characteristic entity is set to Benefit .	Benefit	Field	Lists all fields of the CI_BENEFITS table.	Membership	Characteristic	Lists all characteristics where the characteristic entity is set to Membership .	Membership	Field	Lists all fields of the CI_MEMBERSHIP table.	Membership Person	Characteristic	Lists all characteristics where the characteristic entity is set to Membership Person .	Membership Person	Field	Lists all fields of the CI_MEMBERSHIP_PER table.	Product	Characteristic	Lists all characteristics where the characteristic entity is set to Product . <div data-bbox="873 1476 1214 1581" style="border: 1px solid black; padding: 5px;"> <p data-bbox="873 1476 1214 1581">Note: This option is not applicable for the health insurance business.</p> </div>	
Source Entity	Source Type	Source Type Code																																				
Person	Characteristic	Lists all characteristics where the characteristic entity is set to Person .																																				
Person	Field	Lists all fields of the CI_PER table.																																				
Person	Usage Amount	Lists all values defined for the BAL_FLG lookup field.																																				
Person	Usage Counter	Lists all values defined for the CNT_FLG lookup field.																																				
Benefit	Characteristic	Lists all characteristics where the characteristic entity is set to Benefit .																																				
Benefit	Field	Lists all fields of the CI_BENEFITS table.																																				
Membership	Characteristic	Lists all characteristics where the characteristic entity is set to Membership .																																				
Membership	Field	Lists all fields of the CI_MEMBERSHIP table.																																				
Membership Person	Characteristic	Lists all characteristics where the characteristic entity is set to Membership Person .																																				
Membership Person	Field	Lists all fields of the CI_MEMBERSHIP_PER table.																																				
Product	Characteristic	Lists all characteristics where the characteristic entity is set to Product . <div data-bbox="873 1476 1214 1581" style="border: 1px solid black; padding: 5px;"> <p data-bbox="873 1476 1214 1581">Note: This option is not applicable for the health insurance business.</p> </div>																																				

Field Name	Field Description	Mandatory (Yes or No)																								
	<p>Note:</p> <table border="1"> <thead> <tr> <th data-bbox="483 310 667 363">Source Entity</th> <th data-bbox="667 310 867 363">Source Type</th> <th data-bbox="867 310 1227 363">Source Type Code</th> </tr> </thead> <tbody> <tr> <td data-bbox="483 363 667 583">Product</td> <td data-bbox="667 363 867 583">Field</td> <td data-bbox="867 363 1227 583"> Lists all fields of the CI_PRODUCT table. <div style="border: 1px solid black; padding: 2px;"> <p>Note: This option is not applicable for the health insurance business.</p> </div> </td> </tr> <tr> <td data-bbox="483 583 667 699">Plan</td> <td data-bbox="667 583 867 699">Characteristic</td> <td data-bbox="867 583 1227 699">Lists all characteristics where the characteristic entity is set to Plan.</td> </tr> <tr> <td data-bbox="483 699 667 783">Plan</td> <td data-bbox="667 699 867 783">Field</td> <td data-bbox="867 699 1227 783">Lists all fields of the CI_POLICY_PLAN table.</td> </tr> <tr> <td data-bbox="483 783 667 898">Service Quantity Identifier</td> <td data-bbox="667 783 867 898">—</td> <td data-bbox="867 783 1227 898">Lists all service quantity identifiers available in the CI_SQI table.</td> </tr> <tr> <td data-bbox="483 898 667 1014">State</td> <td data-bbox="667 898 867 1014">Characteristic</td> <td data-bbox="867 898 1227 1014">Lists all characteristics where the characteristic entity is set to State.</td> </tr> <tr> <td data-bbox="483 1014 667 1098">State</td> <td data-bbox="667 1014 867 1098">Field</td> <td data-bbox="867 1014 1227 1098">Lists all fields of the CI_STATE table.</td> </tr> <tr> <td data-bbox="483 1098 667 1213">Algorithm</td> <td data-bbox="667 1098 867 1213">—</td> <td data-bbox="867 1098 1227 1213">Lists all algorithms which are defined using the CI-PPARM-ENT algorithm type.</td> </tr> </tbody> </table>	Source Entity	Source Type	Source Type Code	Product	Field	Lists all fields of the CI_PRODUCT table. <div style="border: 1px solid black; padding: 2px;"> <p>Note: This option is not applicable for the health insurance business.</p> </div>	Plan	Characteristic	Lists all characteristics where the characteristic entity is set to Plan .	Plan	Field	Lists all fields of the CI_POLICY_PLAN table.	Service Quantity Identifier	—	Lists all service quantity identifiers available in the CI_SQI table.	State	Characteristic	Lists all characteristics where the characteristic entity is set to State .	State	Field	Lists all fields of the CI_STATE table.	Algorithm	—	Lists all algorithms which are defined using the CI-PPARM-ENT algorithm type.	
Source Entity	Source Type	Source Type Code																								
Product	Field	Lists all fields of the CI_PRODUCT table. <div style="border: 1px solid black; padding: 2px;"> <p>Note: This option is not applicable for the health insurance business.</p> </div>																								
Plan	Characteristic	Lists all characteristics where the characteristic entity is set to Plan .																								
Plan	Field	Lists all fields of the CI_POLICY_PLAN table.																								
Service Quantity Identifier	—	Lists all service quantity identifiers available in the CI_SQI table.																								
State	Characteristic	Lists all characteristics where the characteristic entity is set to State .																								
State	Field	Lists all fields of the CI_STATE table.																								
Algorithm	—	Lists all algorithms which are defined using the CI-PPARM-ENT algorithm type.																								
Validation Algorithm	<p>Used to indicate the algorithm using which you want to validate the adhoc parameter value.</p> <p>Note:</p> <p>This field appears when the Adhoc option is selected from the Value Type list.</p> <p>The Search (🔍) icon appears corresponding to the Validation Algorithm field. On clicking the Search icon, the Algorithm Search window appears.</p>	No																								

Field Name	Field Description	Mandatory (Yes or No)
Reference Entity	Used to indicate the table whose primary key (column) you want to set as the reference entity. Note: This field appears only when the Reference option is selected from the Value Type list. The Search (🔍) icon appears corresponding to the Reference Entity field. On clicking the Search icon, the Reference Table Search window appears. You can only specify a language table, where the DESCR column is available, in the Reference Entity field.	Yes
Field Name	Indicates the column which is the primary key of the table. The parameter value is then validated against the primary column of the table. Note: This field appears when the Reference option is selected from the Value Type list.	Not applicable

In addition, this screen contains the following two sections:

- **Parameter Values** - Used to define predefined values for the parameter. It contains the following fields in the grid:

Field Name	Field Description	Mandatory (Yes or No)
Parameter Value	Used to specify the parameter value. Note: You can specify any special characters except ampersand (&), comma (,), underscore (_), equal to (=), tilde (~), and semi-colon(;) in the predefined parameter value.	Yes
Description	Used to specify the description for the parameter value.	Yes

Note:

The **Parameter Values** section appears when the **Predefined** option is selected from the **Value Type** list. At least one parameter value should be defined for a parameter where the value type is set to **Predefined**.

If you want to define more than one predefined value for the parameter, click the **Add** (+) icon and then specify the details. However, if you want to remove a predefined value of the parameter, click the **Delete** (🗑️) icon corresponding to the parameter value.

- **Parameter Usage** - Used to indicate where the parameter can be used in the system. It contains the following options:

Option Name	Option Description	Mandatory (Yes or No)																
Price Item	<p>Used to indicate whether the parameter can be associated with a price item or price item bundle. If a parameter is associated with a price item or price item bundle, you can use the parameter while defining the price item pricing.</p> <p>Note: The following table lists the source entity and source type combinations when the Price Item option is disabled in the Parameter Usage section:</p> <table border="1" data-bbox="542 558 1263 810"> <thead> <tr> <th>Source Entity</th> <th>Source Type</th> </tr> </thead> <tbody> <tr> <td>Account</td> <td>Usage Amount</td> </tr> <tr> <td>Account</td> <td>Usage Counter</td> </tr> <tr> <td>Person</td> <td>Usage Amount</td> </tr> <tr> <td>Person</td> <td>Usage Counter</td> </tr> </tbody> </table> <p>The following table lists the source entity and source type combinations when the Price Item option does not appear in the Parameter Usage section:</p> <table border="1" data-bbox="542 947 1263 1100"> <thead> <tr> <th>Source Entity</th> <th>Source Type</th> </tr> </thead> <tbody> <tr> <td>Algorithm</td> <td>—</td> </tr> <tr> <td>Service Quantity Identifier</td> <td>—</td> </tr> </tbody> </table>	Source Entity	Source Type	Account	Usage Amount	Account	Usage Counter	Person	Usage Amount	Person	Usage Counter	Source Entity	Source Type	Algorithm	—	Service Quantity Identifier	—	<p>Yes (Conditional)</p> <p>Note: You must select this option when you want to associate the parameter with a price item.</p>
Source Entity	Source Type																	
Account	Usage Amount																	
Account	Usage Counter																	
Person	Usage Amount																	
Person	Usage Counter																	
Source Entity	Source Type																	
Algorithm	—																	
Service Quantity Identifier	—																	
Pricing Eligibility Criteria	<p>Used to indicate whether the parameter can be used while defining the pricing eligibility criteria.</p> <p>Note: This option does not appear when the Transaction option is selected from the Source Entity list.</p>	<p>Yes (Conditional)</p> <p>Note: You must select this option when you want to define a pricing eligibility criteria using the parameter.</p>																
Price List Eligibility Criteria	<p>Used to indicate whether the parameter can be used while defining the price list eligibility criteria.</p> <p>Note: This option does not appear when the Transaction option is selected from the Source Entity list. This option is not applicable for the health insurance business.</p>	<p>Yes (Conditional)</p> <p>Note: You must select this option when you want to define a price list eligibility criteria using the parameter.</p>																

Option Name	Option Description	Mandatory (Yes or No)
Product Eligibility Criteria	Used to indicate whether the parameter can be used while defining the product eligibility criteria.	Yes (Conditional)
	<p>Note:</p> <p>This option does not appear when the Algorithm, Service Quantity Identifier, or Transaction option is selected from the Source Entity list.</p> <p>This option is not applicable for the health insurance business.</p>	<p>Note: You must select this option when you want to define a product eligibility criteria using the parameter.</p>
Rule Eligibility Criteria	Used to indicate whether the parameter can be used while defining the parameter based rule type.	Yes (Conditional)
	<p>Note:</p> <p>This option does not appear when the Product, Service Quantity Identifier, or Transaction option is selected from the Source Entity list.</p>	<p>Note: You must select this option when you want to define a parameter based rule type.</p>

Note: You must select at least one option in the **Parameter Usage** section.

- Enter the required details in the **Parameter** screen depending on whether you want to create an adhoc, predefined, or reference parameter.
- Click **Save**.

The parameter is defined.

Note: If a parameter is already defined using the source entity, source type, and source type code combination, the system will not allow you to define another parameter with the same combination.

Related Topics

For more information on...	See...
Parameter screen	Parameter (Used for Searching) on page 753

Editing a Parameter

Prerequisites

To edit a parameter, you should have:

- Validation algorithm defined using the **C1_PPARM_VAL** algorithm type (in case you want to validate an adhoc parameter value)
- An algorithm defined using the **C1-PPARM-ENT** algorithm type (in case you want to use the algorithm while validating the pricing eligibility criteria)

Note:

A sample algorithm type named **C1_PPARAM_VAL** is shipped with the product. At present, it allows you to specify any special characters except ampersand (&), comma (,), underscore (_), equal to (=), tilde (~), and semi-colon(;), in the parameter value.

A sample algorithm type named **C1-PPARM-ENT** is shipped with the product. At present, it returns a boolean value true. You can build custom logic in this algorithm which returns a value. This value can then be compared against the parameter value specified in the pricing eligibility criteria.

Procedure

To edit a parameter:

1. Search for the parameter in the **Parameter** screen.
2. In the **Search Results** section, click the **Edit** (✎) icon in the **Edit** column corresponding to the parameter whose details you want to edit.

The **Parameter** screen appears. It contains the following fields:

Field Name	Field Description	Mandatory (Yes or No)
Parameter	Used to specify the parameter name.	Yes
	Note: You cannot specify any special character except underscore (_) in the parameter name.	
Source Entity	Used to indicate the entity from where the parameter value should be derived. The valid values are: <ul style="list-style-type: none"> • Account • Algorithm • Benefit • Membership • Membership Person • Person • Plan • Product 	Yes
	Note: This option is not applicable for the health insurance business. <ul style="list-style-type: none"> • Service Quantity Identifier • State • Transaction 	
Description	Used to specify the description for the parameter.	Yes

Field Name	Field Description	Mandatory (Yes or No)															
Source Type	<p>Used to indicate the type of source from where the parameter value should be derived. The valid values are:</p> <ul style="list-style-type: none"> • Characteristic • Field • Usage Amount • Usage Counter <p>Note:</p> <p>This field appears when the Account, Person, or Product option is selected from the Source Entity list.</p> <p>The Usage Amount and Usage Counter options do not appear in the Source Type list when the Product option is selected from the Source Entity list.</p>	Yes															
Value Type	<p>Used to indicate the type of value that you want to store in the parameter. The valid values are:</p> <ul style="list-style-type: none"> • Adhoc • Predefined • Reference 	Yes															
Source Type Code	<p>Used to indicate the source, such as field, characteristic, usage amount, usage counter, SQL, or algorithm, from where the parameter value should be derived.</p> <p>Note:</p> <p>This field does not appear when the Transaction option is selected from the Source Entity list.</p> <p>The following table indicates the values that are listed in the Source Type Code field depending on the source entity and source type combination:</p> <table border="1"> <thead> <tr> <th>Source Entity</th> <th>Source Type</th> <th>Source Type Code</th> </tr> </thead> <tbody> <tr> <td>Account</td> <td>Characteristic</td> <td>Lists all characteristics where the characteristic entity is set to Account.</td> </tr> <tr> <td>Account</td> <td>Field</td> <td>Lists all fields of the CI_ACCT table.</td> </tr> <tr> <td>Account</td> <td>Usage Amount</td> <td>Lists all values defined for the BAL_FLG lookup field.</td> </tr> <tr> <td>Account</td> <td>Usage Counter</td> <td>Lists all values defined for the CNT_FLG lookup field.</td> </tr> </tbody> </table>	Source Entity	Source Type	Source Type Code	Account	Characteristic	Lists all characteristics where the characteristic entity is set to Account .	Account	Field	Lists all fields of the CI_ACCT table.	Account	Usage Amount	Lists all values defined for the BAL_FLG lookup field.	Account	Usage Counter	Lists all values defined for the CNT_FLG lookup field.	Yes
Source Entity	Source Type	Source Type Code															
Account	Characteristic	Lists all characteristics where the characteristic entity is set to Account .															
Account	Field	Lists all fields of the CI_ACCT table.															
Account	Usage Amount	Lists all values defined for the BAL_FLG lookup field.															
Account	Usage Counter	Lists all values defined for the CNT_FLG lookup field.															

Field Name	Field Description	Mandatory (Yes or No)																																				
	<p data-bbox="483 260 548 289">Note:</p> <table border="1" data-bbox="483 310 1222 1598"> <thead> <tr> <th data-bbox="483 310 670 363">Source Entity</th> <th data-bbox="670 310 862 363">Source Type</th> <th data-bbox="862 310 1222 363">Source Type Code</th> </tr> </thead> <tbody> <tr> <td data-bbox="483 363 670 478">Person</td> <td data-bbox="670 363 862 478">Characteristic</td> <td data-bbox="862 363 1222 478">Lists all characteristics where the characteristic entity is set to Person.</td> </tr> <tr> <td data-bbox="483 478 670 562">Person</td> <td data-bbox="670 478 862 562">Field</td> <td data-bbox="862 478 1222 562">Lists all fields of the CI_PER table.</td> </tr> <tr> <td data-bbox="483 562 670 646">Person</td> <td data-bbox="670 562 862 646">Usage Amount</td> <td data-bbox="862 562 1222 646">Lists all values defined for the BAL_FLG lookup field.</td> </tr> <tr> <td data-bbox="483 646 670 730">Person</td> <td data-bbox="670 646 862 730">Usage Counter</td> <td data-bbox="862 646 1222 730">Lists all values defined for the CNT_FLG lookup field.</td> </tr> <tr> <td data-bbox="483 730 670 846">Benefit</td> <td data-bbox="670 730 862 846">Characteristic</td> <td data-bbox="862 730 1222 846">Lists all characteristics where the characteristic entity is set to Benefit.</td> </tr> <tr> <td data-bbox="483 846 670 930">Benefit</td> <td data-bbox="670 846 862 930">Field</td> <td data-bbox="862 846 1222 930">Lists all fields of the CI_BENEFITS table.</td> </tr> <tr> <td data-bbox="483 930 670 1045">Membership</td> <td data-bbox="670 930 862 1045">Characteristic</td> <td data-bbox="862 930 1222 1045">Lists all characteristics where the characteristic entity is set to Membership.</td> </tr> <tr> <td data-bbox="483 1045 670 1129">Membership</td> <td data-bbox="670 1045 862 1129">Field</td> <td data-bbox="862 1045 1222 1129">Lists all fields of the CI_MEMBERSHIP table.</td> </tr> <tr> <td data-bbox="483 1129 670 1245">Membership Person</td> <td data-bbox="670 1129 862 1245">Characteristic</td> <td data-bbox="862 1129 1222 1245">Lists all characteristics where the characteristic entity is set to Membership Person.</td> </tr> <tr> <td data-bbox="483 1245 670 1360">Membership Person</td> <td data-bbox="670 1245 862 1360">Field</td> <td data-bbox="862 1245 1222 1360">Lists all fields of the CI_MEMBERSHIP_PER table.</td> </tr> <tr> <td data-bbox="483 1360 670 1598">Product</td> <td data-bbox="670 1360 862 1598">Characteristic</td> <td data-bbox="862 1360 1222 1598"> Lists all characteristics where the characteristic entity is set to Product. <div data-bbox="873 1472 1214 1581" style="border: 1px solid black; padding: 5px;"> <p data-bbox="878 1478 1209 1566">Note: This option is not applicable for the health insurance business.</p> </div> </td> </tr> </tbody> </table>	Source Entity	Source Type	Source Type Code	Person	Characteristic	Lists all characteristics where the characteristic entity is set to Person .	Person	Field	Lists all fields of the CI_PER table.	Person	Usage Amount	Lists all values defined for the BAL_FLG lookup field.	Person	Usage Counter	Lists all values defined for the CNT_FLG lookup field.	Benefit	Characteristic	Lists all characteristics where the characteristic entity is set to Benefit .	Benefit	Field	Lists all fields of the CI_BENEFITS table.	Membership	Characteristic	Lists all characteristics where the characteristic entity is set to Membership .	Membership	Field	Lists all fields of the CI_MEMBERSHIP table.	Membership Person	Characteristic	Lists all characteristics where the characteristic entity is set to Membership Person .	Membership Person	Field	Lists all fields of the CI_MEMBERSHIP_PER table.	Product	Characteristic	Lists all characteristics where the characteristic entity is set to Product . <div data-bbox="873 1472 1214 1581" style="border: 1px solid black; padding: 5px;"> <p data-bbox="878 1478 1209 1566">Note: This option is not applicable for the health insurance business.</p> </div>	
Source Entity	Source Type	Source Type Code																																				
Person	Characteristic	Lists all characteristics where the characteristic entity is set to Person .																																				
Person	Field	Lists all fields of the CI_PER table.																																				
Person	Usage Amount	Lists all values defined for the BAL_FLG lookup field.																																				
Person	Usage Counter	Lists all values defined for the CNT_FLG lookup field.																																				
Benefit	Characteristic	Lists all characteristics where the characteristic entity is set to Benefit .																																				
Benefit	Field	Lists all fields of the CI_BENEFITS table.																																				
Membership	Characteristic	Lists all characteristics where the characteristic entity is set to Membership .																																				
Membership	Field	Lists all fields of the CI_MEMBERSHIP table.																																				
Membership Person	Characteristic	Lists all characteristics where the characteristic entity is set to Membership Person .																																				
Membership Person	Field	Lists all fields of the CI_MEMBERSHIP_PER table.																																				
Product	Characteristic	Lists all characteristics where the characteristic entity is set to Product . <div data-bbox="873 1472 1214 1581" style="border: 1px solid black; padding: 5px;"> <p data-bbox="878 1478 1209 1566">Note: This option is not applicable for the health insurance business.</p> </div>																																				

Field Name	Field Description	Mandatory (Yes or No)																								
	<p>Note:</p> <table border="1"> <thead> <tr> <th data-bbox="483 310 667 359">Source Entity</th> <th data-bbox="667 310 867 359">Source Type</th> <th data-bbox="867 310 1227 359">Source Type Code</th> </tr> </thead> <tbody> <tr> <td data-bbox="483 359 667 583">Product</td> <td data-bbox="667 359 867 583">Field</td> <td data-bbox="867 359 1227 583"> Lists all fields of the CI_PRODUCT table. <div style="border: 1px solid black; padding: 2px;"> <p>Note: This option is not applicable for the health insurance business.</p> </div> </td> </tr> <tr> <td data-bbox="483 583 667 695">Plan</td> <td data-bbox="667 583 867 695">Characteristic</td> <td data-bbox="867 583 1227 695">Lists all characteristics where the characteristic entity is set to Plan.</td> </tr> <tr> <td data-bbox="483 695 667 779">Plan</td> <td data-bbox="667 695 867 779">Field</td> <td data-bbox="867 695 1227 779">Lists all fields of the CI_POLICY_PLAN table.</td> </tr> <tr> <td data-bbox="483 779 667 890">Service Quantity Identifier</td> <td data-bbox="667 779 867 890">—</td> <td data-bbox="867 779 1227 890">Lists all service quantity identifiers available in the CI_SQI table.</td> </tr> <tr> <td data-bbox="483 890 667 1010">State</td> <td data-bbox="667 890 867 1010">Characteristic</td> <td data-bbox="867 890 1227 1010">Lists all characteristics where the characteristic entity is set to State.</td> </tr> <tr> <td data-bbox="483 1010 667 1094">State</td> <td data-bbox="667 1010 867 1094">Field</td> <td data-bbox="867 1010 1227 1094">Lists all fields of the CI_STATE table.</td> </tr> <tr> <td data-bbox="483 1094 667 1205">Algorithm</td> <td data-bbox="667 1094 867 1205">—</td> <td data-bbox="867 1094 1227 1205">Lists all algorithms which are defined using the CI-PPARM-ENT algorithm type.</td> </tr> </tbody> </table>	Source Entity	Source Type	Source Type Code	Product	Field	Lists all fields of the CI_PRODUCT table. <div style="border: 1px solid black; padding: 2px;"> <p>Note: This option is not applicable for the health insurance business.</p> </div>	Plan	Characteristic	Lists all characteristics where the characteristic entity is set to Plan .	Plan	Field	Lists all fields of the CI_POLICY_PLAN table.	Service Quantity Identifier	—	Lists all service quantity identifiers available in the CI_SQI table.	State	Characteristic	Lists all characteristics where the characteristic entity is set to State .	State	Field	Lists all fields of the CI_STATE table.	Algorithm	—	Lists all algorithms which are defined using the CI-PPARM-ENT algorithm type.	
Source Entity	Source Type	Source Type Code																								
Product	Field	Lists all fields of the CI_PRODUCT table. <div style="border: 1px solid black; padding: 2px;"> <p>Note: This option is not applicable for the health insurance business.</p> </div>																								
Plan	Characteristic	Lists all characteristics where the characteristic entity is set to Plan .																								
Plan	Field	Lists all fields of the CI_POLICY_PLAN table.																								
Service Quantity Identifier	—	Lists all service quantity identifiers available in the CI_SQI table.																								
State	Characteristic	Lists all characteristics where the characteristic entity is set to State .																								
State	Field	Lists all fields of the CI_STATE table.																								
Algorithm	—	Lists all algorithms which are defined using the CI-PPARM-ENT algorithm type.																								
Validation Algorithm	<p>Used to indicate the algorithm using which you want to validate the adhoc parameter value.</p> <p>Note:</p> <p>This field appears when the Adhoc option is selected from the Value Type list.</p> <p>The Search (🔍) icon appears corresponding to the Validation Algorithm field. On clicking the Search icon, the Algorithm Search window appears.</p>	No																								

Field Name	Field Description	Mandatory (Yes or No)
Reference Entity	Used to indicate the table whose primary key (column) you want to set as the reference entity. Note: This field appears only when the Reference option is selected from the Value Type list. The Search (🔍) icon appears corresponding to the Reference Entity field. On clicking the Search icon, the Reference Table Search window appears. You can only specify a language table, where the DESCR column is available, in the Reference Entity field.	Yes
Field Name	Indicates the column which is the primary key of the table. The parameter value is then validated against the primary column of the table. Note: This field appears when the Reference option is selected from the Value Type list.	Not applicable

In addition, this screen contains the following two sections:

- **Parameter Values** - Used to define predefined values for the parameter. It contains the following fields in the grid:

Field Name	Field Description	Mandatory (Yes or No)
Parameter Value	Used to specify the parameter value. Note: You can specify any special characters except ampersand (&), comma (,), underscore (_), equal to (=), tilde (~), and semi-colon(;) in the predefined parameter value.	Yes
Description	Used to specify the description for the parameter value.	Yes

Note:

The **Parameter Values** section appears when the **Predefined** option is selected from the **Value Type** list.

At least one parameter value should be defined for a parameter where the value type is set to **Predefined**.

If you want to define more than one predefined value for the parameter, click the **Add** (+) icon and then specify the details. However, if you want to remove a predefined value of the parameter, click the **Delete** (🗑️) icon corresponding to the parameter value.

You cannot delete a predefined parameter value which is already used in the system.

- **Parameter Usage** - Used to indicate where the parameter can be used in the system. It contains the following options:

Option Name	Option Description	Mandatory (Yes or No)																
Price Item	<p>Used to indicate whether the parameter can be associated with a price item or price item bundle. If a parameter is associated with a price item or price item bundle, you can use the parameter while defining the price item pricing.</p> <p>Note: The following table lists the source entity and source type combinations when the Price Item option is disabled in the Parameter Usage section:</p> <table border="1" data-bbox="542 558 1263 810"> <thead> <tr> <th>Source Entity</th> <th>Source Type</th> </tr> </thead> <tbody> <tr> <td>Account</td> <td>Usage Amount</td> </tr> <tr> <td>Account</td> <td>Usage Counter</td> </tr> <tr> <td>Person</td> <td>Usage Amount</td> </tr> <tr> <td>Person</td> <td>Usage Counter</td> </tr> </tbody> </table> <p>The following table lists the source entity and source type combinations when the Price Item option does not appear in the Parameter Usage section:</p> <table border="1" data-bbox="542 947 1263 1100"> <thead> <tr> <th>Source Entity</th> <th>Source Type</th> </tr> </thead> <tbody> <tr> <td>Algorithm</td> <td>—</td> </tr> <tr> <td>Service Quantity Identifier</td> <td>—</td> </tr> </tbody> </table>	Source Entity	Source Type	Account	Usage Amount	Account	Usage Counter	Person	Usage Amount	Person	Usage Counter	Source Entity	Source Type	Algorithm	—	Service Quantity Identifier	—	<p>Yes (Conditional)</p> <p>Note: You must select this option when you want to associate the parameter with a price item.</p>
Source Entity	Source Type																	
Account	Usage Amount																	
Account	Usage Counter																	
Person	Usage Amount																	
Person	Usage Counter																	
Source Entity	Source Type																	
Algorithm	—																	
Service Quantity Identifier	—																	
Pricing Eligibility Criteria	<p>Used to indicate whether the parameter can be used while defining the pricing eligibility criteria.</p> <p>Note: This option does not appear when the Transaction option is selected from the Source Entity list.</p>	<p>Yes (Conditional)</p> <p>Note: You must select this option when you want to define a pricing eligibility criteria using the parameter.</p>																
Price List Eligibility Criteria	<p>Used to indicate whether the parameter can be used while defining the price list eligibility criteria.</p> <p>Note: This option does not appear when the Transaction option is selected from the Source Entity list. This option is not applicable for the health insurance business.</p>	<p>Yes (Conditional)</p> <p>Note: You must select this option when you want to define a price list eligibility criteria using the parameter.</p>																

Option Name	Option Description	Mandatory (Yes or No)
Product Eligibility Criteria	Used to indicate whether the parameter can be used while defining the product eligibility criteria.	Yes (Conditional)
	<p>Note:</p> <p>This option does not appear when the Algorithm, Service Quantity Identifier, or Transaction option is selected from the Source Entity list.</p> <p>This option is not applicable for the health insurance business.</p>	<p>Note: You must select this option when you want to define a product eligibility criteria using the parameter.</p>
Rule Eligibility Criteria	Used to indicate whether the parameter can be used while defining the parameter based rule type.	Yes (Conditional)
	<p>Note:</p> <p>This option does not appear when the Product, Service Quantity Identifier, or Transaction option is selected from the Source Entity list.</p>	<p>Note: You must select this option when you want to define a parameter based rule type.</p>

Note: You must select at least one option in the **Parameter Usage** section.

3. Modify the required details in the **Parameter** screen.
4. Click **Save**.

The changes made to the parameter are saved.

Related Topics

For more information on...	See...
How to search for a parameter	Searching for a Parameter on page 756

Deleting a Parameter

Procedure

To delete a parameter:

1. Search for the parameter in the **Parameter** screen.
2. In the **Search Results** section, click the **Delete** () icon in the **Delete** column corresponding to the parameter that you want to delete.

A message appears confirming whether you want to delete the parameter.

Note:

You can delete a parameter when the following conditions are met:

- It is not yet associated to any price item or price item bundle.
- It is not yet used while defining the pricing, price list, or product eligibility criteria.

3. Click OK.

The parameter is deleted.

Related Topics

For more information on...	See...
How to search for a parameter	Searching for a Parameter on page 756

Copying a Parameter

Instead of creating a parameter from scratch, you can define a new parameter using an existing parameter. This is possible through copying a parameter. When you copy a parameter, the predefined values, validation algorithm, and reference entity (depending upon the value type) are copied along with other parameter details. You can then edit the details, if required.

Note: You cannot change the type of value that you can store in the new parameter (which is created using an existing parameter).

Prerequisites

To copy a parameter, you should have:

- Parameter (whose copy you want to create) defined in the application
- Validation algorithm defined using the **C1_PPARM_VAL** algorithm type (in case you want to validate an adhoc parameter value)
- An algorithm defined using the **C1-PPARM-ENT** algorithm type (in case you want to use the algorithm while validating the pricing eligibility criteria)

Note:

A sample algorithm type named **C1_PPARM_VAL** is shipped with the product. At present, it allows you to specify any special characters except ampersand (&), comma (,), underscore (_), equal to (=), tilde (~), and semi-colon(;) in the parameter value.

A sample algorithm type named **C1-PPARM-ENT** is shipped with the product. At present, it returns a boolean value true. You can build custom logic in this algorithm which returns a value. This value can then be compared against the parameter value specified in the pricing eligibility criteria.

Procedure

To copy a parameter:

1. Search for the parameter in the **Parameter** screen.
2. In the **Search Results** section, click the **Copy**  icon in the **Copy** column corresponding to the parameter whose copy you want to create.

The **Parameter** screen appears. It contains the following fields:

Field Name	Field Description	Mandatory (Yes or No)
Parameter	Used to specify the parameter name.	Yes
	Note: You cannot specify any special character except underscore (_) in the parameter name.	
Source Entity	Used to indicate the entity from where the parameter value should be derived. The valid values are: <ul style="list-style-type: none"> • Account • Algorithm • Benefit • Membership • Membership Person • Person • Plan • Product 	Yes
	<p>Note: This option is not applicable for the health insurance business.</p> <ul style="list-style-type: none"> • Service Quantity Identifier • State • Transaction 	
Description	Used to specify the description for the parameter.	Yes
Source Type	Used to indicate the type of source from where the parameter value should be derived. The valid values are: <ul style="list-style-type: none"> • Characteristic • Field • Usage Amount • Usage Counter 	Yes
	<p>Note:</p> <p>This field appears when the Account, Person, or Product option is selected from the Source Entity list.</p> <p>The Usage Amount and Usage Counter options do not appear in the Source Type list when the Product option is selected from the Source Entity list.</p>	

Field Name	Field Description	Mandatory (Yes or No)															
Value Type	Used to indicate the type of value that you want to store in the parameter. The valid values are: <ul style="list-style-type: none"> • Adhoc • Predefined • Reference 	Yes															
Source Type Code	Used to indicate the source, such as field, characteristic, usage amount, usage counter, SQL, or algorithm, from where the parameter value should be derived. <p>Note:</p> This field does not appear when the Transaction option is selected from the Source Entity list. The following table indicates the values that are listed in the Source Type Code field depending on the source entity and source type combination: <table border="1" data-bbox="480 842 1222 1251"> <thead> <tr> <th>Source Entity</th> <th>Source Type</th> <th>Source Type Code</th> </tr> </thead> <tbody> <tr> <td>Account</td> <td>Characteristic</td> <td>Lists all characteristics where the characteristic entity is set to Account.</td> </tr> <tr> <td>Account</td> <td>Field</td> <td>Lists all fields of the CI_ACCT table.</td> </tr> <tr> <td>Account</td> <td>Usage Amount</td> <td>Lists all values defined for the BAL_FLG lookup field.</td> </tr> <tr> <td>Account</td> <td>Usage Counter</td> <td>Lists all values defined for the CNT_FLG lookup field.</td> </tr> </tbody> </table>	Source Entity	Source Type	Source Type Code	Account	Characteristic	Lists all characteristics where the characteristic entity is set to Account .	Account	Field	Lists all fields of the CI_ACCT table.	Account	Usage Amount	Lists all values defined for the BAL_FLG lookup field.	Account	Usage Counter	Lists all values defined for the CNT_FLG lookup field.	Yes
Source Entity	Source Type	Source Type Code															
Account	Characteristic	Lists all characteristics where the characteristic entity is set to Account .															
Account	Field	Lists all fields of the CI_ACCT table.															
Account	Usage Amount	Lists all values defined for the BAL_FLG lookup field.															
Account	Usage Counter	Lists all values defined for the CNT_FLG lookup field.															

Field Name	Field Description	Mandatory (Yes or No)																																				
	<p data-bbox="483 260 545 289">Note:</p> <table border="1" data-bbox="483 310 1224 1598"> <thead> <tr> <th data-bbox="483 310 672 363">Source Entity</th> <th data-bbox="672 310 862 363">Source Type</th> <th data-bbox="862 310 1224 363">Source Type Code</th> </tr> </thead> <tbody> <tr> <td data-bbox="483 363 672 478">Person</td> <td data-bbox="672 363 862 478">Characteristic</td> <td data-bbox="862 363 1224 478">Lists all characteristics where the characteristic entity is set to Person.</td> </tr> <tr> <td data-bbox="483 478 672 558">Person</td> <td data-bbox="672 478 862 558">Field</td> <td data-bbox="862 478 1224 558">Lists all fields of the CI_PER table.</td> </tr> <tr> <td data-bbox="483 558 672 638">Person</td> <td data-bbox="672 558 862 638">Usage Amount</td> <td data-bbox="862 558 1224 638">Lists all values defined for the BAL_FLG lookup field.</td> </tr> <tr> <td data-bbox="483 638 672 718">Person</td> <td data-bbox="672 638 862 718">Usage Counter</td> <td data-bbox="862 638 1224 718">Lists all values defined for the CNT_FLG lookup field.</td> </tr> <tr> <td data-bbox="483 718 672 833">Benefit</td> <td data-bbox="672 718 862 833">Characteristic</td> <td data-bbox="862 718 1224 833">Lists all characteristics where the characteristic entity is set to Benefit.</td> </tr> <tr> <td data-bbox="483 833 672 913">Benefit</td> <td data-bbox="672 833 862 913">Field</td> <td data-bbox="862 833 1224 913">Lists all fields of the CI_BENEFITS table.</td> </tr> <tr> <td data-bbox="483 913 672 1029">Membership</td> <td data-bbox="672 913 862 1029">Characteristic</td> <td data-bbox="862 913 1224 1029">Lists all characteristics where the characteristic entity is set to Membership.</td> </tr> <tr> <td data-bbox="483 1029 672 1108">Membership</td> <td data-bbox="672 1029 862 1108">Field</td> <td data-bbox="862 1029 1224 1108">Lists all fields of the CI_MEMBERSHIP table.</td> </tr> <tr> <td data-bbox="483 1108 672 1224">Membership Person</td> <td data-bbox="672 1108 862 1224">Characteristic</td> <td data-bbox="862 1108 1224 1224">Lists all characteristics where the characteristic entity is set to Membership Person.</td> </tr> <tr> <td data-bbox="483 1224 672 1339">Membership Person</td> <td data-bbox="672 1224 862 1339">Field</td> <td data-bbox="862 1224 1224 1339">Lists all fields of the CI_MEMBERSHIP_PER table.</td> </tr> <tr> <td data-bbox="483 1339 672 1598">Product</td> <td data-bbox="672 1339 862 1598">Characteristic</td> <td data-bbox="862 1339 1224 1598"> Lists all characteristics where the characteristic entity is set to Product. <div data-bbox="873 1465 1214 1583" style="border: 1px solid black; padding: 5px;"> <p>Note: This option is not applicable for the health insurance business.</p> </div> </td> </tr> </tbody> </table>	Source Entity	Source Type	Source Type Code	Person	Characteristic	Lists all characteristics where the characteristic entity is set to Person .	Person	Field	Lists all fields of the CI_PER table.	Person	Usage Amount	Lists all values defined for the BAL_FLG lookup field.	Person	Usage Counter	Lists all values defined for the CNT_FLG lookup field.	Benefit	Characteristic	Lists all characteristics where the characteristic entity is set to Benefit .	Benefit	Field	Lists all fields of the CI_BENEFITS table.	Membership	Characteristic	Lists all characteristics where the characteristic entity is set to Membership .	Membership	Field	Lists all fields of the CI_MEMBERSHIP table.	Membership Person	Characteristic	Lists all characteristics where the characteristic entity is set to Membership Person .	Membership Person	Field	Lists all fields of the CI_MEMBERSHIP_PER table.	Product	Characteristic	Lists all characteristics where the characteristic entity is set to Product . <div data-bbox="873 1465 1214 1583" style="border: 1px solid black; padding: 5px;"> <p>Note: This option is not applicable for the health insurance business.</p> </div>	
Source Entity	Source Type	Source Type Code																																				
Person	Characteristic	Lists all characteristics where the characteristic entity is set to Person .																																				
Person	Field	Lists all fields of the CI_PER table.																																				
Person	Usage Amount	Lists all values defined for the BAL_FLG lookup field.																																				
Person	Usage Counter	Lists all values defined for the CNT_FLG lookup field.																																				
Benefit	Characteristic	Lists all characteristics where the characteristic entity is set to Benefit .																																				
Benefit	Field	Lists all fields of the CI_BENEFITS table.																																				
Membership	Characteristic	Lists all characteristics where the characteristic entity is set to Membership .																																				
Membership	Field	Lists all fields of the CI_MEMBERSHIP table.																																				
Membership Person	Characteristic	Lists all characteristics where the characteristic entity is set to Membership Person .																																				
Membership Person	Field	Lists all fields of the CI_MEMBERSHIP_PER table.																																				
Product	Characteristic	Lists all characteristics where the characteristic entity is set to Product . <div data-bbox="873 1465 1214 1583" style="border: 1px solid black; padding: 5px;"> <p>Note: This option is not applicable for the health insurance business.</p> </div>																																				

Field Name	Field Description	Mandatory (Yes or No)																								
	<p>Note:</p> <table border="1"> <thead> <tr> <th data-bbox="480 310 667 363">Source Entity</th> <th data-bbox="672 310 867 363">Source Type</th> <th data-bbox="872 310 1222 363">Source Type Code</th> </tr> </thead> <tbody> <tr> <td data-bbox="480 369 667 583">Product</td> <td data-bbox="672 369 867 583">Field</td> <td data-bbox="872 369 1222 583"> Lists all fields of the CI_PRODUCT table. <div style="border: 1px solid black; padding: 2px; margin-top: 5px;"> <p>Note: This option is not applicable for the health insurance business.</p> </div> </td> </tr> <tr> <td data-bbox="480 590 667 699">Plan</td> <td data-bbox="672 590 867 699">Characteristic</td> <td data-bbox="872 590 1222 699">Lists all characteristics where the characteristic entity is set to Plan.</td> </tr> <tr> <td data-bbox="480 705 667 779">Plan</td> <td data-bbox="672 705 867 779">Field</td> <td data-bbox="872 705 1222 779">Lists all fields of the CI_POLICY_PLAN table.</td> </tr> <tr> <td data-bbox="480 785 667 894">Service Quantity Identifier</td> <td data-bbox="672 785 867 894">—</td> <td data-bbox="872 785 1222 894">Lists all service quantity identifiers available in the CI_SQI table.</td> </tr> <tr> <td data-bbox="480 900 667 1010">State</td> <td data-bbox="672 900 867 1010">Characteristic</td> <td data-bbox="872 900 1222 1010">Lists all characteristics where the characteristic entity is set to State.</td> </tr> <tr> <td data-bbox="480 1016 667 1092">State</td> <td data-bbox="672 1016 867 1092">Field</td> <td data-bbox="872 1016 1222 1092">Lists all fields of the CI_STATE table.</td> </tr> <tr> <td data-bbox="480 1098 667 1207">Algorithm</td> <td data-bbox="672 1098 867 1207">—</td> <td data-bbox="872 1098 1222 1207">Lists all algorithms which are defined using the CI-PPARM-ENT algorithm type.</td> </tr> </tbody> </table>	Source Entity	Source Type	Source Type Code	Product	Field	Lists all fields of the CI_PRODUCT table. <div style="border: 1px solid black; padding: 2px; margin-top: 5px;"> <p>Note: This option is not applicable for the health insurance business.</p> </div>	Plan	Characteristic	Lists all characteristics where the characteristic entity is set to Plan .	Plan	Field	Lists all fields of the CI_POLICY_PLAN table.	Service Quantity Identifier	—	Lists all service quantity identifiers available in the CI_SQI table.	State	Characteristic	Lists all characteristics where the characteristic entity is set to State .	State	Field	Lists all fields of the CI_STATE table.	Algorithm	—	Lists all algorithms which are defined using the CI-PPARM-ENT algorithm type.	
Source Entity	Source Type	Source Type Code																								
Product	Field	Lists all fields of the CI_PRODUCT table. <div style="border: 1px solid black; padding: 2px; margin-top: 5px;"> <p>Note: This option is not applicable for the health insurance business.</p> </div>																								
Plan	Characteristic	Lists all characteristics where the characteristic entity is set to Plan .																								
Plan	Field	Lists all fields of the CI_POLICY_PLAN table.																								
Service Quantity Identifier	—	Lists all service quantity identifiers available in the CI_SQI table.																								
State	Characteristic	Lists all characteristics where the characteristic entity is set to State .																								
State	Field	Lists all fields of the CI_STATE table.																								
Algorithm	—	Lists all algorithms which are defined using the CI-PPARM-ENT algorithm type.																								
Validation Algorithm	<p>Used to indicate the algorithm using which you want to validate the adhoc parameter value.</p> <p>Note:</p> <p>This field appears when the Adhoc option is selected from the Value Type list.</p> <p>The Search (🔍) icon appears corresponding to the Validation Algorithm field. On clicking the Search icon, the Algorithm Search window appears.</p>	No																								

Field Name	Field Description	Mandatory (Yes or No)
Reference Entity	Used to indicate the table whose primary key (column) you want to set as the reference entity. Note: This field appears only when the Reference option is selected from the Value Type list. The Search (🔍) icon appears corresponding to the Reference Entity field. On clicking the Search icon, the Reference Table Search window appears. You can only specify a language table, where the DESCR column is available, in the Reference Entity field.	Yes
Field Name	Indicates the column which is the primary key of the table. The parameter value is then validated against the primary column of the table. Note: This field appears when the Reference option is selected from the Value Type list.	Not applicable

In addition, this screen contains the following two sections:

- **Parameter Values** - Used to define predefined values for the parameter. It contains the following fields in the grid:

Field Name	Field Description	Mandatory (Yes or No)
Parameter Value	Used to specify the parameter value. Note: You can specify any special characters except ampersand (&), comma (,), underscore (_), equal to (=), tilde (~), and semi-colon(;) in the predefined parameter value.	Yes
Description	Used to specify the description for the parameter value.	Yes

Note:

The **Parameter Values** section appears when the **Predefined** option is selected from the **Value Type** list.

At least one parameter value should be defined for a parameter where the value type is set to **Predefined**.

If you want to define more than one predefined value for the parameter, click the **Add** (+) icon and then specify the details. However, if you want to remove a predefined value of the parameter, click the **Delete** (🗑️) icon corresponding to the parameter value.

- **Parameter Usage** - Used to indicate where the parameter can be used in the system. It contains the following options:

Option Name	Option Description	Mandatory (Yes or No)																
Price Item	<p>Used to indicate whether the parameter can be associated with a price item or price item bundle. If a parameter is associated with a price item or price item bundle, you can use the parameter while defining the price item pricing.</p> <p>Note: The following table lists the source entity and source type combinations when the Price Item option is disabled in the Parameter Usage section:</p> <table border="1" data-bbox="542 558 1263 810"> <thead> <tr> <th>Source Entity</th> <th>Source Type</th> </tr> </thead> <tbody> <tr> <td>Account</td> <td>Usage Amount</td> </tr> <tr> <td>Account</td> <td>Usage Counter</td> </tr> <tr> <td>Person</td> <td>Usage Amount</td> </tr> <tr> <td>Person</td> <td>Usage Counter</td> </tr> </tbody> </table> <p>The following table lists the source entity and source type combinations when the Price Item option does not appear in the Parameter Usage section:</p> <table border="1" data-bbox="542 947 1263 1100"> <thead> <tr> <th>Source Entity</th> <th>Source Type</th> </tr> </thead> <tbody> <tr> <td>Algorithm</td> <td>—</td> </tr> <tr> <td>Service Quantity Identifier</td> <td>—</td> </tr> </tbody> </table>	Source Entity	Source Type	Account	Usage Amount	Account	Usage Counter	Person	Usage Amount	Person	Usage Counter	Source Entity	Source Type	Algorithm	—	Service Quantity Identifier	—	<p>Yes (Conditional)</p> <p>Note: You must select this option when you want to associate the parameter with a price item.</p>
Source Entity	Source Type																	
Account	Usage Amount																	
Account	Usage Counter																	
Person	Usage Amount																	
Person	Usage Counter																	
Source Entity	Source Type																	
Algorithm	—																	
Service Quantity Identifier	—																	
Pricing Eligibility Criteria	<p>Used to indicate whether the parameter can be used while defining the pricing eligibility criteria.</p> <p>Note: This option does not appear when the Transaction option is selected from the Source Entity list.</p>	<p>Yes (Conditional)</p> <p>Note: You must select this option when you want to define a pricing eligibility criteria using the parameter.</p>																
Price List Eligibility Criteria	<p>Used to indicate whether the parameter can be used while defining the price list eligibility criteria.</p> <p>Note: This option does not appear when the Transaction option is selected from the Source Entity list. This option is not applicable for the health insurance business.</p>	<p>Yes (Conditional)</p> <p>Note: You must select this option when you want to define a price list eligibility criteria using the parameter.</p>																

Option Name	Option Description	Mandatory (Yes or No)
Product Eligibility Criteria	Used to indicate whether the parameter can be used while defining the product eligibility criteria.	Yes (Conditional)
	<p>Note:</p> <p>This option does not appear when the Algorithm, Service Quantity Identifier, or Transaction option is selected from the Source Entity list.</p> <p>This option is not applicable for the health insurance business.</p>	<p>Note: You must select this option when you want to define a product eligibility criteria using the parameter.</p>
Rule Eligibility Criteria	Used to indicate whether the parameter can be used while defining the parameter based rule type.	Yes (Conditional)
	<p>Note:</p> <p>This option does not appear when the Product, Service Quantity Identifier, or Transaction option is selected from the Source Entity list.</p>	<p>Note: You must select this option when you want to define a parameter based rule type.</p>

Note: You must select at least one option in the **Parameter Usage** section.

- Enter the required details in the **Parameter** screen depending on whether you want to create an adhoc, predefined, or reference parameter.
- Click **Save**.

The parameter is defined.

Note: If a parameter is already defined using the source entity, source type, and source type code combination, the system will not allow you to define another parameter with the same combination.

Related Topics

For more information on...	See...
How to search for a parameter	Searching for a Parameter on page 756

Viewing the Parameter Details

Procedure

To view the details of a parameter:

- Search for the parameter in the **Parameter** screen.
- In the **Search Results** section, click the **View** () icon in the **View** column corresponding to the parameter whose details you want to view.

The **Parameter** screen appears.

- View the details of the parameter in the **Parameter** screen.

Related Topics

For more information on...	See...
How to search for a parameter	Searching for a Parameter on page 756
Parameter screen	Parameter (Used for Viewing) on page 779
Parameter zone	Parameters on page 828

Parameter (Used for Viewing)

The **Parameter** screen allows you to view the details of a parameter. It contains the following zone:

- [Parameter](#) on page 779

Parameter

The **Parameter** zone displays the details of the parameter. It contains the following sections:

- **Main** – Displays basic information about the parameter. It contains the following fields:

Field Name	Field Description
Parameter	Displays the parameter name.
Description	Displays the description of the parameter.
Value Type	Indicates the type of value that you can store in the parameter. The valid values are: <ul style="list-style-type: none"> • Adhoc • Predefined • Reference
Validation Algorithm	Indicates the algorithm which is used to validate the adhoc parameter value. <div style="border: 1px solid black; padding: 5px; margin-top: 5px;"> <p>Note:</p> <p>This field appears when the Adhoc option is selected from the Value Type list. It has a link. On clicking the link, the Algorithm screen appears where you can view the details of the respective algorithm.</p> </div>
Referenced Table	Indicates the table whose primary key (i.e. column) is used to validate the parameter value. <div style="border: 1px solid black; padding: 5px; margin-top: 5px;"> <p>Note:</p> <p>This field appears when the Reference option is selected from the Value Type list. It has a link. On clicking the link, the Table screen appears where you can view the details of the respective table.</p> </div>

Field Name	Field Description
Source Entity	<p>Indicates the entity from where the parameter value is derived. The valid values are:</p> <ul style="list-style-type: none"> • Account • Algorithm • Benefit • Membership • Membership Person • Person • Plan • Product • Service Quantity Identifier • State • Transaction
Source Type	<p>Indicates the type of source from where the parameter value is derived. The valid values are:</p> <ul style="list-style-type: none"> • Characteristic • Field • Usage Amount • Usage Counter <p>Note: This field appears when the Account, Benefit, Membership, Membership Person, Plan, , Person, Product or State option is selected from the Source Entity list.</p>
Source Type Code	<p>Indicates the source, such as field, characteristic, usage amount, usage counter, SQI, or algorithm, from where the parameter value is derived.</p> <p>Note: This field does not appear when the Transaction option is selected from the Source Entity list.</p>

- **Parameter Usage** – Indicates where the parameter can be used in the system. It contains the following options:

Option Name	Option Description						
Price Item	<p>Indicates whether the parameter can be associated with a price item or price item bundle. If a parameter is associated with a price item or price item bundle, you can use the parameter while defining the price item pricing.</p> <p>The following table lists the source entity and source type combinations when the Price Item option does not appear in the Parameter Usage section:</p> <table border="1"> <thead> <tr> <th>Source Entity</th> <th>Source Type</th> </tr> </thead> <tbody> <tr> <td>Algorithm</td> <td>—</td> </tr> <tr> <td>Service Quantity Identifier</td> <td>—</td> </tr> </tbody> </table>	Source Entity	Source Type	Algorithm	—	Service Quantity Identifier	—
Source Entity	Source Type						
Algorithm	—						
Service Quantity Identifier	—						

Option Name	Option Description
Pricing Eligibility Criteria	Indicates whether the parameter can be used while defining the pricing eligibility criteria.
	Note: This option does not appear when the Transaction option is selected from the Source Entity list.
Price List Eligibility Criteria	Indicates whether the parameter can be used while defining the price list eligibility criteria.
	Note: This option does not appear when the Transaction option is selected from the Source Entity list.
Product Eligibility Criteria	Indicates whether the parameter can be used while defining the product eligibility criteria.
	Note: This option does not appear when the Algorithm, Service Quantity Identifier, or Transaction option is selected from the Source Entity list.
Rule Eligibility Criteria	Indicates whether the parameter can be used while defining the parameter based rule type.
	Note: This option does not appear when the Product, Service Quantity Identifier, or Transaction option is selected from the Source Entity list.

- **Parameter Values** - Lists the predefined values of the parameter. It contains the following columns in the grid:

Column Name	Column Description
Parameter Value	Displays the parameter value.
Description	Displays the description of the parameter value.

Note: The **Parameter Values** section appears when the **Predefined** option is selected from the **Value Type** list.

Related Topics

For more information on...	See...
Parameter screen	Parameter (Used for Viewing) on page 779

Price Item (Health Insurance Business)

The various charges that are to be charged to the customer (for example, premium or optional administration fees to a fully-insured group customer and claim based fees or enrollment based fees to a self-funded customer) are defined as price items in the system. Similarly, various charges credited to the customer are also defined as price items. Stop-loss arrangements for a self-funded customer (for example, specific stop-loss that is calculated and credited to customer) is represented using a price item in the system.

Once you define a price item, you can also define the pricing for the price item at various levels using pricing rules based on the requirements. For a fully-insured group customer, the pricing is defined at the policy plan level. Whereas, for a self-funded customer, the pricing can be defined either at the bill group policy level or at the parent customer level. For more information about the fully-insured pricing, see [Fully-Insured Pricing](#) on page 3013. And, for more information about the self-funded pricing, see [Self-Funded Pricing](#) on page 2453.

The system enables you to create price items which can be used for pricing and billing. It means that pricing can be defined for the price item and charges can be created against it in the system. The system enables you to create the following type of price items:

- **Fees Based Price Items** - The fees based services would include services on which fees is charged to the customers either annually or at regular intervals (for example, for the administrative services offered to the self-funded customer, the admin fees will be charged). You can create fees based price items which can be used for pricing and billing in the system.

You need to associate a contract type with a price item. The system allows you to create a charge (i.e. billable charge) for a price item on an account when a contract of the contract type which is associated with the price item is already present on the account.

You can create price items which can be assigned to any price list except global price list or which can assigned to only global price lists. For more information about global price list, see [Price List](#) on page 844.

You can associate one or more parameters where the parameter usage is set to **Price Item** with a price item. These parameters can then be used for:

- Aggregating transactions which are mapped to the price item
- Defining multi parameter based pricing for the price item

If the parameter usage is set to **Aggregation** while associating a parameter with a price item, the parameter is only used for aggregating transactions which are mapped to the price item. However, if the parameter usage is set to **Pricing** while associating a parameter with a price item, the parameter is used for aggregating transactions as well as for defining multi parameter based pricing for the price item.

You can associate a price item to one or more divisions. In addition, you can do the following when a price item is associated to a division:

- Associate the Service Quantity Identifiers (SQIs) with the Price Item for the Division
- Define the Division-Specific Characteristics for the Price Item

Price Item (Used for Searching)

The **Price Item** screen allows you to search for a price item or price item bundle using various search criteria. It also allows you to create and copy a price item or price item bundle. It contains the following zone:

- [Search Price Item](#) on page 782

Through this screen, you can navigate to the following screens:

- [Price Item \(Used for Viewing\)](#) on page 826
- [Price Item Relationship](#)
- [Price Item Assignments](#)

Search Price Item



The **Search Price Item** zone allows you to search for a price item or price item bundle using various search criteria. It contains the following two sections:

- **Search Criteria** – The **Search Criteria** section contains the following fields:

Field Name	Field Description	Mandatory (Yes or No)
Search By	Used to indicate whether you want to search for a price item or price item bundle using the price item details. The valid value is: <ul style="list-style-type: none"> • Price Item Details 	Yes
	Note: By default, the Price Item Details option is selected.	
Price Item	Used to search a particular price item or price item bundle.	No
Description	Used to search price items or price item bundles with a particular description.	No
Division	Used to search price items or price item bundles which are associated with a particular division.	No
	Note: You can only view those divisions to which you have access in the Division list.	
Global Price List	Used to search price items or price item bundles which can be assigned to a global price list. The valid values are: <ul style="list-style-type: none"> • Yes • No 	No
Price Item Usage	Used to search price items or price item bundles which is available for pricing or pricing and billing. The valid values are: <ul style="list-style-type: none"> • Pricing • Pricing and Billing 	No
	Note: By default, the Pricing and Billing option is selected.	
Bundle	Used to indicate whether you want to search a price item bundle. The valid values are: <ul style="list-style-type: none"> • Yes • No 	No
Price Item Type	Used to search a particular type of price items or price item bundles. The valid values are: <ul style="list-style-type: none"> • Fees • Rate 	No
	Note: This field appears when the Pricing option is selected from the Price Item Usage list.	

Note: You must specify at least one search criterion while searching for a price item or price item bundle.

- **Search Results** – On clicking the **Search** button, the search results appear based on the specified search criteria. The **Search Results** section contains the following columns:

Column Name	Column Description
Price Item Information	Displays information about the price item or price item bundle.
	Note: It has a link. On clicking the link, the Price Item screen appears where you can view the details of the respective price item or price item bundle.
Bundle Type	<p>Indicates the type of the price item bundle. If the price item bundle is available for pricing and billing, the valid values are:</p> <ul style="list-style-type: none"> • Phantom • Ratio • Regular <p>However, if the price item bundle is available for pricing and its price item type is set to Fees, the valid value is:</p> <ul style="list-style-type: none"> • Regular
Price Item Type	<p>Indicates the type of the price item or price item bundle. The valid values are:</p> <ul style="list-style-type: none"> • Rate • Fees
Price Item Usage	<p>Indicates whether the price item or price item bundle is available for pricing or pricing and billing. The valid values are:</p> <ul style="list-style-type: none"> • Pricing • Pricing and Billing
Duplicate	<p>On clicking the Duplicate () icon, the Price Item screen appears where you can create a new price item or price item bundle using an existing price item or price item bundle.</p>
Price Item Assigned To	<p>On clicking the View () icon in the Price Item Assigned To column, the Price Item Assignments screen appears where you can view the persons, accounts, and active price lists to which the price item or price item bundle is assigned.</p>
Price Item Relationship	<p>On clicking the View () icon in the Price Item Relationship column, the Price Item Relationship screen appears where you can view the list of the price items and price item bundles associated with the parent price item or added to the price item bundle.</p>

Note: Pagination is used to display limited number of records in the **Search Results** section. You can use the navigation links, such as **Previous** and **Next** to navigate between pages.

Related Topics

For more information on...	See...
Price Item screen	Price Item (Used for Searching) on page 782
How to search for a price item or price item bundle	Searching for a Price Item or Price Item Bundle on page 785
How to view the details of a price item or price item bundle	Viewing the Price Item or Price Item Bundle Details on page 825
How to copy a price item or price item bundle	Copying a Price Item or Price Item Bundle on page 816
Price Item Assignments screen	Price Item Assignments
Price Item Relationship screen	Price Item Relationship

Searching for a Price Item or Price Item Bundle

Prerequisites

To search for a price item or price item bundle, you should have:

- Divisions defined in the application
- Price items or price item bundles associated with the division to which the user (i.e. who is performing this action) belongs

Procedure

To search for a price item or price item bundle:

1. Click the **Menu** link in the **Application** toolbar.
A list appears.
2. From the **Main** menu, select **Pricing Management** and then click **Price Item**.
A sub-menu appears.
3. Click the **Search** option from the **Price Item** sub-menu.
The **Price Item** screen appears.
4. Enter the search criteria in the **Search Price Item** zone depending on whether you want to search for a price item or price item bundle.

Note: ORMB search engine supports wildcard search, where you can substitute the percentage (%) symbol as a stand in for any word or letter in a search criteria. You can use the ‘%’ wildcard character in all input fields except the date and ID fields. The ‘%’ wildcard character is suffixed automatically at the end of the partial search criteria. Therefore, you may or may not specify the wildcard character at the end of the partial search criteria. However, you have to prefix the wildcard character manually wherever required.

5. Click **Search**.

A list of price items or price item bundles that meet the search criteria appears in the **Search Results** section.

Related Topics

For more information on...	See...
Price Item screen	Price Item (Used for Searching) on page 782
Search Price Item zone	Search Price Item on page 782

Defining a Price Item or Price Item Bundle

Prerequisites

To define a price item or price item bundle, you should have:

- Contract types, To Do types, and To Do roles defined in the application
- To Do roles associated with the required To Do type
- Value defined for the **Default Contract Type** option type in the **C1_PRICING** feature configuration

Procedure

To define a price item or price item bundle:

1. Click the **Menu** link in the **Application** toolbar.
A list appears.
2. From the **Main** menu, select **Pricing Management** and then click **Price Item**.

A sub-menu appears.

3. Click the **Add** option from the **Price Item** sub-menu.

The **Price Item** screen appears. It contains the following sections:

- **Main** - Used to specify basic details about the price item or price item bundle.
- **Parameters** - Used to associate a parameter with the price item or price item bundle. These associated parameters are then used for aggregating transactions and/or for defining the price item pricing.

Note:

The **Parameters** section appears in the **Price Item** screen when the **Multi Price Parameter** option type of the **C1_PPARM_FLG** feature configuration is set to **True**.

You cannot associate parameters to the ratio and phantom price item bundles. Therefore, while defining a ratio or phantom price item bundle, the **Parameters** section does not appear in the **Price Item** screen.

- **Divisions** - Used to associate the price item or price item bundle with one or more divisions. In addition, it enables you to:
 - Associate the service quantity identifiers (SQIs) with the price item or price item bundle for a division
 - Define the accrual type criteria of the price item or price item bundle for a division

Note: This step is not applicable for the health insurance business.

- Associate the price item or price item bundle with a hierarchy entity in an entity hierarchy relationship of a division

Note: This step is not applicable for the health insurance business.

- Define the cost of the price item or price item bundle for a division

Note: This step is not applicable for the health insurance business.

- Define the average price floor and ceil limits of the price item or price item bundle for a division

Note: This step is not applicable for the health insurance business.

- Define the negotiability floor and ceil values of the price item or price item bundle for a division

Note: This step is not applicable for the health insurance business.

- Define the division-specific characteristics for the price item or price item bundle
- **Price Item Characteristics** - Used to define characteristics (which are applicable across divisions) for the price item or price item bundle.

The **Main** section contains the following fields:

Field Name	Field Description	Mandatory (Yes or No)
Price Item	Used to specify the price item or price item bundle.	Yes
Description	Used to specify the description for the price item or price item bundle.	Yes
Price Item Usage	<p>Used to indicate whether the price item or price item bundle is available for pricing or pricing and billing. The valid values are:</p> <ul style="list-style-type: none"> Pricing - Used when you want to define pricing for the price item or price item bundle, but no charges should be created against it in the system. <p>Note: This option is not applicable for the health insurance business.</p> <ul style="list-style-type: none"> Pricing and Billing - Used when you want to define pricing and create charges for the price item or price item bundle in the system. <p>Note: By default, the Pricing and Billing option is selected.</p>	Yes

Field Name	Field Description	Mandatory (Yes or No)
Price Item Type	<p>Used to indicate the type of the price item or price item bundle. The valid values are:</p> <ul style="list-style-type: none"> • Rate - Used when you want to create a rate based price item or price item bundle. For example, savings, current, and loan interest services (i.e. price items) are rate based price items. <div style="border: 1px solid black; padding: 5px; margin: 5px 0;"> <p>Note: This option is not applicable for the health insurance business.</p> </div> <ul style="list-style-type: none"> • Fees - Used when you want to create a fee based price item or price item bundle. For example, debit credit service (i.e. price item) is a fee based price item. <div style="border: 1px solid black; padding: 5px; margin: 5px 0;"> <p>Note: This field appears when the Pricing option is selected from the Price Item Usage list. By default, the Fees option is selected. You cannot create a price item bundle when the Pricing option is selected from the Price Item Usage list and Rate option is selected from the Price Item Type list. The system automatically sets the price item type of those price items or price item bundles which are available for pricing and billing to Fees. Therefore, this field does not appear when the Pricing and Billing option is selected from the Price Item Usage list.</p> </div>	Yes
Bundle	<p>Used to indicate whether you want to create a price item bundle. The valid values are:</p> <ul style="list-style-type: none"> • Yes • No <div style="border: 1px solid black; padding: 5px; margin: 5px 0;"> <p>Note: By default, the No option is selected. This field is not applicable for the health insurance business.</p> </div>	Yes

Field Name	Field Description	Mandatory (Yes or No)
Bundle Type	<p>Used to indicate the type of the price item bundle. If the Pricing and Billing option is selected from the Price Item Usage list, the valid values are:</p> <ul style="list-style-type: none"> • <i>Regular Bundle</i> • <i>Phantom Bundle</i> • <i>Ratio Bundle</i> <p>However, if the Pricing option is selected from the Price Item Usage list and the Fees option is selected from the Price Item Type list, you can only define a regular price item bundle. Therefore, by default, the value is set to Regular.</p>	Yes (Conditional)
	<p>Note:</p> <p>This field appears when the Yes option is selected from the Bundle list.</p> <p>This field is enabled when the Pricing and Billing option is selected from the Price Item Usage list and the Yes option is selected from the Bundle list.</p> <p>You cannot define a price item bundle when the Pricing option is selected from the Price Item Usage list and Rate option is selected from the Price Item Type list.</p> <p>This field is not applicable for the health insurance business.</p>	<p>Note: This field is required when you are creating a price item bundle.</p>
Global Price List	<p>Used to indicate whether the price item or price item bundle can be assigned to a global price list. The valid values are:</p> <ul style="list-style-type: none"> • Yes • No <p>Note: By default, the No option is selected.</p>	Yes

Field Name	Field Description	Mandatory (Yes or No)
Contract Type	<p>Used to indicate the contract type that you want to associate with the price item or price item bundle.</p> <p>Note:</p> <p>This field appears when the Pricing and Billing option is selected from the Price Item Usage list.</p> <p>The Search (🔍) icon appears corresponding to the Contract Type field. On clicking the Search icon, the Contract Type Search window appears.</p>	Yes
Price Item Manager To Do Type	<p>Used to indicate the To Do type using which a To Do should be created when the deal creator or approver requests the price item manager (i.e. clicks the Send Price Items for Approval button) to approve the average price for the price item or price item bundle offered in a deal.</p> <p>Note:</p> <p>The Search (🔍) icon appears corresponding to the Price Item Manager To Do Type field. On clicking the Search icon, the To Do Type Search window appears.</p> <p>On specifying the To Do type, the description of the To Do type appears corresponding to the Price Item Manager To Do Type field.</p> <p>This field is not applicable for the health insurance business.</p>	No
Price Item Manager To Do Role	<p>Used to indicate that users with the specified To Do role can approve the average price for the price item or price item bundle offered in a deal. Note that the price item manager can approve the average price when it is within the average price floor and ceil limits defined for the To Do role.</p> <p>Note:</p> <p>The list appears when the price item manager To Do type is selected from the respective field. It includes only those To Do roles which are associated with the price item manager To Do type.</p> <p>This field is not applicable for the health insurance business.</p>	<p>Yes (Conditional)</p> <p>Note: This field is required when the price item manager To Do type is specified for the price item or price item bundle.</p>

Field Name	Field Description	Mandatory (Yes or No)
Average Price Floor and Ceil Type	<p>Used to indicate the manner in which you want to define the average price floor and ceil limits for the price item or price item bundle. The valid value is:</p> <ul style="list-style-type: none"> • Absolute Value Range - Used when you want to define the average price floor and ceil limits in the absolute values. For example, the average price for the price item or price item bundle should be between 10\$ to 15\$. • Spread Amount - Used when you want to define the average floor and ceil limits based on the spread amount. • Spread Percentage – Used when you want to define the average floor and ceil limits based on the spread percentage. 	Yes (Conditional)
	<p>Note:</p> <ul style="list-style-type: none"> • In case of Spread Amount and Spread Percentage options, the system calculates the average price of a price item and based on the average price and the spread amount or spread percentage, the average floor and ceil limits are derived. • This field is not applicable for the health insurance business. 	<p>Note: This field is required when you are defining the average price floor and ceil limits of the price item or price item bundle for a division.</p>
Sort Sequence	Used to specify the sequence in which the price item should appear in the price item hierarchy of the deal management module.	No

Field Name	Field Description	Mandatory (Yes or No)
Variable Price	Used to indicate whether the system inherits the pricing of the price item from the price list while orchestrating a deal in the deal management module.	No
	<p>Note:</p> <p>If the Variable Price option is selected, the pricing offered for a price item to an entity in the deal is overridden when the price list pricing is changed after orchestrating the deal in the system.</p> <p>However, if the Variable Price option is not selected, the pricing offered for a price item to an entity in the deal is not overridden when the price list pricing is changed in the system. This enables the relationship manager to create deals for an existing customers, accounts, and prospects where the pricing of the price items are fixed for a particular timeframe.</p>	

Tip: Alternatively, you can access the **Price Item** screen by clicking the **Add** button in the **Page Title** area of the **Price Item** screen.

4. Enter the required details in the **Main** section.
5. Associate the parameters with the price item or price item bundle, if required.

Note: For each predefined parameter which is associated with the price item or price item bundle, you can define a set of valid predefined parameter values for the price item or price item bundle, if required.

6. Associate the price item or price item bundle with the required divisions.
7. Associate the SQIs with the price item or price item bundle for the required divisions.
8. Define the accrual type criteria of the price item or price item bundle for the required divisions.

Note: This step is not applicable for the health insurance business.

9. Associate the price item or price item bundle with a hierarchy entity in an entity hierarchy relationship of the required divisions.

Note: This step is not applicable for the health insurance business.

10. Define the cost of the price item or price item bundle for the required divisions.

Note: This step is not applicable for the health insurance business.

11. Define the average price floor and ceil limits of the price item or price item bundle for the required divisions.

Note: This step is not applicable for the health insurance business.

12. Define the negotiability floor and ceil values of the price item or price item bundle for the required divisions.

Note: This step is not applicable for the health insurance business.

13. Define the division-specific characteristics for the price item or price item bundle. if required.

14. Define the characteristics for the price item or price item bundle, if required.

15. Click **Save**.

The price item is defined.

Note: While creating a price item or price item bundle which is available for pricing, the contract type specified in the **Default Contract Type** option type of the **C1_PRICING** feature configuration is automatically associated to the price item or price item bundle.

Related Topics

For more information on...	See...
Price Item screen	Price Item (Used for Searching) on page 782
How to associate a parameter with a price item or price item bundle	Associating a Parameter with a Price Item or Price Item Bundle on page 793
How to associate a price item or price item bundle with a division	Associating a Price Item or Price Item Bundle with a Division on page 798
How to associate an SQI with a price item or price item bundle for a division	Associating an SQI with a Price Item or Price Item Bundle for a Division on page 802
How to define the accrual type criteria of a price item or price item bundle for a division	Defining the Accrual Type Criteria of a Price Item or Price Item Bundle for a Division on page 805
How to associate a price item or price item bundle with a hierarchy entity in an entity hierarchy relationship of a division	Associating a Price Item or Price Item Bundle with a Hierarchy Entity in an Entity Hierarchy Relationship of a Division on page 807
How to define the cost of a price item or price item bundle for a division	Defining the Cost of a Price Item or Price Item Bundle for a Division on page 809
How to define the average price floor and ceil limits of a price item or price item bundle for a division	Defining the Average Price Floor and Ceil Values of a Price Item or Price Item Bundle for a Division on page 812
How to define the rate negotiability floor and ceil values of a price item or price item bundle for a division	Defining the Rate Negotiability Floor and Ceil Values of a Price Item or Price Item Bundle for a Division
How to define a division-specific characteristic for a price item or price item bundle	Defining a Division-Specific Characteristic for a Price Item or Price Item Bundle on page 803
How to define a characteristic for a price item or price item bundle	Defining a Characteristic for a Price Item or Price Item Bundle on page 815
How to set the C1_PRICING feature configuration	Setting the C1_PRICING Feature Configuration on page 3467

Associating a Parameter with a Price Item or Price Item Bundle

You can define multi parameter based pricing for a price item or price item bundle when the parameters using which you want to define the price item pricing are associated with the respective price item or price item bundle during the pricing date range. For example, a bank (from the financial services domain) may want to charge different price for the following price item depending on the return codes:

Service	Price Item	Parameter	Parameter Value	Price
SEPA Direct Debit Return	SEPADDR	Return Code (RTURNCD)	AC01	0.1\$
			AC04	0.2\$

Service	Price Item	Parameter	Parameter Value	Price
			AC06	0.3\$
			AG01	0.10\$

In such case, you need to first define a predefined parameter named Return Code where the parameter usage is set to **Price Item**). In the Return Code parameter, you must specify the above listed return codes (i.e. AC01, AC04, AC06, and AG01) as the predefined values. Then, in order to define multi parameter based pricing for the SEPADDR price item using the Return Code parameter, you must associate the Return Code parameter with the SEPADDR price item using the following specifications:

Parameter	Display Order	Mandatory (Yes or No)	Optional Priority
Return Code	10	Yes	-

Another example, a self-funded customer (from the health insurance domain) may be charged different claim based admin fees depending on the health coverage class and network type:

Service	Price Item	Health Coverage Class	Network Type	Fees
Claim Based Fees	CLBDFS	Medical	In	\$100
		Medical	Out	\$150
		Dental	In	\$50
		Dental	Out	\$75

In such case, you need to first define two predefined parameters named Health Coverage Class and Network Type where the parameter usage is set to **Price Item**). In the Health Coverage Class parameter, you must specify the above listed values (i.e. Medical and Dental)) as the predefined values. And, in the Network Type parameter, you must specify the above listed values (i.e. In and Out)) as the predefined values. Then, in order to define parameter based pricing for the CLBDFS price item using the Health Coverage Class and Network Type parameters, you must associate these parameters with the CLBDFS price item using the following specifications:

Parameter	Display Order	Mandatory (Yes or No)	Optional Priority
Health Coverage Class	10	Yes	-
Network Type	20	Yes	-

Prerequisites

To associate a parameter with a price item or price item bundle, you should have:

- Parameters defined in the application (where the parameter usage is set to **Price Item**)

Procedure

To associate a parameter with a price item or price item bundle:

1. Click the **Parameters** or **Show All** link in the **Section** pane when you are defining, editing, or copying a price item or price item bundle.

The **Parameters** section appears. It contains the following fields in a grid:

Field Name	Field Description	Mandatory (Yes or No)
Effective Start Date	Used to specify the date from when the parameter is associated with the price item or price item bundle.	Yes
Effective End Date	Used to specify the date till when the parameter is associated with the price item or price item bundle.	No
Parameter	<p>Used to indicate the parameter that you want to associate with the price item or price item bundle.</p> <p>Note:</p> <p>The Search (🔍) icon appears corresponding to the Parameter field. On clicking the Search icon, the Parameter Search window appears.</p> <p>In the Parameter Search window, the system allows you to search only those parameters where the parameter usage is set to Price Item.</p> <p>If you select a predefined parameter, the Add (➕) icon appears corresponding to the Parameter field. On clicking the Add icon, a grid appears where you can specify a list of predefined parameter values which are valid for the price item or price item bundle while defining its pricing. If you do not list any predefined parameter value in this grid, the system enables you to specify any predefined value of the parameter while defining the pricing for the price item or price item bundle.</p>	Yes
Business Label	Used to specify a business label for the parameter. If you specify the business label for a parameter, the business label appears throughout the application instead of the parameter name.	No
Display Order	Used to indicate the order in which the parameter and its value should appear in the pricing parameter information string across the application.	Yes
Parameter Usage	<p>Used to indicate whether you want to use the parameter for aggregation and/or for defining the price item pricing. The valid values are:</p> <ul style="list-style-type: none"> • Aggregation – Used when you want to use the parameter for aggregating transactions. • Pricing – Used when you want to use the parameter for aggregating transactions as well as for defining the price item pricing. 	Yes

Field Name	Field Description	Mandatory (Yes or No)
Mandatory	Used to indicate whether the parameter is mandatory while defining the price item pricing.	No
Priority	Used to indicate the priority in which optional parameters should be considered while determining best fit price for the price item or price item bundle.	Yes (Conditional)
	Note: This field is disabled when the Mandatory option is selected.	Note: This field is required when the Mandatory option is not selected.

Note:

The **Parameters** section appears in the **Price Item** screen when the **Multi Price Parameter** option type of the **C1_PPARM_FLG** feature configuration is set to **True**.

You cannot associate parameters to the ratio and phantom price item bundles. Therefore, while defining a ratio or phantom price item bundle, the **Parameters** section does not appear in the **Price Item** screen.

- Enter the required details in the **Parameters** section.
- If you want to associate more than one parameter with the price item or price item bundle, click the **Add (+)** icon and then repeat step 2.

Note:

However, if you want to remove a parameter from the price item or price item bundle, click the **Delete** (🗑️) icon corresponding to the parameter. You can edit the parameter details and remove a parameter from the price item or price item bundle when the parameter or any other parameter from the same date range is not yet used for aggregation or for defining the price item pricing.

You can add a parameter which is used for aggregation, whenever required. However, you can add a parameter which is used for pricing when any other parameter from the same date range is not yet used for aggregation or for defining the price item pricing.

- For each predefined parameter which is associated with the price item or price item bundle, you can define a set of valid predefined parameter values for the price item or price item bundle, if required.
- Click **Save**.

The parameters are associated with the price item or price item bundle.

Note: By default, the priority of all parameters which are mandatory is set to 0.

Related Topics

For more information on...	See...
How to define a price item or price item bundle	Defining a Price Item or Price Item Bundle on page 785
How to edit a price item or price item bundle	Editing a Price Item or Price Item Bundle on page 836
How to copy a price item or price item bundle	Copying a Price Item or Price Item Bundle on page 816
How to define the valid predefined parameter values for a price item or price item bundle	Defining the Valid Predefined Parameter Values for a Price Item or Price Item Bundle on page 797

Defining the Valid Predefined Parameter Values for a Price Item or Price Item Bundle

A predefined parameter may have hundreds of values defined in the system. But, there might be situations when only certain predefined parameter values are applicable for a price item or price item bundle while defining its pricing. In such case, you can define a set of valid predefined parameter values for a price item or price item bundle. For example, the Return Code parameter has the following predefined parameter values:

Parameter Value	Description
AC01	Account Identifier Incorrect (i.e. invalid IBAN)
AC04	Account Closed
AC06	Account Blocked
AG01	Direct Debit Forbidden for Regulatory Reasons
AG02	Operation/Transaction Code Incorrect
AM04	Insufficient Funds
AM05	Duplicate Collection
MD01	Unauthorized Transaction
MD06	Disputed Authorized Transaction

If only the MD01 and MD06 predefined parameter values are applicable for the SEPA Debit Refund (SEPADRF) price item, you can define MD01 and MD06 as the valid predefined parameter values for the SEPADRF price item. In such case, the system will allow you to define the pricing for the SEPADRF price item only using the MD01 or MD06 parameter value. However, if all the above listed predefined parameter values are applicable for the SEPA Direct Debit Return (SEPADDR) price item, you must not define the valid predefined parameter values for the SEPADDR price item. In such case, the system will allow you to define the pricing for the SEPADDR price item using any of the above listed parameter value.

Another example, the Health Coverage Class parameter has the following predefined parameter values:

Parameter Value	Description
MEDICAL	Medical
DENTAL	Dental
VISION	Vision

If only the MEDICAL and DENTAL predefined parameter values are applicable for the Claim Based Fees (CLBDFS) price item, you can define MEDICAL and DENTAL as the valid predefined parameter values for the CLBDFS price item. In such case, the system will allow you to define the pricing for the CLBDFS price item only using the MEDICAL or DENTAL parameter value. However, if all the above listed predefined parameter values are applicable for the Claim Based Fees (CLBDFS) price item, you must not define the valid predefined parameter values for the CLBDFS price item. In such case, the system will allow you to define the pricing for the CLBDFS price item using any of the above listed parameter value.

Prerequisites

To define the valid predefined parameter values for a price item or price item bundle, you should have:

- Predefined values defined for the parameter which is associated with the price item or price item bundle
- Price items or price item bundles associated with the division to which the user (i.e. who is performing this action) belongs

Procedure

To define the valid predefined parameter values for a price item or price item bundle:

1. Click the **Parameters** or **Show All** link in the **Section** pane when you are defining, editing, or copying a price item or price item bundle.

The **Parameters** section appears.

2. Click the **Add** () icon in the **Parameter** column corresponding to the predefined parameter which is associated with the price item or price item bundle.

The following field appears in a grid:

Field Name	Field Description	Mandatory (Yes or No)
Parameter Value	Used to indicate the predefined parameter value which you can use for the price item or price item bundle while defining the pricing.	Yes (Conditional)
	<p>Note:</p> <p>The Search () icon appears corresponding to the Parameter Value field. On clicking the Search icon, the Predefined Parameter Value Search window appears.</p> <p>On specifying the valid predefined parameter value for a price item or price item bundle, the description of the predefined parameter value appears corresponding to the Parameter Value field.</p>	<p>Note: This field is required when you are defining the valid predefined parameter values for the price item or price item bundle.</p>

3. Enter a predefined parameter value which is valid for the price item or price item bundle while defining its pricing.
4. If you want to define more than one valid predefined parameter value for the price item or price item bundle, click the **Add** () icon and then repeat step 3.

Note: However, if you want to remove a valid predefined parameter value from the price item or price item bundle, click the **Delete** () icon corresponding to the parameter value. You can remove a valid predefined parameter value from the price item or price item bundle when the parameter value is not yet used for defining the price item pricing.

5. Click **Save**.

The valid predefined parameter values are defined for the price item or price item bundle.

Related Topics

For more information on...	See...
How to associate a parameter with a price item or price item bundle	Associating a Parameter with a Price Item or Price Item Bundle on page 793

Associating a Price Item or Price Item Bundle with a Division

You can assign a price item or price item bundle to a person or account when the price item or price item bundle is associated with the division to which the person or account belongs. For example, if the SEPA Direct Debit Return (SEPADDR) and Stop Payment (STPPMT) price items are associated with the following divisions:

Price Item	Division
SEPA Direct Debit Return (SEPADDR)	001-AL
	002-CA
	003-FL
	004-IN
Stop Payment (STPPMT)	002-CA
	003-FL
	004-IN

In such case, you can assign the SEPADDR price item to any person or account which belongs to the 001-AL, 002-CA, 003-FL, or 004-IN division. However, you can assign the STPPMT price item to any person or account which belongs to the 002-CA, 003-FL, or 004-IN division.

Another example, if the Claim Based Fees (CLBDFS) price item is associated with the following divisions:

Price Item	Division
Claim Based Fees (CLBDFS)	002-CA
	003-FL
	004-IN

In such case, you can charge the CLBDFS price item to any person or account which belongs to the 002-CA, 003-FL, or 004-IN division.

Prerequisites

To associate a price item or price item bundle with a division, you should have:



- Divisions defined in the application
- Divisions associated with the access group to which the user (i.e. who is performing this action) belongs





Procedure

To associate a price item or price item bundle with a division:

1. Click the **Divisions** or **Show All** link in the **Section** pane when you are defining, editing, or copying a price item or price item bundle.

The **Divisions** section appears. It contains the following fields in a grid:

Field Name	Field Description	Mandatory (Yes or No)
SQIs	On clicking the Add  icon, you can associate an SQI with the price item or price item bundle for the division.	Not applicable
Division Characteristics	On clicking the Add  icon, you can define a division-specific characteristic for the price item or price item bundle.	Not applicable

Field Name	Field Description	Mandatory (Yes or No)
Accrual Type Criteria	On clicking the Add  icon, you can define the accrual type criteria of the price item or price item bundle for the division.	Not applicable
	Note: This feature is not applicable for the health insurance business.	
Entity Hierarchy	On clicking the Add  icon, you can associate the price item or price item bundle with a hierarchy entity of an entity hierarchy relationship for the division.	Not applicable
	Note: This feature is not applicable for the health insurance business.	
Costs	On clicking the Add  icon, you can define the cost of the price item or price item bundle for the division.	Not applicable
	Note: This feature is not applicable for the health insurance business.	
Average Price Floor and Ceil Limits	On clicking the Add  icon, you can define the average price floor and ceil limits of the price item or price item bundle for the division.	Not applicable
	Note: This feature is not applicable for the health insurance business.	
Negotiability	On clicking the Add  icon, you can define the negotiability floor and ceil limits of the price item or price item bundle for the division.	
	Note: This feature is not applicable for the health insurance business.	
Division	Used to indicate the division to which you want to associate the price item or price item bundle.	Yes (Conditional)
	Note: You can only view those divisions to which you have access in the Division list.	Note: This field is required while associating the price item or price item bundle with a division.

- Select the division from the respective field.
- If you want to associate the price item or price item bundle with more than one division, click the **Add**  icon and then repeat step 2.

Note: However, if you want to remove the price item or price item bundle from a division, click the **Delete**  icon corresponding to the division. You cannot remove the price item or price item bundle from a division when it is assigned to a person or account which belongs to the division.

4. Associate the SQIs with the price item or price item bundle for the required divisions.
5. Define the accrual type criteria of the price item or price item bundle for the required divisions.

Note: This step is not applicable for the health insurance business object.

6. Associate the price item or price item bundle with a hierarchy entity of an entity hierarchy relationship for the required divisions.

Note: This step is not applicable for the health insurance business object.

7. Define the cost of the price item or price item bundle for the required divisions.

Note: This step is not applicable for the health insurance business object.

8. Define the average price floor and ceil limits of the price item or price item bundle for the required divisions.

Note: This step is not applicable for the health insurance business object.

9. Define the rate negotiability floor and ceil limits of the price item or price item bundle for the required divisions.

Note: This step is not applicable for the health insurance business object.

10. Define the division-specific characteristics for the price item or price item bundle. if required.

11. Click **Save**.

The price item or price item bundle is associated with the divisions.

Tip: Alternatively, you can associate a price item or price item bundle with a division using the **Division** screen. For more information, see [Associating a Price Item or Price Item Bundle with a Division](#) on page 948.

Related Topics

For more information on...	See...
How to define a price item or price item bundle	Defining a Price Item or Price Item Bundle on page 785
How to edit a price item or price item bundle	Editing a Price Item or Price Item Bundle on page 836
How to copy a price item or price item bundle	Copying a Price Item or Price Item Bundle on page 816
How to associate an SQI with a price item or price item bundle for a division	Associating an SQI with a Price Item or Price Item Bundle for a Division on page 802
How to define the accrual type criteria of a price item or price item bundle for a division	Defining the Accrual Type Criteria of a Price Item or Price Item Bundle for a Division on page 805
How to associate a price item or price item bundle with a hierarchy entity of an entity hierarchy relationship for a division	Associating a Price Item or Price Item Bundle with a Hierarchy Entity in an Entity Hierarchy Relationship of a Division on page 807
How to define the cost of a price item or price item bundle for a division	Defining the Cost of a Price Item or Price Item Bundle for a Division on page 809
How to define the average price floor and ceil limits of a price item or price item bundle for a division	Defining the Average Price Floor and Ceil Values of a Price Item or Price Item Bundle for a Division on page 812
How to define a division-specific characteristic for a price item or price item bundle	Defining a Division-Specific Characteristic for a Price Item or Price Item Bundle on page 803

Associating an SQI with a Price Item or Price Item Bundle for a Division

In the transaction aggregation process, an SQI based billable charge is created for a price item or price item bundle (to which a transaction is mapped) when:

- The SQIs are associated with the price item or price item bundle for the division to which the account (i.e. for which the billable charge is created) belongs.
- The transaction aggregation rules are defined for such SQIs in the system.

Let us assume that the A1 account belongs to the 201-NJ division and the A2 account belongs to the 209-CA division. And, the Stop Payments (STPY) price item is associated with the following SQIs:

Price Item	Division	Service Quantity Identifiers (SQIs)
Stop Payments (STPY)	201-NJ	Number of Transactions (NBRTXN)
		Transaction Volume (TXNVOL)
		Transaction Amount (TXNAMT)
	209-CA	Number of Transactions (NBRTXN)
Transaction Amount (TXNAMT)		

Now, when an SQI based billable charge is created for the A1 account through the transaction aggregation process, the system calculates the following SQIs using the respective transaction aggregation rule:

- Number of Transactions (NBRTXN)
- Transaction Volume (TXNVOL)
- Transaction Amount (TXNAMT)

And, when an SQI based billable charge is created for the A2 account through the transaction aggregation process, the system calculates the following SQIs using the respective transaction aggregation rule:

- Number of Transactions (NBRTXN)
- Transaction Amount (TXNAMT)

Another example, you can calculate the enrollment based fees for a self-funded customer based on Per Subscriber Per Month or Per Member Per Month for the 201-NJ and 209-CA divisions. Therefore, you need to associate two SQIs — Subscriber Count and Member Count with the Enrollment Based Fees (ERBDFS) price item:

Price Item	Division	Service Quantity Identifiers (SQIs)
Enrollment Based Fees (ERBDFS)	201-NJ	Subscriber Count (SUBCNT)
		Member Count (MEMCNT)
	209-CA	Subscriber Count (SUBCNT)
		Member Count (MEMCNT)

Prerequisites

To associate an SQI with a price item or price item bundle for a division, you should have:

- Service Quantity Identifiers (SQIs) defined in the application

- Price items or price item bundles associated with the division to which the user (i.e. who is performing this action) belongs

Procedure

To associate an SQI with a price item or price item bundle for a division:

1. Click the **Divisions** or **Show All** link in the **Section** pane when you are defining, editing, or copying a price item or price item bundle.

The **Divisions** section appears.

2. Click the **Add** (⊕) icon in the **SQIs** column corresponding to the division for which you want to associate SQIs with the price item or price item bundle.

The following field appears in a grid:

Field Name	Field Description	Mandatory (Yes or No)
SQI	Used to indicate the SQI that you want to associate with the price item or price item bundle for the division.	Yes (Conditional)
	<p>Note:</p> <p>The Search (🔍) icon appears corresponding to the SQI field. On clicking the Search icon, the Service Quantity Identifier Search window appears.</p> <p>On specifying the SQI, the description of the SQI appears corresponding to the SQI field.</p>	<p>Note: This field is required while associating an SQI with the price item or price item bundle for the division.</p>

3. Enter the required details in the **SQIs** grid.
4. If you want to associate more than one SQI with the price item or price item bundle for the division, click the **Add** (⊕) icon and then repeat step 3.

Note: However, if you want to remove an SQI from the price item or price item bundle for the division, click the **Delete** (🗑) icon corresponding to the SQI. You cannot remove an SQI from the price item or price item bundle for the division when an SQI based billable charge is created using the SQI.

5. Click **Save**.

The SQIs are associated with the price item or price item bundle for the division.

Related Topics

For more information on...	See...
How to define a price item or price item bundle	Defining a Price Item or Price Item Bundle on page 785
How to edit a price item or price item bundle	Editing a Price Item or Price Item Bundle on page 836
How to copy a price item or price item bundle	Copying a Price Item or Price Item Bundle on page 816
How to associate a price item or price item bundle with a division	Associating a Price Item or Price Item Bundle with a Division on page 798

Defining a Division-Specific Characteristic for a Price Item or Price Item Bundle

Prerequisites

To define a division-specific characteristic for a price item or price item bundle, you should have:

- Characteristic types defined in the application (where the characteristic entity is set to **Division/Price Item Combination**)
- Price items or price item bundles associated with the division to which the user (i.e. who is performing this action) belongs

Procedure

To define a division-specific characteristic for a price item or price item bundle:

1. Click the **Divisions** or **Show All** link in the **Section** pane when you are defining, editing, or copying a price item or price item bundle.

The **Divisions** section appears.

2. Click the **Add** (+) icon in the **Division Characteristics** column corresponding to the division for which you want to define division-specific price item or price item bundle characteristics.

The following fields appear in the grid:

Field Name	Field Description	Mandatory (Yes or No)
Effective Date	Used to specify the date from when the price item or price item bundle characteristic is effective for the division.	Yes (Conditional)
		Note: This field is required while defining a division-specific characteristic for the price item or price item bundle.
Characteristic Type	Used to indicate the characteristic type. Note: The list includes only those characteristic types where the characteristic entity is set to Division/Price Item Combination .	Yes (Conditional)
		Note: This field is required while defining a division-specific characteristic for the price item or price item bundle.
Characteristic Value	Used to specify the value for the characteristic type. Note: If you select a predefined characteristic type, the Search (Q) icon appears corresponding to the Characteristic Value field. On clicking the Search icon, the Predefined Characteristic Search window appears. On specifying the value for a predefined characteristic type, the description of the characteristic value appears corresponding to the Characteristic Value field.	Yes (Conditional)
		Note: This field is required while defining a division-specific characteristic for the price item or price item bundle.

3. Enter the required details in the **Divisions** section.
4. If you want to define more than one division-specific characteristic for the price item or price item bundle, click the **Add** (+) icon and then repeat step 3.

Note: However, if you want to remove a division-specific characteristic from the price item or price item bundle, click the **Delete** (🗑️) icon corresponding to the characteristic.

5. Click **Save**.

The division-specific characteristics are defined for the price item or price item bundle.

Related Topics

For more information on...	See...
How to define a price item or price item bundle	Defining a Price Item or Price Item Bundle on page 785
How to edit a price item or price item bundle	Editing a Price Item or Price Item Bundle on page 836
How to copy a price item or price item bundle	Copying a Price Item or Price Item Bundle on page 816
How to associate a price item or price item bundle with a division	Associating a Price Item or Price Item Bundle with a Division on page 798

Defining the Accrual Type Criteria of a Price Item or Price Item Bundle for a Division

Note: This topic is not applicable for the health insurance business.

The accrual type criteria of a price item or price item bundle is referred when the accrual is calculated for an account using an accrual type where the **Price Item Accrual Criteria Required** option is selected. The system behaves in the following manner when the **Price Item Accrual Criteria Required** option is selected in the accrual type:

If the accrual type criteria of a price item or price item bundle is set to...	Then...
Actual	<p>The system considers the billable charges of the price item for accrual when the following conditions are met:</p> <ul style="list-style-type: none"> The price item is not excluded in the accrual type. The accrual is calculated for an account using the accrual type where the accrual criteria is set to Actual.
Historical	<p>The system considers the billable charges of the price item for accrual when the following conditions are met:</p> <ul style="list-style-type: none"> The price item is not excluded in the accrual type. The accrual is calculated for an account using the accrual type where the accrual criteria is set to Historical.
Not Applicable	<p>The system considers the billable charges of the price item for accrual when the following conditions are met:</p> <ul style="list-style-type: none"> The price item is not excluded in the accrual type The accrual is calculated for an account using the accrual type where the accrual criteria is set to Actual or Historical.

The system enables you to define accrual type criteria of a price item or price item bundle for each division. For example, you can maintain different accrual type criteria of the Stop Payments (STPY) price item for each division as shown below:

Price Item	Division	Accrual Type Criteria
Stop Payments (STPY)	201-NJ	Actual
	209-CA	Historical
	210-FL	Not Applicable
	215-OX	Actual
	220-AL	Historical
	223-NJ	Not Applicable

Prerequisites

To define the accrual type criteria of a price item or price item bundle for a division, you should have:

- Price items or price item bundles associated with the division to which the user (i.e. who is performing this action) belongs

Procedure

To define the accrual type criteria of a price item or price item bundle for a division:

1. Click the **Divisions** or **Show All** link in the **Section** pane when you are defining, editing, or copying a price item or price item bundle.

The **Divisions** section appears.

2. Click the **Add**  icon in the **Accrual Type Criteria** column corresponding to the division for which you want to define accrual type criteria of the price item or price item bundle.

The following field appears in a grid:

Field Name	Field Description	Mandatory (Yes or No)
Accrual Type Criteria	Used to indicate whether the billable charges of the price item should be considered for accrual depending on the accrual criteria specified in the accrual type. The valid values are: <ul style="list-style-type: none"> • Actual - Used when you want the system to consider billable charges of the price item for accrual when the accrual criteria in the accrual type is set to Actual. • Historical - Used when you want the system to consider billable charges of the price item for accrual when the accrual criteria in the accrual type is set to Historical. • Not Applicable - Used when you want the system to consider billable charges of the price item for accrual when the accrual criteria in the accrual type is set to Actual or Historical. 	Yes (Conditional)
	Note: By default, the Not Applicable option is selected.	Note: This field is required while defining the accrual type criteria of the price item or price item bundle for the division.

3. Select the accrual type criteria from the respective field.
4. Click **Save**.

The accrual type criteria of the price item or price item bundle is defined for the division.

Related Topics

For more information on...	See...
How to define a price item or price item bundle	Defining a Price Item or Price Item Bundle on page 785
How to edit a price item or price item bundle	Editing a Price Item or Price Item Bundle on page 836
How to copy a price item or price item bundle	Copying a Price Item or Price Item Bundle on page 816
How to associate a price item or price item bundle with a division	Associating a Price Item or Price Item Bundle with a Division on page 798

Associating a Price Item or Price Item Bundle with a Hierarchy Entity in an Entity Hierarchy Relationship of a Division

Note: This topic is not applicable for the health insurance business.

Once you design the structure of an entity hierarchy relationship, you can associate a price item or price item bundle with a hierarchy entity at any level in the entity hierarchy relationship. You can associate a price item or price item bundle with a hierarchy entity only from the **Price Item** screen. The system enables you to define division-specific hierarchy for a price item or price item bundle. Therefore, while associating a price item or price item bundle with a hierarchy entity, you can select a hierarchy entity from any entity hierarchy relationship which is created for the division. However, the system checks whether the association date range is within the entity hierarchy relationship date range.

For example, you can associate the ACH Transfer (ACHTRN) price item with the Payments hierarchy entity in the Cash Management entity hierarchy relationship as shown below:

```
Cash Management
  Payments
    ACH Transfer
```

Associating a price item or price item bundle with a hierarchy entity does not have any impact on the billing module. At present, the price item hierarchy is only displayed in the Deal Modelling and Simulation module.

Prerequisites

To associate a price item or price item bundle with a hierarchy entity in an entity hierarchy relationship of a division, you should have:

- Entity hierarchy relationships defined for the required divisions
- Hierarchy entities included at the required levels in the entity hierarchy relationship
- Price items or price item bundles associated with the division to which the user (i.e. who is performing this action) belongs

Procedure

To associate a price item or price item bundle with a hierarchy entity in an entity hierarchy relationship of a division:

1. Click the **Divisions** or **Show All** link in the **Section** pane when you are defining, editing, or copying a price item or price item bundle.

The **Divisions** section appears.

2. Click the **Add**  icon in the **Entity Hierarchy** column corresponding to the division for which you want to define price item or price item bundle hierarchy.

The following fields appear in a grid:

Field Name	Field Description	Mandatory (Yes or No)
Hierarchy	Used to indicate the entity hierarchy relationship in which you want to include the price item or price item bundle.	Yes (Conditional)
	Note: The Search  icon appears corresponding to the Hierarchy field. On clicking the Search icon, the Hierarchy Search window appears.	Note: This field is required while associating the price item or price item bundle with a hierarchy entity in an entity hierarchy relationship of the division.
Parent Entity	Used to indicate the hierarchy entity to which you want to associate the price item or price item bundle.	Yes (Conditional)
	Note: The list appears when the entity hierarchy relationship is specified in the Hierarchy field. It contains the hierarchy entities which are included at the root and subsequent levels in the entity hierarchy relationship.	Note: This field is required while associating the price item or price item bundle with a hierarchy entity in an entity hierarchy relationship of the division.

Field Name	Field Description	Mandatory (Yes or No)
Start Date	Used to specify the date from when the price item or price item bundle is associated with the hierarchy entity in the entity hierarchy relationship.	Yes (Conditional)
	Note: The start date cannot be later than the end date. The start date cannot be earlier than the entity hierarchy relationship start date.	Note: This field is required while associating the price item or price item bundle with a hierarchy entity in an entity hierarchy relationship of the division.
End Date	Used to specify the date till when the price item or price item bundle is associated with the hierarchy entity in the entity hierarchy relationship.	No
	Note: The end date cannot be earlier than the start date. The end date cannot be later than the entity hierarchy relationship end date.	

- Enter the required details in the **Entity Hierarchy** grid.
- If you want to associate the price item or price item bundle to more the one hierarchy entity in the same or different entity hierarchy relationship, click the **Add (+)** icon and then repeat step 3.

Note:

You cannot associate the price item or price item bundle to multiple hierarchy entities in the same or different entity hierarchy relationship for the same or overlapping date range.

However, if you want to disassociate the price item or price item bundle from a hierarchy entity of an entity hierarchy relationship, click the **Delete (X)** icon corresponding to the hierarchy and parent entity combination.

- Click **Save**.

The price item or price item bundle is associated with a hierarchy entity in an entity hierarchy relationship of the division.

Related Topics

For more information on...	See...
How to define a price item or price item bundle	Defining a Price Item or Price Item Bundle on page 785
How to edit a price item or price item bundle	Editing a Price Item or Price Item Bundle on page 836
How to copy a price item or price item bundle	Copying a Price Item or Price Item Bundle on page 816
How to associate a price item or price item bundle with a division	Associating a Price Item or Price Item Bundle with a Division on page 798

Defining the Cost of a Price Item or Price Item Bundle for a Division

Note: This topic is not applicable for the health insurance business.

Oracle Revenue Management and Billing enables you to maintain the different types of fixed and variable costs of a price item or price item bundle for each division. The system uses the fixed and variable cost information while calculating the cost of a price item or price item bundle in a deal. It considers the cost which is defined for the division to which the account or person belongs. It derives the fixed and/or variable cost which is effective on the deal start date.

The system enables you to maintain the following types of costs in different currencies:

- Additional Fixed Cost
- Additional Variable Cost
- Fixed Third Party Cost
- Fixed Internal Cost
- Variable Internal Cost
- Variable Third Party Cost

While calculating the cost of a price item or price item bundle in a deal, the system converts the cost in the deal currency when the cost currency is different from the deal currency. As the name implies, the fixed cost is an expense that does not change with the increase or decrease in the price item volume or commitments. Therefore, the total fixed cost is equal to the sum of fixed cost which is effective on the deal start date for the division. However, the variable cost is an expense that change with the increase or decrease in the price item volume or commitments. Therefore, the total variable cost is equal to the sum of multiplication of variable cost (which is effective on the deal start date for the division) and price item volume or commitments.

Let us understand this with the help of an example:

Price Item	Division	Cost Type	Cost Amount
PI1	201-NJ	Fixed Third Party Cost	\$5
		Fixed Internal Cost	\$3
		Additional Fixed Cost	\$1
		Variable Third Party Cost	\$0.1
		Variable Internal Cost	\$0.65
		Additional Variable Cost	\$0.5

If a deal is created for a person who belongs to the 201-NJ division and if the PI1 price item is assigned to the person in the deal and if the original volume and proposed commitment of the PI1 price item in the deal is set to 100 and 200, respectively, the system calculates the cost of the PI1 price item in the following manner:

Original Cost	
Total Fixed Cost	$\$5 + \$3 + \$1 = \9
Total Variable Cost	$(100 * \$0.1) + (100 * \$0.65) + (100 * \$0.5) = \$10 + \$65 + \$50 = \$125$
Total Cost	$\$9 + \$125 = \$134$
Proposed Cost	
Total Fixed Cost	$\$5 + \$3 + \$1 = \9

Total Variable Cost	$(200 * \$0.1) + (200 * \$0.65) + (200 * \$0.5) = \$20 + \$130 + \$100 = \$250$
Total Cost	$\$9 + \$250 = \$259$

Here, the assumption is the deal and cost currency is same (i.e. USD). The system then uses the total original and proposed costs for calculating the original and proposed profitability of the deal.

Prerequisites

To define the cost of a price item or price item bundle for a division, you should have:

- Currencies defined in the application
- Price items or price item bundles associated with the division to which the user (i.e. who is performing this action) belongs

Procedure

To define the cost of a price item or price item bundle for a division:

1. Click the **Divisions** or **Show All** link in the **Section** pane when you are defining, editing, or copying a price item or price item bundle.

The **Divisions** section appears.

2. Click the **Add** (⊕) icon in the **Costs** column corresponding to the division for which you want to define the costs of the price item or price item bundle.

The following fields appear in a grid:

Field Name	Field Description	Mandatory (Yes or No)
Effective Date	Used to specify the date from when the cost of the price item or price item bundle is effective for the division.	Yes (Conditional) Note: This field is required while defining the cost of the price item or price item bundle for the division.
Cost Type	Used to indicate the type of cost incurred in the division for the price item or price item bundle. The valid values are: <ul style="list-style-type: none"> • Additional Fixed Cost • Additional Variable Cost • Fixed Third Party Cost • Fixed Internal Cost • Variable Internal Cost • Variable Third Party Cost 	Yes (Conditional) Note: This field is required while defining the cost of the price item or price item bundle for the division.
Cost Value	Used to specify the cost amount.	Yes (Conditional) Note: This field is required while defining the cost of the price item or price item bundle for the division.

Field Name	Field Description	Mandatory (Yes or No)
Cost Currency	Used to specify the currency in which you want to define the cost. The system does currency conversion when the cost currency is different from the deal currency.	Yes (Conditional)
	Note: The list includes only those currencies which are already defined in the system.	Note: This field is required while defining the cost of the price item or price item bundle for the division.

- Enter the required details in the **Costs** grid.
- If you want to define more than one cost of the price item or price item bundle for the division, click the **Add (+)** icon and then repeat step 3.

Note: However, if you want to remove the cost of the price item or price item bundle from the division, click the **Delete (🗑)** icon corresponding to the cost.

- Click **Save**.

The cost of the price item or price item bundle is defined for the division.

Related Topics

For more information on...	See...
How to define a price item or price item bundle	Defining a Price Item or Price Item Bundle on page 785
How to edit a price item or price item bundle	Editing a Price Item or Price Item Bundle on page 836
How to copy a price item or price item bundle	Copying a Price Item or Price Item Bundle on page 816
How to associate a price item or price item bundle with a division	Associating a Price Item or Price Item Bundle with a Division on page 798

Defining the Average Price Floor and Ceil Values of a Price Item or Price Item Bundle for a Division

Note: This topic is not applicable for the health insurance business.

Oracle Revenue Management and Billing enables you to define the average price floor and ceil limits of a price item or price item bundle for each division. Before you define the average price floor and ceil limits, you need to specify the floor and ceiling type for the price item or price item bundle. At present, the system supports the following floor and ceiling types for a price item or price item bundle:

- Absolute Value Range

Once the floor and ceiling type of a price item or price item bundle is set to **Absolute Value Range**, you can define the average price floor and ceil limits of the price item or price item bundle for the required divisions. The system enables you to define different average price floor and ceil limits for different To Do roles. The system uses the average price floor and ceil limits while approving the average price of the price item or price item bundle in a deal. The deal creator or an approver at any level in the division or deal approval hierarchy can approve the average price of a price item or price item bundle when the average price is within the floor and ceil limits of the To Do role to which the deal creator or approver belongs. For example, if the average price of the P1 price item in a deal is \$25 and the floor and ceil limits of the deal creator's To Do role is set to \$10-\$15, then the deal creator cannot approve the average price of the P1 price item in the deal.

If the average price floor and ceil limits is not defined for the deal creator's or approver's To Do role, the status of the price item or price item bundle in the deal is changed to **Error**. If the average price floor and ceil limits is defined for the deal creator's or approver's To Do role, but the average price of the price item or price item bundle is not within the floor and ceil limits, the status of the price item or price item bundle in the deal is changed to **Pending for Approval**. However, if the average price floor and ceil limits is defined for the deal creator's or approver's To Do role and the

average price of the price item or price item bundle is within the floor and ceil limits, the status of the price item or price item bundle in the deal is changed to **Approved**.

Here, you can also define the average price floor and ceil limits for the price item manager's To Do role. Note that the price item manager can approve the average price of the price item or price item bundle in a deal when the average price of the price item or price item bundle is within the floor and ceil limits of the price item manager's To Do role.

- Spread Amount

Once the average price floor and ceil type of a price item or price item bundle is set to **Spread Amount**, the system calculates the average price floor and ceil limits based on the average price and spread amount. The system calculates the average price of the price item or price item bundle. The system searches for the eligible price list in the price assignments assigned to the To Do roles. If a flat pricing is defined in the price assignment, then the system sets the average price to the flat rate. However, if a tiered pricing is defined in the price assignment, the system calculates the average price using the following formula:

Average Price = Price Item Revenue/Price Item Commitments

The system then considers the spread amount specified for the relationship manager's To Do role in the price item. Using the spread amount and average price, the system calculates the average price floor and ceil limit values. The deal creator or an approver at any level in the division or deal approval hierarchy can approve the average price of a price item or price item bundle when the average price is within the floor and ceil limits of the To Do role to which the deal creator or approver belongs. For example, if the spread amount set by you is 10 and the system calculated average price of the P1 price item in a deal is \$25 then the system sets the floor and ceil limits of the deal creator's To Do role to \$15-\$35. In this case the deal creator can approve the average price of the P1 price item in the deal.

The system then checks whether the average price of the price item in the deal is within the derived average price floor and ceil limits. If so, the system changes the status of the price item to **Approved**. However, if the average price of the price item in the deal is not within the derived average price floor and ceil limits, the status of the price item remains as **Pending for Approval**.

- Spread Percentage

Once the average price floor and ceil type of a price item is set to the **Spread Percentage**, the system calculates the average price floor and ceil limits based on the average price and spread percentage. The system calculates the average price of the price item or price item bundle. The system searches for the eligible price list in the price assignments assigned to the To Do roles. If a flat pricing is defined in the price assignment, then the system sets the average price to the flat rate. However, if a tiered pricing is defined in the price assignment, the system calculates the average price using the following formula:

Average Price = Price Item Revenue/Price Item Commitments

The system then considers the spread percentage specified for the relationship manager's To Do role in the price item. Using the spread percentage and average price, the system calculates the average price floor and ceil values. The deal creator or an approver at any level in the division or approver system then checks whether the average price of the price item in the deal is within the derived average price floor and ceil limits of the To Do role to which the deal creator or approver belongs. For example, if the spread percentage set by you is 10 and the system calculated average price of the P1 price item in a deal is \$50 then the system sets the floor and ceil limits of the deal creator's To Do role to \$45-\$55. In this case the deal creator can approve the average price of the P1 price item in the deal.

The system then checks whether the average price of the price item in the deal is within the derived average price floor and ceil limits. If so, the system changes the status of the price item to **Approved**. However, if the average price of the price item in the deal is not within the derived average price floor and ceil limits, the status of the price item remains as **Pending for Approval**.

Prerequisites

To define the average price floor and ceil limits of a price item or price item bundle for a division, you should have:

- To Do roles and currencies defined in the application
- Price items or price item bundles associated with the division to which the user (i.e. who is performing this action) belongs

Procedure

To define the average price floor and ceil limits of a price item or price item bundle for a division:

1. Click the **Divisions** or **Show All** link in the **Section** pane when you are defining, editing, or copying a price item or price item bundle.

The **Divisions** section appears.

2. Click the **Add**  icon in the **Average Price Floor and Ceil Limits** column corresponding to the division for which you want to define the average price floor and ceil limits of the price item or price item bundle.

The following fields appear in a grid:

Field Name	Field Description	Mandatory (Yes or No)
To Do Role	Used to indicate that users with the specified To Do role can approve the average price of the price item or price item bundle in a deal when it is within the specified floor and ceil limits.	Yes (Conditional)
	<p>Note:</p> <p>The Search  icon appears corresponding to the To Do Role field. On clicking the Search icon, the To Do Role Search window appears.</p> <p>On specifying the To Do role, the description of the To Do role appears corresponding to the To Do Role field.</p>	<p>Note: This field is required while defining the average price floor and ceil limits of the price item or price item bundle for the division.</p>
Floor Value	Used to specify the floor (i.e. lower) limit for the To Do role. The users who belong to the To Do role cannot approve the average price of the price item or price item bundle when it is below the floor limit.	Yes (Conditional)
	<p>Note: The floor value cannot be greater than the ceil value.</p>	<p>Note: This field is required while defining the average price floor and ceil limits of the price item or price item bundle for the division.</p>
Ceil Value	Used to specify the ceil (i.e. upper) limit for the To Do role. The users who belong to the To Do role cannot approve the average price of the price item or price item bundle when it is above the ceil limit.	Yes (Conditional)
	<p>Note: The ceil value cannot be lower than the floor value.</p>	<p>Note: This field is required while defining the average price floor and ceil limits of the price item or price item bundle for the division.</p>
Spread Amount	Used to specify the spread amount specified while defining a price item or price item bundle or assigned to a To Do role.	Yes (Conditional)
	<p>Note: This column appears when you select the Spread Amount option from the Average Price Floor and Ceil Type list for a price item or price item bundle.</p>	<p>Note: This field is required while defining the average price floor and ceil limits of the price item or price item bundle for the division.</p>

Field Name	Field Description	Mandatory (Yes or No)
Spread Percentage	Used to specify the spread percentage specified while defining a price item or price item bundle or assigned to a To Do role.	Yes (Conditional)
	Note: This column appears only when you select the Spread Percentage option from the Average Price Floor and Ceil Type list for a price item or price item bundle.	Note: This field is required while defining the average price floor and ceil limits of the price item or price item bundle for the division.
Floor and Ceil Currency	Used to indicate the currency in which you want to define the floor and ceil limits. The system does the currency conversion when the pricing currency is different from the floor and ceil currency.	Yes (Conditional)
	Note: The list includes only those currencies which are already defined in the system.	Note: This field is required while defining the average price floor and ceil limits of the price item or price item bundle for the division.

- Enter the required details in the **Average Price Floor and Ceil Limits** grid.
- If you want to define the average price floor and ceil limits for more than one To Do role, click the **Add (+)** icon and then repeat step 3.

Note: However, if you want to remove the average price floor and ceil limits of a To Do role from the division, click the **Delete** (🗑️) icon corresponding to the To Do role.

- Click **Save**.

The average price floor and ceil limits of the price item or price item bundle are defined for the division.

Related Topics

For more information on...	See...
How to define a price item or price item bundle	Defining a Price Item or Price Item Bundle on page 785
How to edit a price item or price item bundle	Editing a Price Item or Price Item Bundle on page 836
How to copy a price item or price item bundle	Copying a Price Item or Price Item Bundle on page 816
How to associate a price item or price item bundle with a division	Associating a Price Item or Price Item Bundle with a Division on page 798

Defining a Characteristic for a Price Item or Price Item Bundle

Prerequisites

To define a characteristic for a price item or price item bundle, you should have:

- Characteristic types defined in the application (where the characteristic entity is set to **Price Item**)

Procedure

To define a characteristic for a price item or price item bundle:

- Click the **Price Item Characteristics** or **Show All** link in the **Section** pane when you are defining, editing, or copying a price item or price item bundle.

The **Price Item Characteristics** section appears. It contains the following fields in a grid:

Field Name	Field Description	Mandatory (Yes or No)
Effective Date	Used to specify the date from when the characteristic is effective for the price item or price item bundle.	Yes (Conditional)
		Note: This field is required while defining a characteristic for the price item or price item bundle.
Characteristic Type	Used to indicate the characteristic type. Note: The list includes only those characteristic types where the characteristic entity is set to Price Item .	Yes (Conditional)
		Note: This field is required while defining a characteristic for the price item or price item bundle.
Characteristic Value	Used to specify the value for the characteristic type. Note: If you select a predefined characteristic type, the Search (🔍) icon appears corresponding to the Characteristic Value field. On clicking the Search icon, the Predefined Characteristic Search window appears. On specifying the value for a predefined characteristic type, the description of the characteristic value appears corresponding to the Characteristic Value field.	Yes (Conditional)
		Note: This field is required while defining a characteristic for the price item or price item bundle.

- Enter the required details in the **Price Item Characteristics** section.
- If you want to define more than one characteristic for the price item or price item bundle, click the **Add** (+) icon and then repeat step 2.

Note: However, if you want to remove a characteristic from the price item or price item bundle, click the **Delete** (🗑️) icon corresponding to the characteristic.

- Click **Save**.

The characteristics are defined for the price item or price item bundle.

Related Topics

For more information on...	See...
How to define a price item or price item bundle	Defining a Price Item or Price Item Bundle on page 785
How to edit a price item or price item bundle	Editing a Price Item or Price Item Bundle on page 836
How to copy a price item or price item bundle	Copying a Price Item or Price Item Bundle on page 816

Copying a Price Item or Price Item Bundle

Instead of creating a price item or price item bundle from scratch, you can create a new price item or price item bundle using an existing price item or price item bundle. This is possible through copying a price item or price item bundle.

On copying a price item or price item bundle, the details including the following are copied to the new price item or price item bundle:

- Parameters and Divisions associated with the price item or price item bundle
- SQIs associated with the price item or price item bundle for the divisions
- Division-specific characteristics of the price item or price item bundle
- Accrual type criteria of the price item or price item bundle for the divisions
- Hierarchy entity to which the price item or price item bundle is associated in the divisions
- Cost of the price item or price item bundle for the divisions
- Average price floor and ceil limits of the price item or price item bundle for the divisions
- Negotiability floor and ceil values of the price item or price item bundle for the required divisions

You can then edit the details, if required.

Prerequisites

To copy a price item or price item bundle, you should have:

- Price item or price item bundle (whose copy you want to create) defined in the application
- Price item or price item bundle (whose copy you want to create) associated with the division to which the user (i.e. who is performing this action) belongs
- Contract types, To Do types, and To Do roles defined in the application
- To Do roles associated with the required To Do type
- Value defined for the **Default Contract Type** option type in the **C1_PRICING** feature configuration

Procedure

To copy a price item or price item bundle:

1. Search for the price item or price item bundle in the **Price Item** screen.
2. In the **Search Results** section, click the **Duplicate**  icon in the **Duplicate** column corresponding to the price item or price item bundle whose copy you want to create.

The **Price Item** screen appears. It contains the following sections:

- **Main** - Used to specify basic details about the price item or price item bundle.
- **Parameters** - Used to associate a parameter with the price item or price item bundle. These associated parameters are then used for aggregating transactions and/or for defining the price item pricing.

Note:

The **Parameters** section appears in the **Price Item** screen when the **Multi Price Parameter** option type of the **C1_PPARM_FLG** feature configuration is set to **True**.

You cannot associate parameters to the ratio and phantom price item bundles. Therefore, while defining a ratio or phantom price item bundle, the **Parameters** section does not appear in the **Price Item** screen.

- **Divisions** - Used to associate the price item or price item bundle with one or more divisions. In addition, it enables you to:
 - Associate the service quantity identifiers (SQIs) with the price item or price item bundle for a division
 - Define the accrual type criteria of the price item or price item bundle for a division

Note: This step is not applicable for the health insurance business.

- Associate the price item or price item bundle with a hierarchy entity in an entity hierarchy relationship of a division

Note: This step is not applicable for the health insurance business.

- Define the cost of the price item or price item bundle for a division

Note: This step is not applicable for the health insurance business.

- Define the average price floor and ceil limits of the price item or price item bundle for a division

Note: This step is not applicable for the health insurance business.

- Define the negotiability floor and ceil values of the price item or price item bundle for a division

Note: This step is not applicable for the health insurance business.

- Define the division-specific characteristics for the price item or price item bundle

- **Price Item Characteristics** - Used to define characteristics (which are applicable across divisions) for the price item or price item bundle.

The **Main** section contains the following fields:

Field Name	Field Description	Mandatory (Yes or No)
Price Item	Used to specify the price item or price item bundle.	Yes
Description	Used to specify the description for the price item or price item bundle.	Yes
Price Item Usage	<p>Used to indicate whether the price item or price item bundle is available for pricing or pricing and billing. The valid values are:</p> <ul style="list-style-type: none"> • Pricing - Used when you want to define pricing for the price item or price item bundle, but no charges should be created against it in the system. <p>Note: This option is not applicable for the health insurance business.</p> <ul style="list-style-type: none"> • Pricing and Billing - Used when you want to define pricing and create charges for the price item or price item bundle in the system. 	Yes

Field Name	Field Description	Mandatory (Yes or No)
Price Item Type	<p>Used to indicate the type of the price item or price item bundle. The valid values are:</p> <ul style="list-style-type: none"> • Rate - Used when you want to create a rate based price item or price item bundle. For example, savings, current, and loan interest services (i.e. price items) are rate based price items. <div style="border: 1px solid black; padding: 2px; margin: 5px 0;"> <p>Note: This option is not applicable for the health insurance business.</p> </div> <ul style="list-style-type: none"> • Fees - Used when you want to create a fee based price item or price item bundle. For example, debit credit service (i.e. price item) is a fee based price item. <div style="border: 1px solid black; padding: 2px; margin: 5px 0;"> <p>Note: This field appears when the Pricing option is selected from the Price Item Usage list. You cannot create a price item bundle when the Pricing option is selected from the Price Item Usage list and Rate option is selected from the Price Item Type list. The system automatically sets the price item type of those price items or price item bundles which are available for pricing and billing to Fees. Therefore, this field does not appear when the Pricing and Billing option is selected from the Price Item Usage list.</p> </div>	Yes
Bundle	<p>Used to indicate whether you want to create a price item bundle. The valid values are:</p> <ul style="list-style-type: none"> • Yes • No <div style="border: 1px solid black; padding: 2px; margin: 5px 0;"> <p>Note: This field is not applicable for the health insurance business.</p> </div>	Yes

Field Name	Field Description	Mandatory (Yes or No)
Bundle Type	<p>Used to indicate the type of the price item bundle. If the Pricing and Billing option is selected from the Price Item Usage list, the valid values are:</p> <ul style="list-style-type: none"> • <i>Regular Bundle</i> • <i>Phantom Bundle</i> • <i>Ratio Bundle</i> <p>However, if the Pricing option is selected from the Price Item Usage list and the Fees option is selected from the Price Item Type list, you can only define a regular price item bundle. Therefore, by default, the value is set to Regular.</p>	Yes (Conditional)
	<p>Note:</p> <p>This field appears when the Yes option is selected from the Bundle list.</p> <p>This field is enabled when the Pricing and Billing option is selected from the Price Item Usage list and the Yes option is selected from the Bundle list.</p> <p>You cannot define a price item bundle when the Pricing option is selected from the Price Item Usage list and Rate option is selected from the Price Item Type list.</p> <p>This field is not applicable for the health insurance business.</p>	<p>Note: This field is required when you are creating a price item bundle.</p>
Global Price List	<p>Used to indicate whether the price item or price item bundle can be assigned to a global price list. The valid values are:</p> <ul style="list-style-type: none"> • Yes • No 	Yes
Contract Type	<p>Used to indicate the contract type that you want to associate with the price item or price item bundle.</p>	Yes
	<p>Note:</p> <p>This field appears when the Pricing and Billing option is selected from the Price Item Usage list.</p> <p>The Search (🔍) icon appears corresponding to the Contract Type field. On clicking the Search icon, the Contract Type Search window appears.</p>	

Field Name	Field Description	Mandatory (Yes or No)
Price Item Manager To Do Type	<p>Used to indicate the To Do type using which a To Do should be created when the deal creator or approver requests the price item manager (i.e. clicks the Send Price Items for Approval button) to approve the average price for the price item or price item bundle offered in a deal.</p> <p>Note:</p> <p>The Search (🔍) icon appears corresponding to the Price Item Manager To Do Type field. On clicking the Search icon, the To Do Type Search window appears.</p> <p>On specifying the To Do type, the description of the To Do type appears corresponding to the Price Item Manager To Do Type field.</p> <p>This field is not applicable for the health insurance business.</p>	No
Price Item Manager To Do Role	<p>Used to indicate that users with the specified To Do role can approve the average price for the price item or price item bundle offered in a deal. Note that the price item manager can approve the average price when it is within the average price floor and ceil limits defined for the To Do role.</p> <p>Note:</p> <p>The list appears when the price item manager To Do type is selected from the respective field. It includes only those To Do roles which are associated with the price item manager To Do type.</p> <p>This field is not applicable for the health insurance business.</p>	<p>Yes (Conditional)</p> <p>Note: This field is required when the price item manager To Do type is specified for the price item or price item bundle.</p>

Field Name	Field Description	Mandatory (Yes or No)
Floor and Ceiling Type	<p>Used to indicate the manner in which you want to define the average price floor and ceil limits for the price item or price item bundle. The valid value is:</p> <ul style="list-style-type: none"> • Absolute Value Range - Used when you want to define the average price floor and ceil limits in the absolute values. For example, the average price for the price item or price item bundle should be between 10\$ to 15\$. • Spread Amount - Used when you want to define the average floor and ceil limits based on the spread amount. • Spread Percentage – Used when you want to define the average floor and ceil limits based on the spread percentage. 	Yes (Conditional)
	<p>Note:</p> <ul style="list-style-type: none"> • In case of Spread Amount and Spread Percentage options, the system calculates the average price of a price item and based on the average price and the spread amount or spread percentage, the average floor and ceil limits are derived. • This field is not applicable for the health insurance business. 	<p>Note: This field is required when you are defining the average price floor and ceil limits of the price item or price item bundle for a division.</p>
Sort Sequence	Used to specify the sequence in which the price item should appear in the price item hierarchy of the deal management module.	No

Field Name	Field Description	Mandatory (Yes or No)
Variable Price	Used to indicate whether the system inherits the pricing of the price item from the price list while orchestrating a deal in the deal management module. Note: If the Variable Price option is selected, the pricing offered for a price item to an entity in the deal is overridden when the price list pricing is changed after orchestrating the deal in the system. However, if the Variable Price option is not selected, the pricing offered for a price item to an entity in the deal is not overridden when the price list pricing is changed in the system. This enables the relationship manager to create deals for an existing customers, accounts, and prospects where the pricing of the price items are fixed for a particular timeframe.	No

3. Enter the required details in the **Main** section.
4. Associate, edit, or disassociate parameters from the price item or price item bundle, if required.

Note: For each predefined parameter which is associated with the price item or price item bundle, you can define a set of valid predefined parameter values for the price item or price item bundle, if required.
5. Associate or disassociate the price item or price item bundle from the required divisions.
6. Associate or disassociate the SQIs from the price item or price item bundle for the required divisions.
7. Define, edit, or remove the accrual type criteria of the price item or price item bundle from the required divisions.

Note: This step is not applicable for the health insurance business.
8. Associate or disassociate the price item or price item bundle from a hierarchy entity in an entity hierarchy relationship of the required divisions.

Note: This step is not applicable for the health insurance business.
9. Define, edit, or remove the cost of the price item or price item bundle from the required divisions.

Note: This step is not applicable for the health insurance business.
10. Define, edit, or remove the average price floor and ceil limits of the price item or price item bundle from the required divisions.

Note: This step is not applicable for the health insurance business.
11. Define, edit or remove the negotiability floor and ceil values of the price item or price item bundle for the required divisions.

Note: This step is not applicable for the health insurance business.
12. Define, edit, or remove the division-specific characteristics from the price item or price item bundle. if required.

13. Define, edit, or remove characteristics of the price item or price item bundle, if required.

14. Click **Save**.

The new price item is defined.

Note:

While creating a price item or price item bundle which is available for pricing, the contract type specified in the **Default Contract Type** option type of the **C1_PRICING** feature configuration is automatically associated to the price item or price item bundle.

The system allows you to add a price item to the new price item bundle when:

- Price item and price item bundle (whose copy you are creating) are associated to the same contract type.
- Price item is associated with the division to which the price item bundle (whose copy you are creating) is associated.
- Another price item bundle with the same price item, relationship type, and date range combination does not exist in the system.

Related Topics

For more information on...	See...
How to search for a price item or price item bundle	Searching for a Price Item or Price Item Bundle on page 785
How to associate a parameter with a price item or price item bundle	Associating a Parameter with a Price Item or Price Item Bundle on page 793
How to associate a price item or price item bundle with a division	Associating a Price Item or Price Item Bundle with a Division on page 798
How to associate an SQI with a price item or price item bundle for a division	Associating an SQI with a Price Item or Price Item Bundle for a Division on page 802
How to define the accrual type criteria of a price item or price item bundle for a division	Defining the Accrual Type Criteria of a Price Item or Price Item Bundle for a Division on page 805
How to associate a price item or price item bundle with a hierarchy entity in an entity hierarchy relationship of a division	Associating a Price Item or Price Item Bundle with a Hierarchy Entity in an Entity Hierarchy Relationship of a Division on page 807
How to define the cost of a price item or price item bundle for a division	Defining the Cost of a Price Item or Price Item Bundle for a Division on page 809
How to define the average price floor and ceil limits of a price item or price item bundle for a division	Defining the Average Price Floor and Ceil Values of a Price Item or Price Item Bundle for a Division on page 812
How to define the rate negotiability floor and ceil values of a price item or a price item bundle for a division	Defining the Rate Negotiability Floor and Ceil Values of a Price Item or Price Item Bundle for a Division
How to define a division-specific characteristic for a price item or price item bundle	Defining a Division-Specific Characteristic for a Price Item or Price Item Bundle on page 803
How to define a characteristic for a price item or price item bundle	Defining a Characteristic for a Price Item or Price Item Bundle on page 815
How to set the C1_PRICING feature configuration	Setting the C1_PRICING Feature Configuration on page 3467

Viewing the Price Item or Price Item Bundle Details

Procedure

To view the details of a price item or price item bundle:

1. Search for the price item or price item bundle in the **Price Item** screen.
2. In the **Search Results** section, click the link in the **Price Item Information** column corresponding to the price item or price item bundle whose details you want to view.

The **Price Item** screen appears. It contains the following zones:

- [Price Item](#) on page 826
 - [Parameters](#) on page 828
 - [Predefined Parameter Values for Price Item](#) on page 829
 - [Divisions](#) on page 829
 - [Division-Specific SQIs for Price Item](#) on page 830
 - [Division-Specific Characteristics for Price Item](#) on page 831
 - [Division-Specific Accrual Type Criteria for Price Item](#) on page 831
 - [Division-Specific Hierarchy for Price Item](#) on page 832
 - [Division-Specific Cost for Price Item](#) on page 833
 - [Division-Specific Average Price Floor and Ceil Values for Price Item](#) on page 833
 - [Division-Specific Negotiability Floor and Ceil Values for a Price Item](#)
 - [Price Item Relationship](#) on page 834
3. View the basic details and characteristics of the price item or price item bundle in the **Price Item** zone.
 4. View the parameters associated with the price item or price item bundle in the **Parameters** zone.
 5. View the valid predefined parameter values of the price item or price item bundle in the **Predefined Parameter Values for Price Item** zone.
 6. View the divisions to which the price item or price item bundle is associated in the **Divisions** zone.
 7. View the SQIs associated with the price item or price item bundle for a division in the **Division-Specific SQIs for Price Item** zone.
 8. View the division-specific characteristics of the price item or price item bundle in the **Division-Specific Characteristics for Price Item** zone.
 9. View the accrual type criteria of the price item or price item bundle for a division in the **Division-Specific Accrual Type Criteria for Price Item** zone.

Note: This step is not applicable for the health insurance business.

10. View the hierarchy entity to which the price item or price item bundle is associated in a division in the **Division-Specific Hierarchy for Price Item** zone.

Note: This step is not applicable for the health insurance business.

11. View the cost of the price item or price item bundle for a division in the **Division-Specific Cost for Price Item** zone.

Note: This step is not applicable for the health insurance business.

12. View the average price floor and ceil limits of the price item or price item bundle for a division in the **Division-Specific Floor and Ceil Values for Price Item** zone.

Note: This step is not applicable for the health insurance business.

13. View the negotiability floor and ceil values of the price item or price item bundle for a division in the **Division-Specific Negotiability Floor and Ceil Values for Price Item** zone.

Note: This step is not applicable for the health insurance business.

14. View the price items or price item bundles related to the parent price item or price item bundle in the **Price Item Relationship** zone.

Note: This step is not applicable for the health insurance business.

Related Topics

For more information on...	See...
How to search for a price item or price item bundle	Searching for a Price Item or Price Item Bundle on page 785
Price Item screen	Price Item (Used for Viewing) on page 826

Price Item (Used for Viewing)

The **Price Item** screen allows you to view the details of the price item or price item bundle. It also allows you to edit the details of the price item or price item bundle. It contains the following zones:

- [Price Item](#) on page 826
- [Parameters](#) on page 828
- [Predefined Parameter Values for Price Item](#) on page 829
- [Divisions](#) on page 829
- [Division-Specific SQIs for Price Item](#) on page 830
- [Division-Specific Characteristics for Price Item](#) on page 831
- [Division-Specific Accrual Type Criteria for Price Item](#) on page 831
- [Division-Specific Hierarchy for Price Item](#) on page 832
- [Division-Specific Negotiability Floor and Ceil Values for a Price Item](#)
- [Division-Specific Cost for Price Item](#) on page 833
- [Division-Specific Average Price Floor and Ceil Values for Price Item](#) on page 833
- [Price Item Relationship](#) on page 834

Price Item

The **Price Item** zone displays the details of the price item or price item bundle. It contains the following sections:

- **Main** – Displays basic information about the price item or price item bundle. It contains the following fields:

Field Name	Field Description
Price Item	Displays the price item or price item bundle.
Description	Displays the description of the price item or price item bundle.

Field Name	Field Description
Price Item Usage	<p>Indicates whether the price item or price item bundle is available for pricing or pricing and billing. The valid values are:</p> <ul style="list-style-type: none"> • Pricing • Pricing and Billing
Price Item Type	<p>Indicates the type of the price item or price item bundle. The valid values are:</p> <ul style="list-style-type: none"> • Rate • Fees <p>Note: This field appears when the Pricing option is selected from the Price Item Usage list.</p>
Bundle	<p>Indicates whether the price item is a bundle. The valid values are:</p> <ul style="list-style-type: none"> • Yes • No
Bundle Type	<p>Indicates the type of the price item bundle. The valid values are:</p> <ul style="list-style-type: none"> • Phantom • Ratio • Regular <p>Note: This field appears when the Yes option is selected from the Bundle list.</p>
Global Price List	<p>Indicates whether the price item or price item bundle can be assigned to a global price list. The valid values are:</p> <ul style="list-style-type: none"> • Yes • No
Contract Type	<p>Displays the contract type to which the price item or price item bundle is associated.</p>
Price Item Manager To Do Type	<p>Indicates the To Do type using which a To Do should be created when the deal creator or approver requests the price item manager (i.e. clicks the Send Price Items for Approval button) to approve the average price for the price item or price item bundle offered in a deal.</p> <p>Note: It has a link. On clicking the link, the To Do Type screen appears where you can view the details of the respective To Do type.</p>
Price Item Manager To Do Role	<p>Indicates that users with the specified To Do role can approve the average price of the price item or price item bundle offered in a deal. Note that the price item manager can approve the average price when it is within the average price floor and ceil limits of the To Do role.</p> <p>Note: It has a link. On clicking the link, the To Do Role screen appears where you can view the details of the respective To Do role.</p>

Field Name	Field Description
Average Price Floor and Ceil Type	Indicates the manner in which you want to define the average price floor and ceil limits of the price item or price item bundle. The valid values are: <ul style="list-style-type: none"> • Absolute Value Range • Spread Amount • Spread Percentage

- **Price Item Characteristics** – Lists the characteristics of the price item or price item bundle. It contains the following columns:

Column Name	Column Description
Effective Date	Displays the date from when the characteristic is effective for the price item or price item bundle.
Characteristic Type	Indicates the characteristic type.
Characteristic Value	Displays the value of the characteristic type.

- **Record Actions** – This section contains the following button:

Button Name	Button Description
Edit	Used to edit the details of the price item or price item bundle.

- **Record Information** – This section contains the following field:

Field Name	Field Description
Business Object	Indicates the business object using which the price item or price item bundle is created. In addition, a context menu appears corresponding to this field which helps in navigating to other screens in the application. <p>Note: It has a link. On clicking the link, the Business Object screen appears where you can view the details of the respective business object.</p>

Related Topics

For more information on...	See...
Price Item screen	Price Item (Used for Viewing) on page 826
How to edit a price item or price item bundle	Editing a Price Item or Price Item Bundle on page 836

Parameters

The **Parameters** zone lists the parameters which are associated with the price item or price item bundle. It contains the following columns:

Column Name	Column Description
Effective Start Date	Displays the date from when the parameter is associated with the price item or price item bundle.
Effective End Date	Displays the date till when the parameter is associated with the price item or price item bundle.

Column Name	Column Description
Parameter	Indicates the parameter which is associated with the price item or price item bundle.
	Note: It has a link. On clicking the link, the Parameter screen appears where you can view the details of the respective parameter.
Business Label	Displays the business label of the parameter.
Display Order	Indicates the order in which the parameter and its value should appear in the pricing parameter information string across the application.
Parameter Usage	Indicates whether you can use the parameter for aggregation and/or for defining the price item pricing. The valid values are: <ul style="list-style-type: none"> • Aggregation • Pricing
Mandatory	Indicates whether the parameter is mandatory while defining the price item pricing.
Priority	Indicates the priority in which optional parameters should be considered while determining best fit price for the price item or price item bundle.

On clicking the **Broadcast** () icon corresponding to a parameter, the **Predefined Parameter Values for Price Item** zone appears where you can view the valid predefined parameter values of the price item or price item bundle.

Related Topics

For more information on...	See...
Price Item screen	Price Item (Used for Viewing) on page 826
Predefined Parameter Values for Price Item zone	Predefined Parameter Values for Price Item on page 829

Predefined Parameter Values for Price Item

The **Predefined Parameter Values for Price Item** zone lists the predefined parameter values which are valid for the price item or price item bundle. It contains the following columns:

Column Name	Column Description
Parameter Value	Displays the predefined parameter value.
Description	Displays the description of the predefined parameter value.

By default, the **Predefined Parameter Values for Price Item** zone does not appear in the **Price Item** screen. It appears when you click the **Broadcast** () icon corresponding to a parameter in the **Parameters** zone.

Related Topics

For more information on...	See...
Price Item screen	Price Item (Used for Viewing) on page 826
Parameters zone	Parameters on page 828

Divisions

The **Divisions** zone lists the divisions to which the price item or price item bundle is associated. It contains the following column:

Column Name	Column Description
Division	Indicates the division to which the price item or price item bundle is associated. Note: It has a link. On clicking the link, the Division screen appears where you can view the details of the respective division.

On clicking the **Broadcast** (📡) icon corresponding to a division, the **Division-Specific SQIs for Price Item, Division-Specific Characteristics for Price Item, Division-Specific Accrual Type Criteria for Price Item, Division-Specific Hierarchy for Price Item, Division-Specific Cost for Price Item, Division-Specific Average Price Floor and Ceil Values for Price Item** and **Division-Specific Negotiability Floor and Ceil Values for Price Item** zones appear.

You can filter the list using the **Division** field available in the **Filter** area. By default, the **Filter** area is hidden. You can view the **Filter** area by clicking the **Filters** (🔍) icon in the upper right corner of this zone.

Related Topics

For more information on...	See...
Price Item screen	Price Item (Used for Viewing) on page 826
Division-Specific SQIs for Price Item zone	Division-Specific SQIs for Price Item on page 830
Division-Specific Characteristics for Price Item zone	Division-Specific Characteristics for Price Item on page 831
Division-Specific Accrual Type Criteria for Price Item zone	Division-Specific Accrual Type Criteria for Price Item on page 831
Division-Specific Hierarchy for Price Item zone	Division-Specific Hierarchy for Price Item on page 832
Division-Specific Cost for Price Item zone	Division-Specific Cost for Price Item on page 833
Division-Specific Negotiability Floor and Ceil Values for Price Item	Division-Specific Negotiability Floor and Ceil Values for a Price Item
Division-Specific Floor and Ceil Values for Price Item zone	Division-Specific Average Price Floor and Ceil Values for Price Item on page 833

Division-Specific SQIs for Price Item

The **Division-Specific SQIs for Price Item** zone lists the SQIs associated with the price item or price item bundle for the division. It contains the following column:

Column Name	Column Description
SQI	Indicates the SQI associated with the price item or price item bundle for the division. Note: It has a link. On clicking the link, the Service Quantity Identifier screen appears where you can view the details of the respective SQI.

By default, the **Division-Specific SQIs for Price Item** zone does not appear in the **Price Item** screen. It appears when you click the **Broadcast** (📡) icon corresponding to a division in the **Divisions** zone.

Related Topics

For more information on...	See...
Price Item screen	Price Item (Used for Viewing) on page 826

For more information on...	See...
Divisions zone	Divisions on page 829

Division-Specific Characteristics for Price Item

The **Division-Specific Characteristics for Price Item** zone lists the characteristics of the price item or price item bundle which are defined for the division. It contains the following columns:

Column Name	Column Description
Effective Date	Displays the date from when the price item or price item bundle characteristic is effective for the division.
Characteristic Type	Indicates the characteristic type. Note: It has a link. On clicking the link, the Characteristic Type screen appears where you can view the details of the respective characteristic type.
Characteristic Value	Displays the value of the characteristic type.

By default, the **Division-Specific Characteristics for Price Item** zone does not appear in the **Price Item** screen. It appears when you click the **Broadcast** (📡) icon corresponding to a division in the **Divisions** zone.

Related Topics

For more information on...	See...
Price Item screen	Price Item (Used for Viewing) on page 826
Divisions zone	Divisions on page 829

Division-Specific Accrual Type Criteria for Price Item

Note: This topic is not applicable for the health insurance business.

The **Division-Specific Accrual Type Criteria for Price Item** zone lists the accrual type criteria of the price item or price item bundle which is defined for the division. It contains the following column:

Column Name	Column Description
Accrual Type Criteria	Indicates whether the billable charges of the price item should be considered for accrual depending on the accrual criteria specified in the accrual type. The valid values are: <ul style="list-style-type: none"> Actual Historical Not Applicable

By default, the **Division-Specific Accrual Type Criteria for Price Item** zone does not appear in the **Price Item** screen. It appears when you click the **Broadcast** (📡) icon corresponding to a division in the **Divisions** zone.

Related Topics

For more information on...	See...
Price Item screen	Price Item (Used for Viewing) on page 826
Divisions zone	Divisions on page 829

Division-Specific Hierarchy for Price Item

Note: This topic is not applicable for the health insurance business.

The **Division-Specific Hierarchy for Price Item** zone lists the following in a tree structure:

- Information string of the hierarchy entity at the first level in the entity hierarchy relationship
- Information string of the hierarchy entities at the subsequent levels in the entity hierarchy relationship
- Information string of the price items which are associated with the hierarchy entities at different levels in the entity hierarchy relationship

For example,

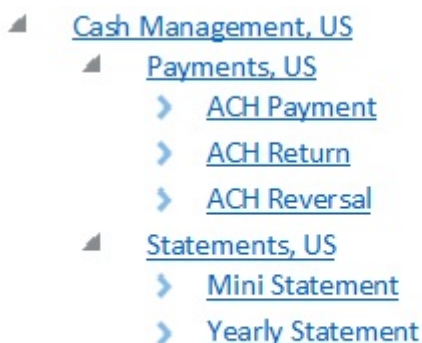

Here, the Cash Management, US (at the first level), Payments, US (at the second level), and Statements, US (at the second level) are the hierarchy entity nodes. And, the ACH Payment, ACH Return, ACH Reversal, Mini Statement, and Yearly Statement are the price item nodes.

Each node in the tree has a link. If you click the link on the hierarchy entity node, the **Hierarchy Entity** screen appears where you can view the details of the respective hierarchy entity. However, if you click the link on the price item node, the **Price Item** screen appears where you can view the details of the respective price item.

It contains the following field:

Field Name	Field Description
Hierarchy	Displays the entity hierarchy relationship code.

In addition, it contains the following buttons:

Button Name	Button Description
Expand All	Used to expand all nodes at once in the entity hierarchy relationship.
Collapse All	Used to collapse all nodes at once in the entity hierarchy relationship.

By default, the **Division-Specific Hierarchy for Price Item** zone does not appear in the **Price Item** screen. It appears when you click the **Broadcast** (📡) icon corresponding to a division in the **Divisions** zone.

Related Topics

For more information on...	See...
Price Item screen	Price Item (Used for Viewing) on page 826

For more information on...	See...
Divisions zone	Divisions on page 829

Division-Specific Cost for Price Item

Note: This topic is not applicable for the health insurance business.

The **Division-Specific Cost for Price Item** zone lists the costs of the price item or price item bundle which is defined for the division. It contains the following columns:

Column Name	Column Description
Effective Date	Displays the date from when the cost of the price item or price item bundle is effective for the division.
Cost Type	Indicates the type of cost incurred in the division for the price item or price item bundle. The valid values are: <ul style="list-style-type: none"> • Additional Fixed Cost • Additional Variable Cost • Fixed Third Party Cost • Fixed Internal Cost • Variable Internal Cost • Variable Third Party Cost
Cost Value	Displays the cost amount.
Cost Currency	Indicates the currency in which the cost is specified. <p>Note: It has a link. On clicking the link, the Currency screen appears where you can view the details of the respective currency.</p>

By default, the **Division-Specific Cost for Price Item** zone does not appear in the **Price Item** screen. It appears when you click the **Broadcast** (📡) icon corresponding to a division in the **Divisions** zone.

Related Topics

For more information on...	See...
Price Item screen	Price Item (Used for Viewing) on page 826
Divisions zone	Divisions on page 829

Division-Specific Average Price Floor and Ceil Values for Price Item

Note: This topic is not applicable for the health insurance business.

The **Division-Specific Average Price Floor and Ceil Values for Price Item** zone lists the average price floor and ceil limits of the price item or price item bundle which are defined for the division. It contains the following columns:

Column Name	Column Description
To Do Role	Indicates that users with the specified To Do role can approve the average price of the price item or price item bundle in a deal when it is within the specified floor and ceil limits. Note: It has a link. On clicking the link, the To Do Role screen appears where you can view the details of the respective To Do role.
Floor Value	Displays the floor (i.e. lower) limit of the To Do role. Note: This column appears when the Absolute Value Range option is selected for the Average Price Floor and Ceil Limits list for a price item or price item bundle.
Ceil Value	Displays the ceil (i.e. upper) limit of the To Do role. Note: This column appears when the Absolute Value Range option is selected for the Average Price Floor and Ceil Type list for a price item or price item bundle.
Floor and Ceil Currency	Indicates the currency in which the average price floor and ceil limits are defined for the price item or price item bundle. Note: It has a link. On clicking the link, the Currency screen appears where you can view the details of the respective currency.
Spread Amount	Indicates the spread amount specified while defining a price item or price item bundle or assigned to a To Do role. Note: This column appears when the Spread Amount option is selected for the Average Price Floor and Ceil Type list for a price item or price item bundle.
Spread Percentage	Indicates the spread percentage specified while defining a price item or price item bundle or assigned to a To Do role. Note: This column appears when the Spread Percentage option is selected for the Average Price Floor and Ceil Type list for a price item or price item bundle.

By default, the **Division-Specific Average Price Floor and Ceil Values for Price Item** zone does not appear in the **Price Item** screen. It appears when you click the **Broadcast** () icon corresponding to a division in the **Divisions** zone.

Related Topics

For more information on...	See...
Price Item screen	Price Item (Used for Viewing) on page 826
Divisions zone	Divisions on page 829

Price Item Relationship

Note: This topic is not applicable for the health insurance business.

The **Price Item Relationship** zone lists the price items or price item bundles which are associated with the parent price item or added to the price item bundle. It contains the following columns:

Column Name	Column Description
Price Item Information	Displays information about the price item or price item bundle.
	Note: It has a link. On clicking the link, the Price Item screen appears where you can view the details of the respective price item or price item bundle.
Effective Start Date	Displays the date from when the price item or price item bundle is associated with the parent price item or added to the price item bundle.
Effective End Date	Displays the date till when the price item or price item bundle is associated with the parent price item or added to the price item bundle.
Relationship Type	Indicates how the price item or price item bundle is related to the parent price item or price item bundle. The valid values are: <ul style="list-style-type: none"> • Bundle • Child Price Item • Custom • Denominator • Numerator • Other • Price Item • Product Group • Service • Service Group
Bundle Type	Indicates the type of the price item bundle. The valid values are: <ul style="list-style-type: none"> • Phantom • Ratio • Regular
	Note: The data appears in this column when the associated price item is a bundle.
Price Item Parameters	Displays the parameters and their values based on which you want to determine pricing for the price item or price item bundle.

Note: Pagination is used to display limited number of records in this zone. You can use the navigation links, such as **Previous** and **Next** to navigate between pages.

You can filter the list using various search criteria (such as, **Price Item**, **Description**, **Effective Start Date**, and **Relationship Type**) available in the **Filter** area. By default, the **Filter** area is hidden. You can view the **Filter** area by clicking the **Filters** (🔍) icon in the upper right corner of this zone.

You can change the layout of this zone. For more information on how to change the layout, see [Changing the Layout](#) on page 3414.

You can associate or disassociate a price item or price item bundle from a parent price item and add or remove a price item or price item bundle from a price item bundle by clicking the **Add/Edit** link in the upper right corner of this zone.

Related Topics

For more information on...	See...
Price Item screen	Price Item (Used for Viewing) on page 826
How to associate a price item or price item bundle with a parent price item	Associating a Price Item or Price Item Bundle with a Parent Price Item
How to add a price item or price item bundle to a price item bundle	Adding a Price Item or Price Item Bundle to a Price Item Bundle
How to disassociate a price item or price item bundle from a parent price item	Disassociating a Price Item or Price Item Bundle from a Parent Price Item
How to remove a price item or price item bundle from a price item bundle	Removing a Price Item or Price Item Bundle from a Price Item Bundle

Editing a Price Item or Price Item Bundle

Prerequisites

To edit a price item or price item bundle, you should have:

- Contract types, To Do types, and To Do roles defined in the application
- To Do roles associated with the required To Do type
- Value defined for the **Default Contract Type** option type in the **C1_PRICING** feature configuration

Procedure

To edit a price item or price item bundle:

1. Search for the price item or price item bundle in the **Price Item** screen.
2. In the **Search Results** section, click the link in the **Price Item Information** column corresponding to the price item or price item bundle whose details you want to edit.

The **Price Item** screen appears.

3. Click the **Edit** button in the **Price Item** zone.

The **Price Item** screen appears. It contains the following sections:

- **Main** - Used to specify basic details about the price item or price item bundle.
- **Parameters** - Used to associate a parameter with the price item or price item bundle. These associated parameters are then used for aggregating transactions and/or for defining the price item pricing.

Note:

The **Parameters** section appears in the **Price Item** screen when the **Multi Price Parameter** option type of the **C1_PPARM_FLG** feature configuration is set to **True**.

You cannot associate parameters to the ratio and phantom price item bundles. Therefore, while defining a ratio or phantom price item bundle, the **Parameters** section does not appear in the **Price Item** screen.

- **Divisions** - Used to associate the price item or price item bundle with one or more divisions. In addition, it enables you to:
 - Associate the service quantity identifiers (SQIs) with the price item or price item bundle for a division
 - Define the accrual type criteria of the price item or price item bundle for a division

Note: This step is not applicable for the health insurance business.

- Associate the price item or price item bundle with a hierarchy entity in an entity hierarchy relationship of a division

Note: This step is not applicable for the health insurance business.

- Define the cost of the price item or price item bundle for a division

Note: This step is not applicable for the health insurance business.

- Define the average price floor and ceil limits of the price item or price item bundle for a division

Note: This step is not applicable for the health insurance business.

- Define the negotiability floor and ceil values of the price item or price item bundle for a division

Note: This step is not applicable for the health insurance business.

- Define the division-specific characteristics for the price item or price item bundle
- **Price Item Characteristics** - Used to define characteristics (which are applicable across divisions) for the price item or price item bundle.

The **Main** section contains the following fields:

Field Name	Field Description	Mandatory (Yes or No)
Price Item	Displays the price item or price item bundle.	Not applicable
Description	Used to specify the description for the price item or price item bundle.	Yes
Price Item Usage	<p>Used to indicate whether the price item or price item bundle is available for pricing or pricing and billing. The valid values are:</p> <ul style="list-style-type: none"> • Pricing - Used when you want to define pricing for the price item or price item bundle, but no charges should be created against it in the system. <p>Note: This option is not applicable for the health insurance business.</p> <ul style="list-style-type: none"> • Pricing and Billing - Used when you want to define pricing and create charges for the price item or price item bundle in the system. <p>Note: You can change the price item usage of a price item or price item bundle from Pricing to Pricing and Billing. But, you cannot change the price item usage of a price item or price item bundle from Pricing and Billing to Pricing.</p>	Yes

Field Name	Field Description	Mandatory (Yes or No)
Price Item Type	<p>Used to indicate the type of the price item or price item bundle. The valid values are:</p> <ul style="list-style-type: none"> • Rate - Used when you want to create a rate based price item or price item bundle. For example, savings, current, and loan interest services (i.e. price items) are rate based price items. <div style="border: 1px solid black; padding: 2px; margin: 5px 0;"> <p>Note: This option is not applicable for the health insurance business.</p> </div> <ul style="list-style-type: none"> • Fees - Used when you want to create a fee based price item or price item bundle. For example, debit credit service (i.e. price item) is a fee based price item. <div style="border: 1px solid black; padding: 2px; margin: 5px 0;"> <p>Note: This field appears when the Pricing option is selected from the Price Item Usage list. You cannot create a price item bundle when the Pricing option is selected from the Price Item Usage list and Rate option is selected from the Price Item Type list. The system automatically sets the price item type of those price items or price item bundles which are available for pricing and billing to Fees. Therefore, this field does not appear when the Pricing and Billing option is selected from the Price Item Usage list.</p> </div>	Yes
Bundle	<p>Used to indicate whether you want to create a price item bundle. The valid values are:</p> <ul style="list-style-type: none"> • Yes • No <div style="border: 1px solid black; padding: 2px; margin: 5px 0;"> <p>Note: This field is not applicable for the health insurance business.</p> </div>	Yes

Field Name	Field Description	Mandatory (Yes or No)
Bundle Type	<p>Used to indicate the type of the price item bundle. If the Pricing and Billing option is selected from the Price Item Usage list, the valid values are:</p> <ul style="list-style-type: none"> • <i>Regular Bundle</i> • <i>Phantom Bundle</i> • <i>Ratio Bundle</i> <p>However, if the Pricing option is selected from the Price Item Usage list and the Fees option is selected from the Price Item Type list, you can only define a regular price item bundle. Therefore, by default, the value is set to Regular.</p>	Yes (Conditional)
	<p>Note:</p> <p>This field appears when the Yes option is selected from the Bundle list.</p> <p>This field is enabled when the Pricing and Billing option is selected from the Price Item Usage list and the Yes option is selected from the Bundle list.</p> <p>You cannot define a price item bundle when the Pricing option is selected from the Price Item Usage list and Rate option is selected from the Price Item Type list.</p> <p>This field is not applicable for the health insurance business.</p>	<p>Note: This field is required when you are creating a price item bundle.</p>
Global Price List	<p>Used to indicate whether the price item or price item bundle can be assigned to a global price list. The valid values are:</p> <ul style="list-style-type: none"> • Yes • No 	Yes
Contract Type	<p>Used to indicate the contract type that you want to associate with the price item or price item bundle.</p>	Yes
	<p>Note:</p> <p>This field appears when the Pricing and Billing option is selected from the Price Item Usage list.</p> <p>The Search (🔍) icon appears corresponding to the Contract Type field. On clicking the Search icon, the Contract Type Search window appears.</p>	

Field Name	Field Description	Mandatory (Yes or No)
Price Item Manager To Do Type	<p>Used to indicate the To Do type using which a To Do should be created when the deal creator or approver requests the price item manager (i.e. clicks the Send Price Items for Approval button) to approve the average price for the price item or price item bundle offered in a deal.</p> <p>Note:</p> <p>The Search (🔍) icon appears corresponding to the Price Item Manager To Do Type field. On clicking the Search icon, the To Do Type Search window appears.</p> <p>On specifying the To Do type, the description of the To Do type appears corresponding to the Price Item Manager To Do Type field.</p> <p>This field is not applicable for the health insurance business.</p>	No
Price Item Manager To Do Role	<p>Used to indicate that users with the specified To Do role can approve the average price for the price item or price item bundle offered in a deal. Note that the price item manager can approve the average price when it is within the average price floor and ceil limits defined for the To Do role.</p> <p>Note:</p> <p>The list appears when the price item manager To Do type is selected from the respective field. It includes only those To Do roles which are associated with the price item manager To Do type.</p> <p>This field is not applicable for the health insurance business.</p>	<p>Yes (Conditional)</p> <p>Note: This field is required when the price item manager To Do type is specified for the price item or price item bundle.</p>

Field Name	Field Description	Mandatory (Yes or No)
Average Price Floor and Ceil Type	<p>Used to indicate the manner in which you want to define the average price floor and ceil limits for the price item or price item bundle. The valid value is:</p> <ul style="list-style-type: none"> • Absolute Value Range - Used when you want to define the average price floor and ceil limits in the absolute values. For example, the average price for the price item or price item bundle should be between 10\$ to 15\$. • Spread Amount - Used when you want to define the average floor and ceil limits based on the spread amount. • Spread Percentage – Used when you want to define the average floor and ceil limits based on the spread percentage. 	Yes (Conditional)
	<p>Note:</p> <ul style="list-style-type: none"> • In case of Spread Amount and Spread Percentage options, the system calculates the average price of a price item and based on the average price and the spread amount or spread percentage, the average floor and ceil limits are derived. • This field is not applicable for the health insurance business. 	<p>Note: This field is required when you are defining the average price floor and ceil limits of the price item or price item bundle for a division.</p>
Sort Sequence	Used to specify the sequence in which the price item should appear in the price item hierarchy of the deal management module.	No

Field Name	Field Description	Mandatory (Yes or No)
Variable Price	Used to indicate whether the system inherits the pricing of the price item from the price list while orchestrating a deal in the deal management module.	No
	<p>Note:</p> <p>If the Variable Price option is selected, the pricing offered for a price item to an entity in the deal is overridden when the price list pricing is changed after orchestrating the deal in the system.</p> <p>However, if the Variable Price option is not selected, the pricing offered for a price item to an entity in the deal is not overridden when the price list pricing is changed in the system. This enables the relationship manager to create deals for an existing customers, accounts, and prospects where the pricing of the price items are fixed for a particular timeframe.</p>	

4. Modify the required details in the **Main** section.
5. Associate, edit, or disassociate parameters from the price item or price item bundle, if required.

Note:

You can edit the parameter details and remove a parameter from the price item or price item bundle when the parameter or any other parameter from the same date range is not yet used for aggregation or for defining the price item pricing.

You can add a parameter which is used for aggregation, whenever required. However, you can add a parameter which is used for pricing when any other parameter from the same date range is not yet used for aggregation or for defining the price item pricing.

For each predefined parameter which is associated with the price item or price item bundle, you can define a set of valid predefined parameter values for the price item or price item bundle, if required.

6. Associate or disassociate the price item or price item bundle from the divisions, if required.

Note: If the price item or price item bundle is associated to a division to which you do not have access, then the corresponding row in the **Divisions** section is grayed out.

7. Associate or disassociate the SQIs from the price item or price item bundle for the required divisions.
8. Define, edit, or remove the accrual type criteria of the price item or price item bundle from the required divisions.

Note: This step is not applicable for the health insurance business.

9. Associate or disassociate the price item or price item bundle from a hierarchy entity in an entity hierarchy relationship of the required divisions.

Note: This step is not applicable for the health insurance business.

10. Define, edit, or remove the cost of the price item or price item bundle from the required divisions.

Note: This step is not applicable for the health insurance business.

11. Define, edit, or remove the average price floor and ceil limits of the price item or price item bundle from the required divisions.

Note: This step is not applicable for the health insurance business.

12. Define, edit or remove the rate negotiability floor and ceil values of the price item or price item bundle for the required divisions.

Note: This step is not applicable for the health insurance business.

13. Define, edit, or remove the division-specific characteristics from the price item or price item bundle, if required.

14. Define, edit, or remove characteristics of the price item or price item bundle, if required.

15. Click **Save**.

The changes made to the price item or price item bundle are saved.

Related Topics

For more information on...	See...
How to search for a price item or price item bundle	Searching for a Price Item or Price Item Bundle on page 785
How to associate a parameter with a price item or price item bundle	Associating a Parameter with a Price Item or Price Item Bundle on page 793
How to associate a price item or price item bundle with a division	Associating a Price Item or Price Item Bundle with a Division on page 798
How to associate an SQI with a price item or price item bundle for a division	Associating an SQI with a Price Item or Price Item Bundle for a Division on page 802
How to define the accrual type criteria of a price item or price item bundle for a division	Defining the Accrual Type Criteria of a Price Item or Price Item Bundle for a Division on page 805
How to associate a price item or price item bundle with a hierarchy entity in an entity hierarchy relationship of a division	Associating a Price Item or Price Item Bundle with a Hierarchy Entity in an Entity Hierarchy Relationship of a Division on page 807
How to define the cost of a price item or price item bundle for a division	Defining the Cost of a Price Item or Price Item Bundle for a Division on page 809
How to define the average price floor and ceil limits of a price item or price item bundle for a division	Defining the Average Price Floor and Ceil Values of a Price Item or Price Item Bundle for a Division on page 812
How to define the rate negotiability floor and ceil values for a price item or price item bundle	Defining the Rate Negotiability Floor and Ceil Values of a Price Item or Price Item Bundle for a Division
How to define a division-specific characteristic for a price item or price item bundle	Defining a Division-Specific Characteristic for a Price Item or Price Item Bundle on page 803
How to define a characteristic for a price item or price item bundle	Defining a Characteristic for a Price Item or Price Item Bundle on page 815
How to set the C1_PRICING feature configuration	Setting the C1_PRICING Feature Configuration on page 3467

Price List

A price list allows you to define standard prices for a group of price items. In other words, a price list is a rate card for price items or services which are offered to the accounts or persons. You can create more than one price list. For example, you can create a price list for large, medium-sized, and small customers. You can also create a set of price lists for different regions. You can define two types of price lists — **Standard** and **Promotional**. You can also set eligibility criteria for the price list with effective start date, end date, and description. At present, there is no functionality associated with the price list type. The implementation team can use the price list type to define the custom logic as per the business requirements.

A price list and price item pricing within the price list are effective for a particular duration. You can define multiple pricing for the same price item and variance parameter or product parameters combination within a price list when the price item pricing date range is different. You can assign the same price item in multiple price lists and define different pricing for the price item in each price list based on the business requirements.

The system enables you to specify the duration for which the price list is available for assignment to an account or a person. However, note that at present, the availability start and end dates are not used in the product while assigning a price list to an account or a person. If required, the implementation team can build the custom logic using the availability start and end dates in the product.

Once you create a price list, you have to assign price items to the price list and define pricing for each price item assigned to the price list. The price lists are then assigned to accounts or persons to indicate the prices that will be charged for various price items or services offered to them. You can assign multiple price lists to an account or a person for an overlapping date range. But, you need to specify the priority or order for the price list in which the pricing from the price list should be considered. You can also assign the same price list to multiple accounts or persons.

You can define whether the account or person can avail the price item pricing listed on the parent or grandparent price list if it is not available on the assigned price list. In other words, you can define whether the account or person can inherit price item pricing from the price list hierarchy.

The system allows you to create the following:

- **Default Price List** – You can create a price list and set it as a default price list for a particular division. To define a default price list for a division, you need to set the value for the **Default Price List ID** parameter in the price assignment search algorithm which is attached to the division. If the effective price item pricing is not available at any level in the customer hierarchy, the system checks whether the default price list is specified in the price assignment search algorithm. If the default price list is specified in the algorithm, the system checks whether effective price item pricing is available in the default price list and accordingly uses the price item pricing. You can have the same price list as a the default price list for multiple divisions.
- **Global Price List** – You can create one global price list in the system. It is used when the price item pricing is not available at any level in the customer hierarchy and in the default price list associated with the division. You can assign only those price items in the global price list whose the **Global Price List** option is set to **Yes**. The global price list is used while searching an effective price item pricing when the **Global Price List** parameter in the price assignment search algorithm (attached to the division) is set to **Y**. Finally, if the effective price item pricing is not available in the default and/or global price list, an error message occurs indicating that the effective price item pricing is not available in the system.
- **Template Price List** – You can define a template price list and assign template price item pricing to a template price list. You cannot assign template price list to an account or a person. You can only create a copy of a template price item pricing which is assigned to a template price list. Once you create a copy of the template price item pricing, you can save the new price item pricing in either **Active** or **Proposed** status.

Price List (Used for Searching)

The **Price List** screen allows you to search for a price list using various search criteria. It also allows you to create a price list. This screen consists of the following zones:

- [Search Price List](#) on page 845
- [Price List Price Items](#) on page 848
- [Price Item Pricing](#)
- [Pricing Structure](#)

Search Price List

The **Search Price List** zone allows you to search for a price list using various search criteria. It contains the following two sections:

- **Search Criteria** - The **Search Criteria** section contains the following fields:

Field Name	Field Description	Mandatory (Yes or No)
Search By	Used to indicate whether you want to search for a price list using the price list details. The valid value is: <ul style="list-style-type: none"> • Price List Details 	Yes
	Note: By default, the Price List Details option is selected.	
Price List ID	Used to search a particular price list.	No
Price List Description	Used to search a price list with a particular description.	No
Effective Start Date	Used to search price lists which are effective from a particular date.	No
Effective End Date	Used to search price lists which are effective till a particular date.	No
Price List Type	Used to search a particular type of price lists. The valid values are: <ul style="list-style-type: none"> • Promotional • Standard 	No
	Note: By default, the Standard option is selected.	
Global Price List	Used to indicate whether you want to search a global price list. The valid values are: <ul style="list-style-type: none"> • Yes • No 	No
Availability Start Date	Used to search price lists which are available for assignment to an account or a person from a particular date.	No
	Note: By default this field does not appear. This field appears when you click the Advanced Search link in the upper right corner of the Search Price List zone.	

Field Name	Field Description	Mandatory (Yes or No)
Availability End Date	Used to search price lists which are available for assignment to an account or a person till a particular date.	No
	Note: By default this field does not appear. This field appears when you click the Advanced Search link in the upper right corner of the Search Price List zone.	
Status	Used to search price lists with a particular status. The valid values are: <ul style="list-style-type: none"> • Active • Inactive • Proposed • Template 	No
	Note: By default this field does not appear. This field appears when you click the Advanced Search link in the upper right corner of the Search Price List zone.	
Division	Used to search price lists which are associated with a particular division.	No
	Note: You can only view those divisions to which you have access in the Division list.	
Parent Price List	Used to search price lists which inherit pricing from a particular parent price list.	No
	Note: The Search (🔍) icon appears corresponding to this field. On clicking the Search icon, the Price List Search window appears. By default this field does not appear. This field appears when you click the Advanced Search link in the upper right corner of the Search Price List zone.	
Parent Price List Effective Date	Used to search price lists that can inherit pricing from a parent price list which is effective from a particular date.	No
	Note: By default this field does not appear. This field appears when you click the Advanced Search link in the upper right corner of the Search Price List zone.	

Note: You must specify at least one search criterion while searching for a price list.

- **Search Results** – On clicking the **Search** button, the search results appear based on the specified search criteria. The **Search Results** section contains the following columns:

Column Name	Column Description
Price List Information	Displays information about the price list.
	Note: It has a link. On clicking the link, the Price List screen appears where you can view the details of the respective price list.
Status	Indicates the status of the price list. The valid values are: <ul style="list-style-type: none"> • Active • Inactive • Proposed • Template
Effective Start Date	Displays the date from when the price list is effective.
Effective End Date	Displays the date till when the price list is effective.
Availability Start Date	Displays the date from when the price list is available for assignment to an account or a person.
Availability End Date	Displays the date till when the price list is available for assignment to an account or a person.
Duplicate	On clicking the Duplicate (📄) icon, the Price List screen appears where you can create a new price list using an existing price list.
Price List Pricing	On clicking the View (🔗) icon in the Price List Pricing column, the Price List Price Item Pricing screen appears where you can view and edit a list of price items pricing information assigned to the price list.
Price List Assigned To	On clicking the View (🔗) icon in the Price List Assigned To column, the Price List Assignments screen appears where you can view the details of the persons and accounts to which the price list is assigned.
Eligible Accounts/ Persons	On clicking the View (🔗) icon in the Eligible Accounts/Persons column, the Entities Eligible for Price List Assignment screen appears where you can search for a list of eligible accounts and persons to which you want to assign the price list in a particular division.

Note:

However, when you search for a price list by specifying the date (which can be current, past or future date) in the **Parent Price List Effective Date** field, the system retrieves the price lists that meet the search criteria along with the details of the parent price list that is effective on that date.

Pagination is used to display limited number of records in the **Search Results** section. You can use the navigation links, such as **Previous** and **Next** to navigate between pages.

By default, the **Filter** area is visible. You can hide the **Filter** area by clicking the **Filters** (🔍) icon in the upper right corner of this zone.

On clicking the **Broadcast** (📢) icon corresponding to the **Price List Information** field, the **Price List Price Items** zone appears where you can view a list of price items to which the price list is assigned.

Related Topics

For more information on...	See...
Price List Price Items zone	Price List Price Items on page 866
How to search for a price list	Searching for a Price List on page 849
How to view price items assigned to a price list	Viewing Price Items Assigned to a Price List on page 850
How to define a price list	Defining a Price List on page 850
How to copy a price list	Copying a Price List on page 857
How to view price list price items and assign price items	Price List Price Item Pricing on page 865
How to view the details of the price list assigned	Price List Assignments on page 914
How to search for eligible accounts and persons to be assigned to the price list.	Entities Eligible for Price List Assignment on page 916

Price List Price Items

The **Price List Price Items** zone lists price items that are assigned to the price list. You will not find any records in this zone if the price list does not have any price items assigned to it. It contains the following columns:

Column Name	Column Description
Pricing Information	<p>Displays the concatenated string consisting of pricing information and pricing ID which are separated by a comma (,) for the price list.</p> <p>Note: It has a link. On clicking the link, the Price Item Pricing screen appears where you can view the pricing information of the respective price list.</p>
Price Item	Displays the price item or price item bundle.
Pricing Parameters	<p>Used to specify multiple parameters based on which you want to determine the pricing utilization.</p> <p>Note: This column appears only when the Multi Price Parameter option type of the Multi Parameter Based Pricing (C1_PPARAM_FLG) feature configuration is set to True.</p>
Pricing Status	<p>Displays the status of pricing for the price item. The valid values are:</p> <ul style="list-style-type: none"> • Active • Inactive
Rate Info	<p>Displays the rate of the price item.</p> <p>Note:</p> <p>If the price assignment has only one price component, you can view the rate defined in the pricing directly through the Rate Info column.</p> <p>However, if the price assignment has more than one price components, then the Rate Info column contains a string indicating the tiering type and pricing currency. It also contains “...” which indicates that for more information about the pricing you should navigate to the Price Item Pricing screen.</p>
Start Date	Displays the date from when the price item pricing is effective for the price list.

Column Name	Column Description
End Date	Displays the date till when the price item pricing is effective for the price list.
Price Assignment Type	<p>Indicates the type of the price item pricing. The valid values are:</p> <ul style="list-style-type: none"> • Regular • Post Processing • Post Processing – Invoice Based • Post Processing – Price Item Based <p>Note: This column appears when the Multi Price Parameter option type of the Multi Parameter Based Pricing (C1_PPARM_FLG) feature configuration is set to True.</p>
Duplicate	On clicking the Duplicate () icon, the Price Item Pricing screen appears where you can define a new price item pricing using an existing price item pricing.

By default, the **Price List Price Items** zone does not appear in the **Price List** screen. It appears when you click the **Broadcast** () icon corresponding to the price list in the **Search Price List** zone.

You can filter the list using various search criteria (such as, **Price Item** and **Effective Start Date**) available in the **Filter** area. By default, the **Filter** area is hidden. You can view the **Filter** area by clicking the **Filters** () icon in the upper right corner of this zone.

On clicking the **Broadcast** () icon corresponding to the **Pricing Information** field, the **Price Item Pricing** and **Pricing Structure** zones appear where you can view the details about the price item pricing and its structure.

You can change the layout of this zone. For more information on how to change the layout, see [Changing the Layout](#) on page 3414.

Related Topics

For more information on...	See...
Search Price List zone	Search Price List on page 845
Price Item Pricing zone	Price Item Pricing
Pricing Structure zone	Pricing Structure
How to view price items assigned to a price list	Viewing Price Items Assigned to a Price List on page 850
How to view price item pricing of a price list	Viewing a Price Item Pricing on page 874

Searching for a Price List

Prerequisites

To search for a price list, you should have:

- Divisions defined in the application
- Price list associated with the division to which the user belongs

Procedure

To search for a price list:

1. Click the **Menu** link in the **Application** toolbar.

A list appears.

- From the **Main** menu, select **Pricing Management** and then click **Price List**.

A sub-menu appears.

- Click the **Search** option from the **Price List** sub-menu.

The **Price List** screen appears.

- Enter the search criteria in the **Search Price List** zone.

Note: ORMB search engine supports wildcard search, where you can substitute the percentage (%) symbol as a stand in for any word or letter in a search criteria. You can use the ‘%’ wildcard character in all input fields except the date and ID fields. The ‘%’ wildcard character is suffixed automatically at the end of the partial search criteria. Therefore, you may or may not specify the wildcard character at the end of the partial search criteria. However, you have to prefix the wildcard character manually wherever required.

- Click **Search**.

A list of price lists that meet the search criteria appears in the **Search Results** section.

Note: Pagination is used to display limited number of records in the **Search Results** section. You can use the navigation links, such as **Previous** and **Next** to navigate between pages.

Related Topics

For more information on...	See...
Price List screen	Price List (Used for Viewing) on page 860
Search Price List zone	Search Price List on page 845

Viewing Price Items Assigned to a Price List

Prerequisites

To view price items assigned to a price list, you should have:

- An algorithm defined using the **C1-PLPINFO** algorithm type and attached to **Pricelist Products Assignment Information** system event in the **Algorithms** tab of the **Installation Options – Framework** screen

Procedure

To view price items assigned to a price list:

- Search for the price list in the **Price List** screen.
- In the **Search Results** section, click the **Broadcast** (📡) icon corresponding to the price list whose price items details you want to view.

The **Price List Price Items** zone appears.

- View the price items that are assigned to the price list in the **Price List Price Items** zone.

Related Topics

For more information on...	See...
How to search for a price list	Searching for a Price List on page 849
Price List Price Items zone	Price List Price Items on page 848

Defining a Price List

Procedure

To define a price list:

1. Click the **Menu** link in the **Application** toolbar.
A list appears.
2. From the **Main** menu, select **Pricing Management** and then click **Price List**.
A sub-menu appears.
3. Click the **Add** option from the **Price List** sub-menu.

The **Price List** screen appears. It consists the following sections:

- **Main** - Used to specify basic details about the price list.
- **Hierarchy** - Used to associate the price list with one or more parent price lists for a particular duration.
- **Divisions** - Used to associate the price list with one or more divisions.
- **Eligibility** - Used to define eligibility criteria for the price list.
- **Characteristics** - Used to define the characteristics for the price list.

The **Main** section contains the following fields:

Field Name	Field Description	Mandatory (Yes or No)
Price List Description	Used to specify the description for the price list.	Yes
Effective Start Date	Used to specify the date from when the price list is effective.	Yes
	Note: By default, the current date appears in this field.	
Effective End Date	Used to specify the date till when the price list is effective.	No
	Note: The effective end date cannot be earlier than the effective start date.	
Price List Type	Used to indicate the type of the price list. The valid values are: <ul style="list-style-type: none"> • Standard • Promotional 	Yes
	Note: By default, the Standard option is selected.	
Global Price List	Used to indicate whether the price list is a global price list. The valid values are: <ul style="list-style-type: none"> • Yes • No 	Yes
Availability Start Date	Used to the specify the date from when the price list is available for assignment to an account or a person.	No
	Note: At present, the availability start date is not used in the price item while assigning a price list to an account or a person. It is available for future use.	

Field Name	Field Description	Mandatory (Yes or No)
Availability End Date	Used to specify the date till when the price list is available for assignment to an account or a person. Note: The availability end date cannot be earlier than the availability start date. At present, the availability end date is not used in the price item while assigning a price list to an account or a person. It is available for future use.	No
Available for Deal Pricing	Used to indicate whether the price list is available for deal pricing or not.	No
Standard for Deal Pricing	Used to indicate whether the price list is applicable for defining costs or floor and ceil limits or commitments at the time of deal pricing.	No
Validity Period (in Days)	Used to specify the period in days for which the price list is valid. It is used to calculate price list assignment validity end date while assigning the price list to an account or a person.	No
Status	Used to indicate the status of the price list. The valid values are: <ul style="list-style-type: none"> • Active - Used to indicate that the price list is used for billing. • Inactive - Used to indicate that the price list is no longer used for billing. • Proposed - Used to indicate that the price list is used for quotations. • Template - Used to indicate that the price list is a template price list. Note: By default, the Active option is selected.	Yes

Tip: Alternatively, you can access the **Price List** screen by clicking the **Add** button in the **Page Title** area of the **Price List** screen.

4. Enter the required details in the **Main** section.

Note: By default the **Main** section is displayed.

5. Click the **Show All** link from the **Section** to view all the sections and define or associate the following:

- Associate the price list with one or more parent price list, if required.
- Associate price list with one or more divisions, if required.
- Define eligibility criteria for the price list, if required.
- Define characteristics for the price list, if required.

6. Click **Save**.

Note: The price list ID is generated automatically when the price list is created.

Related Topics

For more information on...	See...
Price List screen	Price List (Used for Viewing) on page 860
Price List screen	Price List (Used for Searching) on page 844
How to define the price list hierarchy	Defining the Price List Hierarchy on page 853
How to define a characteristic for a price list	Defining a Characteristic for a Price List on page 854
How to associate a price list with a division	Associating a Price List with a Division on page 855
How to define eligibility criteria for a price list	Defining Eligibility Criteria for a Price List on page 856

Defining the Price List Hierarchy

Oracle Revenue Management and Billing allows you to define the price list hierarchy. It helps you to inherit the price item pricing from the parent price list if the price item pricing is not available in the price list (assigned to the account, person, or parent person). And, if the price item pricing is not available in the parent price list, the system will search for the price item pricing in the parent's parent price list (i.e. in the grandparent price list) and continue till it reaches the last level in the hierarchy.

In other words, when you define the price list hierarchy and assign the price list to an account or a person, the account or person can avail the price item pricing listed on the parent or grandparent price list if it is not available on the assigned price list. However, if the price item pricing is available on both the assigned and parent price lists, the system derives the price item pricing from the assigned price list.

You can define multiple parent price lists for a price list. But, only one parent price list is effective for a particular duration. Two or more price lists can have the same parent price list.

Procedure

To define the price list hierarchy:

1. Click the **Hierarchy** or **Show All** link from the **Section** in the **Price List** screen when you are defining, editing, or copying a price list.

The **Hierarchy** section appears. It contains the following fields in a grid:

Field Name	Field Description	Mandatory (Yes or No)
Parent Price List Effective From Date	Used to specify the date from when the price list inherits pricing from the parent price list.	Yes (Conditional) Note: This field is required when you are associating the price list with a parent price list.
Parent Price List Effective To Date	Used to specify the date till when the price list inherits pricing from the parent price list. Note: The parent price list effective to date cannot be earlier than the parent price list effective from date and later than price list effective end date.	No

Field Name	Field Description	Mandatory (Yes or No)
Parent Price List	Used to specify the parent price list ID to which you want to associate the price list.	Yes (Conditional)
	<p>Note:</p> <p>The Search (🔍) icon appears corresponding to this field. On clicking the Search icon, the Price List Search window appears.</p> <p>On specifying the parent price list, the description of the parent price list appears corresponding to the Parent Price List field.</p>	<p>Note: This field is required when you are associating the price list with a parent price list.</p>

- Enter the required details in the **Hierarchy** section.

Note: You can search for a price list by clicking the **Search** (🔍) icon corresponding to the **Parent Price List** field.

- If you want to associate the price list with more than one parent price list, click the **Add** (+) icon corresponding to the parent price list and then repeat step 2.

Note:

You can associate a price list with multiple parent price lists. But, only one parent price list is effective for a particular duration. Also, while associating a price list with a parent price list, you can only specify a price list which is effective during the specified duration.

If you want to remove a parent price list from the price list hierarchy, click the **Delete** (🗑️) icon corresponding to the parent price list.

- Click **Save**.

The price list is associated with the parent price lists.

Related Topics

For more information on...	See...
How to define a price list	Defining a Price List on page 850
How to edit a price list	Editing a Price List on page 863
How to copy a price list	Copying a Price List on page 857

Defining a Characteristic for a Price List

Prerequisites

To define a characteristic for a price list, you should have:

- Characteristic types defined in the application (where the characteristic entity is set to **Price List**)

Procedure

To define a characteristics for a price list:

- Click the **Characteristics** or **Show All** link from the **Section** in the **Price List** window when you are defining, editing, or copying a price list.

The **Characteristics** section appears. It contains the following fields in a grid:

Field Name	Field Description	Mandatory (Yes or No)
Effective Date	Used to specify the date from when the characteristic is effective for the price list.	Yes (Conditional)
		Note: This field is required when you are defining a characteristic for the price list.
Characteristic Type	Used to indicate the characteristic type. Note: The list includes only those characteristic types where the characteristic entity is set to Price List .	Yes (Conditional)
		Note: This field is required when you are defining a characteristic for the price list.
Characteristic Value	Used to specify the value for the characteristic type. Note: The Search (🔍) icon appears corresponding to this field. On clicking the Search icon, the Predefined Characteristic Search window appears. On specifying the value for a predefined characteristic type, the description of the characteristic value appears corresponding to the Characteristic Value field.	Yes (Conditional)
		Note: This field is required when you are defining a characteristic for the price list.

- Enter the required details in the **Characteristics** section.

Note: If you select a predefined characteristic type, the **Search** (🔍) icon appears corresponding to the **Characteristic Value** field. On clicking the **Search** icon, you can search for a predefined characteristic value.

- If you want to define more than one characteristic for the price list, click the **Add** (+) icon and then repeat step 2.

Note: However, if you want to remove a characteristic from the price list, click the **Delete** (🗑️) icon corresponding to the characteristic.

- Click **Save**.

The characteristics are defined for the price list.

Related Topics

For more information on...	See...
How to define a price list	Defining a Price List on page 850
How to edit a price list	Editing a Price List on page 863
How to copy a price list	Copying a Price List on page 857

Associating a Price List with a Division

You can assign a price list only to those accounts or persons which belong to the division to which the price list is associated. Therefore, you need to associate the price list with appropriate divisions.

Prerequisites

To associate a price list with a division, you should have:

- Divisions defined in the application

Procedure

To associate a price list with a division:

1. Click the **Divisions** or **Show All** link from the **Section** in the **Price List** window when you are defining, editing, or copying a price list.

The **Divisions** section appears. It contains the following field in a grid:

Field Name	Field Description	Mandatory (Yes or No)
Division	Used to indicate the division to which you want to associate the price list.	No
	Note: You can only view those divisions to which you have access in the Division list.	

2. Select the required division from the list.
3. If you want to associate the price list with more than one division, click the **Add (+)** icon corresponding to the division and then repeat step 2.

Note: However, if you want to remove the price list from a division, click the **Delete** (🗑️) icon corresponding to the division.

4. Click **Save**.

The price list is associated with the divisions.

Tip: Alternatively, you can associate a price list with a division using the **Division** screen.

Related Topics

For more information on...	See...
How to define a price list	Defining a Price List on page 850
How to edit a price list	Editing a Price List on page 863
How to copy a price list	Copying a Price List on page 857

Defining Eligibility Criteria for a Price List**Prerequisites**

To define eligibility criteria for a price list, you should have:

- The **Price List Eligibility Criteria** check box selected in the **Parameter Usage** section while defining the parameter

Procedure

To define eligibility criteria for a price list:

1. Click the **Eligibility** or **Show All** link from the **Section** in the **Price List** screen when you are defining, editing, or copying a price list.

The **Eligibility** section appears. It contains the following fields in a grid:

Column Name	Column Description	Mandatory (Yes or No)
Criteria	On clicking the Add (+) icon, you can associate eligibility criteria of parameters for the price list.	Yes (Conditional) Note: This field is required when you are defining an eligibility criteria for the price list.
Effective Start Date	Used to specify the date from when the criteria is effective for the price list.	Yes (Conditional) Note: This field is required when you are defining an eligibility criteria for the price list.
Effective End Date	Used to specify the date till when the criteria is effective for the price list.	No
Description	Used to specify the description for the criteria type.	Yes

- Enter the required details in the **Eligibility** section.
- If you want to define more than one eligibility criteria for the price list, click the **Add** (+) icon and then repeat step 2.

Note: However, if you want to remove the eligibility criteria, click the **Delete** (🗑️) icon corresponding to the criteria.

- Associate eligibility criteria of parameter for the price list, if required.
- If you want to define more than one eligibility criteria of parameter for the price item, click the **Add** (+) icon corresponding to the parameter.

Note: However, if you want to remove the eligibility criteria of parameter for the price item, click the **Delete** (🗑️) icon corresponding to the parameter.

- Click **Save**.

The eligibility criteria are defined for the price list.

Related Topics

For more information on...	See...
How to create a price list	Defining a Price List on page 850
How to edit a price list	Editing a Price List on page 863
How to associate eligibility criteria of parameter for a price list	Associating Eligibility Criteria of Parameters for a Price List

Copying a Price List

Instead of creating a price list from scratch, you can create a new price list using an existing price list. This is possible through copying a price list. On copying a price list, the details including the pricing parameters, divisions,

characteristics, eligibility criteria, and the assigned price items are copied to the new price list. You can then edit the details, if required.

Prerequisites

To copy a price list, you should have:

- Price list (whose copy you want to create) defined in the application
- Price list (whose copy you want to create) associated with the division to which the user belongs

Procedure

To copy a price list:

1. Search for the price list in the **Price List** screen.
2. In the **Search Results** section, click the **Copy**  icon in the **Copy** column corresponding to the price list using which you want to define a new price list.

The **Price List** screen appears. It contains the following sections:

- **Main** – Used to specify basic details about the price list.
- **Hierarchy** – Used to define parent price list for the price list for a particular duration.
- **Divisions** – Used to associate price list with one or more divisions.
- **Eligibility Criteria** – Used to define eligibility criteria for price list.
- **Characteristics** – Used to define the characteristics (which are applicable across divisions) for the price list.

The **Main** section contains the following fields:

Field Name	Field Description	Mandatory (Yes or No)
Price List Description	Used to specify the description for the price list.	Yes
Effective Start Date	Used to specify the date from when the price list is effective	Yes
Effective End Date	Used to specify the date till when the price list is effective.	No
Price List Type	Used to indicate the type of the price list. The valid values are: <ul style="list-style-type: none"> • Standard • Promotional 	Yes
Global Price List	Used to Indicate whether the price list is a global price list. The valid values are: <ul style="list-style-type: none"> • Yes • No 	Yes
Availability Start Date	Used to specify the date from when the price list is available for assignment to an account or a person.	Yes
Availability End date	Used to specify the date till when the price list is available for assignment to an account or a person.	No
Available for Deal Pricing	Used to indicate whether the price list is available for deal pricing or not.	No

Field Name	Field Description	Mandatory (Yes or No)
Standard for Deal Pricing	Used to indicate whether the price list is applicable for defining costs or floor and ceil limits or commitments at the time of deal pricing.	No
Validity Period (in Days)	Used to specify the period in days for which the price list is valid. It is used to calculate price list assignment validity end date while assigning the price list to an account or a person.	Yes
Status	Used to indicate the status of the price list. The valid values are: <ul style="list-style-type: none"> • Active • Proposed • Template 	Yes
Copy Pricing	Used to indicate whether you want to copy the pricing information to the price list. The valid values are: <ul style="list-style-type: none"> • All • None 	Yes (Conditional)

- Enter the required details in the **Main** section.
- Add, edit, or remove the parent price list details, if required.
- Associate or disassociate the price list from the required divisions.
- Define, edit, or remove the price list eligibility criteria and parameter eligibility criteria for price list in the, if required.
- Define, edit, or remove characteristics of the price list, if required.
- Click **Save**.

The new price list is defined.

Note: The price list ID is generated automatically when the price list is defined.

Related Topics

For more information on...	See...
How to search for a price list	Searching for a Price List on page 849
How to define the price list hierarchy	Defining the Price List Hierarchy on page 853
How to define a characteristic for a price list	Defining a Characteristic for a Price List on page 854
How to associate a price list with a division	Associating a Price List with a Division on page 855
How to define eligibility criteria for the price list	Defining Eligibility Criteria for a Price List on page 856

Viewing the Price List Details

Procedure

To view the details of a price list:

- Search for the price list in the **Price List** screen.

- In the **Search Results** section, click the link in the **Price List Information** column corresponding to the price list whose details you want to view.

The **Price List** screen appears. It contains the following zones:

- [Price List](#) on page 860
 - [Eligibility Criteria](#) on page 862
 - [Price List Price Items](#) on page 848
- View the basic details, hierarchy, divisions, and characteristics of the price list in the **Price List** zone.
 - View the eligibility criteria to which the price list is associated in the **Eligibility Criteria** zone.
 - View the price items that are assigned to the price list in the **Price List Price Items** zone.

Related Topics

For more information on...	See...
How to search for a price list	Searching for a Price List on page 849
Price List screen	Price List (Used for Viewing) on page 860

Price List (Used for Viewing)

The **Price List** screen allows you to view the details of a price list. It also allows you to edit a price list. It contains the following zones:

- Price List** - Displays the basic details of the price list.
- Eligibility Criteria** - Displays the eligibility criteria for the price list.
- Price List Price Items** - Displays the price items that are assigned to the price list.
- Price Item Pricing**
 - Displays the price item pricing for price items that are assigned to the price list.
- Pricing Structure**
 - Displays the structure of the price item pricing for price item that are assigned to the price list.

Price List

The **Price List** zone displays the details of the price list. It contains the following sections:

- Main** - Displays basic information about the price list. It contains the following fields:

Field Name	Field Description
Price List ID	Displays the price list ID.
Price List Description	Displays the description for the price list.
Effective Start Date	Displays the date from when the price list is effective.
Effective End Date	Displays the date till when the price list is effective.
Price List Type	Indicates the type of the price list. The valid values are: <ul style="list-style-type: none"> Standard Promotional

Field Name	Field Description
Global Price List	Indicates whether the price list is a global price list. The valid values are: <ul style="list-style-type: none"> • Yes • No
Availability Start Date	Displays the date from when the price list is available for assignment to an account or a person.
Availability End date	Displays the date till when the price list is available for assignment to an account or a person.
Available for Deal Pricing	Indicates whether the price list can be assigned with a person or an account.
Standard for Deal Pricing	Indicates whether the price list can be considered to compare the average floor and ceil limit with the standard and average price of a price item associated with a price list.
Validity Period (in Days)	Displays the period in days for which the price list is valid. It is used to calculate price list assignment validity end date while assigning the price list to an account or a person.
Status	Indicates the status of the price list. The valid values are: <ul style="list-style-type: none"> • Active – Indicates that the price list is used for billing. • Inactive – Indicates that the price list is no longer used for billing. • Proposed – Indicates that the price list is used for quotations. • Template – Indicates that the price list is a template price list.

- **Hierarchy** - Lists the parent price list from which the price list has inherited the price item pricing for a particular duration. It contains the following columns:

Column Name	Column Description
Parent Price List ID	Displays the ID of the parent price list.
Parent Price List Effective From Date	Displays the date from when the price list can inherit pricing from the parent price list.
Parent Price List Effective To Date	Displays the date till when the price list can inherit pricing from the parent price list.

- **Divisions** - Lists the divisions to which the price list is associated. It contains the following column:

Column Name	Column Description
Division	Displays the division to which the price list is associated. Note: It has a link. On clicking the link, the Division screen appears where you can view the details of the respective division.

- **Characteristics** - Lists the characteristics that are associated with the price list. It contains the following columns:

Column Name	Column Description
Effective Date	Displays the date from when the characteristic is effective for the price list.
Characteristic Type	Displays the characteristic type.

Column Name	Column Description
Characteristic Value	Displays the value for the characteristic type.

- **Record Actions** - This section contains the following button:

Button Name	Button Description
Edit	Used to edit the details of the price list.

- **Record Information** - This section contains the following field:

Field Name	Field Description
Business Object	Indicates the business object using which the price list is created. In addition, a context menu appears corresponding to this field which helps in navigating to other screens in the application.
	Note: It has a link. On clicking the link, the Business Object screen appears where you can view the details of the respective business object.

Related Topics

For more information on...	See...
Price List screen	Price List (Used for Viewing) on page 860
How to define a price list	Defining a Price List on page 850
How to edit a price list	Editing a Price List on page 863

Eligibility Criteria

The **Eligibility Criteria** zone lists the eligibility criteria of the price list. It contains the following columns:

Field Name	Field Description
Effective Start Date	Displays the date from when the criteria is effective for the price list.
Effective End Date	Displays the date till when the criteria is effective for the price list.
Description	Displays the description for the criteria type.
Sequence	Indicates the order in which the price list eligibility criteria should be executed.
Parameter	Indicates the parameter (on the left hand side) is used in the pricing eligibility criteria.
Operator	Displays the relational operator to define the relation between the parameter name and value.
Parameter Value Type	Indicates whether the parameter (on the left hand side) must be compared against another parameter (on the right hand side) or directly against a parameter value.
Parameter	Indicates the parameter (on the right hand side) against which you want to compare the parameter (on the left hand side).
Parameter Value	Indicates the parameter value against which you want to compare the parameter (on the left hand side).

Field Name	Field Description
Is True	Indicates what happens when the condition is true (satisfied). The valid values are: <ul style="list-style-type: none"> • Check Next Condition – Indicates that the condition with consecutive sequence number should be executed. • Rule Is False – Indicates that the action specified in the Rule False Action field should be executed • Rule Is True – Indicates that the action specified in the Rule True Action field should be executed.
Is False	Indicates what happens when the condition is false (not satisfied). The valid values are: <ul style="list-style-type: none"> • Check Next Condition – Indicates that the condition with consecutive sequence number should be executed. • Rule Is False – Indicates that the action specified in the Rule False Action field should be executed • Rule Is True – Indicates that the action specified in the Rule True Action field should be executed.
Is Insufficient	Indicates what happens when the data is insufficient. The valid values are: <ul style="list-style-type: none"> • Check Next Condition – Indicates that the condition with consecutive sequence number should be executed. • Rule Is False – Indicates that the action specified in the Rule False Action field should be executed • Rule Is True – Indicates that the action specified in the Rule True Action field should be executed.

Related Topics

For more information on...	See...
Price List screen	Price List (Used for Viewing) on page 860

Editing a Price List

Procedure

To edit a price list:

1. Search for the price list in the **Price List** screen.
2. In the **Search Results** section, click the link in the **Price List Information** column corresponding to the price list whose details you want to edit.

The **Price List** screen appears.

3. Click the **Edit** button in the **Price List** zone.

The **Price List** screen appears. It contains the following sections:

- **Main** - Used to specify basic details about the price list.
- **Hierarchy** - Used to define parent price list to inherit price item pricing for the price list for a particular duration.
- **Divisions** - Used to associate price list with one or more divisions.
- **Eligibility Criteria** - Used to define eligibility criteria for the price list.

- **Characteristics** - Used to define the characteristics (which are applicable across divisions) for the price list.

The **Main** section contains the following fields:

Field Name	Field Description	Mandatory (Yes or No)
Price List Description	Used to specify the description for the price list.	Yes
Effective Start Date	Used to specify the date from when the price list is effective. Note: The system will not allow you to change the effective start date when: <ul style="list-style-type: none"> • There is a price item assigned to the price list on that date. • The price list is assigned to an account or a person on that date. 	Yes
Effective End Date	Used to specify the date till when the price list is effective. Note: The effective end date cannot be earlier than the effective start date.	No
Price List Type	Used to indicate the type of the price list. The valid values are: <ul style="list-style-type: none"> • Standard • Promotional 	Yes
Global Price List	Used to indicate whether the price list is a global price list. The valid values are: <ul style="list-style-type: none"> • Yes • No 	Yes
Availability Start Date	Used to the specify the date from when the price list is available for assignment to an account or a person. Note: At present, the availability start date is not used in the product while assigning a price list to an account or a person. It is available for future use.	No
Availability End Date	Used to the specify the date till when the price list is available for assignment to an account or a person. Note: The availability end date cannot be earlier than the availability start date. At present, the availability end date is not used in the product while assigning a price list to an account or a person. It is available for future use.	No

Field Name	Field Description	Mandatory (Yes or No)
Validity Period (in Days)	Used to specify the period in days for which the price list is valid. It is used to calculate price list assignment validity end date while assigning the price list to an account or a person.	No
Status	Used to indicate the status of the price list. The valid values are: <ul style="list-style-type: none"> • Active – Used to indicate that the price list is used for billing. This value appears when you are editing a proposed price list • Proposed – Used to indicate that the price list is used for quotations. • Template – Used to indicate that the price list is a template price list. 	Yes
	Note: You cannot change the status of an active and a template price list.	

4. Modify the details in the **Main** section, if required.

Note: By default the **Main** section is displayed.

5. Add, edit or remove parent price list from the price list hierarchy, if required.
6. Associate or disassociate the price list from the divisions, if required.

Note: You can only view those divisions to which you have access in the **Division** list. If the price list is associated to a division to which you do not have access, then the **Divisions** section is grayed out.

7. Define, edit, or remove eligibility criteria from the price list, if required
8. Define, edit, or remove characteristics of the price list, if required.
9. Click **Save**.

The changes made to the price list are saved.

Related Topics

For more information on...	See...
How to search for a price list	Searching for a Price List on page 849
How to define the price list hierarchy	Defining the Price List Hierarchy on page 853
How to define a characteristic for a price list	Defining a Characteristic for a Price List on page 854
How to associate a price list with a division	Associating a Price List with a Division on page 855
How to define eligibility criteria for the price list	Defining Eligibility Criteria for a Price List on page 856

Price List Price Item Pricing

Once a price list is created, you can either assign a price item to the price list and then define pricing for the price item, or you can copy an existing price item pricing and assign it to the price list. The **Price List Price Item Pricing** screen allows you to:

- View and filter the price items that are assigned to the price list

- Search and assign price items to the price list
- Copy a price item pricing and assign it to the price list



This screen consists of the following zones:

- [Price List Price Items](#) on page 866
- [Search Price Item](#) on page 868

Price List Price Items

The **Price List Price Items** zone lists the price items that are assigned to the price list. You will not find any records in this zone if the price list does not have any price items assigned to it. It contains the following columns:

Column Name	Column Description
Pricing Information	<p>Displays the concatenated string of information about the price item pricing separated by a comma (,).</p> <p>Note: It has a link. On clicking the link, the Price Item Pricing screen appears where you can view the details of the respective price item pricing.</p>
Price Item	Displays the price item or price item bundle.
Pricing Parameters	<p>Displays a comma-separated list of parameter values based on which the pricing is defined for the price item. The order in which the parameter values appear in this column is controlled by the display order (which is defined while associating a parameter with a price item).</p> <p>Note: This column appears when the Multi Price Parameter option type of the Multi Parameter Based Pricing (C1_PPARM_FLG) feature configuration is set to True.</p>
Pricing Status	<p>Indicates the current status of the price item pricing. The valid values are:</p> <ul style="list-style-type: none"> • Active – Indicates that the price assignment is used for billing. • Draft – Indicates that the price assignment is created as a draft. • Inactive – Indicates that the price assignment is no longer used for billing. • Proposed – Indicates that the price assignment is to be used for quotations. • Rejected – Indicates that the price assignment is rejected. • Template – Indicates that the price assignment is a template price list.
Rate Info	<p>Displays the rate of the price item.</p> <p>Note:</p> <p>If the price assignment has only one price component, you can view the rate defined in the pricing directly through the Rate Info column.</p> <p>However, if the price assignment has more than one price components, then the Rate Info column contains a string indicating the tiering type and pricing currency. It also contains “...” which indicates that for more information about the pricing you should navigate to the Price Item Pricing screen.</p>
Effective Start Date	Displays the date from when the price item pricing is effective for the price list.

Column Name	Column Description
Effective End Date	Displays the date till when the price item pricing is effective for the price list.
Price Assignment Type	<p>Indicates the type of price assignment. The valid values are:</p> <ul style="list-style-type: none"> • Post Processing – Indicates that the pricing is used to generate post processing bill segment. This type of price assignment can be done on usage accounts. The post processing bill segment is generated when you generate the bill for the usage account and not when you bill the usage account through an invoice account. • Post Processing – Invoice Based – Indicates that the pricing is used to generate post processing bill segment. This type of price assignment is done on an invoice account, and, as a result, the post processing bill segment is generated on the invoice account. <p>Note: This is not applicable for price items which are defined for Pricing and where the Price Item Type field is set to Fees.</p> <ul style="list-style-type: none"> • Post Processing – Price Item Based – Indicates that the pricing is used to generate post processing bill segment. This type of price assignment is done on both invoice and usage accounts, but the post processing bill segment is generated only on the invoice account. • Regular – Indicates that the pricing is used to generate regular bill segment. <p>Note: This column appears when the Multi Price Parameter option type of the Multi Parameter Based Pricing (C1_PPARM_FLG) feature configuration is set to True.</p>
Edit	On clicking the Edit () icon, you can edit the price item pricing for the price list.
Delete	<p>On clicking the Delete () icon, you can remove the price item pricing from the price list.</p> <p>Note:</p> <p>The Delete icon appears in this column only when the price list is not yet assigned to any account or person.</p> <p>This column appears when the Multi Price Parameter option type of the Multi Parameter Based Pricing (C1_PPARM_FLG) feature configuration is set to False.</p>

You can filter the list using various search criteria (such as, **Price Item** and **Effective Start Date**) available in the **Filter** area. By default, the **Filter** area is hidden. You can view the **Filter** area by clicking the **Filters** () icon in the upper right corner of this zone.

You can change the layout of this zone. For more information on how to change the layout, see [Changing the Layout](#) on page 3414.

Related Topics

For more information on...	See...
How to edit a price item from the price list	Editing a Price Item Pricing of a Price List on page 876

For more information on...	See...
How to remove a price item from the price list	Removing a Price Item from a Price List on page 874

Search Price Item

You can assign a price item or price item bundle to a price list and then define pricing for the price item or price item bundle, or you can copy an existing price item pricing and assign it to a price list. The **Search Price Item** zone allows you to search for a price item pricing which is assigned to an account, person, or a price list. You can then create a new price item pricing using an existing price item pricing through copying the price item pricing. Once you create a copy of an existing price item pricing, the new price item pricing is assigned to the price list. On copying a price item pricing, the pricing details including the price components, eligibility and tiering criteria for each price component, and characteristics are copied to the new price item pricing. You can then edit the details, if required.

The system allows you to create a copy of active, proposed, inactive, rejected, and template price item pricing. Once you create the copy of a template price item pricing, you can save the new price item pricing in either **Active** or **Proposed** status.

The **Search Price Item** zone contains the following two sections:

- **Search Criteria** – The **Search Criteria** section contains the following fields:

Field Name	Field Description	Mandatory (Yes or No)
Search By	Used to indicate whether you want to search price item, pricing assigned to price list and override pricing for an account, or person. The valid values are: <ul style="list-style-type: none"> • Price Item • Price list Pricing • Account Override Pricing • Person Override Pricing 	Yes
Price Item	Used to search a particular price item or price item bundle.	No
Description	Used to search price items or price item bundles with a particular description. Note: This field appears when you select the Price Item option from the Search By list.	No
Global Price List	Used to search price items or price item bundles which can be assigned to a global price list. The valid values are: <ul style="list-style-type: none"> • Yes • No 	No
Bundle	Used to indicate whether you want to search for price item bundles. The valid values are: <ul style="list-style-type: none"> • Yes • No 	No

Field Name	Field Description	Mandatory (Yes or No)
Price List ID	Used to search pricing of price items or price item bundles which are assigned to a particular price list.	No
	Note: This field appears when you select the Price List Pricing option from the Search By list.	
Effective Start Date	Used to search price item pricing on price lists which are effective from a particular date onwards.	No
	Note: This field appears when you select the Price List Pricing, Account Override Pricing, or Person Override Pricing option from the Search By list.	
Effective End Date	Used to search price item pricing on price lists which are effective till a particular date.	No
	Note: This field appears when you select the Price List Pricing, Account Override Pricing, or Person Override Pricing option from the Search By list.	
Pricing Status	Used to search price item pricing with a particular status. The valid values are: <ul style="list-style-type: none"> • Active • Inactive • Proposed • Rejected • Template 	No
	Note: This field appears when you select the Price List Pricing, Account Override Pricing, or Person Override Pricing option from the Search By list.	
Price Assignment Type	Used to search a particular type of the price item pricing. The valid values are: <ul style="list-style-type: none"> • Regular • Post Processing • Post Processing – Invoice Based • Post Processing – Price Item Based 	No
	Note: This field appears when you select the Price List Pricing, Account Override Pricing, or Person Override Pricing option from the Search By list.	

Field Name	Field Description	Mandatory (Yes or No)
Account ID	Used to search pricing of price items or price item bundles which are assigned to a particular account.	Yes
	Note: This field appears when you select the Account Override Pricing option from the Search By list.	
Person ID	Used to search pricing of price items or price item bundles which are assigned to a particular person.	Yes
	Note: This field appears when you select the Person Override Pricing option from the Search By list.	

Note:
 You must specify at least one search criterion while searching for a price item or price item bundle.
 You can search for an account, person by clicking the **Search** (🔍) icon corresponding to the respective field.

- **Search Results** – On clicking the **Search** button, the search results appear based on the specified search criteria. The search results include only those price items or price item bundles that are associated with the division to which the price list belongs. It may also include price items or price item bundles that are already assigned to the price list in case those price items or price item bundles match the search criteria.

The **Search Results** section contains the following columns:

Column Name	Column Description
Assign	On clicking the Assign (📄) icon, the Price Item Pricing screen appears where you can define a new price item pricing.
Price Item Information	Displays details of the price item or price item bundle.
	Note: It has a link. On clicking the link, the Price Item screen appears where you can view the details of the respective price item or price item bundle.
Copy	On clicking the Copy (📄) icon, the Price Item Pricing screen appears where you can define a new price item pricing using an existing price item pricing.
Pricing Information	Displays details of the price item pricing.
	Note: It has a link. On clicking the link, the View Price Item Pricing window appears with the details of the respective price item pricing.

Column Name	Column Description
Account Information	<p data-bbox="570 207 1463 302">Indicates the account to which the price item pricing is assigned. In addition, this column has a context menu which helps in navigating to other screens in the application.</p> <p data-bbox="570 327 1463 632">Note: This column appears when you select the Account Override Pricing option from the Search By list. It has a link. On clicking the link, the Account screen appears where you can view the details of the respective account. The account information string appears when an algorithm defined using the C1-AC-INFO algorithm type is attached to the Account Information system event in the Algorithms tab of the Installation Options – Framework screen.</p>
Person Information	<p data-bbox="570 684 1463 779">Indicates the person to which the price item pricing is assigned. In addition, this column has a context menu which helps in navigating to other screens in the application.</p> <p data-bbox="570 804 1463 1108">Note: This column appears only when you select the Person Override Pricing option from the Search By list. It has a link. On clicking the link, the Person screen appears where you can view the details of the respective person. The person information string appears when an algorithm defined using the PERS-INFO algorithm type is attached to the Person Information system event in the Algorithms tab of the Installation Options – Framework screen.</p>
Price List Information	<p data-bbox="570 1161 1463 1255">Indicates the price list to which the price item pricing is assigned. In addition, this column has a context menu which helps in navigating to other screens in the application.</p> <p data-bbox="570 1281 1463 1480">Note: This column appears when you select the Price List Pricing option from the Search By list. It has a link. On clicking the link, the Price List screen appears where you can view the details of the respective person.</p>
Variance Parameter	<p data-bbox="570 1528 1463 1560">Indicates the variance parameter which is used for defining the price item pricing.</p> <p data-bbox="570 1585 1463 1680">Note: This column appears when the Multi Price Parameter option type of the Multi Parameter Based Pricing (C1_PPARM_FLG) feature configuration is set to False.</p>

Column Name	Column Description
Pricing Parameters	Displays a comma-separated list of parameter values. The order in which parameter values appear in this column is controlled by the display order (which is defined while associating a parameter with a price item or price item bundle).
	Note: This column appears when the Multi Price Parameter option type of the Multi Parameter Based Pricing (C1_PPARM_FLG) feature configuration is set to True .
Effective Start Date	Displays the date from when the price item pricing is effective.
Effective End Date	Displays the date till when the price item pricing is effective.
Pricing Currency	Indicates the currency in which the price item pricing is defined.
Pricing Status	Indicates the status of the price item pricing. The valid values are: <ul style="list-style-type: none"> • Active • Inactive • Proposed • Rejected • Template
Rate Schedule	Indicates the rate schedule which is used for defining the price item pricing.
Price Assignment Usage	Indicates whether the price item pricing is applicable to all customers or only to new customers. The valid values are: <ul style="list-style-type: none"> • AC • NC
Price Assignment Type	Indicates the type of the price item pricing. The valid values are: <ul style="list-style-type: none"> • Regular • Post Processing • Post Processing – Invoice Based • Post Processing – Price Item Based
	Note: This column appears when the Multi Price Parameter option type of the Multi Parameter Based Pricing (C1_PPARM_FLG) feature configuration is set to False .
Price Item	Displays the price item or price item bundle code.
	Note: It has a link. On clicking the link, the Price Item Pricing screen appears where you can define the pricing for the respective price item or price item bundle.
Description	Displays the description of the price item or price item bundle.
Global Price List	Indicates whether the price item or price item bundle can be assigned to a global price list. The valid values are: <ul style="list-style-type: none"> • Y • N

Column Name	Column Description
Unit of Measure	Indicates the unit of measure associated with the price item or price item bundle.
Bundle	Indicates whether the price item is a bundle or not. The valid values are: <ul style="list-style-type: none"> • Y • N
Owner ID	Displays the ID of the person for whose account the price list is created.
Party ID	Displays the third party ID.
Price List ID	Indicates the price list to which the price item pricing is assigned. Note: This column appears when you select the Price List Pricing option from the Search By list.
Price Assignment ID	Displays the price assignment ID.
Price Assignment Owner Type Flag	Displays whether price list or party is the owner of the price assignment.
Bundle Type	Indicates the type of the price item bundle. If the price item bundle is available for pricing and billing, the valid values are: <ul style="list-style-type: none"> • Phantom • Ratio • Regular However, if the price item bundle is available for only pricing and the price item type is Fees then the valid value is Regular . Note: This column appears when you select the Yes option from the Bundle list.
Price Item Type	Indicates the type of the price item or price item bundle. The valid values are: <ul style="list-style-type: none"> • Rate • Fees

Related Topics

For more information on...	See...
How to view price item pricing	View Price Item Pricing
How to assign a price item to a price list	Assigning a Price Item to a Price List
Price Item Pricing window	Price Item Pricing
How to copy a price item pricing and assign it to a price list	Copying a Price Item Pricing
How to view price items assigned to a price list	Viewing Price Items Assigned to a Price List on page 873

Viewing Price Items Assigned to a Price List

Procedure

To view price items assigned to a price list:

1. Search for the price list in the **Price List** screen.

2. In the **Search Results** section, click the **View** () icon from the **Price Item Pricing** column corresponding to the price list whose price items you want to view.

The **Price List Price Item Pricing** screen appears.

3. View the price items that are assigned to the price list in the **Price List Price Items** zone.



Related Topics

For more information on...	See...
How to search for a price list	Searching for a Price List on page 849
Price List Price Item Pricing screen	Price List Price Item Pricing on page 865
Price List Price Items zone	Price List Price Items on page 866

Removing a Price Item from a Price List

Procedure

To remove a price item from a price list:

1. Search for the price list in the **Price List** screen.
2. In the **Search Results** section, click the **View** () icon corresponding to the price list from which you want to remove a price item.
The **Price List Price Item Pricing** screen appears.
3. Filter the list in the **Price List Price Items** zone, if required.
4. Click the **Delete** () icon in the **Delete** column corresponding to the price item that you want to remove from the price list.

A message appears confirming whether you want to remove the price item from the price list.

Note: The **Delete** icon appears in the **Delete** column when the price list is not yet assigned to any account or person.

5. Click **OK**.

The price item is removed from the price list.

Related Topics

For more information on...	See...
How to search for a price list	Searching for a Price List on page 849



Viewing a Price Item Pricing

Procedure

To view a price item pricing and assignment details:

1. Do either of the following:

If you want to view...	Then...
Price Item Pricing of a Price List from the Price List Price Item Pricing screen	<ol style="list-style-type: none"> 1. Search for the price list in the Price List screen.

If you want to view...	Then...
	<ol style="list-style-type: none"> 2. In the Search Results section, click the View () icon corresponding to the price list whose details you want to view. The Price List Price Item Pricing screen appears. 3. Price assignments effective for the price list appears in the Price List Price Item zone. 4. Click the link in the Pricing Information column corresponding to the price list whose pricing details you want to view.
Price Item Pricing of a Price List from the Price List screen	<ol style="list-style-type: none"> 1. . Search for the price list in the Price List screen. 2. In the Search Results section, click the Broadcast () icon corresponding to the price list whose price item pricing you want to view. The Price List Price Item zone appears. 3. Click the link in the Pricing Information column corresponding to the price item whose price item pricing you want to view. <p>Tip: Alternatively, you can click on the Broadcast () icon corresponding to the price list whose price item pricing you want to view. The Price Item Pricing zone appears in the Price List screen.</p>

The **Price Item Pricing** screen appears. It contains the following zones:

- **Price Item Pricing Information** – Displays the price item pricing details. It contains the following sections:
 - **Main** – Displays the pricing information of the price item.
 - **Deal Information**
 - **TFM Information** – Displays the transaction feed management information of the price item.
 - **Characteristics** – Displays the details of price item pricing characteristics.
 - **Price Item and Parameter Information** – Displays the price item parameter details.
 - **Division-Specific Average Price Floor and Ceil Values** – Displays the floor and ceil values of a price item.
 - **Division-Specific SQIs for Price Item** – Displays the details of the SQIs associated with the price item.
 - **Division-Specific Cost for Price Item** – Displays the details of the costs associated with the price item.

- **Division-Specific Negotiability Floor and Ceil Values for Price Item** – Displays the negotiability floor and ceil values of a price item.
 - **Record Actions** – Displays the record actions of the price item pricing.
 - **Record Information** – Displays the record information of the price item pricing.
 - **Pricing Structure** – Displays the details of the rate and price component of the price item.
2. View the basic details of price item pricing in the **Price Item Pricing** zone.
 3. View the rate and price component details of price item in the **Pricing Structure** zone.
 4. View the tiering criteria of price item pricing in the **Pricing Structure** zone.
 5. View the pricing eligibility criteria of price item pricing in the **Pricing Structure** zone.

Note: You can define, edit, copy, or delete the pricing price components of a rate component when the price item pricing status is **Draft, Proposed, or Template**.

Related Topics

For more information on...	See...
How to search for a price list	Searching for a Price List on page 849
Price List Price Item Pricing screen	Price List Price Item Pricing on page 865
Price List Price Items zone	Price List Price Items on page 848
Price Item Pricing screen	Price Item Pricing (Used for Viewing)
Price Item Pricing zone	Price Item Pricing
Rate and Price Component Summary zone	Rate and Price Component Summary
Rate Components zone	Rate Components
Price Components zone	Price Components
Tiering Criteria zone	Tiering Criteria
Pricing Eligibility Criteria zone	Pricing Eligibility Criteria

Editing a Price Item Pricing of a Price List

Prerequisites

To edit a price item pricing of a price list, you should have:



- Transactions mapped to the price item defined in the application
- Rate schedules, rate versions, rate components defined in the application
- Parameters associated with the price item (in case you want to define price item pricing based on those parameters)

Procedure

To edit a price item pricing of a price list:

1. Do either of the following:

If you want to...	Then...
Edit pricing of a price item that is assigned to a price list from Price List screen	<ol style="list-style-type: none"> 1. Search for the price list in the Price List screen. 2. In the Search Results section of Price List Price Items zone, click the link in the Pricing

If you want to...	Then...
	<p>Information column corresponding to the price item whose pricing details you want to view.</p> <p>The Price Item Pricing screen appears.</p> <p>3. Click the Edit button in the Record Actions section.</p> <p>The Price Item Pricing screen appears to edit the pricing details of a price item.</p> <div style="border: 1px solid black; padding: 5px;"> <p>Note: The Edit button appears when the price item pricing is in the Draft status.</p> </div>
<p>Edit pricing of a price item that is assigned to a price list from Price List Price Item Pricing screen</p>	<p>1. Search for the price list in the Price List screen.</p> <p>In the Search Results section, click the Price List Pricing () icon corresponding to the price list whose <i>details</i> you want to view.</p> <p>The Price List Price Item Pricing screen appears.</p> <p>2. Price items assigned to the price list appears in the Price List Price Items zone.</p> <p>3. You can edit the pricing item pricing through the following alternatives:</p> <p>a. First alternative,</p> <ul style="list-style-type: none"> • In the Search Results section of Price List Price Items zone, click the Edit () icon in the Edit column corresponding to the price item pricing whose details you want to edit. <p>The Price Item Pricing screen appears to edit the pricing details of a price item.</p> <p>b. Second alternative,</p> <ul style="list-style-type: none"> • Search for a price item in the Search Price Item or Price Item Pricing zone. <p>In the Search Results section, click the Assign () icon corresponding to the price item.</p> <ul style="list-style-type: none"> • Enter the required details in the Price Item Pricing screen and click Save. <p>The Price Item Pricing screen appears.</p>

If you want to...	Then...
	<ul style="list-style-type: none"> Click the Edit button in the Record Actions section. <p>The Price Item Pricing screen appears to edit the pricing details of a price item.</p> <div style="border: 1px solid black; padding: 5px;"> <p>Note: The Edit button appears when the price item pricing is in the Draft status.</p> </div>

The **Price Item Pricing** screen appears. It contains the following sections:

- Main** – Used to specify basic details about the price item pricing.
- Deal Information** – Used to indicate the average price floor and ceil type to define the floor and ceil limits for the price item or price item bundle
- TFM Information** – Used to specify the transaction feed management information about the price item pricing.

Note: This section appears in the **Price Item Pricing** screen when the value for the **Show Default Values in Price Item Pricing** option type for **C1_FM** feature configuration is set to **Y** and **Price Item Available For** is **Pricing and Billing**.

- Characteristics** – Used to define the characteristics for the price item pricing.
- Price Item and Parameter Information** – Used to define the parameter details segment for the price item pricing.

Note: This section appears when **Price Assignment Type** is **Regular**.

- Commitments** – Used to indicate the basic details about the pricing and commitments such as costs, floor and ceil limits, and negotiability specific to a division.

The **Main** section contains the following fields:

Field Name	Field Description	Mandatory (Yes or No)
Start Date	<p>Used to specify the date from when the price item pricing is effective.</p> <div style="border: 1px solid black; padding: 5px;"> <p>Note:</p> <p>The effective start date cannot be later than the effective end date.</p> <p>If you change the effective start and end dates while editing a price item pricing, you need to specify the parameters which are effective during that date range.</p> <p>This field will be in read-only mode when the price assignment has been used.</p> </div>	Yes

Field Name	Field Description	Mandatory (Yes or No)
End Date	Used to specify the date till when the price item pricing is effective.	No
	Note: The effective end date cannot be earlier than the effective start date.	
Price Assignment Type	<p>Used to indicate the type of price assignment. The valid values are:</p> <ul style="list-style-type: none"> • Regular – Used to indicate that the pricing must be used to generate regular bill segment. • Post Processing – Used to indicate that the pricing must be used to generate post processing bill segment. This type of price assignment can be done on usage accounts. The post processing bill segment is generated when you generate the bill for the usage account and not when you bill the usage account through an invoice account. <p>Note:</p> <p>The post processing bill segment is generated when the Post Processing Sequence (PPSEQ) characteristic is defined for the price item and when the price item is associated with another price item using the Price Item relationship type.</p> <ul style="list-style-type: none"> • Post Processing – Invoice Based – Used to indicate that the pricing must be used to generate post processing bill segment. This type of price assignment can be done on an invoice account, and, as a result, the post processing bill segment is generated on the invoice account. <p>Note: This will not be applicable for price item which are defined for Only Pricing.</p> <ul style="list-style-type: none"> • Post Processing – Price Item Based – Used to indicate that the pricing must be used to generate post processing bill segment. This type of price assignment can be done on both invoice and usage accounts, but the post processing bill segment is generated only on the invoice account. <p>Note: This will not be applicable for price item which are defined for Only Pricing.</p>	Yes
Pricing Eligibility	Used to select pricing eligibility criteria for price item pricing.	No
	Note: This field will be enabled for selection if the checkbox is not selected. If the checkbox appears selected then this field will be in read-only mode.	

Field Name	Field Description	Mandatory (Yes or No)
Pricing Status	<p>Used to indicate the status of the price assignment. The valid values are:</p> <ul style="list-style-type: none"> • Draft – Indicates that the price assignment is created as a draft. • Active – Indicates that the price assignment is used for billing. • Inactive – Indicates that the price assignment is no longer used for billing. • Proposed – Indicates that the price assignment is to be used for quotations. • Template – Indicates that the price assignment is a template price list. <p>Note: If a price assignment is in Active status, you can change its status to Inactive. If a price assignment is in Draft status, you cannot change its status to Proposed.</p>	Yes
Pricing Currency	Used to indicate the currency in which you want to define the price item pricing.	Yes
Rate Schedule	<p>Used to specify the rate schedule that you want to use while defining price item pricing.</p> <p>Note: Rate schedules control how the bills for the price item will be calculated.</p> <p>The Search (🔍) icon appears corresponding to this field. On clicking the Search icon, the Rate Schedule Search screen appears.</p>	Yes
Pricing Rule Type	<p>Used to indicate the pricing rule type. The valid value is:</p> <ul style="list-style-type: none"> • Two-Dimensional 	<p>Yes (Conditional)</p> <p>Note: This field is required when you are editing a two-dimensional pricing rule.</p>
Print Zero	<p>Used to indicate whether zero pricing should be displayed in the bill. The valid values are:</p> <ul style="list-style-type: none"> • Yes • No <p>Note: By default, Yes is selected.</p>	Yes

Field Name	Field Description	Mandatory (Yes or No)
Price Assignment Usage	Used to indicate whether the price item pricing is applicable to all customers or only to new customers. The valid values are: <ul style="list-style-type: none"> All Customers New Customers 	Yes
Pricing Frequency	Used to indicate pricing frequency for the price item.	Yes
	Note: This field appears when Price Item is defined as Only Pricing and Price Item Type is defined as Fees .	

2. Modify the details in the **Main** section, if required.
3. Edit the deal information in a price item pricing, if required.
4. Edit the TFM information in a price item pricing, if required.
5. Edit the characteristics for a price item pricing, if required.
6. Edit the parameters for a price item pricing, if required.
7. Edit the pricing commitments, if required.
8. Click **Save**.

The changes made to the price item pricing are saved.

Related Topics

For more information on...	See...
Price List Price Item Pricing screen	Price List Price Item Pricing on page 865
Price List Price Items zone	Price List Price Items on page 848
How to search for a price list	Searching for a Price List on page 849
How to define a price item pricing.	Defining a Price Item Pricing
How to define a characteristic for a price item pricing.	Defining a Characteristic for a Price Item Pricing on page 888
How to define parameters for a price item pricing.	Defining Parameters for a Price Item Pricing on page 889
How to define TFM Information in a price item pricing.	Defining TFM Information in a Price Item Pricing on page 890
How to define deal information in a price item pricing	Defining the Deal Information in a Price Item Pricing
How to define average price floor and ceil limits for a division in a price item pricing	Defining the Average Price Floor and Ceil Values of a Price Item or Price Item Bundle for a Division on page 812
How to define negotiability floor and ceil limits for a division in a price item pricing	Defining the Rate Negotiability Floor and Ceil Values of a Price Item or Price Item Bundle for a Division
How to define cost of a price item for a division in a price item pricing	Defining the Cost of a Price Item or Price Item Bundle for a Division on page 809

Assigning a Price Item to a Price List

Prerequisites



To assign a price item to a price list, you should have:

- Transactions mapped to the price item defined in the application
- Rate schedules, rate versions, and rate components defined in the application
- Parameters associated with the price item (in case you want to define price item pricing based on multiple parameters)

Procedure

To assign a price item to a price list:

1. Do either of the following:

If you want to...	Then...
Define pricing of a price item that is assigned to a price list from Price List screen	<ol style="list-style-type: none"> 1. Search for the price list in the Price List screen. 2. In the Search Results section of Price List Price Items zone, click the link in the Pricing Information column corresponding to the price item whose pricing details you want to view. The Price Item Pricing screen appears. 3. Click the Edit button in the Record Actions section. The Price Item Pricing screen appears to edit the pricing details of a price item. <div style="border: 1px solid black; padding: 5px; margin-top: 10px;"> <p>Note: The Edit button appears when the price item pricing is in the Draft status.</p> </div>
Define pricing of a price item that is assigned to a price list from Price List Price Item Pricing screen	<ol style="list-style-type: none"> 1. Search for the price list in the Price List screen. In the Search Results section, click the Price List Pricing () icon corresponding to the price list whose <i>details</i> you want to view. The Price List Price Item Pricing screen appears. 2. Price items assigned to the price list appears in the Price List Price Items zone. 3. You can edit the pricing item pricing through the following alternatives: <ol style="list-style-type: none"> a. First alternative, <ul style="list-style-type: none"> • In the Search Results section of Price List Price Items zone, click the Edit () icon in the Edit column corresponding to the price item pricing whose details you want to edit.

If you want to...	Then...
	<p>The Price Item Pricing screen appears to edit the pricing details of a price item.</p> <p>b. Second alternative,</p> <ul style="list-style-type: none"> • Search for a price item in the Search Price Item or Price Item Pricing zone. <p>In the Search Results section, click the Assign  icon corresponding to the price item.</p> <ul style="list-style-type: none"> • Enter the required details in the Price Item Pricing screen and click Save. <p>The Price Item Pricing screen appears.</p> <ul style="list-style-type: none"> • Click the Edit button in the Record Actions section. <p>The Price Item Pricing screen appears to edit the pricing details of a price item.</p> <div data-bbox="1003 995 1399 1108" style="border: 1px solid black; padding: 5px;"> <p>Note: The Edit button appears when the price item pricing is in the Draft status.</p> </div>

The **Price Item Pricing** screen appears. It contains the following sections:

- **Main** – Used to specify basic details about the price item pricing.
- **Deal Information** – Used to indicate the average price floor and ceil type to define the floor and ceil limits for the price item or price item bundle
- **TFM Information** – Used to specify the transaction feed management information about the price item pricing.

Note: This section appears in the **Price Item Pricing** screen when the value for the **Show Default Values in Price Item Pricing** option type for **C1_FM** feature configuration is set to **Y** and **Price Item Available For** is **Pricing and Billing**.

- **Characteristics** – Used to define the characteristics for the price item pricing.
- **Price Item and Parameter Information** – Used to define the parameter details segment for the price item pricing.

Note: This section appears when **Price Assignment Type** is **Regular**.

- **Commitments** – Used to indicate the basic details about the pricing and commitments such as costs, floor and ceil limits, and negotiability specific to a division.

The **Main** section contains the following fields:

Field Name	Field Description	Mandatory (Yes or No)
Start Date	Used to specify the date from when the price item pricing is effective.	Yes
	<p>Note:</p> <p>The effective start date cannot be later than the effective end date.</p> <p>If you change the effective start and end dates while editing a price item pricing, you need to specify the parameters which are effective during that date range.</p> <p>This field will be in read-only mode when the price assignment has been used.</p>	
End Date	Used to specify the date till when the price item pricing is effective.	No
	<p>Note: The effective end date cannot be earlier than the effective start date.</p>	

Field Name	Field Description	Mandatory (Yes or No)
Price Assignment Type	<p>Used to indicate the type of price assignment. The valid values are:</p> <ul style="list-style-type: none"> • Regular – Used to indicate that the pricing must be used to generate regular bill segment. • Post Processing – Used to indicate that the pricing must be used to generate post processing bill segment. This type of price assignment can be done on usage accounts. The post processing bill segment is generated when you generate the bill for the usage account and not when you bill the usage account through an invoice account. <div data-bbox="607 642 1203 884" style="border: 1px solid black; padding: 5px;"> <p>Note: The post processing bill segment is generated when the Post Processing Sequence (PPSEQ) characteristic is defined for the price item and when the price item is associated with another price item using the Price Item relationship type.</p> </div> <ul style="list-style-type: none"> • Post Processing – Invoice Based – Used to indicate that the pricing must be used to generate post processing bill segment. This type of price assignment can be done on an invoice account, and, as a result, the post processing bill segment is generated on the invoice account. <div data-bbox="607 1108 1203 1192" style="border: 1px solid black; padding: 5px;"> <p>Note: This will not be applicable for price item which are defined for Only Pricing.</p> </div> <ul style="list-style-type: none"> • Post Processing – Price Item Based – Used to indicate that the pricing must be used to generate post processing bill segment. This type of price assignment can be done on both invoice and usage accounts, but the post processing bill segment is generated only on the invoice account. <div data-bbox="607 1417 1203 1501" style="border: 1px solid black; padding: 5px;"> <p>Note: This will not be applicable for price item which are defined for Only Pricing.</p> </div>	Yes
Pricing Eligibility	<p>Used to select pricing eligibility criteria for price item pricing.</p> <div data-bbox="545 1577 1203 1692" style="border: 1px solid black; padding: 5px;"> <p>Note: This field will be enabled for selection if the checkbox is not selected. If the checkbox appears selected then this field will be in read-only mode.</p> </div>	No

Field Name	Field Description	Mandatory (Yes or No)
Pricing Status	<p>Used to indicate the status of the price assignment. The valid values are:</p> <ul style="list-style-type: none"> • Draft – Indicates that the price assignment is created as a draft. • Active – Indicates that the price assignment is used for billing. • Inactive – Indicates that the price assignment is no longer used for billing. • Proposed – Indicates that the price assignment is to be used for quotations. • Template – Indicates that the price assignment is a template price list. <p>Note: If a price assignment is in Active status, you can change its status to Inactive. If a price assignment is in Draft status, you cannot change its status to Proposed.</p>	Yes
Pricing Currency	Used to indicate the currency in which you want to define the price item pricing.	Yes
Rate Schedule	<p>Used to specify the rate schedule that you want to use while defining price item pricing.</p> <p>Note: Rate schedules control how the bills for the price item will be calculated.</p> <p>The Search (🔍) icon appears corresponding to this field. On clicking the Search icon, the Rate Schedule Search screen appears.</p>	Yes
Pricing Rule Type	<p>Used to indicate the pricing rule type. The valid value is:</p> <ul style="list-style-type: none"> • Two-Dimensional 	<p>Yes (Conditional)</p> <p>Note: This field is required when you are editing a two-dimensional pricing rule.</p>
Print Zero	<p>Used to indicate whether zero pricing should be displayed in the bill. The valid values are:</p> <ul style="list-style-type: none"> • Yes • No <p>Note: By default, Yes is selected.</p>	Yes

Field Name	Field Description	Mandatory (Yes or No)
Price Assignment Usage	Used to indicate whether the price item pricing is applicable to all customers or only to new customers. The valid values are: <ul style="list-style-type: none"> All Customers New Customers 	Yes
Pricing Frequency	Used to indicate pricing frequency for the price item.	Yes
	Note: This field appears when Price Item is defined as Only Pricing and Price Item Type is defined as Fees .	

- Define the details in the **Main** section.
- Define the deal information in a price item pricing.
- Define the TFM information in a price item pricing.
- Define the characteristics for a price item pricing.
- Define the parameters for a price item pricing.
- Select the required division from the **Commitments** section to define the commitments of a price item pricing.
- Define the cost of the price item or price item bundle for the required divisions
- Define the average price floor and ceil limits of the price item or price item bundle for the required divisions.
- Define the negotiability floor and ceil values of the price item or price item bundle for the required divisions
- Click **Save**.

The pricing is defined for a price item.

Related Topics

For more information on...	See...
Price List Price Item Pricing screen	Price List Price Item Pricing on page 865
Search Price Item or Price Item Pricing zone	Search Price Item on page 868
How to search for an person	Searching for a Price List on page 849
How to define a characteristic for a price item pricing.	Defining a Characteristic for a Price Item Pricing on page 888
How to define parameters for a price item pricing.	Defining Parameters for a Price Item Pricing on page 889
How to define deal Information in a price item pricing.	Defining the Deal Information in a Price Item Pricing
How to define TFM Information in a price item pricing.	Defining TFM Information in a Price Item Pricing on page 890
How to define average floor and ceil limits for a division in a price item pricing.	Defining the Average Price Floor and Ceil Values of a Price Item or Price Item Bundle for a Division on page 812
How to define cost of a price item for a division in a price item pricing.	Defining the Cost of a Price Item or Price Item Bundle for a Division on page 809
How to define negotiability floor and ceil limits for a division in a price item pricing.	Defining the Rate Negotiability Floor and Ceil Values of a Price Item or Price Item Bundle for a Division

Defining a Characteristic for a Price Item Pricing

Prerequisites

To define a characteristic for a price item pricing, you should have:

- Characteristic types defined in the application (where the characteristic entity is set to **Price Item**)

Procedure

To define a characteristic for a price item pricing that is assigned to an account:

1. Ensure that the **Characteristics** section is expanded when you are defining a price item pricing.

The **Characteristics** section contains the following columns:

Column Name	Column Description	Mandatory (Yes or No)
Effective Date	Used to specify the date from when the characteristic is effective for the price item pricing.	Yes (Conditional) Note: This field is required when you are defining a characteristic for the price item pricing.
Characteristic Type	Used to indicate the characteristic type. Note: The list includes only those characteristic types where the characteristic entity is set to Price Item Pricing .	Yes (Conditional) Note: This field is required when you are defining a characteristic for the price item pricing.
Characteristic Value	Used to specify the value for the characteristic type. Note: If you select a predefined characteristic type, the Search (🔍) icon appears corresponding to the Characteristic Value field. On clicking the Search icon, the Predefined Characteristic Search window appears. On specifying the value for a predefined characteristic type, the description of the characteristic value appears corresponding to the Characteristic Value field.	Yes (Conditional) Note: This field is required when you are defining a characteristic for the price item pricing.

2. Enter the required details in the **Characteristics** section.
3. If you want to define more than one characteristic for the price item pricing, click the **Add** (+) icon and then repeat step 2.

Note: However, if you want to remove a characteristic from the price item pricing, click the **Delete** (🗑️) icon corresponding to the characteristic.

4. Click **Save**.

The characteristics are defined for the price item pricing.

Related Topics

For more information on...	See...
How to define a price item pricing	Defining a Price Item Pricing
How to edit a price item pricing	Editing a Price Item Pricing
How to override a price item pricing	Overriding a Price Item Pricing

Defining Parameters for a Price Item Pricing

Prerequisites

To define parameters for a price item pricing, you should have:

- Parameters associated with the price item, in case, you want to define price item pricing based on multiple parameters

Procedure

To define parameter details segment for a price item pricing that is assigned to an account:

1. Ensure that the **Price Item and Parameter Information** section is expanded when you are defining a price item pricing.

The **Price Item and Parameter Information** section contains the following field:

Field Name	Field Description
Price Item	Indicates the price item or price item bundle whose pricing details are listed in this section.

In addition, this section contains a grid which has the following columns:

Column Name	Column Description	Mandatory (Yes or No)
Parameter	Used to indicate the parameter that you want to associate with the price item pricing. Note: The Search (🔍) icon appears corresponding to this field. On clicking the Search icon, the Price Item Parameter Search window appears. The parameter search results displays only those parameters where the Price Item check box is selected.	Yes
Parameter Information	Displays a comma-separated string which contains of the following: <ul style="list-style-type: none"> Parameter Description Mandatory (Yes or No) Priority 	Not applicable
Parameter Value	Used to specify the value of the parameter.	Yes

2. Enter the required details in the **Price Item and Parameter Information** section.
3. If you want to define more than one parameter information for the price item pricing, click the **Add** (+) icon and then repeat step 2.

Note: However, if you want to remove a parameter information from the price item pricing, click the **Delete** (🗑️) icon corresponding to the parameter.

4. Click **Save**.

The parameters are defined for the price item pricing.

Related Topics

For more information on...	See...
How to define a price item pricing	Defining a Price Item Pricing
How to edit a price item pricing	Editing a Price Item Pricing
How to override a price item pricing	Overriding a Price Item Pricing

Defining TFM Information in a Price Item Pricing

Prerequisites

To define the TFM information in a price item pricing, you should have:

- Transactions mapped to the price item defined in the application
- Aggregation or Rating Criteria data to be defined for the price item pricing

Procedure

To define the TFM information in a price item pricing:

1. Ensure that the **TFM Information** section is expanded when you are defining a price item pricing.

The **TFM Information** section contains the following fields:

Field Name	Field Description	Mandatory (Yes or No)
Ignore Transaction	Used to indicate whether the transactions mapped to the price item is considered for billing. The valid values are: <ul style="list-style-type: none"> • Yes • No 	Yes
Aggregate Transactions	Used to indicate whether the transactions mapped to the price item is aggregated for billing. The valid values are: <ul style="list-style-type: none"> • Yes • No 	Yes
Aggregation Schedule	Used to indicate the transaction aggregation cycle. The valid values are: <ul style="list-style-type: none"> • Daily • Weekly • Monthly • Quaterly • Yearly 	Yes

Field Name	Field Description	Mandatory (Yes or No)
Transaction Rating Criteria	Used to indicate how and when the transaction legs mapped to the price item are rated. The valid values are: <ul style="list-style-type: none"> Aggregate Transactions and Then Rate Aggregated SQs Do Not Rate Transactions Rate Transaction and Aggregate Calc Lines Across Transaction 	Yes

- Enter the required details in the **TFM Information** section.

Note: **TFM Information** section appears when the value for **Show Default Values in Price Item Pricing** option type of **C1_FM feature configuration** is set to **Y** and **Price Item Available For** is **Pricing and Billing**.

- Click **Save**.

The transactions are defined for the price item pricing.

Related Topics

For more information on...	See...
How to define a price item pricing for an account	Assigning a Price Item to an Account
How to edit a price item pricing for an account	Editing a Price Item Pricing of an Account
How to override a price item pricing for an account	Overriding a Price Item Pricing of an Account
How to define a price item pricing for a person	Assigning a Price Item to a Person
How to edit a price item pricing for a person	Editing a Price Item Pricing of a Person
How to override a price item pricing for a person	Overriding a Price Item Pricing of a Person
How to define a price item pricing for a price list	Assigning a Price Item to a Price List on page 881
How to edit a price item pricing for a price list	Editing a Price Item Pricing of a Price List on page 876

Price List Assignment

Once a price list is defined, you can assign it to accounts or persons to indicate the prices that will be charged for the price items or services offered to the accounts or persons. You can assign multiple price lists to an account or a person along with the priority or order in which the pricing should be considered. You can also define whether the account or person can avail the price item pricing listed on the parent or grandparent price list if it is not available on the assigned price list. In other words, you can define whether the account or person can inherit the price item pricing from the price list hierarchy.

For example, suppose you have PL1 (with priority 10) and PL2 (with priority 20) assigned to an account or a person. While determining pricing for a price item, the system will search for the price item pricing in PL1. If the system does not find the price item pricing in PL1, it will search for the price item pricing in PL2. The system will behave in this manner when the price list inheritance for PL1 is set to **No** during the price list assignment.

If the price list inheritance while assigning PL1 and PL2 to an account or a person is set to **Yes**, the system will search for the price item pricing in PL1. If the system does not find the price item pricing in PL1, it will search for the price item pricing from the price list hierarchy defined for PL1. However, if the system does not find the price item pricing from the price list hierarchy of PL1, it will then search for the price item pricing in PL2 (assigned to the account or person with priority 20). If the system still does not find the price item pricing in PL2, it will search for the price item pricing from the price list hierarchy defined for PL2.

The **Price List Assignment** screen allows you to search and assign a price list to an account or a person. It also allows you to view the price lists that are already assigned to an account or a person. It contains the following zones:

- [Price List Assignments](#) on page 892
- [Price List Price Items](#) on page 894
- [Search Price List for Assignment](#)

Price List Assignments

The **Price List Assignments** zone allows you to view and filter price lists that are currently assigned to the account or person. You can also search for the price lists assigned to the account or person which are either inactive or expired. You will not find any records in this zone if the account does not have any price lists assigned to it. It contains the following two sections:

- **Search Criteria** - The **Search Criteria** section contains the following fields:

Field Name	Field Description	Mandatory (Yes or No)
Search By	Used to indicate whether you want to search for the current, inactive, or historical price list assignments. The valid values are: <ul style="list-style-type: none"> • Current Price List Assignments • Inactive Price List Assignments • Historical Price List Assignments 	Yes
	Note: By default, the Current Price List Assignments option is selected.	
Price List ID	Used to search a particular price list assigned to an account or a person.	No
	Note: The Search (🔍) icon appears corresponding to the Price List ID field. On clicking the Search icon, the Price List Search window appears.	
Price List Description	Used to search price lists which are assigned to the account or person having a particular description.	No
Effective Start Date	Used to search price lists which are assigned to the account or person from a particular date.	No
Effective End Date	Used to search price lists which are assigned to the account or person till a particular date.	No

Field Name	Field Description	Mandatory (Yes or No)
Assignment Status	<p>Used to search price list assignments with a particular status. The valid values are:</p> <ul style="list-style-type: none"> • Active • Rejected • Proposed • Inactive 	No
	<p>Note:</p> <p>The Inactive option is not available in the Assignment Status list when you have selected the Current Price List Assignments or Historical Price List Assignments option from the Search By list.</p> <p>This field is disabled, and by default, the Inactive option is selected when you select the Inactive Price List Assignments option from the Search By list.</p>	
Price List Inheritance	<p>Used to search price list assignments where the account or person inherits price item pricing from the price list hierarchy. The valid values are:</p> <ul style="list-style-type: none"> • Yes • No 	No

Note: You must specify at least one search criterion while searching for price list assignments.

- **Search Results** - On clicking the **Search** button, the search results appear based on the specified search criteria. The **Search Results** section contains the following columns:

Column Name	Column Description
Price List Information	<p>Displays information about the price list which is assigned to the account or person.</p> <p>Note: It has a link. On clicking the link, the Price List screen appears with the details of the respective price list.</p>
Effective Start Date	Displays the date from when the price list is assigned to the account or person.
Effective End Date	Displays the date till when the price list is assigned to the account or person.
Priority	Indicates the order in which the assigned price list must be considered while determining the price item pricing for the account or person.
Assignment Status	<p>Indicates the status of the price list assignment. The valid values are:</p> <ul style="list-style-type: none"> • Active • Rejected • Proposed • Inactive

Column Name	Column Description
Price List Inheritance	Indicates whether the account or person can avail the price item pricing listed on the parent or grandparent price list if it is not available on the assigned price list. In other words, it indicates whether the account or person can inherit the price item pricing from the price list hierarchy.
Edit	On clicking the Edit (✎) icon, the Price List Assignment screen appears where you can edit the price list assignment details.

Note: Pagination is used to display limited number of records in the **Search Results** section. You can use the navigation links, such as **Previous** and **Next** to navigate between pages.

On clicking the **Broadcast** (📡) icon corresponding to the assigned price list, the **Price List Price Items** zone appears where you can view the price items assigned to the price list.

Related Topics

For more information on...	See...
Price List Price Items zone	Price List Price Items on page 866
How to view price items assigned to the price list	Viewing Price Items Assigned to a Price List on page 900
How to edit the price list assignment details of an account	Editing the Price List Assignment Details of an Account on page 908
How to edit the price list assignment details of a person	Editing the Price List Assignment Details of a Person on page 911
How to view price lists assigned to an account	Viewing Price Lists Assigned to an Account on page 898
How to view price lists assigned to a person	Viewing Price Lists Assigned to a Person on page 899

Price List Price Items

The **Price List Price Items** zone lists the price items that are assigned to the price list. You will not find any records in this zone if the price list does not have any price items assigned to it. It contains the following columns:

Column Name	Column Description
Pricing	Displays information about the price item pricing.
	Note: It has a link. On clicking the link, the Price Item Pricing screen appears where you can view the details of the price item pricing.
Pricing Parameters	Displays a comma-separated list of parameter values. The order in which parameter values appear in this column is controlled by the display order (which is defined while associating a parameter with a price item).
	Note: This column appears when the Multi Price Parameter option type of the Multi Parameter Based Pricing (C1_PPARM_FLG) feature configuration is set to True .

Column Name	Column Description
Pricing Status	Indicates the status of the price item pricing. The valid values are: <ul style="list-style-type: none"> • Active • Inactive • Proposed • Rejected • Template
Rate Info	Displays the rate of the price item. Note: If the price assignment has only one price component, you can view the rate defined in the pricing directly through the Rate Info column. However, if the price assignment has more than one price components, then the Rate Info column contains a string indicating the tiering type and pricing currency. It also contains “...” which indicates that for more information about the pricing you should navigate to the Price Item Pricing screen.
Effective Start Date	Displays the date from when the price item pricing is effective for the price list.
Effective End Date	Displays the date till when the price item pricing is effective for the price list.
Price Assignment Type	Indicates the type of the price assignment for price item pricing. The valid values are: <ul style="list-style-type: none"> • Regular • Post Processing • Post Processing – Invoice Based • Post Processing – Price Item Based Note: This column appears when the Multi Price Parameter option type of the Multi Parameter Based Pricing (C1_PPARM_FLG) feature configuration is set to True .
Copy	On clicking the Copy (📄) icon, the Price Item Pricing screen appears where you can define a new price item pricing using an existing price item pricing.

By default, the **Price List Price Items** zone does not appear in the **Price List Assignment** screen. It appears when you click the **Broadcast** (📡) icon corresponding to the assigned price list in the **Price List Assignments** zone.

You can filter the list using various search criteria (such as, **Price Item** and **Effective Start Date**) available in the **Filter** area. By default, the **Filter** area is hidden. You can view the **Filter** area by clicking the **Filters** (🔍) icon in the upper right corner of this zone.

You can change the layout of this zone. For more information on how to change the layout, see [Changing the Layout](#) on page 3414.

Related Topics

For more information on...	See...
How to view price items assigned to a price list	Viewing Price Items Assigned to a Price List on page 900

Search Price List for Assignment

The **Search Price List for Assignment** zone allows you to search for a price list that you want to assign to the account or person. It contains the following two sections:

- **Search Criteria** – The **Search Criteria** section contains the following fields:

Field Name	Field Description	Mandatory (Yes or No)
Search By	Used to indicate whether you want to search against all price lists or against those price lists which are already assigned to an account or a person. The valid values are: <ul style="list-style-type: none"> • Price List • Assigned Price List 	Yes
	Note: By default, the Price List option is selected.	
Price List ID	Used to search a particular price list.	No
Price List Description	Used to search price lists with a particular description.	No
Effective Start Date	If you have selected the Price List option from the Search By list, this field is used to search price lists which are effective from a particular date onwards. However, if you have selected the Assigned Price List option from the Search By list, this field is used to search price lists which are assigned to an account or a person from a particular date onwards.	No
Effective End Date	If you have selected the Price List option from the Search By list, this field is used to search price lists which are effective till a particular date. However, if you have selected the Assigned Price List option from the Search By list, this field is used to search price lists which are assigned to an account or a person till a particular date.	No
Account ID	Used to search price lists assigned to a particular account.	No
	Note: This field appears when you have selected the Assigned Price List option from the Search By list.	
Person ID	Used to search price lists assigned to a particular person.	No
	Note: This field appears when you have selected the Assigned Price List option from the Search By list.	

Field Name	Field Description	Mandatory (Yes or No)
Status	Used to search price lists with a particular status. The valid values are: <ul style="list-style-type: none"> • Active • Proposed 	No
	Note: This field appears when you have selected the Price List option from the Search By list.	
Price List Type	Used to search a particular type of price lists. The valid values are: <ul style="list-style-type: none"> • Standard • Promotional 	No
	Note: This field appears when you have selected the Price List option from the Search By list.	
Only Eligible Price Lists	Used to search price lists which are eligible for the account or person.	No
	Note: This field appears when you have selected the Price List option from the Search By list.	
Eligibility Date	Used to search price lists which are eligible for the account or person from a particular date.	No
	Note: This field appears only when you have selected the Price List option from the Search By list. By default, the current date appears in this field when the Only Eligible Price Lists option is selected. You can change the value, if required.	

Note: You must specify at least one search criterion while searching for a price list.

- **Search Results** – On clicking the **Search** button, the search results appear based on the specified search criteria. The search results include only those price lists that are associated with the division to which the account belongs. It may also include price lists that are already assigned to the account in case those price lists match the search criteria.

The **Search Results** section contains the following columns:

Column Name	Column Description
Assign	On clicking the Assign () icon, the Price List Assignment screen appears where you can assign the price list to the account or person.
Price List Information	Displays the information about the price list.
	Note: It has a link. On clicking the link, the Price List screen appears where you can view the details of the respective price list.

Column Name	Column Description
Account Information	Displays the information about the account.
	Note: It has a link. On clicking the link, the Account screen appears where you can view the details of the respective account.
Person Information	Displays the information about the person.
	Note: It has a link. On clicking the link, the Person screen appears where you can view the details of the respective person.
Effective Start Date	If you have selected the Price List option from the Search By list, the date from when the price list is effective appears in this column. However, if you have selected the Assigned Price List option from the Search By list, the date from when the price list is assigned to the account or person appears in this column.
Effective End Date	If you have selected the Price List option from the Search By list, the date till when the price list is effective appears in this column. However, if you have selected the Assigned Price List option from the Search By list, the date till when the price list is assigned to the account or person appears in this column.
Availability Start Date	Displays the date from when the price list is available for assignment to an account or a person.
Availability End Date	Displays the date till when the price list is available for assignment to an account or a person.

Related Topics

For more information on...	See...
How to assign a price list to an account	Assigning a Price List to an Account on page 901
How to assign a price list to a person	Assigning a Price List to a Person on page 904

Viewing Price Lists Assigned to an Account

Procedure

To view the price lists assigned to an account:

1. Search for the account in the **Customer 360° View** screen.
2. In the **Search Results** section, click the **Show Context Menu** () icon corresponding to the account whose details you want to view.

A menu appears.

3. Click the **Go To Price List Assignment** menu option.

The **Price List Assignment** screen appears. It contains the following zones:

- **Price List Assignments** – Lists the price lists that are already assigned to the account.
- **Price List Price Items** – Lists the price items that are assigned to the price list.
- **Search Price List for Assignment** – Enables you to search for a price list that you want to assign to the account.

4. Do either of the following:

If...	Then
If you want to view the price lists which are currently assigned to an account	<ol style="list-style-type: none"> 1. Ensure that the Current Price List Assignments option is selected from the Search By list. 2. Enter the required search criteria and then click Search. <p>The price lists which are currently assigned to the account appears in the search results.</p>
If you want to view the price lists assigned to an account which are inactive	<ol style="list-style-type: none"> 1. Select the Inactive Price List Assignments option from the Search By list. 2. Enter the required search criteria and then click Search. <p>The price lists assigned to an account which are inactive appears in the search results.</p>
If you want to view the price lists assigned to an account which are expired	<ol style="list-style-type: none"> 1. Select the Historical Price List Assignments option from the Search By list. 2. Enter the required search criteria and then click Search. <p>The price lists assigned to an account which are expired appears in the search results.</p>

Related Topics

For more information on...	See...
How to search for a person	Searching for an Account
Price List Assignment screen	Price List Assignment on page 891
Price List Assignments zone	Price List Assignments on page 892

Viewing Price Lists Assigned to a Person

Procedure

To view the price lists assigned to a person:

1. Search for the person in the **Customer 360° View** screen.
2. In the **Search Results** section, click the **Show Context Menu** () icon corresponding to the person whose details you want to view.
A menu appears.
3. Click the **Go To Price List Assignment** menu option.

The **Price List Assignment** screen appears. It contains the following zones:

- **Price List Assignments** – Lists the price lists that are already assigned to the person.
- **Price List Price Items** – Lists the price items that are assigned to the price list.

- **Search Price List for Assignment** – Enables you to search for a price list that you want to assign to the person.

4. Do either of the following:

If...	Then
If you want to view the price lists which are currently assigned to a person	<ol style="list-style-type: none"> 1. Ensure that the Current Price List Assignments option is selected from the Search By list. 2. Enter the required search criteria and then click Search. <p>The price lists which are currently assigned to the person appears in the search results.</p>
If you want to view the price lists assigned to a person which are inactive	<ol style="list-style-type: none"> 1. Select the Inactive Price List Assignments option from the Search By list. 2. Enter the required search criteria and then click Search. <p>The price lists assigned to a person which are inactive appears in the search results.</p>
If you want to view the price lists assigned to a person which are expired	<ol style="list-style-type: none"> 1. Select the Historical Price List Assignments option from the Search By list. 2. Enter the required search criteria and then click Search. <p>The price lists assigned to a person which are expired appears in the search results.</p>

Related Topics

For more information on...	See...
How to search for a person	Searching for a Person
Price List Assignment screen	Price List Assignment on page 891
Price List Assignments zone	Price List Assignments on page 892

Viewing Price Items Assigned to a Price List

Prerequisites

To view the price items assigned to a price list, you should have:

- An algorithm defined using the **C1-PLPINFO** algorithm type and attached to **Pricelist Products Assignment Information** system event in the **Algorithms** tab of the **Installation Options – Framework** screen

Procedure

To view the price items assigned to a price list:

1. Do either of the following:

If you want to view...	Then...
Price items assigned to the price list which is assigned to the account	<ol style="list-style-type: none"> 1. Search for the account in the Customer 360° View screen. 2. In the Search Results section, click the Show Context Menu (▼) icon corresponding to the account whose <i>details</i> you want to view. A menu appears. 3. Click the Go To Price List Assignment menu option. The Price List Assignment screen appears. 4. In the Price List Assignments zone, click the Broadcast (📡) icon corresponding to the assigned price list whose price items you want to view.
Price items assigned to the price list which is assigned to the person	<ol style="list-style-type: none"> 1. Search for the person in the Customer 360° View screen. 2. In the Search Results section, click the Show Context Menu (▼) icon corresponding to the person whose <i>details</i> you want to view. A menu appears. 3. Click the Go To Price List Assignment menu option. The Price List Assignment screen appears. 4. In the Price List Assignments zone, click the Broadcast (📡) icon corresponding to the assigned price list whose price items you want to view.

The **Price List Price Items** zone appears.

2. View the price items that are assigned to the price list in the **Price List Price Items** zone.

Related Topics

For more information on...	See...
How to search for an account	Searching for an Account
How to search for a person	Searching for a Person
Price List Assignment screen	Price List Assignment on page 891
Price List Assignments zone	Price List Assignments on page 892
Price List Price Items zone	Price List Price Items on page 894

Assigning a Price List to an Account

Prerequisites

To assign a price list to an account, you should have:

- Price list defined in the application

- Price list associated with the division to which the account belongs
- Value defined for the **Default Price List Priority** option type in the **C1_PRICING** feature configuration

Procedure

To assign a price list to an account:

1. Search for the account in the **Customer 360° View** screen.
2. In the **Search Results** section, click the **Show Context Menu** () icon corresponding to the account whose details you want to edit.

A menu appears.

3. Click the **Go To Price List Assignment** menu option.

The **Price List Assignment** screen appears. It contains the following zones:

- **Price List Assignments** – Lists the price lists that are already assigned to the account.
 - **Price List Price Items** – Lists the price items that are assigned to the price list.
 - **Search Price List for Assignment** – Enables you to search for a price list that you want to assign to the account.
4. In the **Search Price List for Assignment** zone, select the **Price List** or **Assigned Price List** option from the **Search By** list depending on whether you want to search against all price lists or against those price lists which are already assigned to an account or a person.
 5. Enter the search criteria in the **Search Price List for Assignment** zone.

Note: ORMB search engine supports wildcard search, where you can substitute the percentage (%) symbol as a stand in for any word or letter in a search criteria. You can use the ‘%’ wildcard character in all input fields except the date and ID fields. The ‘%’ wildcard character is suffixed automatically at the end of the partial search criteria. Therefore, you may or may not specify the wildcard character at the end of the partial search criteria. However, you have to prefix the wildcard character manually wherever required.

6. Click **Search**.

A list of price lists that meet the search criteria appears in the **Search Results** section.

Note: The search results include only those price lists that are associated with the division to which the account belongs. It may also include price lists that are already assigned to the account in case those price lists match the search criteria.

7. In the **Search Results** section, click the **Assign** () icon corresponding to the price list that you want to assign to the account.

The **Price List Assignment** screen appears. It consists of the following sections:

- **Main** – Used to specify basic information while assigning the price list to the account.
- **Characteristics** – Used to define the characteristics for the price list assignment.

The **Main** section contains the following fields:

Field Name	Field Description	Mandatory (Yes or No)
Account Information	Indicates the account to which you want to assign the price list.	Not applicable
Price List Information	Displays the information about the price list.	Not applicable

Field Name	Field Description	Mandatory (Yes or No)								
Effective Start Date	Used to specify the date from when you want to assign the price list to the account.	Yes								
	Note: The price list assignment start date cannot be earlier than the price list effective start date or later than the price list effective end date.									
Effective End Date	Used to specify the date till when you want to assign the price list to the account.	No								
	<p>Note:</p> <p>The effective end date cannot be earlier than the effective start date.</p> <p>If the validity period is specified for the price list, the price list assignment end date should be earlier than or equal to the following whichever is earlier:</p> <ul style="list-style-type: none"> • Price list assignment validity end date (which is price list assignment start date + validity period) • Price list effective end date <p>Let us understand this with the help of the following example:</p> <table border="1"> <tbody> <tr> <td>Price List Effective Start Date</td> <td>01-Jan-2015</td> </tr> <tr> <td>Price List Effective End Date</td> <td>31-Jan-2015</td> </tr> <tr> <td>Validity Period</td> <td>15 Days</td> </tr> <tr> <td>Price List Assignment Start Date</td> <td>15-Jan-2015</td> </tr> <tr> <td>Price List Assignment Validity End Date</td> <td>30-Jan-2015 (i.e. 15-Jan-2015 + 15 Days)</td> </tr> </tbody> </table> <p>In the above example, the price list assignment end date must be earlier than or equal to the price list assignment validity end date because the price list assignment validity end date is earlier than the price list effective end date.</p>		Price List Effective Start Date	01-Jan-2015	Price List Effective End Date	31-Jan-2015	Validity Period	15 Days	Price List Assignment Start Date	15-Jan-2015
Price List Effective Start Date	01-Jan-2015									
Price List Effective End Date	31-Jan-2015									
Validity Period	15 Days									
Price List Assignment Start Date	15-Jan-2015									
Price List Assignment Validity End Date	30-Jan-2015 (i.e. 15-Jan-2015 + 15 Days)									
Priority	Used to specify the order in which the price list should be considered while determining the price item pricing for the account.	Yes								
Price List Inheritance	<p>Used to indicate whether the account can avail the price item pricing listed on the parent or grandparent price list if it is not available on the price list. The valid values are:</p> <ul style="list-style-type: none"> • Yes – Used to indicate that the account can inherit the price item pricing from the price list hierarchy. • No – Used to indicate that the account cannot inherit the price item pricing from the price list hierarchy. 	Yes								

Field Name	Field Description	Mandatory (Yes or No)
Assignment Status	Used to indicate the status of the price list assignment. The valid values are: <ul style="list-style-type: none"> • Active – Used to indicate that you want to use the price item pricing on the price list for billing. • Proposed – Used to indicate that you want to use the price item pricing on the price list for quotations. 	Yes

8. Enter the required details in the **Main** section.
9. Define characteristics for the price list assignment, if required.
10. Click **Save**.

The price list is assigned to the account.

Related Topics

For more information on...	See
How to search for an account	Searching for an Account
Price List Assignment screen	Price List Assignment on page 891
Search Price List for Assignment zone	Search Price List for Assignment on page 896
How to define a characteristic for a price list assignment	Defining a Characteristic for a Price List Assignment on page 907
How to set the C1_PRICING feature configuration	Setting the C1_PRICING Feature Configuration on page 3467

Assigning a Price List to a Person

Prerequisites

To assign a price list to a person, you should have:

- Price list defined in the application
- Price list associated with the division to which the person belongs
- Value defined for the **Default Price List Priority** option type in the **C1_PRICING** feature configuration

Procedure

To assign a price list to a person:

1. Search for the person in the **Customer 360° View** screen.
2. In the **Search Results** section, click the **Show Context Menu** () icon corresponding to the person whose details you want to edit.

A menu appears.

3. Click the **Go To Price List Assignment** menu option.

The **Price List Assignment** screen appears. It contains the following zones:

- **Price List Assignments** – Lists the price lists that are already assigned to the person.
- **Price List Price Items** – Lists the price items that are assigned to the price list.
- **Search Price List for Assignment** – Enables you to search for a price list that you want to assign to the person.

4. In the **Search Price List for Assignment** zone, select the **Price List** or **Assigned Price List** option from the **Search By** list depending on whether you want to search against all price lists or against those price lists which are already assigned to an account or a person.
5. Enter the search criteria in the **Search Price List for Assignment** zone.

Note: ORMB search engine supports wildcard search, where you can substitute the percentage (%) symbol as a stand in for any word or letter in a search criteria. You can use the ‘%’ wildcard character in all input fields except the date and ID fields. The ‘%’ wildcard character is suffixed automatically at the end of the partial search criteria. Therefore, you may or may not specify the wildcard character at the end of the partial search criteria. However, you have to prefix the wildcard character manually wherever required.

6. Click **Search**.

A list of price lists that meet the search criteria appears in the **Search Results** section.

Note: The search results include only those price lists that are associated with the division to which the person belongs. It may also include price lists that are already assigned to the person in case those price lists match the search criteria.

7. In the **Search Results** section, click the **Assign**  icon corresponding to the price list that you want to assign to the person.

The **Price List Assignment** screen appears. It consists of the following sections:

- **Main** – Used to specify basic information while assigning the price list to the person.
- **Characteristics** – Used to define the characteristics for the price list assignment.

The **Main** section contains the following fields:

Field Name	Field Description	Mandatory (Yes or No)
Person Information	Indicates the person to whom you want to assign the price list.	Not applicable
Price List Information	Displays the information about the price list.	Not applicable
Effective Start Date	Used to specify the date from when you want to assign the price list to the person.	Yes
	Note: The price list assignment start date cannot be earlier than the price list effective start date or later than the price list effective end date.	

Field Name	Field Description	Mandatory (Yes or No)										
Effective End Date	<p>Used to specify the date till when you want to assign the price list to the person.</p> <p>Note:</p> <p>The effective end date cannot be earlier than the effective start date.</p> <p>If the validity period is specified for the price list, the price list assignment end date should be earlier than or equal to the following whichever is earlier:</p> <ul style="list-style-type: none"> • Price list assignment validity end date (which is price list assignment start date + validity period) • Price list effective end date <p>Let us understand this with the help of the following example:</p> <table border="1" data-bbox="521 751 1141 1129"> <tbody> <tr> <td>Price List Effective Start Date</td> <td>01-Jan-2015</td> </tr> <tr> <td>Price List Effective End Date</td> <td>31-Jan-2015</td> </tr> <tr> <td>Validity Period</td> <td>15 Days</td> </tr> <tr> <td>Price List Assignment Start Date</td> <td>15-Jan-2015</td> </tr> <tr> <td>Price List Assignment Validity End Date</td> <td>30-Jan-2015 (i.e. 15-Jan-2015 + 15 Days)</td> </tr> </tbody> </table> <p>In the above example, the price list assignment end date must be earlier than or equal to the price list assignment validity end date because the price list assignment validity end date is earlier than the price list effective end date.</p>	Price List Effective Start Date	01-Jan-2015	Price List Effective End Date	31-Jan-2015	Validity Period	15 Days	Price List Assignment Start Date	15-Jan-2015	Price List Assignment Validity End Date	30-Jan-2015 (i.e. 15-Jan-2015 + 15 Days)	No
Price List Effective Start Date	01-Jan-2015											
Price List Effective End Date	31-Jan-2015											
Validity Period	15 Days											
Price List Assignment Start Date	15-Jan-2015											
Price List Assignment Validity End Date	30-Jan-2015 (i.e. 15-Jan-2015 + 15 Days)											
Priority	Used to specify the order in which the price list should be considered while determining the price item pricing for the person.	Yes										
Price List Inheritance	<p>Used to indicate whether the person can avail the price item pricing listed on the parent or grandparent price list if it is not available on the price list. The valid values are:</p> <ul style="list-style-type: none"> • Yes – Used to indicate that the person can inherit the price item pricing from the price list hierarchy. • No – Used to indicate that the person cannot inherit the price item pricing from the price list hierarchy. 	Yes										

Field Name	Field Description	Mandatory (Yes or No)
Assignment Status	Used to indicate the status of the price list assignment. The valid values are: <ul style="list-style-type: none"> • Active – Used to indicate that you want to use the price item pricing on the price list for billing. • Proposed – Used to indicate that you want to use the price item pricing on the price list for quotations. 	Yes

8. Enter the required details in the **Main** section.
9. Define characteristics for the price list assignment, if required.
10. Click **Save**.

The price list is assigned to the person.

Related Topics

For more information on...	See
How to search for a person	Searching for a Person
Price List Assignment screen	Price List Assignment on page 891
Search Price List for Assignment zone	Search Price List for Assignment on page 896
How to define a characteristic for a price list assignment	Defining a Characteristic for a Price List Assignment
How to set the CI_PRICING feature configuration	Setting the CI_PRICING Feature Configuration on page 3467

Defining a Characteristic for a Price List Assignment

Prerequisites

To define a characteristic for a price list assignment, you should have:

- Characteristic types defined in the application (where the characteristic entity is set to **Price List Assignment**)

Procedure

To define a characteristic for a price list assignment:

1. Ensure that the **Characteristics** section is expanded when you are defining or editing characteristics for a price list assignment.

The **Characteristics** section contains the following fields:

Field Name	Field Description	Mandatory (Yes or No)
Effective Date	Used to specify the date from when the characteristic is effective for the price list assignment.	Yes (Conditional)
		Note: This field is required when you are defining a characteristic for the price list assignment.

Field Name	Field Description	Mandatory (Yes or No)
Characteristic Type	Used to indicate the characteristic type.	Yes (Conditional)
	Note: The list includes only those characteristic types where the characteristic entity is set to Price List Assignment .	Note: This field is required when you are defining a characteristic for the price list assignment.
Characteristic Value	Used to specify the value for the characteristic type.	Yes (Conditional)
	Note: On specifying the value for a predefined characteristic type, the description of the characteristic value appears corresponding to the Characteristic Value field.	Note: This field is required when you are defining a characteristic for the price list assignment.

- Enter the required details in the **Characteristics** section.

Note: If you select a predefined characteristic type, the **Search** (🔍) icon appears corresponding to the **Characteristic Value** field. On clicking the **Search** icon, you can search for a predefined characteristic value.

- If you want to define more than one characteristic for the price list assignment, click the **Add** (+) icon and then repeat step 2.

Note: However, if you want to remove a characteristic from the price list assignment, click the **Delete** (🗑️) icon corresponding to the characteristic.

- Click **Save**.

The characteristics are defined for the price list assignment.

Related Topics

For more information on...	See...
How to assign a price list to an account	Assigning a Price List to an Account on page 901
How to assign a price list to a person	Assigning a Price List to a Person on page 904
How to edit the price list assignment details of an account	Editing the Price List Assignment Details of an Account on page 908
How to edit the price list assignment details of a person	Editing the Price List Assignment Details of a Person on page 911

Editing the Price List Assignment Details of an Account

Procedure

To edit the price list assignment details of an account:

- Search for the account in the **Customer 360° View** screen.
- In the **Search Results** section, click the **Show Context Menu** (▼) icon corresponding to the account whose details you want to edit.

A menu appears.

- Click the **Go To Price List Assignment** menu option.

The **Price List Assignment** screen appears. It contains the following zones:

- **Price List Assignments** – Lists the price lists that are already assigned to the account.
- **Price List Price Items** – Lists the price items that are assigned to the price list.
- **Search Price List for Assignment** – Enables you to search for a price list that you want to assign to the account.

4. Do either of the following:

If you want to...	Then...
Edit the details of the price list assignment which is currently effective	<ol style="list-style-type: none"> 1. Select the Current Price List Assignments option from the Search By list. 2. Enter the required search criteria and then click Search. The price lists which are currently assigned to the account appears in the search results. 3. In the Search Results section, click the Edit (✎) icon in the Edit column corresponding to the price list whose assignment details you want to edit.
Edit the details of the price list assignment which is expired	<ol style="list-style-type: none"> 1. Select the Historical Price List Assignments option from the Search By list. 2. Enter the required search criteria and then click Search. The price lists assigned to an account which are expired appears in the search results. 3. In the Search Results section, click the Edit (✎) icon in the Edit column corresponding to the price list whose assignment details you want to edit.

The **Price List Assignment** screen appears. It contains the following sections:

- **Main** – Used to specify basic information while assigning the price list to the account.
- **Characteristics** – Used to define the characteristics for the price list assignment.

The **Main** section contains the following fields:

Field Name	Field Description	Mandatory (Yes or No)
Account Information	Indicates the account whose price list assignment details you want to edit.	Not applicable
Price List Information	Displays the information about the price list.	Not applicable
Effective Date Start	Displays the date from when the price list is assigned to the account.	Not applicable

Field Name	Field Description	Mandatory (Yes or No)										
Effective End Date	<p>Used to specify the date till when you want to assign the price list to the account.</p> <p>Note:</p> <p>The effective end date cannot be earlier than the effective start date.</p> <p>If the validity period is specified for the price list, the price list assignment end date should be earlier than or equal to the following whichever is earlier:</p> <ul style="list-style-type: none"> • Price list assignment validity end date (which is price list assignment start date + validity period) • Price list effective end date <p>Let us understand this with the help of the following example:</p> <table border="1" data-bbox="521 751 1141 1129"> <tbody> <tr> <td>Price List Effective Start Date</td> <td>01-Jan-2015</td> </tr> <tr> <td>Price List Effective End Date</td> <td>31-Jan-2015</td> </tr> <tr> <td>Validity Period</td> <td>15 Days</td> </tr> <tr> <td>Price List Assignment Start Date</td> <td>15-Jan-2015</td> </tr> <tr> <td>Price List Assignment Validity End Date</td> <td>30-Jan-2015 (i.e. 15-Jan-2015 + 15 Days)</td> </tr> </tbody> </table> <p>In the above example, the price list assignment end date must be earlier than or equal to the price list assignment validity end date because the price list assignment validity end date is earlier than the price list effective end date.</p>	Price List Effective Start Date	01-Jan-2015	Price List Effective End Date	31-Jan-2015	Validity Period	15 Days	Price List Assignment Start Date	15-Jan-2015	Price List Assignment Validity End Date	30-Jan-2015 (i.e. 15-Jan-2015 + 15 Days)	No
Price List Effective Start Date	01-Jan-2015											
Price List Effective End Date	31-Jan-2015											
Validity Period	15 Days											
Price List Assignment Start Date	15-Jan-2015											
Price List Assignment Validity End Date	30-Jan-2015 (i.e. 15-Jan-2015 + 15 Days)											
Priority	Used to specify the order in which the price list should be considered while determining the price item pricing for the account.	Yes										
Price List Inheritance	<p>Used to indicate whether the account can avail the price item pricing listed on the parent or grandparent price list if it is not available on the price list. The valid values are:</p> <ul style="list-style-type: none"> • Yes – Used to indicate that the account can inherit the price item pricing from the price list hierarchy. • No – Used to indicate that the account cannot inherit the price item pricing from the price list hierarchy. 	Yes										

Field Name	Field Description	Mandatory (Yes or No)
Assignment Status	<p>Used to indicate the status of the price list assignment. The valid values are:</p> <ul style="list-style-type: none"> • Active – Used to indicate that you want to use the price item pricing on the price list for billing. This value appears when you are editing an active and proposed price list assignment. • Proposed – Used to indicate that you want to use the price item pricing on the price list for quotations. This value appears when you are editing a proposed price list assignment. • Rejected – Used to indicate that you want to reject the price list assignment. This value appears only when you are editing a proposed price list assignment. • Inactive – Used to indicate that you no longer want to use the price list assignment. This value appears when you are editing an active price list assignment. <p>Note: You cannot change the status of a rejected price list assignment.</p>	Yes

5. Modify the required details in the **Main** section.
6. Define, edit, or remove characteristics of the price list assignment, if required.
7. Click **Save**.

The changes made to the price list assignment are saved.

Related Topics

For more information on...	See
How to search for an account	Searching for an Account
Price List Assignment screen	Price List Assignment on page 891
Price List Assignments zone	Price List Assignments on page 892
How to define a characteristic for a price list assignment	Defining a Characteristic for a Price List Assignment on page 907

Editing the Price List Assignment Details of a Person

Procedure

To edit the price list assignment details of a person:

1. Search for the person in the **Customer 360° View** screen.
2. In the **Search Results** section, click the **Show Context Menu** () icon corresponding to the person whose details you want to edit.

A menu appears.

3. Click the **Go To Price List Assignment** menu option.

The **Price List Assignment** screen appears. It contains the following zones:

- **Price List Assignments** – Lists the price lists that are already assigned to the person.
- **Price List Price Items** – Lists the price items that are assigned to the price list.
- **Search Price List for Assignment** – Enables you to search for a price list that you want to assign to the person.

4. Do either of the following:

If you want to...	Then...
Edit the details of the price list assignment which is currently effective	<ol style="list-style-type: none"> 1. Select the Current Price List Assignments option from the Search By list. 2. Enter the required search criteria and then click Search. The price lists which are currently assigned to the person appears in the search results. 3. In the Search Results section, click the Edit (✎) icon in the Edit column corresponding to the price list whose assignment details you want to edit.
Edit the details of the price list assignment which is expired	<ol style="list-style-type: none"> 1. Select the Historical Price List Assignments option from the Search By list. 2. Enter the required search criteria and then click Search. The price lists assigned to a person which are expired appears in the search results. 3. In the Search Results section, click the Edit (✎) icon in the Edit column corresponding to the price list whose assignment details you want to edit.

The **Price List Assignment** screen appears. It contains the following sections:

- **Main** – Used to specify basic information while assigning the price list to the person.
- **Characteristics** – Used to define the characteristics for the price list assignment.

The **Main** section contains the following fields:

Field Name	Field Description	Mandatory (Yes or No)
Person Information	Indicates the person whose price list assignment details you want to edit.	Not applicable
Price List Information	Displays the information about the price list.	Not applicable
Effective Start Date	Displays the date from when the price list is assigned to the person.	Not applicable

Field Name	Field Description	Mandatory (Yes or No)										
Effective End Date	<p>Used to specify the date till when the price list is assigned to the person.</p> <p>Note:</p> <p>The effective end date cannot be earlier than the effective start date.</p> <p>If the validity period is specified for the price list, the price list assignment end date should be earlier than or equal to the following whichever is earlier:</p> <ul style="list-style-type: none"> • Price list assignment validity end date (which is price list assignment start date + validity period) • Price list effective end date <p>Let us understand this with the help of the following example:</p> <table border="1" data-bbox="516 747 1138 1129"> <tbody> <tr> <td>Price List Effective Start Date</td> <td>01-Jan-2015</td> </tr> <tr> <td>Price List Effective End Date</td> <td>31-Jan-2015</td> </tr> <tr> <td>Validity Period</td> <td>15 Days</td> </tr> <tr> <td>Price List Assignment Start Date</td> <td>15-Jan-2015</td> </tr> <tr> <td>Price List Assignment Validity End Date</td> <td>30-Jan-2015 (i.e. 15-Jan-2015 + 15 Days)</td> </tr> </tbody> </table> <p>In the above example, the price list assignment end date must be earlier than or equal to the price list assignment validity end date because the price list assignment validity end date is earlier than the price list effective end date.</p>	Price List Effective Start Date	01-Jan-2015	Price List Effective End Date	31-Jan-2015	Validity Period	15 Days	Price List Assignment Start Date	15-Jan-2015	Price List Assignment Validity End Date	30-Jan-2015 (i.e. 15-Jan-2015 + 15 Days)	No
Price List Effective Start Date	01-Jan-2015											
Price List Effective End Date	31-Jan-2015											
Validity Period	15 Days											
Price List Assignment Start Date	15-Jan-2015											
Price List Assignment Validity End Date	30-Jan-2015 (i.e. 15-Jan-2015 + 15 Days)											
Priority	Used to specify the order in which the price list should be considered while determining the price item pricing for the person.	Yes										
Price List Inheritance	<p>Used to indicate whether the person can avail the price item pricing listed on the parent or grandparent price list if it is not available on the price list. The valid values are:</p> <ul style="list-style-type: none"> • Yes – Used to indicate that the person can inherit the price item pricing from the price list hierarchy. • No – Used to indicate that the person cannot inherit the price item pricing from the price list hierarchy. 	Yes										

Field Name	Field Description	Mandatory (Yes or No)
Assignment Status	<p>Used to indicate the status of the price list assignment. The valid values are:</p> <ul style="list-style-type: none"> • Active – Used to indicate that you want to use the price item pricing on the price list for billing. This value appears when you are editing an active and proposed price list assignment. • Proposed – Used to indicate that you want to use the price item pricing on the price list for quotations. This value appears when you are editing a proposed price list assignment. • Rejected – Used to indicate that you want to reject the price list assignment. This value appears only when you are editing a proposed price list assignment. • Inactive – Used to indicate that you no longer want to use the price list assignment. This value appears when you are editing an active price list assignment. <p>Note: You cannot change the status of a rejected price list assignment.</p>	Yes

5. Modify the required details in the **Main** section.
6. Define, edit, or remove characteristics of the price list assignment, if required.
7. Click **Save**.

The changes made to the price list assignment are saved.

Related Topics

For more information on...	See
How to search for a person	Searching for a Person
Price List Assignment screen	Price List Assignment on page 891
Price List Assignments zone	Price List Assignments on page 892
How to define a characteristic for a price list assignment	Defining a Characteristic for a Price List Assignment

Price List Assignments

The **Price List Assignments** screen allows you to view the price list assignments of a particular price list. It contains the following zones:

- [Persons to whom Price List is Assigned](#) on page 915
- [Accounts where Price List is Assigned](#) on page 914

Accounts where Price List is Assigned

The **Accounts where Price List is Assigned** zone displays the details of the accounts where price list is assigned. It contains the following fields:

Field Name	Field Description
Account ID	Displays the account ID.
Account Information	Displays information about the account. In addition, this column has a context menu which helps in navigating to other screens in the application. Note: It has a link. On clicking the link, the Account screen appears where you can view the details of the respective account.
Price List Assignment Start Date	Displays the price list assignment start date.
Price List Assignment End Date	Displays the price list assignment end date.
Division	Displays the division to which the account belongs.
Price List Assignment ID	Displays the price list assignment ID.

Related Topics

For more information on...	See...
How to search a price list	Searching for a Price List on page 849
How to view accounts and persons where price list is assigned	Viewing Accounts and Persons where Price List is Assigned on page 916

Persons to whom Price List is Assigned

The **Persons to whom Price List is Assigned** zone displays the details of the persons where price list is assigned. It contains the following fields:

Field Name	Field Description
Person ID	Displays the person ID.
Person Information	Displays information about the person. In addition, this column has a context menu which helps in navigating to other screens in the application. Note: It has a link. On clicking the link, the Person screen appears where you can view the details of the respective person.
Price List Assignment Start Date	Displays the price list assignment start date.
Price List Assignment End Date	Displays the price list assignment end date.
Division	Displays the division to which the person belongs.
Price List Assignment ID	Displays the price list assignment ID.

Related Topics

For more information on...	See...
How to search a price list	Searching for a Price List on page 849

For more information on...	See...
How to view accounts and persons where price list is assigned	Viewing Accounts and Persons where Price List is Assigned on page 916

Viewing Accounts and Persons where Price List is Assigned

Prerequisites

To view accounts and persons where price list is assigned, you should have:

- Accounts and persons created in the application
- Price list defined and assigned to the accounts and persons

Procedure

To view accounts and persons where price list is assigned:

1. Click the **Menu** link in the **Application** toolbar.
A list appears.
2. From the **Main** menu, select **Pricing Management** and then click **Price List**.
The **Price List** screen appears.
3. You can search for a price list by entering the search criteria in the **Search Price List** zone.

Note: ORMB search engine supports wildcard search, where you can substitute the percentage (%) symbol as a stand in for any word or letter in a search criteria. You can use the ‘%’ wildcard character in all input fields except the date and ID fields. The ‘%’ wildcard character is suffixed automatically at the end of the partial search criteria. Therefore, you may or may not specify the wildcard character at the end of the partial search criteria. However, you have to prefix the wildcard character manually wherever required.

4. Click **Search**.
A list of price lists that meet the search criteria appears in the search results.
5. In the **Search Results** section, click the **Assigned To** () icon in the **Assigned To** column corresponding to the price list whose details you want to view.
The **Price List Assignments** screen appears.
6. You can view the accounts and persons list where price list is assigned in the **Price List Assignments** screen.

Related Topics

For more information on...	See...
How to search a price list	Searching for a Price List on page 849
Accounts where Price List is Assigned zone	Accounts where Price List is Assigned on page 914
Persons to whom Price List is Assigned zone	Persons to whom Price List is Assigned on page 915

Entities Eligible for Price List Assignment

The **Entities Eligible for Price List Assignment** screen allows you to view the details of a price list. It also allows you to search for multiple eligible accounts or persons and assign them to the price list. This screen consists of the following zones:

- [Eligible Accounts](#) on page 917
- [Eligible Persons](#) on page 917

Eligible Accounts

The **Eligible Accounts** zone allows you to search the eligible accounts for price list assignments. Moreover, it also allows you to assign the multiple eligible accounts to a price list. This zone contains the following two sections:

- **Search Criteria** — The **Search Criteria** section contains the following fields:

Field Name	Field Description	Mandatory (Yes or No)
Division	Used to indicate the division whose accounts you want to search.	Yes
Effective Date	Used to indicate the date from when the accounts are eligible for price list assignment.	No
Account ID	Used to indicate the account ID.	No

- **Search Results** — On clicking the **Search** button, the search results appear based on the specified search criteria. The **Search Results** section contains the following columns:

Column Name	Column Description
Account Information	Displays the information about the eligible accounts where price list can be assigned. In addition, this column has a context menu which helps in navigating to other screens in the application.
	Note: It has a link. On clicking the link, the Account screen appears where you can view the details of the respective account.
Assigned	Displays whether the account is assigned to the price list or not. The valid values are: <ul style="list-style-type: none"> • Yes • No

Eligible Persons

The **Eligible Persons** zone allows you to search the eligible persons for price list assignments. Moreover, it also allows you to assign the multiple eligible persons to a price list. This zone contains the following two sections:

- **Search Criteria** — The **Search Criteria** section contains the following fields:

Field Name	Field Description	Mandatory (Yes or No)
Division	Used to indicate the division whose persons you want to search.	Yes
Effective Date	Used to indicate the date from when the persons are eligible for price list assignment.	No
Person ID	Used to indicate the person ID.	No

- **Search Results** — On clicking the **Search** button, the search results appear based on the specified search criteria. The **Search Results** section contains the following columns:

Column Name	Column Description
Person Information	Displays the information about the eligible persons where price list can be assigned. In addition, this column has a context menu which helps in navigating to other screens in the application.
	Note: It has a link. On clicking the link, the Person screen appears where you can view the details of the respective person.
Assigned	Displays whether the person is assigned to the price list or not. The valid values are: <ul style="list-style-type: none"> • Yes • No

Related Topics

For more information on...	See...
How to search for a price list	Searching for a Price List on page 849
How to view the accounts and persons eligible for price list assignments	Viewing Accounts and Persons Eligible for Price List Assignment
How to define a characteristic for a Price List Assignment	Defining a Characteristic for a Price List Assignment on page 921

Assigning a Price List to One or More Eligible Accounts

Prerequisites

To assign a price list to one or more eligible accounts, you should have:

- Price list defined in the application
- Accounts created in the application
- Price list should be associated with the division to which accounts belong.
- Value defined for the **Default Price List Priority** option type in the **C1_PRICING** feature configuration

Procedure

To assign a price list to one or more eligible accounts:

1. Search for the eligible accounts in the **Eligible Accounts** zone of **Persons and Accounts Eligible for Price List Assignment** screen.
2. In the **Search Results** section, select the one or more accounts that you want to assign to the price list.
3. Click the **Assign** button available in the upper left corner of this section

The **Price List Assignment** screen appears. This screen contains following two sections:

- **Main** — Used to specify basic details about the price list. This section contains the following fields:

Field Name	Field Description	Mandatory (Yes or No)
Price List Information	Displays the additional information about the price list.	Not applicable
Effective Start Date	Used to specify the date from when the price list is effective.	Yes

Field Name	Field Description	Mandatory (Yes or No)
Effective End Date	Used to specify the date till when the price list is effective.	No
Priority	Used to specify the order in which the price list should be considered while determining the price item pricing for the account.	No
Price List Inheritance	Used to indicate whether the account can avail the price item pricing listed on the parent or grandparent price list if it is not available on the price list. The valid values are: <ul style="list-style-type: none"> • Yes • No 	No
Assignment Status	Used to indicate the status of the price list assignment. The valid values are: <ul style="list-style-type: none"> • Active • Proposed 	No
Priority Indicator	Used to set the priority of the price list assignment. The valid values are: <ul style="list-style-type: none"> • Highest — Used when you want the price list assignment to have the highest priority. It checks whether there are any other price list assignments for the account, derives the priority of each such price list assignment, and then sets the priority of the new price list assignment to the existing price list assignment with highest priority minus one. • Lowest — Used when you want the price list assignment to have the lowest priority. It checks whether there are any other price list assignments for the account, derives the priority of each such price list assignment, and then sets the priority of the new price list assignment to the existing price list assignment with lowest priority plus one. 	No

- **Characteristics** — Used to define the characteristics for the price list.

4. Click **Save**.

Selected accounts are assigned to the price list.

Related Topics

For more information on...	See...
How to search for a price list	Searching for a Price List on page 849
Eligible Persons zone	Eligible Persons on page 917
Eligible Accounts zone	Eligible Accounts on page 917

For more information on...	See...
How to define a characteristic for a Price List Assignment	Defining a Characteristic for a Price List Assignment on page 921
How to set the C1_PRICING feature configuration	Setting the C1_PRICING Feature Configuration on page 3467

Assigning a Price List to One or More Eligible Persons

Prerequisites

To assign a price list to one or more eligible persons, you should have:

- Price list defined in the application
- Persons created in the application
- Price list should be associated with the division to which persons belong.
- Value defined for the **Default Price List Priority** option type in the **C1_PRICING** feature configuration

Procedure

To assign a price list to one or more eligible persons:

1. Search for the eligible Persons in the **Eligible Persons** zone of **Persons and Accounts Eligible for Price List Assignment** screen.
2. In the **Search Results** section, select the one or more persons that you want to assign to the price list.
3. Click the **Assign** button available in the upper left corner.

The **Price List Assignment** screen appears. This screen contains following two sections:

- **Main** — Used to specify basic details about the price list. This section contains the following fields:

Field Name	Field Description	Mandatory (Yes or No)
Price List Information	Displays the additional information about the price list.	Not applicable
Effective Start Date	Used to specify the date from when the price list is effective.	Yes
Effective End Date	Used to specify the date till when the price list is effective.	No
Priority	Used to specify the order in which the price list should be considered while determining the price item pricing for the person.	No
Price List Inheritance	Used to indicate whether the account can avail the price item pricing listed on the parent or grandparent price list if it is not available on the price list. The valid values are: <ul style="list-style-type: none"> • Yes • No 	No

Field Name	Field Description	Mandatory (Yes or No)
Assignment Status	Used to indicate the status of the price list assignment. The valid values are: <ul style="list-style-type: none"> Active Proposed 	No
Priority Indicator	Used to set the priority of the price list assignment. The valid values are: <ul style="list-style-type: none"> Highest — Used when you want the price list assignment to have the highest priority. It checks whether there are any other price list assignments for the person, derives the priority of each such price list assignment, and then sets the priority of the new price list assignment to the existing price list assignment with highest priority minus one. Lowest — Used when you want the price list assignment to have the lowest priority. It checks whether there are any other price list assignments for the person, derives the priority of each such price list assignment, and then sets the priority of the new price list assignment to the existing price list assignment with lowest priority plus one. 	No

- **Characteristics** — Used to define the characteristics for the price list.

4. Click **Save**.

Selected persons are assigned to the price list.

Related Topics

For more information on...	See...
How to search for a price list	Searching for a Price List on page 849
Eligible Persons zone	Eligible Persons on page 917
Eligible Accounts zone	Eligible Accounts on page 917
How to define a characteristic for a Price List Assignment	Defining a Characteristic for a Price List Assignment on page 921
How to set the C1_PRICING feature configuration	Setting the C1_PRICING Feature Configuration on page 3467

Defining a Characteristic for a Price List Assignment

Prerequisites

To define characteristics for a price list assignment, you should have:

- Characteristic types defined in the application (where the characteristic entity is set to **Price List Assignment**)

Procedure

To define a characteristic for a price list assignment:

1. Click the **Characteristics** tab in the **Price List Assignment** screen when you are assigning a price list to multiple persons or accounts and also editing the price list assignment details of multiple persons or accounts.

The **Characteristics** tab appears. It contains the following fields:

Field Name	Field Description	Mandatory (Yes or No)
Effective Date	Used to specify the date from when the characteristic is effective for the price list assignment.	Yes (Conditional) Note: This field is required when you are defining a characteristic for the price list assignment.
Characteristic Type	Used to indicate the characteristic type. Note: The list includes only those characteristic types where the characteristic entity is set to Price List Assignment .	Yes (Conditional) Note: This field is required when you are defining a characteristic for the price list assignment.
Characteristic Value	Used to specify the value for the characteristic type. Note: On specifying the value for a predefined characteristic type, the description of the characteristic value appears corresponding to the Characteristic Value field.	Yes (Conditional) Note: This field is required when you are defining a characteristic for the price list assignment.

2. Enter the required details in the **Characteristics** tab.

Note: If you select a predefined characteristic type, the **Search** (🔍) icon appears corresponding to the **Characteristic Value** field. On clicking the **Search** icon, you can search for a predefined characteristic value.

3. If you want to define more than one characteristic for the price list assignment, click the **Add** (+) icon and then repeat step 2.

Note: However, if you want to remove a characteristic from the price list assignment, click the **Delete** (🗑️) icon corresponding to the characteristic.

4. Click **Save**.

The characteristics are defined for the price list assignment.

Related Topics

For more information on...	See...
How to assign a price list to a person	Assigning a Price List to a Person on page 904
How to edit the price list assignment details of a person	Editing the Price List Assignment Details of a Person on page 911

Rate Definition

Rate schedules, rate versions, and rate components are used to define the formulas to calculate the total amount charged to a customer for a product. Some examples of formulas are: price times the number of transactions used and a flat monthly charge plus a percentage of the average daily balance.

The rate is a formula with variables whose values are supplied by a user by setting up a price list or override price. For example, a rate might add a flat monthly charge and a percentage of the average daily balance to arrive at the amount charged to the customer. This rate might be used to calculate the charge for multiple products, each product with its own flat amount and percentage. So, these two factors are defined as variables whose values must be entered by users when they setup price list or override price. In Oracle Revenue Management and Billing (ORMB), these variables are defined as rate components.

The system provides you with the ability to create tiered pricing in case standard flat pricing is not sufficient to meet the business needs. The **Rate Definition** screen allows you to indicate whether the rate component supports standard flat pricing or tiered pricing. It allows you to define, edit, and delete the tiering setup of a rate component. This screen consists of the following zones:

- [Rate Schedule Components](#) on page 923
- [Create/Edit Rate Definition](#) on page 924

Rate Schedule Components

The **Rate Schedule Components** zone allows you to select the rate schedule whose rate components' tiering setup you want to define or edit. This zone contains the following two sections:

- **Search Criteria** — The **Search Criteria** section contains the following field:

Field Name	Field Description	Mandatory (Yes or No)
Rate Schedule	Used to select the rate schedule.	Yes

- **Search Results** — On clicking the **Search** button, the rate components of the rate schedule appear in the search results. The **Search Results** section contains the following columns:

Column Name	Column Description
Rate Schedule	Displays the rate schedule.
Rate Component Sequence	Displays the sequence number of the rate component.
Rate Component Description	Displays the description of the rate component.
Effective Start Date	Displays the date from when the rate version to which the rate component belongs is effective.
Tiering Type	Displays the tiering type.
Maximum Tiering Combinations	Displays the maximum number of tiering ranges supported by the rate component. Note: Each tiering range supports more than one tiering criteria. For example, a rate component supports tiering based on two different criteria such as transaction volumes from a bundle and balances of the priced product. In such case, for a single rate, it is possible to enter separate tiering range information for each criterion and vary this information by product.

Column Name	Column Description
Rate Component Map Description	Displays the description of the tiering setup of the rate component.
Action	Indicates the action that can be performed on the rate component. The valid values are: <ul style="list-style-type: none"> • Add — Allows you to define the tiering setup of the rate component • Edit — Allows you to edit the tiering setup of the rate component
Rate Component Map ID	Displays the rate component map ID. Note: This ID is generated automatically when you define the tiering setup of the rate component.

On clicking the **Broadcast** () icon corresponding to the rate component, the **Create/Edit Rate Definition** zone appears with the details of the respective rate component.

Related Topics

For more information on...	See...
How to define tiering setup of a rate component	Defining Tiering Setup of a Rate Component on page 925
How to edit tiering setup of a rate component	Editing Tiering Setup of a Rate Component on page 926
How to delete tiering setup of a rate component	Deleting Tiering Setup of a Rate Component on page 927

Create/Edit Rate Definition

The **Create/Edit Rate Definition** zone allows you to define and edit tiering setup of the rate component. This zone contains the following fields:

Field Name	Field Description	Mandatory (Yes or No)
Rate Schedule	Displays the code of the rate schedule.	Not applicable
Rate Component Description	Displays the description of the rate component.	Not applicable
Effective Start Date	Displays the date from when the rate version to which the rate component belongs is effective.	Not applicable
Rate Component Sequence	Displays the sequence number of the rate component.	Not applicable
Tiering Type	Used to specify the tiering type. The valid values are: <ul style="list-style-type: none"> • FLAT • STEP • THRESHOLD Note: This field is non-editable when you edit the tiering setup of the rate component.	Yes

Field Name	Field Description	Mandatory (Yes or No)
Maximum Tiering Combinations	Used to specify the maximum number of tiering ranges supported by the rate component. Note: This field is non-editable when you: <ul style="list-style-type: none"> Select the tiering type as FLAT or STEP Edit the tiering setup of the rate component By default, 0 appears in this field when you select the tiering type as FLAT , and 1 appears when you select the tiering type as STEP .	Yes
Rate Component Map Description	Used to specify the description for the tiering setup of the rate component. For example, if you want the user to enter price per transaction for a tiering range, enter Price Per Transaction in the Rate Component Map Description field.	Yes

This zone contains the following buttons:

Button Name	Button Description (When the Action is Add)	Button Description (When the Action is Edit)
Save	Used to create the tiering setup.	Used to save the changes made in this zone.
Delete	Note: This button is disabled when you define the tiering setup of the rate component.	Used to delete the tiering setup of the rate component.
		Note: You can delete the tiering setup when the rate component is not yet used for any product pricing.
Cancel	Used to clear the fields in this zone.	Used to reset the changes made in this zone.

Related Topics

For more information on...	See...
How to define tiering setup of a rate component	Defining Tiering Setup of a Rate Component on page 925
How to edit tiering setup of a rate component	Editing Tiering Setup of a Rate Component on page 926
How to delete tiering setup of a rate component	Deleting Tiering Setup of a Rate Component on page 927

Defining Tiering Setup of a Rate Component

Prerequisites

To define tiering setup of a rate component, you should have:

- Rate schedules defined in the application
- Rate components of the rate schedule defined in the application

Procedure

To define tiering setup of a rate component:

1. Click the **Menu** link in the **Application** toolbar.

A list appears.

- From the **Main** menu, select **Rates** and then click **Rate Definition**.

The **Rate Definition** screen appears.

- Select the rate schedule in the **Rate Schedule Components** zone.
- Click **Search**.

The rate components of the rate schedule appear as the search results.

- Click the **Broadcast** (📡) icon corresponding to the rate component whose tiering setup you want to define.

The **Create/Edit Rate Definition** zone appears.

- Select the tiering type from the list.
- Enter the maximum number of tiering ranges supported by the rate component.

Note:

The **Maximum Tiering Combinations** field is non-editable when you select the tiering type as **FLAT** or **STEP**. By default, **0** appears in the **Maximum Tiering Combinations** field when you select the tiering type as **FLAT**, and **1** appears when you select the tiering type as **STEP**.

- Enter the description for the tiering setup of the rate component.

For example, if you want the user to enter price per transaction for a tiering range, enter `Price Per Transaction` in the **Rate Component Map Description** field.

- Click **Save**.

The rate component map ID is generated automatically when you define the tiering setup of the rate component.

Related Topics

For more information on...	See...
Rate Definition screen	Rate Definition on page 923
Rate Schedule Components zone	Rate Schedule Components on page 923
Create/Edit Rate Definition zone	Create/Edit Rate Definition on page 924

Editing Tiering Setup of a Rate Component

Procedure

To edit tiering setup of a rate component:

- Click the **Menu** link in the **Application** toolbar.
A list appears.
- From the **Main** menu, select **Rates** and then click **Rate Definition**.

The **Rate Definition** screen appears.

- Select the rate schedule in the **Rate Schedule Components** zone.
- Click **Search**.

The rate components of the rate schedule appear as the search results.

5. Click the **Broadcast** (📡) icon corresponding to the rate component whose tiering setup you want to edit.
The **Create/Edit Rate Definition** zone appears.
6. Modify the details of the tiering setup.

Note: You can only modify the rate component map description.

7. Click **Save**.
The changes made to the tiering setup are saved.

Related Topics

For more information on...	See...
Rate Definition screen	Rate Definition on page 923
Rate Schedule Components zone	Rate Schedule Components on page 923
Create/Edit Rate Definition zone	Create/Edit Rate Definition on page 924

Deleting Tiering Setup of a Rate Component

Procedure

To delete tiering setup of a rate component:

1. Click the **Menu** link in the **Application** toolbar.
A list appears.
2. From the **Main** menu, select **Rates** and then click **Rate Definition**.
The **Rate Definition** screen appears.
3. Select the rate schedule in the **Rate Schedule Components** zone.
4. Click **Search**.
The rate components of the rate schedule appear as the search results.
5. Click the **Broadcast** (📡) icon corresponding to the rate component whose tiering setup you want to delete.
The **Create/Edit Rate Definition** zone appears.
6. Click **Delete**.

The tiering setup of the rate component is deleted, and the action that can be performed on the rate component changes from **Edit** to **Add** in the **Rate Schedule Components** zone.

Note:

The **Delete** button is disabled when you define the tiering setup of the rate component.
You can delete the tiering setup when the rate component is not yet used for any product pricing.

Related Topics

For more information on...	See...
Rate Definition screen	Rate Definition on page 923
Rate Schedule Components zone	Rate Schedule Components on page 923

For more information on...	See...
Create/Edit Rate Definition zone	Create/Edit Rate Definition on page 924

Tiering Criterion

Oracle Revenue Management and Billing (ORMB) provides you with the ability to create tiered pricing in case standard flat pricing is not sufficient to meet the business needs. Through tiered pricing, you can offer more favorable pricing to the customers based on service quantity utilization.

Let us understand this with the help of an example. ABC company uses wire transfer services provided by a large bank. If ABC company initiates up to 1,000 wire transfers, the fee charged by the bank will be \$5 per transfer. If ABC company initiates more than 1,000 wire transfers, the fee will be \$3 per transfer. To introduce this flexibility in the pricing model, you will have to define tiered pricing with the following tiering ranges:

- If the number of wire transfers is greater than 0 and less than or equal to 1000, then charge \$5 per transfer to ABC company.
- If the number of wire transfers is greater than 1000, then charge \$3 per transfer to ABC company.

In the above example, number of wire transfers is the tiering criterion, 0 – 1000 and 1000 – BLANK are tiering ranges, and \$5 and \$3 are rates per transfer.

The **Tiering Criteria** screen allows you to create and edit a tiering criterion. This screen consists of the following zones:

- [Tiering Criterion List](#) on page 928
- [Edit Tiering Criterion](#) on page 928
- [Create Tiering Criterion](#) on page 929

Tiering Criterion List

The **Tiering Criterion List** zone displays tiering criterion that are already defined in the system. This zone contains the following columns:

Column Name	Column Description
Tiering Criterion	Displays the code of the tiering criterion.
Description	Displays the description of the tiering criterion.
Service Quantity Identifier	Displays the Service Quantity Identifier (SQI) of the tiering criterion.

You can change the layout of this zone. For more information on how to change the layout, see [Changing the Layout](#) on page 3414.

On clicking the **Broadcast** () icon corresponding to the tiering criterion, the **Edit Tiering Criterion** zone appears with the details of the respective tiering criterion.

Edit Tiering Criterion

The **Edit Tiering Criterion** zone allows you to edit the tiering criterion. This zone contains the following fields:

Field Name	Field Description	Mandatory (Yes or No)
Tiering Criterion	Displays the code of the tiering criterion.	Not applicable

Field Name	Field Description	Mandatory (Yes or No)
Description	Used to modify the description of the tiering criterion.	Yes
Service Quantity Identifier	Displays the Service Quantity Identifier (SQI) of the tiering criterion.	Not applicable

This zone contains the following two buttons:

Button Name	Button Description
Save	Used to save the changes made in this zone.
Cancel	Used to clear the changes made in this zone.

By default, the **Edit Tiering Criterion** zone does not appear in the **Tiering Criteria** screen. It appears when you click the **Broadcast** (📡) icon corresponding to the tiering criterion in the **Tiering Criteria List** zone.

Related Topics

For more information on...	See...
How to edit a tiering criterion	Editing a Tiering Criterion on page 930

Create Tiering Criterion

The **Create Tiering Criterion** zone allows you to create tiering criterion. This zone contains the following fields:

Field Name	Field Description	Mandatory (Yes or No)
Tiering Criterion	Used to specify the code that uniquely identifies the tiering criterion.	Yes
Description	Used to specify the description for the tiering criterion.	Yes
Service Quantity Identifier	Used to specify the Service Quantity Identifier (SQI) for the tiering criterion. Note: During billing, the rating engine uses the SQI to determine which service quantities are applied to tiers.	Yes

This zone contains the following two buttons:

Button Name	Button Description
Save	Used to create the tiering criterion.
Cancel	Used to clear the fields in this zone.

Related Topics

For more information on...	See...
How to create a tiering criterion	Creating a Tiering Criterion on page 929

Creating a Tiering Criterion

Prerequisites

To create a tiering criterion, you should have:

- Service Quantity Identifiers (SQIs) defined in the application

Procedure

To create a tiering criterion:

1. Click the **Menu** link in the **Application** toolbar.
A list appears.
2. From the **Main** menu, select **Pricing Management** and then click **Tiering Criterion**.
The **Tiering Criterion** screen appears.
3. In the **Create Tiering Criterion** zone, enter the code that uniquely identifies the tiering criterion.
4. Enter the description for the tiering criterion.
5. Select the Service Quantity Identifier (SQI) that you want to associate with the tiering criterion.
6. Click **Save**.
The tiering criterion is created.

Related Topics

For more information on...	See...
Tiering Criterion screen	Tiering Criterion on page 928
Create Tiering Criterion zone	Create Tiering Criterion on page 929

Editing a Tiering Criterion

Procedure

To edit a tiering criterion:

1. Click the **Menu** link in the **Application** toolbar.
A list appears.
2. From the **Main** menu, select **Pricing Management** and then click **Tiering Criterion**.
The **Tiering Criterion** screen appears.
3. In the **Tiering Criterion** zone, click the **Broadcast** () icon corresponding to the tiering criterion whose details you want to edit.
The **Edit Tiering Criterion** zone appears.
4. Modify the description of the tiering criterion, if required.
5. Click **Save**.
The changes made to the tiering criterion are saved.

Related Topics

For more information on...	See...
Tiering Criterion screen	Tiering Criterion on page 928
Edit Tiering Criterion zone	Edit Tiering Criterion on page 928

Chapter 10

Division

Topics:

- [Division](#)

The following two types of divisions are used while defining a contract type:

- **General Ledger (GL) Division** — GL divisions typically comprise of individual entities (for example, companies) in the general ledger. You must set up a GL division for each such entity. The GL division is used to define the accounting period for financial transactions linked to contracts. Contracts are associated with GL divisions through their contract type. The system uses accounting periods to prevent a user from creating financial transactions in the closed periods. It also uses accounting periods when it generates the flat file that contains the consolidated journal entry that is interfaced to the general ledger.
- **Division** — A division is associated with a jurisdiction. A jurisdiction is a geographic-oriented entity with unique business rules. For example, if you conduct business in California and Japan, each jurisdiction has different set of rules, and therefore you need to have a separate jurisdiction for each division. You must set up a division for each jurisdiction in which you conduct the business. For the Pricing Management functionality, setting up a division is mandatory, and the system must contain information about at least one division.

A division is associated with the following:

- **Person** — You may or may not associate person to a division. It is optional. But, when you are using division specific functionality, you have to associate person to a division while creating a local person.
- **Contract** — Contract is associated to a division through its contract type. The contract type controls multiple business rules which are defined for a given jurisdiction and contract type combination. In addition to controlling the business rules defined on the contract's contract type, the contract's division also controls the type of collection criteria used to determine if and how to collect overdue debt.
- **Account** — The division on account when combined with the account's customer class defines the jurisdiction that governs financial business rules (for example, the bill's due date, when and how late payment charges are calculated, etc.). It also allows you to assign To Do entries associated with the account to a given To Do role based on the account's division.

Division

The **Division** screen allows you to define, edit, and delete a division. It consists of the following tabs:

Tab Name	Tab Description	Mandatory (Yes or No)
Main	Used to define basic details of a division.	Yes
Access Groups	Used to define the users who have right to associate objects (such as persons, accounts, price items, price lists, etc.) with this division. The users can only view those divisions to which they have access in the Division list used across the application.	No
Price Items	Used to define which price items are available to persons or accounts in a division.	No
	Note: Once the price item is created, you need to associate it with a division.	
Price Lists	Used to define which price lists are available to persons or accounts in a division.	No
	Note: Once the price list is created, you need to associate it with a division. You can associate a price list with a division when all price items in the price list are already associated with the division.	
Languages	Used to limit the languages that you can select for a person's bills and correspondence in a division.	No
Invoice Currencies	Used to limit the invoice currencies that you can select for accounts in a division.	No
	Note: Invoice currency is a currency in which the accounts in the division can be billed.	
Person Identifier Types	Used to limit the person identifier types that you can select for persons in a division.	No

Tab Name	Tab Description	Mandatory (Yes or No)
Algorithms	<p>Used to associate algorithms with the division. Once a division is created, you must associate the Price Assignment Search algorithm to it. For the Banking functionality, this is required to ensure that the price item pricing is displayed in the correct order as defined by the algorithm. Each division can have unique hierarchy order or more than one division can have the same hierarchy order. The hierarchy order is also used in billing when the price determination is controlled by the sort order definition of the algorithm.</p> <p>You can define algorithms in the Algorithm screen. The search order is governed by the second parameter of the algorithm, and the valid values for the same are:</p> <ul style="list-style-type: none"> • AGREED_PRICELIST - If you use this search order, the price item pricing is searched in the following order: Account Agreed, Account Price List, Account Inherited Price List, Customer Agreed, Customer Price List, Customer Inherited Price List, Parent Customer Agreed, Parent Customer Price List, and Parent Customer Inherited Price List. <div data-bbox="602 961 1114 1104" style="border: 1px solid black; padding: 5px;"> <p>Note: In this search order, the account agreed level has highest precedence and parent customer inherited price list level has lowest precedence.</p> </div> <ul style="list-style-type: none"> • AGREED_FIRST - If you use this search order, the price item pricing is searched in the following order: Account Agreed, Customer Agreed, Parent Customer Agreed, Account Price List, Account Inherited Price List, Customer Price List, Customer Inherited Price List, Parent Customer Price List, and Parent Customer Inherited Price List. <div data-bbox="602 1394 1114 1537" style="border: 1px solid black; padding: 5px;"> <p>Note: In this search order, the account agreed level has highest precedence and parent customer inherited price list level has lowest precedence.</p> </div>	No
Characteristics	Used to define the characteristics for a division.	No
Bill Messages	Used to specify the bill messages that are valid for accounts in a division.	No
Party Char Types	Used to limit the characteristic types that you can select for persons and accounts in a division.	No
Bill Cycles	Used to limit the bill cycles that you can select for accounts in a division.	No
Account Identifier Types	Used to limit the account identifier types that you can select for accounts in a division.	No

Tab Name	Tab Description	Mandatory (Yes or No)
Price Item Characteristics	Used to define division-specific characteristics for price items associated with the division.	No

Related Topics

For more information on...	See...
How to define a division	Defining a Division on page 944
How to associate access groups with a division	Associating an Access Group with a Division on page 947
How to associate price items with a division	Associating a Price Item or Price Item Bundle with a Division on page 948
How to associate price lists with a division	Associating a Price List with a Division on page 950
How to associate languages with a division	Associating a Language with a Division on page 951
How to associate invoice currencies with a division	Associating an Invoice Currency with a Division on page 952
How to associate person identifier types with a division	Associating a Person Identifier Type with a Division on page 953
How to associate algorithms with a division	Associating an Algorithm with a Division on page 954
How to define a characteristic for a division	Defining a Characteristic for a Division on page 961
How to associate bill messages with a division	Associating a Bill Message with a Division on page 962
How to associate party characteristic types with a division	Associating a Party Characteristic Type with a Division on page 964
How to associate bill cycles with a division	Associating a Bill Cycle with a Division on page 965
How to associate account identifier types with a division	Associating an Account Identifier Type with a Division on page 966
How to define division-specific characteristics for a price item	Defining a Division-Specific Characteristic for a Price Item on page 967

Division - Main

The **Main** tab displays the basic information about the division. It contains the following fields:

Field Name	Field Description
Division	Indicates the division. Note: The Search (🔍) icon appears corresponding to the Division field. On clicking the Search icon, the Division Search window appears where you can search for a division.
Description	Displays the description of the division.
Work Calendar	Indicates the work calendar which is associated with the division.

Field Name	Field Description
Status	Indicates the status of the division. The valid values are: <ul style="list-style-type: none"> Active Pending Retired
Bill Format	Indicates the format in which the bills should be printed for the accounts which belong to the division. The valid values are: <ul style="list-style-type: none"> Detailed Summary
Bill Route Type	Indicates how the bills must be sent to the main customer of the accounts which belong to the division.
Base Currency	Indicates the currency in which the GL entries should be created for the accounts which belong to the division.
Time Zone	Indicates the time zones in which the division is operational.
Eligible for Accrual	Indicates whether accrual should be calculated for the accounts which belong to the division.
Accrual Cycle	Indicates the accrual cycle of the accounts which belong to the division.
Comments	Displays additional details about the division.
Business Object	Indicates the business object using which the division is created in the system.

In addition, the **Main** tab contains the following fields in a grid:

Field Name	Field Description
To Do Type	Indicates the To Do type for which division-specific To Do role is defined.
To Do Role	Indicates the To Do role whose users must receive the To Do entries of the specified To Do type for the accounts which belong to the division.

Related Topics

For more information on...	See...
How to define a division	Defining a Division on page 944

Division - Access Groups

The **Access Groups** tab lists the access groups which are associated with the division. It contains the following field:

Field Name	Field Description
Division	Indicates the division.

In addition, the following fields appear in a grid:

Field Name	Field Description
Access Group	Indicates the access group which is associated with the division.
Description	Displays the description of the access group.

Related Topics

For more information on...	See...
How to associate an access group with a division	Associating an Access Group with a Division on page 947

Division - Price Items

The **Price Items** tab lists the price items which are associated with the division. It contains the following field:

Field Name	Field Description
Division	Indicates the division.

In addition, the following fields appear in a grid:

Field Name	Field Description
Price Item	Indicates the price item which is associated with the division.
Description	Displays the description of the price item.
Accrual Type Criteria	Indicates whether the billable charges of the price item should be considered for accrual depending on the accrual criteria specified in the accrual type. The valid values are: <ul style="list-style-type: none"> • Actual • Historical • Not Applicable

Related Topics

For more information on...	See...
How to associate a price item with a division	Associating a Price Item or Price Item Bundle with a Division on page 948

Division - Price Lists

The **Price Lists** tab lists the price lists which are associated with the division. It contains the following field:

Field Name	Field Description
Division	Indicates the division.

In addition, the following fields appear in a grid:

Field Name	Field Description
Price List ID	Indicates the price list.
Description	Displays the description of the price list.

Related Topics

For more information on...	See...
How to associate a price list with a division	Associating a Price List with a Division on page 950

Division - Languages

The **Languages** tab lists the languages which you can select for generating invoice and correspondence for the accounts in the division. It contains the following field:

Field Name	Field Description
Division	Indicates the division.

In addition, the following field appears in a grid:

Field Name	Field Description
Language	Indicates the language associated with the division.

Related Topics

For more information on...	See...
How to associate a language with a division	Associating a Language with a Division on page 951

Division - Invoice Currencies

The **Invoice Currencies** tab lists the currencies which you can use for generating the invoice of the accounts in the division. It contains the following field:

Field Name	Field Description
Division	Indicates the division.

In addition, the following fields appear in a grid:

Field Name	Field Description
Currency	Indicates the currency.
Rounding Type	Indicates the rounding type for the currency. The valid values are: <ul style="list-style-type: none"> • Down • Nearest • Up

Related Topics

For more information on...	See...
How to associate an invoice currency with a division	Associating an Invoice Currency with a Division on page 952

Division - Person Identifier Types

The **Person Identifier Types** tab lists the identifier types which are valid for the persons associated with the division. It contains the following field:

Field Name	Field Description
Division	Indicates the division.

In addition, the following field appears in a grid:

Field Name	Field Description
Person Identifier Type	Indicates the person identifier type.

Related Topics

For more information on...	See...
How to associate a person identifier type with a division	Associating a Person Identifier Type with a Division on page 953

Division - Algorithms

The **Algorithms** tab lists the algorithms which are associated with the division. It contains the following field:

Field Name	Field Description
Division	Indicates the division.

In addition, the following fields appear in a grid:

Field Name	Field Description
Division Algorithm Entity	Indicates the algorithm entity to which you want to attach the algorithm.
Sequence Number	Displays the order in which the algorithms with the same entity should be executed.
Algorithm	Indicates the algorithm.
Description	Displays the description of the algorithm.

Related Topics

For more information on...	See...
How to associate an algorithm with a division	Associating an Algorithm with a Division on page 954

Division - Characteristics

The **Characteristics** tab lists the characteristics which are defined for the division. It contains the following field:

Field Name	Field Description
Division	Indicates the division.

In addition, the following fields appear in a grid:

Field Name	Field Description
Effective Date	Indicates the date from when the characteristic is effective for the division.
Characteristic Type	Indicates the characteristic type.
Characteristic Value	Indicates the value for the characteristic type.

Related Topics

For more information on...	See...
How to define a characteristic for a division	Defining a Characteristic for a Division on page 961

Division - Bill Messages

The **Bill Messages** tab lists the bill messages which are valid for the accounts in the division for a specified duration. It contains the following field:

Field Name	Field Description
Division	Indicates the division.

In addition, the following fields appear in a grid:

Field Name	Field Description
Start Date	Indicates the date from when you want the bill message to appear on the bill.
End Date	Indicates the date till when you want the bill message to appear on the bill.
Bill Message	Indicates the bill message that is valid for the accounts in the division.
Description	Displays the description of the bill message.

Related Topics

For more information on...	See...
How to associate a bill message with a division	Associating a Bill Message with a Division on page 962

Division - Party Char Types

The **Party Char Types** tab lists the characteristic types which are valid for the persons and accounts associated with the division. It contains the following field:

Field Name	Field Description
Division	Indicates the division.

In addition, the following fields appear in a grid:

Field Name	Field Description
Characteristic Entity	Indicates whether the characteristic type is valid for a person or an account in this division.
Characteristic Type	Indicates the characteristic type.

Related Topics

For more information on...	See...
How to associate a party char type with a division	Associating a Party Characteristic Type with a Division on page 964

Division - Bill Cycles

The **Bill Cycles** tab lists the bill cycles which are valid for the accounts associated with the division. It contains the following field:

Field Name	Field Description
Division	Indicates the division.

In addition, the following field appears in a grid:

Field Name	Field Description
Bill Cycle	Indicates the bill cycle.

Related Topics

For more information on...	See...
How to associate a bill cycle with a division	Associating a Bill Cycle with a Division on page 965

Division - Account Identifier Types

The **Account Identifier Types** tab lists the identifier types which are valid for the accounts associated with the division. It contains the following field:

Field Name	Field Description
Division	Indicates the division.

In addition, the following field appears in a grid:

Field Name	Field Description
Account Identifier Type	Indicates the account identifier type.

Related Topics

For more information on...	See...
How to associate an account identifier type with a division	Associating an Account Identifier Type with a Division on page 966

Division - Price Item Characteristics

The **Price Item Characteristics** tab lists division-specific characteristics of price items which are associated with the division. It contains the following field:

Field Name	Field Description
Division	Indicates the division.

In addition, the following fields appear in a grid:

Field Name	Field Description
Price Item	Displays the price item count associated with the selected division to which the user belongs.
Price Item	Displays the price item associated with the division to which the user belongs.
Effective Date	Indicates the date from when the price item characteristic is effective for the division.

Field Name	Field Description
Characteristic Type	Indicates the characteristic type.
Characteristic Value	Displays the value for the characteristic type.

Related Topics

For more information on...	See...
How to define a division-specific characteristic for a price item	Defining a Division-Specific Characteristic for a Price Item on page 967

Searching for a Division

Procedure

To search for a division:

1. Click the **Admin** link in the **Application** toolbar.
A list appears.
2. From the **Admin** menu, select **D** and then click **Division**.
A sub-menu appears.
3. Click the **Search** option from the **Division** sub-menu.

The **Division Search** window appears. It contains the following two sections:

- **Search Criteria** - The **Search Criteria** section contains the following fields:

Field Name	Field Description	Mandatory (Yes or No)
Division	Used to search for a particular division.	No
Description	Used to search division with a particular name.	No

Note: You must specify at least one search criterion while searching for a division.

- **Search Results** - On clicking the **Search** button corresponding to the respective field, the search results appear based on the specified search criteria. The **Search Results** section contains the following columns:

Column Name	Column Description
Division	Displays the division.
Description	Displays the description of the division.

Note: ORMB search engine supports wildcard search, where you can substitute the percentage (%) symbol as a stand in for any word or letter in a search criteria. You can use the '%' wildcard character in all input fields except the date and ID fields. The '%' wildcard character is suffixed automatically at the end of the partial search criteria. Therefore, you may or may not specify the wildcard character at the end of the partial search criteria. However, you have to prefix the wildcard character manually wherever required.

4. In the **Search Results** section, click the division whose details you want to view or edit.

The **Division** screen appears.

Related Topics

For more information on...	See...
Division screen	<i>Division</i> on page 934

Defining a Division

Prerequisites

To define a division, you should have:

- Required division business object defined in the application
- Work calendars, bill route types, currencies, time zones, accrual cycles, To Do types, and To Do roles defined in the application
- Values defined for the **BILL_FORMAT_FLG** lookup field

Procedure

To define a division:

1. Click the **Admin** link in the **Application** toolbar.
A list appears.
2. From the **Admin** menu, select **D** and then click **Division**.
A sub-menu appears.
3. Click the **Add** option from the **Division** sub-menu.
The **Division** screen appears.
4. Ensure that the **Main** tab is selected.

The **Main** tab contains the following fields:

Field Name	Field Description	Mandatory (Yes or No)
Division	Used to specify the division.	Yes
Description	Used to specify the description for the division.	Yes
Work Calendar	Used to indicate the work calendar that you want to associate with the division. The work calendar indicates the days when the division is operational. It is used to ensure that the system calculated dates (for example, bill due date, credit and collection event dates, etc.) fall on a working day.	Yes
	Note: The list includes only those work calendars which are already defined in the system.	

Field Name	Field Description	Mandatory (Yes or No)
Status	<p>Used to indicate the status of the division. The valid values are:</p> <ul style="list-style-type: none"> • Active - Indicates that you can use the division in the system. • Pending - Indicates that the division is not yet available for use. • Retired - Indicates that the division is no longer available for use. <p>Note: The list includes only those statuses which are defined in the DIVISION_STATUS_FLG lookup field.</p>	No
Bill Format	<p>Used to specify the format in which the bills should be printed for the accounts which belong to the division. The valid values are:</p> <ul style="list-style-type: none"> • Detailed • Summary <p>Note: The list includes only those bill formats which are defined in the BILL_FORMAT_FLG lookup field.</p>	No
Bill Route Type	<p>Used to indicate how the bills must be sent to the main customer of the accounts which belong to the division.</p> <p>Note: The list includes only those bill route types which are already defined in the system.</p>	No
Base Currency	<p>Used to specify the currency in which the GL entries should be created for the accounts which belong to the division. If the account's invoice currency and division's base currency are different, the system converts the GL amount from the account's invoice currency to the division's base currency. In such cases, the system creates the financial transactions for the accounts in both the currencies (i.e. account's invoice currency and division's base currency).</p> <p>Note: The list includes only those currencies which are already defined in the system.</p>	Yes
Time Zone	<p>Used to indicate the time zone in which the division is operational.</p> <p>Note: The list includes only those time zones which are already defined in the system.</p>	No

Field Name	Field Description	Mandatory (Yes or No)
Eligible for Accrual	Used to indicate whether you can calculate accrual for the accounts which belong to the division.	No
Accrual Cycle	Used to indicate the accrual cycle for the accounts which belong to the division.	Yes (Conditional) Note: The field is required when the Eligible for Accrual option is selected.
	Note: This field is enabled when the Eligible for Accrual option is selected. The Search (🔍) icon appears corresponding to the Accrual Cycle field. On clicking the Search icon, the Accrual Cycle Search window appears.	
Comments	Used to specify additional details about the division.	No
Business Object	Used to indicate the business object using which you want to create the division.	Yes
	Note: The Search (🔍) icon appears corresponding to the Business Object field. On clicking the Search icon, the Business Object Search window appears.	

In addition, the **Main** tab contains the following fields in a grid:

Field Name	Field Description	Mandatory (Yes or No)
To Do Type	Used to indicate the To Do type for which you want to define division-specific To Do role.	Yes (Conditional) Note: This field is required when you are defining the division-specific To Do role for a To Do type.
	Note: The Search (🔍) icon appears corresponding to the To Do Type field. On clicking the Search icon, the To Do Type Search window appears.	
To Do Role	Used to indicate the To Do role whose users must receive the To Do entries of the specified To Do type for the accounts which belong to the division.	Yes (Conditional) Note: This field is required when you are defining the division-specific To Do role for a To Do type.
	Note: The Search (🔍) icon appears corresponding to the To Do Role field. On clicking the Search icon, the Role for To Do Type window appears.	

5. Enter the required details in the **Main** tab.
6. Associate access groups, price items, price lists, languages, invoice currencies, person identifier types, algorithms, bill messages, party characteristic types, bill cycles, and account identifier types with the division, if required.
7. Define characteristics for the division, if required.
8. Define division-specific characteristics for the price items, if required.

- Click the **Save** button in the **Page Title** area.

The division is defined. The status of the division is set to **Pending**.

Related Topics

For more information on...	See...
Division screen	Division on page 934
Main tab	Division - Main on page 936
How to associate an access group with a division	Associating an Access Group with a Division on page 947
How to associate a price item with a division	Associating a Price Item or Price Item Bundle with a Division on page 948
How to associate a price list with a division	Associating a Price List with a Division on page 950
How to associate a language with a division	Associating a Language with a Division on page 951
How to associate an invoice currency with a division	Associating an Invoice Currency with a Division on page 952
How to associate a person identifier type with a division	Associating a Person Identifier Type with a Division on page 953
How to associate an algorithm with a division	Associating an Algorithm with a Division on page 954
How to define a characteristic for a division	Defining a Characteristic for a Division on page 961
How to associate a bill message with a division	Associating a Bill Message with a Division on page 962
How to associate a party characteristic type with a division	Associating a Party Characteristic Type with a Division on page 964
How to associate a bill cycle with a division	Associating a Bill Cycle with a Division on page 965
How to associate an account identifier type with a division	Associating an Account Identifier Type with a Division on page 966
How to define a division-specific characteristic for a price item	Defining a Division-Specific Characteristic for a Price Item on page 967

Associating an Access Group with a Division

On associating an access group with a division, the users which belong to the access group can view the division in the respective list across the system. These users can then create and edit the accounts of the division.

Prerequisites

To associate an access group with a division, you should have:

- Access groups defined in the application

Procedure

To associate an access group with a division:

1. Search for the division to which you want to associate an access group.
2. Click the **Access Groups** tab in the **Division** screen.

The **Access Groups** tab appears. It contains the following field:

Field Name	Field Description
Division	Indicates the division.
	Note: The Search (🔍) icon appears corresponding to the Division field. On clicking the Search icon, the Division Search window appears where you can search for a division.

In addition, it contains the following fields in a grid:

Field Name	Field Description	Mandatory (Yes or No)
Access Group	Used to indicate the access group which you want to associate with the division.	Yes (Conditional)
	Note: The Search (🔍) icon appears corresponding to the Access Group field. On clicking the Search icon, the Access Group Search window appears. On specifying an access group, the description of the access group appears in the Description field.	Note: This field is required when you are associating an access group with the division.
Description	Displays the description of the access group.	Not applicable

- Enter the required details in the **Access Groups** tab.
- If you want to associate more than one access group with the division, click the **Add** (+) icon and then repeat step 3.

Note: However, if you want to remove an access group from the division, click the **Delete** (🗑️) icon corresponding to the access group.

- Click the **Save** button in the **Page Title** area.

The access group is associated with the division.

Related Topics

For more information on...	See...
How to search for a division	Searching for a Division on page 943
Division screen	Division on page 934
Access Groups tab	Division - Access Groups on page 937
How to define a division	Defining a Division on page 944

Associating a Price Item or Price Item Bundle with a Division

On associating a price item with a division, you can assign the price item to the persons and accounts which belong to the division. While associating a price item with a division, you can specify the accrual type criteria for the price item. The accrual type criteria is referred when the accrual is calculated for an account using an accrual type where the **Price Item Accrual Criteria Required** option is selected. The system behaves in the following manner when the **Price Item Accrual Criteria Required** option is selected in the accrual type:

If the accrual type criteria is set to...	Then...
Actual	The system considers the billable charges of the price item when the accrual is calculated for an account using the accrual type where the accrual criteria is set to Actual .
Historical	The system considers the billable charges of the price item when the accrual is calculated for an account using the accrual type where the accrual criteria is set to Historical .

Prerequisites

To associate a price item with a division, you should have:

- Price items defined in the application

Procedure

To associate a price item with a division:

1. Search for the division to which you want to associate a price item.
2. Click the **Price Items** tab in the **Division** screen.

The **Price Items** tab appears. It contains the following field:

Field Name	Field Description
Division	Indicates the division. Note: The Search (🔍) icon appears corresponding to the Division field. On clicking the Search icon, the Division Search window appears where you can search for a division.

In addition, it contains the following fields in a grid:

Field Name	Field Description	Mandatory (Yes or No)
Price Item	Used to indicate the price item which you want to associate with the division.	Yes (Conditional)
	Note: The Search (🔍) icon appears corresponding to the Price Item field. On clicking the Search icon, the Price Item Search window appears. On specifying a price item, the description of the price item appears in the Description field.	Note: This field is required when you are associating a price item with the division.
Description	Displays the description of the price item.	Not applicable

Field Name	Field Description	Mandatory (Yes or No)
Accrual Type Criteria	<p>Used to indicate whether the billable charges of the price item should be considered for accrual depending on the accrual criteria specified in the accrual type. The valid values are:</p> <ul style="list-style-type: none"> • Actual <ul style="list-style-type: none"> - Used to indicate that the billable charges of the price item should be considered for accrual when the accrual criteria in the accrual type is set to Actual. • Historical <ul style="list-style-type: none"> - Used to indicate that the billable charges of the price item should be considered for accrual when the accrual criteria in the accrual type is set to Historical. • Not Applicable <ul style="list-style-type: none"> - Used to indicate that the billable charges of the price item should be considered for accrual irrespective of the accrual criteria specified in the accrual type 	No

3. Enter the required details in the **Price Items** tab.
4. If you want to associate more than one price item with the division, click the **Add (+)** icon and then repeat step 3.

Note: However, if you want to remove a price item from the division, click the **Delete (🗑)** icon corresponding to the price item.

5. Click the **Save** button in the **Page Title** area.

The price item is associated with the division.

Related Topics

For more information on...	See...
How to search for a division	Searching for a Division on page 943
Division screen	Division on page 934
Price Items tab	Division - Price Items on page 938
How to define a division	Defining a Division on page 944

Associating a Price List with a Division

Prerequisites

To associate a price list with a division, you should have:

- Price lists defined in the application

Procedure

To associate a price list with a division:

1. Search for the division to which you want to associate a price list.
2. Click the **Price Lists** tab in the **Division** screen.

The **Price Lists** tab appears. It contains the following field:

Field Name	Field Description
Division	Indicates the division. Note: The Search (🔍) icon appears corresponding to the Division field. On clicking the Search icon, the Division Search window appears where you can search for a division.

In addition, it contains the following fields in a grid:

Field Name	Field Description	Mandatory (Yes or No)
Price List ID	Used to specify the price list which you want to associate with the division. Note: The Search (🔍) icon appears corresponding to this field. On clicking the Search icon, the Price List Search window appears. On specifying a price list, the description of the price list appears in the Description field.	Yes (Conditional) Note: This field is required when you are associating a price list with a division.
Description	Displays the description of the price list.	Not applicable

3. Enter the required details in the **Price Lists** tab.
4. If you want to associate more than one price list with the division, click the **Add** (+) icon and then repeat step 3.

Note: However, if you want to remove a price list from the division, click the **Delete** (🗑️) icon corresponding to the price list.

5. Click the **Save** button in the **Page Title** area.

The price list is associated with the division.

Related Topics

For more information on...	See...
How to search for a division	Searching for a Division on page 943
Price Lists tab	Division - Price Lists on page 938
Division screen	Division on page 934
How to define a division	Defining a Division on page 944

Associating a Language with a Division

Prerequisites

To associate a language with a division, you should have:

- Languages defined in the application

Procedure

To associate a language with a division:

1. Search for the division to which you want to associate a language.
2. Click the **Languages** tab in the **Division** screen.

The **Languages** tab appears. It contains the following field:

Field Name	Field Description
Division	Indicates the division.
	Note: The Search (🔍) icon appears corresponding to the Division field. On clicking the Search icon, the Division Search window appears where you can search for a division.

In addition, it contains the following field in a grid:

Field Name	Field Description	Mandatory (Yes or No)
Language	Used to specify the language which you want to select for generating invoice and correspondence for the accounts in the division.	No

3. Select the language from the list.
4. If you want to associate more than one language with the division, click the **Add** (+) icon and then repeat step 3.

Note: However, if you want to remove a language from the division, click the **Delete** (🗑️) icon corresponding to the language.

5. Click the **Save** button in the **Page Title** area.

The language is associated with the division.

Related Topics

For more information on...	See...
How to search for a division	Searching for a Division on page 943
Languages tab	Division - Languages on page 939
Division screen	Division on page 934
How to define a division	Defining a Division on page 944

Associating an Invoice Currency with a Division

Prerequisites

To associate an invoice currency with a division, you should have:

- Currencies defined in the application

Procedure

To associate an invoice currency with a division:

1. Search for the division to which you want to associate an invoice currency.

- Click the **Invoice Currencies** tab in the **Divisions** screen.

The **Invoice Currencies** tab appears. It contains the following field:

Field Name	Field Description
Division	Indicates the division. Note: The Search (🔍) icon appears corresponding to the Division field. On clicking the Search icon, the Division Search window appears where you can search for a division.

In addition, it contains the following fields in a grid:

Field Name	Field Description	Mandatory (Yes or No)
Currency	Used to indicate the currency which you want to use for generating the invoice of the accounts in the division.	Yes (Conditional) Note: This field is required when you are associating an invoice currency with the division.
Rounding Type	Used to indicate the rounding type for the currency. The valid values are: <ul style="list-style-type: none"> Down Nearest Up 	Yes (Conditional) Note: This field is required when you are associating an invoice currency with the division.

- Select the currency and its rounding type from the respective list.
- If you want to associate more than one invoice currency with the division, click the **Add** (+) icon and then repeat step 3.

Note: However, if you want to remove an invoice currency from the division, click the **Delete** (🗑️) icon corresponding to the currency.

- Click the **Save** button in the **Page Title** area.

The invoice currency is associated with the division.

Related Topics

For more information on...	See...
How to search for a division	Searching for a Division on page 943
Invoice Currencies tab	Division - Invoice Currencies on page 939
Division screen	Division on page 934
How to define a division	Defining a Division on page 944

Associating a Person Identifier Type with a Division

Prerequisites

To associate a person identifier type with a division, you should have:

- Person identifier types defined in the application

Procedure

To associate a person identifier type with a division:

1. Search for the division to which you want to associate a person identifier type.
2. Click the **Person Identifier Types** tab in the **Division** screen.

The **Person Identifier Types** tab appears. It contains the following field:

Field Name	Field Description
Division	Indicates the division. Note: The Search (🔍) icon appears corresponding to the Division field. On clicking the Search icon, the Division Search window appears where you can search for a division.

In addition, it contains the following field in a grid:

Field Name	Field Description	Mandatory (Yes or No)
Person Identifier Type	Used to indicate the person identifier type.	Yes (Conditional) Note: This field is required when you are associating a person identifier type with a division.

3. Select the person identifier type from the list.
4. If you want to associate more than one person identifier type with the division, click the **Add** (+) icon and then repeat step 3.

Note: However, if you want to remove a person identifier type from the division, click the **Delete** (🗑️) icon corresponding to the person identifier type.

5. Click the **Save** button in the **Page Title** area.

The person identifier type is associated with the division.

Related Topics

For more information on...	See...
How to search for a division	Searching for a Division on page 943
Person Identifier Types tab	Division - Person Identifier Types on page 939
Division screen	Division on page 934
How to define a division	Defining a Division on page 944

Associating an Algorithm with a Division

Prerequisites

To associate an algorithm with a division, you should have:

- Required algorithms defined in the application

Procedure

To associate an algorithm with a division:

1. Search for the division to which you want to associate the algorithm.

The **Division** screen appears.

2. Click the **Algorithms** tab.

The **Algorithms** tab appears. It contains the following field:

Field Name	Field Description
Division	<p>Indicates the division.</p> <p>Note: The Search (🔍) icon appears corresponding to the Division field. On clicking the Search icon, the Division Search window appears where you can search for a division.</p>

In addition, it contains the following fields in a grid:

Field Name	Field Description	Mandatory (Yes or No)
Division Algorithm Entity	<p>Used to indicate the algorithm entity to which you want to attach the algorithm. The valid values are:</p> <ul style="list-style-type: none"> • ASL Accumulation Post-Processing - Used to attach an algorithm which must be triggered for undertaking some post-processing activities on the aggregate stop-loss accumulation amount. This algorithm is invoked when you execute the C1-ACASL batch. <div style="border: 1px solid black; padding: 5px; margin: 5px 0;"> <p>Note: No algorithm types for this algorithm entity are shipped with the product. The implementation team can create custom algorithm type for this algorithm entity based on the customer requirements.</p> </div> <ul style="list-style-type: none"> • ASL Accumulation Pre-Processing - Used to attach an algorithm which must be triggered for undertaking some pre-processing activities on the aggregate stop-loss accumulation records. This algorithm is invoked when you execute the C1-ACASL batch. <div style="border: 1px solid black; padding: 5px; margin: 5px 0;"> <p>Note: No algorithm types for this algorithm entity are shipped with the product. The implementation team can create custom algorithm type for this algorithm entity based on the customer requirements.</p> </div> <ul style="list-style-type: none"> • Account - Post Processing - Used to attach an algorithm which must be triggered when you create or edit an account. <div style="border: 1px solid black; padding: 5px; margin: 5px 0;"> <p>Note: The C1-CLSACCT and C1-UACM-IC algorithm types are shipped with the product. For more information, see the algorithm type description.</p> </div> <ul style="list-style-type: none"> • Accrual - Used to attach an algorithm which must be triggered to create the accruals for the account. • Contract Derivation - Used to attach an algorithm which must be triggered to derive active contract for the account. This algorithm is invoked when you execute the C1-TXNVP batch. Note that this algorithm is invoked only when the account has multiple active contracts of the contract type which is associated with the price item. <div style="border: 1px solid black; padding: 5px; margin: 5px 0;"> <p>Note: The SA_DERV_POPC algorithm type is shipped with the product. For more information, see the algorithm type description.</p> </div>	<p>Yes (Conditional)</p> <div style="border: 1px solid black; padding: 5px; margin-top: 10px;"> <p>Note: This field is required when you are associating an algorithm with the division.</p> </div>

Field Name	Field Description	Mandatory (Yes or No)
	<ul style="list-style-type: none"> <li data-bbox="618 218 1122 373">• Currency Conversion For Adjustments - Used to attach a date or date and time based currency conversion algorithm which must be triggered while creating adjustments and FT GL entries for adjustments. <div data-bbox="651 401 1122 569" style="border: 1px solid black; padding: 5px; margin: 5px 0;"> <p>Note: The C1_CURALGAD and C1_EXCRTAD algorithm types are shipped with the product. For more information, see the algorithm type description.</p> </div> <ul style="list-style-type: none"> <li data-bbox="618 590 1122 745">• Currency Conversion For Bill Segments - Used to attach a date or date and time based currency conversion algorithm which must be triggered while creating bill segments and FT GL entries for bill segments. <div data-bbox="651 772 1122 940" style="border: 1px solid black; padding: 5px; margin: 5px 0;"> <p>Note: The C1_CURALGBS and C1_EXCRTBS algorithm types are shipped with the product. For more information, see the algorithm type description.</p> </div> <ul style="list-style-type: none"> <li data-bbox="618 961 1122 1150">• Currency Conversion For Payments - Used to attach a date or date and time based currency conversion algorithm which must be triggered while creating payments, payment tenders, and FT GL entries for payments. <div data-bbox="651 1178 1122 1346" style="border: 1px solid black; padding: 5px; margin: 5px 0;"> <p>Note: The C1_CURALGPY and C1_EXCRTPY algorithm types are shipped with the product. For more information, see the algorithm type description.</p> </div> <ul style="list-style-type: none"> <li data-bbox="618 1367 1122 1451">• GL Account Validation - Used to attach an algorithm which must be triggered during dynamic GL account validation. <div data-bbox="651 1478 1122 1625" style="border: 1px solid black; padding: 5px; margin: 5px 0;"> <p>Note: The C1-GLVAL and C1-GLVAL-COB algorithm types are shipped with the product. For more information, see the algorithm type description.</p> </div> <ul style="list-style-type: none"> <li data-bbox="618 1646 792 1667">• GL Assign - <li data-bbox="618 1688 1052 1709">• Generate Conditional GL Entries - <li data-bbox="618 1730 1122 1919">• Price Assignment Eligibility - Used to attach an algorithm which must be triggered to determine whether the post-processing pricing is eligible for the account. This algorithm is invoked when you execute the C1-BLPPR and POSTPROC batches. <div data-bbox="651 1946 1122 2100" style="border: 1px solid black; padding: 5px; margin: 5px 0;"> <p>Note: This algorithm is invoked while executing these batches when an algorithm created using the C1-GENBSICPA algorithm type</p> </div>	

Field Name	Field Description	Mandatory (Yes or No)
	<ul style="list-style-type: none"> <li data-bbox="618 218 1127 436">• Price Assignment Search - Used to attach an algorithm which indicates the order in which the price item pricing must be determined while billing. It also indicates the order in which the price item pricing must be listed in the Pricing (Account) and Pricing (Person) screens. <div data-bbox="651 464 1127 604" style="border: 1px solid black; padding: 5px; margin: 5px 0;"> <p>Note: The C1_PRASN_PP algorithm type is shipped with the product. For more information, see the algorithm type description.</p> </div> <ul style="list-style-type: none"> <li data-bbox="618 625 1127 674">• Pricing Fees Calculation Post-Processing - <li data-bbox="618 701 1127 749">• Pricing Fees Calculation Pre-Processing - <li data-bbox="618 756 1127 804">• Pricing Rate Post-Processing - <li data-bbox="618 810 1127 858">• Pricing Rate Pre-Processing - <li data-bbox="618 865 1127 968">• Sequential Bill Number Generation - Used to attach an algorithm which indicates how to sequence alternate bill numbers which are unique within the division. <div data-bbox="651 995 1127 1136" style="border: 1px solid black; padding: 5px; margin: 5px 0;"> <p>Note: The C1_ALTBLLDIV and C1_ALTBLDIV1 algorithm types are shipped with the product. For more information, see the algorithm type description.</p> </div> <ul style="list-style-type: none"> <li data-bbox="618 1184 1127 1402">• SSL Accumulation Pre-Processing - Used to attach an algorithm which must be triggered for undertaking some pre-processing activities on the aggregate stop-loss accumulation records. This algorithm is invoked when you execute the C1-ACSSL batch. <div data-bbox="651 1430 1127 1591" style="border: 1px solid black; padding: 5px; margin: 5px 0;"> <p>Note: No algorithm types for this algorithm entity are shipped with the product. The implementation team can create custom algorithm type for this algorithm entity based on the customer requirements.</p> </div> <ul style="list-style-type: none"> <li data-bbox="618 1619 1127 1866">• TFM - Billable Charge Post-Processing - Used to attach an algorithm which must be triggered for undertaking some post-processing activities on the billable charges which are generated through the transaction aggregation process. This algorithm is invoked when you execute the C1-TXNSQ and C1-TXNCU batches. <div data-bbox="651 1894 1127 2034" style="border: 1px solid black; padding: 5px; margin: 5px 0;"> <p>Note: The C1_BCHG_POPC algorithm type is shipped with the product. For more information, see the algorithm type description.</p> </div> <ul style="list-style-type: none"> <li data-bbox="618 2053 1127 2100">• TFM - Cancellation Pre-Processing - 	

Field Name	Field Description	Mandatory (Yes or No)
	<ul style="list-style-type: none"> <li data-bbox="618 218 1122 344">• TFM - Currency Conversion - Used to attach a date or date and time based currency conversion algorithm which must be triggered while aggregating transactions. <div data-bbox="651 365 1122 537" style="border: 1px solid black; padding: 5px; margin: 5px 0;"> <p>Note: The C1_CURALGTFM and C1_EXCRTTFM algorithm types are shipped with the product. For more information, see the algorithm type description.</p> </div> <ul style="list-style-type: none"> <li data-bbox="618 558 1122 747">• TFM - Disaggregation Pre-Processing - Used to attach an algorithm which must be triggered for undertaking some pre-processing activities while disaggregating the transactions. This algorithm is invoked when you execute the C1-PDTXN batch. <div data-bbox="651 768 1122 911" style="border: 1px solid black; padding: 5px; margin: 5px 0;"> <p>Note: The C1_DSAG_PRPC algorithm type is shipped with the product. For more information, see the algorithm type description.</p> </div> <ul style="list-style-type: none"> <li data-bbox="618 932 1122 995">• TFM - Disaggregation Request Post-Processing <li data-bbox="618 1016 1122 1205">• TFM - Price Item Derivation Post-Processing - Used to attach an algorithm which must be triggered for undertaking some post-processing activities on the transaction legs. This algorithm is invoked when you execute the C1-TXNIP batch. <div data-bbox="651 1226 1122 1360" style="border: 1px solid black; padding: 5px; margin: 5px 0;"> <p>Note: The C1_PRDR_POPC and C1-VALECRTRN algorithm types are shipped with the product. For more information, see the algorithm type description.</p> </div> <ul style="list-style-type: none"> <li data-bbox="618 1381 1122 1604">• TFM - Rate Post-Processing - Used to attach an algorithm which must be triggered for undertaking some post-processing activities while determining rate for transaction legs. This algorithm is invoked when you execute the C1-TXNEX and C1-TXNSQ batches. <div data-bbox="651 1625 1122 1793" style="border: 1px solid black; padding: 5px; margin: 5px 0;"> <p>Note: The C1-ASOEXPOS and C1_RTCL_POPC algorithm types are shipped with the product. For more information, see the algorithm type description.</p> </div> <ul style="list-style-type: none"> <li data-bbox="618 1814 1122 2024">• TFM - Rate Pre-Processing - Used to attach an algorithm which must be triggered for undertaking some pre-processing activities while determining rate for transaction legs. This algorithm is invoked when you execute the C1-TXNEX and C1-TXNSQ batches. <div data-bbox="651 2045 1122 2091" style="border: 1px solid black; padding: 5px; margin: 5px 0;"> <p>Note: The C1-RETFLAT and</p> </div>	

Field Name	Field Description	Mandatory (Yes or No)
	<ul style="list-style-type: none"> <li data-bbox="618 218 1122 407">• TFM - Rollback Pre-Processing - Used to attach an algorithm which must be triggered for undertaking some pre-processing activities while rolling back the transactions. This algorithm is invoked when you execute the C1-TXNRB batch. Note: The C1_ROBK_PRPC algorithm type is shipped with the product. For more information, see the algorithm type description. <li data-bbox="618 590 1122 806">• TFM - SSL Accumulation Post-Processing - Used to attach an algorithm which must be triggered for undertaking some post-processing activities on the specific stop-loss accumulation amount. This algorithm is invoked when you execute the C1-ACSSL batch. Note: No algorithm types for this algorithm entity are shipped with the product. The implementation team can create custom algorithm type for this algorithm entity based on the customer requirements. <li data-bbox="618 1024 1122 1276">• TFM - Verify Pricing Post-Processing - Used to attach an algorithm which must be triggered for undertaking some post-processing activities on a summary record in the CI_TXN_DTL_PRITM_SUMMARY table. This algorithm is invoked when you execute the C1-TXNVP batch. Note: The C1-VRPR_POPC algorithm type is shipped with the product. For more information, see the algorithm type description. 	
Sequence Number	Used to specify the order in which the algorithms with the same entity should be executed.	Yes (Conditional) Note: This field is required when you are associating an algorithm with the division.
Algorithm	Used to specify the algorithm code. Note: The Search (🔍) icon appears corresponding to the Algorithm field. On clicking the Search icon, the Algorithm Search window appears.	Yes (Conditional) Note: This field is required when you are associating an algorithm with the division.

Field Name	Field Description	Mandatory (Yes or No)
Description	Displays the description of the algorithm.	Not applicable
	Note: The description appears automatically when you specify the algorithm code in the Algorithm field.	

- Enter the required details in the **Algorithms** tab.
- If you want to associate more than one algorithm with the division, click the **Add (+)** icon and then repeat step 3.

Note: However, if you want to remove an algorithm from the division, click the **Delete (🗑)** icon corresponding to the algorithm.

- Click the **Save** button in the **Page Title** area.
The algorithm is associated with the division.

Related Topics

For more information on...	See...
How to search for a division	Searching for a Division on page 943
Algorithms tab	Division - Algorithms on page 940
Division screen	Division on page 934
How to define a division	Defining a Division on page 944

Defining a Characteristic for a Division

Prerequisites

To define a characteristic for a division, you should have:

- Characteristic types defined in the application (where the characteristic entity is set to Division)

Procedure

To define a characteristic for a division:

- Search for the division for which you want to define a characteristic.
- Click the **Characteristics** tab in the **Division** screen.

The **Characteristics** tab appears. It contains the following field:

Field Name	Field Description
Division	Indicates the division.
	Note: The Search (🔍) icon appears corresponding to the Division field. On clicking the Search icon, the Division Search window appears where you can search for a division.

In addition, it contains the following fields in a grid:

Field Name	Field Description	Mandatory (Yes or No)
Effective Date	Used to specify the date from when the characteristic is effective for the division.	Yes (Conditional)
		Note: This field is required when you are defining a characteristic for the division.
Characteristic Type	Used to indicate the characteristic type. Note: The list includes only those characteristic types where the characteristic entity is set to Division.	Yes (Conditional)
		Note: This field is required when you are defining a characteristic for the division.
Characteristic Value	Used to specify the value for the characteristic type. Note: The Search (🔍) icon appears corresponding to the Characteristic Value field. On clicking the Search icon, the Characteristic Value Search window appears. On specifying the value for a predefined characteristic type, the description of the characteristic value appears corresponding to the Characteristic Value field.	Yes (Conditional)
		Note: This field is required when you are defining a characteristic for the division.

- Enter the required details in the **Characteristics** tab.
- If you want to define more than one characteristic for the division, click the **Add** (+) icon and then repeat step 3.

Note: However, if you want to remove a characteristic from the division, click the **Delete** (🗑️) icon corresponding to the characteristic.

- Click the **Save** button in the **Page Title** area.
The characteristic is defined for the division.

Related Topics

For more information on...	See...
How to search for a division	Searching for a Division on page 943
Characteristics tab	Division - Characteristics on page 940
Division screen	Division on page 934
How to define a division	Defining a Division on page 944

Associating a Bill Message with a Division

Prerequisites

To associate a bill message with a division, you should have:

- Bill messages defined in the application

Procedure

To associate a bill message with a division:

1. Search for the division to which you want to associate a bill message.
2. Click the **Bill Messages** tab in the **Division** screen.

The **Bill Messages** tab appears. It contains the following field:

Field Name	Field Description
Division	Indicates the division. Note: The Search (🔍) icon appears corresponding to the Division field. On clicking the Search icon, the Division Search window appears where you can search for a division.

In addition, it contains the following fields in a grid:

Field Name	Field Description	Mandatory (Yes or No)
Start Date	Used to specify the date from when you want the bill message to appear on the bill for the accounts in the division.	Yes (Conditional) Note: This field is required when you are associating a bill message with the division.
End Date	Used to specify the date till when you want the bill message to appear on the bill for the accounts in the division.	No
Bill Message	Used to specify the bill message which is valid for the accounts in the division. Note: The Search (🔍) icon appears corresponding to this field. On clicking the Search icon, the Bill Message Search window appears. On specifying a bill message, the description of the bill message appears in the Description field.	Yes (Conditional) Note: This field is required when you are associating a bill message with the division.
Description	Displays the description of the bill message.	Not applicable

3. Enter the required details in the **Bill Messages** tab.
4. If you want to associate more than one bill message with the division, click the **Add** (+) icon and then repeat step 3.

Note: However, if you want to remove a bill message from the division, click the **Delete** (🗑️) icon corresponding to the bill message.

5. Click the **Save** button in the **Page Title** area.

The bill message is associated with the division.

Related Topics

For more information on...	See...
How to search for a division	Searching for a Division on page 943

For more information on...	See...
Bill Messages tab	Division - Bill Messages on page 941
Division screen	Division on page 934
How to define a division	Defining a Division on page 944

Associating a Party Characteristic Type with a Division

Prerequisites

To associate a party char type with a division, you should have:

- Characteristic types defined in the application (where the characteristic entity is set to Division)

Procedure

To associate a party char type with a division:

1. Search for the division to which you want to associate a party char type.
2. Click the **Party Char Types** tab in the **Division** screen.

The **Party Char Types** tab appears. It contains the following field:

Field Name	Field Description
Division	Indicates the division. Note: The Search (🔍) icon appears corresponding to the Division field. On clicking the Search icon, the Division Search window appears where you can search for a division.

In addition, it contains the following fields in a grid:

Field Name	Field Description	Mandatory (Yes or No)
Characteristic Entity	Used to indicate whether the characteristic type is valid for a person or an account in the division.	Yes (Conditional) Note: This field is required when you are associating a party char type with the division.
Characteristic Type	Used to indicate the characteristic type. Note: The list includes only those characteristic types where the characteristic entity is set to Division.	Yes (Conditional) Note: This field is required when you are associating a party char type with the division.

3. Enter the required details in the **Party Char Types** tab.
4. If you want to associate more than one party char type with the division, click the **Add** (+) icon and then repeat step 3.

Note: However, if you want to remove a party char type from the division, click the **Delete** (🗑️) icon corresponding to the characteristic type.

5. Click the **Save** button in the **Page Title** area.

The party char type is associated with the division.

Related Topics

For more information on...	See...
How to search for a division	Searching for a Division on page 943
Party Char Types tab	Division - Party Char Types on page 941
Division screen	Division on page 934
How to define a division	Defining a Division on page 944

Associating a Bill Cycle with a Division

Prerequisites

To associate a bill cycle with a division, you should have:

- Bill cycles defined in the application

Procedure

To associate a bill cycle with a division:

1. Search for the division to which you want to associate a bill cycle.
2. Click the **Bill Cycles** tab in the **Division** screen.

The **Bill Cycles** tab appears. It contains the following field:

Field Name	Field Description
Division	Indicates the division. Note: The Search (🔍) icon appears corresponding to the Division field. On clicking the Search icon, the Division Search window appears where you can search for a division.

In addition, it contains the following field in a grid:

Field Name	Field Description	Mandatory (Yes or No)
Bill Cycle	Used to specify the bill cycle that is valid for the accounts associated with the division.	Yes (Conditional) Note: This field is required when you are associating a bill cycle with the division.

3. Select the bill cycle from the list.
4. If you want to associate more than one bill cycle with the division, click the **Add** (+) icon and then repeat step 3.

Note: However, if you want to remove a bill cycle from the division, click the **Delete** (🗑️) icon corresponding to the bill cycle.

5. Click the **Save** button in the **Page Title** area.

The bill cycle is associated with the division.

Related Topics

For more information on...	See...
How to search for a division	Searching for a Division on page 943
Bill Cycles tab	Division - Bill Cycles on page 941
Division screen	Division on page 934
How to define a division	Defining a Division on page 944

Associating an Account Identifier Type with a Division**Prerequisites**

To associate an account identifier type with a division, you should have:

- Account identifier types defined in the application

Procedure

To associate an account identifier type with a division:

1. Search for the division to which you want to associate an account identifier type.
2. Click the **Account Identifier Types** tab in the **Division** screen.

The **Account Identifier Types** tab appears. It contains the following field:

Field Name	Field Description
Division	Indicates the division. Note: The Search (🔍) icon appears corresponding to the Division field. On clicking the Search icon, the Division Search window appears where you can search for a division.

In addition, it contains the following field in a grid:

Field Name	Field Description	Mandatory (Yes or No)
Account Identifier Type	Used to specify the account identifier type valid for the accounts associated with the division.	Yes (Conditional) Note: This field is required when you are associating an account identifier type with the division.

3. Select the account identifier type from the list.
4. If you want to associate more than one account identifier type with the division, click the **Add** (+) icon and then repeat step 3.

Note: However, if you want to remove an account identifier type from the division, click the **Delete** (🗑️) icon corresponding to the account identifier type.

5. Click the **Save** button in the **Page Title** area.

The account identifier type is associated with the division.

Related Topics

For more information on...	See...
How to search for a division	Searching for a Division on page 943
Account Identifier Types tab	Division - Account Identifier Types on page 942
Division screen	Division on page 934
How to define a division	Defining a Division on page 944

Defining a Division-Specific Characteristic for a Price Item

Prerequisites

To define a division-specific characteristics for a price item, you should have:

- Characteristic types defined in the application (where the characteristic entity is set to Division/Price Item Combination)
- Price item associated with the division to which the user belongs

Procedure

To define a division-specific characteristic for a price item:

1. Search for the division for which you want to define a price item characteristic.
2. Click the **Price Item Characteristics** tab in the **Division** screen.

The **Price Item Characteristics** tab appears. It contains the following field:

Field Name	Field Description
Division	Indicates the division.
	Note: The Search (🔍) icon appears corresponding to the Division field. On clicking the Search icon, the Division Search window appears where you can search for a division.

In addition, it contains the following fields in a grid:

Field Name	Field Description	Mandatory (Yes or No)
Price Item	Indicates the price item count associated with the selected division.	No
Price Item	Indicates the price item code associated with the division to which the user belongs.	Not applicable
Effective Date	Used to specify the date from when the price item characteristic is effective for the division.	Yes (Conditional)
		Note: This field is required when you are defining a division-specific characteristic for the price item.

Field Name	Field Description	Mandatory (Yes or No)
Characteristic Type	Used to indicate the characteristic type.	Yes (Conditional)
	Note: The list includes only those characteristic types where the characteristic entity is set to Division/Price Item Combination.	Note: This field is required when you are defining a division-specific characteristic for the price item.
Characteristic Value	Used to specify the value for the characteristic type.	Yes (Conditional)
	Note: If you select a predefined characteristic type, the Search (🔍) icon appears corresponding to the Characteristic Value field. On clicking the Search icon, the Characteristic Value Search window appears. On specifying the value for a predefined characteristic type, the description of the characteristic value appears corresponding to the Characteristic Value field.	Note: This field is required when you are defining a division-specific characteristic for the price item.

- If the division has multiple price items associated with it, navigate to define a characteristic for the required price item.

Note: You can use the **Previous** (⬅️) and **Next** (➡️) buttons to navigate through the price items while defining their characteristics.

- Enter the required details in the **Price Item Characteristics** tab.
- If you want to define more than one division-specific characteristic for the price item, click the **Add** (+) icon and then repeat step 4.

Note: However, if you want to remove a division-specific characteristic from the price item, click the **Delete** (🗑️) icon corresponding to the characteristic.

- Click the **Save** button in the **Page Title** area.

The division-specific characteristic is defined for the price item.

Related Topics

For more information on...	See...
How to search for a division	Searching for a Division on page 943
Price Item Characteristics tab	Division - Price Item Characteristics on page 942
Division screen	Division on page 934
How to define a division	Defining a Division on page 944

Associating a To Do Type and To Do Role with a Division

Prerequisites

To associate a To Do type and To Do role with a division, you should have:

- To Do types and to do roles defined in the application
- To Do roles associated to the respective to do types

Procedure

To associate a To Do type and To Do role with a division:

1. Search for the division to which you want to associate a To Do type and To Do role.
2. Click the **Main** tab in the **Divisions** screen.
The **Main** tab appears.
3. The **To Do** section contains the following fields in a grid:

Field Name	Field Description	Mandatory (Yes or No)
To Do Type	Used to indicate the To Do type for which you want to define division-specific To Do role.	Yes (Conditional)
	Note: The Search (🔍) icon appears corresponding to the To Do Type field. On clicking the Search icon, the To Do Type Search window appears.	Note: This field is required when you are defining a To Do type for the division
To Do Role	Used to indicate the To Do role whose users must receive the To Do entries of the specified To Do type for the accounts which belong to the division.	Yes (Conditional)
	Note: The Search (🔍) icon appears corresponding to the To Do Role field. On clicking the Search icon, the Role for To Do Type window appears.	Note: This field is required when you are defining a division-specific To Do role for a To Do type

4. If you want to associate more than one To Do type and To Do role with the division, click the **Add** (+) icon and then repeat step 3.

Note: However, if you want to remove a To Do type and To Do role from the division, click the **Delete** (🗑️) icon corresponding to the To Do type.

5. Click the **Save** button in the **Page Title** area.

The To Do type and To Do role is associated with the division.

Related Topics

For more information on...	See...
How to search for a division	Searching for a Division on page 943
Main tab	Division - Main on page 936
Division screen	Division on page 934
How to define a division	Defining a Division on page 944

Chapter 11

Approval Workflow

Topics:

- [Most Commonly Used Terms](#)
- [Approval Workflow Process](#)
- [Prerequisites](#)
- [Approval Transaction](#)
- [Comparison: New versus Existing](#)
- [Approve Price Assignment](#)
- [Modify Price Assignment](#)
- [Resolve Price Assignment](#)
- [Approval Workflow Group \(Used for Searching\)](#)
- [Approval Workflow Group \(Used for Viewing\)](#)
- [Approval Workflow Chain \(Used for Searching\)](#)
- [Approval Workflow Chain \(Used for Viewing\)](#)
- [Approval Workflow Criterion Type \(Used for Searching\)](#)
- [Approval Workflow Criterion Type \(Used for Viewing\)](#)
- [Approval Workflow Group Chain Linkage \(Used for Searching\)](#)
- [Approval Workflow Group Chain Linkage \(Used for Viewing\)](#)
- [Approval Workflow Setting \(Used for Searching\)](#)
- [Approval Workflow Setting \(Used for Viewing\)](#)
- [Approval Workflow Reason \(Used for Searching\)](#)

Oracle Revenue Management and Billing may optionally be configured to use the approval workflow process whenever any addition, modification, or deletion is done manually by a user. The approval workflow process routes any changes made to the business objects (such as person, account, contract, division, and so on) to a group of people for approval. The approval workflow process allows you to manage and track all tasks involved in the approval process.

Approval workflow allows you to define the rules for requiring an approval step before the data changes are committed to the database. Once you establish the approval workflow rules, the application manages the business process flow for having data changes approved before they are reflected in the database.

The system provides you with a flexible set of options used to determine when approvals are required, and how the approval process is to be managed including:

- Turning approval on or off for individual business objects within the application
- Grouping business objects so that approval is required for the group rather than the individual business objects within the group
- Who should approve
- How many levels of approvals are required
- Different approval workflow chains based on different criteria

Once you have turned approval workflow on for an object, or a group of objects, the system will use the approval workflow configuration to manage the entire approval process including:

- Determining whether approval is required based on data changes submitted by a user
- Routing approval workflow requests to one or more qualified approvers
- Managing rejected data changes and sending these back to the submitter for resolution
- Committing the changes once all required approvals are received

- *Approval Workflow Reason
(Used for Viewing)*

Most Commonly Used Terms

Before you understand the approval workflow process, you must familiarize yourself with the following terms:

Term	Description
Submitter	A person who adds, modifies or deletes a business object, such as person, account, contract, and division is called a submitter.
Approver	A person who approves any changes made to a business object is called an approver.
Approval Workflow Group	A group of one or more business objects for which approval is required, under some or all conditions, when data changes are made.
Approval Workflow Chain	The approval workflow chain indicates how many levels of approvals are required to approve the changes made by the submitter.

Approval Workflow Process

When a submitter adds, edits or deletes a business object (for example, an account) that belongs to an approval workflow group, the system checks whether approval workflow is activated for the approval workflow group. If the approval workflow is activated for the group, the system creates an approval workflow request. Every approval workflow request is uniquely identified in the system through the Approval Transaction ID.

The system identifies the approval workflow chain that must be used for approval depending on the pre-configured conditions or criteria. Based on the number of levels defined in the approval workflow chain, the request is sent to the approver at each level in the chain or hierarchy for approval. When the approver at the first level approves the request, a notification is sent to the approver at the second level for approval. This process continues till the approval is received from all levels in the hierarchy. Once the approvers at all levels approve the request, the changes are committed to the database.

However, if an approver at any level in the hierarchy rejects the request, a notification is sent to the submitter who has made the changes. The submitter then makes the required corrections based on the approver's comments and resubmits the changes for approval. In this case, the approval process starts once again from the beginning and not from the level at which the request was rejected.

The submitter also has the facility to modify the request before the approver at the first level in the hierarchy approves or rejects the request. Once the changes are made, the submitter submits the request for approval. The submitter also has the facility to cancel the request.

The following figure indicates the flow of the approval workflow process:

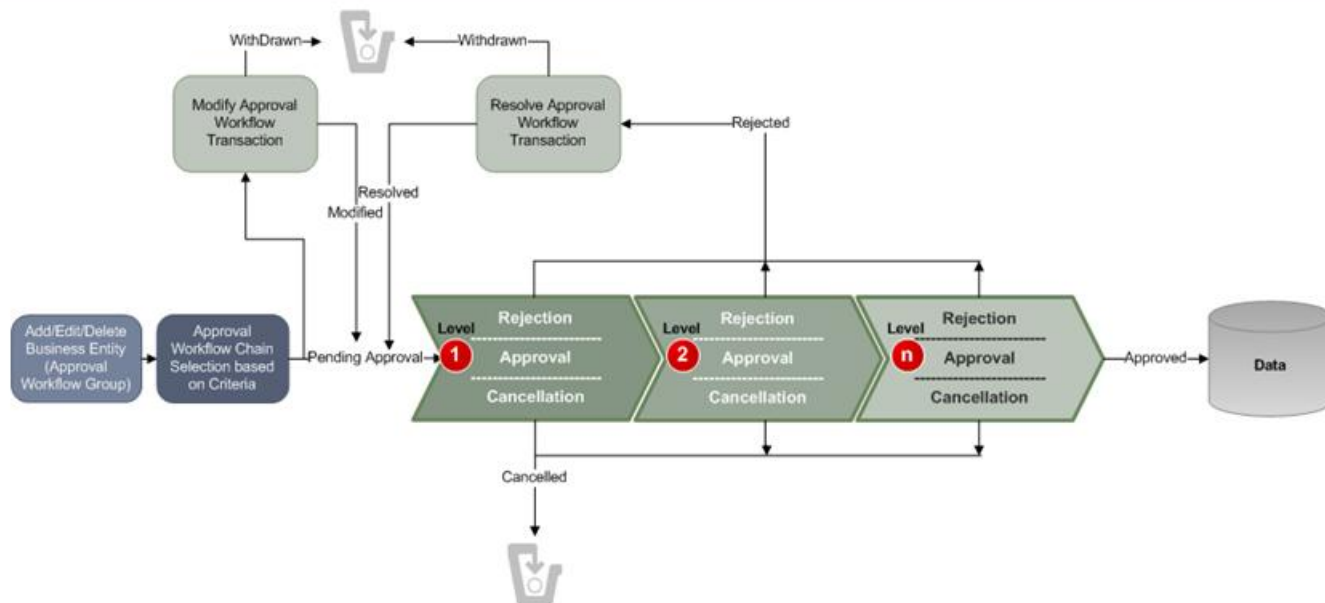

To implement the approval workflow process, you need to define the following:

- [Approval Workflow Group \(Used for Searching\)](#) on page 1028
- [Approval Workflow Chain \(Used for Searching\)](#) on page 1045
- [Approval Workflow Criterion Type \(Used for Searching\)](#) on page 1052
- [Approval Workflow Group Chain Linkage \(Used for Searching\)](#) on page 1058
- [Approval Workflow Reason \(Used for Searching\)](#) on page 1075
- [Approval Workflow Setting \(Used for Searching\)](#) on page 1068

For price list, price item and price assignment, the approval workflow configuration is shipped with ORMB. The following groups are available in the system:

- **C1PRODUCT** – Contains the C1_PRICEITEM_BO business object
- **C1PRICELST** – Contains the C1_F_ADDPLBO business object
- **C1PRICEASG** – Contains the C1_PRICECOMP and C1_PRICEASGN_BO business objects

After creating the approval workflow chains, you need to link these groups to the corresponding approval workflow chains. To setup the approval workflow process for price assignment, you need to do the following:

For Price Item	<ol style="list-style-type: none"> 1. If a Determine BO algorithm is not specified for the C1_PRICEITEM maintenance object, create a Determine BO algorithm using the F1-MOBO algorithm type and specify C1_PRICEITEM_BO as the business object on this algorithm. 2. Attach this algorithm on the Determine BO algorithm spot of the C1_PRICEITEM MO. 3. Link the C1PRODUCT group to the appropriate approval workflow chain. 4. Activate the approval workflow for the C1PRODUCT group by setting the Active flag corresponding to the group in the Approval Workflow Settings screen to Y.
----------------	---

For Price List	<ol style="list-style-type: none"> 1. If a Determine BO algorithm is not specified for the C1_PRICELIST maintenance object, create a Determine BO algorithm using the F1-MOBO algorithm type and specify C1_F_ADDPLBO as the business object on this algorithm. 2. Attach this algorithm on the Determine BO algorithm spot of the C1_PRICELIST MO. 3. Link the C1PRICELST group to the appropriate approval workflow chain. 4. Activate the approval workflow for the C1PRICELST group by setting the Active flag corresponding to the group in the Approval Workflow Settings screen to Y.
For Price Assignments	<ol style="list-style-type: none"> 1. If a Determine BO algorithm is not specified for the C1_PRICECOMP maintenance object, create a Determine BO algorithm using the F1-MOBO algorithm type and specify C1_PRICECOMP as the business object on this algorithm. 2. Attach this algorithm on the Determine BO algorithm spot of the C1_PRICECOMP MO. 3. If a Determine BO algorithm is not specified for the C1_PRICEASGN maintenance object, create a Determine BO algorithm using the F1-MOBO algorithm type and specify C1_PRICEASGN_BO as the business object on this algorithm. 4. Attach this algorithm on the Determine BO algorithm spot of the C1_PRICEASGN MO. 5. Link the C1PRICEASG group to the appropriate approval workflow chain. 6. Activate the approval workflow for the C1PRICEASG group by setting the Active flag corresponding to the group in the Approval Workflow Settings screen to Y.

Similarly, for invoicing group, the approval workflow configuration is shipped with ORMB. The following groups are available in the system:

- **C1IGADD**
- **C1IGUPD**

After creating the approval workflow chains, you need to link these groups to the corresponding approval workflow chains, and activate the approval workflow for these groups by setting the following in the **Approval Workflow Settings** screen:

- Set **Active** flag to **Yes**
- Set **Prevalidation** flag to **Yes**

Note: You must set the **Active** flag to **No** for both the groups in case you do not want to activate the approval workflow for invoicing group. If you set the **Active** flag to **Yes** for either of the groups, approval workflow is triggered when you add and/or edit an invoicing group.

Prerequisites

You need to setup the following prerequisites to implement the approval workflow process:

- **Setup Feature Configuration for Approval Workflow** — If you create new Maintenance Objects (MOs) and want the access control for these MOs in the approval workflow transactions to be based on the access group and division, then you have to create a custom algorithm and attach it to the **Approval Transaction Entity Access Algorithms** option type of the **C1_AXENTITY** feature configuration. Note that you will then have two access algorithms; one default algorithm (that is, **C1-APPTXN**) and another custom algorithm. For more information

about the **C1_AXENTITY** feature configuration, see [Setting the C1_AXENTITY Feature Configuration](#) on page 3441.

- **Create and Attach Determine BO Algorithm** — To use approval workflow for a business object, check the corresponding maintenance object to see if a **Determine BO** algorithm is already attached to it. If not, create a **Determine BO** algorithm using the **F1-MOBO** algorithm type, and specify the appropriate business object name on the newly created algorithm. Attach this algorithm on the **Determine BO** algorithm spot of the maintenance object.
- **Attach Audit Algorithm to Business Objects** — To use the approval workflow process for a business object, you need to attach the **C1-APPTXNBAS** algorithm on the **Audit** algorithm spot of the business object. Unless you attach the audit algorithm to a business object, the approval workflow process will not be triggered for the respective business object. This step is only required when you are using the base panels. If you have created custom UI maps to enter or modify data for a specific business object, this step is not needed.
- **Attach Validation Algorithms to Business Objects** — The following algorithms are shipped with ORMB:

Business Object	Basic Validation Algorithm	Pending Transaction Validation Algorithm
C1-AppBOChain	C1-GRPCHNALG	C1-APPGRPCHL
C1-AppGrp	C1-GRPALG	C1-APPGROUPV
C1-ApprovalChainEligible	C1-ADMALG	C1-APGBYPORT
C1-ApprovalTransactionChain	C1-APCHALGO	C1-APCHNPEND

The basic validation algorithms are attached to the respective business objects, and then shipped with ORMB. However, the pending transaction validation algorithms are not attached to the respective business objects. If you want to restrict the users from either editing or deleting the approval workflow group, approval workflow settings, approval workflow chain, or approval workflow group chain linkage when the respective approval workflow requests are in the **Pending**, **Work-in-Progress**, or **Rejected** state, then you must attach the pending transaction validation algorithm on the **Validation** algorithm spot of the respective business object.

- **Set Colors for Highlighting during Comparison** — While approving, rejecting, or cancelling approval workflow requests where the submitter action is Update (UPD), you will be able to compare the existing and new data. By default, any modifications are highlighted in the Yellow (9933FF) color and new additions are highlighted in the Purple (FFFF66) color. You can easily change these default colors. For more information on how to set the colors used for highlighting, see [Setting the C1_AXENTITY Feature Configuration](#) on page 3441.
- **Create To Do Types** — You need to create the To Do types that you want to use in the approval workflow process. Once the To Do type is created, you need to link it to the required To Do roles so that users belonging to the To Do role can view and work on the To Do type.
- **Create To Do Roles** — You need to create the To Do roles that you want to use in the approval workflow process. Once the To Do role is created, you need to add the users whom you want to assign this role.

Note: User who is withdrawing the approval workflow request must be assigned to the To Do role to which the approver at the first level in the hierarchy is assigned. Otherwise, the user will not be able to withdraw the approval workflow request.

- **Create Input UI Map for an Approval Workflow Group** — The system provides you with the ability to automatically generate an Input UI map, and associate it with the approval workflow group. Alternatively, you can create an Input UI map manually, and attach it to the approval workflow group. For more information on how to create an Input UI map manually, see [Creating Input UI Map for an Approval Workflow Group](#) on page 3419.
- **Create Display UI Map for an Approval Workflow Group** — The system provides you with the ability to automatically generate a Display UI map, and associate it with the approval workflow group. Alternatively, you can create a Display UI map manually, and attach it to the approval workflow group. For more information on

how to create a Display UI map manually, see [Creating Display UI Map for an Approval Workflow Group](#) on page 3418.

Approval Transaction

If an approver at any level in the hierarchy rejects a request, a notification is sent to the submitters having the To Do role to resolve. The submitter then makes the required corrections based on the approver's comments, and resubmits the changes for approval. In this case, the approval process starts once again from the beginning, and not from the level at which the request was rejected.

The **Approval Transaction** screen allows you to resolve or withdraw a request. It consists of the following zones:

- [Search Approval Transaction](#)
- [Approval Transaction Log](#)

Search Approval Transaction

The **Search Approval Transaction** zone allows you to search for an approval transaction using various search criteria. It contains the following two sections:

- **Search Criteria** — The **Search Criteria** section contains the following fields:

Field Name	Field Description	Mandatory (Yes or No)
Search By	Used to indicate whether you want to search for an approval transaction using the task or approval transaction details. The valid values are: <ul style="list-style-type: none"> • Task Details • Approval Transaction Details 	Yes
	Note: By default, the Task Details option is selected.	
Status	Used to search approval transactions with a particular status. The valid values are: <ul style="list-style-type: none"> • Approved • Cancelled • Rejected • Inprocess • Pending • Deleted 	No
	Note: This field appears when you select the Approval Transaction Details option from the Search By list.	

Field Name	Field Description	Mandatory (Yes or No)
Task	Used to search approval transactions with a particular task. The valid values are: <ul style="list-style-type: none"> • Approve • Modify • Resolve 	Yes (Conditional)
	Note: This field appears when you select the Task Details option from the Search By list.	Note: This field is required when you want to search approval transactions using the task details.
Approval Workflow Group	Used to search approval transactions created for the business objects that belong to a particular approval workflow group.	No
Division	Used to search approval transactions which belong to a particular division.	No
	Note: You can only view those divisions to which you have access in the Division list.	
Reference ID	Used to search approval transactions created for the business object with a particular reference ID.	No
Approval Transaction ID	Used to search for a particular approval transaction.	No
Created From	Used to search approval transactions which are created from a particular date onwards.	No
Created Until	Used to search approval transactions which are created till a particular date.	No
Action	Used to search approval transactions which are created while adding, updating, or deleting a business object.	No
Submitter ID	Used to search approval transactions which are created by a particular submitter.	No
	Note: This field appears either when you select the Task Details from the Search By list and Approve option from the Task list or when you select the Approval Transaction Details from the Search By list and Processing, Pending, or Deleted option from the Approval Transaction Status list. The Search (🔍) icon appears corresponding to this field. On clicking the Search icon, the Submitter Id for Status window appears.	

Field Name	Field Description	Mandatory (Yes or No)
Approver ID	Used to search approval transactions which are rejected by a particular approver. Note: The Approver ID is displayed when the approval transaction is searched by Task Details and Task is Resolve . It is also displayed when the approval transaction is searched by Approval Transaction Details and Status is Approved, Canceled, or Rejected . The Search (🔍) icon appears corresponding to this field. On clicking the Search icon, the Approver ID Search window appears.	No

Note: You must specify at least one search criterion while searching for an approval transaction. One more search criterion is required when you are searching for an approval transaction using the **Task** field.

- **Search Results** - On clicking the **Search** button, the search results appear based on the specified search criteria. The **Search Results** section contains the following columns:

Column Name	Column Description
Approval Transaction ID	Displays the approval transaction ID. Note: It has a link. The link appears when you select Task Details option from the Search By list. If the Approve option is selected from the Task list then on clicking the link, Comparison: New versus Existing window appears with the compared details of the new and existing approval transactions. If the Modify option is selected from the Task list then on clicking the link, Modify/Resolve Price List Assignment window appears to modify or resolve the details of price list assignment. If the Resolve option is selected from the Task list then on clicking the link, Modify/Resolve Price List Assignment window appears to modify or resolve the details of price list assignment.
Approval Workflow Group	Displays the code of the approval workflow group.
Submitter Name	Displays the name of submitter who submits the approval transaction details list. Note: This column appears either when you select the Approve or Modify option from the Task list or when you select the Processing, Pending, or Deleted option from the Approval Transaction Status list.
Approver Name	Displays the name of an approver who approves an approval transaction details list. Note: This column appears either when you select the Resolve option from the Task list or when you select the Approved, Canceled, or Rejected option from the Approval Transaction Status list.

Column Name	Column Description
Submitted On	Displays the date and time on which approval transaction is submitted for approval.
	Note: This column appears either when you select the Approve or Modify option from the Task list or when you select the Approved , Pending , or Deleted option from the Approval Transaction Details list.
Action	Indicates the various types of action. The valid values are: <ul style="list-style-type: none"> • Add • Delete (DEL) • Update (UPD)
Division	Displays the division to which the approval transaction belongs.
Status	Displays the status of approval transaction. The valid values are: <ul style="list-style-type: none"> • Approved • Cancelled • Rejected • Processing • Pending • Deleted
	Note: This column appears either when you select Approval Transaction Details option from the Search By list of the search criteria.
To Do Type	Displays the type of To Do (notification) received for the approval transaction.
Approval Transaction Information	Displays additional information about the approval transaction.
Rejected On	Displays the date and time on which the transaction is rejected.
	Note: This column appears either when you select the Resolve option from the Task list or when you select the Rejected , option from the Approval Transaction Details list.
Reject Reason	Displays the reason for which the approval transaction is rejected by the approver.
	Note: This column appears either when you select the Resolve option from the Task list or when you select the Rejected option from the Approval Transaction Details list.
Canceled On	Displays the date and time on which the approval transaction is canceled by the user.
	Note: This column appears when you select the Cancelled option from the Approval Transaction Details list.

Column Name	Column Description
Cancel Reason	Displays the reason for which the approval transaction is canceled by the user.
	Note: This column appears either when you select the Canceled option from the Approval Transaction Details list.
Withdraw	Displays a link to withdraw an approval transaction.
	Note: This column appears either when you select the Modify or Resolve option from the Task list. It has a link and on clicking the link, a message appears to confirm the withdrawal of the respective approval transaction.

On clicking the **Broadcast** () icon corresponding to the approval transaction the **Approval Transaction Log** zone appears with the approval transaction log details.

Related Topics

For more information on...	See...
Approval Transaction Log zone	Approval Transaction Log on page 981
How to search for an approval transaction	Searching for an Approval Transaction on page 982
How to view the log of an approval transaction	Viewing the Log of an Approval Transaction on page 982

Approval Transaction Log

The **Approval Transaction Log** zone displays the complete trail of submitter and approver actions performed on the approval transaction. It contains the following columns:

Column Name	Column Description
Date Time	Displays the date and time when the action was performed on the approval transaction.
User Name	Indicates the user who has performed the action on the approval transaction.
Status	Displays the status of the approval transaction. The valid values are: <ul style="list-style-type: none"> • Approved • Cancelled • Rejected • InProcess • Pending • Deleted
View	It has a link. On clicking the View link, the Comparison: New versus Existing window appears where you can view the existing and new compared transactions”.
Status Reason	Displays the status reason of the approval transaction.
Comments	Displays additional information about the approval transaction.

By default, the **Banking Approval Transaction Log** zone does not appear. It appears when you click the **Broadcast** () icon corresponding to the approval transaction in the **Approval Transaction** zone.

You can change the layout of this zone. For more information on how to change the layout, see [Changing the Layout](#) on page 3414.

Related Topics

For more information on...	See...
How to view the log of an approval transaction	Viewing the Log of an Approval Transaction on page 982

Searching for an Approval Transaction**Procedure**

To search for an approval transaction:

1. Click the **Menu** link in the **Application** toolbar.
A list appears.
2. From the **Main** menu, select **Approval Workflow** and then click **Approval Transaction**.
The **Approval Transaction** screen appears.
3. Click the **Search** option from the **Approval Transaction** sub-menu.
The **Approval Transaction** screen appears.
4. Enter the search criteria in the **Search Approval Transaction** zone depending on whether you want to search for a task or approval transaction details.

Note: ORMB search engine supports wildcard search, where you can substitute the percentage (%) symbol as a stand in for any word or letter in a search criteria. You can use the ‘%’ wildcard character in all input fields except the date and ID fields. The ‘%’ wildcard character is suffixed automatically at the end of the partial search criteria. Therefore, you may or may not specify the wildcard character at the end of the partial search criteria. However, you have to prefix the wildcard character manually wherever required.

5. Click **Search**.
A list of task or approval transactions that meet the search criteria appears in the **Search Results** section.

Related Topics

For more information on...	See...
Approval Transaction screen	Approval Transaction on page 977
Search Approval Transaction zone	Search Approval Transaction on page 977

Viewing the Log of an Approval Transaction**Procedure**

To view the log of an approval transaction:

1. Search for the task or approval transaction details in the **Approval Transaction** screen.
2. In the Search Results section, click the **Broadcast** () icon corresponding to the approval transaction whose log details you want to view.
The **Approval Transaction Log** zone appears.
3. View the log details of the approval transactions in the **Approval Transaction Log** zone.

Related Topics

For more information on...	See...
Search Approval Transaction zone	Search Approval Transaction on page 977
Approval Transaction Log zone	Approval Transaction Log on page 981

Comparison: New versus Existing

You have to define the reason codes which are used when the approval workflow request is either rejected or cancelled. The reason code helps to indicate the reason why a particular request was rejected or cancelled.

The **Comparison: New versus Existing** screen allows you to view the changes in the new approval transaction compared to the existing one. It contains the following sections:

- New
- Existing

Through this screen you can do the following:

- Approve an approval transaction
- Reject an Approval Transaction
- Cancel an approval transaction
- Modify an approval transaction
- Withdraw an Approval Transaction
- Resolve an approval transaction

Approving an Approval Transaction

You can view the number of approval transactions which are pending for approval in the **Approval Transaction** screen. The approver can review, and accordingly approve, return to the submitter, revert to the original, or cancel the approval transaction based on the observations.

Note: The system will not allow you to approve, return to the submitter, revert to the original or cancel an approval transaction submitted by you.

Procedure

To approve an approval transaction:

1. Search for approval transactions with task details and status as Approve in the **Approval Transaction** screen.
2. In the **Search Results** section, click the link in the **Approval Transaction ID** column corresponding to the approval transaction which you want to review.

The **Comparison: New versus Existing** screen appears.

3. Review the compared existing and new approval transactions.
4. Click **Approve**.

A message appears with confirmation on transaction approved successfully.

Note: ORMB search engine supports wildcard search, where you can substitute the percentage (%) symbol as a stand in for any word or letter in a search criteria. You can use the '%' wildcard character in all input fields except the date and ID fields. The '%' wildcard character is suffixed automatically at the end of the partial search criteria. Therefore, you may or may not specify the wildcard character at the end of the partial search criteria. However, you have to prefix the wildcard character manually wherever required.

5. Click **OK**.

The approval transaction is removed from the search results.

Note:

By default, any modifications will be highlighted in the Yellow (9933FF) color and new additions will be highlighted in the Purple (FFFF66) color. You can easily change these default colors. For more information on how to set the colors used for highlighting, see [Setting the CI_AXENTITY Feature Configuration](#) on page 3441.

6. Review the changes and click **Approve** to accept the changes.

The changes in the approval transaction are approved.

Related Topics

For more information on...	See...
Search Approval Transaction zone	Search Approval Transaction on page 977
Comparison: New versus Existing screen	Comparison: New versus Existing on page 983
How to search for an approval transaction	Searching for an Approval Transaction on page 982

Rejecting an Approval Transaction**Prerequisites**

To return an approval transaction to its submitter, you should have:

- Rejection reasons defined in the application

Note:

While returning an approval transaction, you need to specify the reason why you want to return the approval transaction. You can select the appropriate rejection reason when you have defined the reasons for the **Rejected** status of the business object in the **Status Reason** screen.

The system will not allow you to approve, return or revert an approval transaction submitted by you.

Procedure

To reject an approval transaction:

1. Click the **Menu** link in the **Application** toolbar.

A list appears.

2. In the **Search Results** section, click the link in the **Approval Transaction ID** column corresponding to the approval transaction which you want to review.

The **Comparison: New versus Existing** screen appears.

3. Review the compared existing and new approval transactions.

4. Click Return to Submitter.” With stepresult, “The Rejection/Cancelation Reason window appears. It contains the following fie

Field Name	Field Description	Mandatory (Yes or No)
Approval Workflow Reason	Used to search a particular approval workflow reason.	Yes
Comments	Used to specify additional information while rejecting the usage record.	Yes

5. Enter the required details.
6. Click **OK**.

The approval transaction is removed from the search results.

Related Topics

For more information on...	See...
Search Approval Transaction zone	Search Approval Transaction on page 977
Comparison: New versus Existing screen	Comparison: New versus Existing on page 983
How to approve an approval transaction	Approving an Approval Transaction on page 983
How to search for an approval transaction	Searching for an Approval Transaction on page 982

Canceling an Approval Transaction

Prerequisites

To revert an approval transaction to its initial status, you should have:

- Cancellation reasons defined in the application

Note:

While reverting an approval transaction, you need to specify the reason why you want to revert the approval transaction. You can select the appropriate cancellation reason when you have defined the reasons for the **Canceled** status of the business object in the **Status Reason** screen.

The system will not allow you to approve, return or revert an approval transaction submitted by you.

Procedure

To cancel an approval transaction:

1. Search for approval transactions with task details and status as Approve in the **Approval Transaction** screen.
2. In the **Search Results** section, click the link in the **Approval Transaction ID** column corresponding to the approval transaction which you want to review.

The **Comparison: New versus Existing** screen appears.

3. Review the compared existing and new approval transactions.
4. Click **Revert to Original**.

The **Rejection/Cancellation Reason** window appears. It contains the following fields:

Field Name	Field Description	Mandatory (Yes or No)
Approval Workflow Reason	Used to search a particular approval workflow reason.	Yes
Comments	Used to specify additional information while rejecting the usage record.	Yes

5. Enter the required details.

A **Comparison: New versus Existing** screen appears where you can view the changes in the new transaction as compared to the existing ones.

Note:

By default, any modifications will be highlighted in the Yellow (9933FF) color and new additions will be highlighted in the Purple (FFFF66) color. You can easily change these default colors. For more information on how to set the colors used for highlighting, see [Setting the CI_AXENTITY Feature Configuration](#) on page 3441.

6. Click OK.

The approval transaction is removed from the search results.

Related Topics

For more information on...	See...
Search Approval Transaction zone	Search Approval Transaction on page 977
Comparison: New versus Existing screen	Comparison: New versus Existing on page 983
How to approve an approval transaction	Approving an Approval Transaction on page 983
How to search for an approval transaction	Searching for an Approval Transaction on page 982

Modifying an Approval Transaction**Prerequisites**

To modify an approval transaction, you should have:

- Characteristic Types defined in the application.

Procedure

To Modify an approval transaction:

1. Search for approval transactions with task details and status as Modify in the **Approval Transaction** screen.

Note: ORMB search engine supports wildcard search, where you can substitute the percentage (%) symbol as a stand in for any word or letter in a search criteria. You can use the '%' wildcard character in all input fields except the date and ID fields. The '%' wildcard character is suffixed automatically at the end of the partial search criteria. Therefore, you may or may not specify the wildcard character at the end of the partial search criteria. However, you have to prefix the wildcard character manually wherever required.

2. From the **Main** menu, select **Approval Workflow** and then click **Approval Transaction**.

A screen appears where you can review the changes, and accordingly modify or resolve the request based on your observations. In case where the submitter action is **Update (UPD)**, you will be able to compare the existing and new data, and accordingly take an action.

3. Modify the required details.
4. Click **Save**.

The modifications made to the approval transaction are saved.

Related Topics

For more information on...	See...
Approval Transaction screen	Approval Transaction on page 977
Search Approval Transaction zone	Search Approval Transaction on page 977
How to search for an approval transaction	Searching for an Approval Transaction on page 982

Withdrawing an Approval Transaction

Procedure

To withdraw an approval transaction:

1. Click the **Menu** link in the **Application** toolbar.

A list appears.

2. In the **Search Results** section, click the link in the **Withdraw** column corresponding to the approval transaction which you want to withdraw.

A message appears confirming whether you want to withdraw the approval transaction.

3. Click **OK**.

A message appears confirming whether you want to delete the approval transaction.

4. Click **OK**.

The approval transaction is deleted.

Related Topics

For more information on...	See...
Approval Transaction screen	Approval Transaction on page 977
Search Approval Transaction zone	Search Approval Transaction on page 977
How to search for an approval transaction	Searching for an Approval Transaction on page 982

Resolving an Approval Transaction

Prerequisites

To resolve an approval transaction, you should have:

- Characteristic Types defined in the application.

Procedure

To resolve an approval transaction:

1. Search for approval transactions with task details and status as Resolve in the **Approval Transaction** screen.

A list appears.

2. In the **Search Results** section, click the link in the **Approval Transaction ID** column corresponding to the approval transaction which you want to resolve.

A screen appears where you can review the changes, and accordingly modify or resolve the request based on your observations. In case where the submitter action is Update (UPD), you will be able to compare the existing and new data, and accordingly take an action.

3. Make the required changes.

4. Click **Save**.

The changes resolve for the approval transaction are saved.

Related Topics

For more information on...	See...
Approval Transaction screen	Approval Transaction on page 977

For more information on...	See...
Search Approval Transaction zone	Search Approval Transaction on page 977
How to search for an approval transaction	Searching for an Approval Transaction on page 982

Approve Price Assignment

The **Approve Price Assignment** screen allows you to search for the price assignment requests that are pending in your workflow for approval. You can review the changes, and accordingly approve, reject or cancel the request based on your observations. It contains the following zones:

- [Search](#) on page 988
- [List of Price Assignments](#) on page 991
- [Approve Price Assignment - Comparison: New versus Existing](#) on page 992
- [Approval Transaction Log](#) on page 981

Search

The **Search** zone allows you to search for the price assignment requests that are pending in your workflow for approval. It contains the following two sections:

- **Search Criteria** – The **Search Criteria** section contains the following fields:

Field Name	Field Description	Mandatory (Yes or No)
Search By	Used to indicate whether you want to search for price assignments using the account, person, price list, submitter ID or transaction ID. The valid values are: <ul style="list-style-type: none"> • Person • Account • Price List • Submitter ID • Approval Transaction ID 	Yes
	Note: By default, the Person option is selected.	
Division	Used to search price assignments which are associated with a particular division.	No
	Note: You can only view those divisions to which you have access in the Division list. This field appears when you select the Person or Account option from the Search By list.	

Field Name	Field Description	Mandatory (Yes or No)
Person Identifier Type	Used to specify the value for the person identifier type.	Yes (Conditional)
		Note: If you enter the person identifier as a search criteria, you have to select the person identifier type.
Person Identifier	Used to specify the ID linked to the person.	Yes (Conditional)
	Note: This field appears when you select the Person option from the Search By list.	Note: If you specify the person identifier type as a search criteria, you have to enter the person identifier.
Account ID	Used to search price assignments which are created for a particular account.	No
	Note: This field appears when you select the Account option from the Search By list.	
Account Identifier Type	Used to select the identifier type based on which you want to search price assignments of an account.	Yes (Conditional)
	Note: This field appears when you select the Account option from the Search By list.	Note: If you enter the account identifier as a search criteria, you have to select the account identifier type.
Account Identifier	Used to specify the account whose price assignments you want to view.	Yes (Conditional)
	Note: This field appears when you select the Account option from the Search By list.	Note: If you specify the account identifier type as a search criteria, you have to enter the account identifier.
Price List Description	Used to search price lists with a particular description.	No
	Note: This field appears when you select the Price List option from the Search By list.	
Submitter ID	Used to search for price assignment requests that are created by a particular submitter.	No
	Note: This field appears when you select the Submitter ID option from the Search By list.	

Field Name	Field Description	Mandatory (Yes or No)
Approval Transaction ID	This field appears when you select the Approval Transaction ID option from the Search By list.	No
	<p>Note:</p> <p>The approval transaction ID is generated automatically when the price assignment request is created.</p> <p>This field appears when you select the Transaction ID option from the Search By list.</p>	

Note: You must specify at least one search criterion while searching for a price assignment.

- **Search Results** – On clicking the **Search** button, the search results appear based on the specified search criteria. It contains the following columns:

Column Name	Column Description
Account ID	Displays the account ID.
	Note: This column appears only when you select the Account option from the Search By list.
Account Identifier Type	Indicates the account identifier type of the account for the price assignments.
	Note: This column appears when you select the Account option from the Search By list.
Account Identifier	Displays the value of the account identifier type.
	Note: This column appears when you select the Account option from the Search By list.
Price List ID	
	Note: This column appears when you select the Price List option from the Search By list.
Price List Description	Displays the description for the price list.
	Note: This column appears when you select the Price List option from the Search By list.
Person Identifier	
	Note: This column appears when you select the Person option from the Search By list.
Person Name	Displays the name of the person.
	Note: This column appears when you select the Person option from the Search By list.
Division	Displays the division to which the account, person, or price list belongs.

Column Name	Column Description
Submitter ID	Displays the ID of the submitter.
	Note: This column appears when you select the Submitter ID option from the Search By list.
Approval Transaction ID	Displays the approval transaction ID.
	Note: This column appears when you select the Approval Transaction ID option from the Search By list.

On clicking the **Broadcast** () icon corresponding to the account, person, price list, or submitter ID the **List of Price Assignments** zone appears with the list of price assignments.

Related Topics

For more information on...	See...
List of Price Assignments zone	List of Price Assignments on page 1010
How to approve a price assignment for an account	Approving a Price Assignment for an Account on page 995
How to approve a price assignment for a person	Approving a Price Assignment for a Person on page 996
How to approve a price assignment for a price list	Approving a Price Assignment for a Price List on page 997
How to reject a price assignment for an account	Rejecting a Price Assignment for an Account on page 998
How to reject a price assignment for a person	Rejecting a Price Assignment for a Person on page 999
How to reject a price assignment for a price list	Rejecting a Price Assignment for a Price List on page 1001
How to cancel a price assignment for an account	Canceling a Price Assignment for an Account on page 1002
How to cancel a price assignment for a person	Canceling a Price Assignment for a Person on page 1003
How to cancel a price assignment for a price list	Canceling a Price Assignment for a Price List on page 1005

List of Price Assignments

The **List of Price Assignments** zone lists price assignment requests specific to an account, a person, or a price list. It contains the following columns:

Column Name	Column Description
Approval Transaction ID	Displays the approval transaction id.
	Note: The approval transaction id is generated automatically when the price assignment request is created.
Submitter Name	Displays the name of the submitter.
Action	Indicates the type of action, such as Add , Update (UPD) , or Delete (DEL) performed by the submitter during price assignment.
Submitted On	Indicates the submitter who has created the price assignment request.

Column Name	Column Description
To Do Type	Displays the type of To Do (notification) received for the price assignment request.
Price Item	Displays the price item or price item code.
Description	Displays the description of the price item or price item code.
Pricing Currency	Indicates the currency in which the price item pricing is defined.
Start Date	Displays the date from when the price item pricing is effective.
End Date	Displays the date till when the price item pricing is effective.
Approval Transaction Information	Displays the additional information of an approval transaction.

Note:

By default, the **List of Price Assignments** zone does not appear in the **Approve Price Assignment** screen. It appears when you click the **Broadcast** () icon corresponding to the account, person, or price list in the **Search** zone.

Related Topics

For more information on...	See...
Search Approve Price Assignment zone	Search on page 988
Comparison: New versus Existing zone	Approve Price Assignment - Comparison: New versus Existing on page 992
How to approve a price assignment for an account	Approving a Price Assignment for an Account on page 995
How to approve a price assignment for a person	Approving a Price Assignment for a Person on page 996
How to approve a price assignment for a price list	Approving a Price Assignment for a Price List on page 997
How to reject a price assignment for an account	Rejecting a Price Assignment for an Account on page 998
How to reject a price assignment for a person	Rejecting a Price Assignment for a Person on page 999
How to reject a price assignment for a price list	Rejecting a Price Assignment for a Price List on page 1001
How to cancel a price assignment for an account	Canceling a Price Assignment for an Account on page 1002
How to cancel a price assignment for a person	Canceling a Price Assignment for a Person on page 1003
How to cancel a price assignment for a price list	Canceling a Price Assignment for a Price List on page 1005

Approve Price Assignment - Comparison: New versus Existing

The **Comparison: New versus Existing** zone lists the existing and the new price assignments defined in the system. You can approve, cancel, reject a price assignment through this zone. It contains the following fields:

Field Name	Field Description
Approval Transaction ID	Displays the approval transaction id.
Submitter ID	Displays the submitter id who has created the price assignment request.

Field Name	Field Description
Approval Transaction Information	Displays information about the approval transaction
Action	Indicates the action that can be performed on the price assignment. The valid values are: <ul style="list-style-type: none"> • Add – Allows you to define the tiering setup of the price assignment • DEL – Allows you to delete the tiering setup of the price assignment. • UPD – Allows you to upload the tiering setup of the price assignment.

In addition to the above fields, this zone also contains the following two sections:

- **New** – It consists of the new approved price assignments.
- **Existing** – It consists of the existing or old price assignments.

In addition, this zone also contains the following buttons:

Button Name	Button Description
Approve	Used to approve the price assignment.
Return to Submitter	Used to reject the price assignment.
Revert to Original	Used to cancel the price assignment.

Note:

By default, the **Comparison: New versus Existing** zone does not appear in the **Approve Price Assignment** screen. It appears when you click the **Broadcast** () icon corresponding to the approval transaction ID in the **List Of Price Assignments** zone.

The changes made are highlighted in both the sections for the respective fields. The fields change according to the price assignments.

You can click on **Approve** button, **Return to Submitter** button, or **Revert to Original** button to **Approve**, **Reject** or **Cancel** the price assignments, respectively.

Related Topics

For more information on...	See...
Search Approve Price Assignment zone	Search on page 988
List of Price Assignments zone	List of Price Assignments on page 1010
How to approve a price assignment for an account	Approving a Price Assignment for an Account on page 995
How to approve a price assignment for a person	Approving a Price Assignment for a Person on page 996
How to approve a price assignment for a price list	Approving a Price Assignment for a Price List on page 997
How to reject a price assignment for an account	Rejecting a Price Assignment for an Account on page 998
How to reject a price assignment for a person	Rejecting a Price Assignment for a Person on page 999

For more information on...	See...
How to reject a price assignment for a price list	Rejecting a Price Assignment for a Price List on page 1001
How to cancel a price assignment for an account	Canceling a Price Assignment for an Account on page 1002
How to cancel a price assignment for a person	Canceling a Price Assignment for a Person on page 1003
How to cancel a price assignment for a price list	Canceling a Price Assignment for a Price List on page 1005

Approval Transaction Log

The **Approval Transaction Log** zone displays the complete trail of submitter and approver actions performed on the approval transaction. It contains the following columns:

Column Name	Column Description
Date Time	Displays the date and time when the action was performed on the approval transaction.
User Name	Indicates the user who has performed the action on the approval transaction.
Status	Indicates the status of the approval transaction. The valid values are: <ul style="list-style-type: none"> • Approved • Cancelled • Rejected • Inprocess • Pending • Initial • Deleted
Status Reason	Indicates the reason why the approval transaction was rejected or cancelled.
Comments	Displays the additional details entered by the approver on rejecting or cancelling the approval transaction.

Note:

By default, the **Approval Transaction Log** zone does not appear in the **Approve Price Assignment** screen. It appears when you click the **Broadcast** () icon corresponding to the approval transaction ID in the **List Of Price Assignments** zone.

You can change the layout of this zone. For more information on how to change the layout, see [Changing the Layout](#) on page 3414.

Related Topics

For more information on...	See...
List Of Price Assignments zone	List of Price Assignments on page 1010

Approving a Price Assignment for an Account

You can view the number of price assignments which are pending for approval in the **Approve Price Assignment** screen. The approver can review, and accordingly approve, reject or cancel the price assignment based on the observations.



Note: The system will not allow you to approve, reject or cancel a price assignment submitted by you.

Procedure

To approve a price assignment for an account:

1. Click the **Menu** link in the **Application** toolbar.
A list appears.
2. From the **Main** menu, select **Approval Workflow** and then click **Approve Price Assignment**.
The **Approve Price Assignment** screen appears.
3. Enter the search criteria in the **Search** zone.

Note: ORMB search engine supports wildcard search, where you can substitute the percentage (%) symbol as a stand in for any word or letter in a search criteria. You can use the ‘%’ wildcard character in all input fields except the date and ID fields. The ‘%’ wildcard character is suffixed automatically at the end of the partial search criteria. Therefore, you may or may not specify the wildcard character at the end of the partial search criteria. However, you have to prefix the wildcard character manually wherever required.

4. Click **Search**.
A list of accounts that meet the search criteria appears in the **Search Results** section.
5. Click the **Broadcast** () icon corresponding to the account whose price assignments you want to review for approval.
The **List of Price Assignments** zone appears.
6. In the **List of Price Assignments** zone, click the **Broadcast** () icon corresponding to the price assignment whose details you want to review and approve.
The **Comparison: New Versus Existing** zone appears.

Note:

By default, any modifications will be highlighted in the Yellow (9933FF) color and new additions will be highlighted in the Purple (FFFF66) color. You can easily change these default colors. For more information on how to set the colors used for highlighting, see [Setting the CI_AXENTITY Feature Configuration](#) on page 3441.

Only those users who have access to the application services for each business object within the approval workflow group will be able to view the details of the price assignment request.

7. Review the compared existing and new approval transactions.
A message appears indicating that the price assignment request is sent to the approver at the next level in the hierarchy for approval. However, if you are the last approver in the hierarchy, a message appears indicating that the price assignment request is approved successfully.
8. Click **Approve**.
A message appears with confirmation on transaction approved successfully.

Tip: Alternatively, in the **List of Price Assignments** zone, you can select the check box corresponding to the price assignment request that you want to approve and then click **Approve**.

9. Click **OK**.

The approval transaction is removed from the **List of Price Assignments** zone.

Related Topics

For more information on...	See...
Approve Price Assignment screen	Approve Price Assignment on page 988
Search zone	Search on page 988
List of Price Assignments zone	List of Price Assignments on page 991
Comparison: New versus Existing zone	Comparison: New versus Existing on page 983

Approving a Price Assignment for a Person

Procedure

To approve a price assignment for a person:

1. Click the **Menu** link in the **Actions/Navigation** area.
A list appears.
2. From the **Main** menu, select **Approval Workflow** and then click **Approve Price Assignment**.
The **Approve Price Assignment** screen appears.
3. In the **Search** zone, enter the search criteria by selecting **Person** in the **Search By** field.

Note:

ORMB search engine supports wildcard search, where you can substitute the percentage (%) symbol as a stand in for any word or letter in a search criteria. You can use the ‘%’ wildcard character in all input fields except the date and ID fields. The ‘%’ wildcard character is suffixed automatically at the end of the partial search criteria. Therefore, you may or may not specify the wildcard character at the end of the partial search criteria. However, you have to prefix the wildcard character manually wherever required.

The **Search Results** appear when **Person Identifier Type** and **Person Identifier** fields are entered.

4. Click **Search**.
A list of persons that meet the search criteria appears in the **Search Results** section.
5. Click the **Broadcast** (📡) icon corresponding to the person whose price assignments you want to review for approval.
The **List of Price Assignments** zone appears.
6. Click the **Broadcast** (📡) icon corresponding to the **Transaction Id** in the **List of Price Assignments** zone, whose details you want to view and approve.
The **Comparison: New Versus Existing** zone appears.

Note:

By default, any modifications will be highlighted in the Yellow (9933FF) color and new additions will be highlighted in the Purple (FFFF66) color. You can easily change these default colors. For more information on how to set the colors used for highlighting, see [Setting the CI_AXENTITY Feature Configuration](#) on page 3441.

Only those users who have access to the application services for each business object within the approval workflow group will be able to view the details of the price assignment request.

- Review the pricing details, tiering ranges, and price assignment characteristics, and if they are accurate, then click **Approve**.

A message appears indicating that the price assignment request is sent to the approver at the next level in the hierarchy for approval. However, if you are the last approver in the hierarchy, a message appears indicating that the price assignment request is approved successfully.

- Click **OK**.

A To Do (notification) is sent to the approver at the next level in the hierarchy. You will no longer be able to view this request in your workflow for approval. In case you are the last approver in the hierarchy, the changes are committed to the database.

Tip: Alternatively, in the **List of Price Assignments** zone, you can select the check box corresponding to the price assignment request that you want to approve, and then click **Approve**.

Related Topics

For more information on...	See...
Approve Price Assignment screen	Approve Price Assignment on page 988
Search zone	Search on page 988
List of Price Assignments zone	List of Price Assignments on page 991

Approving a Price Assignment for a Price List

Procedure

To approve a price assignment for a price list:

- Click the **Menu** link in the **Application** toolbar.
A list appears.
- From the **Main** menu, select **Approval Workflow** and then click **Approve Price Assignment**.
The **Approve Price Assignment** screen appears.
- In the **Search** zone, enter the search criteria by selecting either **Price List** in the **Search By** field.

Note: ORMB search engine supports wildcard search, where you can substitute the percentage (%) symbol as a stand in for any word or letter in a search criteria. You can use the ‘%’ wildcard character in all input fields except the date and ID fields. The ‘%’ wildcard character is suffixed automatically at the end of the partial search criteria. Therefore, you may or may not specify the wildcard character at the end of the partial search criteria. However, you have to prefix the wildcard character manually wherever required.

- Click **Search**.
A list of price lists that meet the search criteria appears in the **Search Results** section.
- Click the **Broadcast** (📡) icon corresponding to the price list whose price assignments you want to review for approval.
The **List of Price Assignments** zone appears.
- Click the **Broadcast** (📡) icon corresponding to the **Transaction Id** in the **List of Price Assignments** zone, whose details you want to view and approve.
The **Comparison: New Versus Existing** zone appears.
- Review the pricing details, tiering ranges, and price assignment characteristics, and if they are accurate, then click **Approve**.

A message appears indicating that the price assignment request is sent to the approver at the next level in the hierarchy for approval. However, if you are the last approver in the hierarchy, a message appears indicating that the price assignment request is approved successfully.

8. Click **OK**.

A To Do (notification) is sent to the approver at the next level in the hierarchy. You will no longer be able to view this request in your workflow for approval. In case you are the last approver in the hierarchy, the changes are committed to the database.

Tip: Alternatively, in the **List of Price Assignments** zone, you can select the check box corresponding to the price assignment request that you want to approve, and then click **Approve**.

Related Topics

For more information on...	See...
Approve Price Assignment screen	Approve Price Assignment on page 988
Search zone	Search on page 988
List of Price Assignments zone	List of Price Assignments on page 991

Rejecting a Price Assignment for an Account

Procedure

To reject a price assignment for an account:

1. Click the **Menu** link in the **Application** toolbar.

A list appears.

2. From the **Main** menu, select **Approval Workflow** and then click **Approve Price Assignment**.

The **Approve Price Assignment** screen appears.

3. In the **Search** zone, enter the search criteria by selecting either **Account** in the **Search By** field.

Note: ORMB search engine supports wildcard search, where you can substitute the percentage (%) symbol as a stand in for any word or letter in a search criteria. You can use the '%' wildcard character in all input fields except the date and ID fields. The '%' wildcard character is suffixed automatically at the end of the partial search criteria. Therefore, you may or may not specify the wildcard character at the end of the partial search criteria. However, you have to prefix the wildcard character manually wherever required.

4. Click **Search**.

A list of accounts that meet the search criteria appears in the **Search Results** section.

5. Click the **Broadcast** (📡) icon corresponding to the account whose price assignments you want to review for approval.

The **List of Price Assignments** zone appears.

6. Click the **Broadcast** (📡) icon corresponding to the **Transaction Id** in the **List of Price Assignments** zone, whose details you want to view and approve.

The **Comparison: New Versus Existing** zone appears.

Note:

By default, any modifications will be highlighted in the Yellow (9933FF) color and new additions will be highlighted in the Purple (FFFF66) color. You can easily change these default colors. For more information on how to set the colors used for highlighting, see [Setting the CI_AXENTITY Feature Configuration](#) on page 3441.

Only those users who have access to the application services for each business object within the approval workflow group will be able to view the details of the price assignment request.

- Review the pricing details, tiering ranges, and price assignment characteristics, and if they are not appropriate, then click **Return to Submitter**.

The **Rejection/Cancellation Reason** screen appears.

Tip: Alternatively, in the **List of Price Assignments** zone, you can select the check box corresponding to the price assignment request that you want to reject, and then click **Return to Submitter**.

- Select the reason for rejecting the price assignment request and enter the comments in the respective field.
- Click **OK**.

The **Approve** and **Revert to Original** buttons are disabled. You will no longer be able to view this request in your workflow for approval.

Related Topics

For more information on...	See...
Approve Price Assignment screen	Approve Price Assignment on page 988
Search zone	Search on page 988
List of Price Assignments zone	List of Price Assignments on page 991

Rejecting a Price Assignment for a Person

You can view the number of price assignments which are pending for approval in the **Approve Price Assignment** screen. You can review, and accordingly approve, reject or cancel the price assignment based on the observations.

Note: The system will not allow you to approve, reject or cancel a price assignment submitted by you.

Procedure



To reject a price assignment for a person:

- Click the **Menu** link in the **Application** toolbar.
A list appears.
- From the **Main** menu, select **Approval Workflow** and then click **Approve Price Assignment**.
The **Approve Price Assignment** screen appears.
- Enter the search criteria in the **Search** zone.

Note: ORMB search engine supports wildcard search, where you can substitute the percentage (%) symbol as a stand in for any word or letter in a search criteria. You can use the ‘%’ wildcard character in all input fields except the date and ID fields. The ‘%’ wildcard character is suffixed automatically at the end of the partial search criteria. Therefore, you may or may not specify the wildcard character at the end of the partial search criteria. However, you have to prefix the wildcard character manually wherever required.

- Click **Search**.

A list of persons that meet the search criteria appears in the **Search Results** section.

5. Click the **Broadcast** () icon corresponding to the person whose price assignments you want to review.
The **List of Price Assignments** zone appears.
6. In the **List of Price Assignments** zone, click the **Broadcast** () icon corresponding to the price assignment whose details you want to review.
The **Comparison: New Versus Existing** zone appears.

Note:

By default, any modifications will be highlighted in the Yellow (9933FF) color and new additions will be highlighted in the Purple (FFFF66) color. You can easily change these default colors. For more information on how to set the colors used for highlighting, see [Setting the CI_AXENTITY Feature Configuration](#) on page 3441.

Only those users who have access to the application services for each business object within the approval workflow group will be able to view the details of the price assignment request.

7. Review the compared existing and new approval transactions.

The **Rejection/Cancellation Reason** screen appears. It contains following fields:

Field Name	Field Description	Mandatory (Yes or No)
Reason Code	Used to specify the reason why the approval workflow request is rejected.	Yes
Rejection/Cancellation Comment	Used to specify additional information while rejecting/ cancelling the approval workflow request.	Yes

Tip: Alternatively, in the **List of Price Assignments** zone, you can select the check box corresponding to the price assignment request that you want to reject, and then click **Return to Submitter**.

8. Click **Return to Submitter**.

The **Rejection/Cancellation Reason** screen appears. It contains the following fields:

Field Name	Field Description	Mandatory (Yes or No)
Approval Workflow Reason	Used to search a particular approval workflow reason.	Yes
Comments	Used to add additional comments.	No

9. Enter the required details.

10. Click **OK**.

The approval transaction is removed from the **List of Price Assignments** zone.

Note: Alternatively, you can cancel the price assignment by selecting the check box corresponding to the price assignment which you want to cancel and then click the **Revert to Original** button in the **List of Price Assignments** zone.

Related Topics

For more information on...	See...
Approve Price Assignment screen	Approve Price Assignment on page 988
Search zone	Search on page 988
List of Price Assignments zone	List of Price Assignments on page 991

For more information on...	See...
Comparison: New versus Existing zone	<i>Comparison: New versus Existing</i> on page 983

Rejecting a Price Assignment for a Price List

You can view the number of price assignments which are pending for approval in the **Approve Price Assignment** screen. You can review, and accordingly approve, reject or cancel the price assignment based on the observations.

Note: The system will not allow you to approve, reject or cancel a price assignment submitted by you.

Procedure

To reject a price assignment for a price list:

1. Click the **Menu** link in the **Actions/Navigation** area.

A list appears.

2. From the **Main** menu, select **Approval Workflow** and then click **Approve Price Assignment**.

The **Approve Price Assignment** screen appears.

3. Enter the search criteria in the **Search** zone.

Note: ORMB search engine supports wildcard search, where you can substitute the percentage (%) symbol as a stand in for any word or letter in a search criteria. You can use the ‘%’ wildcard character in all input fields except the date and ID fields. The ‘%’ wildcard character is suffixed automatically at the end of the partial search criteria. Therefore, you may or may not specify the wildcard character at the end of the partial search criteria. However, you have to prefix the wildcard character manually wherever required.

4. Click **Search**.

A list of price lists that meet the search criteria appears in the **Search Results** section.

5. Click the **Broadcast** (📢) icon corresponding to the price list whose price assignments you want to review.

The **List of Price Assignments** zone appears.

6. In the **List of Price Assignments** zone, click the **Broadcast** (📢) icon corresponding to the price assignment whose details you want to review.

The **Comparison: New Versus Existing** zone appears.

Note:

By default, any modifications will be highlighted in the Yellow (9933FF) color and new additions will be highlighted in the Purple (FFFF66) color. You can easily change these default colors. For more information on how to set the colors used for highlighting, see [Setting the CI_AXENTITY Feature Configuration](#) on page 3441.

Only those users who have access to the application services for each business object within the approval workflow group will be able to view the details of the price assignment request.

7. Review the compared existing and new approval transactions.

The **Rejection/Cancellation Reason** screen appears.

Tip: Alternatively, in the **List of Price Assignments** zone, you can select the check box corresponding to the price assignment request that you want to reject, and then click **Return to Submitter**.

8. Click **Return to Submitter**.

The **Rejection/Cancelation Reason** screen appears. It contains the following fields:

Field Name	Field Description	Mandatory (Yes or No)
Approval Workflow Reason	Used to search a particular approval workflow reason.	Yes
Comments	Used to add additional comments.	No

9. Enter the required details.

The **Approve** and **Revert to Original** buttons are disabled.

10. Click **OK**.

The approval transaction is removed from the **List of Price Assignments** zone.

Tip: Alternatively, you can reject the price assignment by selecting the check box corresponding to the price assignment which you want to reject and then click the **Return to Submitter** button in the **List of Price Assignments** zone.

Related Topics

For more information on...	See...
Approve Price Assignment screen	Approve Price Assignment on page 988
Search zone	Search on page 988
List of Price Assignments zone	List of Price Assignments on page 991
Comparison: New versus Existing zone	Comparison: New versus Existing on page 983

Canceling a Price Assignment for an Account

You can view the number of price assignments which are pending for approval in the **Approve Price Assignment** screen. You can review, and accordingly approve, reject or cancel the price assignment based on the observations.

Note: The system will not allow you to approve, reject or cancel a price assignment submitted by you.

Procedure

To cancel a price assignment for an account:

1. Click the **Menu** link in the **Application** toolbar.

A list appears.

2. From the **Main** menu, select **Approval Workflow** and then click **Approve Price Assignment**.

The **Approve Price Assignment** screen appears.

3. Enter the search criteria in the **Search** zone.

Note: ORMB search engine supports wildcard search, where you can substitute the percentage (%) symbol as a stand in for any word or letter in a search criteria. You can use the ‘%’ wildcard character in all input fields except the date and ID fields. The ‘%’ wildcard character is suffixed automatically at the end of the partial search criteria. Therefore, you may or may not specify the wildcard character at the end of the partial search criteria. However, you have to prefix the wildcard character manually wherever required.

4. Click **Search**.

A list of accounts that meet the search criteria appears in the **Search Results** section.

5. Click the **Broadcast** () icon corresponding to the account whose price assignments you want to review.

The **List of Price Assignments** zone appears.

- In the **List of Price Assignments** zone, click the **Broadcast** () icon corresponding to the price assignment whose details you want to review.

The **Comparison: New Versus Existing** zone appears.

Note:

By default, any modifications will be highlighted in the Yellow (9933FF) color and new additions will be highlighted in the Purple (FFFF66) color. You can easily change these default colors. For more information on how to set the colors used for highlighting, see [Setting the CI_AXENTITY Feature Configuration](#) on page 3441.

Only those users who have access to the application services for each business object within the approval workflow group will be able to view the details of the price assignment request.

- Review the compared existing and new approval transactions.

The **Rejection/Cancelation Reason** screen appears.

Tip: Alternatively, in the **List of Price Assignments** zone, you can select the check box corresponding to the price assignment request that you want to reject, and then click **Revert to Original**.

- Click **Revert to Original**.

The **Rejection/Cancelation Reason** screen appears. It contains the following fields:

Field Name	Field Description	Mandatory (Yes or No)
Approval Workflow Reason	Used to search a particular approval workflow reason.	Yes
Comments	Used to add additional comments.	No

- Enter the required details.

- Click **OK**.

The approval transaction is removed from the **List of Price Assignments** zone.

Tip: Alternatively, you can cancel the price assignment by selecting the check box corresponding to the price assignment which you want to cancel and then click the **Revert to Original** button in the **List of Price Assignments** zone.

Related Topics

For more information on...	See...
Approve Price Assignment screen	Approve Price Assignment on page 988
Search zone	Search on page 988
List of Price Assignments zone	List of Price Assignments on page 991
Comparison: New versus Existing zone	Comparison: New versus Existing on page 983

Canceling a Price Assignment for a Person

You can view the number of price assignments which are pending for approval in the **Approve Price Assignment** screen. You can review, and accordingly approve, reject or cancel the price assignment based on the observations.

Note: The system will not allow you to approve, reject or cancel a price assignment submitted by you.

Procedure

To cancel a price assignment for a person:

1. Click the **Menu** link in the **Application** toolbar.

A list appears.

2. From the **Main** menu, select **Approval Workflow** and then click **Approve Price Assignment**.

The **Approve Price Assignment** screen appears.

3. Enter the search criteria in the **Search** zone.

Note: ORMB search engine supports wildcard search, where you can substitute the percentage (%) symbol as a stand in for any word or letter in a search criteria. You can use the '%' wildcard character in all input fields except the date and ID fields. The '%' wildcard character is suffixed automatically at the end of the partial search criteria. Therefore, you may or may not specify the wildcard character at the end of the partial search criteria. However, you have to prefix the wildcard character manually wherever required.

4. Click **Search**.

A list of accounts that meet the search criteria appears in the **Search Results** section.

5. Click the **Broadcast** (📢) icon corresponding to the account whose price assignments you want to review.

The **List of Price Assignments** zone appears.

6. In the **List of Price Assignments** zone, click the

Broadcast (📢) icon corresponding to the price assignment whose details you want to review.

The **Comparison: New Versus Existing** zone appears.

Note:

By default, any modifications will be highlighted in the Yellow (9933FF) color and new additions will be highlighted in the Purple (FFFF66) color. You can easily change these default colors. For more information on how to set the colors used for highlighting, see [Setting the CI_AXENTITY Feature Configuration](#) on page 3441.

Only those users who have access to the application services for each business object within the approval workflow group will be able to view the details of the price assignment request.

7. Review the compared existing and new approval transactions.

The **Rejection/Cancelation Reason** screen appears.

Tip: Alternatively, in the **List of Price Assignments** zone, you can select the check box corresponding to the price assignment request that you want to reject, and then click **Revert to Original**.

8. Click **Revert to Original**.

The **Rejection/Cancelation Reason** screen appears. It contains the following fields:

Field Name	Field Description	Mandatory (Yes or No)
Approval Workflow Reason	Used to search a particular approval workflow reason.	Yes
Comments	Used to add additional comments.	No

9. Enter the required details.

10. Click **OK**.

The approval transaction is removed from the **List of Price Assignments** zone.

Tip: Alternatively, you can cancel the price assignment by selecting the check box corresponding to the price assignment which you want to cancel and then click the **Revert to Original** button in the **List of Price Assignments** zone.

Related Topics

For more information on...	See...
Approve Price Assignment screen	Approve Price Assignment on page 988
Search zone	Search on page 988
List of Price Assignments zone	List of Price Assignments on page 991
Comparison: New versus Existing zone	Comparison: New versus Existing on page 983

Canceling a Price Assignment for a Price List

You can view the number of price assignments which are pending for approval in the **Approve Price Assignment** screen. You can review, and accordingly approve, reject or cancel the price assignment based on the observations.

Note: The system will not allow you to approve, reject or cancel a price assignment submitted by you.

Procedure

To cancel a price assignment for a price list:

1. Click the **Menu** link in the **Application** toolbar.
A list appears.
2. From the **Main** menu, select **Approval Workflow** and then click **Approve Price Assignment**.
The **Approve Price Assignment** screen appears.
3. Enter the search criteria in the **Search** zone.

Note: ORMB search engine supports wildcard search, where you can substitute the percentage (%) symbol as a stand in for any word or letter in a search criteria. You can use the '%' wildcard character in all input fields except the date and ID fields. The '%' wildcard character is suffixed automatically at the end of the partial search criteria. Therefore, you may or may not specify the wildcard character at the end of the partial search criteria. However, you have to prefix the wildcard character manually wherever required.

4. Click **Search**.
A list of price lists that meet the search criteria appears in the **Search Results** section.
5. Click the **Broadcast** (📡) icon corresponding to the price list whose price assignments you want to review.
The **List of Price Assignments** zone appears.
6. In the **List of Price Assignments** zone, click the **Broadcast** (📡) icon corresponding to the price assignment whose details you want to review.
The **Comparison: New Versus Existing** zone appears.
7. Review the compared existing and new approval transactions.
The **Rejection/Cancellation Reason** screen appears.

Tip: Alternatively, in the **List of Price Assignments** zone, you can select the check box corresponding to the price assignment request that you want to cancel, and then click **Revert to Original**.

8. Click **Revert to Original**.

The **Rejection/Cancellation Reason** screen appears. It contains the following fields:

Field Name	Field Description	Mandatory (Yes or No)
Approval Workflow Reason	Used to search a particular approval workflow reason.	Yes
Comments	Used to add additional comments.	No

9. Enter the required details.

10. Click **OK**.

The approval transaction is removed from the **List of Price Assignments** zone.

Tip: Alternatively, you can cancel the price assignment by selecting the check box corresponding to the price assignment which you want to cancel and then click the **Revert to Original** button in the **List of Price Assignments** zone.

Related Topics

For more information on...	See...
Approve Price Assignment screen	Approve Price Assignment on page 988
Search zone	Search on page 988
List of Price Assignments zone	List of Price Assignments on page 991
Comparison: New versus Existing zone	Comparison: New versus Existing on page 983

Modify Price Assignment

The submitter has the facility to modify or withdraw a price assignment request before the approver at the first level in the hierarchy approves or rejects the request. Once the changes are made, the submitter submits the request for approval.

The **Modify Price Assignment** screen allows you to modify or withdraw a price assignment request. It contains the following zones:

- [Search](#) on page 1006
- [List of Price Assignments](#) on page 1021

Search

The **Search** zone allows you to search for the price assignment request using various search criteria. This zone contains the following two sections:

- **Search Criteria** – The **Search Criteria** section contains the following fields:

Field Name	Field Description	Mandatory (Yes or No)
Search By	Used to indicate whether you want to search for price assignments using the account, person, price list, submitter ID or transaction ID. The valid values are: <ul style="list-style-type: none"> • Person • Account • Price List • Submitter ID • Approval Transaction ID 	Yes
	Note: By default, the Person option is selected.	
Division	Used to search price assignments which are associated with a particular division.	No
	Note: You can only view those divisions to which you have access in the Division list. This field appears when you select the Person or Account option from the Search By list.	
Person Identifier Type	Used to select the identifier type based on which you want to search price assignments through which the person's record is created or updated in the system.	Yes (Conditional)
	Note: This field appears when you select the Person option from the Search By list.	
Person Identifier	Used to specify the value for the person identifier type.	Yes (Conditional)
	Note: If you specify the person identifier type as a search criteria, you have to enter the person identifier.	
Account ID	Used to search price assignments which are created for a particular account.	No
	Note: This field appears when you select the Account option from the Search By list.	
Account Identifier Type	Used to select the identifier type based on which you want to search price assignments of an account.	Yes (Conditional)
	Note: This field appears when you select the Account option from the Search By list.	
		Note: If you enter the account identifier as a search criteria, you have to select the account identifier type.

Field Name	Field Description	Mandatory (Yes or No)
Account Identifier	Used to specify the account whose price assignments you want to view.	Yes (Conditional) Note: If you specify the account identifier type as a search criteria, you have to enter the account identifier.
	Note: This field appears when you select the Account option from the Search By list.	
Price List Description	Used to search price lists with a particular description.	No
	Note: This field appears when you select the Price List option from the Search By list.	
Submitter ID	Used to search for price assignment requests that are created by a particular submitter.	No
	Note: This field appears when you select the Submitter ID option from the Search By list.	
Approval Transaction ID	Used to search the price assignment request using the approval transaction ID.	No
	Note: The approval transaction ID is generated automatically when the price assignment request is created. This field appears when you select the Approval Transaction ID option from the Search By list.	

Note: You must specify at least one search criterion while searching for a price assignment.

- **Search Results** - On clicking the **Search** button, the search results appear based on the specified search criteria. The **Search Results** section contains the following columns:

Column Name	Column Description
Person Identifier	Indicates the person for whom the price assignment is created.
	Note: This column appears when you select the Person or Submitter ID option from the Search By list.
Person Name	Displays the name of the person.
	Note: This column appears when you select the Person or Submitter ID option from the Search By list.
Person Identifier Type	Displays the person identifier type.
	Note: This column appears when you select the Submitter ID option from the Search By list.
Division	Displays the division to which the account, person, or price list belongs.

Column Name	Column Description
Account Information	<p>Displays information about the account. In addition, this column has a context menu which helps in navigating to other screens in the application.</p> <p>Note: This column appears when you select the Account or Submitter ID option from the Search By list. It has a link. On clicking the link, the Account screen appears where you can view the details of the respective account.</p>
Account Identifier Type	<p>Indicates the account identifier type of the account for the price assignments.</p> <p>Note: This column appears when you select the Account or Submitter ID option from the Search By list.</p>
Account Identifier	<p>Displays the value of the account identifier type.</p> <p>Note: This column appears when you select the Account or Submitter ID option from the Search By list.</p>
Price List ID	<p>Displays the price list ID.</p> <p>Note: This column appears only when you select the Price List option from the Search By list.</p>
Price List Description	<p>Displays the description for the price list.</p> <p>Note: This column appears when you select the Price List option from the Search By list.</p> <p>Note: This column appears when you are searching for price assignment requests of a price list.</p>
Submitter ID	<p>Displays the ID of the submitter.</p> <p>Note: This column appears when you select the Submitter ID option from the Search By list.</p>

On clicking the **Broadcast** (📡) icon corresponding to the account, person, price list, or submitter ID the **List of Price Assignments** zone appears with the list of price assignments.

Related Topics

For more information on...	See...
List of Price Assignments zone	List of Price Assignments on page 1010
How to modify a price assignment for an account	Modifying a Price Assignment for an Account on page 1011
How to modify a price assignment for a person	Modifying a Price Assignment for a Person on page 1012
How to modify a price assignment for a price list	Modifying a Price Assignment for a Price List on page 1013

For more information on...	See...
How to withdraw a price assignment for an account	Withdrawing a Price Assignment for an Account on page 1013
How to withdraw a price assignment for a person	Withdrawing a Price Assignment for a Person on page 1014
How to withdraw a price assignment for a price list	Withdrawing a Price Assignment for a Price List on page 1015

List of Price Assignments

The **List of Price Assignments** zone lists price assignment requests specific to an account, a person, or a price list. It contains the following columns:

Column Name	Column Description
Approval Transaction ID	Displays the approval transaction ID.
	Note: The approval transaction id is generated automatically when the price assignment request is created.
Submitter Name	Indicates the submitter who has created the price assignment request.
Action	Indicates the type of action, such as Add , Update (UPD) , or Delete (DEL) , performed by the submitter during price assignment.
Submitted On	Displays the date and time when the price assignment request was created by the submitter.
To Do Type	Displays the type of To Do (notification) received for the price assignment request.
Price Item	Displays the price item or price item code.
Description	Displays the description of the price item or price item code.
Pricing Currency	Indicates the currency in which the price item pricing is defined.
Start Date	Displays the date from when the price item pricing is effective.
End Date	Displays the date till when the price item pricing is effective.
Approval Transaction Information	Displays information about the approval transaction.
	Note: This information string is generated using the C1-APPTXNINF algorithm.
Modify	It has a link. On clicking the Modify link, the Modify/Resolve Price Assignment screen appears where you can modify the price assignment.
Withdraw	It has a link. On clicking the Withdraw link, you can withdraw and remove the approval transaction from the list of price assignments.
View	It has a link. On clicking the Log link, you can view the approval transaction log details.

By default, the **List of Price Assignments** zone does not appear in the **Modify Price Assignment** screen. It appears when you click the **Broadcast** (📡) icon corresponding to the account, person, or price list in the **Search** zone.

Related Topics

For more information on...	See...
Modify Price Assignment Search zone	Search on page 1006
How to modify a price assignment for an account	Modifying a Price Assignment for an Account on page 1011
How to modify a price assignment for a person	Modifying a Price Assignment for a Person on page 1012
How to modify a price assignment for a price list	Modifying a Price Assignment for a Price List on page 1013
How to withdraw a price assignment for an account	Withdrawing a Price Assignment for an Account on page 1013
How to withdraw a price assignment for a person	Withdrawing a Price Assignment for a Person on page 1014
How to withdraw a price assignment for a price list	Withdrawing a Price Assignment for a Price List on page 1015

Modifying a Price Assignment for an Account

You can view the number of price assignments which are pending for modification in the **Modify Price Assignment** screen. The modifier can review, and accordingly modify, withdraw or view log of the price assignment based on the observations.

Procedure

To modify a price assignment for an account:

1. Click the **Menu** link in the **Application** toolbar.
A list appears.
2. From the **Main** menu, select **Approval Workflow** and then click **Modify Price Assignment**.
The **Modify Price Assignment** screen appears.
3. Enter the search criteria in the **Search** zone.

Note: ORMB search engine supports wildcard search, where you can substitute the percentage (%) symbol as a stand in for any word or letter in a search criteria. You can use the ‘%’ wildcard character in all input fields except the date and ID fields. The ‘%’ wildcard character is suffixed automatically at the end of the partial search criteria. Therefore, you may or may not specify the wildcard character at the end of the partial search criteria. However, you have to prefix the wildcard character manually wherever required.

4. Click **Search**.
A list of accounts that meet the search criteria appears in the **Search Results** section.
5. Click the **Broadcast** () icon corresponding to the account whose price assignments you want to review.
The **List of Price Assignments** zone appears.
6. Click the **Modify** link in the **Modify** column corresponding to the price assignment that you want to modify.
The **Modify/Resolve Price Assignment** screen appears.

Note: Only those users who have access to the application services for each business object within the approval workflow group will be able to modify the details of the price assignment request.

7. Make the required changes.
8. Modify the required details.

The changes made to the price assignment are saved.

Related Topics

For more information on...	See...
Modify Price Assignment screen	Modify Price Assignment on page 1006
Search zone	Search on page 1006
List of Price Assignments zone	List of Price Assignments on page 1010

Modifying a Price Assignment for a Person

Procedure

To modify a price assignment for a person:

1. Click the **Menu** link in the **Application** toolbar.
A list appears.
2. From the **Main** menu, select **Approval Workflow** and then click **Modify Price Assignment**.
The **Modify Price Assignment** screen appears.
3. In the **Search** zone, enter the search criteria, such as the division to which the person belongs or the person identification type and value.

Note: ORMB search engine supports wildcard search, where you can substitute the percentage (%) symbol as a stand in for any word or letter in a search criteria. You can use the ‘%’ wildcard character in all input fields except the date and ID fields. The ‘%’ wildcard character is suffixed automatically at the end of the partial search criteria. Therefore, you may or may not specify the wildcard character at the end of the partial search criteria. However, you have to prefix the wildcard character manually wherever required.

4. Click **Search**.
A list of persons that meet the search criteria appears in the **Search Results** section.
5. Click the **Broadcast** (📡) icon corresponding to the person whose price assignment requests you want to modify.
The **List of Price Assignments** zone appears.
6. Click the **Modify** link in the **Modify** column corresponding to the price assignment request that you want to modify.
The **Modify/Resolve Price Assignment** screen appears where you can modify the pricing details, tiering ranges, and price assignment characteristics.

Note: Only those users who have access to the application services for each business object within the approval workflow group will be able to modify the details of the price assignment request.

7. Make the required changes.
8. Click **Save**.
The price assignment for a person is updated.

Related Topics

For more information on...	See...
Modify Price Assignment screen	Modify Price Assignment on page 1006

For more information on...	See...
Search zone	Search on page 1006
List of Price Assignments zone	List of Price Assignments on page 1010

Modifying a Price Assignment for a Price List

Procedure

To modify a price assignment for a price list:

1. Click the **Menu** link in the **Application** toolbar.
A list appears.
2. From the **Main** menu, select **Approval Workflow** and then click **Modify Price Assignment**.
The **Modify Price Assignment** screen appears.
3. In the **Search** zone, enter the search criteria, such as the description of the price list.

Note: ORMB search engine supports wildcard search, where you can substitute the percentage (%) symbol as a stand in for any word or letter in a search criteria. You can use the ‘%’ wildcard character in all input fields except the date and ID fields. The ‘%’ wildcard character is suffixed automatically at the end of the partial search criteria. Therefore, you may or may not specify the wildcard character at the end of the partial search criteria. However, you have to prefix the wildcard character manually wherever required.

4. Click **Search**.
A list of price lists that meet the search criteria appears in the **Search Results** section.
5. Click the **Broadcast** () icon corresponding to the price list whose price assignment requests you want to modify.
The **List of Price Assignments** zone appears.
6. Click the **Modify** link in the **Modify** column corresponding to the price assignment request that you want modify.
The **Modify/Resolve Price Assignment** screen appears where you can modify the pricing details, tiering ranges, and price assignment characteristics.

Note: Only those users who have access to the application services for each business object within the approval workflow group will be able to modify the details of the price assignment request.

7. Make the required changes.
8. Click **Save**.
The price assignment for a price list is updated.

Related Topics

For more information on...	See...
Modify Price Assignment screen	Modify Price Assignment on page 1006
Search zone	Search on page 1006
List of Price Assignments zone	List of Price Assignments on page 1010

Withdrawing a Price Assignment for an Account

Procedure

To withdraw a price assignment for an account:

1. Click the **Menu** link in the **Application** toolbar.
A list appears.
2. Do the following:

If you want to...	Then...
Withdraw a price assignment request when it is in the Pending Approval status	From the Main menu, select Approval Workflow and then click Modify Price Assignment . The Modify Price Assignment screen appears.
Withdraw a price assignment request when it has been rejected by an approver at any level in the hierarchy	From the Main menu, select Approval Workflow and then click Resolve Price Assignment . The Resolve Price Assignment screen appears.

3. In the **Search** zone, enter the search criteria, such as the division to which the account belongs, account ID, or account identifier.

Note: ORMB search engine supports wildcard search, where you can substitute the percentage (%) symbol as a stand in for any word or letter in a search criteria. You can use the '%' wildcard character in all input fields except the date and ID fields. The '%' wildcard character is suffixed automatically at the end of the partial search criteria. Therefore, you may or may not specify the wildcard character at the end of the partial search criteria. However, you have to prefix the wildcard character manually wherever required.

4. Click **Search**.

A list of accounts that meet the search criteria appears in the **Search Results** section.

5. Click the **Broadcast** () icon corresponding to the account whose price assignment requests you want to withdraw.

The **List of Price Assignments** zone appears.

Note: The system provides you with a facility to view the log of a price assignment request from the **Modify Price Assignment** and **Resolve Price Assignment** screens before withdrawing a request.

6. Click the **Withdraw** link in the **Withdraw** column corresponding to the price assignment request that you want to withdraw.

A message box appears confirming whether you want to delete the price assignment request.

7. Click **OK**.

You will no longer be able to view this request in your workflow.

Related Topics

For more information on...	See...
Modify Price Assignment screen	Modify Price Assignment on page 1006
Resolve Price Assignment screen	Resolve Price Assignment on page 1017

Withdrawing a Price Assignment for a Person**Procedure**

To withdraw a price assignment for a person:

1. Click the **Menu** link in the **Application** toolbar.
A list appears.
2. Select the **Main** menu and do the following:

If you want to...	Then...
Withdraw a price assignment request when it is in the Pending Approval status	From the Main menu, select Approval Workflow and then click Modify Price Assignment . The Modify Price Assignment screen appears.
Withdraw a price assignment request when it has been rejected by an approver at any level in the hierarchy	From the Main menu, select Approval Workflow and then click Resolve Price Assignment . The Resolve Price Assignment screen appears.

3. In the **Search** zone, enter the search criteria, such as the division to which the person belongs or the person identification type and value.

Note: ORMB search engine supports wildcard search, where you can substitute the percentage (%) symbol as a stand in for any word or letter in a search criteria. You can use the ‘%’ wildcard character in all input fields except the date and ID fields. The ‘%’ wildcard character is suffixed automatically at the end of the partial search criteria. Therefore, you may or may not specify the wildcard character at the end of the partial search criteria. However, you have to prefix the wildcard character manually wherever required.

4. Click **Search**.
A list of persons that meet the search criteria appears in the **Search Results** section.
5. Click the **Broadcast** () icon corresponding to the person whose price assignment requests you want to withdraw.
The **List of Price Assignments** zone appears.

Note: The system provides you with a facility to view the log of a price assignment request from the **Modify Price Assignment** and **Resolve Price Assignment** screens before withdrawing a request.

6. Click the **Withdraw** link in the **Withdraw** column corresponding to the price assignment request that you want to withdraw.
A message box appears confirming whether you want to delete the price assignment request.
7. Click **OK**.
You will no longer be able to view this request in your workflow.

Related Topics

For more information on...	See...
Modify Price Assignment screen	Modify Price Assignment on page 1006
Resolve Price Assignment screen	Resolve Price Assignment on page 1017

Withdrawing a Price Assignment for a Price List

Procedure

To withdraw a price assignment for a price list:

1. Click the **Menu** link in the **Application** toolbar.
A list appears.

- Do the following:

If you want to...	Then...
Withdraw a price assignment request when it is in the Pending Approval status	From the Main menu, select Approval Workflow and then click Modify Price Assignment . The Modify Price Assignment screen appears.
Withdraw a price assignment request when it has been rejected by an approver at any level in the hierarchy	From the Main menu, select Approval Workflow and then click Resolve Price Assignment . The Resolve Price Assignment screen appears.

- In the **Search** zone, enter the search criteria, such as the description of the price list.

Note: ORMB search engine supports wildcard search, where you can substitute the percentage (%) symbol as a stand in for any word or letter in a search criteria. You can use the ‘%’ wildcard character in all input fields except the date and ID fields. The ‘%’ wildcard character is suffixed automatically at the end of the partial search criteria. Therefore, you may or may not specify the wildcard character at the end of the partial search criteria. However, you have to prefix the wildcard character manually wherever required.

- Click **Search**.

A list of price lists that meet the search criteria appears in the **Search Results** section.

- Click the **Broadcast** () icon corresponding to the price list whose price assignment requests you want to withdraw.

The **List of Price Assignments** zone appears.

Note: The system provides you with a facility to view the log of a price assignment request from the **Modify Price Assignment** and **Resolve Price Assignment** screens before withdrawing a request.

- Click the **Withdraw** link in the **Withdraw** column corresponding to the price assignment request that you want to withdraw.

A message box appears confirming whether you want to delete the price assignment request.

- Click **OK**.

You will no longer be able to view this request in your workflow.

Related Topics

For more information on...	See...
Modify Price Assignment screen	Modify Price Assignment on page 1006
Resolve Price Assignment screen	Resolve Price Assignment on page 1017

Viewing the Log of an Approval Transaction

Procedure

To view the log of an approval transaction:

- Click the **Menu** link in the **Application** toolbar.
A list appears.
- From the **Main** menu, select **Approval Workflow** and then click **Modify Price Assignment**.
The **Modify Price Assignment** screen appears.
- In the **Search** zone, enter the search criteria, such as the description of the price list.

Note: ORMB search engine supports wildcard search, where you can substitute the percentage (%) symbol as a stand in for any word or letter in a search criteria. You can use the ‘%’ wildcard character in all input fields except the date and ID fields. The ‘%’ wildcard character is suffixed automatically at the end of the partial search criteria. Therefore, you may or may not specify the wildcard character at the end of the partial search criteria. However, you have to prefix the wildcard character manually wherever required.

4. Click **Search**.

A list of price lists that meet the search criteria appears in the **Search Results** section.

5. Click the **Broadcast** () icon corresponding to the price list whose price assignment requests you want to modify.

The **List of Price Assignments** zone appears.

6. Click on **Log** link in the **View** column.

The **Approval Transaction Log** screen appears.

7. View the log of an approval transaction, as required.

Related Topics

For more information on...	See...
Modify Price Assignment screen	Modify Price Assignment on page 1006
Search zone	Search on page 1006
Approval Transaction Log zone	Approval Transaction Log on page 981

Resolve Price Assignment

If an approver at any level in the hierarchy rejects a price assignment request, a notification is sent to the submitter who has made the changes. The submitter then makes the required corrections based on the approver’s comments, and resubmits the changes for approval. In this case, the approval process starts once again from the beginning, and not from the level at which the request was rejected.

The **Resolve Price Assignment** screen allows you to resolve or withdraw a price assignment request. It consists of the following zones:

- [Search](#) on page 1017
- [List of Price Assignments](#) on page 1021

Search

The **Search** zone allows you to search for the price assignment requests rejected by approvers and pending for you to resolve. It contains the following two sections:

- **Search Criteria** — The **Search Criteria** section contains the following fields:

Field Name	Field Description	Mandatory (Yes or No)
Search By	Used to indicate whether you want to search price assignments using various details. The valid values are: <ul style="list-style-type: none"> • Person • Account • Price List • Submitter ID • Approver Transaction ID 	Yes
	Note: By default, the Person option is selected.	
Division	Used to search price assignments which belong to a particular division.	No
	Note: You can only view those divisions to which you have access in the Division list.	
Person Identifier Type	Used to specify the identifier type based on which you want to search for price assignment requests of a person.	Yes (Conditional)
	Note: This field appears when you select the Person option from the Search By list.	
Person Identifier	Used to specify the ID linked to the person.	Yes (Conditional)
	Note: This field appears when you select the Person option from the Search By list.	
Account ID	Used to search for price assignment requests created for an account.	No
	Note: This field appears when you select the Account option from the Search By list.	
Account Identifier Type	Used to specify the account identifier type of the account whose price assignment requests you want to search.	Yes (Conditional)
	Note: This field appears when you select the Account option from the Search By list.	
Account Identifier	Used to specify the value of the account identifier type.	Yes (Conditional)
	Note: This field appears when you select the Account option from the Search By list.	

Field Name	Field Description	Mandatory (Yes or No)
Price List Description	Used to search for price assignment requests created for a price list.	No
	Note: This field appears when you select the Price List option from the Search By list.	
Submitter ID	Used to search for price assignment requests that are created by a particular submitter.	No
	Note: This field appears when you select the Submitter ID option from the Search By list.	
Approval Transaction ID	Used to search the price assignment request using the approval transaction ID.	No
	Note: The approval transaction ID is generated automatically when the price assignment request is created. This field appears when you select the Approval Transaction ID option from the Search By list.	

Note: You must specify at least one search criterion while searching for a price assignments.

- **Search Results** — On clicking the **Search** button, the search results appear based on the specified search criteria. The **Search Results** section contains the following columns:

Column Name	Column Description
Person Identifier	Displays the ID linked to the person.
	Note: This column appears when you are searching for price assignment requests of a person.
Person Name	Displays the name of the person.
	Note: This column appears when you are searching for price assignment requests of a person.
Division	Displays the division to which the account, person, or price list belongs.
Account Information	Displays information about the account. In addition, this column has a context menu which helps in navigating to other screens in the application.
	Note: This column appears when you are searching for price assignment requests of an account. It has a link. On clicking the link, the Account screen appears where you can view the details of the respective account.

Column Name	Column Description
Account Identifier Type	Displays the account identifier type.
	Note: This column appears when you are searching for price assignment requests of an account.
Account Identifier	Displays the value of the account identifier type.
	Note: This column appears when you are searching for price assignment requests of an account.
Price List ID	Displays the price list ID.
	Note: This column appears only when you are searching for price assignment requests of a price list.
Price List Description	Displays the description of the price list.
	Note: This column appears when you are searching for price assignment requests of a price list.
Owner ID	Displays the ID of the person for whose account the approval workflow request is created.
Approval Transaction ID	Displays the approval transaction ID.
	Note: The approval transaction ID is generated automatically when the price assignment request is created.
Person Identifier Type	Displays the person identifier type.
	Note: This column appears when you are searching for price assignment requests of a person.

On clicking the **Broadcast** () icon corresponding to the account, person, or price list, the **List of Price Assignments** zone appears.

Related Topics

For more information on...	See...
How to resolve a price assignment for an account	Resolving a Price Assignment for an Account on page 1022
How to resolve a price assignment for a person	Resolving a Price Assignment for a Person on page 1023
How to resolve a price assignment for a price list	Resolving a Price Assignment for a Price List on page 1024
How to withdraw a price assignment for an account	Withdrawing a Price Assignment for an Account on page 1024
How to withdraw a price assignment for a person	Withdrawing a Price Assignment for a Person on page 1025
How to withdraw a price assignment for a price list	Withdrawing a Price Assignment for a Price List on page 1026

List of Price Assignments

The **List of Price Assignments** zone lists price assignment requests specific to an account, a person, or a price list. It contains the following columns:

Column Name	Column Description
Approval Transaction ID	Displays the approval transaction ID.
	Note: The approval transaction ID is generated automatically when the price assignment request is created.
Submitter Name	Indicates the submitter who has created the price assignment request.
Action	Indicates the type of action, such as Add , Update (UPD) , or Delete (DEL) performed by the submitter during price assignment.
Submitted On	Displays the date and time when the price assignment request was created by the submitter.
To Do Type	Displays the type of To Do (notification) received for the price assignment request.
Price Item	Displays the price item code.
Description	Displays the description of the product.
Pricing Currency	Indicates the currency in which the product pricing is defined.
Start Date	Displays the date from when the product pricing is effective.
End Date	Displays the date till when the product pricing is effective.
Approver Name	Indicates the approver who has rejected the price assignment request.
Rejected On	Displays the date and time when the price assignment request was rejected by an approver.
Reject Reason	Indicates the reason why the price assignment request was rejected.
Rejection Comments	Displays the additional details entered by an approver on rejecting the price assignment request.
Approval Transaction Information	Displays information about the approval transaction.
	Note: This information string is generated using the C1-APPTXNINF algorithm.
Resolve	On clicking the Resolve link, you can modify the details of the price assignment request, and resubmit it for approval. On resubmitting, the approval workflow process starts once again from the first level in the hierarchy.
Withdraw	On clicking the Withdraw link, you can withdraw the price assignment request. Once you withdraw the request, no further action will be taken on the request.
View	On clicking the Log link, you can view the log of the price assignment request from the Resolve Price Assignment screen before resolving or withdrawing a request.

By default, the **List of Price Assignments** zone does not appear in the **Resolve Price Assignment** screen. It appears when you click the **Broadcast** (📢) icon corresponding to the account, person, or price list in the **Search** zone.

Related Topics

For more information on...	See...
How to resolve a price assignment for an account	Resolving a Price Assignment for an Account on page 1022
How to resolve a price assignment for a person	Resolving a Price Assignment for a Person on page 1023
How to resolve a price assignment for a price list	Resolving a Price Assignment for a Price List on page 1024
How to withdraw a price assignment for an account	Withdrawing a Price Assignment for an Account on page 1024
How to withdraw a price assignment for a person	Withdrawing a Price Assignment for a Person on page 1025
How to withdraw a price assignment for a price list	Withdrawing a Price Assignment for a Price List on page 1026

Resolving a Price Assignment for an Account

Procedure

To resolve a price assignment for an account:

1. Click the **Menu** link in the **Application** toolbar.

A list appears.

2. From the **Main** menu, select **Approval Workflow** and then click **Resolve Price Assignment**.

The **Resolve Price Assignment** screen appears.

3. In the **Search** zone, enter the search criteria, such as the division to which the account belongs, account ID, or account identifier.

Note: ORMB search engine supports wildcard search, where you can substitute the percentage (%) symbol as a stand in for any word or letter in a search criteria. You can use the ‘%’ wildcard character in all input fields except the date and ID fields. The ‘%’ wildcard character is suffixed automatically at the end of the partial search criteria. Therefore, you may or may not specify the wildcard character at the end of the partial search criteria. However, you have to prefix the wildcard character manually wherever required.

4. Click **Search**.

A list of accounts that meet the search criteria appears in the **Search Results** section.

5. Click the **Broadcast** () icon corresponding to the account whose price assignment requests you want to resolve.

The **List of Price Assignments** zone appears.

6. Click the **Resolve** link in the **Resolve** column corresponding to the price assignment request that you want to resolve.

The **Modify/Resolve Price Assignment** screen appears where you can modify the pricing details, tiering ranges, and price assignment characteristics.

Note: Only those users who have access to the application services for each business object within the approval workflow group will be able to resolve the request and resubmit it for approval.

7. Make the required changes.

8. Click **Save**.

The price assignment is updated and resubmitted for approval.

Related Topics

For more information on...	See...
Resolve Price Assignment screen	Resolve Price Assignment on page 1017
Search zone	Search on page 1017
List of Price Assignments zone	List of Price Assignments on page 1021

Resolving a Price Assignment for a Person

Procedure

To resolve a price assignment for a person:

1. Click the **Menu** link in the **Application** toolbar.
A list appears.
2. From the **Main** menu, select **Approval Workflow** and then click **Resolve Price Assignment**.
The **Resolve Price Assignment** screen appears.
3. In the **Search** zone, enter the search criteria, such as the division to which the person belongs or the person identification type and value.

Note: ORMB search engine supports wildcard search, where you can substitute the percentage (%) symbol as a stand in for any word or letter in a search criteria. You can use the ‘%’ wildcard character in all input fields except the date and ID fields. The ‘%’ wildcard character is suffixed automatically at the end of the partial search criteria. Therefore, you may or may not specify the wildcard character at the end of the partial search criteria. However, you have to prefix the wildcard character manually wherever required.

4. Click **Search**.
A list of persons that meet the search criteria appears in the **Search Results** section.
5. Click the **Broadcast** () icon corresponding to the person whose price assignment requests you want to resolve.
The **List of Price Assignments** zone appears.
6. Click the **Resolve** link in the **Resolve** column corresponding to the price assignment request that you want to resolve.
A screen appears where you can modify the pricing details, tiering ranges, and price assignment characteristics.

Note: Only those users who have access to the application services for each business object within the approval workflow group will be able to resolve the request, and resubmit it for approval.

7. Make the required changes.
8. Click **Save**.
The price assignment is updated and resubmitted for approval.

Related Topics

For more information on...	See...
Resolve Price Assignment screen	Resolve Price Assignment on page 1017
Search zone	Search on page 1017
List of Price Assignments zone	List of Price Assignments on page 1021

Resolving a Price Assignment for a Price List

Procedure

To resolve a price assignment for a price list:

1. Click the **Menu** link in the **Application** toolbar.

A list appears.

2. From the **Main** menu, select **Approval Workflow** and then click **Resolve Price Assignment**.

The **Resolve Price Assignment** screen appears.

3. In the **Search** zone, enter the search criteria, such as the description of the price list.

Note: ORMB search engine supports wildcard search, where you can substitute the percentage (%) symbol as a stand in for any word or letter in a search criteria. You can use the ‘%’ wildcard character in all input fields except the date and ID fields. The ‘%’ wildcard character is suffixed automatically at the end of the partial search criteria. Therefore, you may or may not specify the wildcard character at the end of the partial search criteria. However, you have to prefix the wildcard character manually wherever required.

4. Click **Search**.

A list of price lists that meet the search criteria appears in the **Search Results** section.

5. Click the **Broadcast** (📡) icon corresponding to the price list whose price assignment requests you want to resolve.

The **List of Price Assignments** zone appears.

6. Click the **Resolve** link in the **Resolve** column corresponding to the price assignment request that you want to resolve.

The **Modify/Resolve Price Assignment** screen appears where you can modify the pricing details, tiering ranges, and price assignment characteristics.

Note: Only those users who have access to the application services for each business object within the approval workflow group will be able to resolve the request, and resubmit it for approval.

7. Make the required changes.

8. Click **Save**.

The price assignment is updated and resubmitted for approval.

Related Topics

For more information on...	See...
Resolve Price Assignment screen	Resolve Price Assignment on page 1017
Search zone	Search on page 1017
List of Price Assignments zone	List of Price Assignments on page 1021

Withdrawing a Price Assignment for an Account

Procedure

To withdraw a price assignment for an account:

1. Click the **Menu** link in the **Application** toolbar.

A list appears.

- Do the following:

If you want to...	Then...
Withdraw a price assignment request when it is in the Pending Approval status	From the Main menu, select Approval Workflow and then click Modify Price Assignment . The Modify Price Assignment screen appears.
Withdraw a price assignment request when it has been rejected by an approver at any level in the hierarchy	From the Main menu, select Approval Workflow and then click Resolve Price Assignment . The Resolve Price Assignment screen appears.

- In the **Search** zone, enter the search criteria, such as the division to which the account belongs, account ID, or account identifier.

Note: ORMB search engine supports wildcard search, where you can substitute the percentage (%) symbol as a stand in for any word or letter in a search criteria. You can use the '%' wildcard character in all input fields except the date and ID fields. The '%' wildcard character is suffixed automatically at the end of the partial search criteria. Therefore, you may or may not specify the wildcard character at the end of the partial search criteria. However, you have to prefix the wildcard character manually wherever required.

- Click **Search**.

A list of accounts that meet the search criteria appears in the **Search Results** section.

- Click the **Broadcast** (📡) icon corresponding to the account whose price assignment requests you want to withdraw.

The **List of Price Assignments** zone appears.

Note: The system provides you with a facility to view the log of a price assignment request from the **Modify Price Assignment** and **Resolve Price Assignment** screens before withdrawing a request.

- Click the **Withdraw** link in the **Withdraw** column corresponding to the price assignment request that you want to withdraw.

A message box appears confirming whether you want to delete the price assignment request.

- Click **OK**.

You will no longer be able to view this request in your workflow.

Related Topics

For more information on...	See...
Modify Price Assignment screen	Modify Price Assignment on page 1006
Resolve Price Assignment screen	Resolve Price Assignment on page 1017

Withdrawing a Price Assignment for a Person

Procedure

To withdraw a price assignment for a person:

- Click the **Menu** link in the **Application** toolbar.

A list appears.

- Select the **Main** menu and do the following:

If you want to...	Then...
Withdraw a price assignment request when it is in the Pending Approval status	From the Main menu, select Approval Workflow and then click Modify Price Assignment . The Modify Price Assignment screen appears.
Withdraw a price assignment request when it has been rejected by an approver at any level in the hierarchy	From the Main menu, select Approval Workflow and then click Resolve Price Assignment . The Resolve Price Assignment screen appears.

- In the **Search** zone, enter the search criteria, such as the division to which the person belongs or the person identification type and value.

Note: ORMB search engine supports wildcard search, where you can substitute the percentage (%) symbol as a stand in for any word or letter in a search criteria. You can use the '%' wildcard character in all input fields except the date and ID fields. The '%' wildcard character is suffixed automatically at the end of the partial search criteria. Therefore, you may or may not specify the wildcard character at the end of the partial search criteria. However, you have to prefix the wildcard character manually wherever required.

- Click **Search**.

A list of persons that meet the search criteria appears in the **Search Results** section.

- Click the **Broadcast** () icon corresponding to the person whose price assignment requests you want to withdraw.

The **List of Price Assignments** zone appears.

Note: The system provides you with a facility to view the log of a price assignment request from the **Modify Price Assignment** and **Resolve Price Assignment** screens before withdrawing a request.

- Click the **Withdraw** link in the **Withdraw** column corresponding to the price assignment request that you want to withdraw.

A message box appears confirming whether you want to delete the price assignment request.

- Click **OK**.

You will no longer be able to view this request in your workflow.

Related Topics

For more information on...	See...
Modify Price Assignment screen	Modify Price Assignment on page 1006
Resolve Price Assignment screen	Resolve Price Assignment on page 1017

Withdrawing a Price Assignment for a Price List

Procedure

To withdraw a price assignment for a price list:

- Click the **Menu** link in the **Application** toolbar.

A list appears.

- Do the following:

If you want to...	Then...
Withdraw a price assignment request when it is in the Pending Approval status	From the Main menu, select Approval Workflow and then click Modify Price Assignment . The Modify Price Assignment screen appears.
Withdraw a price assignment request when it has been rejected by an approver at any level in the hierarchy	From the Main menu, select Approval Workflow and then click Resolve Price Assignment . The Resolve Price Assignment screen appears.

- In the **Search** zone, enter the search criteria, such as the description of the price list.

Note: ORMB search engine supports wildcard search, where you can substitute the percentage (%) symbol as a stand in for any word or letter in a search criteria. You can use the '%' wildcard character in all input fields except the date and ID fields. The '%' wildcard character is suffixed automatically at the end of the partial search criteria. Therefore, you may or may not specify the wildcard character at the end of the partial search criteria. However, you have to prefix the wildcard character manually wherever required.

- Click **Search**.

A list of price lists that meet the search criteria appears in the **Search Results** section.

- Click the **Broadcast** () icon corresponding to the price list whose price assignment requests you want to withdraw.

The **List of Price Assignments** zone appears.

Note: The system provides you with a facility to view the log of a price assignment request from the **Modify Price Assignment** and **Resolve Price Assignment** screens before withdrawing a request.

- Click the **Withdraw** link in the **Withdraw** column corresponding to the price assignment request that you want to withdraw.

A message box appears confirming whether you want to delete the price assignment request.

- Click **OK**.

You will no longer be able to view this request in your workflow.

Related Topics

For more information on...	See...
Modify Price Assignment screen	Modify Price Assignment on page 1006
Resolve Price Assignment screen	Resolve Price Assignment on page 1017

Viewing the Log of an Approval Transaction

Procedure

To view the log of an approval transaction:

- Click the **Menu** link in the **Application** toolbar.
A list appears.
- From the **Main** menu, select **Approval Workflow** and then click **Modify Price Assignment**.
The **Resolve Price Assignment** screen appears.
- In the **Search** zone, enter the search criteria, such as the description of the price list.

Note: ORMB search engine supports wildcard search, where you can substitute the percentage (%) symbol as a stand in for any word or letter in a search criteria. You can use the ‘%’ wildcard character in all input fields except the date and ID fields. The ‘%’ wildcard character is suffixed automatically at the end of the partial search criteria. Therefore, you may or may not specify the wildcard character at the end of the partial search criteria. However, you have to prefix the wildcard character manually wherever required.

4. Click Search.

A list of price lists that meet the search criteria appears in the **Search Results** section.

5. Click the Broadcast () icon corresponding to the price list whose price assignment requests you want to modify.

The **List of Price Assignments** zone appears.

6. Click on Log link in the View column.

The **Approval Transaction Log** screen appears.

7. You can view the log of an approval transaction, as required.

Related Topics

For more information on...	See...
Approval Transaction screen	Approval Transaction on page 977
Search zone	Search on page 1017
Approval Transaction Log zone	Approval Transaction Log on page 981

Approval Workflow Group (Used for Searching)

The **Approval Workflow Group** screen allows you to search for approval workflow group using various search criteria. Through this screen, you can navigate to the following screen:

- [Approval Workflow Group \(Used for Viewing\)](#) on page 1037

This screen consists of the following zone:

- [Search Approval Workflow Group](#) on page 1028

For more information on...	See...
How to search an approval workflow group	Searching for an Approval Workflow Group on page 1029
How to view the details of approval workflow group	Viewing the Approval Workflow Group Details on page 1030

Search Approval Workflow Group

The **Search Approval Workflow Group** zone allows you to search for an approval workflow group using various search criteria. It contains the following sections:

- **Search Criteria** - The **Search Criteria** section contains the following fields:

Field Name	Field Description	Mandatory (Yes or No)
Approval Workflow Group	Used to search a particular approval workflow group.	No

Field Name	Field Description	Mandatory (Yes or No)
Description	Used to search approval workflow groups with a particular description.	No

- **Search Results** - On clicking the **Search** button, the search results appear based on the specified search criteria. The **Search Results** section contains the following columns:

Column Name	Column Description
Approval Workflow Group	Displays the approval workflow group.
Description	Displays the description of the approval workflow group.
	Note: It has a link. On clicking the link, the Approval Workflow Group screen appears where you can view the details of the respective approval workflow group.

Note: You must specify at least one search criterion while searching for an Approval Workflow Group.

Related Topics

For more information on...	See...
How to search for an approval workflow group	Searching for an Approval Workflow Group on page 1029
How to view the details of an approval workflow group	Viewing the Approval Workflow Group Details on page 1030

Searching for an Approval Workflow Group

Procedure

To search for an approval workflow group:

1. Click the **Admin** link in the **Application** toolbar.
A list appears.
2. From the **Admin** menu, select **A** and then click **Approval Workflow Group**.
The **Approval Workflow Group** screen appears.
3. Enter the search criteria in the **Search Approval Workflow Group** zone.

Note: ORMB search engine supports wildcard search, where you can substitute the percentage (%) symbol as a stand in for any word or letter in a search criteria. You can use the ‘%’ wildcard character in all input fields except the date and ID fields. The ‘%’ wildcard character is suffixed automatically at the end of the partial search criteria. Therefore, you may or may not specify the wildcard character at the end of the partial search criteria. However, you have to prefix the wildcard character manually wherever required.

4. Click **Search**.

A list of approval workflow groups that meet the search criteria appear in the **Search Results** section.

Related Topics

For more information on...	See...
Search Approval Workflow Group screen	Approval Workflow Group (Used for Searching) on page 1028

For more information on...	See...
Search Approval Workflow Group zone	Search Approval Workflow Group on page 1028

Viewing the Approval Workflow Group Details

Procedure

To view the details of an approval workflow group:

1. Search for the approval workflow group in the **Approval Workflow Group** screen.
2. In the **Search Results** section, click the link in the **Description** column corresponding to the approval workflow group whose details you want to view.

The **Approval Workflow Group** screen appears. It consists of the **Main** tab with the following zone:

- [Approval Workflow Group](#) on page 1038
3. View the details of the approval workflow group in the **Approval Workflow Group** zone.

Related Topics

For more information on...	See...
How to search for an approval workflow group	Searching for an Approval Workflow Group on page 1029
Approval Workflow Group screen	Approval Workflow Group (Used for Searching) on page 1028
Approval Workflow Group zone	Search Approval Workflow Group on page 1028

Defining an Approval Workflow Group

Prerequisites

To define an approval workflow group, you should have:

- Input and Display UI maps created in the application in case you want to use custom UI maps.
- Dependency, Approval, and Approval Post Processing algorithms defined in the application in case you want to use any of them.

Note: Before you define an approval workflow group for the User BO, you need to attach the **C1-APPTXNBAS** algorithm on the **Audit** algorithm spot of the business object belonging to the USER-SC MO, and not the USER MO.

Procedure

To define an approval workflow group:

1. Click the **Admin** link in the **Application** toolbar.
A list appears.
2. From the **Admin** menu, Select **A** and then click **Approval Workflow Group**.
The **Approval Workflow Group** screen appears.
3. Click the **Add** button in the **Page Title** area of **Approval Workflow Group** screen.

The **Approval Workflow Group** screen appears. It contains the following sections:

- **Main** - Used to specify basic details about the approval workflow group.
- **Business Objects and Group BO Relation** - Used to add business objects and define group BO Relation for the approval workflow group.

The **Main** section contains the following:

Field Name	Field Description	Mandatory (Yes or No)
Approval Transaction Type	Used to indicate the transaction type to which the approval workflow group belongs.	Yes
Approval Workflow Group	Used to specify the approval workflow group.	Yes
Description	Used to specify the approval workflow group with a particular description.	Yes
Display UI Map	<p>Used to specify the UI map that you want to use for viewing data of the business objects within the approval workflow group.</p> <p>Note: You can search for a UI map, code, and an algorithm by clicking the Search icon (🔍) corresponding to the Display UI Map field.</p> <p>Note: If you clear the Display UI Map field, you need to either manually specify the UI map or automatically regenerate the UI map by clicking the Regenerate UI Maps icon corresponding to the group in the Approval Workflow Settings screen.</p>	No
Input UI Map	<p>Used to specify the UI map that you want to use for modifying data of the business objects within the approval workflow group.</p> <p>Note: You can search for a UI map, code, and an algorithm by clicking the Search icon (🔍) corresponding to the Input UI Map field.</p> <p>Note: If you clear the Input UI Map field, you need to either manually specify the UI map or automatically regenerate the UI map by clicking the Regenerate UI Maps icon corresponding to the group in the Approval Workflow Settings screen.</p>	No
Dependency Algorithm	<p>Used to specify the algorithm that will be triggered before creating the approval workflow group.</p> <p>Note: You can search for a Input UI map, code, and an algorithm by clicking the Search icon (🔍) corresponding to the Dependency Algorithm field.</p> <p>Note: This algorithm can be used to check all prerequisites before creating the approval workflow group.</p>	No

Field Name	Field Description	Mandatory (Yes or No)
Approval Algorithm	<p>Used to specify the algorithm that will be triggered after the approval workflow group is approved by the approver at the last level in the hierarchy. The following approval algorithms are shipped with ORMB:</p> <ul style="list-style-type: none"> • C1-APPPROD - This approval algorithm is used for the C1PRODUCT group, which is shipped with ORMB. • C1-APPPL - This approval algorithm is used for the C1PRICELST group, which is shipped with ORMB. • C1-APPASG - This approval algorithm is used for the C1PRICEASG group, which is shipped with ORMB. • C1-APPALG - This is a standard approval algorithm that you can use for approval workflow groups where custom logic is not required. <p>You can also create your own approval algorithms for custom UIs.</p> <p>Note: You can search for a Input UI map, code, and an algorithm by clicking the Search icon (🔍) corresponding to the Approval Algorithm field.</p>	No
Approval Post Processing Algorithm	<p>Used to specify the algorithm that will be triggered after the changes (which are approved by all approvers' in the hierarchy) are committed to the database.</p> <p>Note: You can search for a Input UI map, code, and an algorithm by clicking the Search icon (🔍) corresponding to the Approval Post Processing Algorithm field.</p>	No

Field Name	Field Description	Mandatory (Yes or No)
Transaction Creation Algorithm	<p>Used to specify the algorithm that will create approval workflow group. The following transaction creation algorithms are shipped with ORMB:</p> <ul style="list-style-type: none"> • C1-APPASGCR - Used to create approval workflow group for price assignment. • C1-AXPROD - Used to create approval workflow group for price item. • C1-AXUSR - Used to create approval workflow group for user. • C1-IGCREATE - Used to create approval workflow group for invoicing group. • C1-AXCREATE - This is a standard transaction creation algorithm that you can use to create approval workflow group for most of the base objects. <p>You can also create your own transaction creation algorithms for custom UIs.</p> <p>In case of the base UIs, this algorithm is only used while modifying or resolving a group. The initial approval transaction creation for base UIs takes place through the Audit algorithm attached on the business object.</p> <p>Note: You can search for a Input UI map, code, and an algorithm by clicking the Search icon (🔍) corresponding to the Transaction Creation Algorithm field.</p>	Yes
Data Retrieval Algorithm	<p>Used to specify the algorithm that will be triggered to retrieve the original data of the business objects within the approval workflow group. This will help an approver to compare the original and new data in case where the submitter action is Update (UPD). The following data retrieval algorithms are shipped with ORMB:</p> <ul style="list-style-type: none"> • C1-APPIGDR - Used to retrieve data for invoicing group. • C1-AXPRICEOV - Used to retrieve data for price assignment. • C1_APPDATA - This is a standard data retrieval algorithm that you can use to retrieve data for most of the base objects. <p>You can also create your own data retrieval algorithms for custom UIs.</p> <p>Note: You can search for a Input UI map, code, and an algorithm by clicking the Search icon (🔍) corresponding to the Data Retrieval Algorithm field.</p>	Yes

Field Name	Field Description	Mandatory (Yes or No)
Information Algorithm	Used to specify the algorithm information.	No
	Note: You can search for a Input UI map, code, and an algorithm by clicking the Search icon (🔍) corresponding to the Approval Post Processing Algorithm field.	
Compare Map	Used to specify the customized Display UI map that you want to use for the approval workflow group. It overrides the UI map specified in the Display UI Map field.	No
	Note: You can search for a Input UI map, code, and an algorithm by clicking the Search icon (🔍) corresponding to the Approval Post Processing Algorithm field.	
Input Script	Used to specify the customized Input UI map that you want to use for the approval workflow group. It overrides the UI map specified in the Input UI Map field.	No
	Note: You can search for a Input UI map, code, and an algorithm by clicking the Search icon (🔍) corresponding to the Approval Post Processing Algorithm field.	

4. Enter the required details.
5. Add business objects and group BO relation with the approval workflow group, if required.
6. Click **Save**.

The approval workflow group is defined.

Related Topics

For more information on...	See...
Approval Workflow Group screen	Approval Workflow Group (Used for Viewing) on page 1037
Approval Workflow Group zone	Approval Workflow Group on page 1038
How to add business objects and group BO relation	Adding a Business Object

Adding a Business Object

Prerequisites

To add a business object in the approval workflow group, you should have:

- Business object and approval workflow group created in the application.

Procedure

To add a business object in the approval workflow group:

1. Click the **Admin** link in the **Application** toolbar.
A list appears.
2. From the **Admin** menu, Select **A**, and then click **Approval Workflow Group**.

The **Approval Workflow Group** screen appears.

- Click the **Add** button in the page-title area of the **Approval Workflow Group** screen.

The **Approval Workflow Group** screen appears. It contains following sections:

- Main** - Used to specify basic details of the approval workflow group.
- Business Objects and Group BO Relation** - Used to specify the fields that allow to define business and parent objects and link them with the approval workflow group.

The **Business Objects and Group BO Relation** section contains following fields:

Field Name	Field Description	Mandatory (Yes or No)
Business Object	Used to specify the Business Object Code that you want to include in the Approval Workflow Group.	Yes
Reference ID 1	Used to specify the XPATH key of the field in the business object that you want to display in the approval transaction information string.	Yes
Reference ID 2	Used to specify the XPATH key of the field in the business object that you want to display in the approval transaction information string.	Yes
Reference ID 3	Used to specify the XPATH key of the field in the business object that you want to display in the approval transaction information string.	Yes
Reference ID 4	Used to specify the XPATH key of the field in the business object that you want to display in the approval transaction information string.	Yes
Reference Foreign Key 1	Used to specify the XPATH key of the field in the business object that you want to use for validating whether duplicate approval transaction exists in the system.	No
Reference Foreign Key 2	Used to specify the XPATH key of the field in the business object that you want to use for validating whether duplicate approval transaction exists in the system.	No
Reference Foreign Key 3	Used to specify the XPATH key of the field in the business object that you want to use for validating whether duplicate approval transaction exists in the system.	No
Reference Foreign Key 4	Used to specify the XPATH key of the field in the business object that you want to use for validating whether duplicate approval transaction exists in the system.	No
Reference Foreign Key 5	Used to specify the XPATH key of the field in the business object that you want to use for validating whether duplicate approval transaction exists in the system.	No
Reference Foreign Key 6	Used to specify the XPATH key of the field in the business object that you want to use for validating whether duplicate approval transaction exists in the system.	No

Field Name	Field Description	Mandatory (Yes or No)
List	Used to indicate whether the group contains one or multiple instance of the business object. For example, if you want to create a group that contains multiple account objects, you need to set this flag for the Account BO to True. If you want to create a group that contains single instance of the business object, you must set this flag for the business object to False.	Yes
Parent Business Object	Used to specify the parent business object. This should be one of the business objects within the group.	No
From Key	Used to specify the XPATH key of the field or list of fields in the parent business object.	No
To Key	Used to specify the XPATH key of the field or list of fields in the current business object.	No

Note: You can search for a business object and parent business object, by clicking the **Search** (🔍) icon placed corresponding to the **Business Object** field.

- If you want to define more than one business and parent business object for the approval workflow group, click the **Add** (+) icon placed corresponding to the field.
- Enter the required details in **Main** and **Business Objects and Group BO Relation** sections.
- Click **Save**

The business object is added in the approval workflow group.

Note: When you add business objects in an approval workflow group, you need to regenerate the Input and Display UI maps by clicking the **Regenerate UI Maps** (🔄) icon corresponding to the group in the **Approval Workflow Settings** screen. You must do this when you are using automatically generated UI maps, and not otherwise.

Related Topics

For more information on...	See...
Approval Workflow Group screen	Approval Workflow Group (Used for Viewing) on page 1037
Approval Workflow Group zone	Approval Workflow Group on page 1038

Defining a Group BO Relation

Prerequisites

To define a relationship between business object in the approval workflow group, you should have:

- Business objects added in the approval workflow group.

Procedure

To define a relationship between business objects in the approval workflow group:

- Click the **Admin** link in the **Application** toolbar.
A list appears.
- From the **Admin** menu, Select **A** and then click **Approval Workflow Group**.

The **Approval Workflow Group** screen appears.

3. Search for an approval workflow group in the **Approval Workflow Group** screen.
4. In the **Search Results** section, click the link in the **Description** column corresponding to the approval workflow group.
5. The **Approval Workflow Group** screen appears. It contains following sections:
 - **Main** - Used to specify basic details of the approval workflow group.
 - **Business Objects and Group BO Relation** - Used to specify the fields that allow to define business and parent objects, and link them with the approval workflow group.
6. Define and edit the approval workflow group details from the **Main** section, if required.
7. If you only want to define a business object, enter the required details in the **Business Objects and Group BO Relation** section.
8. If you want to define a group BO relation with the business object, enter the required details in the following fields.
 - a) **Parent Business Object**
 - b) **From Key**
 - c) **To Key**

Note: If you want to define more than one business or parent object, click the **Add** (+) icon and then repeat step 2. However, if you want to remove a business or parent object, click the **Delete** (🗑️) icon corresponding to the business or parent object field.

9. Click **Save**.

The business object is defined, and its relationship with the parent object is also defined in the approval workflow group.

Related Topics

For more information on...	See...
How to define an approval workflow group	Defining an Approval Workflow Group on page 1030
How to define an approval workflow business object	Adding a Business Object
How to define an approval workflow group BO object	Defining a Group BO Relation on page 1036

Approval Workflow Group (Used for Viewing)

Once you define an approval workflow group, the **Approval Workflow Group** screen allows you to:

- Edit the details of an approval workflow group
- Edit the details of business objects and group business object relation
- Delete an approval workflow group
- Delete a business object and a group business object relation
- View the details of an approval workflow group

This screen consists of the following zone:

- [Approval Workflow Group](#) on page 1038

Approval Workflow Group

The **Approval Workflow Group** zone displays the details of the approval workflow group. It contains the following sections:

- **Main** - Displays basic information about the approval workflow group. It contains the following fields:

Field Name	Field Description
Approval Workflow Group	Displays the name of the approval workflow group.
Description	Displays the description of the approval workflow group.
Display UI Map	Indicates the UI map that will be used for viewing data of the business objects within the approval workflow group. Note: It has a link. On clicking the link, the UI Map screen appears where you can view the details of the respective UI Map.
Input UI Map	Indicates the UI map that will be used for modifying data of the business objects within the approval workflow group. Note: It has a link. On clicking the link, the UI Map screen appears where you can view the details of the respective UI Map.
Dependency Algorithm	Indicates the algorithm that will be triggered before creating the approval workflow request. Note: This algorithm can be used to check all prerequisites before creating the approval workflow request.
Approval Algorithm	Indicates the algorithm that will be triggered after the approval workflow request is approved by the approver at the last level in the hierarchy.
Approval Post Processing Algorithm	Indicates the algorithm that will be triggered after the changes (which are approved by all approvers in the hierarchy) are committed to the database.
Transaction Creation Algorithm	Indicates the algorithm that will create approval workflow requests. Note: It has a link. On clicking the link, the Algorithm screen appears where you can view the details of the respective algorithm.
Data Retrieval Algorithm	Indicates the algorithm that will be triggered to retrieve the original data of the business objects within the approval workflow group. This will help an approver to compare the original and new data in case where the submitter action is Update (UPD). Note: It has a link. On clicking the link, the Algorithm screen appears where you can view the details of the respective algorithm.
Information Algorithm	Indicates the Approval Transaction information from the Approval Transactions that are created for a particular entity, based on the inputs of the XPath paths provided in the Reference IDs.
Compare Map	Indicates the customized Display UI map that you want to use for the approval workflow group. It overrides the UI map specified in the Display UI Map field.
Input Script	Indicates the customized Input UI map that you want to use for the approval workflow group. It overrides the UI map specified in the Input UI Map field.

- **Record Actions** - This section contains the following buttons:

Button Name	Button Description
Edit	Used to define, edit the approval workflow group. It is also used to delete the business objects and group BO relation.
Delete	Used to delete an approval workflow group.

- **Record Information** - This section contains the following fields:

Field Name	Field Description
Business Object	Indicates the business object using which the approval workflow group is created. In addition, a context menu appears corresponding to this field which helps in navigating to other screens in the application.
	Note: It has a link. On clicking the link, the Business Object screen appears where you can view the details of the respective business object.

- **Business Objects And Group BO Relation** - The Business Objects And Group BO Relation contains the following fields:

Field Name	Field Description
Business Object	Indicates the Business Object that you want to include in the Approval Workflow Group.
Reference ID 1	Indicates the XPATH key of the field in the business object that you want to display in the approval transaction information string.
Reference ID 2	Indicates the XPATH key of the field in the business object that you want to display in the approval transaction information string.
Reference ID 3	Indicates the XPATH key of the field in the business object that you want to display in the approval transaction information string.
Reference ID 4	Indicates the XPATH key of the field in the business object that you want to display in the approval transaction information string.
Reference Foreign Key 1	Indicates the XPATH key of the field in the business object that you want to use for validating whether duplicate approval transaction exists in the system.
Reference Foreign Key 2	Indicates the XPATH key of the field in the business object that you want to use for validating whether duplicate approval transaction exists in the system.
Reference Foreign Key 3	Indicates the XPATH key of the field in the business object that you want to use for validating whether duplicate approval transaction exists in the system.
Reference Foreign Key 4	Indicates the XPATH key of the field in the business object that you want to use for validating whether duplicate approval transaction exists in the system.
Reference Foreign Key 5	Indicates the XPATH key of the field in the business object that you want to use for validating whether duplicate approval transaction exists in the system.
Reference Foreign Key 6	Indicates the XPATH key of the field in the business object that you want to use for validating whether duplicate approval transaction exists in the system.

Field Name	Field Description
List	Indicates whether the group contains one or multiple instance of the business object. For example, if you want to create a group that contains multiple account objects, you need to set this flag for the Account BO to True. If you want to create a group that contains single instance of the business object, you must set this flag for the business object to False.
Parent Business Object	Indicates the parent business object. This should be one of the business objects within the group.
From Key	Indicates the XPATH key of the field or list of fields in the parent business object.
To Key	Indicates the XPATH key of the field or list of fields in the current business object.

Editing an Approval Workflow Group

Procedure

To edit an approval workflow group:

1. Search for the approval workflow group in the **Approval Workflow Group**.
2. In the **Search Results** section, click the link in the **Description** column corresponding to the approval workflow group whose details you want to edit.

The **Approval Workflow Group** screen appears.

3. Click the **Edit** button in the **Approval workflow Group** zone.

The **Approval Workflow Group** screen appears.

4. Modify the details of the approval workflow group, if required.
5. Define, edit, or remove business objects and group BO relation from the approval workflow group, if required.
6. Click **Save**.

The changes made to the approval workflow group are saved.

Related Topics

For more information on...	See...
How to search for an approval workflow group	Searching for an Approval Workflow Group on page 1029
How to add a business object	Adding a Business Object on page 1034
How to define a Group BO Relation	Defining a Group BO Relation on page 1036

Deleting an Approval Workflow Group

Procedure

To delete an approval workflow group:

1. Search for the approval workflow group in the **Search Approval Workflow Group** screen.
2. In the **Search Results** section, click the link in the **Description** column corresponding to the approval workflow group that you want to delete.
3. Click the **Delete** button in the **Approval Workflow Group** zone.

A message appears confirming whether you want to delete the approval workflow group.

4. Click **OK**.

The approval workflow group is deleted.

Related Topics

For more information on...	See...
How to search for an approval workflow group	Searching for an Approval Workflow Group on page 1029

Editing a Business Object

Procedure

To edit a business object in the approval workflow group:

1. From the **Admin** menu, select **A** and then click **Approval Workflow Group**.
The **Approval Workflow Group** screen appears.
2. Search for an approval workflow group in the **Search Approval Workflow Group** zone.
3. In the **Search Results** section, click the link in the **Description** column corresponding to the approval workflow group whose details you want to edit.
4. The **Approval Workflow Group** zone appears. Click the **Edit** button from **Record Action** sections.

The **Approval Workflow Group** screen appears. It contains the following sections:

- **Main** - Used to specify the basic details of the approval workflow group.
- **Business Objects and Group BO Relation** - Used to specify the fields that allow to define business objects and link them with the approval workflow group

The **Business Objects and Group BO Relation** section contains following fields:

Field Name	Field Description	Mandatory (Yes or No)
Business Object	Displays the Business Object Code that is included in the Approval Workflow Group.	Yes
Reference ID 1	Displays the XPATH key of the field in the business object that you want to use as criteria for searching approval workflow groups.	No
Reference ID 2	Displays the XPATH key of the field in the business object that you want to use as criteria for searching approval workflow groups.	No
Reference ID 3	Displays the XPATH key of the field in the business object that you want to use as criteria for searching approval workflow groups.	No
Reference ID 4	Displays the XPATH key of the field in the business object that you want to use as criteria for searching approval workflow groups.	No
Reference Foreign Key 1	Displays the XPATH key of the field in the business object that you want to use for validating whether duplicate approval transaction exists in the system.	No
Reference Foreign Key 2	Displays the XPATH key of the field in the business object that you want to use for validating whether duplicate approval transaction exists in the system.	No

Field Name	Field Description	Mandatory (Yes or No)
Reference Foreign Key 3	Displays the XPATH key of the field in the business object that you want to use for validating whether duplicate approval transaction exists in the system.	No
Reference Foreign Key 4	Displays the XPATH key of the field in the business object that you want to use for validating whether duplicate approval transaction exists in the system.	No
Reference Foreign Key 5	Displays the XPATH key of the field in the business object that you want to use for validating whether duplicate approval transaction exists in the system.	No
Reference Foreign Key 6	Displays the XPATH key of the field in the business object that you want to use for validating whether duplicate approval transaction exists in the system.	No
List	Indicates whether the group contains one or multiple instance of the business object. For example, if you want to create a group that contains multiple account objects, you need to set this flag for the Account BO to True. If you want to create a group that contains single instance of the business object, you must set this flag for the business object to False.	Yes
Parent Business Object	Used to specify the parent business object. This should be one of the business objects within the group.	No
From Key	Display the XPATH key of the field or list of fields in the parent business object.	No
To Key	Display the XPATH key of the field or list of fields in the current business object.	No

Note: You can search for a business object or parent business object by clicking the **Search** (🔍) icon placed corresponding to the **Business Object** and **Parent Business Object** field.

- If you want to define more than one business object or parent object for the approval workflow group, click the **Add** (+) icon placed corresponding to the field.
- Enter the required details in **Main** and **Business Objects and Group BO Relation** sections.
- Click **Save**.

The changes made to the business object in approval workflow group are saved.

Note: When you change business objects in an approval workflow group, you need to regenerate the Input and Display UI maps by clicking the **Regenerate UI Maps** (🔄) icon corresponding to the group in the **Approval Workflow Settings** screen. You must do this when you are using automatically generated UI maps, and not otherwise.

Related Topics

For more information on...	See...
Approval Workflow Group screen	Approval Workflow Group (Used for Searching) on page 1028
Approval Workflow Group zone	Search Approval Workflow Group on page 1028
How to delete a Business Object	Deleting a Business Object on page 1043

Deleting a Business Object

Procedure

To delete a business object in the approval workflow group:

1. Search for an approval workflow group in the **Approval Workflow Group** screen.
2. In the **Search Results** section, click the link in the **Description** column corresponding to the approval workflow group.

The **Approval Workflow Group** zone appears.

3. In the View section of **Approval Workflow Group**, click the **Edit** button.

The **Approval Workflow Group** window appears.

4. In the **Business Objects and Group BO Relation** zone, click the **Delete** (🗑️) icon corresponding to the business object that you want to delete.
5. Click **Save**.

The business object is deleted from the approval workflow group.

Related Topics

For more information on...	See...
Approval Workflow Group screen	Approval Workflow Group (Used for Searching) on page 1028
Approval Workflow Group zone	Search Approval Workflow Group on page 1028

Editing a Group BO Relation

Procedure

To edit the business object's relationship details in the approval workflow group:

1. If required, filter the approval workflow group in the **Approval Workflow Group** screen.
2. In the **Search Results** section, click the link in the **Description** column corresponding to the approval workflow group.

The **Approval Workflow Group** screen appears. It contains following two sections:

- **Main** - Displays the basic details of the approval workflow group.
- **Business Objects and Group BO Relation** - Displays the fields that allow to define or edit business objects, and link them with the approval workflow group.

3. If required, define and edit the approval workflow group details from the **Main** section.
4. The **Business Objects and Group BO Relation** section contains following fields:

Field Name	Field Description	Mandatory (Yes or No)
Business Object	Used to specify the business object that you want to add in the approval workflow group.	Yes
Reference ID 1	Used to indicate the XPATH key of the field that you want to concatenate in the approval transaction information string.	No
Reference ID 2	Used to indicate the XPATH key of the field that you want to concatenate in the approval transaction information string.	No

Field Name	Field Description	Mandatory (Yes or No)
Reference ID 3	Used to indicate the XPATH key of the field that you want to concatenate in the approval transaction information string.	No
Reference ID 4	Used to indicate the XPATH key of the field that you want to concatenate in the approval transaction information string.	No
Reference Foreign Key 1	Used to indicate the XPATH key of the field that you want to use while validating whether a duplicate approval transaction does not exist in the system.	No
Reference Foreign Key 2	Used to indicate the XPATH key of the field that you want to use while validating whether a duplicate approval transaction does not exist in the system.	No
Reference Foreign Key 3	Used to indicate the XPATH key of the field that you want to use while validating whether a duplicate approval transaction does not exist in the system.	No
Reference Foreign Key 4	Used to indicate the XPATH key of the field that you want to use while validating whether a duplicate approval transaction does not exist in the system.	No
Reference Foreign Key 5	Used to indicate the XPATH key of the field that you want to use while validating whether a duplicate approval transaction does not exist in the system.	No
Reference Foreign Key 6	Used to indicate the XPATH key of the field that you want to use while validating whether a duplicate approval transaction does not exist in the system.	No
List	Indicates whether the group contains one or multiple instance of the business object. For example, if you want to create a group that contains multiple account objects, you need to set this flag for the Account BO to True. If you want to create a group that contains single instance of the business object, you must set this flag for the business object to False.	Yes
Parent Business Object	Displays the parent business object. This should be one of the business objects within the group.	No
From Key	Displays the XPATH key of the field or list of fields in the parent business object.	No
To Key	Displays the XPATH key of the field or list of fields in the current business object.	No

Note: You can search for a parent business object by clicking the **Search** (🔍) icon placed corresponding to the field. You can also define a new parent business object by clicking the **Add** (+) icon placed corresponding to the field.

5. Modify the required details in **Business Objects and Group BO Relation** section.
6. Click **Save**.

The changes made to business object's relationship are saved in the approval workflow group.

Related Topics

For more information on...	See...
Search Approval Workflow Group screen	Approval Workflow Group (Used for Searching) on page 1028
Search Approval Workflow Group zone	Search Approval Workflow Group on page 1028
How to edit a Business Object	Editing a Business Object on page 1041
How to edit a Group BO Relation	Editing a Group BO Relation on page 1043

Deleting a Group BO Relation**Procedure**

To delete the business object's relationship details in the approval workflow group:

1. If required, filter the approval workflow group in the **Approval Workflow Group** screen.
2. In the **Search Results** section, click the link in the **Description** column corresponding to the approval workflow group.
3. The **Approval Workflow Group** screen appears.
4. Click the **Edit** button in the **Record Actions** zone.
The **Approval Workflow Group** screen appears.
5. In the **Business Objects and Group BO Relation** section, click the **Delete** (🗑️) icon appearing next to the Business Object that you want to delete.
6. Click **Save**

The business object's relationship details are deleted from the approval workflow group.

Related Topics

For more information on...	See...
Approval Workflow Group screen	Approval Workflow Group (Used for Searching) on page 1028
Approval Workflow Group zone	Search Approval Workflow Group on page 1028
How to delete a Business Object	Deleting a Business Object on page 1043
How to delete a Group BO Relation	Deleting a Group BO Relation on page 1045

Approval Workflow Chain (Used for Searching)

The **Approval Workflow Chain** screen allows you to search for approval workflow chain using various search criteria. Through this screen, you can navigate to the following screen:

- [Approval Workflow Chain \(Used for Viewing\)](#) on page 1049

This screen consists of the following zone:

- [Search Approval Workflow Chain](#) on page 1045

Search Approval Workflow Chain

The **Search Approval Workflow Chain** zone allows you to search for an approval workflow chain using various search criteria. It contains the following two sections:

- **Search Criteria** - The **Search Criteria** section contains the following fields:

Field Name	Field Description	Mandatory (Yes or No)
Approval Workflow Chain	Used to search a particular approval workflow chain.	No
Description	Used to search approval workflow chains with a particular description.	No

- **Search Results** - On clicking the **Search** button, the search results appear based on the specified search. The **Search Results** section contains the following columns:

Column Name	Column Description
Approval Workflow Chain	Displays the approval workflow chain.
Description	Displays the description of the approval workflow chain.
	Note: It has a link. On clicking the link, the Approval Workflow Chain screen appears where you can view the details of the respective approval workflow chain.

Note: You must specify at least one search criterion while searching for an approval workflow chain.

Related Topics

For more information on...	See...
How to search for an approval workflow chain	Searching for an Approval Workflow Chain on page 1046
How to view the details of an approval workflow chain	Viewing the Approval Workflow Chain Details on page 1047

Searching for an Approval Workflow Chain

Procedure

To search the approval workflow chain:

1. Click the **Admin** link in the **Application** toolbar.
A list appears.
2. From the **Admin** menu, select **A** and then click **Approval Workflow Chain**.

The **Approval Workflow Chain** screen appears.

3. Enter the search criteria in the **Search Approval Workflow Chain** zone.

ORMB search engine supports wildcard search, where you can substitute the percentage (%) symbol as a stand in for any word or letter in a search criteria. You can use the '%' wildcard character in all input fields except the date fields. The '%' wildcard character is suffixed automatically at the end of the partial search criteria. Therefore, you may or may not specify the wildcard character at the end of the partial search criteria. However, you have to prefix the wildcard character manually wherever required.

4. Click **Search**.

A list of approval workflow chains that meet the search criteria appears in the **Search Results** section.

Related Topics

For more information on...	See...
Search Approval Workflow Chain zone	Search Approval Workflow Chain on page 1045

Viewing the Approval Workflow Chain Details

Procedure

To view the details of an approval workflow chain:

1. Search for the approval workflow chain in the **Approval Workflow Chain** screen.
2. In the **Search Results** section, click the link in the **Description** column corresponding to the approval workflow chain whose details you want to view.

The **Approval Workflow Chain** screen appears. It contains the following zone:

- [Approval Workflow Chain](#) on page 1049
3. View the details of the approval workflow chain in the **Approval Workflow Chain** zone.

Related Topics

For more information on...	See...
How to search an approval workflow chain	Searching for an Approval Workflow Chain on page 1046

Defining an Approval Workflow Chain

Prerequisites

To define an approval workflow chain, you should have:

- The To Do role and To Do type defined in the application.
- Action algorithms defined in the application, in case you want to use any of them.

Procedure

To define an approval workflow chain:

1. Click the **Admin** link in the **Application** toolbar.
A list appears.
2. From the **Admin** menu, select **A** and then click **Approval Workflow Chain**.
The **Approval Workflow Chain** screen appears.
3. Click the **Add** button in the **Page Title** area of the **Approval Workflow Chain** screen.

The **Approval Workflow Chain** screen appears. It contains the following sections:

- **Main** - Used to specify basic details of the approval workflow chain.
- **Approval Levels** - Used to specify a level in the approval workflow chain.

The **Main** section contains the following fields:

Field Name	Field Description	Mandatory (Yes or No)
Approval Workflow Chain	Used to specify the approval workflow chain	Yes
Description	Used to specify the description for the approval workflow chain	Yes

Field Name	Field Description	Mandatory (Yes or No)
To Do Role To Resolve	Used to specify the To Do Role to indicate the users who will receive a notification when the approval transactions are rejected by an approver at any level in the hierarchy.	Yes

- Enter the required details.
- Define approval levels for the approval workflow chain, if required.
- Click **Save**.

The approval workflow chain is defined.

Related Topics

For more information on...	See...
Approval Workflow Chain screen	Approval Workflow Chain (Used for Searching) on page 1045
Approval Workflow Chain zone	Approval Workflow Chain on page 1049
How to define Approval Levels for an approval workflow chain	Defining Approval Levels for an Approval Workflow Chain on page 1048

Defining Approval Levels for an Approval Workflow Chain

Prerequisites

To define approval levels in the approval workflow chain, you should have:

- The To Do Role and To Do Type defined in the application.
- Action algorithms defined in the application, in case you want to use any of them.

Procedure

To define an approval levels for an approval workflow chain:

- Ensure that the **Approval Levels** section is expanded when you are defining or editing an approval workflow chain.

The **Approval Levels** section contains the following fields

Field Name	Field Description	Mandatory (Yes or No)
Action Algorithm	Used to specify the additional action that you want the system to perform apart from generating a notification when the approver approves or rejects the request. Note: You can search for an action algorithm by clicking the Search (🔍) icon corresponding to the Action Algorithm field.	Yes
Approver To Do Role	Used to specify the To Do role to indicate the users who will either approve or reject the request at this level in the hierarchy. Note: You can search for an approver to do role by clicking the Search (🔍) icon corresponding to the Approver To Do Role field.	Yes

Field Name	Field Description	Mandatory (Yes or No)
Approver To Do Type	Used to specify the type of notification that you want to generate when the approver approves or rejects the request.	Yes
	Note: You can search for an approver to do type by clicking the Search (🔍) icon corresponding to the Approver To Do Type field.	

- Enter the required details in the **Approval Levels** section.
- If you want to define more than one approval level for the approval workflow chain, click the **Add** (+) icon and then repeat step 2. However, if you want to remove a approval level from the approval workflow chain, click the **Delete** (🗑) icon corresponding to the approval level.

Related Topics

For more information on...	See...
How to define an approval workflow chain	Defining an Approval Workflow Chain on page 1047
How to edit an approval workflow chain	Editing an Approval Workflow Chain on page 1050

Approval Workflow Chain (Used for Viewing)

Once you define an approval workflow chain, the **Approval Workflow Chain** screen allows you to:

- View the details of an approval workflow chain
- Edit an approval workflow chain
- Delete an approval workflow chain

This screen contains the following zone:

- [Approval Workflow Chain](#) on page 1049

Approval Workflow Chain

The **Approval Workflow Chain** zone displays the details of the approval workflow chain. It contains the following sections:

- Main** - Displays basic information about the approval workflow chain. It contains the following fields:

Field Name	Field Description
Approval Workflow Chain	Displays the approval workflow chain and levels.
Description	Displays the description of the approval workflow chain and levels.
To Do Role To Resolve	Displays the description of To Do Role role type.

- Approval Levels** - Displays the levels defined in the approval workflow chain.

Field Name	Field Description
Action Algorithm	Indicates the additional action that the system will perform apart from generating a notification when the approver approves or rejects the request.

Field Name	Field Description
Level	Indicates the level in the hierarchy.
Approver To Do Role	Indicates that the users with the specified To Do role will either approve or reject the request at this level in the hierarchy.
Approval To Do Type	Indicates the type of notification that will be generated when the approver approves or rejects the request.

- **Record Actions** - This section contains the following buttons:

Button Name	Button Description
Edit	Used to edit and delete the approval workflow chain and approval levels.
Delete	Used to delete the approval workflow chain.

- **Record Information** - This section contains the following field:

Field Name	Field Description
Business Object	Indicates the business object using which the approval workflow chain is created. In addition, a context menu appears corresponding to this field which helps in navigating to other screens in the application.
	Note: It has a link. On clicking the link, the Business Object screen appears where you can view the details of the respective business object.

Editing an Approval Workflow Chain

Procedure

To edit an approval workflow chain:

1. Search for an approval workflow chain in the **Search Approval Workflow Chain** screen.
2. In the **Search Results** section, click the link in the **Description** column corresponding to the approval workflow chain whose details you want to edit.

The **Approval Workflow Chain** screen appears.

3. Click the **Edit** button in the **Approval Workflow Chain**.

The **Approval Workflow Chain** screen appears.

- **Main** - Used to specify the basic details of the approval workflow chain. It contains the following fields:

Field Name	Field Description	Mandatory (Yes or No)
Approval Workflow Chain	Displays the approval workflow chain.	Yes
Description	Displays the description for the approval workflow chain.	Yes
To Do Role To Resolve	Displays the To Do role to indicate the users who will be sent a notification when the approval workflow request is rejected by an approver at any level in the hierarchy.	Yes

- **Approval Levels** - Used to specify a level in the approval workflow chain. It contains the following fields:

Field Name	Field Description	Mandatory (Yes or No)
Action Algorithm	Displays the additional action that you want the system to perform apart from generating a notification when the approver approves or rejects the request.	Yes
Approver To Do Role	Displays the To Do role to indicate the users who will either approve or reject the request at this level in the hierarchy.	Yes
Approval To Do Type	Displays the type of notification that you want to generate when the approver approves or rejects the request.	Yes

4. Modify the required details in the **Main** section.
5. Edit, or remove approval levels from the approval workflow chain, if required.
6. Click **Save**.

The changes made to the approval workflow chain screen are saved.

Related Topics

For more information on...	See...
Approval Workflow Chain screen	Approval Workflow Chain (Used for Viewing) on page 1049
Approval Workflow Chain zone	Approval Workflow Chain on page 1049
How to define approval levels for an approval workflow chain	Defining an Approval Workflow Chain on page 1047

Deleting an Approval Workflow Chain

Procedure

To delete an approval workflow chain:

1. Search for the approval workflow chain in the **Search Approval Workflow Chain** screen.
2. In the **Search Results** section, click the link in the **Description** column corresponding to the approval workflow chain that you want to delete.

The **Approval Workflow Chain** screen appears.

3. Click the **Delete** button in the **Approval Workflow Chain** zone.

A message appears confirming whether you want to delete the approval workflow chain.

4. Click **OK**.

The approval workflow chain is deleted.

Related Topics

For more information on...	See...
How to search for an approval workflow chain	Searching for an Approval Workflow Chain on page 1046
Approval Workflow Chain screen	Approval Workflow Chain (Used for Viewing) on page 1049
Approval Workflow Chain zone	Approval Workflow Chain on page 1049

Approval Workflow Criterion Type (Used for Searching)

The **Approval Workflow Criterion Type** screen allows you to search for an approval workflow criterion type using various search criteria. Through this screen, you can navigate to the following screen:

- [Approval Workflow Criterion Type \(Used for Viewing\)](#) on page 1055

This screen consists of the following zone:

- [Search Approval Workflow Criterion Type](#) on page 1052

Search Approval Workflow Criterion Type

The **Search Approval Workflow Criterion Type** zone allows you to search for an approval workflow criterion type using various search criteria. It contains the following two sections:

- **Search Criteria** - The **Search Criteria** section contains the following fields:

Field Name	Field Description	Mandatory (Yes or No)
Approval Workflow Criterion Type	Used to search a particular approval workflow criterion type.	Yes
Description	Used to specify the description for the approval workflow criteria type.	No

Note: You must specify at least one search criterion while searching for an approval workflow criterion type.

- **Search Results** - On clicking the **Search** button, the search results are filtered based on the specified search criteria. The **Search Results** section contains the following columns:

Column Name	Column Description
Approval Workflow Criterion Type	Displays the approval workflow criterion type.
Description	Displays the description of the approval workflow criterion type.

Related Topics

For more information on...	See...
How to search for an approval workflow criterion type	Searching for an Approval Workflow Criterion Type on page 1052
How to view the details of an approval workflow criterion type	Viewing the Approval Workflow Criterion Type Details on page 1053

Searching for an Approval Workflow Criterion Type

Procedure

To search the approval workflow criterion type:

1. Click the **Admin** link in the **Application** toolbar.
A list appears.
2. From the **Admin** menu, select **A** and then click **Approval Workflow Criterion Type**.
The **Approval Workflow Criterion Type** screen appears.
3. Enter the search criteria in the **Search Approval Workflow Criterion Type** zone.

Note: ORMB search engine supports wildcard search, where you can substitute the percentage (%) symbol as a stand in for any word or letter in a search criteria. You can use the ‘%’ wildcard character in all input fields except the date and ID fields. The ‘%’ wildcard character is suffixed automatically at the end of the partial search criteria. Therefore, you may or may not specify the wildcard character at the end of the partial search criteria. However, you have to prefix the wildcard character manually wherever required.

4. Click **Search**

A list of approval workflow criterion types that meet the search criteria appears in the **Search Results** section.

Related Topics

For more information on...	See...
Approval Workflow Criterion Type screen	Approval Workflow Criterion Type (Used for Searching) on page 1052
Approval Workflow Criterion Type zone	Search Approval Workflow Criterion Type on page 1052

Viewing the Approval Workflow Criterion Type Details

Procedure

To view the details of an approval workflow criterion type:

1. If required, filter the approval workflow criterion type details in the **Search Approval Workflow Criterion Type** screen.
2. In the **Search Results** section, click the link in the **Description** column corresponding to the approval workflow criterion type whose details you want to view.

The **Approval Workflow Criterion** screen appears. It contains the following zone:

- [Approval Workflow Criterion Type](#) on page 1055

3. View the details of the approval workflow criterion type in the **Approval Workflow Criterion Type** zone.

Related Topics

For more information on...	See...
How to search the approval workflow criterion type	Searching for an Approval Workflow Criterion Type on page 1052
Approval Workflow Criterion Type screen	Approval Workflow Criterion Type (Used for Viewing) on page 1055
Approval Workflow Criterion Type zone	Approval Workflow Criterion Type on page 1055

Defining an Approval Workflow Criterion Type

Prerequisites

To define an approval workflow criterion type, you should have:

- Algorithm, Business object, and Field object defined in the application.

Procedure

To define an approval workflow criterion type:

1. Click the **Admin** link in the **Application** toolbar.

A list appears.

- From the **Admin** menu, select **A** and then click **Approval Workflow Criterion Type**.

The **Approval Workflow Criterion Type** screen appears.

- Click the **Add** button in the **Page Title** area of the **Approval Workflow Criterion Type** screen.

The **Approval Workflow Criterion Type** screen appears. It contains the following section:

- Main** - Used to specify basic details about the approval workflow criterion type.

The **Main** section contains the following fields:

Field Name	Field Description	Mandatory (Yes or No)
Approval Workflow Criterion Type	Used to specify the approval workflow criterion type.	Yes
Description	Used to specify the description for the approval workflow criterion type.	Yes
Derived From	Used to indicate the option which triggers the approval workflow. The valid values are: <ul style="list-style-type: none"> Algorithm Business Object 	Yes
Algorithm	Used to indicate the algorithm for which you want to define the approval workflow criterion type. Note: The Search (🔍) icon appears corresponding to this field. On clicking the Search icon, the Algorithm Search window appears. This field appears when you select the Algorithm option from the Derived From list.	Yes
Business Object	Used to indicate the business object for which you want to define the approval workflow criterion type. Note: The Search (🔍) icon appears corresponding to this field. On clicking the Search icon, the Business Object Search window appears. This field appears when you select the Business Object option from the Derived From list.	Yes

Field Name	Field Description	Mandatory (Yes or No)
Field	Used to indicate the field that you want to use to define the criteria for associating approval workflow requests with the approval workflow chains.	Yes
	<p>Note:</p> <p>The Search (🔍) icon corresponding to this field. On clicking the Search icon, the Field Search window appears.</p> <p>This field appears when you select the Business Object option from the Derived From list.</p>	

4. Enter the required details.
5. Click **Save**.

The approval workflow criterion type is created.

Related Topics

For more information on...	See...
Approval Workflow Criterion Type screen	Approval Workflow Criterion Type (Used for Viewing) on page 1055
Search Approval Workflow Criterion Type zone	Search Approval Workflow Criterion Type on page 1052

Approval Workflow Criterion Type (Used for Viewing)

Once you define an approval workflow criterion type, the **Approval Workflow Criterion Type** screen allows you to:

- Edit the details of an approval workflow criterion type
- Delete an approval workflow criterion type

This screen contains the following zone:

- [Approval Workflow Criterion Type](#) on page 1055

Approval Workflow Criterion Type

The **Approval Workflow Criterion Type** zone displays the details of the approval workflow criterion types. It contains the following sections:

- **Main** - Displays basic information about the approval workflow criterion type. It contains the following fields:

Field Name	Field Description
Approval Workflow Criterion Type	Displays the approval workflow criterion type.
Description	Displays the description of the approval workflow criterion type.
Derived From	Indicates the criteria type that triggers the approval workflow. The valid values are: <ul style="list-style-type: none"> • Algorithm • Business Object

Field Name	Field Description
Business Object	Indicates the business object using which the approval workflow criterion type is created. In addition, a context menu appears corresponding to this field which helps in navigating to other screens in the application.
	Note: It has a link. On clicking the link, the Business Object screen appears where you can view the details of the respective business object.
Field	Indicates the field using which the criteria for associating approval workflow requests with the approval workflow chains will be defined.
	Note: It has a link. On clicking the link, the Fields screen appears where you can view the details of the respective field.

- **Record Actions** - This section contains the following buttons:

Button Name	Button Description
Edit	Used to edit the approval workflow criterion type.
Delete	Used to delete the approval workflow criterion type.

- **Record Information** - This section contains the following field:

Field Name	Field Description
Business Object	Indicates the business object using which the approval workflow chain and levels is created. In addition, a context menu appears corresponding to this field which helps in navigating to other screens in the application.
	Note: It has a link. On clicking the link, the Business Object screen appears where you can view the details of the respective business object.

Editing an Approval Workflow Criterion Type

Procedure

To edit an approval workflow criterion type:

1. Search for the approval workflow criterion type in the **Approval Workflow Criterion Type** screen.
2. In the **Search Results** section, click the link in the **Description** column corresponding to the approval workflow criterion type whose details you want to edit.

The **Approval Workflow Criterion Type** screen appears.

3. Click the **Edit** button in the **Approval Workflow Criterion Type** zone.

The **Approval Workflow Criterion Type** screen appears. It contains the following section:

- **Main** - This section contains the following fields:

Field Name	Field Description	Mandatory (Yes or No)
Approval Workflow Criterion Type	Displays the approval workflow criterion type.	Yes
Description	Displays the description for the approval workflow criterion type.	Yes

Field Name	Field Description	Mandatory (Yes or No)
Derived From	Displays an option which triggers the approval workflow.	Yes
Algorithm	Displays the algorithm for which you want to define the approval workflow criterion type.	Yes
	<p>Note:</p> <p>The Search (🔍) icon corresponding to this field. On clicking the Search icon, the Algorithm Search window appears</p> <p>This field appears when you select the Algorithm option form the Derived From list.</p>	
Business Object	Displays the business object which is used to define the approval workflow criterion type.	Yes
	<p>Note:</p> <p>The Search (🔍) icon corresponding to this field. On clicking the Search icon, the Business Object Search window appears.</p> <p>This field appears when you select the Business Object option form the Derived From list.</p>	
Field	Displays the field which is used to define the criteria for associating approval workflow requests with the approval workflow chains.	Yes
	<p>Note:</p> <p>The Search (🔍) icon corresponding to the respective field. On clicking the Search icon, the Field Search window appears.</p> <p>This field appears when you select the Business Object option form the Derived From list.</p>	

4. Modify the required details in the **Approval Workflow Criterion Type** screen.

5. Click **Save**.

The changes made to the approval workflow criterion type screen are saved.

Related Topics

For more information on...	See...
How to search for an approval workflow criterion type	Searching for an Approval Workflow Criterion Type on page 1052
Approval Workflow Criterion Type screen	Approval Workflow Criterion Type (Used for Viewing) on page 1055
Approval Workflow Criterion Type zone	Approval Workflow Criterion Type on page 1055

Deleting an Approval Workflow Criterion Type

Procedure

To delete an approval workflow criterion type:

1. Search for the approval workflow criterion type in the **Approval Workflow Criterion Type** screen.
2. In the **Search Results** section, click the link in the **Description** column corresponding to the approval workflow criterion type whose details you want to delete.

The **Approval Workflow Criterion Type** screen appears.

3. Click the **Delete** button in the **Approval Workflow Criterion Type** zone.

A message appears confirming whether you want to delete the approval workflow criterion type.

4. Click **OK**.

The approval workflow criterion type is deleted.

Related Topics

For more information on...	See...
How to search for an approval workflow criterion type	Searching for an Approval Workflow Criterion Type on page 1052
Approval Workflow Criterion Type screen	Approval Workflow Criterion Type (Used for Viewing) on page 1055
Approval Workflow Criterion Type zone	Approval Workflow Criterion Type on page 1055

Approval Workflow Group Chain Linkage (Used for Searching)

The **Approval Workflow Group Chain Linkage** screen allows you to search for an approval workflow group chain linkage using various search criteria. Through this screen, you can navigate to the following screen:

- [Approval Workflow Group Chain Linkage \(Used for Viewing\)](#) on page 1064

This screen consists of the following zone:

- [Search Approval Workflow Group Chain Linkage](#) on page 1058

For more information on...	See...
How to search for an approval workflow group chain linkage	Searching for an Approval Workflow Group Chain Linkage on page 1059
How to view the details of an approval workflow group chain linkage	Viewing the Approval Workflow Group Chain Linkage Details on page 1060

Search Approval Workflow Group Chain Linkage

The **Search Approval Workflow Group Chain Linkage** zone allows you to search for an approval workflow group chain linkage using various search criteria. It contains the following two sections:

- **Search Criteria** - The **Search Criteria** section contains the following fields:

Field Name	Field Description	Mandatory (Yes or No)
Group Chain Linkage ID	Used to search a particular approval workflow group chain linkage.	Yes

Field Name	Field Description	Mandatory (Yes or No)
Approval Workflow Group	Used to search a group chain linkage for which an approval workflow group is defined.	Yes
Approval Workflow Chain	Used to search a group chain linkage for which an approval workflow chain is defined.	Yes

Note: You must specify at least one search criterion while searching for an approval workflow group chain linkage.

- **Search Results** - On clicking the **Search** button, the search results appear based on the specified search criteria. The **Search Results** section contains the following columns:

Column Name	Column Description
Group Chain Linkage ID	Displays the ID which is generated automatically when the link is created.
Approval Workflow Group	Indicates the approval workflow group for which the link is created. Note: It has a link. On clicking the link, the Approval Workflow Group Chain Linkage screen appears with the details of the respective business object.
Approval Workflow Chain	Indicates the approval workflow chain for which the link is created.
Field Approval Rule	Indicates whether you want to configure approval rule for one or more fields of the business objects which are included in the approval workflow group. The valid values are: <ul style="list-style-type: none"> • Yes • No

Related Topics

For more information on...	See...
How to search for an approval work group chain linkage	Searching for an Approval Workflow Group Chain Linkage on page 1059
How to view the details of an approval workflow group chain linkage	Viewing the Approval Workflow Group Chain Linkage Details on page 1060

Searching for an Approval Workflow Group Chain Linkage

Procedure

To search an approval workflow group chain linkage:

1. Click the **Admin** link in the **Application** toolbar.
A list appears.
2. From the **Admin** menu, select **A** and then click **Approval Workflow Group Chain Linkage**.
The **Approval Workflow Group Chain Linkage** screen appears.
3. Enter the search criteria in the **Search Group Chain Linkage** zone.

Note: ORMB search engine supports wildcard search, where you can substitute the percentage (%) symbol as a stand in for any word or letter in a search criteria. You can use the ‘%’ wildcard character in all input fields except the date and ID fields. The ‘%’ wildcard character is suffixed automatically at the end of the partial search criteria. Therefore, you may or may not specify the wildcard character at the end of the partial search criteria. However, you have to prefix the wildcard character manually wherever required.

4. Click **Search**.

A list of group chain linkages that meet the search criteria appears in the **Search Results** section.

Related Topics

For more information on...	See...
Approval Workflow Group Chain Linkage screen	Approval Workflow Group Chain Linkage (Used for Searching) on page 1058
Search Approval Workflow Group Chain Linkage zone	Search Approval Workflow Group Chain Linkage on page 1058

Viewing the Approval Workflow Group Chain Linkage Details

Procedure

To view the details of an approval workflow chain linkage:

1. Search for the approval workflow group chain linkage in the **Approval Workflow Group Chain Linkage** screen.
2. In the **Search Results** section, click the link in the **Approval Workflow Group** column corresponding to the approval workflow chain whose details you want to view.

The **Approval Workflow Group Chain Linkage** screen appears. It contains the following zone:

- [Approval Workflow Group Chain Linkage](#) on page 1065
3. View the details of the approval workflow group chain linkage in the **Approval Workflow Group Chain Linkage** zone.

Related Topics

For more information on...	See...
How to search for an approval workflow group chain linkage	Searching for an Approval Workflow Group Chain Linkage on page 1059
Approval Workflow Group Chain Linkage screen	Approval Workflow Group Chain Linkage (Used for Viewing) on page 1064

Defining an Approval Workflow Group Chain Linkage

Prerequisites

To define an approval workflow group chain linkage, you should have:

- Business Object, Field, Criterion Type, Approval Workflow Group and Approval Workflow Chain defined in the application.

Procedure

To define an approval workflow group chain linkage:

1. Click the **Admin** link in the **Application** toolbar.

A list appears.

- From the **Admin** menu, select **A** and then click **Approval Workflow Group Chain Linkage**.

The **Approval Workflow Group Chain Linkage** screen appears.

- Click the **Add** button in the **Page Title** area of the **Approval Workflow Group Chain Linkage** screen.

The **Approval Workflow Group Chain Linkage** screen appears. It contains the following sections:

- **Main** - Used to specify basic details about the approval workflow group chain linkage.
- **Group Chain Linkage Criteria** - Used to define group chain linkage criteria for the approval workflow type.

The **Main** section contains the following fields:

Field Name	Field Description	Mandatory (Yes or No)
Approval Workflow Group	Used to indicate the approval workflow group.	Yes
	Note: You can search for an approval workflow group type by clicking the Search (🔍) icon corresponding to the field.	
Approval Workflow Chain	Used to indicate the approval workflow chain.	Yes
	Note: You can search for an approval workflow chain by clicking the Search (🔍) icon corresponding to the field.	
Field Approval Rule	Used to indicate whether you want to configure approval rule for one or more fields of the business objects which are included in the approval workflow group. The valid values are: <ul style="list-style-type: none"> • Yes • No 	Yes

- Enter the required details.
- Define group chain linkage criteria for the approval workflow, if required.
- Define field approval rule criteria for the approval workflow, if required.
- Click **Save**.

The approval workflow group chain linkage is created.

Related Topics

For more information on...	See...
Approval Workflow Chain Linkage screen	Approval Workflow Group Chain Linkage (Used for Searching) on page 1058
Search Approval Workflow Chain Linkage zone	Search Approval Workflow Group Chain Linkage on page 1058
How to define group chain linkage criteria for an approval workflow	Defining an Approval Workflow Group Chain Linkage on page 1060

Defining Group Chain Linkage Criteria for an Approval Workflow

Prerequisites

To define group chain linkage criteria for an approval workflow, you should have:

- Approval Workflow Criterion Type defined in the application.

Procedure

To define group chain linkage criteria for an approval workflow:

1. Ensure that the **Group Chain Linkage Criteria** section is expanded when you are defining or editing an approval workflow.

The **Group Chain Linkage Criteria** section contains the following fields:

Field Name	Field Description	Mandatory (Yes or No)
Group Chain Linkage ID	Displays the Group Chain Linkage ID.	Yes
	Note: The data appears in this field when you are editing the details of an approval workflow criterion type.	
Criterion Type	Used to indicate the criteria type needed for defining the criterion.	Yes
	Note: The Search (🔍) icon appears corresponding to this field. On clicking the Search icon, the Approval Workflow Chain Search window appears.	
Operator	Used to indicate the relational operator used to define the relation between the criterion type and criterion value.	Yes
Criterion Value	Used to specify the criterion value.	Yes

2. Enter the required details.
3. If you want to define more than one group chain linkage criteria for the approval workflow, click the **Add (+)** icon, and then repeat step 2.

Note: However, if you want to remove a group chain linkage criteria from the approval workflow, click the **Delete (🗑)** icon corresponding to the group chain linkage criteria.

Related Topics

For more information on...	See...
How to edit an approval workflow group chain linkage	Editing an Approval Workflow Group Chain Linkage on page 1067

Defining a Field Approval Rule

Prerequisites

To define a field approval rule for an approval workflow group chain linkage, you should have:

- Business Object, Field, and Approval Workflow Chain to be defined in the application.

Procedure

To define a field approval rule for an approval workflow group chain linkage:

1. Ensure that the

Field Approval Rule Criteria section is expanded when you select the Yes option from the Field Approval Rule field of the M

The **Field Approval Rule Criteria** section contains the following fields in a grid:

Field Name	Field Description	Mandatory (Yes or No)
Sequence.	Used to indicate the order in which the rule criteria should be executed while adding or updating the field value.	Yes
Applicable For	Used to indicate whether the rule criteria should be considered while adding and/or updating the field value. The valid values are: <ul style="list-style-type: none"> • Add • Update • Add and Update 	Yes
Business Object	Used to indicate the business object in which the field is included.	Yes
	Note: The Search (🔍) icon appears corresponding to the Business Object field. On clicking the search icon, the Search Group Based Business Object search window appears.	
Field	Used to indicate the field for which you want to define the approval rule criteria.	Yes
	Note: The Search (🔍) icon appears corresponding to the Field search field. On clicking the search icon, the Field Search search window appears.	
Approval Workflow Chain	Used to indicate the approval workflow chain that you want to use for the field value approval.	Yes
	Note: The Search (🔍) icon appears corresponding to the Approval Workflow Chain field. On clicking the search icon, the Approval Workflow Chain Search search window appears.	
Value Range	Used to indicate whether you want to define value based threshold limit for each approval level.	No
	Note: This field is enabled when the data type of the field is Numeric .	

Field Name	Field Description	Mandatory (Yes or No)
Hierarchical	Used to indicate whether multi-level or single-level approval is required while adding or updating the field value beyond the threshold limit.	No

If the **Value Range** check box is selected, a grid appears with the following set of fields:

Field	Field Description
Threshold Value	Used to specify the threshold value using which you want to control the approval hierarchy.
Approval Level	Used to indicate the approval level at which approval is required when the field value is within the threshold value. Note: The Search (🔍) icon appears corresponding to the Approval Level field. On clicking the search icon, the Approval Level Search search window appears. Note: The search results will include all those levels which are defined in the approval workflow chain.
Approval Level Information	Displays additional information about the approval level.

- Enter the required details in the **Field Approval Rule Criteria** section.
- If you want to define more than one field approval rule criteria for the approval workflow chain linkage, click the **Add** (+) icon and then repeat step 2. However, if you want to remove a field approval rule criteria from the approval workflow chain linkage, click the **Delete** (🗑) icon corresponding to the sequence field.
- Click **Save**.

The approval workflow field rule is defined.

Related Topics

For more information on...	See...
How to edit an approval workflow group chain linkage	Editing an Approval Workflow Group Chain Linkage on page 1067

Approval Workflow Group Chain Linkage (Used for Viewing)

Once you define an approval workflow group chain linkage, the **Approval Workflow Group Chain Linkage** screen allows you to:

- Edit an approval workflow group chain linkage
- Delete an approval workflow group chain linkage

This screen contains the following zone:

- [Approval Workflow Group Chain Linkage](#) on page 1065

For more information on...	See...
How to view the details of an approval workflow group chain linkage	Viewing the Approval Workflow Group Chain Linkage Details on page 1060

Approval Workflow Group Chain Linkage

The **Approval Workflow Group Chain Linkage** zone displays the details of the approval workflow group chain linkage. It contains the following sections:

- **Main** - Displays basic information about the approval workflow group chain linkage. It contains the following fields:

Field Name	Field Description
Approval Workflow Group	Displays the approval workflow group for which a link is created.
	Note: It has a link. On clicking the link, the Approval Workflow Group screen appears with the details of the respective approval workflow group.
Approval Workflow Chain	Displays the approval workflow chain for which a link is created.
	Note: It has a link. On clicking the link, the Approval Workflow Chain screen appears with the details of the respective approval workflow group.
Field Approval Rule	Indicates whether you want to configure approval rule for one or more fields of the business objects which are included in the approval workflow group. The valid values are: <ul style="list-style-type: none"> • Yes • No

- **Record Actions** - This section contains the following buttons:

Button Name	Button Description
Edit	Used to edit the details of the approval workflow group chain linkage. Also used to define, edit, delete Group Chain Linkage Criteria and Field Approval Rule Criteria.
Delete	Used to delete the approval workflow group chain linkage.

- **Record Information** - This section contains the following field:

Field Name	Field Description
Business Object	Indicates the business object using which the approval workflow chain linkage is created. In addition, a context menu appears corresponding to this field which helps in navigating to other screens in the application.
	Note: It has a link. On clicking the link, the Business Object screen appears where you can view the details of the respective business object.

- **Group Chain Linkage Criteria** - Lists the group chain linkage criteria..This section contains the following columns:

Column Name	Column Description
Group Chain Linkage ID	Displays the ID which is generated automatically when the link is created.

Column Name	Column Description
Criterion Type	Displays the criterion type needed for defining the criterion.
	Note: It has a link. On clicking the link, the Approval Workflow Criterion Type screen appears where you can view the details of the respective criterion type.
Operator	Indicates the relational operator used to define the relation between the criterion type and criterion value. The valid values are: <ul style="list-style-type: none"> EQUALS IN
Criterion Value	Displays the criterion value.

- **Field Approval Rule Criteria** - Lists the field approval rule criteria for approval workflow group chain linkage. It contains the following columns:

Column Name	Column Description
Sequence	Indicates the order in which the rule criteria should be executed while adding or updating the field value.
Applicable For	Displays the rule criteria which should be considered while adding and/or updating the field value.
Business Object	Displays the business object in which the field is included.
Field	Displays the field for which you want to define the approval rule criteria.
	Note: The Context Menu () icon appears corresponding to the Field search field. On clicking the context menu icon, the Go to Field menu appears. On clicking the Go to Field menu item, the Field screen appears with the details of the respective field.
	Note: It has a link. On clicking the link, the Field screen appears with the details of the respective field.
Approval Workflow Chain	Indicates the approval workflow chain that you want to use for the field value approval.
	Note: It has a link. On clicking the link, the Approval Workflow Chain screen appears with the details of the respective approval workflow chain.
Value Range	Indicates whether you want to define value based threshold limit for each approval level.
	Note: This field is enabled when the data type of the field is Numeric .

Column Name	Column Description
Hierarchical Approval	Indicates whether multi-level or single-level approval is required while adding or updating the field value beyond the threshold limit.
	Note: This field is enabled when the Value Range check box is selected.

If the **Value Range** check box is selected, a grid appears with the following set of fields:

Field	Field Description
Threshold Value	Displays the threshold value using which you want to control the approval hierarchy.
Approval Level	Displays the approval level at which approval is required when the field value is within the threshold value.
	Note: The Search (🔍) icon appears corresponding to the Approval Level field. On clicking the search icon, the Approval Level Search search window appears.
	Note: The search results will include all those levels which are defined in the approval workflow chain.
Approval Level Information	Displays additional information about the approval level.

Editing an Approval Workflow Group Chain Linkage

Prerequisites

To edit an approval workflow group chain linkage, you should have:

- Business Object, Field, Criterion Type, Approval Workflow Group, and Approval Workflow Chain defined in the application.

Procedure

To edit an approval workflow group chain linkage:

1. Search for the Approval Workflow Group Chain Linkage in the **Approval Workflow Group Chain Linkage** screen.
2. In the **Search Results** section, click the link in the **Approval Workflow Group** column corresponding to the approval workflow chain whose details you want to edit.
The **Approval Workflow Group Chain Linkage** screen appears.
3. Click the **Edit** button in the **Approval Workflow Group Chain Linkage** zone.
The **Approval Workflow Group Chain Linkage** screen appears.
4. Define or edit approval workflow group chain linkage, if required.
5. Define, edit or remove approval workflow criterion from the approval workflow group chain linkage, if required.
6. Define, edit or remove field approval rule criteria from the approval workflow group chain linkage, if required.
7. Click **Save**.

The changes made to the approval workflow group chain linkage screen are saved.

Related Topics

For more information on...	See...
How to search approval workflow group chain linkage	Searching for an Approval Workflow Group Chain Linkage on page 1059
Approval Workflow Group Chain Linkage screen	Approval Workflow Group Chain Linkage (Used for Viewing) on page 1064
Approval Workflow Group Chain Linkage zone	Approval Workflow Group Chain Linkage on page 1065

Deleting an Approval Workflow Group Chain Linkage

Procedure

To delete an approval workflow group chain linkage:

1. Search for an approval workflow group chain linkage in the **Search Approval Workflow Group Chain Linkage** zone.
2. In the **Search Results** section, click the link in the **Approval Workflow Group** column corresponding to the approval workflow chain that you want to delete.

The **Approval Workflow Group Chain Linkage** screen appears.

3. Click the **Delete** button in the **Approval Workflow Group Chain Linkage** zone.

A message appears confirming whether you want to delete the approval workflow group chain linkage.

4. Click **OK**.

The approval workflow group chain linkage is deleted.

Related Topics

For more information on...	See...
How to search for an approval workflow group chain linkage	Searching for an Approval Workflow Group Chain Linkage on page 1059

Approval Workflow Setting (Used for Searching)

The **Approval Workflow Setting** screen allows you to search for approval workflow setting using various search criteria. It consists the following zone:

- [Search Approval Workflow Group](#) on page 1068

Through this screen, you can navigate to the following screen:

- [Approval Workflow Setting \(Used for Viewing\)](#) on page 1072

For more information on...	See...
How to search for an approval workflow setting	Searching for an Approval Workflow Group on page 1069
How to view the details of approval workflow settings	Viewing the Approval Workflow Setting Details on page 1070

Search Approval Workflow Group

The **Search Approval Workflow Group** zone allows you to search for an approval workflow group using various search criteria. It contains the following two sections:

- **Search Criteria** - The **Search Criteria** section contains the following fields::

Field Name	Field Description	Mandatory (Yes or No)
Approval Workflow Group	Used to search a particular approval workflow group.	Yes
Description	Used to search approval workflow group with a particular description.	Yes

Note: You must specify at least one search criterion while searching for an approval workflow group.

- **Search Results** - On clicking the **Search** button, the search results appear based on the specified search criteria. The **Search Results** section contains the following columns:

Column Name	Column Description
Approval Workflow Group	Displays the approval workflow group.
Description	Displays the description of the approval workflow group.
	Note: It has a link. On clicking the link, the Approval Workflow Group screen appears where you can view the details of the respective approval workflow group.

Related Topics

For more information on...	See...
How to search for an approval workflow group	Searching for an Approval Workflow Group on page 1029
How to view the details of approval workflow setting	Viewing the Approval Workflow Setting Details on page 1070

Searching for an Approval Workflow Group

Prerequisites

To search for an approval workflow group, you should have:

- Approval Workflow Group defined in the application.
- Active flag should be set to **Yes**

Procedure

To search for an approval workflow group:

1. Click the **Admin** link in the **Application** toolbar.
A list appears.
2. From the **Admin** menu, Select **A** and then click **Approval Workflow Setting**.
The **Approval Workflow Setting** screen appears.
3. Enter the search criteria in the **Search Approval Workflow Group** zone.

Note: ORMB search engine supports wildcard search, where you can substitute the percentage (%) symbol as a stand in for any word or letter in a search criteria. You can use the '%' wildcard character in all input fields except the date and ID fields. The '%' wildcard character is suffixed automatically at the end of the partial search criteria. Therefore, you may or may not specify the wildcard character at the end of the partial search criteria. However, you have to prefix the wildcard character manually wherever required.

4. Click **Search**.

A list of approval workflow groups that meet the search criteria appears in the **Search Results** section.

Related Topics

For more information on...	See...
Approval Workflow Setting screen	Approval Workflow Setting (Used for Viewing) on page 1072
Search Approval Workflow Group zone	Search Approval Workflow Group on page 1028

Viewing the Approval Workflow Setting Details

Procedure

To view the details of approval workflow setting:

1. Search for an approval workflow group in the **Approval Workflow Setting** screen.
2. In the **Search Results** section, click the link in the **Description** column corresponding to the approval workflow group whose details you want to view.

The **Approval Workflow Settings** screen appears.

3. View the details of the approval workflow group in the **Approval Workflow Group Settings** zone.

Related Topics

For more information on...	See...
Approval Workflow Group Settings screen	Approval Workflow Setting (Used for Viewing) on page 1072
Approval Workflow Group Settings zone	Approval Workflow Group Settings on page 1072
How to search for an approval workflow setting	Searching for an Approval Workflow Group on page 1069

Defining Approval Workflow Group Settings

Prerequisites

To define an approval workflow group setting, you should have:

- Approval Workflow Group defined in the application.
- Active flag set to **Yes**

Procedure

To define an approval workflow group setting:

1. Click the **Admin** link in the **Application** toolbar.
A list appears.
2. From the **Admin** menu, select **A** and then click **Approval Workflow Setting**.
The **Approval Workflow Settings** screen appears.
3. Click the **Add** button in the **Page Title** area of the **Approval Workflow Settings** screen.

The **Approval Workflow Settings** screen appears. It contains the following section:

- **Main** - Used to specify the details for the approval workflow settings.

The **Main** section contains the following fields:

Field Name	Field Description	Mandatory (Yes or No)
Approval Workflow Group	Used to specify the approval workflow group.	Yes
Approval Chain Selection Algorithm	Used to specify the algorithm that will be triggered before creating the approval workflow request.	Yes
	Note: This algorithm identifies the approval workflow chain that must be used for the approval workflow group.	
	Note: You can search for an approval chain selection algorithm by clicking the Search (🔍) icon corresponding to the Approval Chain Selection Algorithm field.	
Prevalidation	Used to indicate whether validation must be done before the approval workflow request is created. The valid values are: <ul style="list-style-type: none"> • Yes • No 	Yes
	Note: You can search for a prevalidation by clicking the Search (🔍) icon corresponding to the Prevalidation field.	
Approval Reason Required	Used to indicate whether you want the approver to add reason and comments while approving the approval transaction. The valid values are: <ul style="list-style-type: none"> • Yes • No 	Yes
Active	Used to indicate whether the approval workflow is required for the business objects in the approval workflow group. The valid values are: <ul style="list-style-type: none"> • Yes - Used when you want to activate the approval workflow for the business objects in the approval workflow group. • No - Used when you do not want to activate the approval workflow for the business objects in the approval workflow group. • Conditional - Used when you want to activate the approval workflow for business objects that satisfy particular criteria (for example, when the person or account belongs to a particular division). Note that, at present, this functionality works only for an approval workflow group which consists of a single business object. 	Yes

Field Name	Field Description	Mandatory (Yes or No)
Conditional Algorithm	Used to specify the algorithm that will be used to determine the business objects for which the approval workflow must be activated.	Yes
	Note: This field appears when the Conditional option is selected from the Active list.	

4. Enter the required details.

5. Click **Save**.

The approval workflow group setting is defined.

Related Topics

For more information on...	See...
Approval Workflow Group screen	Approval Workflow Group (Used for Searching) on page 1028
Search Approval Workflow Group zone	Search Approval Workflow Group on page 1028

Approval Workflow Setting (Used for Viewing)

Once the approval workflow group setting is defined, the **Approval Workflow Settings** screen allows you to:

- View the details of an approval workflow setting
- Edit the approval workflow group settings
- Delete an approval workflow group settings
- Regenerate approval workflow setting UI maps

This screen consists of the following zone:

- [Approval Workflow Group Settings](#) on page 1072

For more information on...	See...
How to edit the approval workflow group settings	Editing Approval Workflow Group Settings on page 1074
How to delete an approval workflow group settings	Deleting Approval Workflow Group Settings on page 1074
How to regenerate UI Maps	Regenerating Input and Display UI Maps on page 1075

Approval Workflow Group Settings

The **Approval Workflow Group Settings** zone displays the details of the approval workflow group settings. It contains the following sections:

- **Main** - Displays the basic information about the approval workflow group settings. It contains the following fields:

Field Name	Field Description
Approval Workflow Group	Displays the approval workflow group.

Field Name	Field Description
Approval Chain Selection Algorithm	Displays the algorithm that will be triggered after creating the approval workflow request.
	Note: This algorithm identifies the approval workflow chain that must be used for the approval workflow group.
	Note: It has a link. On clicking the link, the Algorithm screen appears where you can view the details of the respective approval chain selection algorithm.
Prevalidation	Indicates whether validation must be done before the approval workflow request is created. The valid values are: <ul style="list-style-type: none"> • Yes • No
Approval Reason Required	Indicates whether you want the approver to add reason and comments while approving the approval transaction. The valid values are: <ul style="list-style-type: none"> • Yes • No
Active	Indicates whether the approval workflow is required for the business objects in the approval workflow group. The valid values are: <ul style="list-style-type: none"> • Yes - Used when you want to activate the approval workflow for the business objects in the approval workflow group. • No - Used when you do not want to activate the approval workflow for the business objects in the approval workflow group. • Conditional - Used when you want to activate the approval workflow for business objects that satisfy particular criteria (for example, when the person or account belongs to a particular division). Note that, at present, this functionality works only for an approval workflow group which consists of a single business object.
Conditional Algorithm	Displays the algorithm that will be used to determine the business objects for which the approval workflow must be activated.
	Note: This field appears when the Conditional option is selected from the Active list.
	Note: It has a link. On clicking the link, the Algorithm screen appears where you can view the details of the respective conditional algorithm.

- **Record Actions** - This section contains the following buttons:

Button Name	Button Description
Edit	Used to edit the settings of the approval workflow group.
Delete	Used to delete the approval workflow group setting.
Regenerate UI Maps	Used to regenerate the approval workflow group setting UI Maps.

- **Record Information** - This section contains the following fields:

Field Name	Field Description
Business Object	Indicates the business object using which the approval workflow reason is created. In addition, a context menu appears corresponding to this field which helps in navigating to other screens in the application.
	Note: It has a link. On clicking the link, the Business Object screen appears where you can view the details of the respective business object.

Editing Approval Workflow Group Settings

Prerequisites

To edit approval workflow group settings, you should have:

- Approval Chain Selection Algorithm defined in the application.
- Prevalidation, Approval Reason Required, and Active flag defined in the application.
- Conditional Algorithm defined in the application

Procedure

To edit approval workflow group settings:

1. Search for the approval workflow group in the **Approval Workflow Setting** screen.
2. In the **Search Results** section, click the link in the **Description** column corresponding to the approval workflow group whose details you want to edit.

The **Approval Workflow Settings** screen appears.

3. Click the **Edit** button in the **Approval Workflow Group Settings** zone.

The **Approval Workflow Group Settings** screen appears.

4. Edit the settings for the approval workflow group, if required.
5. Click **Save**.

The changes made to the approval workflow group settings are saved.

Related Topics

For more information on...	See...
How to search for an approval workflow group	Searching for an Approval Workflow Group on page 1029
Approval Workflow Settings screen	Approval Workflow Setting (Used for Viewing) on page 1072
Approval Workflow Group Settings zone	Approval Workflow Group Settings on page 1072

Deleting Approval Workflow Group Settings

Procedure

To delete approval workflow group settings:

1. Search for the approval workflow group in the **Approval Workflow Setting** screen.
2. In the **Search Results** section, click the link in the **Description** column corresponding to the approval workflow group that you want to delete.

The **Approval Workflow Settings** screen appears.

3. Click the **Delete** button in the **Approval Workflow Group Settings** zone.

A message appears confirming whether you want to delete the approval workflow group settings.

4. Click **OK**.

The approval workflow setting is deleted.

Related Topics

For more information on...	See...
How to search for an approval workflow group	Searching for an Approval Workflow Group on page 1029
Approval Workflow Settings screen	Approval Workflow Setting (Used for Viewing) on page 1072
Approval Workflow Group Settings zone	Approval Workflow Group Settings on page 1072

Regenerating Input and Display UI Maps

Procedure

To regenerate UI Maps for an approval workflow group setting:

1. Search for the approval workflow group in the **Approval Workflow Setting** screen.
2. In the **Search Results** section, click the link in the **Description** column corresponding to the approval workflow group for which you want to regenerate UI maps.

The **Approval Workflow Settings** screen appears.

3. Click the **Regenerate UI Maps** button in the **Approval Workflow Group Settings** zone.

A message appears confirming whether you want to replace the existing Input and Display UI Maps.

4. Click **OK**.

The Input and Display UI Maps are generated.

Related Topics

For more information on...	See...
How to search for an approval workflow group	Searching for an Approval Workflow Group on page 1029
Approval Workflow Settings screen	Approval Workflow Setting (Used for Viewing) on page 1072
Approval Workflow Setting zone	Approval Workflow Group Settings on page 1072

Approval Workflow Reason (Used for Searching)

The **Approval Workflow Reason** screen allows you to search for an approval workflow reason using various search criteria. It also allows you to define an approval workflow reason. It contains the following zone:

- [Approval Workflow Reason List](#) on page 1075

Approval Workflow Reason List

The **Approval Workflow Reason List** zone lists the approval workflow reasons that are already defined in the system. It contains the following two sections:

- **Search Criteria** - The **Search Criteria** section contains the following fields:

Field Name	Field Description	Mandatory (Yes or No)
Approval Workflow Reason	Used to search a particular approval workflow reason.	No
Description	Used to search approval workflow reasons with a particular description.	No

- **Search Results** - On clicking the **Search** button, the search results are filtered based on the specified search criteria. The **Search Results** section contains the following columns:

Column Name	Column Description
Approval Workflow Reason	Displays the approval workflow reason.
Description	Displays the description of the approval workflow reason.
Reason Category	Indicates the category to which the approval workflow reason belongs. The valid values are: <ul style="list-style-type: none"> • Approve • Cancel • Reject

Related Topics

For more information on...	See...
How to filter approval workflow reasons	Filtering the Approval Workflow Reasons on page 1076
How to view the details of an approval workflow reason	Viewing the Approval Workflow Reason Details on page 1077
How to define an approval workflow reason	Defining an Approval Workflow Reason on page 1077

Filtering the Approval Workflow Reasons

Procedure

To filter the approval workflow reasons:

1. Click the **Admin** link in the **Application** toolbar.
A list appears.
2. From the **Admin** menu, select **A** and then click **Approval Workflow Reason**.
The **Approval Workflow Reason** screen appears.
3. Enter the required search criteria in the **Approval Workflow Reason List** zone.

Note: ORMB search engine supports wildcard search, where you can substitute the percentage (%) symbol as a stand in for any word or letter in a search criteria. You can use the ‘%’ wildcard character in all input fields except the date and ID fields. The ‘%’ wildcard character is suffixed automatically at the end of the partial search criteria. Therefore, you may or may not specify the wildcard character at the end of the partial search criteria. However, you have to prefix the wildcard character manually wherever required.

4. Click **Search**.
The search results are filtered based on the specified criteria.

Related Topics

For more information on...	See...
Approval Workflow Reason screen	Approval Workflow Reason (Used for Searching) on page 1075
Approval Workflow Reason List zone	Approval Workflow Reason List on page 1075

Viewing the Approval Workflow Reason Details

Procedure

To view the details of an approval workflow reason:

1. If required, filter the approval workflow reasons in the **Approval Workflow Reason** screen.
2. In the **Search Results** section, click the link in the **Description** column corresponding to the approval workflow reason whose details you want to view.

The **Approval Workflow Reason** screen appears. It contains the following zone:

- [Approval Workflow Reason](#) on page 1078

3. View the details of the approval workflow reason in the **Approval Workflow Reason** zone.

Related Topics

For more information on...	See...
How to filter the approval workflow reasons	Filtering the Approval Workflow Reasons on page 1076
Approval Workflow Reason screen	Approval Workflow Reason (Used for Viewing) on page 1078

Defining an Approval Workflow Reason

Prerequisites

To define an approval workflow reason, you should have:

- Values defined for the **APPTXN_REASON_TYPE** lookup field

Procedure

To define an approval workflow reason:

1. Click the **Admin** link in the **Application** toolbar.
A list appears.
2. From the **Admin** menu, select **A** and then click **Approval Workflow Reason**.
The **Approval Workflow Reason** screen appears.
3. Click the **Add** button in the **Page Title** area of the **Approval Workflow Reason** screen.

The **Approval Workflow Reason** screen appears. It contains the following fields:

Field Name	Field Description	Mandatory (Yes or No)
Approval Workflow Reason	Used to specify the approval workflow reason.	Yes
Description	Used to specify the description for the approval workflow reason.	Yes

Field Name	Field Description	Mandatory (Yes or No)
Reason Category	Used to indicate the category to which the approval workflow reason belongs. The valid values are: <ul style="list-style-type: none"> • Approve • Cancel • Reject 	Yes

- Enter the required details in the **Approval Workflow Reason** screen.
- Click **Save**.

The approval workflow reason is defined.

Related Topics

For more information on...	See...
Approval Workflow Reason screen	Approval Workflow Reason (Used for Searching) on page 1075

Approval Workflow Reason (Used for Viewing)

Once you define an approval workflow reason, the **Approval Workflow Reason** screen allows you to:

- View the details of an approval workflow reason
- Edit and delete an approval workflow reason

This screen contains the following zone:

- [Approval Workflow Reason](#) on page 1078

Approval Workflow Reason

The **Approval Workflow Reason** zone displays the details of the approval workflow reason. It contains the following sections:

- **Main** - Displays basic information about the approval workflow reason. It contains the following fields:

Field Name	Field Description
Approval Workflow Reason	Displays the approval workflow reason.
Description	Displays the description of the approval workflow reason.
Reason Category	Indicates the category to which the approval workflow reason belongs. The valid values are: <ul style="list-style-type: none"> • Approve • Cancel • Reject

- **Record Actions** - This section contains the following buttons:

Button Name	Button Description
Edit	Used to edit the details of the approval workflow reason.
Delete	Used to delete the approval workflow reason.

- **Record Information** - This section contains the following field:

Field Name	Field Description
Business Object	Indicates the business object using which the approval workflow reason is created. In addition, a context menu appears corresponding to this field which helps in navigating to other screens in the application.
	Note: It has a link. On clicking the link, the Business Object screen appears where you can view the details of the respective business object.

Related Topics

For more information on...	See...
How to edit an approval workflow reason	Editing an Approval Workflow Reason on page 1079
How to delete an approval workflow reason	Deleting an Approval Workflow Reason on page 1080

Editing an Approval Workflow Reason

Prerequisites

To edit an approval workflow reason, you should have:

- Values defined for the **APPTXN_REASON_TYPE** lookup field

Procedure

To edit an approval workflow reason:

1. Click the **Admin** link in the **Application** toolbar.
A list appears.
2. From the **Admin** menu, select **A** and then click **Approval Workflow Reason**.
The **Approval Workflow Reason** screen appears.
3. If required, filter the approval workflow reasons in the **Approval Workflow Reason** screen.
4. In the **Search Results** section, click the link in the **Description** column corresponding to the approval workflow reason whose details you want to edit.

The **Approval Workflow Reason** screen appears.

5. Click the **Edit** button in the **Approval Workflow Reason** zone.

The **Approval Workflow Reason** screen appears. It contains the following fields:

Field Name	Field Description	Mandatory (Yes or No)
Approval Workflow Reason	Displays the approval workflow reason.	Not applicable
Description	Used to specify the description for the approval workflow reason.	Yes

Field Name	Field Description	Mandatory (Yes or No)
Reason Category	Used to indicate the category to which the approval workflow reason belongs. The valid values are: <ul style="list-style-type: none"> • Approve • Cancel • Reject 	Yes

6. Modify the required details in the **Approval Workflow Reason** screen.
7. Click **Save**.

The changes made to the approval workflow reason are saved.

Related Topics

For more information on...	See...
How to filter the approval workflow reasons	Filtering the Approval Workflow Reasons on page 1076
Approval Workflow Reason screen	Approval Workflow Reason (Used for Viewing) on page 1078
Approval Workflow Reason zone	Approval Workflow Reason on page 1078

Deleting an Approval Workflow Reason

Procedure

To delete an approval workflow reason:

1. Click the **Admin** link in the **Application** toolbar.
A list appears.
2. From the **Admin** menu, select **A** and then click **Approval Workflow Reason**.
The **Approval Workflow Reason** screen appears.
3. If required, filter the approval workflow reasons in the **Approval Workflow Reason** screen.
4. In the **Search Results** section, click the link in the **Description** column corresponding to the approval workflow reason that you want to delete.
The **Approval Workflow Reason** screen appears.
5. Click the **Delete** button in the **Approval Workflow Reason** zone.
A message appears confirming whether you want to delete the approval workflow reason.
6. Click **OK**.
The approval workflow reason is deleted.

Related Topics

For more information on...	See...
How to filter the approval workflow reasons	Filtering the Approval Workflow Reasons on page 1076
Approval Workflow Reason screen	Approval Workflow Reason (Used for Viewing) on page 1078
Approval Workflow Reason zone	Approval Workflow Reason on page 1078

Chapter 12

Rules Engine

Topics:

- [Rule Type \(Used for Searching\)](#)
- [Rule Type \(Used for Viewing\)](#)
- [Rule](#)
- [Rule](#)
- [Rule Check](#)

A rules engine executes one or more business rules in a runtime production environment. It allows you to define, execute, and maintain these business rules separately from the application code. You can then use these business rules in any program to facilitate operational decisions at runtime. For example, you might use business rules in the Collection module to decide the collection strategy or in the Banking module to derive charges codes or price items for the transaction.

A rules engine allows you to classify these rules using the rule type. It also allows you to define the relationship between two or more rules and set the priority for each rule. When a calling program invokes these rules using the rule type, all effective rules with the specified rule type are executed, starting with the rule having highest priority. For example, a rule with the priority 10 will be executed before a rule with the priority 20.

Each rule contains one or more criteria. Depending on whether the criteria is satisfied, the system either executes the next criteria or indicates whether the rule is true or false. The rules engine allows you to define what should happen when the rule is true or false. In both the cases, you can enforce the system to either:

- Execute any dependent rule
- Execute a rule with the same rule type having lower priority
- Return the output parameters and their values to the calling program

You can define a criteria for a rule only using the input parameters that are defined for the rule type. Also, when the rule is true, you can only return the output parameters that are defined for the rule type to the calling programs. Therefore, in case you want to use any field in the rule, you have to associate it with the rule type as an input or output parameter.

A rules engine also allows you to execute preprocessing and postprocessing algorithms. A preprocessing algorithm is triggered before executing any criteria in the rule. It pre-processes the input parameters and then returns processed values against which the criteria is validated. A postprocessing algorithm is triggered after executing all criteria in the rule. It post-processes the output parameters and returns the updated values to the calling programs or dependent rules.

Oracle Revenue Management and Billing provides you with the Rule Check utility. It allows you to validate whether rules defined with a specific rule type get executed as expected. On validating, it indicates the sequence in which the rules were executed, the total execution time, and displays the output parameters of the rule that was successfully executed.

Normally, in the Transaction Feed Management feature, the transaction legs are created using the output parameters of the rule where the criteria returns **Rule**

Is True and the rule true action is set to **Success**. Oracle Revenue Management and Billing also enables you to accumulate the output parameters of all rules where the criteria returns **Rule Is True** irrespective of whether the rule true action is set to **Next Dependent**, **Next Rule by Priority**, or **Success**. This accumulation process continues until a rule is executed where the criteria returns **Rule Is True** and the rule true action is set to **Success**. Once the output parameters are accumulated, the transactions legs are created using these accumulated output parameters. You can enable the rule output accumulation feature for the Transaction Feed Management module by setting the **Rule Output Accumulation** option type in the **C1_FM** feature configuration to **true**.

There might be situations when duplicate transaction legs are created through the rule output accumulation process. The system enables you to indicate whether duplicate transaction legs must be created during the transaction aggregation cycle through the rule output accumulation process. If the **Remove Duplicates from Accumulated Rule Output** option type in **C1_FM** feature configuration is set to **true**, the system does not create duplicate transaction legs during the transaction aggregation cycle.

Note: The transaction legs with the same account ID, price item, variance parameter or price item parameters, and processing date are considered as duplicate transaction legs.

Rule Type (Used for Searching)

A rule type can be used for defining rule based auto pay instructions or business rules for mapping transactions with the price items. If you want to use the rule type for defining rule based auto pay instructions, you must set the **Rule Type Usage** field to **Auto Pay**. However, if you want to use the rule type for defining business rules for mapping transactions with the price items, you must leave the **Rule Type Usage** field blank.

It is the rule type which helps the system to determine:

- Fields that can be used while defining criteria for business rules or rule based auto pay instructions
- Entities whose characteristics can be used while defining criteria for rule based auto pay instructions
- Algorithms which must be used for deriving information from the financial transaction
- Maximum number of rules that can be defined when the rule based auto pay instruction is created using the rule type

The **Rule Type** screen allows you to search for a rule type using various search criteria. It also allows you to define, edit, delete, and copy a rule type. It contains the following zone:

- [Search Rule Type](#) on page 1083

Search Rule Type





The **Search Rule Type** zone allows you to search for a rule type using various search criteria. It contains the following two sections:

- **Search Criteria** - The **Search Criteria** section contains the following fields:

Field Name	Field Description	Mandatory (Yes or No)
Rule Type	Used to search a particular rule type.	No
Description	Used to search rule types with a particular description.	No
Rule Type Usage	Used to indicate whether you want to search rule types which are used for defining rule based auto pay instructions or which are used for defining business rules for mapping transactions with the price items. The valid value is: <ul style="list-style-type: none"> • ASO Billing Line Item Eligibility • ASO Billing Markup/Down Eligibility • • Auto Pay 	No
	Note: If you want to search rule types which are used for defining business rules for mapping transactions with the price items, you must leave this field blank.	

- **Search Results** - On clicking the **Search** button, the search results appear based on the specified search criteria. The **Search Results** section contains the following columns:

Column Name	Column Description
Rule Type	Displays the rule type.
Description	Displays the description of the rule type.

Column Name	Column Description
Rule Type Usage	Indicates whether the rule type is used for defining rule based auto pay instructions or for defining business rules for mapping transactions with the price items.
View	On clicking the View () icon, the Rule Type screen appears where you can view the details of the rule type.
Edit	On clicking the Edit () icon, the Rule Type screen appears where you can edit the details of the rule type.
Delete	On clicking the Delete () icon, you can delete the rule type.
	Note: You can delete a rule type when the rule based auto pay instructions or business rules are not yet defined using the rule type.
Duplicate	On clicking the Duplicate () icon, the Rule Type screen appears where you can create a new rule type using an existing rule type.

Related Topics

For more information on...	See...
How to search for a rule type	Searching for a Rule Type on page 1084
How to view the details of a rule type	Viewing the Rule Type Details on page 1098
How to edit a rule type	Editing a Rule Type on page 1091
How to delete a rule type	Deleting a Rule Type on page 1094
How to copy a rule type	Copying a Rule Type on page 1094

Searching for a Rule Type

Prerequisites

To search for a rule type, you should have:

- Values defined for the **C1_RULE_USAGE_FLG** lookup field

Procedure

To search for a rule type:

1. Click the **Admin** link in the **Application** toolbar.
A list appears.
2. From the **Admin** menu, select **R** and then click **Rule Type**.
A sub-menu appears.
3. Click the **Search** option from the **Rule Type** sub-menu.
The **Rule Type** screen appears.
4. Enter the search criteria in the **Search Rule Type** zone.

Note: ORMB search engine supports wildcard search, where you can substitute the percentage (%) symbol as a stand in for any word or letter in a search criteria. You can use the ‘%’ wildcard character in all input fields except the date and ID fields. The ‘%’ wildcard character is suffixed automatically at the end of the partial search criteria. Therefore, you may or may not specify the wildcard character at the end of the partial search criteria. However, you have to prefix the wildcard character manually wherever required.

5. Click **Search**.

A list of rule types that meet the search criteria appears in the **Search Results** section.

Related Topics

For more information on...	See...
Rule Type screen	Rule Type (Used for Searching) on page 1083
Search Rule Type zone	Search Rule Type on page 1083

Defining a Rule Type

Prerequisites

To define a rule type, you should have:

- Values defined for the **C1_RULE_USAGE_FLG** lookup field
- Values defined for the **RULE_TYPE_CAT_FLG** lookup field

Procedure

To define a rule type:

1. Click the **Admin** link in the **Application** toolbar.
A list appears.
2. From the **Admin** menu, select **R** and then click **Rule Type**.
A sub-menu appears.
3. Click the **Add** option from the **Rule Type** sub-menu.

The **Rule Type** screen appears. It contains the following sections:

- **Main** - Used to specify basic details about the rule type.
- **Input and Output Parameters** - Used to define input and output parameters for the rule type.
- **Rule Criteria Characteristic Entities** - Used to indicate the entities whose characteristics you can use while defining rule based auto pay instructions using the rule type.

Note: This section appears when you select the **Auto Pay** option from the **Rule Type Usage** list.

- **Rule Criteria Derivation Algorithms** - Used to attach algorithms which you want to use for deriving the following from the financial transaction:
 - Values of all those fields (such as, policy number, plan number, or price item) which are selected in the rule type as the input and output parameters
 - Characteristics of all those entities which are selected in the rule type as the rule criteria characteristic entities

Note: This section appears when you select the **Auto Pay** option from the **Rule Type Usage** list.

The **Main** section contains the following fields:

Field Name	Field Description	Mandatory (Yes or No)
Rule Type	Used to specify the rule type.	Yes

Field Name	Field Description	Mandatory (Yes or No)
Rule Type Usage	<p>Used to indicate whether you want to use the rule type for defining rule based auto pay instructions or for defining business rules for mapping transactions with the price items. The valid values are:</p> <ul style="list-style-type: none"> • Line Item Eligibility • Mark Up/Mark Down Eligibility • Domestic Provider Eligibility • Auto Pay • File Upload Interface • Price Item Eligibility • Related Pricing Rule Type Eligibility <p>Note: If you want to use the rule type for defining rule based auto pay instructions, you must set the rule type usage to Auto Pay. However, if you want to use the rule type for defining business rules for mapping transactions with the price items, you must leave this field blank.</p>	No
Description	Used to specify the description for the rule type.	Yes
Maximum Rule Count	<p>Used to indicate the maximum number of rules that can be defined when the rule based auto pay instruction is created using the rule type.</p> <p>Note: This field appears when you select the Auto Pay option from the Rule Type Usage list. The maximum rule count cannot be less than or equal to zero.</p>	No
Rule Type Category	<p>Used to indicate whether you want to create a field based or parameter based rule type. The valid values are:</p> <ul style="list-style-type: none"> • Field Based • Parameter Based <p>Note: This field appears when you select the Price Item Eligibility or Related Pricing Rule Type Eligibility option from the Rule Type Usage list. By default the value of this option type is set to Field Based.</p>	No

Tip: Alternatively, you can access this screen by clicking the **Add** button in the **Page Title** area of the **Rule Type** screen.

4. Enter the required details in the **Main** section.
5. Define input and output parameters for the rule type.

Note: On selecting the **Parameter Based** option from the **Rule Type Category** list, the **Parameter** column appears in the **Input and Output Parameters** section. Here, you can specify a parameter whether the parameter usage is set to **Rule Eligibility Criteria**.

- Associate one or more characteristic entities with the rule type, if required.

Note: You must specify at least one input or output parameter when you want to use the rule type for defining business rules for mapping transactions with the price items. However, you must specify at least one input or output parameter or associate at least one characteristic entity when you want to use the rule type for defining rule based auto pay instructions.

- Associate the rule criteria derivation algorithm when you want to use the rule type for defining rule based auto pay instructions.

Note: You must associate the rule criteria derivation algorithm with the rule type when the **Rule Type Usage** field is set to **Auto Pay**.

- Click **Save**.

The rule type is defined.

Related Topics

For more information on...	See...
How to define input and output parameters for a rule type	Defining Input and Output Parameters for a Rule Type on page 1087
How to associate a characteristic entity with a rule type	Associating a Characteristic Entity with a Rule Type on page 1089
How to associate an algorithm with a rule type	Associating an Algorithm with a Rule Type on page 1090

Defining Input and Output Parameters for a Rule Type

Prerequisites

To define the input and output parameters for a rule type, you should have:

- Fields defined in the application
- Field search zone defined in the application

Procedure

To define the input and output parameters for a rule type:

- Ensure that the **Input and Output Parameters** section is expanded when you are defining, editing, or copying a rule type.

The **Input and Output Parameters** section contains the following fields in a grid:

Field Name	Field Description	Mandatory (Yes or No)
Sequence	Used to specify the sequence number for the input or output parameter.	Yes

Field Name	Field Description	Mandatory (Yes or No)
Field	Used to indicate the field that you want to use as the input or output parameter while defining a business rule.	Yes
	<p>Note: The Search (🔍) icon appears corresponding to this field. On clicking the Search icon, the Field Search window appears. On specifying the field, the description of the field appears corresponding to the Field.</p>	
Parameter	Used to indicate the parameter that you want to use as the input or output parameter while defining a business rule.	Yes
	<p>Note:</p> <p>The Search (🔍) icon appears corresponding to this field. On clicking the Search icon, the Parameter Search window appears. On specifying the parameter, the description of the parameter appears corresponding to the Parameter field.</p> <p>This field appears when you select the Parameter Based option from the Rule Type Category field.</p>	
Rule Input/ Output	Used to indicate whether you want to use the field as input and/or output parameter while defining a business rule. The valid values are:	Yes
	<ul style="list-style-type: none"> • Input • Input and Output • Output <p>Note:</p> <p>By default, the Input option is selected.</p> <p>This field appears when you do not select the Auto Pay option from the Rule Type Usage list.</p>	
Search Zone	Used to indicate the search zone that you want to use for searching the field value while defining criteria for rule based auto pay instructions.	No
	<p>Note:</p> <p>The Search (🔍) icon appears corresponding to this field. On clicking the Search icon, the Zone Search window appears.</p> <p>This field appears when you select the Auto Pay option from the Rule Type Usage list.</p>	

2. Enter the required details in the **Input and Output Parameters** section.

Note:

At present, the following fields are only supported while defining a rule type where the **Rule Type Usage** field is set to **Auto Pay**:

- Policy Number
- Plan Number
- Price Item

If you want to use any other field while defining criteria for rule based auto pay instructions, the implementation team will have to develop the custom logic to implement the requirement.

3. If you want to define more than one input or output parameter for the rule type, click the **Add (+)** icon and then repeat step 2.

Note: However, if you want to remove an input or output parameter from the rule type, click the **Delete (🗑)** icon corresponding to the parameter.

Related Topics

For more information on...	See...
How to define a rule type	Defining a Rule Type on page 1085
How to edit a rule type	Editing a Rule Type on page 1091
How to copy a rule type	Copying a Rule Type on page 1094

Associating a Characteristic Entity with a Rule Type**Prerequisites**

To associate a characteristic entity with a rule type, you should have:

- Values defined for the **RULE_CRITERIA_ENTITY_FLG** lookup field

Procedure

To associate a characteristic entity with a rule type:

1. Ensure that the **Rule Criteria Characteristic Entities** section is expanded when you are defining, editing, or copying a rule type.

The **Rule Criteria Characteristic Entities** section contains the following fields in a grid:

Field Name	Field Description	Mandatory (Yes or No)
Characteristic Entity	<p>Used to indicate the entity whose characteristics you want to use while defining criteria for rule based auto pay instructions. The valid values are:</p> <ul style="list-style-type: none"> • Adjustment • Billable Charge • Policy • Policy Plan • Price Item 	Yes
	<p>Note: At present, the characteristics of the above listed entities are only supported while defining criteria for rule based auto pay instructions. If you want to use characteristics of any other entity, the implementation team will have to develop the custom logic to implement the requirement.</p>	

Note: This section appears when you select the **Auto Pay** option from the **Rule Type Usage** list.

2. Enter the required details in the **Rule Criteria Characteristic Entities** section.
3. If you want to associate more than one characteristic entity with the rule type, click the **Add (+)** icon and then repeat step 2.

Note: However, if you want to remove a characteristic entity from the rule type, click the **Delete** (🗑️) icon corresponding to the characteristic entity.

Related Topics

For more information on...	See...
How to define a rule type	Defining a Rule Type on page 1085
How to edit a rule type	Editing a Rule Type on page 1091
How to copy a rule type	Copying a Rule Type on page 1094

Associating an Algorithm with a Rule Type

Prerequisites

To associate an algorithm with a rule type, you should have:

- Rule criteria derivation algorithm defined using the **C1-APRCRIDER** algorithm type

Procedure

To associate an algorithm with a rule type:

1. Ensure that the **Rule Criteria Derivation Algorithms** section is expanded when you are defining, editing, or copying a rule type.

The **Rule Criteria Derivation Algorithms** section contains the following fields in a grid:

Field Name	Field Description	Mandatory (Yes or No)
Sequence	Used to indicate the order in which the algorithm should be executed.	Yes
Algorithm	<p>Used to attach an algorithm which you want to use for deriving the following from the financial transaction:</p> <ul style="list-style-type: none"> • Values of all those fields (such as, policy number, plan number, or price item) which are selected in the rule type as the input and output parameters • Characteristics of all those entities which are selected in the rule type as the rule criteria characteristic entities <p>Note: The Search (🔍) icon appears corresponding to this field. On clicking the Search icon, the Algorithm Search window appears.</p>	Yes

Note: This section appears when you select the **Auto Pay** option from the **Rule Type Usage** list.

2. Enter the required details in the **Rule Criteria Derivation Algorithms** section.
3. If you want to associate more than one algorithm with the rule type, click the **Add** (+) icon and then repeat step 2.

Note: However, if you want to remove an algorithm from the rule type, click the **Delete** (🗑️) icon corresponding to the algorithm.

Related Topics

For more information on...	See...
How to define a rule type	Defining a Rule Type on page 1085
How to edit a rule type	Editing a Rule Type on page 1091
How to copy a rule type	Copying a Rule Type on page 1094

Editing a Rule Type

Procedure

To edit a rule type:

1. Search for the rule type in the **Rule Type** screen.
2. In the **Search Results** section, click the **Edit** (✎) icon in the **Edit** column corresponding to the rule type whose details you want to edit.

The **Rule Type** screen appears. It contains the following sections:

- **Main** - Used to specify basic details about the rule type.
- **Input and Output Parameters** - Used to define input and output parameters for the rule type.
- **Rule Criteria Characteristic Entities** - Used to indicate the entities whose characteristics you can use while defining rule based auto pay instructions using the rule type.

Note: This section appears when you select the **Auto Pay** option from the **Rule Type Usage** list.

- **Rule Criteria Derivation Algorithms** - Used to attach algorithms which you want to use for deriving the following from the financial transaction:
 - Values of all those fields (such as, policy number, plan number, or price item) which are selected in the rule type as the input and output parameters
 - Characteristics of all those entities which are selected in the rule type as the rule criteria characteristic entities

Note: This section appears when you select the **Auto Pay** option from the **Rule Type Usage** list.

The **Main** section contains the following fields:

Field Name	Field Description	Mandatory (Yes or No)
Rule Type	Displays the rule type.	Not applicable
	Note: This is a read-only field.	
Rule Type Usage	Indicates whether the rule type is used for defining rule based auto pay instructions or for defining business rules for mapping transactions with the price items. The valid values are: <ul style="list-style-type: none"> • Line Item Eligibility • Mark Up/Mark Down Eligibility • Domestic Provider Eligibility • Auto Pay • File Upload Interface • Price Item Eligibility • Related Pricing Rule Type Eligibility 	Not applicable
	Note: This is a read-only field.	
Description	Used to specify the description for the rule type.	Yes
Maximum Rule Count	Used to indicate the maximum number of rules that can be defined when the rule based auto pay instruction is created using the rule type.	No
	Note: This field appears when the Rule Type Usage field is set to Auto Pay . The maximum rule count cannot be less than or equal to zero. You cannot reduce the maximum rule count when one or more auto pay instructions contain the specified number of rules.	

Field Name	Field Description	Mandatory (Yes or No)
Rule Type Category	<p>Used to indicate whether you want to create a field based or parameter based rule type. The valid values are:</p> <ul style="list-style-type: none"> Field Based Parameter Based 	No
	<p>Note:</p> <p>This field appears when you have selected the Price Item Eligibility or Related Pricing Rule Type Eligibility option from the Rule Type Usage list while defining a rule type.</p> <p>This is a read-only field.</p>	

Tip: Alternatively, you can edit the details of a rule type by clicking the **Edit** link in the **Rule Type** zone.

- Modify the required details in the **Main** section.
- Define, edit, or remove input or output parameters from the rule type, if required.

Note: You cannot edit or remove an input or output parameter from the rule type when it is used for defining criteria in a business rule or rule based auto pay instruction.

- Associate or remove one or more characteristic entities from the rule type, if required.

Note:

You must specify at least one input or output parameter when you want to use the rule type for defining business rules for mapping transactions with the price items. However, you must specify at least one input or output parameter or associate at least one characteristic entity when you want to use the rule type for defining rule based auto pay instructions.

You cannot remove a characteristic entity from the rule type when it is used for defining criteria in a rule based auto pay instruction.

- Associate or remove one or more rule criteria derivation algorithm from the rule type, if required.

Note: You must associate the rule criteria derivation algorithm with the rule type when the **Rule Type Usage** field is set to **Auto Pay**.

- Click **Save**.

The changes made to the rule type are saved.

Related Topics

For more information on...	See...
How to search for a rule type	Searching for a Rule Type on page 1084
How to define input and output parameters for a rule type	Defining Input and Output Parameters for a Rule Type on page 1087
How to associate a characteristic entity with a rule type	Associating a Characteristic Entity with a Rule Type on page 1089
How to associate an algorithm with a rule type	Associating an Algorithm with a Rule Type on page 1090

For more information on...	See...
Rule Type zone	Rule Type on page 1097

Deleting a Rule Type

Procedure

To delete a rule type:

1. Search for the rule type in the **Rule Type** screen.
2. In the **Search Results** section, click the **Delete** () icon in the **Delete** column corresponding to the rule type that you want to delete.

A message appears confirming whether you want to delete the rule type.

Note: You can delete a rule type when the rule based auto pay instructions or business rules are not yet defined using the rule type.

3. Click **OK**.

The rule type is deleted.

Related Topics

For more information on...	See...
How to search for a rule type	Searching for a Rule Type on page 1084

Copying a Rule Type

Instead of creating a rule type from scratch, you can create a new rule type using an existing rule type. This is possible through copying a rule type. On copying a rule type, the details including the input and output parameters, rule criteria characteristic entities, and rule criteria derivation algorithms are copied to the new rule type. You can then edit the details, if required.

Prerequisites

To copy a rule type, you should have:

- Rule type (whose copy you want to create) defined in the application
- Values defined for the **C1_RULE_USAGE_FLG** lookup field
- Values defined for the **RULE_TYPE_CAT_FLG** lookup field

Procedure

To copy a rule type:

1. Search for the rule type in the **Rule Type** screen.
2. In the **Search Results** section, click the **Copy** () icon in the **Copy** column corresponding to the rule type whose copy you want to create.

The **Rule Type** screen appears. It contains the following sections:

- **Main** - Used to specify basic details about the rule type.
- **Input and Output Parameters** - Used to define input and output parameters for the rule type.
- **Rule Criteria Characteristic Entities** - Used to indicate the entities whose characteristics you can use while defining rule based auto pay instructions using the rule type.

Note: This section appears when you select the **Auto Pay** option from the **Rule Type Usage** list.

- **Rule Criteria Derivation Algorithms** - Used to attach algorithms which you want to use for deriving the following from the financial transaction:
 - Values of all those fields (such as, policy number, plan number, or price item) which are selected in the rule type as the input and output parameters
 - Characteristics of all those entities which are selected in the rule type as the rule criteria characteristic entities

Note: This section appears when you select the **Auto Pay** option from the **Rule Type Usage** list.

The **Main** section contains the following fields:

Field Name	Field Description	Mandatory (Yes or No)
Rule Type	Used to specify the rule type.	Yes
Rule Type Usage	<p>Used to indicate whether you want to use the rule type for defining rule based auto pay instructions or for defining business rules for mapping transactions with the price items. The valid values are:</p> <ul style="list-style-type: none"> • Line Item Eligibility • Mark Up/Mark Down Eligibility • Domestic Provider Eligibility • Auto Pay • File Upload Interface • Price Item Eligibility • Related Pricing Rule Type Eligibility <p>Note: If you want to use the rule type for defining rule based auto pay instructions, you must set the rule type usage to Auto Pay. However, if you want to use the rule type for defining business rules for mapping transactions with the price items, you must leave this field blank.</p>	No
Description	Used to specify the description for the rule type.	Yes
Maximum Rule Count	<p>Used to indicate the maximum number of rules that can be defined when the rule based auto pay instruction is created using the rule type.</p> <p>Note: This field appears when you select the Auto Pay option from the Rule Type Usage list. The maximum rule count cannot be less than or equal to zero.</p>	No

Field Name	Field Description	Mandatory (Yes or No)
Rule Type Category	Used to indicate whether you want to create a field based or parameter based rule type. The valid values are: <ul style="list-style-type: none"> Field Based Parameter Based 	No
	<p>Note:</p> <p>This field appears when you select the Price Item Eligibility or Related Pricing Rule Type Eligibility option from the Rule Type Usage list.</p> <p>By default the value of this option type is set to Field Based.</p>	

- Enter the required details in the **Main** section.
- Define, edit, or remove input or output parameters from the rule type, if required.

Note: On selecting the **Parameter Based** option from the **Rule Type Category** list, the **Parameter** column appears in the **Input and Output Parameters** section. Here, you can specify a parameter whether the parameter usage is set to **Rule Eligibility Criteria**.

- Associate or remove one or more characteristic entities from the rule type, if required.

Note: You must specify at least one input or output parameter when you want to use the rule type for defining business rules for mapping transactions with the price items. However, you must specify at least one input or output parameter or associate at least one characteristic entity when you want to use the rule type for defining rule based auto pay instructions.

- Associate the rule criteria derivation algorithm when you want to use the rule type for defining rule based auto pay instructions.

Note: You must associate the rule criteria derivation algorithm with the rule type when the **Rule Type Usage** field is set to **Auto Pay**.

- Click **Save**.

The new rule type is defined.

Related Topics

For more information on...	See...
How to search for a rule type	Searching for a Rule Type on page 1084
How to define input and output parameters for a rule type	Defining Input and Output Parameters for a Rule Type on page 1087
How to associate a characteristic entity with a rule type	Associating a Characteristic Entity with a Rule Type on page 1089
How to associate an algorithm with a rule type	Associating an Algorithm with a Rule Type on page 1090

Rule Type (Used for Viewing)

The **Rule Type** screen allows you to view the details of the rule type. It contains the following zone:

- [Rule Type](#) on page 1097

Rule Type

The **Rule Type** zone displays the details of the rule type. It contains the following sections:

- **Main** - Displays basic information about the rule type. It contains the following fields:

Field Name	Field Description
Rule Type	Displays the rule type.
Rule Type Usage	<p>Indicates whether the rule type is used for defining rule based auto pay instructions or for defining business rules for mapping transactions with the price items. The valid values are:</p> <ul style="list-style-type: none"> • Line Item Eligibility • Mark Up/Mark Down Eligibility • Domestic Provider Eligibility • Auto Pay • File Upload Interface • Price Item Eligibility • Related Pricing Rule Type Eligibility <p>Note: This field appears when the rule type usage is specified while defining the rule type.</p>
Description	Displays the description of the rule type.
Maximum Rule Count	<p>Indicates the maximum number of rules that can be defined when the rule based auto pay instruction is created using the rule type.</p> <p>Note: This field appears when the Rule Type Usage field is set to Auto Pay.</p>
Rule Type Category	<p>Indicates whether you want to create a field based or parameter based rule type. The valid values are:</p> <ul style="list-style-type: none"> • Field Based • Parameter Based <p>Note: This field appears when you select the Price Item Eligibility or Related Pricing Rule Type Eligibility option from the Rule Type Usage list while defining the rule type.</p>

- **Input and Output Parameters** - Lists the input and output parameters defined for the rule type. It contains the following columns:

Column Name	Column Description
Sequence	Displays the sequence number of the input or output parameter.
Field	Indicates the field which is used as the input or output parameter.
Parameter	Indicates the parameter that you want to use as the input or output parameter.
Rule Input/Output	Indicates whether the field is used as input and/or output parameter while defining a business rule.

Column Name	Column Description
Search Zone	Indicates the search zone that is used for searching the field value while defining criteria for rule based auto pay instructions.
	Note: It has a link. On clicking the link, the Zone screen appears where you can view the details of the zone.

- **Rule Criteria Characteristic Entities** - This section contains the following column:

Column Name	Column Description
Characteristic Entity	Indicates the entity whose characteristics can be used while defining criteria for rule based auto pay instructions. The valid values are: <ul style="list-style-type: none"> • Adjustment • Billable Charge • Policy • Policy Plan • Price Item

- **Rule Criteria Derivation Algorithms** - Lists the algorithms attached to the rule type. It contains the following columns:

Column Name	Column Description
Sequence	Indicates the order in which the algorithm should be executed.
Algorithm	Indicates the algorithm attached to the rule type which derives the following from the financial transaction: <ul style="list-style-type: none"> • Values of all those fields (such as, policy number, plan number, or price item) which are selected in the rule type as the input and output parameters • Characteristics of all those entities which are selected in the rule type as the rule criteria characteristic entities

Note: The **Rule Criteria Characteristic Entities** and **Rule Criteria Derivation Algorithms** sections appear when the **Rule Type Usage** field is set to **Auto Pay**.

You can edit the details of the rule type by clicking the **Edit** link in the upper-right corner of this zone.

Related Topics

For more information on...	See...
How to edit a rule type	Editing a Rule Type on page 1091

Viewing the Rule Type Details

Procedure

To view the details of a rule type:

1. Search for the rule type in the **Rule Type** screen.
2. In the **Search Results** section, click the **View** () icon in the **View** column corresponding to the rule type whose details you want to view.

The **Rule Type** screen appears.

3. View the details of the rule type in the **Rule Type** zone.

Related Topics

For more information on...	See...
How to search for a rule type	Searching for a Rule Type on page 1084
Rule Type screen	Rule Type (Used for Viewing) on page 1096
Rule Type zone	Rule Type on page 1097

Editing a Rule Type

Procedure

To edit a rule type:

1. Search for the rule type in the **Rule Type** screen.
2. In the **Search Results** section, click the **Edit** (✎) icon in the **Edit** column corresponding to the rule type whose details you want to edit.

The **Rule Type** screen appears. It contains the following sections:

- **Main** - Used to specify basic details about the rule type.
- **Input and Output Parameters** - Used to define input and output parameters for the rule type.
- **Rule Criteria Characteristic Entities** - Used to indicate the entities whose characteristics you can use while defining rule based auto pay instructions using the rule type.

Note: This section appears when you select the **Auto Pay** option from the **Rule Type Usage** list.

- **Rule Criteria Derivation Algorithms** - Used to attach algorithms which you want to use for deriving the following from the financial transaction:
 - Values of all those fields (such as, policy number, plan number, or price item) which are selected in the rule type as the input and output parameters
 - Characteristics of all those entities which are selected in the rule type as the rule criteria characteristic entities

Note: This section appears when you select the **Auto Pay** option from the **Rule Type Usage** list.

The **Main** section contains the following fields:

Field Name	Field Description	Mandatory (Yes or No)
Rule Type	Displays the rule type.	Not applicable
	Note: This is a read-only field.	

Field Name	Field Description	Mandatory (Yes or No)
Rule Type Usage	<p>Indicates whether the rule type is used for defining rule based auto pay instructions or for defining business rules for mapping transactions with the price items. The valid values are:</p> <ul style="list-style-type: none"> Line Item Eligibility Mark Up/Mark Down Eligibility Domestic Provider Eligibility Auto Pay File Upload Interface Price Item Eligibility Related Pricing Rule Type Eligibility <p>Note: This is a read-only field.</p>	Not applicable
Description	Used to specify the description for the rule type.	Yes
Maximum Rule Count	<p>Used to indicate the maximum number of rules that can be defined when the rule based auto pay instruction is created using the rule type.</p> <p>Note: This field appears when the Rule Type Usage field is set to Auto Pay. The maximum rule count cannot be less than or equal to zero. You cannot reduce the maximum rule count when one or more auto pay instructions contain the specified number of rules.</p>	No
Rule Type Category	<p>Used to indicate whether you want to create a field based or parameter based rule type. The valid values are:</p> <ul style="list-style-type: none"> Field Based Parameter Based <p>Note: This field appears when you have selected the Price Item Eligibility or Related Pricing Rule Type Eligibility option from the Rule Type Usage list while defining a rule type. This is a read-only field.</p>	No

Tip: Alternatively, you can edit the details of a rule type by clicking the **Edit** link in the **Rule Type** zone.

3. Modify the required details in the **Main** section.
4. Define, edit, or remove input or output parameters from the rule type, if required.

Note: You cannot edit or remove an input or output parameter from the rule type when it is used for defining criteria in a business rule or rule based auto pay instruction.

- Associate or remove one or more characteristic entities from the rule type, if required.

Note:

You must specify at least one input or output parameter when you want to use the rule type for defining business rules for mapping transactions with the price items. However, you must specify at least one input or output parameter or associate at least one characteristic entity when you want to use the rule type for defining rule based auto pay instructions.

You cannot remove a characteristic entity from the rule type when it is used for defining criteria in a rule based auto pay instruction.

- Associate or remove one or more rule criteria derivation algorithm from the rule type, if required.

Note: You must associate the rule criteria derivation algorithm with the rule type when the **Rule Type Usage** field is set to **Auto Pay**.

- Click **Save**.

The changes made to the rule type are saved.

Related Topics

For more information on...	See...
How to search for a rule type	Searching for a Rule Type on page 1084
How to define input and output parameters for a rule type	Defining Input and Output Parameters for a Rule Type on page 1087
How to associate a characteristic entity with a rule type	Associating a Characteristic Entity with a Rule Type on page 1089
How to associate an algorithm with a rule type	Associating an Algorithm with a Rule Type on page 1090
Rule Type zone	Rule Type on page 1097

Rule

The **Rule** screen allows you to define, edit, delete, and copy a rule. This screen consists of the following zones:

- [Search Rule](#) on page 1101





Search Rule

The **Search Rule** zone allows you to search for a rule. This zone contains the following two sections:

- Search Criteria** - The **Search Criteria** section contains the following fields:

Field Name	Field Description	Mandatory (Yes or No)
Rule	Used to specify the rule code.	No
Rule Type	Used to specify the type of rule.	No
Description	Used to specify the description for the rule.	No
Rule Priority	Used to specify the priority of the rule.	No
Effective Start Date	Used to specify the date from when the rule is effective.	No

- **Search Results** - On clicking the **Search** button, the search results appear based on the specified search criteria. The **Search Results** section contains the following columns:

Column Name	Column Description
Rule Priority	Displays the priority of the rule.
Rule	Displays the rule code.
Description	Displays the description of the rule.
Rule Type	Displays the type of rule.
Effective Start Date	Displays the date from when the rule is effective.
Effective End Date	Displays the date till when the rule is effective.
Pre-Processing Algorithm	Indicates the algorithm that will be triggered before executing the criteria in the rule. It pre-processes the input parameters and then returns processed values against which the criteria is validated.
Post-Processing Algorithm	Indicates the algorithm that will be triggered when the rule is true. It post-processes the output parameters and returns the updated values to the calling programs or dependent rules.
View	On clicking the View () icon, the View Rule screen appears where you can view the details of the rule.
Edit	On clicking the Edit () icon, the Edit Rule screen appears where you can edit the details of the rule.
Delete	On clicking the Delete () icon, you can delete the rule.
	Note: You can delete a rule only if it is not used.
Duplicate	On clicking the Duplicate () icon, the Copy Rule screen appears where you can create a rule using an existing rule.

You can create a new rule by clicking the **Add** link in the upper right corner of this zone.

Related Topics

For more information on...	See...
How to search for a rule	Searching for a Rule on page 1102
How to view the details of a rule	Viewing the Rule Details on page 1103
How to define a rule	Defining a Rule on page 1103
How to edit a rule	Editing a Rule on page 1109
How to delete a rule	Deleting a Rule on page 1115
How to copy a rule	Copying a Rule on page 1116

Searching for a Rule

Procedure

To search for a rule:

1. Click the **Admin** link in the **Application** toolbar.
A list appears.
2. From the **Admin** menu, select **R** and then click **Rule**.
A sub-menu appears.
3. Click the **Search** option from the **Rule** sub-menu.
The **Rule** screen appears.
4. Enter the search criteria in the **Search** zone.

Note: ORMB search engine supports wildcard search, where you can substitute the percentage (%) symbol as a stand in for any word or letter in a search criteria. You can use the ‘%’ wildcard character in all input fields except the date and ID fields. The ‘%’ wildcard character is suffixed automatically at the end of the partial search criteria. Therefore, you may or may not specify the wildcard character at the end of the partial search criteria. However, you have to prefix the wildcard character manually wherever required.

5. Click **Search**.
A list of rules that meet the search criteria appears in the **Search Results** section.

Related Topics

For more information on...	See...
Rule screen	Rule on page 1101
Search zone	Search Rule on page 1101

Viewing the Rule Details

Procedure

To view the details of a rule:

1. Search for the rule in the **Rule** screen.
2. In the **Search Results** section, click the **View** () icon in the **View** column corresponding to the rule whose details you want to view.
The **View Rule** screen appears.
3. View the details of the rule in the **Rule Information** zone.

Related Topics

For more information on...	See...
View Rule screen	Rule on page 1122
Rule Information zone	Rule Information on page 1122
How to search for a rule	Searching for a Rule Type on page 1084

Defining a Rule

Prerequisites

To define a rule, you should have:

- Rule types defined in the application

- Pre-processing and post-processing algorithms, dependent rules, and parameters defined in the application in case you want to use any of them

Procedure

To define a rule:

1. Click the **Admin** link in the **Application** toolbar.
A list appears.
2. From the **Admin** menu, select **R** and then click **Rule**.
A sub-menu appears.
3. Click the **Add** option from the **Rule** sub-menu.

The **Rule** screen appears. It contains the following fields:

Field Name	Field Description	Mandatory (Yes or No)
Rule	Used to specify the rule code.	Yes
Rule Type	Used to specify the type of rule.	Yes
Description	Used to specify the description for the rule.	Yes
Rule Priority	Used to specify the priority of the rule. Note: You cannot define two rules with the same rule type and priority in the same duration.	Yes
Effective Start Date	Used to specify the date from when the rule is effective.	Yes
Effective End Date	Used to specify the date till when the rule is effective. Note: The effective end date cannot be earlier than the effective start date.	No
Pre-Processing Algorithm	Used to specify the algorithm that will be triggered before executing the criteria in the rule. It pre-processes the input parameters and then returns processed values against which the criteria is validated. Note: The Search (🔍) icon appears corresponding to this field. On clicking the Search icon, the Algorithm Search window appears. On specifying the algorithm, the description of the algorithm appears corresponding to the Pre-Processing Algorithm field.	No

Field Name	Field Description	Mandatory (Yes or No)
Post-Processing Algorithm	Used to specify the algorithm that will be triggered when the rule is true. It post-processes the output parameters and returns the updated values to the calling programs or dependent rules.	No
	<p>Note:</p> <p>The Search (🔍) icon appears corresponding to this field. On clicking the Search icon, the Algorithm Search window appears.</p> <p>On specifying the algorithm, the description of the algorithm appears corresponding to the Post-Processing Algorithm field.</p>	
Rule True Action	<p>Used to indicate what should happen when all conditions in the rule are satisfied and returns Rule is True. The valid values are:</p> <ul style="list-style-type: none"> • Next Dependent Rule — Used to indicate that the dependent rule should be executed when the rule is true. • Next Rule by Priority — Used to indicate that the rule of the same rule type having lower priority should be executed when the rule is true. • Success — Used to indicate that no more rules should be executed when the rule is true. The output parameters and their values are returned to the calling programs. 	Yes
Dependent Rule	Used to specify the next dependent rule that must be executed when Next Dependent Rule is selected from the Rule True Action list.	<p>Yes (Conditional)</p> <p>Note: This field is required when you select Next Dependent Rule from the Rule True Action list.</p>
Rule False Action	<p>Used to indicate what should happen when any of the criteria in the rule is not satisfied and returns Rule is False. The valid values are:</p> <ul style="list-style-type: none"> • Next Dependent Rule — Used to indicate that the dependent rule should be executed when the rule is false. • Next Rule by Priority — Used to indicate that the rule of the same rule type having lower priority should be executed when the rule is false. • Success — Used to indicate that no more rules should be executed when the rule is false. The output parameters and their values are returned to the calling programs. 	Yes

Field Name	Field Description	Mandatory (Yes or No)
Dependent Rule	Used to specify the next dependent rule that must be executed when Next Dependent Rule is selected from the Rule False Action list.	Yes (Conditional) Note: This field is required when you select Next Dependent Rule from the Rule False Action list.

In addition, it contains the following two sections:

- **Rule Output Parameters** — Used to specify the output parameters that must be returned to the calling programs or dependent rules when all conditions in the rule are satisfied. This section contains the following columns:

Column Name	Column Description	Mandatory (Yes or No)
Parameter Name	Used to specify the parameter. Note: For more information about the output parameters that you can specify while defining a rule, see Transaction Validation and Initial Price Item Determination . The Search (🔍) icon appears corresponding to this field. On clicking the Search icon, the Search Input or Output Parameter window appears. On specifying the parameter, the parameter description appears corresponding to the Parameter Name field.	Yes
Parameter Value	Used to specify the value for the parameter. Note: You can specify any special characters except ampersand (&), comma (,), underscore (_), equal to (=), tilde (~), and semi-colon(;), in the parameter value.	Yes

- **Criteria** — Used to define criteria for the rule. This section contains the following columns:

Column Name	Column Description	Mandatory (Yes or No)
Sequence Number	Used to indicate the order in which the criteria should be executed in the rule.	Yes

Column Name	Column Description	Mandatory (Yes or No)						
Parameter Name	<p>Used to indicate whether you want to specify a field or an algorithm as an input parameter. The valid values are:</p> <ul style="list-style-type: none"> • Field • Algorithm <p>Note:</p> <p>By default, the Field option is selected.</p> <p>If a business label is defined for a user defined field (that you have selected), the business label appears in the Parameter Name field.</p> <table border="1" data-bbox="586 638 1252 1352"> <thead> <tr> <th data-bbox="586 638 773 785">If the parameter name is selected as ...</th> <th data-bbox="773 638 1252 785">Then...</th> </tr> </thead> <tbody> <tr> <td data-bbox="586 785 773 1066">Field</td> <td data-bbox="773 785 1252 1066"> <p>The Search (🔍) icon appears corresponding to this field. On clicking the Search icon, the Search Input or Output Parameter window appears.</p> <p>On specifying the field, the field description appears corresponding to the Parameter Name field.</p> </td> </tr> <tr> <td data-bbox="586 1066 773 1352">Algorithm</td> <td data-bbox="773 1066 1252 1352"> <p>The Search (🔍) icon appears corresponding to this field. On clicking the Search icon, the Algorithm Search window appears.</p> <p>On specifying the algorithm, the algorithm description appears corresponding to the Parameter Name field.</p> </td> </tr> </tbody> </table>	If the parameter name is selected as ...	Then...	Field	<p>The Search (🔍) icon appears corresponding to this field. On clicking the Search icon, the Search Input or Output Parameter window appears.</p> <p>On specifying the field, the field description appears corresponding to the Parameter Name field.</p>	Algorithm	<p>The Search (🔍) icon appears corresponding to this field. On clicking the Search icon, the Algorithm Search window appears.</p> <p>On specifying the algorithm, the algorithm description appears corresponding to the Parameter Name field.</p>	Yes
If the parameter name is selected as ...	Then...							
Field	<p>The Search (🔍) icon appears corresponding to this field. On clicking the Search icon, the Search Input or Output Parameter window appears.</p> <p>On specifying the field, the field description appears corresponding to the Parameter Name field.</p>							
Algorithm	<p>The Search (🔍) icon appears corresponding to this field. On clicking the Search icon, the Algorithm Search window appears.</p> <p>On specifying the algorithm, the algorithm description appears corresponding to the Parameter Name field.</p>							
Operator	Used to specify the relational operator to define the relation between the parameter name and value.	Yes						

Column Name	Column Description	Mandatory (Yes or No)						
Parameter Value	<p>Used to specify the parameter value. The valid values are:</p> <ul style="list-style-type: none"> • Field • Algorithm <p>Note:</p> <p>By default, the Field option is selected.</p> <p>You can specify any special characters except ampersand (&), comma (,), underscore (_), equal to (=), tilde (~), and semi-colon(;) in the parameter value.</p> <table border="1" data-bbox="586 604 1252 1318"> <thead> <tr> <th data-bbox="586 604 773 751">If the parameter value is selected as ...</th> <th data-bbox="773 604 1252 751">Then...</th> </tr> </thead> <tbody> <tr> <td data-bbox="586 751 773 1035">Field</td> <td data-bbox="773 751 1252 1035"> <p>The Search (🔍) icon appears corresponding to this field. On clicking the Search icon, the Search Input or Output Parameter window appears.</p> <p>On specifying the field, the field description appears corresponding to the Parameter Value field.</p> </td> </tr> <tr> <td data-bbox="586 1035 773 1318">Algorithm</td> <td data-bbox="773 1035 1252 1318"> <p>The Search (🔍) icon appears corresponding to this field. On clicking the Search icon, the Algorithm Search window appears.</p> <p>On specifying the algorithm, the algorithm description appears corresponding to the Parameter Value field.</p> </td> </tr> </tbody> </table>	If the parameter value is selected as ...	Then...	Field	<p>The Search (🔍) icon appears corresponding to this field. On clicking the Search icon, the Search Input or Output Parameter window appears.</p> <p>On specifying the field, the field description appears corresponding to the Parameter Value field.</p>	Algorithm	<p>The Search (🔍) icon appears corresponding to this field. On clicking the Search icon, the Algorithm Search window appears.</p> <p>On specifying the algorithm, the algorithm description appears corresponding to the Parameter Value field.</p>	Yes
If the parameter value is selected as ...	Then...							
Field	<p>The Search (🔍) icon appears corresponding to this field. On clicking the Search icon, the Search Input or Output Parameter window appears.</p> <p>On specifying the field, the field description appears corresponding to the Parameter Value field.</p>							
Algorithm	<p>The Search (🔍) icon appears corresponding to this field. On clicking the Search icon, the Algorithm Search window appears.</p> <p>On specifying the algorithm, the algorithm description appears corresponding to the Parameter Value field.</p>							
Is True	<p>Used to indicate what should happen when the condition is true (satisfied). The valid values are:</p> <ul style="list-style-type: none"> • Check next condition — Used to indicate that the condition with consecutive sequence number should be executed. • Rule is false — Used to indicate that the action specified in the Rule False Action field should be executed. • Rule is true — Used to indicate that the action specified in the Rule True Action field should be executed. 	Yes						

Column Name	Column Description	Mandatory (Yes or No)
Is False	Used to indicate what should happen when the condition is false (not satisfied). The valid values are: <ul style="list-style-type: none"> • Check next condition — Used to indicate that the condition with consecutive sequence number should be executed. • Rule is false — Used to indicate that the action specified in the Rule False Action field should be executed. • Rule is true — Used to indicate that the action specified in the Rule True Action field should be executed. 	Yes
Is Insufficient	Used to indicate what should happen when the data is insufficient. The valid values are: <ul style="list-style-type: none"> • Check next condition — Used to indicate that the condition with consecutive sequence number should be executed. • Rule is false — Used to indicate that the action specified in the Rule False Action field should be executed. • Rule is true — Used to indicate that the action specified in the Rule True Action field should be executed. 	Yes

Tip: Alternatively, you can access the **Add Rule** screen by clicking the **Add** link in the upper right corner of the **Search** zone in the **Rule** screen.

4. Enter the required details.

Note:

You can search for a parameter, dependent rule and an algorithm by clicking the **Search** (🔍) icon corresponding to the respective field.

If you want to associate more than one output parameter with the rule or define more than one criteria for the rule, click the **Add** (+) icon and then specify the details. However, if you want to remove an output parameter or a criteria from the rule, click the **Delete** (🗑️) icon corresponding to it.

5. Click **Save**.

The rule is defined.

Related Topics

For more information on...	See...
Rule screen	Rule on page 1101
Search zone	Search Rule on page 1101

Editing a Rule

Prerequisites

To edit a rule, you should have:

- Pre-processing and post-processing algorithms, dependent rules, and parameters defined in the application in case you want to use any of them.

Procedure

To edit a rule:

1. Search for the rule in the **Rule** screen.
2. In the **Search Results** section, click the **Edit**  icon in the **Edit** column corresponding to the rule whose details you want to edit.

The **Rule** screen appears. It contains the following fields:

Field Name	Field Description	Mandatory (Yes or No)
Rule	Used to specify the rule code.	Yes
Rule Type	Used to specify the type of rule.	Yes
Description	Used to specify the description for the rule.	Yes
Rule Priority	Used to specify the priority of the rule.	Yes
	Note: You cannot define two rules with the same rule type and priority in the same duration.	
Effective Start Date	Used to specify the date from when the rule is effective.	Yes
Effective End Date	Used to specify the date till when the rule is effective.	No
	Note: The effective end date cannot be earlier than the effective start date.	
Pre-Processing Algorithm	Used to specify the algorithm that will be triggered before executing the criteria in the rule. It pre-processes the input parameters and then returns processed values against which the criteria is validated.	No
	Note: The Search  icon appears corresponding to this field. On clicking the Search icon, the Algorithm Search window appears. On specifying the algorithm, the description of the algorithm appears corresponding to the Pre-Processing Algorithm field.	

Field Name	Field Description	Mandatory (Yes or No)
Post-Processing Algorithm	<p>Used to specify the algorithm that will be triggered when the rule is true. It post-processes the output parameters and returns the updated values to the calling programs or dependent rules.</p> <p>Note:</p> <p>The Search (🔍) icon appears corresponding to this field. On clicking the Search icon, the Algorithm Search window appears.</p> <p>On specifying the algorithm, the description of the algorithm appears corresponding to the Post-Processing Algorithm field.</p>	No
Rule True Action	<p>Used to indicate what should happen when all conditions in the rule are satisfied and returns Rule is True. The valid values are:</p> <ul style="list-style-type: none"> • Next Dependent Rule — Used to indicate that the dependent rule should be executed when the rule is true. • Next Rule by Priority — Used to indicate that the rule of the same rule type having lower priority should be executed when the rule is true. • Success — Used to indicate that no more rules should be executed when the rule is true. The output parameters and their values are returned to the calling programs. 	Yes
Dependent Rule	<p>Used to specify the next dependent rule that must be executed when Next Dependent Rule is selected from the Rule True Action list.</p>	<p>Yes (Conditional)</p> <p>Note: This field is required when you select Next Dependent Rule from the Rule True Action list.</p>
Rule False Action	<p>Used to indicate what should happen when any of the criteria in the rule is not satisfied and returns Rule is False. The valid values are:</p> <ul style="list-style-type: none"> • Next Dependent Rule — Used to indicate that the dependent rule should be executed when the rule is false. • Next Rule by Priority — Used to indicate that the rule of the same rule type having lower priority should be executed when the rule is false. • Success — Used to indicate that no more rules should be executed when the rule is false. The output parameters and their values are returned to the calling programs. 	Yes

Field Name	Field Description	Mandatory (Yes or No)
Dependent Rule	Used to specify the next dependent rule that must be executed when Next Dependent Rule is selected from the Rule False Action list.	Yes (Conditional) Note: This field is required when you select Next Dependent Rule from the Rule False Action list.







In addition, it contains the following two sections:

- **Rule Output Parameters** — Used to specify the output parameters that must be returned to the calling programs or dependent rules when all conditions in the rule are satisfied. This section contains the following columns:

Column Name	Column Description	Mandatory (Yes or No)
Parameter Name	Used to specify the parameter. Note: For more information about the output parameters that you can specify while defining a rule, see Transaction Validation and Initial Price Item Determination . The Search (🔍) icon appears corresponding to this field. On clicking the Search icon, the Search Rule Type Field window appears. On specifying the rule type field, the description of the rule type field appears corresponding to the Parameter Name field.	Yes
Parameter Value	Used to specify the value for the parameter. Note: You can specify any special characters except ampersand (&), comma (,), underscore (_), equal to (=), tilde (~), and semi-colon(;) in the parameter value.	Yes

- **Criteria** — Used to define criteria for the rule. This section contains the following columns:

Column Name	Column Description	Mandatory (Yes or No)
Sequence Number	Used to indicate the order in which the criteria should be executed in the rule.	Yes

Column Name	Column Description	Mandatory (Yes or No)						
Parameter Name	<p>Used to indicate whether you want to specify a field or an algorithm as an input parameter. The valid values are:</p> <ul style="list-style-type: none"> • Field • Algorithm <p>Note:</p> <p>By default, the Field option is selected.</p> <p>If a business label is defined for a user defined field (that you have selected), the business label appears in the Parameter Name field.</p> <table border="1" data-bbox="602 638 1263 1381"> <thead> <tr> <th data-bbox="602 638 769 814">If the parameter name is selected as ...</th> <th data-bbox="769 638 1263 814">Then...</th> </tr> </thead> <tbody> <tr> <td data-bbox="602 814 769 1100">Field</td> <td data-bbox="769 814 1263 1100"> <p>The Search  icon appears corresponding to this field. On clicking the Search icon, the Search Input or Output Parameter window appears.</p> <p>On specifying the field, the field description appears corresponding to the Parameter Name field.</p> </td> </tr> <tr> <td data-bbox="602 1100 769 1381">Algorithm</td> <td data-bbox="769 1100 1263 1381"> <p>The Search  icon appears corresponding to this field. On clicking the Search icon, the Algorithm Search window appears.</p> <p>On specifying the algorithm, the algorithm description appears corresponding to the Parameter Name field.</p> </td> </tr> </tbody> </table>	If the parameter name is selected as ...	Then...	Field	<p>The Search  icon appears corresponding to this field. On clicking the Search icon, the Search Input or Output Parameter window appears.</p> <p>On specifying the field, the field description appears corresponding to the Parameter Name field.</p>	Algorithm	<p>The Search  icon appears corresponding to this field. On clicking the Search icon, the Algorithm Search window appears.</p> <p>On specifying the algorithm, the algorithm description appears corresponding to the Parameter Name field.</p>	Yes
If the parameter name is selected as ...	Then...							
Field	<p>The Search  icon appears corresponding to this field. On clicking the Search icon, the Search Input or Output Parameter window appears.</p> <p>On specifying the field, the field description appears corresponding to the Parameter Name field.</p>							
Algorithm	<p>The Search  icon appears corresponding to this field. On clicking the Search icon, the Algorithm Search window appears.</p> <p>On specifying the algorithm, the algorithm description appears corresponding to the Parameter Name field.</p>							
Operator	Used to specify the relational operator to define the relation between the parameter name and value.	Yes						

Column Name	Column Description	Mandatory (Yes or No)						
Parameter Value	<p>Used to specify the parameter value. The valid values are:</p> <ul style="list-style-type: none"> • Field • Algorithm <p>Note:</p> <p>By default, the Field option is selected.</p> <p>You can specify any special characters except ampersand (&), comma (,), underscore (_), equal to (=), tilde (~), and semi-colon(;) in the parameter value.</p> <table border="1" data-bbox="602 606 1263 1318"> <thead> <tr> <th data-bbox="602 606 764 785">If the parameter value is selected as ...</th> <th data-bbox="764 606 1263 785">Then...</th> </tr> </thead> <tbody> <tr> <td data-bbox="602 785 764 1066">Field</td> <td data-bbox="764 785 1263 1066"> <p>The Search (🔍) icon appears corresponding to this field. On clicking the Search icon, the Search Input or Output Parameter window appears.</p> <p>On specifying the field, the field description appears corresponding to the Parameter Value field.</p> </td> </tr> <tr> <td data-bbox="602 1066 764 1318">Algorithm</td> <td data-bbox="764 1066 1263 1318"> <p>The Search (🔍) icon appears corresponding to this field. On clicking the Search icon, the Algorithm Search window appears.</p> <p>On specifying the algorithm, the algorithm description appears corresponding to the Parameter Value field.</p> </td> </tr> </tbody> </table>	If the parameter value is selected as ...	Then...	Field	<p>The Search (🔍) icon appears corresponding to this field. On clicking the Search icon, the Search Input or Output Parameter window appears.</p> <p>On specifying the field, the field description appears corresponding to the Parameter Value field.</p>	Algorithm	<p>The Search (🔍) icon appears corresponding to this field. On clicking the Search icon, the Algorithm Search window appears.</p> <p>On specifying the algorithm, the algorithm description appears corresponding to the Parameter Value field.</p>	Yes
If the parameter value is selected as ...	Then...							
Field	<p>The Search (🔍) icon appears corresponding to this field. On clicking the Search icon, the Search Input or Output Parameter window appears.</p> <p>On specifying the field, the field description appears corresponding to the Parameter Value field.</p>							
Algorithm	<p>The Search (🔍) icon appears corresponding to this field. On clicking the Search icon, the Algorithm Search window appears.</p> <p>On specifying the algorithm, the algorithm description appears corresponding to the Parameter Value field.</p>							
Is True	<p>Used to indicate what should happen when the condition is true (satisfied). The valid values are:</p> <ul style="list-style-type: none"> • Check next condition — Used to indicate that the condition with consecutive sequence number should be executed. • Rule is false — Used to indicate that the action specified in the Rule False Action field should be executed. • Rule is true — Used to indicate that the action specified in the Rule True Action field should be executed. 	Yes						

Column Name	Column Description	Mandatory (Yes or No)
Is False	Used to indicate what should happen when the condition is false (not satisfied). The valid values are: <ul style="list-style-type: none"> • Check next condition — Used to indicate that the condition with consecutive sequence number should be executed. • Rule is false — Used to indicate that the action specified in the Rule False Action field should be executed. • Rule is true — Used to indicate that the action specified in the Rule True Action field should be executed. 	Yes
Is Insufficient	Used to indicate what should happen when the data is insufficient. The valid values are: <ul style="list-style-type: none"> • Check next condition — Used to indicate that the condition with consecutive sequence number should be executed. • Rule is false — Used to indicate that the action specified in the Rule False Action field should be executed. • Rule is true — Used to indicate that the action specified in the Rule True Action field should be executed. 	Yes

Tip: Alternatively, you can access the **Edit Rule** screen by clicking the **Edit** link in the **View Rule** screen.

3. Modify the required details.

Note: You can search for a parameter, dependent rule and an algorithm by clicking the **Search** (🔍) icon corresponding to the respective field.

4. Add or remove output parameters or criteria from the rule, if required.

Note: If you want to associate more than one output parameter with the rule or define more than one criteria for the rule, click the **Add** (+) icon and then specify the details. However, if you want to remove an output parameter or a criteria from the rule, click the **Delete** (🗑️) icon corresponding to it.

5. Click **Save**.

The changes made to the rule are saved.

Related Topics

For more information on...	See...
Rule screen	Rule on page 1101
Search zone	Search Rule on page 1101

Deleting a Rule

Procedure

To delete a rule:

1. Search for the rule in the **Rule** screen.

- In the **Search Results** section, click the **Delete** () icon in the **Delete** column corresponding to the rule that you want to delete.

A message appears confirming whether you want to delete the rule.

Note: You can delete a rule when it is not yet used in the system.

- Click **OK**.

The rule is deleted.

Related Topics

For more information on...	See...
Rule screen	Rule on page 1101
Search zone	Search Rule on page 1101

Copying a Rule

Instead of creating a rule from scratch, you can also create a new rule using an existing rule. You can do this by copying a rule. When you copy a rule, the output parameters and criteria defined for the original rule are copied to the new rule. You can then add or remove parameters or criteria from the new rule.

Prerequisites

To copy a rule, you should have:

- Rule (whose copy you want to create) defined in the application
- Preprocessing and postprocessing algorithms, dependent rules, and parameters defined in the application in case you want to use any of them

Procedure

To copy a rule:

- Search for the rule in the **Rule** screen.
- In the **Search Results** section, click the **Copy** () icon corresponding to the rule whose copy you want to create.

The **Rule** screen appears. It contains the following fields:

Field Name	Field Description	Mandatory (Yes or No)
Rule	Used to specify the rule code.	Yes
Rule Type	Used to specify the type of rule.	Yes
Description	Used to specify the description for the rule.	Yes
Rule Priority	Used to specify the priority of the rule.	Yes
	Note: You cannot define two rules with the same rule type and priority in the same duration.	
Effective Start Date	Used to specify the date from when the rule is effective.	Yes

Field Name	Field Description	Mandatory (Yes or No)
Effective End Date	Used to specify the date till when the rule is effective.	No
	Note: The effective end date cannot be earlier than the effective start date.	
Pre-Processing Algorithm	Used to specify the algorithm that will be triggered before executing the criteria in the rule. It pre-processes the input parameters and then returns processed values against which the criteria is validated.	No
	Note: The Search (🔍) icon appears corresponding to this field. On clicking the Search icon, the Algorithm Search window appears. On specifying the algorithm, the description of the algorithm appears corresponding to the Pre-Processing Algorithm field.	
Post-Processing Algorithm	Used to specify the algorithm that will be triggered when the rule is true. It post-processes the output parameters and returns the updated values to the calling programs or dependent rules.	No
	Note: The Search (🔍) icon appears corresponding to this field. On clicking the Search icon, the Algorithm Search window appears. On specifying the algorithm, the description of the algorithm appears corresponding to the Post-Processing Algorithm field.	
Rule True Action	Used to indicate what should happen when all conditions in the rule are satisfied and returns Rule is True . The valid values are: <ul style="list-style-type: none"> • Next Dependent Rule — Used to indicate that the dependent rule should be executed when the rule is true. • Next Rule by Priority — Used to indicate that the rule of the same rule type having lower priority should be executed when the rule is true. • Success — Used to indicate that no more rules should be executed when the rule is true. The output parameters and their values are returned to the calling programs. 	Yes
Dependent Rule	Used to specify the next dependent rule that must be executed when Next Dependent Rule is selected from the Rule True Action list.	Yes (Conditional)
		Note: This field is required when you select Next Dependent Rule from the Rule True Action list.

Field Name	Field Description	Mandatory (Yes or No)
Rule False Action	Used to indicate what should happen when any of the criteria in the rule is not satisfied and returns Rule is False . The valid values are: <ul style="list-style-type: none"> • Next Dependent Rule — Used to indicate that the dependent rule should be executed when the rule is false. • Next Rule by Priority — Used to indicate that the rule of the same rule type having lower priority should be executed when the rule is false. • Success — Used to indicate that no more rules should be executed when the rule is false. The output parameters and their values are returned to the calling programs. 	Yes
Dependent Rule	Used to specify the next dependent rule that must be executed when Next Dependent Rule is selected from the Rule False Action list.	Yes (Conditional) Note: This field is required when you select Next Dependent Rule from the Rule False Action list.

In addition, it contains the following two sections:

- **Rule Output Parameters** — Used to specify the output parameters that must be returned to the calling programs or dependent rules when all conditions in the rule are satisfied. This section contains the following columns:

Column Name	Column Description	Mandatory (Yes or No)
Parameter Name	Used to specify the parameter. Note: For more information about the output parameters that you can specify while defining a rule, see Transaction Validation and Initial Price Item Determination . The Search (🔍) icon appears corresponding to this field. On clicking the Search icon, the Search Rule Type Field window appears. On specifying the rule type field, the description of the rule type field appears corresponding to the Parameter Name field.	Yes
Parameter Value	Used to specify the value for the parameter. Note: You can specify any special characters except ampersand (&), comma (,), underscore (_), equal to (=), tilde (~), and semi-colon(;). in the parameter value.	Yes

- **Criteria** — Used to define criteria for the rule. This section contains the following columns:

Column Name	Column Description	Mandatory (Yes or No)						
Sequence Number	Used to indicate the order in which the criteria should be executed in the rule.	Yes						
Parameter Name	<p>Used to indicate whether you want to specify a field or an algorithm as an input parameter. The valid values are:</p> <ul style="list-style-type: none"> • Field • Algorithm <p>Note: By default, the Field option is selected. If a business label is defined for a user defined field (that you have selected), the business label appears in the Parameter Name field.</p> <table border="1" data-bbox="594 720 1224 1499"> <thead> <tr> <th data-bbox="594 720 769 898">If the parameter name is selected as ...</th> <th data-bbox="769 720 1224 898">Then...</th> </tr> </thead> <tbody> <tr> <td data-bbox="594 898 769 1182">Field</td> <td data-bbox="769 898 1224 1182"> <p>The Search (🔍) icon appears corresponding to this field. On clicking the Search icon, the Search Input or Output Parameter window appears.</p> <p>On specifying the field, the field description appears corresponding to the Parameter Name field.</p> </td> </tr> <tr> <td data-bbox="594 1182 769 1499">Algorithm</td> <td data-bbox="769 1182 1224 1499"> <p>The Search (🔍) icon appears corresponding to this field. On clicking the Search icon, the Algorithm Search window appears.</p> <p>On specifying the algorithm, the algorithm description appears corresponding to the Parameter Name field.</p> </td> </tr> </tbody> </table>	If the parameter name is selected as ...	Then...	Field	<p>The Search (🔍) icon appears corresponding to this field. On clicking the Search icon, the Search Input or Output Parameter window appears.</p> <p>On specifying the field, the field description appears corresponding to the Parameter Name field.</p>	Algorithm	<p>The Search (🔍) icon appears corresponding to this field. On clicking the Search icon, the Algorithm Search window appears.</p> <p>On specifying the algorithm, the algorithm description appears corresponding to the Parameter Name field.</p>	Yes
If the parameter name is selected as ...	Then...							
Field	<p>The Search (🔍) icon appears corresponding to this field. On clicking the Search icon, the Search Input or Output Parameter window appears.</p> <p>On specifying the field, the field description appears corresponding to the Parameter Name field.</p>							
Algorithm	<p>The Search (🔍) icon appears corresponding to this field. On clicking the Search icon, the Algorithm Search window appears.</p> <p>On specifying the algorithm, the algorithm description appears corresponding to the Parameter Name field.</p>							
Operator	Used to specify the relational operator to define the relation between the parameter name and value.	Yes						

Column Name	Column Description	Mandatory (Yes or No)						
Parameter Value	<p>Used to specify the parameter value. The valid values are:</p> <ul style="list-style-type: none"> Field Algorithm <p>Note: By default, the Field option is selected.</p> <p>You can specify any special characters except ampersand (&), comma (,), underscore (_), equal to (=), tilde (~), and semi-colon(;), in the parameter value.</p> <table border="1" data-bbox="597 604 1222 1381"> <thead> <tr> <th data-bbox="597 604 769 785">If the parameter value is selected as ...</th> <th data-bbox="769 604 1222 785">Then...</th> </tr> </thead> <tbody> <tr> <td data-bbox="597 785 769 1066">Field</td> <td data-bbox="769 785 1222 1066"> <p>The Search (🔍) icon appears corresponding to this field. On clicking the Search icon, the Search Input or Output Parameter window appears.</p> <p>On specifying the field, the field description appears corresponding to the Parameter Value field.</p> </td> </tr> <tr> <td data-bbox="597 1066 769 1381">Algorithm</td> <td data-bbox="769 1066 1222 1381"> <p>The Search (🔍) icon appears corresponding to this field. On clicking the Search icon, the Algorithm Search window appears.</p> <p>On specifying the algorithm, the algorithm description appears corresponding to the Parameter Value field.</p> </td> </tr> </tbody> </table>	If the parameter value is selected as ...	Then...	Field	<p>The Search (🔍) icon appears corresponding to this field. On clicking the Search icon, the Search Input or Output Parameter window appears.</p> <p>On specifying the field, the field description appears corresponding to the Parameter Value field.</p>	Algorithm	<p>The Search (🔍) icon appears corresponding to this field. On clicking the Search icon, the Algorithm Search window appears.</p> <p>On specifying the algorithm, the algorithm description appears corresponding to the Parameter Value field.</p>	Yes
If the parameter value is selected as ...	Then...							
Field	<p>The Search (🔍) icon appears corresponding to this field. On clicking the Search icon, the Search Input or Output Parameter window appears.</p> <p>On specifying the field, the field description appears corresponding to the Parameter Value field.</p>							
Algorithm	<p>The Search (🔍) icon appears corresponding to this field. On clicking the Search icon, the Algorithm Search window appears.</p> <p>On specifying the algorithm, the algorithm description appears corresponding to the Parameter Value field.</p>							
Is True	<p>Used to indicate what should happen when the condition is true (satisfied). The valid values are:</p> <ul style="list-style-type: none"> Check next condition — Used to indicate that the condition with consecutive sequence number should be executed. Rule is false — Used to indicate that the action specified in the Rule False Action field should be executed. Rule is true — Used to indicate that the action specified in the Rule True Action field should be executed. 	Yes						

Column Name	Column Description	Mandatory (Yes or No)
Is False	Used to indicate what should happen when the condition is false (not satisfied). The valid values are: <ul style="list-style-type: none"> • Check next condition — Used to indicate that the condition with consecutive sequence number should be executed. • Rule is false — Used to indicate that the action specified in the Rule False Action field should be executed. • Rule is true — Used to indicate that the action specified in the Rule True Action field should be executed. 	Yes
Is Insufficient	Used to indicate what should happen when the data is insufficient. The valid values are: <ul style="list-style-type: none"> • Check next condition — Used to indicate that the condition with consecutive sequence number should be executed. • Rule is false — Used to indicate that the action specified in the Rule False Action field should be executed. • Rule is true — Used to indicate that the action specified in the Rule True Action field should be executed. 	Yes

3. Modify the required details.
4. Add or remove the output parameters or criteria from the new rule, if required.

Note:

You can specify any special characters except ampersand (&), comma (,), underscore (_), equal to (=), tilde (~), and semi-colon(:) in the parameter value.

You can search for a parameter, dependent rule and an algorithm by clicking the **Search** (🔍) icon corresponding to the respective field.

If you want to associate more than one output parameter with the rule or define more than one criteria for the rule, click the **Add** (+) icon and then specify the details. However, if you want to remove an output parameter or a criteria from the rule, click the **Delete** (🗑️) icon corresponding to it. For more information on the output parameters that you can specify while defining a rule, see [Transaction Validation and Initial Price Item Determination](#).

5. Click **Save**.

The new rule is defined.

Related Topics

For more information on...	See...
Rule screen	Rule on page 1101
Search zone	Search Rule on page 1101

For more information on...	See...
How to define a rule	Defining a Rule on page 1103

Rule

The **Rule** screen allows you to view the details of a rule. This screen consists of the following zones:

- [Rule Information](#) on page 1122

Rule Information

The **Rule Information** zone displays information about the rule. This zone contains the following fields:

Field Name	Field Description
Rule	Displays the rule code.
Rule Type	Indicates the type of rule.
Description	Displays the description of the rule.
Rule Priority	Indicates the priority of the rule. Note: You can use the Move Up (↑) and Move Down (↓) icons corresponding to this field to view the details of a rule (having the same rule type) with a higher or lower priority. Note that this functionality is available when you access the View Rule screen through the Rule screen.
Effective Start Date	Displays the date from when the rule is effective.
Effective End Date	Displays the date till when the rule is effective.
Pre-Processing Algorithm	Indicates the algorithm that will be triggered before executing the criteria in the rule. It pre-processes the input parameters and then returns processed values against which the criteria is validated.
Post-Processing Algorithm	Indicates the algorithm that will be triggered after executing the criteria in the rule. It post-processes the output parameters and returns the updated values to the calling programs or dependent rules.
Rule True Action	Indicates what should happen when all conditions in the rule are satisfied and returns Rule is True .
Dependent Rule	Indicates the next dependent rule that must be executed when Next Dependent Rule is selected from the Rule True Action list.
Rule False Action	Indicates what should happen when any of the criteria in the rule is not satisfied and returns Rule is False .
Dependent Rule	Indicates the next dependent rule that must be executed when Next Dependent Rule is selected from the Rule False Action list.

In addition, it contains the following two sections:

- **Rule Output Parameters** — Lists the output parameters that must be returned to the calling programs or dependent rules when all conditions in the rule are satisfied. This section contains the following columns:

Column Name	Column Description
Parameter Name	Displays the name of the parameter. In addition, this column has a context menu which helps in navigating to the Field screen.
Parameter Value	Displays the value of the parameter.

- **Criteria** — Lists the criteria defined in the rule. This section contains the following columns:

Column Name	Column Description
Sequence Number	Indicates the order in which the criteria should be executed in the rule.
Parameter Type	Indicates whether the input parameter is a field or an algorithm.
Parameter Name	Displays the field or algorithm name which is used as an input parameter.
Operator	Indicates the relational operator used to define the relation between the parameter name and value.
Parameter Value	Displays the parameter value.
Is True	Indicates what should happen when the condition is true (satisfied). The valid values are: <ul style="list-style-type: none"> • Check next condition — Indicates that the condition with consecutive sequence number should be executed. • Rule is false — Indicates that the action specified in the Rule False Action field should be executed. • Rule is true — Indicates that the action specified in the Rule True Action field should be executed.
Is False	Indicates what should happen when the condition is false (not satisfied). The valid values are: <ul style="list-style-type: none"> • Check next condition — Indicates that the condition with consecutive sequence number should be executed. • Rule is false — Indicates that the action specified in the Rule False Action field should be executed. • Rule is true — Indicates that the action specified in the Rule True Action field should be executed.
Is Insufficient	Indicates what should happen when the data is insufficient. The valid values are: <ul style="list-style-type: none"> • Check next condition — Indicates that the condition with consecutive sequence number should be executed. • Rule is false — Indicates that the action specified in the Rule False Action field should be executed. • Rule is true — Indicates that the action specified in the Rule True Action field should be executed.

The **Edit** link appears in the upper-right corner of the **Rule Information** zone. On clicking the **Edit** link, the **Edit Rule** screen appears where you can edit the details of the rule.

Related Topics

For more information on...	See...
How to view the details of a rule	Viewing the Rule Details on page 1103

Viewing the Rule Details

Procedure

To view the details of a rule:

1. Search for the rule in the **Rule** screen.
2. In the **Search Results** section, click the **View** () icon in the **View** column corresponding to the rule whose details you want to view.

The **View Rule** screen appears.

3. View the details of the rule in the **Rule Information** zone.

Related Topics

For more information on...	See...
View Rule screen	Rule on page 1122
Rule Information zone	Rule Information on page 1122
How to search for a rule	Searching for a Rule Type on page 1084

Rule Check

The **Rule Check** screen allows you to validate whether rules of a particular rule type are executed as expected. On validating, it indicates the sequence in which all effective rules were executed, the total execution time, and the output parameters of the rule that was successfully executed. This screen consists of the following sections:

- Rule Type Input Parameters
- Rule Output Parameters
- Rule Execution

Rule Type Input Parameters

The **Rule Type Input Parameters** section contains the following fields:

Field Name	Field Description	Mandatory (Yes or No)
Rule Type	Used to specify the rule type.	Yes
Effective Date	Used when you want to execute the rules which are effective on a particular date.	No
	Note: If you do not specify the effective date, the system executes all rules which are effective on the system date.	

Field Name	Field Description	Mandatory (Yes or No)
Parameter Name	Indicates the input parameter.	Not applicable
	Note: The input parameters listed change depending on the rule type that you have selected.	
Parameter Value	Used to specify the value for the input parameter.	Yes

In addition, this section contains the **Check Rule** button. On clicking the button, you can validate the sequence in which the rules with the specified rule type are executed.

Rule Output Parameters

The **Rule Output Parameters** section contains the following fields:

Field Name	Field Description
Status	Displays the status of the rule execution. The valid values are: <ul style="list-style-type: none"> • Success — Indicates that one of the rule was successfully executed and returned the output parameters. • Fail — Indicates that none of the rules with the specified rule type were successfully executed. • Error — Indicates that an error occurred while executing a rule.
Execution Time	Displays the total time taken to execute all effective rules with the specified rule type.
Error	Displays the error message indicating the error that occurred while executing a rule.
	Note: This field appears when the status is Error .

In addition, this section contains the following columns:

Column Name	Column Description
Parameter Name	Displays the output parameter of the rule that was successfully executed.
Parameter Value	Displays the value of the output parameter.

Rule Execution

The **Rule Execution** section indicates the sequence in which all effective rules with the specified rule type were executed. This section contains the following columns:

Column Name	Column Description
Rule	Indicates the rule that was executed.
Rule Type	Indicates the type of rule.
Rule Priority	Indicates the priority of the rule.
Rule Status	Indicates whether the rule was true or false.
Rule Next Action	Indicates the action that took place when the rule was true or false.

Rule Check

The **Rule Check** zone allows you to validate whether rules of a particular rule type are executed as expected. It indicates the sequence in which all effective rules were executed along with the total execution time. This zone consists of the following sections:

- **Rule Type Input Parameters** — This sections contains the following fields:

Field Name	Field Description	Mandatory (Yes or No)
Rule Type	Used to specify the rule type.	Yes
Effective Date	Used when you want to execute the rules which are effective on a particular date.	No
Parameter Name	Indicates the input parameter.	Not applicable
	Note: The input parameters listed change depending on the rule type that you have selected.	
Parameter Value	Used to specify the value for the input parameter.	Yes

In addition, this section contains the **Check Rule** button. On clicking the button, you can validate the sequence in which the rules with the specified rule type are executed.

- **Rule Output Parameters** — This section contains the following fields:

Field Name	Field Description
Status	Displays the status of the rule execution. The valid values are: <ul style="list-style-type: none"> • Success — Indicates that one of the rule was successfully executed and returned the output parameters. • Fail — Indicates that none of the rules with the specified rule type were successfully executed. • Error — Indicates that an error occurred while executing a rule.
Execution Time	Displays the total time taken to execute a set of rules.
Error	Displays the error message indicating the error that occurred while executing a rule.
	Note: This field appears when the status is Error .

In addition, this section contains the following columns:

Column Name	Column Description
Parameter Name	Displays the output parameter of the rule that was successfully executed.
Parameter Value	Displays the value of the output parameter.

- **Rule Execution** — Indicates the sequence in which the rules with the specified rule type were executed. This section contains the following columns:

Column Name	Column Description
Rule Code	Displays the rule code.
Rule Type	Displays the type of rule.

Column Name	Column Description
Rule Priority	Displays the priority of the rule.
Rule Status Flag	Indicates whether the rule was true or false.
Rule Next Action	Indicates the action that took place when the rule was true or false.

Related Topics

For more information on...	See...
Rule Check screen	Rule Check on page 1124

Chapter 13

Alternate Sequential Bill Numbers

Topics:

- [Alternate Sequential Bill Number Generation Algorithms](#)
- [Enabling the Alternate Sequential Bill Numbers Feature](#)

Each bill is uniquely identified by its bill ID. Bill ID is a random system-generated number. In some locales, bills have an additional identifier known as alternate sequential bill number. Alternate sequential bill numbers are system-generated sequential numbers. For example, the first bill generated by the system is assigned a sequential bill number of 1, the next bill is assigned a value of 2, and so on.

If you want to generate alternate sequential bill numbers for the completed bills, you must select the **Use Sequential Bill Numbers** option in the **Billing** tab of the **Installation Options** screen. You can configure the application to generate alternate sequential bill numbers which are either unique throughout the system or within the division. The **Assign Sequential Bill Numbers (ASSGNSBN)** batch allows you to generate alternate sequential bill numbers for the completed bills. You need to configure this batch such that it is executed at regular intervals. For more information about the batch, refer to *Oracle Revenue Management and Billing Batch Guide*.

Related Topics

For more information on...	See...
How to enable the Alternate Sequential Bill Numbers feature	Enabling the Alternate Sequential Bill Numbers Feature on page 1136

Alternate Sequential Bill Number Generation Algorithms

The following table lists the alternate sequential bill number generation algorithm types which are shipped with the product:

If you want to generate...	Then create an algorithm using the following algorithm type...
Alternate sequential bill numbers unique throughout the system	C1_ALTBLLSYS on page 1130
Alternate sequential bill numbers unique within the division	C1_ALTBLDV on page 1133
Alternate sequential bill numbers unique throughout the system in the required format using a set of parameters	C1_ALTBLSYS1 on page 1130 Note: The alternate sequential bill number will be unique throughout the system when you configure the algorithm parameters appropriately.
Alternate sequential bill numbers unique within the division in the required format using a set of parameters	C1_ALTBLDIV1 on page 1133 Note: The alternate sequential bill number will be unique within the division when you configure the algorithm parameters appropriately.

C1_ALTBLLSYS

The **C1_ALTBLLSYS** algorithm type is used to generate an alternate bill ID for the completed bills. The alternate bill ID is sequenced using the sequence number, and is unique throughout the system. This algorithm type does not have any parameters.

If you attach an algorithm created using the **C1_ALTBLLSYS** algorithm type to the **Sequence Generation Algorithm** field in the **Billing** tab of the **Installation Options** screen, the algorithm is invoked while executing the **Assign Sequential Bill Numbers (ASSGNSBN)** batch.

C1_ALTBLSYS1

The **C1_ALTBLSYS1** algorithm type is used to generate an alternate bill ID for the completed bills. You can generate an alternate bill ID in the required format using the following parameters:

Parameter	Description
'X'	Here, X stands for a separator. For example, ','. The separator must be enclosed within single quotes. It will act as a delimiter in the alternate sequential bill number.
CIS_DIVISION	The division to which the account belongs. It is retrieved from the bill. It should not be more than five characters.
BILL_CYC_CD	The bill cycle of the account for which the bill is generated. It is retrieved from the bill. It should not be more than four characters.

Parameter	Description
ACCT_IDENTIFIER=<Account_Identifier_Type>,<CharStartPosition>,<CharCount>	<p>Here, you need to specify the following information separated by a comma:</p> <ul style="list-style-type: none"> • <Account_Identifier_Type> - Used to indicate the account identifier type whose value must be used to generate the alternate sequential bill number. • <CharStartPosition> - Used to indicate the starting position from where you want to extract the characters from the account identifier. If you do not specify the starting position, by default, it is set to zero (0) (i.e. from the first character). • <CharCount> - Used to indicate the number of characters that you want to extract from the account identifier. If you do not specify the count, by default, it is set to five.
CHARACC=<Characteristic_Type>,<CharStartPosition>,<CharCount>	<p>Here, you need to specify the following information separated by a comma:</p> <ul style="list-style-type: none"> • <Characteristic_Type> - Used to indicate the account's characteristic whose value must be used to generate the alternate sequential bill number. • <CharStartPosition> - Used to indicate the starting position from where you want to extract the characters from the characteristic value. If you do not specify the starting position, by default, it is set to zero (0) (i.e. from the first character). • <CharCount> - Used to indicate the number of characters that you want to extract from the characteristic value. If you do not specify the count, by default, it is set to five. <p>Note: If the same characteristic is defined multiple times for an account, the characteristic value which is effective on the batch business date is considered.</p>

Parameter	Description
CHARPER=<Characteristic_Type>,<CharStartPosition>,<CharCount>	<p>Here, you need to specify the following information separated by a comma:</p> <ul style="list-style-type: none"> • <Characteristic_Type> - Used to indicate the person's characteristic whose value must be used to generate the alternate sequential bill number. • <CharStartPosition> - Used to indicate the starting position from where you want to extract the characters from the characteristic value. If you do not specify the starting position, by default, it is set to zero (0) (i.e. from the first character). • <CharCount> - Used to indicate the number of characters that you want to extract from the characteristic value. If you do not specify the count, by default, it is set to five. <p>Note: If the same characteristic is defined multiple times for a person, the characteristic value which is effective on the batch business date is considered.</p>
BILL_DT=MMddy	<p>The date when the bill is created for the account. It should not be more than six characters. You can use the following patterns in the date format:</p> <ul style="list-style-type: none"> • “yyyy” or “yy” for year • “MM” or “M” for month • “dd” or “d” for day <p>Note: The date format should either start or end with the year.</p>
SEQ_NBR	The sequence number generated by the database. It should not be more than 12 characters.
FIXED_SUFFIX=XX	Here, X stands for a letter or a group of letters that you want to add at the end of the alternate sequential bill number.
LEFT_PADDING_CHAR=ZERO LEFT_PADDING_CHAR=SPACE	Indicates whether you want to add zero or space when the number of characters derived from the account's or person's characteristic value is less than the character count. The padding is added to the left.

You can specify the above mentioned parameters against any of the following parameters available in the **C1_ALTBLSYS1** algorithm type:

- Field1
- Field2
- Field3
- Field4
- Field5
- Field6
- Field7

- Field8
- Field9
- Field10

None of these algorithm type parameters are mandatory. The system will concatenate the parameter values and then generate alternate bill ID in the required format. For example, if you create an algorithm using the following parameters:

- Field1 — CIS_DIVISION
- Field2 — ‘|’
- Field3 — SEQ_NBR
- Field4 — ‘-’
- Field5 — FIXED_SUFFIX=01

In this case, the system will generate the alternate bill ID in the CIS_DIVISION|SEQ_NBR-01 format. For example, DIV1|12345678-01. If you want to generate unique alternate bill ID, we recommend you to use the **SEQ_NBR** parameter while creating an algorithm using the **C1_ALTBLSYS1** algorithm type.

Note that if you do not specify the value for any parameters while creating an algorithm using the **C1_ALTBLSYS1** algorithm type, the system will generate the alternate bill ID using the sequence number.

While specifying the value for these parameters, you need to ensure that the length of the alternate bill ID should not exceed 30 characters. An algorithm named **C1_ALTBLSYS1** is already shipped with the product. You can create custom algorithms using the **C1_ALTBLSYS1** algorithm type to design the required alternate bill ID format using the above mentioned parameters. If you attach an algorithm created using the **C1_ALTBLSYS1** algorithm type to the **Sequence Generation Algorithm** field in the **Billing** tab of the **Installation Options** screen, the algorithm is invoked while executing the **Assign Sequential Bill Numbers (ASSGNSBN)** batch.

C1_ALTBLDV

The **C1_ALTBLDV** algorithm type is used to generate a unique alternate bill ID for the completed bills within the division. For example, two bills (such as B1 and B2) belonging to the same division (such as D1) cannot have the same alternate bill ID. However, two bills (such as B1 and B2) belonging to different divisions, (such as D1 and D2) can have the same alternate bill ID.

This algorithm type contains the following parameter:

Parameter	Description	Mandatory (Yes or No)
Initial Bill Sequence Number	Used to specify the initial alternate bill ID that you want to use while sequencing. Note: If you do not specify any value for this parameter, by default, the system will generate the initial alternate bill ID for sequencing.	No

If you attach an algorithm created using the **C1_ALTBLDV** algorithm type to the **Sequence Generation Algorithm** field in the **Billing** tab of the **Installation Options** screen, the algorithm is invoked while executing the **Assign Sequential Bill Numbers (ASSGNSBN)** batch.

C1_ALTBLDIV1

The **C1_ALTBLDIV1** algorithm type is used to generate an alternate bill ID for the completed bills. You can generate an alternate bill ID in the required format using the following parameters:

Parameter	Description
'X'	Here, X stands for a separator. For example, ','. The separator must be enclosed within single quotes. It will act as a delimiter in the alternate sequential bill number.
CIS_DIVISION	The division to which the account belongs. It is retrieved from the bill. It should not be more than five characters.
BILL_CYC_CD	The bill cycle of the account for which the bill is generated. It is retrieved from the bill. It should not be more than four characters.
ACCT_IDENTIFIER=<Account_Identifier_Type>,<CharStartPosition>,<CharCount>	<p>Here, you need to specify the following information separated by a comma:</p> <ul style="list-style-type: none"> • <Account_Identifier_Type> - Used to indicate the account identifier type whose value must be used to generate the alternate sequential bill number. • <CharStartPosition> - Used to indicate the starting position from where you want to extract the characters from the account identifier. If you do not specify the starting position, by default, it is set to zero (0) (i.e. from the first character). • <CharCount> - Used to indicate the number of characters that you want to extract from the account identifier. If you do not specify the count, by default, it is set to five.
CHARACC=<Characteristic_Type>,<CharStartPosition>,<CharCount>	<p>Here, you need to specify the following information separated by a comma:</p> <ul style="list-style-type: none"> • <Characteristic_Type> - Used to indicate the account's characteristic whose value must be used to generate the alternate sequential bill number. • <CharStartPosition> - Used to indicate the starting position from where you want to extract the characters from the characteristic value. If you do not specify the starting position, by default, it is set to zero (0) (i.e. from the first character). • <CharCount> - Used to indicate the number of characters that you want to extract from the characteristic value. If you do not specify the count, by default, it is set to five.
	<p>Note: If the same characteristic is defined multiple times for an account, the characteristic value which is effective on the batch business date is considered.</p>

Parameter	Description
CHARPER=<Characteristic_Type>,<CharStartPosition>,<CharCount>	<p>Here, you need to specify the following information separated by a comma:</p> <ul style="list-style-type: none"> • <Characteristic_Type> - Used to indicate the person's characteristic whose value must be used to generate the alternate sequential bill number. • <CharStartPosition> - Used to indicate the starting position from where you want to extract the characters from the characteristic value. If you do not specify the starting position, by default, it is set to zero (0) (i.e. from the first character). • <CharCount> - Used to indicate the number of characters that you want to extract from the characteristic value. If you do not specify the count, by default, it is set to five. <p>Note: If the same characteristic is defined multiple times for a person, the characteristic value which is effective on the batch business date is considered.</p>
BILL_DT=MMddy	<p>The date when the bill is created for the account. It should not be more than six characters. You can use the following patterns in the date format:</p> <ul style="list-style-type: none"> • “yyyy” or “yy” for year • “MM” or “M” for month • “dd” or “d” for day <p>Note: The date format should either start or end with the year.</p>
FIXED_SUFFIX=XX	Here, X stands for a letter or a group of letters that you want to add at the end of the alternate sequential bill number.
LEFT_PADDING_CHAR=ZERO LEFT_PADDING_CHAR=SPACE	<p>or</p> <p>Indicates whether you want to add zero or space when the number of characters derived from the account's or person's characteristic value is less than the character count. The padding is added to the left.</p>

You can specify the above mentioned parameters against any of the following parameters available in the **C1_ALTBLDIV1** algorithm type:

- Field1
- Field2
- Field3
- Field4
- Field5
- Field6
- Field7
- Field8
- Field9

- Field10

None of these algorithm type parameters are mandatory. The system will concatenate the parameter values and then generate alternate bill ID in the required format. For example, if you create an algorithm using the following parameters:

- Field1 — CIS_DIVISION
- Field2 — ‘|’
- Field3 — BILL_DT=MMddy
- Field4 — ‘-’
- Field5 — FIXED_SUFFIX=01

In this case, the system will generate the alternate bill ID in the CIS_DIVISION|MMddy-01 format. For example, DIV1|110501-01. Note that if you do not specify the value for any of these algorithm type parameters, the system will not generate the alternate bill ID for the completed bills.

While specifying the value for these parameters, you need to ensure that the length of the alternate bill ID should not exceed 30 characters. An algorithm named **C1_ALTBLDIV1** is already shipped with the product. You can create custom algorithms using the **C1_ALTBLDIV1** algorithm type to design the required alternate bill ID format using the above mentioned parameters. If you attach an algorithm created using the **C1_ALTBLDIV1** algorithm type to the **Sequence Generation Algorithm** field in the **Billing** tab of the **Installation Options** screen, the algorithm is invoked while executing the **Assign Sequential Bill Numbers (ASSGNSBN)** batch.

Enabling the Alternate Sequential Bill Numbers Feature

Prerequisites

To enable the alternate sequential bill numbers feature, you should have:

- An algorithm created using the **C1_ALTBLLSYS**, **C1_ALTBLSYS1**, **C1_ALTBLDV**, or **C1_ALTBLDIV1** algorithm type that you want to use for alternate sequential bill number generation

Procedure

To enable the alternate sequential bill numbers feature:

1. Click the **Admin** link in the **Application** toolbar.

A list appears.

2. From the **Admin** menu, select **I** and then click **Installation Options**.

The **Installation Options** screen appears.

3. Click the **Billing** tab.

The **Billing** tab appears.

4. Select the **Use Sequential Bill Numbers** option to indicate that you want to generate alternate sequential bill numbers for the completed bills.

The **Sequential Invoice** field is enabled.

5. Select the **System-wide** or **Division-specific** option from the **Sequential Invoice** list depending on whether you want alternate sequential bill numbers to be unique throughout the system or within the division.

6. Do either of the following:

If you want to generate...	Then
Alternate sequential bill numbers unique throughout the system	<ol style="list-style-type: none"> 1. Attach an algorithm created using the C1_ALTBLLSYS algorithm type to the Sequence Generation Algorithm field

If you want to generate...	Then
	<p>to indicate how an alternate bill number which is unique throughout the system should be sequenced.</p> <div data-bbox="716 285 1399 394" style="border: 1px solid black; padding: 5px;"> <p>Note: The Sequence Generation Algorithm field is enabled when the System-wide option is selected from the Sequential Invoice list.</p> </div> <ol style="list-style-type: none"> 2. Click the Save button in the Page Title area. The changes made to the installation options are saved.
<p>Alternate sequential bill numbers unique within the division</p>	<ol style="list-style-type: none"> 1. Click the Save button in the Page Title area. The changes made to the installation options are saved. 2. From the Admin menu, select D and then click Division. The Division screen appears. 3. Search for the division, whose accounts' bills should have alternate sequential bill numbers unique within the division. 4. In the Division screen, click the Algorithms tab. The Algorithms tab appears. 5. Select the Sequential Bill Number Generation option from the Division Algorithm Entity list. 6. Enter the sequence number to indicate the order in which the algorithms with the same entity should be executed. 7. Attach an algorithm created using the C1_ALTBLDV algorithm type to the respective field to indicate how an alternate bill number which is unique within the division should be sequenced. 8. Click the Save button in the Page Title area. The changes made to the division are saved.
<p>Alternate sequential bill numbers unique throughout the system in the required format using a set of parameters</p>	<ol style="list-style-type: none"> 1. Attach an algorithm created using the C1_ALTBLSYS1 algorithm type to the Sequence Generation Algorithm field to indicate how an alternate bill number which is unique throughout the system should be generated. <div data-bbox="716 1583 1399 1871" style="border: 1px solid black; padding: 5px;"> <p>Note:</p> <p>The Sequence Generation Algorithm field is enabled when the System-wide option is selected from the Sequential Invoice list.</p> <p>The alternate sequential bill number will be unique throughout the system when you configure the algorithm parameters appropriately.</p> </div> <ol style="list-style-type: none"> 2. Click the Save button in the Page Title area.

If you want to generate...	Then
	The changes made to the installation options are saved.
Alternate sequential bill numbers unique within the division in the required format using a set of parameters	<ol style="list-style-type: none"> <li data-bbox="686 306 1401 380">1. Click the Save button in the Page Title area. The changes made to the installation options are saved. <li data-bbox="686 411 1401 485">2. From the Admin menu, select D and then click Division. The Division screen appears. <li data-bbox="686 516 1401 590">3. Search for the division, whose accounts' bills should have alternate sequential bill numbers unique within the division. <li data-bbox="686 621 1401 695">4. In the Division screen, click the Algorithms tab. The Algorithms tab appears. <li data-bbox="686 726 1401 800">5. Select the Sequential Bill Number Generation option from the Division Algorithm Entity list. <li data-bbox="686 831 1401 905">6. Enter the sequence number to indicate the order in which the algorithms with the same entity should be executed. <li data-bbox="686 936 1401 1041">7. Attach an algorithm created using the C1_ALTBLDIV1 algorithm type to the respective field to indicate how an alternate bill number which is unique within the division should be generated. <div data-bbox="716 1041 1401 1157" style="border: 1px solid black; padding: 5px; margin: 10px 0;"> <p>Note: The alternate sequential bill number will be unique within the division when you configure the algorithm parameters appropriately.</p> </div> <ol style="list-style-type: none"> <li data-bbox="686 1188 1401 1262">8. Click the Save button in the Page Title area. The changes made to the division are saved.

Related Topics

For more information on...	See...
Alternate Sequential Bill Numbers	Alternate Sequential Bill Numbers on page 1129
Alternate Sequential Bill Number Generation Algorithms	Alternate Sequential Bill Number Generation Algorithms on page 1130



Chapter 14

Transaction Feed Management

Topics:

- [Prerequisites](#)
- [Transaction Rating Before Billing](#)
- [Transaction Aggregation](#)
- [Transaction Aggregation Batch Processing](#)
- [Transaction Disaggregation](#)
- [Transaction Disaggregation Batch Processing](#)
- [Reseeding](#)
- [Transaction Cancellation](#)
- [Transaction Cancellation Batch Processing](#)
- [Transaction Rollback](#)
- [Feed Status Transition](#)
- [Transaction Status Transition](#)
- [Transaction Leg Status Transition](#)
- [Transaction Data File](#)
- [Error List](#)
- [Alert Notification for Transaction Feed Management](#)
- [Feed Management Dashboard](#)
- [Transaction Details](#)
- [Transaction Source](#)
- [Transaction Record Type](#)
- [Transaction Aggregation Rule](#)
- [Schedule](#)
- [Disaggregation Request](#)

Oracle Revenue Management and Billing provides you with a facility to upload banking and Administrative Services Only (ASO) transactions received from various product processors or applications for billing. You can use the **File Upload Interface** feature to upload transaction data files in the following formats:

- Comma Separated Values
- JavaScript Object Notation
- Fixed Position
- Pipe Separated Values
- Tilde Separated Values
- Extensible Markup Language

For more information on how to upload the data using the **File Upload Interface** feature, refer to the respective feature documentation. Once the transaction data is uploaded in the system, you need to:

- Validate Header Details
- Validate Transaction Details and Determine Initial Product
- Verify Price Item Pricing
- Rate Transactions Before Billing (if required)
- Create and Update Billable Charge with the SQI values
- Clean-up Unwanted Data

The system provides the flexibility to rate the transactions either prior to billing or during billing. Based on the business requirements, you can configure the system such that transactions mapped to some price item can be rated at a frequency which is different than the account's billing frequency. For example, daily, weekly, etc. During the transaction feed management process, each transaction goes through various statuses until it is billed to the person. For more information about the transaction statuses, see [Transaction Status Transition](#) on page 1195.

The transaction feed management process includes the following sub-processes:

- [Transaction Aggregation](#)
- [Transaction Disaggregation](#) on page 1177
- [Transaction Cancellation](#) on page 1188
- [Transaction Rollback](#) on page 1192

Prerequisites

To setup the transaction feed management process, you need to do the following:

- Define the required transaction sources in the system
- Define the required transaction record types for each transaction source
- Associate the required SQIs with a price item —division combination
- Define the required transaction aggregation rule for each SQI
- Define the aggregation schedules in the system
- Define the required rules in the system to determine initial price item for transactions
- Attach a validation algorithm to each account identifier type (to ensure that the account identifier type and account identifier combination is unique in or across divisions)
- Attach the **Price Assignment Search** algorithm to each division
- Define the **TFM - Processing Date** characteristic for each division
- Create an algorithm of the **C1_CURALGTFM** algorithm type and attach it to the **TFM - Currency Conversion** algorithm spot of the division for which you want to enable the currency conversion feature
- Define the required exchange rates for currency conversion
- Define values for the PAGE_NUMBER lookup field
- Create an algorithm of the **C1_RTCL_POPC** algorithm type and attach it to the **TFM - Rate Post-Processing** algorithm spot of the required division

Besides this, you need to setup the following feature configurations:

- *Rule Engine (C1_RLENG)*
- *Dummy Header (C1-TXNDMYID)*
- *Multi Parameter Based Pricing (C1_PPARAM_FLG)*
- *Feed Management (C1_FM)*

Transaction Rating Before Billing

The system provides the flexibility to rate the transaction legs either prior to billing or during billing. Based on the business requirements, you can configure the system such that transactions mapped to some price items can be rated at a frequency which is different than the account's billing frequency. For example, daily, weekly, etc. This will help to reduce the performance issues which are caused when large volume of transactions are rated at the time of billing.

The system offers the following ways in which a transaction leg can be priced, rated and billed:

1. **Rate the Transaction Leg During Billing** – In this approach, you can use either of the following ways:
 - a. Determine effective pricing for a transaction leg, create a billable charge for the transaction leg, and then determine the rate during billing.
 - b. Determine effective pricing for a transaction leg, create a billable charge for aggregated transaction legs, and then determine the rate during billing.
2. **Rate the Transaction Leg Prior to Billing** – In this approach, you can use either of the following ways:
 - a. Determine effective pricing and rate for a transaction leg, and accumulate pre-calculated charges in a pass through billable charge based on the distribution code, currency code, description on bill, aggregation

parameter group ID (which is created based on the rate component characteristics). The pass through billable charge is then billed during billing.

- b. Determine effective pricing for a transaction leg, aggregate the transaction legs, determine rate for aggregated service quantities, and then accumulate pre-calculated charges in a pass through billable charge based on the distribution code, currency code, description on bill, aggregation parameter group ID (which is created based on the rate component characteristics). The pass through billable charge is then billed during billing.
- c. Determine effective pricing and rate for a transaction leg and create a pass through billable charge for the transaction leg which is billed during billing.

3. Ignore the Transaction Leg for Billing – In this approach, you can use either of the following ways:

- a. Determine effective pricing for a transaction leg, but the billable charge is not created for the transaction leg.
- b. Determine effective pricing and rate for a transaction leg, but the billable charge is not created for the transaction leg.

Note:

Once the rate is determined for transaction legs, a set of rate component characteristics and their values are grouped. For example, if a price assignment has the following rate components, the system creates two groups — Group A and Group B:

- RC1, Char1=Y, Char2=Y
- RC2, Char1=N, Char2=Y
- RC3, Char1=Y, Char2=Y

Group A contains Char1=Y, Char2=Y and Group B contains Char1=N, Char2=Y. These groups are used for accumulating pre-calculated charges. A unique aggregation parameter group ID is generated for each group. If a group with a set of rate component characteristics and their values already exists in the system, a new group is not created. Instead, the existing group is used for accumulating pre-calculated charges. The aggregation parameter group ID is created when you attach an algorithm of the **C1_RTCL_POPC** algorithm type on the **TFM - Rate Post-Processing** algorithm entity in the **Algorithms** tab of the **Division** screen. Note that the system invokes the algorithm which is attached on the derived account's division and not on the division to which the transaction belongs.

While defining a price item pricing, you need to specify the rating criteria which indicates how and when you want to rate the transaction legs. The valid values are:

- Do Not Rate Transactions (DNRT)
- Aggregate transactions and then rate aggregated SQs (AGTR)
- Rate individual transactions and aggregate calc lines across transactions (RITA)
- Rate Transactions (RITX)

Along with the **Rating Criteria** field, the **Ignore Transaction** and **Aggregate Transaction** fields help the system to determine how and when the corresponding transaction leg must be rated. The following table indicates how to configure the system in order to use the above mentioned ways:

Transaction Rating Approach and Way	Ignore Transaction (Yes or No)	Aggregate Transaction (Yes or No)	Rating Criteria	Batch in which the Rate is Determined
3a	Yes	Not applicable	Do Not Rate Transactions (DNRT)	Not applicable because ignored transactions are not considered for billing.

Transaction Rating Approach and Way	Ignore Transaction (Yes or No)	Aggregate Transaction (Yes or No)	Rating Criteria	Batch in which the Rate is Determined
3b	Yes	Not applicable	Rate Transactions (RITX)	Update Status (C1-TXNEX)
1b	No	Yes	Do Not Rate Transactions (DNRT)	Not applicable because the rate is determined during billing.
2b	No	Yes	Aggregate transactions and then rate aggregated SQs (AGTR)	Service Quantity Calculation (C1-TXNSQ)
2a	No	Yes	Rate individual transactions and aggregate calc lines across transactions (RITA)	Update Status (C1-TXNEX)
1a	No	No	Do Not Rate Transactions (DNRT)	Not applicable because the rate is determined during billing.
2c	No	No	Rate Transactions (RITX)	Service Quantity Calculation (C1-TXNSQ)

Let us understand the following transaction rating ways with the help of an example:

- 2a
- 2b
- 2c

The following table lists the account, price item, and price item parameters combination to which transaction T1 and T2 are mapped:

Transaction	Transaction Volume	Transaction Date	Account	Price Item	Price Item Parameter Group ID	Price Assignment ID	Aggregation Schedule
T1	300	01/01/2015	A1	P1	PG1	PA1	Monthly
T1	300	01/01/2015	A2	P1	PG1	PA2	Monthly
T2	200	15/01/2015	A1	P1	PG1	PA1	Monthly
T2	200	15/01/2015	A3	P1	PG1	PA3	Monthly

The following table lists the rate components available on the PA1, PA2, and PA3 price assignments:

Transaction	Price Assignment ID	Rate Component	Currency Code	Distribution Code	Description on Bill	Aggregation Parameter Group ID (Rate Component's Characteristics)
T1	PA1	RC1- 0.1*Transaction Volume	USD	BK-AR1	XYZ	Char1=Y
T1	PA1	RC2- 0.2*Transaction Volume	USD	BK-AR2	ABC	Char2=Y
T1	PA2	RC3- 0.3*Transaction Volume	USD	BK-AR3	XYZ	Char1=Y
T1	PA2	RC4- 0.2*Transaction Volume	USD	BK-AR4	ABC	Char2=Y
T2	PA1	RC1- 0.1*Transaction Volume	USD	BK-AR1	XYZ	Char1=Y
T2	PA1	RC2- 0.2*Transaction Volume	USD	BK-AR2	ABC	Char2=Y
T2	PA3	RC3- 0.3*Transaction Volume	USD	BK-AR3	XYZ	Char1=Y
T2	PA3	RC4- 0.2*Transaction Volume	USD	BK-AR3	XYZ	Char1=Y

Now, if you use **RITA (2a)** approach, the system will rate a transaction leg and accumulate pre-calculated charges in a pass through billable charge based on the distribution code, currency code, description on bill, aggregation parameter group ID, as shown in the following table:

Billable Charge	Start Date	End Date	Transaction Leg	Rate Component	Calculation Details	Pass Through Charge (\$)	Comments
BC1	01/01/2015	31/01/2015	T1– A1P1PG1– PA1, T2– A1P1PG1– PA1	RC1	$300 * 0.1 = 30$, $200 * 0.1 = 20$	$30 + 20 = 50$	The pass through charge is calculated for each transaction leg and then accumulated because the distribution code, currency code, description on bill, and characteristics of the rate components are same.
BC1	01/01/2015	31/01/2015	T1– A1P1PG1– PA1, T2– A1P1PG1– PA1	RC2	$300 * 0.2 = 60$, $200 * 0.2 = 40$	$60 + 40 = 100$	The pass through charge is calculated for each transaction leg and then accumulated because the distribution code, currency code, description on bill, and characteristics of the rate components are same.
BC2	01/01/2015	31/01/2015	T1– A2P1PG1– PA2	RC3	$300 * 0.3 = 90$	90	The pass through charge is calculated for the transaction leg.
BC2	01/01/2015	31/01/2015	T1– A2P1PG1– PA2	RC4	$300 * 0.2 = 60$	60	The pass through charge is calculated for the transaction leg.
BC3	01/01/2015	31/01/2015	T2– A3P1PG1– PA3	RC3, RC4	$200 * 0.3 = 60$, $200 * 0.2 = 40$	$60 + 40 = 100$	The pass through charges are calculated for the transaction leg and then accumulated because the distribution code, currency code, description on bill, and characteristics of the rate components are same.

In the above example, the BC1 and BC2 will have two pass through lines, whereas the BC3 will have one pass through line.

Now, if you use **RITX (2c)** approach, the system will rate a transaction leg and calculate charges for each transaction leg in a separate pass through billable charge, as shown in the following table:

Billable Charge	Start Date	End Date	Transaction Leg	Rate Component	Calculation Details	Pass Through Charge (\$)	Comments
BC1	01/01/2015	31/01/2015	T1-A1P1PG1-PA1	RC1	$300 * 0.1 = 30$	30	The pass through charge is calculated for the transaction leg.
BC1	01/01/2015	31/01/2015	T1-A1P1PG1-PA1	RC2	$300 * 0.2 = 60$	60	The pass through charge is calculated for the transaction leg.
BC2	01/01/2015	31/01/2015	T1-A2P1PG1-PA2	RC3	$300 * 0.3 = 90$	90	The pass through charge is calculated for the transaction leg.
BC2	01/01/2015	31/01/2015	T1-A2P1PG1-PA2	RC4	$300 * 0.2 = 60$	60	The pass through charge is calculated for the transaction leg.
BC3	01/01/2015	31/01/2015	T2-A1P1PG1-PA1	RC1	$200 * 0.1 = 20$	20	The pass through charge is calculated for the transaction leg.
BC3	01/01/2015	31/01/2015	T2-A1P1PG1-PA1	RC2	$200 * 0.2 = 40$	40	The pass through charge is calculated for the transaction leg.

Billable Charge	Start Date	End Date	Transaction Leg	Rate Component	Calculation Details	Pass Through Charge (\$)	Comments
BC4	01/01/2015	31/01/2015	T2-A3P1PG1-PA3	RC3, RC4	200*0.3 = 60, 200*0.2 = 40	60+40 = 100	The pass through charges are calculated for the transaction leg and then accumulated because the distribution code, currency code, description on bill, and characteristics of the rate components are same.

In the above example, the BC1, BC2, and BC3 will have two pass through lines, whereas the BC4 will have one pass through line.

Now, if you use **AGTR (2b)** approach, the system will determine effective pricing for a transaction leg, aggregate the transaction legs, determine rate for aggregated service quantities, and then accumulate pre-calculated charges in a pass through billable charge based on the distribution code, currency code, description on bill, aggregation parameter group ID (which is created based on the rate component characteristics), as shown in the following table:

Account- Price Item- Price Item Parameter Group- Price Assignment- Aggregation Schedule	Total Transaction Volume	Billable Charge	Start Date	End Date	Rate Component	Calculation Details	Pass Through Charge (\$)	Comments
AIP1PG1- PA1- Monthly	300+200 = 500	BC1	01/01/2015	31/01/2015	RC1	500*0.1 = 50	50	The transaction volume of T1 and T2 legs having the same price item and price item parameters combination and whose transaction date falls between the aggregation schedule is first aggregated and then pass through charge is calculated for aggregated service quantities.

Account- Price Item- Price Item Parameter Group- Price Assignment- Aggregation Schedule	Total Transaction Volume	Billable Charge	Start Date	End Date	Rate Component	Calculation Details	Pass Through Charge (\$)	Comments
A1P1PG1- PA1- Monthly	300+200 = 500	BC1	01/01/2015	31/01/2015	RC2	500*0.2 = 100	100	The transaction volume of T1 and T2 legs having the same price item and price item parameters combination and whose transaction date falls between the aggregation schedule is first aggregated and then pass through charge is calculated for aggregated service quantities.
A2P1PG1- PA2- Monthly	300	BC2	01/01/2015	31/01/2015	RC3	300*0.3 = 90	90	The pass through charge is calculated for the transaction leg.
A2P1PG1- PA2- Monthly	300	BC2	01/01/2015	31/01/2015	RC4	300*0.2 = 60	60	The pass through charge is calculated for the transaction leg.

Account- Price Item- Price Item Parameter Group- Price Assignment- Aggregation Schedule	Total Transaction Volume	Billable Charge	Start Date	End Date	Rate Component	Calculation Details	Pass Through Charge (\$)	Comments
A3PIPG1- PA3- Monthly	200	BC3	01/01/2015	31/01/2015	RC3, RC4	200*0.3 = 60, 200*0.2 = 40	60+40 = 100	The pass through charges are calculated for the transaction leg and then accumulated because the distribution code, currency code, description on bill, and characteristics of the rate components are same.

In the above example, the BC1 and BC2 will have two pass through lines, whereas the BC3 will have one pass through line.

Transaction Aggregation

The transaction aggregation process includes the following sub-processes:

- [Header Validation](#) on page 1150
- [Transaction Validation and Initial Price Item Determination](#) on page 1152
- [Price Item Pricing Verification](#) on page 1163
- [Aggregation](#) on page 1168
- [Clean Up](#) on page 1172

The following figure graphically explains the transaction aggregation process:

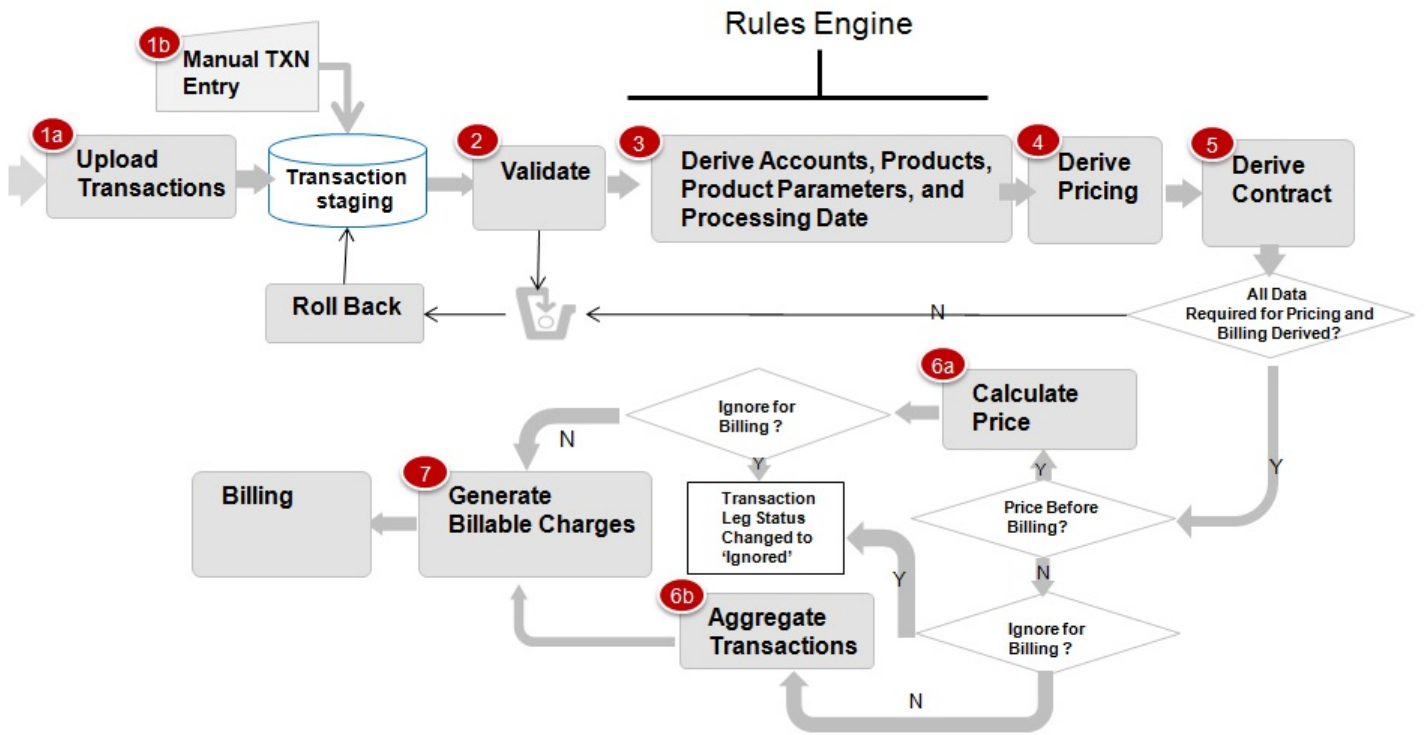

Header Validation

Once the file is uploaded in the system, you can execute the **Header Validation (C1-TXNHV)** batch to validate the file or header level information. It checks whether:

- Transaction Header ID and Transaction Source is available in the header.
- At least one transaction record is available in the file.
- The number of transaction records in the file matches the total transaction records in the header.
- The sum of transaction amount matches the total transaction amount in the header.
- The sum of transaction volume matches the total transaction volume in the header.
- File with the same header date and transaction header ID is not available in the system.
- External reference number is specified in each transaction record of the file.

If the file or header information is validated successfully, the status of the file or feed is changed to **Validated (VALI)** and the status of all transactions in the feed remains as **Uploaded (UPLD)**. However, if the header validation fails, the status of the feed and all transactions in the feed is changed to **Invalid (INVL)**.

The **Header Validation (C1-TXNHV)** batch is a multi-threaded batch. You can specify either of the following parameters while executing this batch:

Parameter Name	Description	Mandatory (Yes or No)
Transaction Header ID	Used when you want to validate a particular transaction feed.	No

Parameter Name	Description	Mandatory (Yes or No)
Transaction Source	Used when you want to validate the transaction feeds which are received from a particular transaction source.	No
Checksum Validation Required	<p>Used to indicate whether the following should be validated:</p> <ul style="list-style-type: none"> • The number of transaction records in the file matches the total transaction records in the header. • The sum of transaction amount matches the total transaction amount in the header. • The sum of transaction volume matches the total transaction volume in the header. <p>The valid values are:</p> <ul style="list-style-type: none"> • Y • N 	No
Duplicate Check Required	<p>Used to indicate whether the following should be validated:</p> <ul style="list-style-type: none"> • File with the same header date and external header ID is not available in the system. <p>The valid values are:</p> <ul style="list-style-type: none"> • Y • N <p>Note: The duplicate check is done only against the transaction feeds which are in the Validated (VALI) status and not against the transaction feeds which are in the Uploaded (UPLD) status.</p>	No
Allow Positive Transaction Volume in Header	<p>Used to indicate whether you want to allow positive value in the total transaction volume which is specified in the header record. The valid values are:</p> <ul style="list-style-type: none"> • Y • N <p>Note: By default, the parameter value is set to Y.</p>	Yes
Allow Negative Transaction Volume in Header	<p>Used to indicate whether you want to allow negative value in the total transaction volume which is specified in the header record. The valid values are:</p> <ul style="list-style-type: none"> • Y • N <p>Note: By default, the parameter value is set to N.</p>	Yes

Parameter Name	Description	Mandatory (Yes or No)
Allow Zero Transaction Volume in Header	Used to indicate whether you want to allow zero value in the total transaction volume which is specified in the header record. The valid values are: <ul style="list-style-type: none"> • Y • N 	Yes
	Note: By default, the parameter value is set to N.	
Thread Pool Name	Used to specify the thread pool on which you want to execute the batch.	No

Transaction Validation and Initial Price Item Determination

This process includes the following two sub-processes:

- **Transaction Validation** - In this sub-process, the transaction records are validated. The transaction level validations are done to check the integrity of the data. During the transaction validation, the system checks whether:
 - Transaction source is defined in the system.
 - Transaction record type is defined for the transaction source in the system.
 - Division and currencies are defined in the system.
 - The account with the specified account identifier, account identifier type and division exists in the system.

Note: This validation is done when the **Transaction Detail Account Validation** option type of the **Feed Management (C1_FM)** feature configuration is set to **Y**. If you set the **Transaction Detail Account Validation** option type of the **Feed Management (C1_FM)** feature configuration to **N**, the system overrides the transaction's account identifier type, account identifier, and division with the first derived account's account identifier type, account identifier, and division, respectively.

- User ID (if available in the transaction information) is defined in the system.
- The value other than 'Y' or 'N' is not specified in the **Manual Switch** column.
- The value other than '+' or '-' is not specified in the **Credit/Debit Indicator** column.
- Transaction Amount is specified when Transaction Currency is specified, and vice versa.
- Additional Amount 1 is specified when Amount 1 Currency Code is specified, and vice versa.
- Additional Amount 2 is specified when Amount 2 Currency Code is specified, and vice versa.
- Additional Amount 3 is specified when Amount 3 Currency Code is specified, and vice versa.
- Additional Amount 4 is specified when Amount 4 Currency Code is specified, and vice versa.
- Additional Amount 5 is specified when Amount 5 Currency Code is specified, and vice versa.
- Additional Amount 6 is specified when Amount 6 Currency Code is specified, and vice versa.
- Additional Amount 7 is specified when Amount 7 Currency Code is specified, and vice versa.
- Additional Amount 8 is specified when Amount 8 Currency Code is specified, and vice versa.
- Additional Amount 9 is specified when Amount 9 Currency Code is specified, and vice versa.
- Additional Amount 10 is specified when Amount 10 Currency Code is specified, and vice versa.

If the transaction information is invalid or incorrect (for example, division is invalid), the status of the transaction is changed to **Error (EROR)**. But, if the transaction information is not available, the status of the transaction is changed to **Invalid (INVL)**.

- **Pricing Rule Type or Rule Type Determination** - If the transaction validation is successful, the system checks whether a primary pricing rule type is specified in the respective transaction record type. If a primary pricing rule type is specified in the transaction record type, the system calls the primary pricing rule type and invokes the algorithms which are attached to the following system events of the primary pricing rule type in the specified sequence:
 1. **Transaction Validation** - At present, the product has not shipped an algorithm type for the **Transaction Validation** system event. If required, you can create a custom algorithm type which validates the transaction before deriving the transaction legs.
 2. **Bill Group Derivation** - For more information, refer to the *Bill Group Derivation* on page 2957 section.
 3. **Account and Price Item Derivation** - Depending on the category to which the pricing rule type belongs, you need to attach different algorithm to the **Account and Price Item Derivation** system event. The following table lists the algorithms that you can attach to a primary pricing rule types with different category:

Pricing Rule Type Category	Algorithm	For more information on how the system derives the transaction legs, refer to...
Claim	C1_ACCPRIDRV	<i>Account and Price Item Derivation (for the Claim Pricing Rule Type Category)</i> on page 2960
Retention Type Enrollment Based	C1_ACCPRIDRV	<i>Account and Price Item Derivation (for the Retention Type Enrollment Based Pricing Rule Type Category)</i> on page 2990
Ancillary	C1_ACCPRIDRV	<i>Account and Price Item Derivation (for the Ancillary Pricing Rule Type Category)</i> on page 3000

Once the primary pricing rule type is called, the system calls the eligible related pricing rule types (if any) defined in the primary pricing rule type. Note that the related pricing rule types are called one by one in the specified sequence. The system invokes the algorithms which are attached to the following system events of the related pricing rule type in the specified sequence:

1. **Transaction Validation** - At present, the product has not shipped an algorithm type for the **Transaction Validation** system event. If required, you can create a custom algorithm type which validates the transaction before deriving the transaction legs.
2. **Account and Price Item Derivation** - Depending on the category to which the pricing rule type belongs, you need to attach different algorithm to the **Account and Price Item Derivation** system event. The following table lists the algorithms that you can attach to a related pricing rule type with different category:

Pricing Rule Type Category	Algorithm	For more information on how the system derives the transaction legs, refer to...
Specific Stop-Loss	C1_ACCPRISL	<i>Account and Price Item Derivation (for the Specific Stop-Loss and Aggregate Stop-Loss Pricing Rule Type Categories)</i> on page 2965
Aggregate Stop-Loss	C1_ACCPRISL	<i>Account and Price Item Derivation (for the Specific Stop-Loss and Aggregate Stop-Loss Pricing Rule Type Categories)</i> on page 2965

Pricing Rule Type Category	Algorithm	For more information on how the system derives the transaction legs, refer to...
Retention Type Claim Based	C1_ACCPRIDRV	<i>Account and Price Item Derivation (for the Retention Type Claim Based Pricing Rule Type Category) on page 2978</i>

However, if a primary pricing rule type is not specified in the transaction record type, the system determines the account which will bear the charges for the transaction and the price item and variance parameter or price item parameters to which the transaction will be mapped using rules which are invoked through the rule type. Depending on the transaction record type, a rule type is invoked for each transaction. The effective rules with the specified rule type are executed, starting with the rule having highest priority, until a rule is satisfied. For example, a rule with the priority 10 will be executed before a rule with the priority 20.

Note: The system determines rules which are effective based on the **TFM - Processing Date** characteristic defined for the division to which the transaction belongs. The system uses the **TFM - Processing Date** characteristic which is effective on the transaction date. If the **TFM - Processing Date** characteristic type is set to BATCH_DT, the system executes rules which are effective on the batch business date. However, if the **TFM - Processing Date** characteristic type is set to TXN_DT, the system executes rules which are effective on the transaction date. Note that the transaction date must be earlier than or equal to the batch business date. And, if the **TFM - Processing Date** characteristic is not defined for the division to which a transaction belongs, the system, by default, executes rules which are effective on the transaction date.

Each rule contains one or more conditions or criteria. For example, Rule A states that if the transaction record type is R001 and the division is New York, then set the following output parameters:

- ACCT_NO1_Val - Account 1
- DIVISION1_VAL - D1
- PRODUCT1_1_Val - Price Item X

Here, Transaction Record Type = R001 and Division = New York are two conditions. If these two conditions in the rule are satisfied, then set three output parameters - ACCT_NO1_Val, DIVISION1_VAL and PRODUCT1_1_Val. Now, when this rule is executed and the transaction satisfies this criteria, the transaction is mapped to Price Item X and Account 1 which belongs to D1 bears the charges for the transaction. In case, the rule has four output parameters (ACCT_NO1_Val set to Account 1, DIVISION1_VAL set to D1, PRODUCT1_1_Val set to Price Item X, and PRODUCT1_2_Val set to Price Item Y), the transaction will be mapped to both the price items (i.e. Price Item X and Price Item Y) and Account 1 which belongs to D1 bears the charges for the transaction. A transaction can be mapped to one or more price items or to one or more price item and TOU (variance parameter) combinations. If the multi parameter based pricing feature is enabled, you can map a transaction to one or more price item and price item parameters combinations. Let us understand this with the help of an example.

Rule B states that if the transaction is performed in US and the transaction amount exceeds 1000 USD, then set the following output parameters:

- ACCT_NO1_Val - Account A
- DIVISION1_VAL - D1
- PRODUCT1_1_Val - Price Item X
- PCD1_1_1_VAL - Country
- PVL1_1_1_VAL - US
- PCD1_1_2_VAL - Currency
- PVL1_1_2_VAL - USD
- PRODUCT1_2_Val - Price Item Y
- PCD1_2_1_VAL - Country

- PVL1_2_1_VAL - US
- PCD1_2_2_VAL - Currency
- PVL1_2_2_VAL - USD

Now, when this rule is executed and the transaction satisfies the criteria, Account A which belongs to D1 bears the charges for the transaction which is mapped to the following price item and price item parameters combinations:

- Price Item X, Country - US, Currency - USD
- Price Item Y, Country - US, Currency - USD

More than one account can bear the charges for a transaction and each account can belong to a different division. You can map a transaction to one or more price items, to one or more price item and TOU (variance parameter) combinations, or to one or more price item and price item parameters combinations. The system allows you to map price items for each account. For example, Rule C states that if the transaction is performed in UK and the transaction amount exceeds 1000 USD, then set the following output parameters:

- ACCT_NO1_Val - Account A
- DIVISION1_VAL - D1
- PRODUCT1_1_Val - Price Item X
- PCD1_1_1_VAL - Country
- PVL1_1_1_VAL - UK
- PCD1_1_2_VAL - Currency
- PVL1_1_2_VAL - USD
- PRODUCT1_2_Val - Price Item Y
- PCD1_2_1_VAL - Country
- PVL1_2_1_VAL - UK
- PCD1_2_2_VAL - Currency
- PVL1_2_2_VAL - USD
- ACCT_NO2_Val - Account B
- DIVISION2_VAL - D2
- PRODUCT2_1_Val - Price Item A
- PCD2_1_1_VAL - Country
- PVL2_1_1_VAL - US
- PCD2_1_2_VAL - Currency
- PVL2_1_2_VAL - USD

Now, when this rule is executed and the transaction satisfies the criteria, the transaction is mapped to the following price item and price item parameters combinations:

Charges Borne By	Division to which the account belongs...	Price Item	Country	Currency
Account A	D1	Price Item X	UK	USD
Account A	D1	Price Item Y	UK	USD
Account B	D2	Price Item A	US	USD

You can limit the maximum accounts that can bear the charges for a transaction, maximum price item that can be mapped to a transaction, and maximum parameters that can be used with each price item to determine price item pricing. For more information, see [Defining a Transaction Record Type](#) on page 1280. You can also define rules to ignore transactions based on the transaction attributes. If the rule returns the **IGNORE_SW** equal to **Y**, the status of the transaction is changed to **Ignored (IGNR)** and no further processing takes place on the transaction.

You can use the following output parameters while defining rules in the system:

Output Parameter	Naming Convention	Example	Description
Account Identifier	ACCT_NOX_Val	ACCT_NO1_Val, ACCT_NO2_Val, ACCT_NO3_Val,	Used to indicate the account which must bear the charges for the transaction.
Account Identifier Column Name	ACCT_NOX_Col	ACCT_NO1_Col, ACCT_NO2_Col, ACCT_NO3_Col, ...	Used to indicate the column from where the account identifier corresponding to the transaction (in the transaction details) must be picked.
Account Identifier Type	ACCT_NO_TYPEX_Val	ACCT_NO_TYPE1_Val, ACCT_NO_TYPE2_Val, ACCT_NO_TYPE3_Val, ...	Used to indicate the type of account identifier.
Account Identifier Type Column Name	ACCT_NO_TYPEX_Col	ACCT_NO_TYPE1_Col, ACCT_NO_TYPE2_Col, ACCT_NO_TYPE3_Col, ...	Used to indicate the column from where the account identifier type corresponding to the transaction (in the transaction details) must be picked.
Account Division	DIVISIONX_VAL	DIVISION1_VAL	Used to indicate the division to which the account belongs.
Account Division Column Name	DIVISIONX_COL	DIVISION1_COL	Used to indicate the column from where the division corresponding to the transaction (in the transaction details) must be picked.
Price Item Name	PRODUCTX_Y_Val	PRODUCT1_1_Val, PRODUCT2_1_Val, PRODUCT2_2_Val,	Used to indicate the price item to which the transaction must be mapped.
	Note: Here, X represents the account and Y represents the price item.		
Price Item Column Name	PRODUCTX_Y_Col	PRODUCT1_1_Col,, PRODUCT2_1_Col, PRODUCT2_2_Col, ...	Used to indicate the column from where the price item corresponding to the transaction (in the transaction details) must be picked.
	Note: Here, X represents the account and Y represents the price item.		

Output Parameter	Naming Convention	Example	Description
TOU	TOUX_Y_Val	TOU1_1_Val, TOU2_1_Val, TOU2_2_Val, ...	Used to indicate the variance parameter which you want to use along with the price item for price determination. Note: This output parameter appears when the Multi Price Parameter Based Pricing (C1_PPARM_FLG) feature configuration is set to False .
	Note: Here, X represents the account and Y represents the price item.		
TOU Column Name	TOUX_Y_Col	TOU1_1_Col, TOU2_1_Col, TOU2_2_Col, ...	Used to indicate the column from where the variance parameter corresponding to the transaction (in the transaction details) must be picked. Note: This output parameter appears when the Multi Price Parameter Based Pricing (C1_PPARM_FLG) feature configuration is set to False .
	Note: Here, X represents the account and Y represents the price item.		
Parameter Code	PCDX_Y_Z_VAL	PCD1_1_1_VAL, PCD1_2_1_VAL, PCD2_1_1_VAL, ...	Used to indicate the parameter which you want to use along with the price item for price determination. Note: This output parameter appears when the Multi Price Parameter option type of the Multi Parameter Based Pricing (C1_PPARM_FLG) feature configuration is set to True . You must not specify any special character except underscore (_) in the parameter code. Otherwise, the status of the transaction is changed to Error (EROR) .
	Note: At present, the system does not support the Parameter Code Column output parameter.		
	Note: Here, X represents the account, Y represents the price item, and Z represents the parameter.		

Output Parameter	Naming Convention	Example	Description
Parameter Value	PVLX_Y_Z_VAL	PVL1_1_1_VAL, PVL1_2_1_VAL, PVL2_1_1_VAL, ...	Used to specify the value for the parameter.
	<p>Note: Here, X represents the account, Y represents the price item, and Z represents the parameter.</p>		<p>Note:</p> <p>This output parameter appears when the Multi Price Parameter option type of the Multi Parameter Based Pricing (C1_PPARM_FLG) feature configuration is set to True.</p> <p>The parameter value must not contain the equal to (=) and tilde (~) symbols. Otherwise, the status of the transaction is changed to Error (EROR).</p>
Parameter Value Column Name	PVLX_Y_Z_COL	PVL1_1_1_COL, PVL1_2_1_COL, PVL2_1_1_COL, ...	Used to indicate the column from where the parameter value corresponding to the transaction (in the transaction details) must be picked.
	<p>Note: Here, X represents the account, Y represents the price item, and Z represents the parameter.</p>		<p>Note:</p> <p>This output parameter appears when the Multi Price Parameter option type of the Multi Parameter Based Pricing (C1_PPARM_FLG) feature configuration is set to True.</p> <p>The column from where the parameter value is picked must not contain the equal to (=) and tilde (~) symbols. Otherwise, the status of the transaction is changed to Error (EROR).</p>

Output Parameter	Naming Convention	Example	Description
Processing Date Type	PRCS_DTX_Y_TYP	PRCS_DT1_1_TYP, PRCS_DT1_2_TYP, PRCS_DT2_1_TYP, ...	<p>Used to indicate the date type using which you want to determine the effective price item parameters, pricing, and exchange rate. The valid values are:</p> <ul style="list-style-type: none"> • TXN_DT - Used when you want to determine price item parameters, pricing, and exchange rate which are effective on the transaction date. • Batch_DT - Used when you want to determine price item parameters, pricing, and exchange rate which are effective on the batch business date.
	<p>Note: Here, X represents the account and Y represents the price item.</p>		

Output Parameter	Naming Convention	Example	Description
Processing Date	PRCS_DTX_Y_VAL	PRCS_DT1_1_VAL, PRCS_DT1_2_VAL, PRCS_DT2_1_VAL, ...	Used to specify a custom date on which you want to determine the effective price item parameters, pricing, and exchange rate.
	<p>Note: Here, X represents the account and Y represents the price item.</p>		<p>Note:</p> <p>The custom date must be a date other than the transaction or batch business date.</p> <p>Based on the TFM - Processing Date characteristic defined for the division to which a transaction belongs, the system determines the rules, price item parameters, pricing, and exchange rate which are effective on the transaction or batch business date. The price item parameters, pricing, and exchange rate which are effective is determined for all account and price item combinations to which the transaction is mapped. If you want to use a custom processing date for a particular account and price item combination to which the transaction is mapped, you need to set the PRCS_DTX_Y_VAL output parameter. In other words, the PRCS_DTX_Y_VAL output parameter helps you to override the processing date for a particular account and price item combination. However, the overridden processing date is used only while determining effective price item parameters, pricing, and exchange rate.</p>
Ignore Transaction	IGNORE_SW		<p>Used to ignore transactions based on the transaction attributes. The valid values are:</p> <ul style="list-style-type: none"> • Y • N

Once the transaction satisfies any rule (invoked through the rule type), one transaction leg is created for each account, division, price item, and variance parameter or price item parameters combination. Let us understand this with the help of an example. The following table lists the accounts and price items to which T1, T2, and T3 are mapped:

Transaction	Charges Borne By	Division to which the account belongs...	Price Item	Variance Parameter	Price Item Parameters
T1	A1	D1	P1	-	Country - US, Currency - USD
T1	A1	D1	P2	-	Country - Germany, Currency - USD
T1	A2	D2	P3	USD	-
T2	A1	D1	P1	-	Country - US, Currency - USD
T2	A2	D2	P2	USD	-
T3	A1	D1	P3	-	Country - Germany, Currency - USD

In such case, the system will create three legs for T1, two legs for T2, and one leg for T3. Each transaction leg will have its own status. The status of the transaction legs and transaction is changed to **Initial Price Item Determined (INPD)**. However, if a transaction does not satisfy any rule, the status of the transaction is changed to **Error (EROR)**.

Note:

During this sub-process, the system validates the following:

- Whether the price item parameters specified in the output parameters are effective for the price item on the processing date.
- Whether the mandatory price item parameter which is effective on the processing date is specified in the output parameter.
- Whether the parameter value is specified for all mandatory price item parameters which are effective on the processing date.

If any of the above validation fails, the status of the transaction is changed to **Error (EROR)** and no transaction legs are created.

Once the transaction legs are created, the price item parameters of each transaction leg are grouped. For example, when a transaction is mapped to the following price item and price item parameters combinations, the system creates three groups - Group A, Group B, and Group C:

- Account A, Price Item X, Country - US, Currency - USD
- Account A, Price Item Y, Country - Germany, Currency - USD
- Account B, Price Item X, Country - England, Currency - USD

Group A contains Country - US, Currency - USD; Group B contains Country - Germany, Currency - USD; and Group C contains Country - England, Currency - USD.

A set of price item parameters are grouped when the multi parameter based pricing feature is enabled. A group is used to determine the price item pricing. A unique group ID is generated for each group. If a group with a set of price item parameters already exists in the system, a new group is not created. Instead, the existing group is used for determining the price item pricing.

You can execute this process through a multi-threaded batch named **Validate Transaction and Derive Price Item (C1-TXNIP)**. You can specify the following parameters while executing this batch:

Parameter Name	Description	Mandatory (Yes or No)
Batch Business Date	Used to identify the transactions for which you want to perform validation and determine price item. The system considers the transactions whose transaction date is earlier than or equal to the batch business date.	No
	<p>Note:</p> <p>If you do not specify any date, the batch business date is set to the current date.</p> <p>The batch business date used while executing the C1-TXNIP batch is stamped in the database. It is then used while executing all other consequent batches in the transaction aggregation cycle.</p>	
Transaction Header ID	Used when you want to validate and derive price item for the transactions which are received in a particular transaction feed.	No
Transaction Source	Used when you want to validate and derive price item for the transactions which are received from a particular transaction source.	No
Division	Used when you want to validate and derive price item for the transactions belonging to a particular division.	No
Shuffle Work Unit	Used to indicate whether you want to shuffle the work units across threads to correct the uneven thread processing time. The valid values are: <ul style="list-style-type: none"> • Y • N 	No
	Note: By default, the parameter value is set to N.	
Chunk Size	Used to specify the number of transactions you want to execute in each work unit.	Yes
Maximum Batch Count	Used to specify the maximum number of transactions after which the data must be transferred to the database.	Yes
Thread Pool Name	Used to specify the thread pool on which you want to execute the batch.	No

A log is generated if the **Logging Rules for Transaction Feed** option type in the **Rule Engine (C1_RLENG)** feature configuration is set to **True**. This log indicates the rules that were executed for each transaction and whether each rule passed or failed during the execution.

Note:

You can aggregate transaction legs in a billable charge using aggregation parameters other than account ID, price item code, variance or price item parameters, aggregation start date, and aggregation end date. The additional aggregation parameters can be stamped in the form of aggregation parameter group ID while performing post-processing activities for each transaction leg. This aggregation parameter group ID will be used in subsequent batches during the transaction aggregation cycle. If you want to perform some post-processing activities on the transaction legs, you need to attach a post-processing algorithm on the **TFM - Price Item Derivation Post-Processing** algorithm entity in the **Algorithms** tab of the **Division** screen. Note that the system invokes the algorithm which is attached on the division to which the transaction belongs. This algorithm is triggered only for transactions which are in the **Initial Price Item Determined (INPD)** status. It is triggered before the price item parameter group is created.

A sample post-processing algorithm type named **C1_PRDR_POPC** is shipped with the price item. It does not have any business logic. If you want to undertake some post-processing activities for a transaction leg, you need to create custom algorithm type and attach the respective algorithm on the **TFM - Price Item Derivation Post-Processing** algorithm spot of the respective division. You can refer to the **C1_PRDR_POPC** algorithm type to understand the input parameters that must be passed to the custom algorithm type.

Once the **Validate Transaction and Derive Price Item (C1-TXNIP)** batch is executed, the processing date is stamped against each transaction leg in the database. If a custom processing date is specified for a particular account and price item combination, the custom processing date is stamped against the respective transaction leg. Otherwise, the processing date defined for the division to which a transaction belongs is stamped against the legs of the respective transaction. The processing date which is stamped against a transaction leg in the database is used while executing all subsequent batches in the transaction aggregation cycle.

Related Topics

For more information on...	See...
Rules Engine	Rules Engine on page 1081
How to define a rule	Defining a Rule on page 1103

Price Item Pricing Verification

In this process, the system behaves in the following manner:

If the Multi Parameter Based Pricing feature is...	Then...
Disabled	<p>The system checks whether effective pricing is available for the account, price item or regular bundle (to which the price item belongs) or parent (regular) bundle (to which the regular bundle belongs) and/or TOU combination on the processing date. The system searches for the price item, regular bundle or parent bundle pricing depending on the value defined for the Prefer Price Item Over Bundle parameter in the price assignment search algorithm (which is defined for the division to which the account belongs).</p> <p>If the price item belongs to a regular bundle and the effective pricing is available for the regular bundle at the account level, the system considers the regular bundle as the final price item and maps it to the transaction leg. If the effective pricing is not available for the regular bundle, the system checks whether the effective pricing is available for the parent bundle (if assigned) at the account level. If the effective pricing is available for the parent bundle, the system considers the parent bundle as the final price item and maps it to the transaction leg. If the effective pricing is not available for the price item, regular bundle, or parent bundle, the status of the transaction leg is changed to Error (EROR). If the effective pricing is not available for one or more price items to which a transaction is mapped, the status of the transaction is also changed to Error (EROR).</p>
Enabled	<p>The system checks whether effective pricing is available for the account, price item or regular bundle (to which the price item belongs) or parent (regular) bundle (to which the regular bundle belongs) and/or price item parameters (parameter group) combination on the processing date. The system searches for the price item, regular bundle or parent bundle pricing depending on the value defined for the Prefer Price Item Over Bundle parameter in the price assignment search algorithm (which is defined for the division to which the account belongs).</p> <p>The system searches for a price with exact match at all levels defined in the search order. If the exact match is available at two or more levels, the price assignment at the higher precedence level is considered for calculating the charges. But, if the system does not find the exact match at any level, it searches for the best fit match at all levels. For more information about best fit match, see Multi Parameter Based Pricing. If the system finds the best fit match with same weight at multiple levels, the price assignment at the higher precedence level is considered for calculating the charges.</p> <p>If the price item belongs to a regular bundle and the exact or best fit price is available for the regular bundle at the account level, the system considers the regular bundle as the final price item and maps it to the transaction leg. If the exact or best fit price is not available for the regular bundle, the system checks whether the exact or best fit price is available for the parent bundle (if assigned) at the account level. If the exact or best fit price is available for the parent bundle, the system considers the parent bundle as the final price item and maps it to the transaction leg. If the exact or best fit price is not available for the price item, regular bundle, or parent bundle, the status of the transaction leg is changed to Error (EROR). If the exact or best fit price is not available for one or more price items to which a transaction is mapped, the status of the transaction is also changed to Error (EROR).</p>

Note:

The processing date which is stamped against a transaction leg is used to determine effective pricing for the transaction leg.

The order in which the system searches effective pricing for the price item, regular bundle, or parent (regular) bundle at the same level depends on the value defined for the **Prefer Price Item Over Bundle** parameter in the price assignment search algorithm. If the value of the **Prefer Price Item Over Bundle** parameter is set to **Y**, the system first searches whether effective pricing is available for the price item. If the effective pricing is not available for the price item, then the system searches whether effective pricing is available for the regular bundle at the same level. If the effective pricing is not available for the regular bundle, then the system searches whether effective pricing is available for the parent bundle at the same level. However, if the value of the **Prefer Price Item Over Bundle** parameter is set to **N**, the system first searches whether effective pricing is available for the parent bundle. If the effective pricing is not available for the parent bundle, then the system searches whether effective pricing is available for the regular bundle at the same level. If the effective pricing is not available for the regular bundle, then the system searches whether effective pricing is available for the price item at the same level.

In addition, the status of the transaction and transaction leg is changed to **Error (EROR)** when:

- There is no contract available with the specified contract type on the transaction date or when the contract is inactive.
- There are multiple effective contracts of the same contract type (available on the transaction date) in **Active**, **Pending Stop**, or **Stop** status.
- The **Price Assignment Search** algorithm is not defined for the division.
- The parameter values are either not defined or invalid in the **Price Assignment Search** algorithm on the processing date.
- The period in which the transaction date falls is not defined in the aggregation schedule.

Once the effective pricing is determined for the initial or final price item, the values of the following pricing attributes are retrieved:

- Ignore Transaction
- Aggregate Transaction
- Aggregation Schedule
- Rating Criteria
- Price Assignment ID
- Account ID (in case of account agreed and price list pricing)
- Person ID (in case of customer agreed and price list pricing)
- Price List ID (in case of price list pricing)
- Contract ID
- Regular Bundle Code
- Pricing Currency

In addition, the system invokes the algorithms attached to the following algorithm spots of the derived account's division in the specified sequence for the self-funded health insurance business:

1. **TFM - Contract Derivation** - You can attach an algorithm created using the **SA_DERV_POPC** algorithm type to this algorithm spot. If the account has multiple active contracts of the contract type which is associated with the price item, this algorithm derives the contract which is associated with the policy and maps it to the transaction leg. The manner in which the system derives the active contract for the account differs in the following scenarios:

If the effective pricing rule stamped against the transaction leg is defined at ...	Then...
The bill group level	The system first fetches the policy derived for the transaction and then derives the active contract which is associated with the policy.
The parent customer level	The system first fetches the bill group to which the account belongs and then the policy where the bill group is associated with the policy using the policy person role which is specified in the Bill Group Policy Person Role option type of the C1-ASOBLLNG feature configuration. Once the policy is derived, the system derives the active contract which is associated with the policy.

2. **TFM - Verify Pricing Post-Processing** - You can attach an algorithm created using the **C1-VRPR_POPC** algorithm type to this algorithm spot. This algorithm removes the price assignment ID and price item parameter group ID from the summary ID column of each transaction leg.

You can execute this process through a multi-threaded batch named **Price Item Pricing Verification (C1-TXNVP)**. You can specify either of the following parameters while executing this batch:

Parameter Name	Description	Mandatory (Yes or No)
Transaction Header ID	Used when you want to find the price item pricing for transactions which are received in a particular transaction feed.	No
Transaction Source	Used when you want to find the price item pricing for transactions which are received from a particular transaction source.	No
Division	Used when you want to find the price item pricing for transactions belonging to a particular division.	No
Chunk Size	Used to specify the number of transactions you want to execute in each work unit.	Yes
Thread Pool Name	Used to specify the thread pool on which you want to execute the batch.	No

Note that the **Price Item Pricing Verification (C1-TXNVP)** batch does not change the status of the transaction and its legs. You need to execute the **Update Status (C1-TXNEX)** batch to update the status of the transaction and its legs. Besides updating the status, the **Update Status (C1-TXNEX)** batch determines the rate for transaction legs whose effective pricing has either of the following set of attributes:

- **Ignore Transaction** is set to **Yes** and **Rating Criteria** is set to **Rate Transactions (RITX)**
- **Ignore Transaction** is set to **No**, **Aggregate Transaction** is set to **Yes**, and **Rating Criteria** is set to **Rate individual transactions and aggregate calc lines across transactions (RITA)**

Each set of pricing attributes indicates how the transaction legs must be rated before billing. For more information about the different ways in which a transaction leg can be rated, see [Transaction Rating Before Billing](#) on page 1140.

You can specify either of the following parameters while executing this batch:

Parameter Name	Description	Mandatory (Yes or No)
Transaction Header ID	Used when you want to change the status of transactions which are received in a particular transaction feed.	No

Parameter Name	Description	Mandatory (Yes or No)
Transaction Source	Used when you want to change the status of transactions which are received from a particular transaction source.	No
Division	Used when you want to change the status of transactions belonging to a particular division.	No
Shuffle Work Unit	Used to indicate whether you want to shuffle the work units across threads to correct the uneven thread processing time. The valid values are: <ul style="list-style-type: none"> • Y • N 	No
	Note: By default, the parameter value is set to N.	
Chunk Size	Used to specify the number of transactions you want to execute in each work unit.	Yes
Maximum Batch Count	Used to specify the maximum number of transactions after which the data must be transferred to the database.	Yes
Thread Pool Name	Used to specify the thread pool on which you want to execute the batch.	No

Note:

You must specify same parameters in the **Product Pricing Verification (C1-TXNVP)** and **Update Status (C1-TXNEX)** batches. Otherwise, erroneous results might occur.

If you want to do some preprocessing activities before invoking the rates engine, you need to attach a preprocessing algorithm on the **TFM - Rate Pre-Processing** algorithm entity in the **Algorithms** tab of the **Division** screen. Note that the system invokes the algorithm which is attached on the derived account's division and not on the division to which the transaction belongs. A sample preprocessing algorithm type named **C1_RTCL_PRPC** is shipped with the product. It does not have any business logic. If you want to undertake some preprocessing activities before invoking the rates engine, you need to create custom algorithm type and attach the respective algorithm on the **TFM - Rate Pre-Processing** algorithm spot of the respective division. You can refer to the **C1_RTCL_PRPC** algorithm type to understand the input parameters that must be passed to the custom algorithm type.

If a transaction leg is ignored and not considered for billing, the status of the transaction leg is changed to **Ignored (IGNR)**, whereas the status of the transaction remains as **Initial Price Item Determined (INPD)**. However, if all legs of a transaction are ignored and not considered for billing, the status of the transaction and transaction legs is changed to **Ignored (IGNR)**.

You can store the price item pricing information, and thereby improve the **Price Item Pricing Verification (C1-TXNVP)** batch performance. If you set the **Use Materialized Views** option type of the **C1_FM** feature configuration to **true**, the system will store the product pricing information in the following tables:

- CI_PRC_AGRD
- CI_PRC_PL
- CI_PRC_INH_PL

But, if you set the **Use Materialized Views** option type of the **C1_FM** feature configuration to **false**, the system will not store the product pricing information in the above mentioned tables. If there are any pricing changes, you will have to update these tables before executing the **Price Item Pricing Verification (C1-TXNVP)** batch. You can update the product pricing information in these tables by executing the **Refresh Pricing (C1-TXNRP)** batch. Ideally, you must execute the **Refresh Pricing (C1-TXNRP)** batch after you execute the **Flush All Caches (F1-FLUSH)** batch in the

transaction aggregation cycle. You can specify the following parameters while executing the **Refresh Pricing (C1-TXNRP)** batch:

Parameter Name	Description	Mandatory (Yes or No)
Division	Used when you want to update the price item pricing information of accounts belonging to a particular division.	No
Chunk Size	Used to specify the number of persons whose regular and post-processing price item pricing information you want to update in each work unit.	Yes
Thread Pool Name	Used to specify the thread pool on which you want to execute the batch.	No

Related Topics

For more information on...	See...
Transaction Leg Status Transition	Transaction Leg Status Transition on page 1196
How to set the C1_FM feature configuration	Setting the C1_FM Feature Configuration on page 3453

Aggregation

Once the price item pricing verification is complete, you can aggregate the transaction legs, create a billable charge, and update the SQI values in the billable charge. In the aggregation process, the system behaves in the following manner:

If the Multi Parameter Based Pricing feature is...	Then...
Disabled	<p>The system checks the value defined in the Aggregate Transaction field. If the Aggregate Transaction field is set to No, the system creates one billable charge (with the Billable status) for each transaction leg. However, if the Aggregate Transaction field is set to Yes, the system creates one billable charge (with the Billable status) for all transactions legs having the same price item and TOU combination and whose transaction date falls between the aggregation schedule.</p> <p>Note:</p> <p>During the billable charge creation, the system also considers the contract start and end dates along with the aggregation schedule. If the contract start date falls between the aggregation schedule, the billable charge start date is equal to the contract start date. If the contract start date is earlier than the aggregation schedule start date, the billable charge start date is equal to the aggregation schedule start date. If the contract end date is earlier than the aggregation schedule end date, the billable charge end date is equal to the contract end date. If the contract end date is later than the aggregation schedule end date, the billable charge end date is equal to the aggregation schedule end date. However, if the contract start date is later than the aggregation schedule end date or if the contract end date is earlier than the aggregation schedule start date, the status of the transaction leg is changed to Error (EROR).</p> <p>If the aggregated billable charge already exists for the account, price item and TOU combination and there is no bill segment associated with the billable charge, the system will update the SQI values in the existing billable charge.</p>

If the Multi Parameter Based Pricing feature is...	Then...
Enabled	<p>The system checks the value defined in the Aggregate Transaction field. If the Aggregate Transaction field is set to No, the system creates one billable charge (with the Billable status) for each transaction leg. However, if the Aggregate Transaction field is set to Yes, the system creates one billable charge (with the Billable status) for all transaction legs having the same price item and price item parameters (parameter group) combination and whose transaction date falls between the aggregation schedule.</p> <p>Note:</p> <p>During the billable charge creation, the system also considers the contract start and end dates along with the aggregation schedule. If the contract start date falls between the aggregation schedule, the billable charge start date is equal to the contract start date. If the contract start date is earlier than the aggregation schedule start date, the billable charge start date is equal to the aggregation schedule start date. If the contract end date is earlier than the aggregation schedule end date, the billable charge end date is equal to the contract end date. If the contract end date is later than the aggregation schedule end date, the billable charge end date is equal to the aggregation schedule end date. However, if the contract start date is later than the aggregation schedule end date or if the contract end date is earlier than the aggregation schedule start date, the status of the transaction leg is changed to Error (EROR).</p> <p>If the aggregated billable charge already exists for the account, price item and price item parameters combination and there is no bill segment associated with the billable charge, the system will update the SQI values in the existing billable charge.</p>

The transaction aggregation is done based on the aggregation schedule defined in the price item pricing. You can use the following standard schedules or you can create your own custom schedules for aggregation:

- Daily
- Weekly
- Monthly
- Quarterly
- Yearly

Once the billable charge is created, the system aggregates the SQIs defined for the price item — division combination using the aggregation function and then updates the billable charge with the respective SQI values. If the aggregation function is based on the transaction amount or on any other user defined amount and the transaction or user defined currency is different from the pricing currency, the system does currency conversion if the appropriate exchange rate is available in the system. The processing date which is stamped against a transaction leg is used to determine effective exchange rate for the transaction leg.

Once the SQI values are updated in the billable charge, the rate is determined for the transaction leg whose effective pricing has either of the following set of attributes:

- **Ignore Transaction** is set to **No**, **Aggregate Transaction** is set to **Yes**, and **Rating Criteria** is set to **Aggregate transactions and then rate aggregated SQs (AGTR)**
- **Ignore Transaction** is set to **No**, **Aggregate Transaction** is set to **No**, and **Rating Criteria** is set to **Rate Transactions (RITX)**

Each set of pricing attributes indicates how the transaction legs must be rated before billing. For more information about the different ways in which a transaction leg can be rated, see [Transaction Rating Before Billing](#) on page 1140.

Note: If you want to do some preprocessing activities while determining rate, you need to attach a preprocessing algorithm on the **TFM - Rate Pre-Processing** algorithm entity in the **Algorithms** tab of the **Division** screen. Note that the system invokes the algorithm which is attached on the derived account's division and not on the division to which the transaction belongs. A sample preprocessing algorithm type named **C1_RTCL_PRPC** is shipped with the price item. It does not have any business logic. If you want to undertake some preprocessing activities while determining rate for transaction legs, you need to create custom algorithm type and attach the respective algorithm on the **TFM - Rate Pre-Processing** algorithm spot of the respective division. You can refer to the **C1_RTCL_PRPC** algorithm type to understand the input parameters that must be passed to the custom algorithm type.

In addition, the system invokes the algorithm attached to the following algorithm spot of the derived account's division for the **self-funded health insurance** business:

- **TFM - Billable Charge Post Processing** - You can attach an algorithm created using the **C1_BCHG_POPC** algorithm type to this algorithm spot. This algorithm invokes the algorithm which is attached to the **Bill After Date Determination** system event of the respective pricing rule type. For more information, refer to the [Bill After Date Determination](#) on page 3008 section.

Once the billable charge is created and updated successfully, the status of the transaction leg is changed to **Completed (COMP)**. However, if the SQIs are not defined for the price item — division combination, the transaction aggregation rule is not defined for the SQI, or if the exchange rate is not available during currency conversion, the status of the transaction leg is changed to **Error (EROR)**. If all legs of a transaction are in the **Completed (COMP)** status, the status of the transaction is changed to **Completed (COMP)**. But, if any of the transaction leg is in the **Error (EROR)** status, the status of the transaction is changed to **Error (EROR)**.

You can execute this process through a multi-threaded batch named **Service Quantity Calculation (C1-TXNSQ)**. You can specify either of the following parameters while executing this batch:

Parameter Name	Description	Mandatory (Yes or No)
Transaction Header ID	Used when you want to create the billable charges for transactions which are received in a particular transaction feed.	No
Transaction Source	Used when you want to create the billable charges for transactions which are received from a particular transaction source.	No
Division	Used when you want to create the billable charges for transactions belonging to a particular division.	No
Chunk Size	Used to specify the number of transactions you want to execute in each work unit.	Yes
Maximum Batch Count	Used to specify the maximum number of transactions after which the data must be transferred to the database.	Yes
Thread Pool Name	Used to specify the thread pool on which you want to execute the batch.	No

The **Service Quantity Calculation (C1-TXNSQ)** batch does not change the status of the transaction and its legs. You need to execute the **Mark Completion (C1-TXNCM)** batch to update the status of the transaction and its legs. Besides updating the status, the **Mark Completion (C1-TXNCM)** batch does the following with other legs when billable charge is not created for one or more transaction legs:

Rate for other transaction leg is determined using the following set of pricing attributes...	Then....
Ignore Transaction is set to Yes and Rating Criteria is set to Rate Transactions (RITX)	The corresponding calculation lines of the transaction leg are deleted.
Ignore Transaction is set to No , Aggregate Transaction is set to No , and Rating Criteria is set to Rate Transactions (RITX)	The corresponding billable charge and calculation lines of the transaction leg are deleted.
Ignore Transaction is set to No , Aggregate Transaction is set to Yes , and Rating Criteria is set to Rate individual transactions and aggregate calc lines across transactions (RITA)	The corresponding calculation lines of the transaction leg are deleted.
Ignore Transaction is set to No , Aggregate Transaction is set to Yes , and Rating Criteria is set to Aggregate transactions and then rate aggregated SQs (AGTR)	The corresponding billable charge and calculation lines are not deleted.
Ignore Transaction is set to No , Aggregate Transaction is set to No , and Rating Criteria is set to Do Not Rate Transactions	The corresponding non-aggregated billable charge is deleted.

You can specify either of the following parameters while executing the **Mark Completion (C1-TXNCM)** batch:

Parameter Name	Description	Mandatory (Yes or No)
Transaction Header ID	Used when you want to change the status of transactions which are received in a particular transaction feed.	No
Transaction Source	Used when you want to change the status of transactions which are received from a particular transaction source.	No
Division	Used when you want to change the status of transactions belonging to a particular division.	No
Chunk Size	Used to specify the number of transactions you want to execute in each work unit.	Yes
Maximum Batch Count	Used to specify the maximum number of transactions after which the data must be transferred to the database.	Yes
Thread Pool Name	Used to specify the thread pool on which you want to execute the batch.	No

Note:

You must specify same parameters in the **Service Quantity Calculation (C1-TXNSQ)** and **Mark Completion (C1-TXNCM)** batches. Otherwise, erroneous results might occur.

If you want to perform some post-processing activities on a billable charge, you need to attach a post-processing algorithm on the **TFM - Billable Charge Post-Processing** algorithm entity in the **Algorithms** tab of the **Division** screen. This algorithm is triggered once the billable charge is created and SQIs are updated in the billable charge. Note that the system invokes the algorithm which is attached on the derived account's division and not on the division to which the transaction belongs. A sample post-processing algorithm type named **C1_BCHG_POPC** is shipped with the product. It does not have any business logic. If you want to undertake some post-processing activities on a billable charge, you need to create custom algorithm type and attach the respective algorithm on the **Feed Management Billable Charge Post-Processing** algorithm spot of the respective division. You can refer to the **C1_BCHG_POPC** algorithm type to understand the input parameters that must be passed to the custom algorithm type.

Related Topics

For more information on...	See...
Transaction Leg Status Transition	Transaction Leg Status Transition on page 1196

Clean Up

There might be situations when a transaction is mapped to one or more price items and due to some reasons a billable charge could not be created for one of the price item. And, therefore the status of the transaction is changed to **Error (EROR)**. In such case, you need to either recalculate SQIs in the aggregated billable charge or delete the aggregated billable charge depending on whether the aggregated billable charge includes transaction legs in the **Completed (COMP)** status. You can perform this clean up process through a multi-threaded batch named **Clean Up (C1-TXNCU)**.

When the transaction legs in the **Error (EROR)** and **Completed (COMP)** statuses are aggregated together in a billable charge, the **Clean Up (C1-TXNCU)** batch does the following:

Billable charge contain transaction legs with the following set of pricing attributes...	Then....
Ignore Transaction is set to No , Aggregate Transaction is set to Yes , and Rating Criteria is set to Do Not Rate Transactions	The SQIs are recalculated in the billable charge.
Ignore Transaction is set to No , Aggregate Transaction is set to Yes , and Rating Criteria is set to Aggregate transactions and then rate aggregated SQs (AGTR)	The SQIs are recalculated in the billable charge and the rate is determined for aggregated service quantities. Once the rate is determined, pass through charges are calculated and accumulated accordingly.
Ignore Transaction is set to No , Aggregate Transaction is set to Yes , and Rating Criteria is set to Rate individual transactions and aggregate calc lines across transactions (RITA)	The pass through charges are recalculated and accumulated accordingly.

However, when the transaction legs in the **Error (EROR)** status are only aggregated in a billable charge, the **Clean Up (C1-TXNCU)** batch does the following:

Billable charge contain transaction legs with the following set of pricing attributes...	Then....
Ignore Transaction is set to No , Aggregate Transaction is set to Yes , and Rating Criteria is set to Do Not Rate Transactions	The aggregated billable charge is deleted.
Ignore Transaction is set to No , Aggregate Transaction is set to Yes , and Rating Criteria is set to Aggregate transactions and then rate aggregated SQs (AGTR)	The aggregated billable charge and the corresponding calculation lines are deleted.
Ignore Transaction is set to No , Aggregate Transaction is set to Yes , and Rating Criteria is set to Rate individual transactions and aggregate calc lines across transactions (RITA)	The aggregated billable charge is deleted.

Note:

If the aggregation function is based on the transaction amount or on any other user defined amount and the transaction or user defined currency is different from the pricing currency, the system does currency conversion if the appropriate exchange rate is available in the system. The processing date which is stamped against a transaction leg is used to determine effective exchange rate for the transaction leg.

The SQIs in an aggregated billable charge are recalculated only when the **SQ Recalculation Required** option type in the **C1_FM** feature configuration is set to **Y**. If you set the **SQ Recalculation Required** option type in the **C1_FM** feature configuration to **N**, the SQIs are not recalculated in an aggregated billable charge. We recommend you to recalculate SQIs in an aggregated billable charge when more than one account bears the charges for a transaction.

If you want to perform some post-processing activities on a billable charge, you need to attach a post-processing algorithm on the **TFM - Billable Charge Post-Processing** algorithm entity in the **Algorithms** tab of the **Division** screen. This algorithm is triggered once the billable charge is created and SQIs are updated in the billable charge. Note that the system invokes the algorithm which is attached on the derived account's division and not on the division to which the transaction belongs. A sample post-processing algorithm type named **C1_BCHG_POPC** is shipped with the product. It does not have any business logic. If you want to undertake some post-processing activities on a billable charge, you need to create custom algorithm type and attach the respective algorithm on the **TFM - Billable Charge Post-Processing** algorithm spot of the respective division. You can refer to the **C1_BCHG_POPC** algorithm type to understand the input parameters that must be passed to the custom algorithm type.

Besides the transaction aggregation process, the **Clean Up (C1-TXNCU)** batch is also used during the following sub-processes:

- **Cancellation** — During the cancellation process, it deletes non-aggregated billable charges and recalculates SQIs in aggregated billable charges.
- **Disaggregation** — During the disaggregation process, it deletes an aggregated billable charge when all the corresponding transaction legs which were aggregated in the billable charge are deleted during disaggregation.

You can specify either of the following parameters while executing the **Clean Up (C1-TXNCU)** batch:

Parameter Name	Description	Mandatory (Yes or No)
Transaction Header ID	Used when you want to update or delete billable charges created for transactions which are received in a particular transaction feed.	Yes (Conditional) Note: This parameter is required when you set the request type to CNCL .
	Note: This parameter should not be used during the disaggregation process.	
Transaction Source	Used when you want to update or delete billable charges created for transactions which are received from a particular transaction source.	No
	Note: This parameter should not be used during the cancellation and disaggregation processes.	
Division	Used when you want to update or delete billable charges created for transactions belonging to a particular division.	No
	Note: This parameter should not be used during the cancellation process.	

Parameter Name	Description	Mandatory (Yes or No)
Account ID	Used when you want to update or delete billable charges created for transactions of a particular account.	No
	Note: This parameter should be used only during the disaggregation process.	
Bill Cycle	Used when you want to update or delete billable charges created for transactions of accounts having a particular bill cycle.	No
	Note: This parameter should be used only during the disaggregation process.	
Disaggregate Transactions From Date	Used when you want to update or delete billable charges created for transactions which were performed from a particular date onwards.	Yes (Conditional)
	Note: You must specify the date in the YYYY-MM-DD format. This parameter should be used only during the disaggregation process.	
Request Type	Used to indicate the process during which you want to execute the batch. The valid values are: <ul style="list-style-type: none"> • CNCL • EROR • DISAGG 	Yes
Chunk Size	Used to specify the number of transactions you want to execute in each work unit.	Yes
Maximum Batch Count	Used to specify the maximum number of transactions after which the data must be transferred to the database.	Yes
Thread Pool Name	Used to specify the thread pool on which you want to execute the batch.	No

Related Topics

For more information on...	See...
Transaction Leg Status Transition	Transaction Leg Status Transition on page 1196
How to set the C1_FM feature configuration	Setting the C1_FM Feature Configuration on page 3453

Transaction Aggregation Batch Processing

During the transaction aggregation process, you need to execute the following batches in the specified order:

1. Flush All Caches (F1-FLUSH)
2. Refresh Pricing (C1-TXNRP)
3. Header Validation (C1-TXNHV)

4. Validate Transaction and Derive Price Item (C1-TXNIP)
5. Price Item Pricing Verification (C1-TXNVP)
6. Update Status (C1-TXNEX)
7. Service Quantity Calculation (C1-TXNSQ)
8. Mark Completion (C1-TXNCM)
9. Clean Up (C1-TXNCU) with the **Request Type** parameter set to **EROR**

The **Validate Transaction and Derive Price Item (C1-TXNIP)** batch locks the **CI_TXN_DTL_PRITM_SUMMARY** table before inserting records to ensure that only unique records are inserted in this table. The locking mechanism results in performance issue when there is no or very little aggregation of transactions. Therefore, we recommend you to use an alternative transaction aggregation process when the aggregation ratio is low. You can enable the alternative transaction aggregation process by setting the **Use C1-TXNPS During Transaction Aggregation** option type in the **C1_FM** feature configuration to **true**. In this alternative transaction aggregation process, you need to execute the following batches in the specified order:

1. Flush All Caches (F1-FLUSH)
2. Refresh Pricing (C1-TXNRP)
3. Header Validation (C1-TXNHV)
4. Validate Transaction and Derive Price Item (C1-TXNIP)
5. Populate CI_TXN_DTL_PRITM_SUMMARY Table (C1-TXNPS)
6. Price Item Pricing Verification (C1-TXNVP)
7. Update Status (C1-TXNEX)
8. Service Quantity Calculation (C1-TXNSQ)
9. Mark Completion (C1-TXNCM)
10. Clean Up (C1-TXNCU) with the **Request Type** parameter set to **EROR**

The following figure graphically explains the sequence in which you need to execute the batches during the transaction aggregation process:

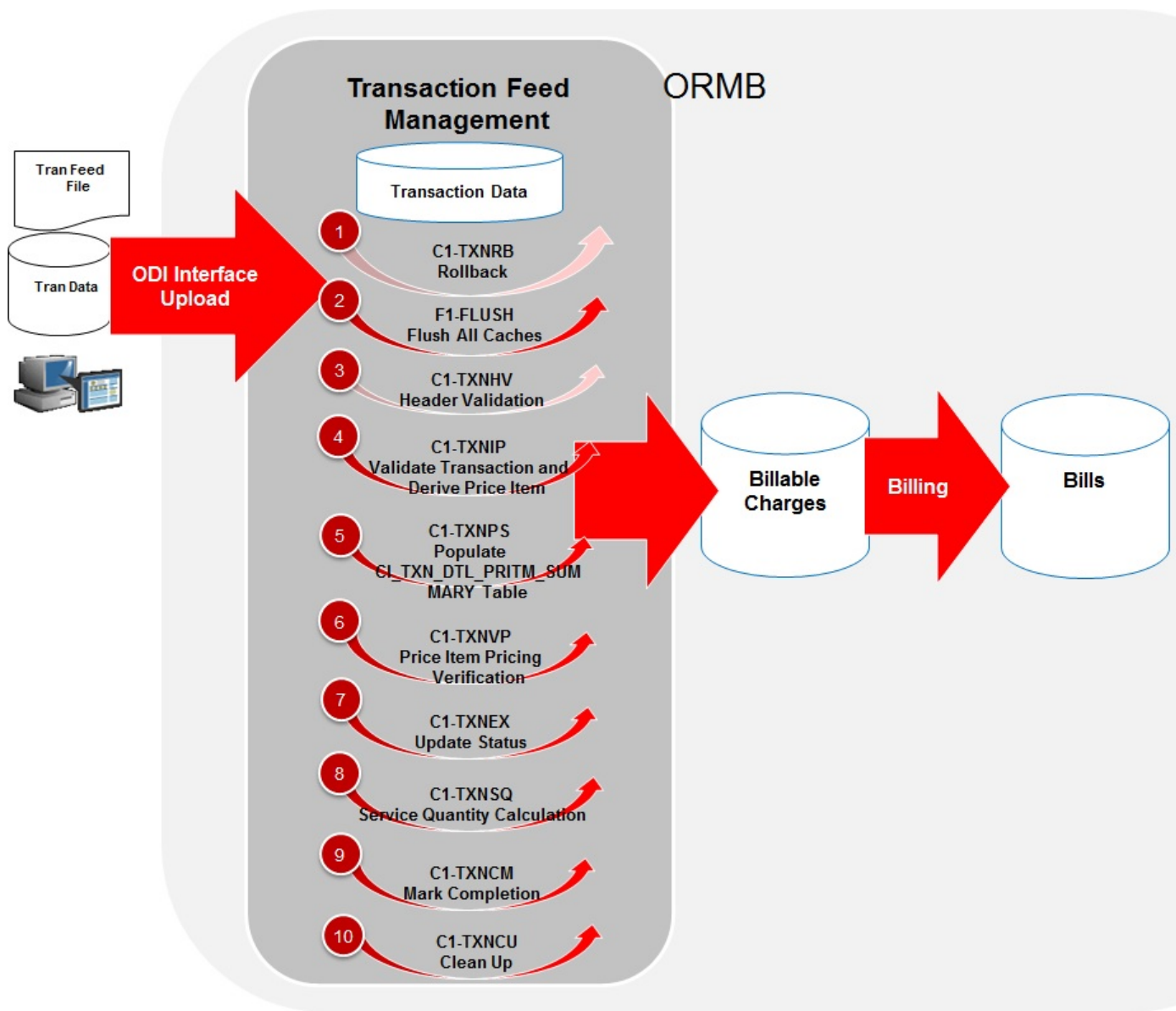

Note:

You need to remember the following points during the transaction aggregation process:

- Before you start the transaction aggregation process, you need to execute the **Flush All Caches (F1-FLUSH)** batch to clean the cache. This batch has one parameter named **Thread Pool** which allows you to clean cache of a particular thread pool. In case you want to reprocess the error transactions from the earlier cycle, you need to execute the **Rollback (C1-TXNRB)** batch.
- You can store the price item pricing information, and thereby improve the **Price Item Pricing Verification (C1-TXNVP)** batch performance. If you set the **Use Materialized Views** option type of the **C1_FM** feature configuration to **true**, the system will store the price item pricing information in the following tables:
 - CI_PRC_AGRD
 - CI_PRC_PL
 - CI_PRC_INH_PL

But, if you set the **Use Materialized Views** option type of the **C1_FM** feature configuration to **false**, the system will not store the price item pricing information in the above mentioned tables. If there are any pricing changes, you can update the price item pricing information in these tables by executing the **Refresh Pricing (C1-TXNRP)** batch.

- The **Header Validation (C1-TXNHV)** batch is optional. You can directly execute the **Validate Transaction and Derive Price Item (C1-TXNIP)** batch once the transactions are uploaded in the system.
- The system allows you to execute each batch consecutively. You can execute the **Validate Transaction and Derive Price Item (C1-TXNIP)** batch consecutively with the same division and same parameters, or with the different division and different parameters. But, you cannot execute the **Validate Transaction and Derive Price Item (C1-TXNIP)** batch consecutively with the same division and different parameters. For example, once you execute this batch with division as D1 and transaction source as S1, you cannot execute this batch again with division as D1 and transaction source as S2 until the former transaction aggregation cycle is complete.
- Once the **Price Item Pricing Verification (C1-TXNVP)** batch is executed, you cannot execute the **Validate Transaction and Derive Price Item (C1-TXNIP)** batch again with the same division and same parameters unless and until the transaction aggregation cycle is complete. Similarly, once the **Service Quantity Calculation (C1-TXNSQ)** batch is executed, you cannot execute the **Price Item Pricing Verification (C1-TXNVP)** batch again with the same division and same parameters unless and until the transaction aggregation cycle is complete. This rule is applicable to all subsequent batches in the transaction aggregation cycle.
- During the transaction aggregation process, you must specify the same division and same parameters across each batch. Otherwise, erroneous results might occur.
- If you have already executed the **Validate Transaction and Derive Price Item (C1-TXNIP)** batch without any division, then you cannot execute this batch once again with a division unless and until the transaction aggregation cycle is complete.

Transaction Disaggregation

As the aggregation cycle is different from the billing cycle, there might be situations when due to pricing changes, the billable charges are no longer valid. In such cases, you need to disaggregate the transactions. In the following scenarios, the system automatically creates a disaggregation request in the CI_TXN_DISAGG_REQ table:

If...	Then
A price item is assigned to an account	A disaggregation request is created for the account.

If...	Then
<p>The following values in the price item pricing assigned to an account is changed:</p> <ul style="list-style-type: none"> • Effective Start Date • Effective End Date • Aggregation Schedule • Ignore Transaction • Aggregate Transaction • Rating Criteria • Price Item Parameter 	<p>A disaggregation request is created for the account.</p>
<p>A price item is assigned to a person</p>	<p>A disaggregation request is created for each account of the person and its child person.</p>
<p>The following values in the price item pricing assigned to a person is changed:</p> <ul style="list-style-type: none"> • Effective Start Date • Effective End Date • Aggregation Schedule • Ignore Transaction • Aggregate Transaction • Rating Criteria • Price Item Parameter 	<p>A disaggregation request is created for each account of the person and its child person.</p>
<p>A price list is assigned to an account.</p>	<p>A disaggregation request is created for the account.</p>
<p>The following values in the price list assigned to an account is changed:</p> <ul style="list-style-type: none"> • Effective Start Date • Effective End Date • Priority • Price List Inheritance 	<p>A disaggregation request is created for the account.</p>
<p>A price list is assigned to a person.</p>	<p>A disaggregation request is created for each account of the person and its child person.</p>
<p>The following values in the price list assigned to a person is changed:</p> <ul style="list-style-type: none"> • Effective Start Date • Effective End Date • Priority • Price List Inheritance 	<p>A disaggregation request is created for each account of the person and its child person.</p>

However, there are various other scenarios for which you have to disaggregate the transactions. But, at the moment, the system does not automatically create a disaggregation request for these scenarios in the CL_TXN_DISAGG_REQ table. You will have to create an appropriate disaggregation request in this table. The system allows you to create a

disaggregation request manually through the **Disaggregation Request** screen or through a batch named **Disaggregation Request Creation (C1-DISTG)**.

In the following scenarios, you have to create an appropriate disaggregation request for the account or person, respectively:

- Effective price item pricing assigned to an account is overridden.
- Variance parameter in the price item pricing assigned to an account is changed.
- A price list assignment has expired or a price list is no longer available to an account.
- Effective price item pricing assigned to a person is overridden.
- Variance parameter in the price item pricing assigned to a person is changed.
- A price list assignment has expired or a price list is no longer available to a person.
- A price item is added to a price list.
- The following details in the price item pricing assigned to a price list is changed:
 - Variance Parameter
 - Effective Start Date
 - Effective End Date
 - Aggregation Schedule
 - Ignore Transaction
 - Rating Criteria
 - Aggregate Transaction
- A new bundle is created.
- A price item is added to a bundle.
- A price item is removed from a bundle.
- A bundle is eliminated (that is, all its price item are removed).
- A price item is added.
- A price list hierarchy is changed.
- SQIs associated with a price item - division combination are changed.
- Transaction aggregation rule defined for an SQI is changed or deleted.
- Business rules used for initial price item mapping are changed.

At present, the system disaggregates transactions at the account level and not at the price item level. Let us understand this with the help of an example. The following table lists the accounts and price items to which T1 is mapped:

Transaction	Account	Price Item
T1	A1	P1
T1	A1	P2
T1	A2	P1
T1	A2	P2

Now, if the pricing of P1 assigned to A1 changes, the system creates a disaggregation request for A1 and identifies all transaction legs which are mapped to A1 for disaggregation. In this example, the system will consider the first two transaction legs - T1-A1-P1 and T1-A1-P2 - for disaggregation even if the pricing of P2 assigned to A1 has not changed.

The **Disaggregation Request Creation (C1-DISTG)** batch creates a disaggregation request for an account. When you create a disaggregation request for an account, the transactions mapped to the account are disaggregated. This batch is a multi-threaded batch. The multi-threading is based on account ID and chunks for multi-threading are created based on numerical distribution of account ID. You can specify either of the following parameters while executing this batch:

Parameter Name	Description	Mandatory (Yes or No)
Division	Used when you want to create disaggregation request for accounts belonging to a particular division.	No
Person ID	Used when you want to create disaggregation request for accounts belonging to a particular person.	No
Bill Cycle	Used when you want to create disaggregation request for accounts having a particular bill cycle.	No
Disaggregate Transactions From Date	Used when you want to create disaggregation request for accounts for which transactions were performed from a particular date onwards.	Yes
	Note: You must specify the date in the YYYY-MM-DD format.	
Thread Pool Name	Used to specify the thread pool on which you want to execute the batch.	No

Before you proceed with the disaggregation process, you need to ensure that there are no pending bills for the accounts whose transactions need to be disaggregated. If there are pending bills for these accounts, you need to first execute the **Pending Bill Segments Deletion (C1-BSEGD)** batch and then execute the **Pending Bill Deletion (C1-PNBD)** batch. While executing these batches in the specified order, ensure that you specify the same parameters in both these batches. For more information about these batches, see *Oracle Revenue Management and Billing Batch Execution Guide*.

Note: The **Pending Bill Deletion (C1-PNBD)** batch deletes those pending bills which are generated through the billing batches (i.e. **BILLING** or **C1-PNDBL**). It does not delete pending bills which are generated through the user interface. Also, it deletes regular pending bills and not adhoc pending bills.

Once a disaggregation request is either manually or automatically created for an account, you need to execute the following batches in the specified order to disaggregate transactions:

- **Identify Transactions for Disaggregation (C1-IDENT)** - This batch fetches disaggregation requests which are created for accounts from the CI_TXN_DISAGG_REQ table. It identifies the transactions and the corresponding aggregated and non-aggregated billable charges for disaggregation. If the bill segment of a billable charge is in the **Pending Cancel** or **Frozen** status, the system will not identify the billable charge for deletion. You can specify either of the following parameters while executing this batch:

Parameter Name	Description	Mandatory (Yes or No)
Division	Used when you want to identify the transactions of accounts belonging to a particular division for disaggregation.	No
Account ID	Used when you want to identify the transactions of a particular account for disaggregation.	No
Bill Cycle	Used when you want to identify the transactions of accounts having a particular bill cycle for disaggregation.	No

Parameter Name	Description	Mandatory (Yes or No)
Disaggregate Transactions From Date	Used when you want to identify the transactions which were performed from a particular date onwards for disaggregation.	No
	<p>Note:</p> <p>You must specify the date in the YYYY-MM-DD format.</p> <p>The aggregated billable charge, which is affected, should not contain a transaction leg whose transaction date is earlier than the date specified in this parameter. Otherwise, erroneous results will occur. Therefore, ensure that you specify the appropriate value for the Disaggregate Transactions From Date parameter.</p>	
Chunk Size	Used to specify the number of transactions you want to execute in each work unit.	Yes
Maximum Batch Count	Used to specify the maximum number of transactions after which the data must be transferred to the database.	Yes
Post-Processing Algorithm	Used to attach a post-processing algorithm. This algorithm is triggered once the transactions and corresponding billable charges are identified for disaggregation.	No
Exclude Canceled Billable Charges (Y or N)	Used to indicate whether you want to exclude the aggregated and non-aggregated billable charges which are in the Canceled status during the disaggregation process. The valid values are:	No
	<ul style="list-style-type: none"> • Y • N <p>Note: If you do not specify any value, by default, the parameter value is set to N.</p>	
Thread Pool Name	Used to specify the thread pool on which you want to execute the batch.	No

- **Process Non-Aggregated Transactions (C1-PDTXN)** - This batch processes the identified transactions, deletes the required transaction legs, and changes the status of the transaction to **Uploaded (UPLD)**. If a non-aggregated billable charge exists for a transaction leg and the corresponding bill segment is in the **Cancel** status, then:
 - The billable charge is cancelled.
 - The corresponding transaction leg and calculation lines (if any) are deleted.
 - The status of the transaction is changed to **Uploaded (UPLD)**.

However, if a non-aggregated billable charge exists for a transaction leg, but if the bill segment is not yet generated, then the billable charge, the corresponding calculation lines (if any), and transaction leg are deleted, and the status of the transaction is changed to **Uploaded (UPLD)**. If a non-aggregated billable charge is in the **Cancel** status, then the corresponding transaction leg and calculation lines (if any) are deleted and the status of the transaction is changed to **Uploaded (UPLD)**. If the rate is determined for a transaction leg which is in the **Ignored (IGNR)** status, the calculation lines are deleted along with the transaction leg during disaggregation.

If aggregated billable charge exists for a transaction leg, then the corresponding transaction legs and calculation lines (if any) are deleted and the status of the transaction is changed to **Uploaded (UPLD)**. You can specify either of the following parameters while executing this batch:

Parameter Name	Description	Mandatory (Yes or No)
Division	Used when you want to disaggregate the transactions of accounts belonging to a particular division.	No
Account ID	Used when you want to disaggregate the transactions of a particular account.	No
Bill Cycle	Used when you want to disaggregate the transactions of accounts having a particular bill cycle.	No
Disaggregate Transactions From Date	Used when you want to disaggregate the transactions which were performed from a particular date onwards. Note: You must specify the date in the YYYY-MM-DD format.	Yes
Chunk Size	Used to specify the number of transactions you want to execute in each work unit.	Yes
Maximum Batch Count	Used to specify the maximum number of transactions after which the data must be transferred to the database.	Yes
Thread Pool Name	Used to specify the thread pool on which you want to execute the batch.	No

Note:

If you want to undertake some preprocessing activities (such as cleaning data in any custom tables) during the disaggregation process, you need to attach a preprocessing algorithm on the **TFM - Disaggregation Pre-Processing** algorithm entity in the **Algorithms** tab of the **Division** screen. This algorithm is triggered when you execute the **Process Non-Aggregated Transactions (C1-PDTXN)** batch. Note that the system invokes the algorithm which is attached on the derived account's division and not on the division to which the transaction belongs.

A sample preprocessing algorithm type named **C1_DSAG_PRPC** is shipped with the product. It does not have any business logic. If you want to undertake some preprocessing activities during the disaggregation process, you need to create custom algorithm type and attach the respective algorithm on the **TFM - Disaggregation Pre-Processing** algorithm spot of the respective division. You can refer to the **C1_DSAG_PRPC** algorithm type to understand the input parameters that must be passed to the custom algorithm type.

- **Clean Up (C1-TXNCU)** - This batch deletes an aggregated billable charge when all the corresponding transaction legs which were aggregated in the billable charge are deleted during disaggregation. If an aggregated billable charge exists for a transaction leg and the corresponding bill segment is in the **Cancel** status, then:
 - The billable charge is cancelled.
 - The status of the transaction is changed to **Uploaded (UPLD)**.

However, if an aggregated billable charge exists for a transaction leg, but if the bill segment is not yet generated, then the billable charge, and the corresponding calculation lines (if any) are deleted, and the status of the transaction is changed to **Uploaded (UPLD)**. If an aggregated billable charge is in the **Cancel** status, then the corresponding calculation lines (if any) are deleted and the status of the transaction is changed to **Uploaded (UPLD)**.

While executing the **Clean Up (C1-TXNCU)** batch during disaggregation, you must set the **Request Type** parameter to **DISAGG**. For more information about the parameters that you can specify while executing this batch, refer to [Clean Up](#) on page 1172.

- **Update Disaggregation Request Status (C1-DRSUA)** - This batch changes the status of the disaggregation request in the **CI_TXN_DISAGG_REQ** table to **COMPLETE**. You can specify either of the following parameters while executing this batch:

Parameter Name	Description	Mandatory (Yes or No)
Account ID	Used when you want to update the disaggregation requests' status of a particular account.	No
Division	Used when you want to update the disaggregation requests' status of accounts belonging to a particular division.	No
Bill Cycle	Used when you want to update the disaggregation requests' status of accounts having a particular bill cycle.	No
Disaggregate Transactions From Date	Used when you want to update the disaggregation requests' status of accounts whose transactions were performed from a particular date onwards and the bill segments created for these transactions are in the Pending Cancel or Frozen status. Note: You must specify the date in the YYYY-MM-DD format.	Yes
Chunk Size	Used to specify the number of transactions you want to execute in each work unit.	Yes
Update Status Algorithm	Used to attach a custom algorithm which indicates when the status of the disaggregation request in the CI_TXN_DISAGG_REQ table must be changed to COMPLETE . Note: If an algorithm is specified in this parameter, the system uses the custom logic and not the in-built logic for updating the status of the disaggregation requests.	No
Exclude Canceled Billable Charges (Y or N)	Used to indicate whether you want to change the status of the disaggregation request to COMPLETE when the canceled billable charges are excluded during the disaggregation process. The valid values are: <ul style="list-style-type: none"> • Y • N Note: If you do not specify any value, by default, the parameter value is set to N. You must specify the same value for this parameter while executing the Identify Transactions for Disaggregation (C1-IDENT) and Update Disaggregation Request Status (C1-DRSUA) batches during the disaggregation process. Otherwise, erroneous results will occur.	No

Parameter Name	Description	Mandatory (Yes or No)
Thread Pool Name	Used to specify the thread pool on which you want to execute the batch.	No

Related Topics

For more information on...	See...
Transaction Leg Status Transition	Transaction Leg Status Transition on page 1196
How to create a disaggregation request manually	Creating a Disaggregation Request

Transaction Disaggregation Batch Processing

During the transaction disaggregation process, you need to execute the following batches in the specified order:

1. Disaggregation Request Creation (C1-DISTG)
2. Pending Bill Segments Deletion (C1-BSEGD)
3. Pending Bill Deletion (C1-PNBD)
4. Identify Transactions for Disaggregation (C1-IDENT)
5. Process Non-Aggregated Transactions (C1-PDTXN)
6. Clean Up (C1-TXNCU) with the **Request Type** parameter set to **DISAGG**
7. Update Disaggregation Request Status (C1-DRSUA)

The following figure graphically explains the sequence in which you need to execute the batches during the transaction disaggregation process:

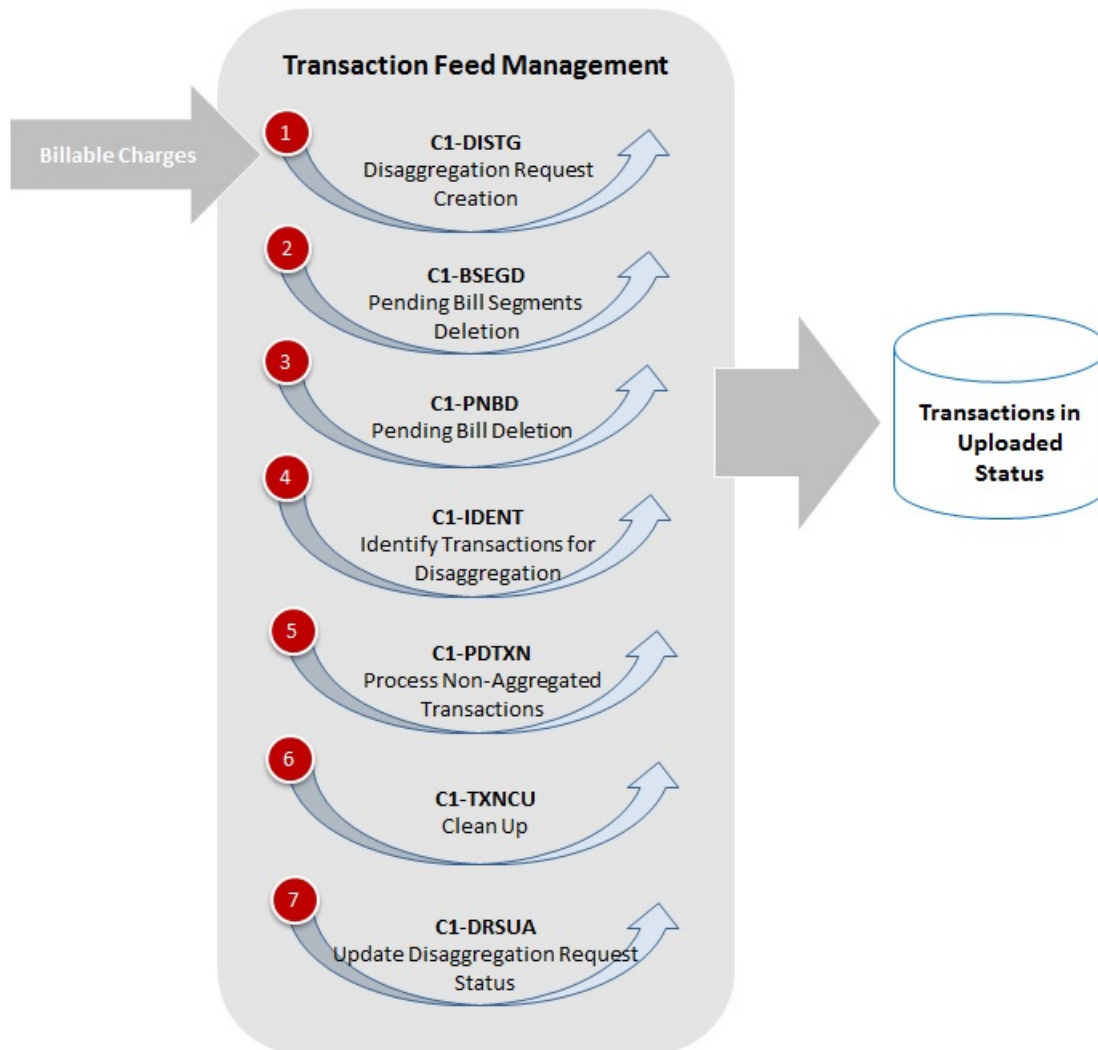

Reseeding

In the self-funded health insurance business, there might be situations when you may want to disaggregate the claim, enrollment, and ancillary transactions. The system enables you to disaggregate the claim, enrollment, and ancillary transactions until these transactions are not billed to the customer. If a transaction is billed to the customer, you cannot disaggregate the transaction using the normal transaction disaggregation process.

In the following scenarios, you may want to disaggregate the claim or ancillary transactions once these are billed to the customer:

- The changes are made to the specific stop-loss (SSL), aggregate stop-loss (ASL), discount arrangement, or level funded pricing rule which is used during the transaction aggregation process.
- A new pricing rule is created using a specific stop-loss (SSL) or aggregate stop-loss (ASL) pricing rule type which is added in the claim or ancillary pricing rule type using which the claim or ancillary transaction is processed.
- A new pricing rule is created using a discount arrangement pricing rule type which is added in the claim or ancillary pricing rule type using which the claim or ancillary transaction is processed.
- A new pricing rule is created using a level funded pricing rule type which is added in the claim or ancillary pricing rule type using which the claim or ancillary transaction is processed.

- A specific stop-loss, aggregate stop-loss, discount arrangement, or level funded pricing rule type is added as related pricing rule type in the claim or ancillary pricing rule type using which the claim or ancillary transaction is processed.

The former scenario arises due to change in pricing rule, whereas the latter four scenarios arise due to the late setup. In such scenarios, you can create the **Accumulation Group Based Disaggregation Request** (also known as **Reseeding Request**) to disaggregate the claim and ancillary transactions. In the **Accumulation Group Based Disaggregation** (also known as **Reseeding**) feature, the system allows you to create the reseeding requests for the accounts using a parent accumulation group. At present, you can create the reseeding requests for the accounts only from the user interface and not through the **Disaggregation Request Creation (C1-DISTG)** batch.

While creating a reseeding request using the **Parent Accumulation Group** request type, you can specify the accumulation type (i.e. whether it is stop-loss or discount arrangement). If the accumulation type is set to **Stop Loss**, the system provides the **Disaggregate All Account** option. If you select the **Disaggregate All Account** option, the system considers accounts of all bill groups of the parent customer (for whom the parent accumulation group is created) and then creates a reseeding request for each such account. However, if you do not select the **Disaggregate All Account** option, the system considers accounts of only those bill groups where the parent accumulation group is used for creating the specific stop-loss and aggregate stop-loss pricing rules and then creates a reseeding request for each such account. In addition, the system creates a reseeding request for the ASSL and ASL Credit accounts which are specified in the specific stop-loss and aggregate stop-loss pricing rules, respectively. Note that the reseeding requests are created for the ASSL and ASL Credit accounts irrespective of whether the **Disaggregate All Account** option is selected or not.

However, if the accumulation type is set to **Discount Arrangement**, the system does not provide the **Disaggregate All Account** option. In this case, the system, by default, considers accounts of all bill groups of the parent customer (for whom the parent accumulation group is created) and then creates a reseeding request for each such account.

Note: In the late setup scenarios, you need to ensure that the pricing rules are created before you create the reseeding requests for accounts.

In the **Reseeding** process, you need to execute the following batches in the specified sequence:

1. **Identify Transactions for Disaggregation (C1-IDENT)** - It fetches the reseeding requests for accounts and then identifies the claim or ancillary transactions for disaggregation. If the reseeding request is created due to change in a pricing rule, the **BILLABLE_CHG_ACT_CD** column corresponding to the specific stop-loss, aggregate stop-loss, discount, or level-funded billable charges in the **CI_DISAGG_BCHG_DETAIL** table is set to **Billable Charge is Part of Frozen Bill Segment (40)**. It indicates that no action must be taken on these billable charges. And, if the reseeding request is created due to the late setup scenarios, the claim or ancillary transaction and its legs are moved to the **CI_TXN_DETAIL_STG** and **CI_TXN_DTL_PRITM_STG** tables, respectively. In addition, the status of the claim or ancillary transaction is changed to **Uploaded**. For more information about the parameters, refer to *ORMB - Transaction Feed Management - Batch Execution Guide*.
2. **Process Non-Aggregated Transactions (C1-PDTXN)** - If the reseeding request is created due to change in a pricing rule, it does the following:
 - The specific stop-loss, aggregate stop-loss, discount arrangement, and stop-loss and discount specific level funded transaction legs, whose corresponding bill segments are in the **Frozen** or **Pending Cancel** status, are forcibly deleted from the **CI_TXN_DTL_PRITM** table.
 - The specific stop-loss, aggregate stop-loss, discount arrangement, and stop-loss and discount specific level funded transaction legs, whose corresponding bill segments are in a status other than **Frozen** or **Pending Cancel**, are moved to the **CI_TXN_DTL_PRITM_STG** table. And, the claim or ancillary transaction is moved to the **CI_TXN_DETAIL_STG** table and its status is changed to **Uploaded**.

Irrespective of whether the reseeding request is created due to change in a pricing rule or the late setup scenarios, this batch does not perform any actions on the claim, claim based fee, and ancillary transaction legs and their billable charges. For more information about the parameters, refer to *ORMB - Transaction Feed Management - Batch Execution Guide*.

3. **Transaction Cleanup Batch (C1-TXNCU)** - While executing the **Clean Up (C1-TXNCU)** batch during reseeding, you must set the **Request Type** parameter to **DISAGG**. For more information about the parameters, refer to *ORMB - Transaction Feed Management - Batch Execution Guide*.

- 4. Update Disaggregation Request Status (C1-DRSUA)** - Once the claim or ancillary transaction is successfully disaggregated, the status of the reseeded request is changed to **COMPLETE**. For more information about the parameters, refer to *ORMB - Transaction Feed Management - Batch Execution Guide*.

When you re-aggregate the claim or ancillary transactions which were disaggregated due to late setup, the system creates the specific stop-loss, aggregate stop-loss, discount arrangement, and stop-loss and discount specific level funded transaction legs and their billable charges. However, when you re-aggregate the claim or ancillary transactions which were disaggregated due to change in a pricing rule, the system creates the specific stop-loss, aggregate stop-loss, discount arrangement, and stop-loss and discount specific level funded transaction legs and the billable charges for the delta amount (which resulted due to change in pricing).

If the accumulation type is set to **Stop Loss**, the system deletes the specific stop-loss transaction legs. In addition, it deletes the aggregate stop-loss transaction legs (if any), discount arrangement transaction legs (if any), and level funded transaction legs (if any) whose calculation is based on the specific stop-loss transaction legs.

However, if the accumulation type is set to **Discount Arrangement**, the system deletes the discount arrangement transaction legs. It deletes the specific stop-loss transaction legs (if any), aggregate stop-loss transaction legs (if any), and level funded transaction legs (if any) when the discount arrangement pricing rule is used in the specific stop-loss pricing rule. However, it deletes the aggregate stop-loss transaction legs (if any) and level funded transaction legs (if any) when the discount arrangement pricing rule is used in the aggregate stop-loss pricing rule.

For example, the CLAIM pricing rule type contains the SSL, ASL, DISCOUNT, and LEVEL FUNDED pricing rule types as the related pricing rule types, and the SSL and ASL pricing rules contain the following discount arrangement pricing rules:

Discount Arrangement Pricing Rule	Included in the SSL Pricing Rule (Yes or No)	Included in the ASL Pricing Rule (Yes or No)
DISCOUNT1	Yes	No
DISCOUNT2	No	Yes

Now, if the reseeded request (where the accumulation type is set to **Stop Loss**) is created for an account due to change in the SSL pricing rule, the system behaves in the following manner for the C1 claim transaction:

Transaction Leg	Existing Transaction Leg Deleted (Yes or No)	New Transaction Leg Created (Yes or No)	Existing Billable Charge Deleted (Yes or No)	New Billable Charge Created for Delta Charges (Yes or No)
Claim	No	No	No	No
SSL	Yes	Yes	No	Yes
ASL	Yes	Yes	No	Yes
DISCOUNT	No	No	No	No
LEVEL FUNDED	Yes	Yes	No	Yes
DISCOUNT1	Yes	Yes	No	Yes
DISCOUNT2	Yes	Yes	No	Yes

However, if the reseeded request (where the accumulation type is set to **Discount Arrangement**) is created for an account due to change in the DISCOUNT2 pricing rule, the system behaves in the following manner for the C1 claim transaction:

Transaction Leg	Existing Transaction Leg Deleted (Yes or No)	New Transaction Leg Created (Yes or No)	Existing Billable Charge Deleted (Yes or No)	New Billable Charge Created for Delta Charges (Yes or No)
Claim	No	No	No	No
SSL	No	No	No	No
ASL	Yes	Yes	No	Yes
DISCOUNT	No	No	No	No
LEVEL FUNDED	Yes	Yes	No	Yes
DISCOUNT1	No	No	No	No
DISCOUNT2	Yes	Yes	No	Yes

Let us take another example where the related pricing rule types are not specified in the CLM1 pricing rule type. Therefore, the system just created claim-specific transaction legs and billable charges for the C2 claim transaction. These claim billable charges are then billed to the customer. Now, if you add the SSL and ASL pricing rule types as the related pricing rule types in the CLM1 pricing rule type and create a reseeding request (where the accumulation type is set to **Stop Loss**) for an account, the system behaves in the following manner for the C2 claim transaction when the transaction incurred and paid dates fall within the incurred and paid date ranges defined in the parent accumulation group:

Transaction Leg	Existing Transaction Leg Deleted (Yes or No)	New Transaction Leg Created (Yes or No)	Existing Billable Charge Deleted (Yes or No)	New Billable Charge Created for Delta Charges (Yes or No)
Claim	No	No	No	No
SSL	Not applicable	Yes	Not applicable	Yes
ASL	Not applicable	Yes	Not applicable	Yes
DISCOUNT1	Not applicable	Yes	Not applicable	Yes
DISCOUNT2	Not applicable	Yes	Not applicable	Yes

Transaction Cancellation

There might be situations when incorrect transaction data file is uploaded in the system. In such cases, the system provides you with an ability to cancel the whole transaction feed. You can cancel a transaction feed either before the transaction aggregation process starts (that is, before executing the **Validate Transaction and Derive Price Item (C1-TXNIP)** batch) or after the transaction aggregation process ends (that is, after executing the **Clean Up (C1-TXNCU)** batch). In other words, you cannot cancel a transaction feed during the transaction aggregation process. Once the transaction feed is cancelled, the status of the feed and all transactions in the feed is changed to **Cancelled (CNCL)**.

The following table explains how the system behaves:

When you cancel a transaction feed for which...	Then
<p>A bill (with the Pending status) is already generated in the system</p>	<p>The corresponding billable charges, bill segments, and bill are deleted. The corresponding transaction legs and their calculation lines (if any) are deleted, and the status of the transactions is changed to Cancelled (CNCL).</p> <p>Note:</p> <p>If a pending bill has a bill segment in the Frozen or Pending Cancel status, the system does not allow you to cancel the transaction feed.</p> <p>If a pending bill has a bill segment in the Cancel status, the system behaves in the following manner:</p> <ul style="list-style-type: none"> • Deletes all other bill segments which are not in the Cancel status. • The billable charge corresponding to the bill segment which is not in the Cancel status is deleted if the billable charge is in the Billable status and if the billable charge only includes transactions from the feed that you want to cancel. • The billable charge corresponding to the bill segment which is not in the Cancel status is not deleted or recalculated if the billable charge is in the Cancelled status. • The billable charge corresponding to the bill segment which is in the Cancel status is cancelled if the billable charge only includes transactions from the feed that you want to cancel. • The SQIs in the billable charge are recalculated if the billable charge includes transactions from multiple feeds. <p>If a bill is created for transactions which are uploaded through multiple transaction feeds (for example, Feed A and Feed B and you want to cancel Feed A), then:</p> <ul style="list-style-type: none"> • The bill and their corresponding bill segments are deleted. • The SQIs are recalculated in the corresponding billable charges. • The legs of transactions uploaded through Feed A and the corresponding calculation lines (if any) are deleted. • The status of the transactions uploaded through Feed A is changed to Cancelled (CNCL). • The status of Feed A is changed to Cancelled (CNCL). • The status of the transactions uploaded through Feed B remains the same (i.e. Completed (COMP)).
<p>A bill (with the Complete status) already exists in the system</p>	<p>The system does not allow you to cancel the transaction feed.</p>

When you cancel a transaction feed for which...	Then
A bill (with the Complete status) has all bill segments in the Cancelled status	The corresponding billable charges are cancelled. The corresponding transaction legs and their calculation lines (if any) are deleted, and the status of the transactions is changed to Cancelled (CNCL) .
A billable charge (with the Billable status) exists in the system	<p>The billable charge is deleted. The corresponding transaction legs and their calculation lines (if any) are deleted, and the status of the transactions is changed to Cancelled (CNCL).</p> <p>Note:</p> <p>In case a billable charge is created for transactions uploaded through multiple transaction feeds (for example, Feed A and Feed B and you want to cancel Feed A), then:</p> <ul style="list-style-type: none"> • The SQIs are recalculated in the billable charge. • The legs of transactions uploaded through Feed A and the corresponding calculation lines (if any) are deleted. • The status of the transactions uploaded through Feed A is changed to Cancelled (CNCL). • The status of Feed A is changed to Cancelled (CNCL). • The status of the transactions uploaded through Feed B remains the same (i.e. Completed (COMP)).
A billable charge (with the Cancelled status) exists in the system	The billable charge is not deleted. However, the corresponding transaction legs and their calculation lines (if any) are deleted and the status of the transactions is changed to Cancelled (CNCL) .

To cancel a transaction feed, you need to execute the following batches in the specified order:

1. **Pending Bill Deletion (C1-DELBL)** — This batch deletes the bills (with the **Pending** status) and their corresponding bill segments. You can specify either of the following parameters while executing this batch:

Parameter Name	Description	Mandatory (Yes or No)
Transaction Header ID	Used when you want to delete bills which include charges for transactions which are received in a particular transaction feed.	Yes
Chunk Size	Used to specify the number of transactions you want to execute in each work unit.	Yes
Maximum Batch Count	Used to specify the maximum number of transactions after which the data must be transferred to the database.	Yes
Thread Pool Name	Used to specify the thread pool on which you want to execute the batch.	No

2. **Clean Up (C1-TXNCU)** — This batch deletes non-aggregated and aggregated billable charges. An aggregated billable charge is deleted when it includes legs of transactions from the feed that you want to cancel. If an aggregated billable charge includes legs of transactions from multiple feeds, the SQIs and calculation lines (if any) are recalculated in the aggregated billable charge. The corresponding calculation lines are deleted whenever an aggregated billable charge, which includes transaction legs whose rating criteria is set to **Aggregate transactions and then rate aggregated SQs (AGTR)**, is cancelled or deleted during the cancellation process. Note that while executing this batch, the **Request Type** parameter must be set to **CNCL**. For more information about the parameters that you can specify while executing this batch, refer to [Clean Up](#) on page 1172.

3. **Cancellation (C1-TXCNC)** — This batch deletes the transaction legs. The corresponding calculation lines are deleted whenever an aggregated billable charge, which includes transaction legs whose rating criteria is set to **Rate individual transactions and aggregate calc lines across transactions (RITA)** or **Rate Transactions (RITX)**, is cancelled or deleted during the cancellation process. Finally, this batch changes the status of the feed and all transactions in the feed to **Cancelled (CNCL)**. You can specify either of the following parameters while executing this batch:

Parameter Name	Description	Mandatory (Yes or No)
Transaction Header ID	Used when you want to cancel a particular transaction feed.	Yes
Chunk Size	Used to specify the number of transactions you want to execute in each work unit.	Yes
Maximum Batch Count	Used to specify the maximum number of transactions after which the data must be transferred to the database.	Yes
Thread Pool Name	Used to specify the thread pool on which you want to execute the batch.	No

Note:

If you want to undertake some preprocessing activities (such as cleaning data in any custom tables) during the cancellation process, you need to attach a preprocessing algorithm on the **TFM - Cancellation Pre-Processing** algorithm entity in the **Algorithms** tab of the **Division** screen. This algorithm is triggered when you execute the **Cancellation (C1-TXCNC)** batch. Note that the system invokes the algorithm which is attached on the derived account's division and not on the division to which the transaction belongs.

A sample preprocessing algorithm type named **C1_CNCL_PRPC** is shipped with the product. It does not have any business logic. If you want to undertake some preprocessing activities during the cancellation process, you need to create custom algorithm type and attach the respective algorithm on the **TFM - Cancellation Pre-Processing** algorithm spot of the respective division. You can refer to the **C1_CNCL_PRPC** algorithm type to understand the input parameters that must be passed to the custom algorithm type.

Related Topics

For more information on...	See...
Transaction Leg Status Transition	Transaction Leg Status Transition on page 1196

Transaction Cancellation Batch Processing

During the transaction cancellation process, you need to execute the following batches in the specified order:

1. Pending Bill Deletion (C1-DELBL)
2. Clean Up (C1-TXNCU) with the **Request Type** parameter set to **CNCL**
3. Cancellation (C1-TXCNC)

The following figure graphically explains the sequence in which you need to execute the batches during the transaction cancellation process:

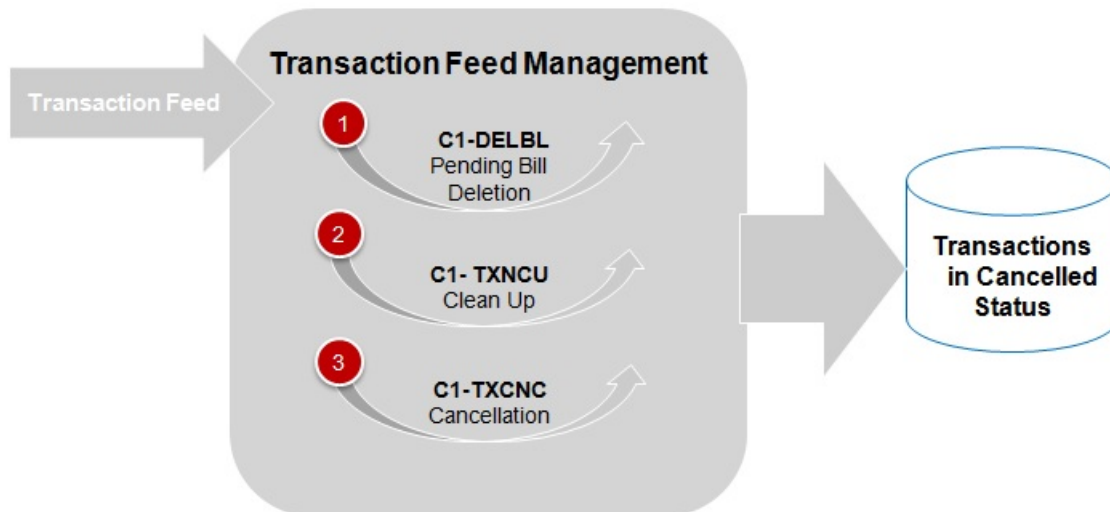

Transaction Rollback

In the transaction aggregation process, an error occurs when:

- Transaction validation fails.
- Transaction does not satisfy any rule invoked through the rule type.
- Effective pricing is not available for one or more price items to which a transaction is mapped.
- SQIs are not defined for the price item — division combination.
- Transaction aggregation rule is not defined for the SQL.
- Exchange rate is not available during currency conversion.
- There is no contract available with the specified contract type on the transaction date or when the contract is inactive.
- There are multiple effective contracts of the same contract type (available on the transaction date) in **Active**, **Pending Stop**, or **Stop** status.
- The **Price Assignment Search** algorithm is not defined for the division.
- The parameter values are either not defined or invalid in the **Price Assignment Search** algorithm on the processing date.
- The period in which the transaction date falls is not defined in the aggregation schedule.
- Price Item parameters specified in the output parameters are not effective for the price item on the processing date.
- Mandatory price item parameter which is effective on the processing date is not specified in the output parameter.
- Parameter value is not specified for all mandatory price item parameters which are effective on the processing date.

In such cases, the status of the transaction is changed to **Error**. You can configure the required setup and then execute the following batches once again in the specified order:

1. Flush All Caches (F1-FLUSH)
2. Refresh Pricing (C1-TXNRP)
3. Header Validation (C1-TXNHV)
4. Validate Transaction and Derive Price Item (C1-TXNIP)
5. Populate CI_TXN_DTL_PRITM_SUMMARY Table (C1-TXNPS)

Note: You must execute the **Populate CI_TXN_DTL_PRITM_SUMMARY Table (C1-TXNPS)** batch when the **Use C1-TXNPS During Transaction Aggregation** option type in the **C1_FM** feature configuration is set to **true**.

6. Price Item Pricing Verification (C1-TXNVP)
7. Update Status (C1-TXNEX)
8. Service Quantity Calculation (C1-TXNSQ)
9. Mark Completion (C1-TXNCM)
10. Clean Up (C1-TXNCU)

But, before you execute these batches, you need to rollback the transaction status to **Uploaded (UPLD)**. The system allows you to rollback transactions which are in the **Ignored (IGNR)** and **Error (EROR)** status. When you rollback a transaction, the corresponding transaction legs are deleted and the status of the transaction is changed to **Uploaded (UPLD)**. On rolling back a transaction leg whose effective pricing has the **Ignore Transaction** field set to **Yes** and the **Rating Criteria** field set to **Rate Transactions (RITX)**, the corresponding calculation lines are also deleted along with the transaction leg. If you rollback a partially disaggregated transaction which is in the **Error (EROR)** status, the transaction legs which are in the **Error (EROR)** status are only deleted and the status of the transaction is changed to **Uploaded (UPLD)**.

You need to execute the **Rollback (C1-TXNRB)** batch to rollback transactions which are in the **Ignored (IGNR)** and **Error (EROR)** status. You can specify the following parameters while executing this batch:

Parameter Name	Description	Mandatory (Yes or No)
Transaction Status	Used to indicate whether you want to rollback transactions which are in the Ignored or Error status. The valid values are: <ul style="list-style-type: none"> • IGNR • EROR 	Yes
Transaction Header ID	Used when you want to rollback transactions which are received in a particular transaction feed.	No
Transaction Source	Used when you want to rollback transactions which are received from a particular transaction source.	No
Division	Used when you want to rollback transactions belonging to a particular division.	No
Rollback From Date	Used when you want to rollback transactions which were performed from a particular date onwards. <p>Note: You must specify the date in the YYYY-MM-DD format. The rollback from date cannot be later than the rollback to date.</p>	No
Rollback To Date	Used when you want to rollback transactions which were performed till a particular date. <p>Note: You must specify the date in the YYYY-MM-DD format. The rollback to date cannot be earlier than the rollback from date.</p>	No

Parameter Name	Description	Mandatory (Yes or No)
Chunk Size	Used to specify the number of transactions you want to execute in each work unit.	Yes
Maximum Batch Count	Used to specify the maximum number of transactions after which the data must be transferred to the database.	Yes
Thread Pool Name	Used to specify the thread pool on which you want to execute the batch.	No

Note:

If you want to undertake some preprocessing activities (such as cleaning data in any custom tables) during the rollback process, you need to attach a preprocessing algorithm on the **Transaction Feed Management Rollback Preprocessing** algorithm entity in the **Algorithms** tab of the **Division** screen. This algorithm is triggered when you execute the **Rollback (C1-TXNRB)** batch. Note that the system invokes the algorithm which is attached on the division to which the transaction belongs.

A sample preprocessing algorithm type named **C1_ROBK_PRPC** is shipped with the product. It does not have any business logic. If you want to undertake some preprocessing activities during the rollback process, you need to create custom algorithm type and attach the respective algorithm on the **TFM - Rollback Pre-Processing** algorithm spot of the respective division. You can refer to the **C1_ROBK_PRPC** algorithm type to understand the input parameters that must be passed to the custom algorithm type.

Related Topics

For more information on...	See...
Transaction Leg Status Transition	Transaction Leg Status Transition on page 1196

Feed Status Transition

The following figure graphically indicates how a feed moves from one status to another during the transaction feed management process:

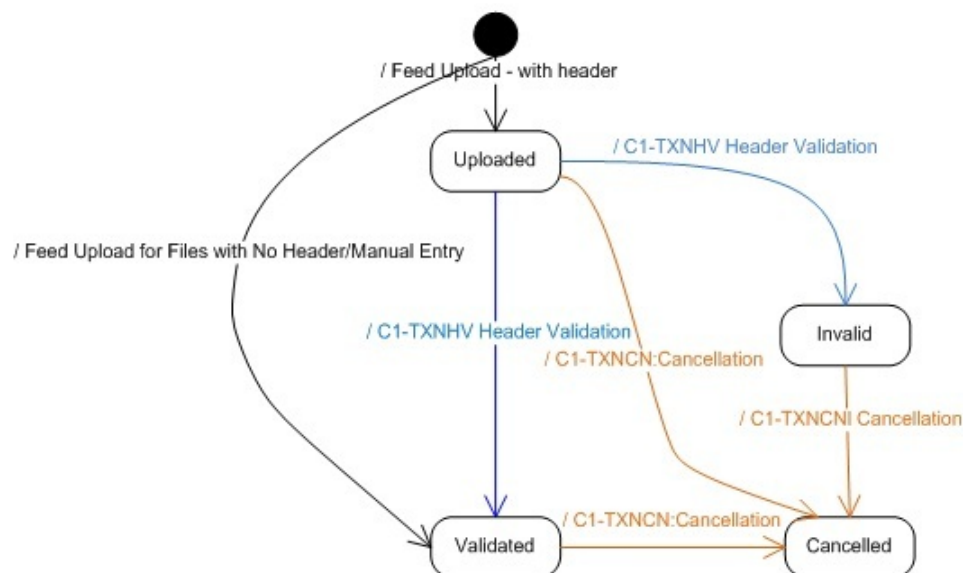

Transaction Status Transition

Aggregation

The following figure graphically indicates how a transaction moves from one status to another during the aggregation process:

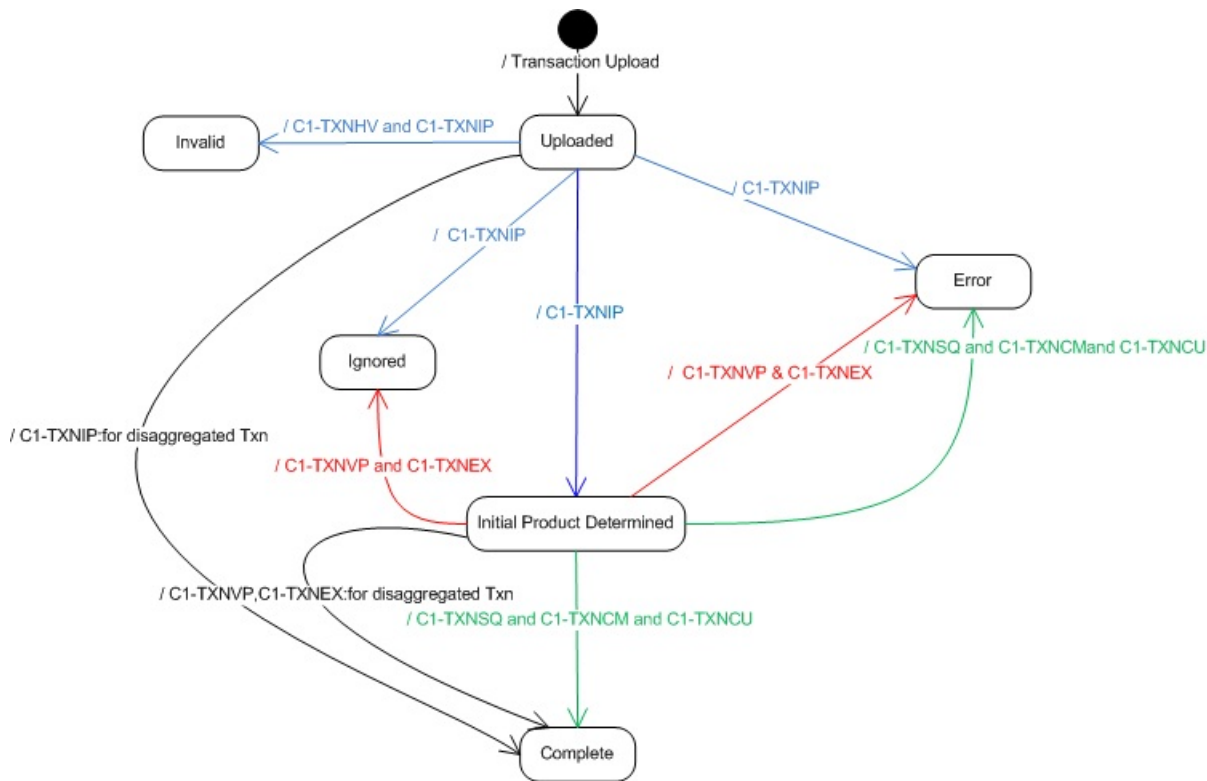

Disaggregation, Rollback, and Cancellation

The following figure graphically indicates how a transaction moves from one status to another during the disaggregation, rollback, and cancellation processes:

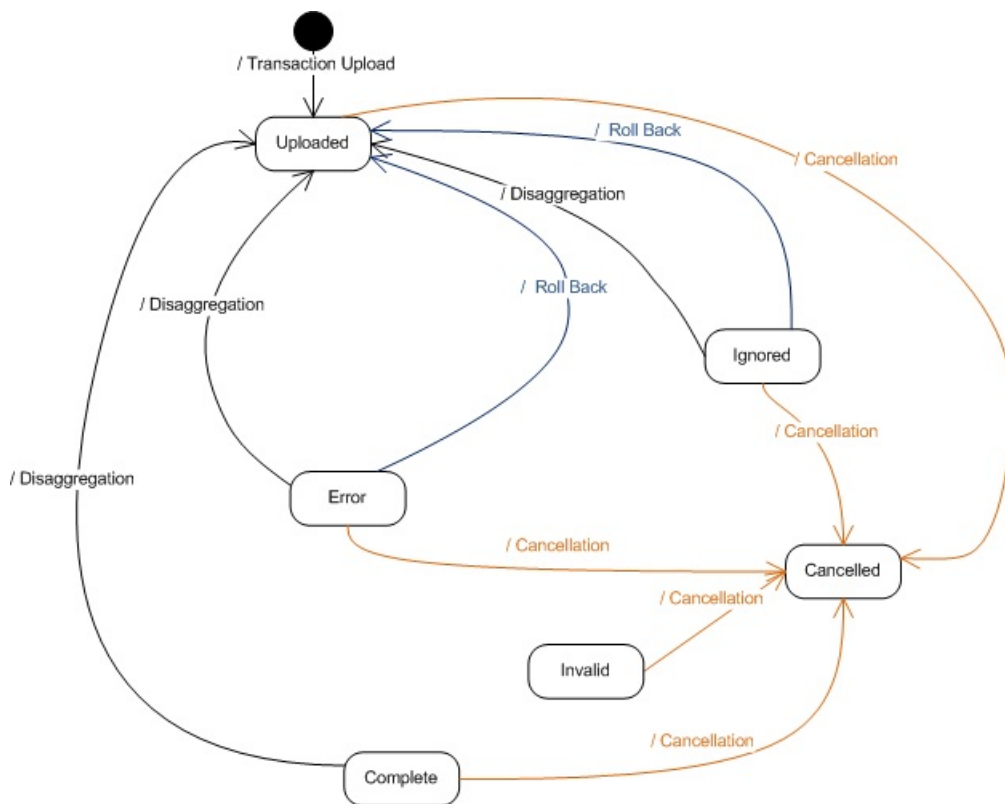

Transaction Leg Status Transition

This section explains how a transaction leg moves from one status to another during the following sub-processes:

- Transaction Aggregation

Note: This is the aggregation process for transactions that are recently uploaded or reaggregated after being fully disaggregated.

- Transaction Rollback
- Transaction Cancellation
- Transaction Disaggregation
- Transaction Reaggregation

Note: This is the aggregation process for transactions that are reaggregated after being partially disaggregated.

Transaction Aggregation

The following table indicates how a transaction leg moves from one status to another during the aggregation process:

Sr. No.	Batch	Event	Pre Event Transaction Status	Pre Event Transaction Leg Status	Post Event Transaction Status	Post Event Transaction Leg Status
1	C1-TXNIP	Transaction validation fails due to incomplete transaction data	UPLOADED	Not applicable as the transaction legs are not yet created	INVALID	Not applicable as the transaction legs are not yet created
2	C1-TXNIP	Transaction validation fails due to invalid or incorrect transaction data	UPLOADED	Not applicable as the transaction legs are not yet created	ERROR	Not applicable as the transaction legs are not yet created
3	C1-TXNIP	Transaction validation is successful but no product is derived	UPLOADED	Not applicable as the transaction legs are not yet created	ERROR	Not applicable as the transaction legs are not yet created
4	C1-TXNIP	Transaction validation is successful and product is derived	UPLOADED	Not applicable as the transaction legs are not yet created	INITIAL PRODUCT DETERMINED	INITIAL PRODUCT DETERMINED
5	C1-TXNIP	Transaction validation is successful and the transaction is ignored by the rule based on the transaction attributes	UPLOADED	Not applicable as the transaction legs are not yet created	IGNORED	Not applicable as the transaction legs are not yet created
6	C1-TXNVP and C1-TXNEX	Effective pricing is not found for any of the transaction legs	INITIAL PRODUCT DETERMINED	INITIAL PRODUCT DETERMINED	ERROR	ERROR
7	C1-TXNVP and C1-TXNEX	Ignore Transaction flag is set to Y in the effective pricing for one or more transaction legs but not for all transaction legs	INITIAL PRODUCT DETERMINED	INITIAL PRODUCT DETERMINED	INITIAL PRODUCT DETERMINED	IGNORED (when Ignore Transaction flag is set to Y in the effective pricing) INITIAL PRODUCT DETERMINED (when Ignore Transaction flag is set to N in the effective pricing)
8	C1-TXNVP and C1-TXNEX	Ignore Transaction flag is set to Y in the effective pricing for all transaction legs	INITIAL PRODUCT DETERMINED	INITIAL PRODUCT DETERMINED	IGNORED	IGNORED

Sr. No.	Batch	Event	Pre Event Transaction Status	Pre Event Transaction Leg Status	Post Event Transaction Status	Post Event Transaction Leg Status
9	C1-TXNVP and C1-TXNEX	Ignore Transaction flag is set to N in the effective pricing for all transaction legs	INITIAL PRODUCT DETERMINED	INITIAL PRODUCT DETERMINED	INITIAL PRODUCT DETERMINED	INITIAL PRODUCT DETERMINED
10	C1-TXNSQ and C1-TXNCM	SQIs are not defined for the product — division combination, Transaction aggregation rule is not defined for the SQI, or Exchange rate is not available during currency conversion	INITIAL PRODUCT DETERMINED	INITIAL PRODUCT DETERMINED	ERROR	ERROR
11	C1-TXNSQ and C1-TXNCM	Billable charges are created successfully for all transaction legs	INITIAL PRODUCT DETERMINED	INITIAL PRODUCT DETERMINED	COMPLETED	COMPLETED

Transaction Rollback

The following table indicates how a transaction leg moves from one status to another during the rollback process:

Sr. No.	Batch	Event	Pre Event Transaction Status	Pre Event Transaction Leg Status	Post Event Transaction Status	Post Event Transaction Leg Status
1	C1-TXNRB	Transactions with the Error (EROR) status are rolled back	ERROR	ERROR	UPLOADED	Not applicable as the transaction legs are not yet created
2	C1-TXNRB	Transactions with the Ignored (IGNR) status are rolled back	IGNORED	IGNORED	UPLOADED	Not applicable as the transaction legs are not yet created

Transaction Cancellation

The following table indicates how a transaction leg moves from one status to another during the cancellation process:

Sr. No.	Batch	Event	Pre Event Transaction Status	Pre Event Transaction Leg Status	Post Event Transaction Status	Post Event Transaction Leg Status
1	C1-TXCNC	Transactions in any status are cancelled	UPLOADED, INITIAL PRODUCT DETERMINED, ERROR, COMPLETED, INVALID, or IGNORED	INITIAL PRODUCT DETERMINED, ERROR, IGNORED, or COMPLETED	CANCELLED	CANCELLED

Transaction Disaggregation

The following table indicates how a transaction leg moves from one status to another during the disaggregation process:

Sr. No.	Batch	Event	Pre Event Transaction Status	Pre Event Transaction Leg Status	Post Event Transaction Status	Post Event Transaction Leg Status
1	C1-DISTG	Transactions in the COMPLETED, ERROR, or IGNORED status are disaggregated.	COMPLETED, ERROR, or IGNORED Note: The transactions in the ERROR or IGNORED status must have legs for disaggregation.	COMPLETED, ERROR, or IGNORED	No change in the status	No change in the status
2	C1-DISTG	Transactions in the INVALID or CANCELLED status cannot be disaggregated. In addition, the newly uploaded transactions and fully disaggregated transactions which are in the UPLOADED status cannot be disaggregated.	CANCELLED, INVALID, or UPLOADED	Not applicable as the transactions will not have any legs in these statuses	No change in the status	Not applicable as the transactions will not have any legs in these statuses
3	C1-IDENT	Transactions in the COMPLETED, ERROR, or IGNORED status are disaggregated.	COMPLETED, ERROR, or IGNORED Note: The transactions in the ERROR or IGNORED status must have legs for disaggregation.	COMPLETED, ERROR, or IGNORED	No change in the status	No change in the status

Sr. No.	Batch	Event	Pre Event Transaction Status	Pre Event Transaction Leg Status	Post Event Transaction Status	Post Event Transaction Leg Status
4	C1-IDENT	Transaction has already been disaggregated and is in the UPLOADED status. The transaction legs which were not affected are moved in the staging table and the transaction legs which were affected are deleted. Now, if the effective pricing is changed for the account to which the transaction leg in the staging table is mapped, then that transaction leg must be disaggregated. Thus, disaggregation is done even though the transaction is in the UPLOADED status.	UPLOADED	UPLOADED	No change in the status	No change in the status
5	C1-PDTXN	Transactions in the COMPLETED, ERROR, or IGNORED status are disaggregated.	COMPLETED, ERROR, or IGNORED Note: The transactions in the ERROR or IGNORED status must have legs for disaggregation.	COMPLETED, ERROR, or IGNORED	UPLOADED	Transaction legs which are affected during disaggregation are deleted and the other legs which are not affected are moved to the staging table.

Transaction Reaggregation

The following table indicates how a transaction leg moves from one status to another during the reaggregation process:

Sr. No.	Batch	Event	Transaction Status Before Disaggregation	Transaction Leg Status Before Disaggregation	Transaction Status After Reaggregation	Transaction Leg Status After Reaggregation
1	C1-TXNIP	Transaction in the COMPLETED status was disaggregated. It had four transaction legs – two in the COMPLETED status and other two in the IGNORED status. A transaction leg in the COMPLETED status was disaggregated due to change in the business rule (i.e. IGNORE_SW is set to Y).	COMPLETED	COMPLETED, IGNORED	COMPLETED	Derived Leg: IGNORED Existing Legs: COMPLETED and IGNORED
2	C1-TXNIP	Transaction in the COMPLETED status was disaggregated. It had one transaction leg in the COMPLETED status and all other transaction legs in the IGNORED status. The leg in the COMPLETED status was disaggregated due to change in the business rule (i.e. IGNORE_SW is set to Y).	COMPLETED	COMPLETED, IGNORED	IGNORED	Derived Leg: IGNORED Existing Legs: IGNORED

Sr. No.	Batch	Event	Transaction Status Before Disaggregation	Transaction Leg Status Before Disaggregation	Transaction Status After Reaggregation	Transaction Leg Status After Reaggregation
3	C1-TXNIP	Transaction in the COMPLETED status was disaggregated. All the transaction legs were in the COMPLETED status. One of the transaction legs in the COMPLETED status was disaggregated. During reaggregation, no product was derived for this transaction leg.	COMPLETED	COMPLETED	ERROR	Derived Leg: No new transaction leg was created Existing Legs: COMPLETED
4	C1-TXNIP	Transaction in the ERROR status was disaggregated. It had no transaction legs. During reaggregation, no product was derived for the transaction.	ERROR	No Transaction Legs Exist	ERROR	Derived Leg: No new transaction leg was created Existing Legs: None
5	C1-TXNIP	Transaction in the ERROR status was disaggregated. It had no transaction legs. During reaggregation, a product was derived for the transaction.	ERROR	No Transaction Legs Exist	INITIAL PRODUCT DETERMINED	Derived Leg: INITIAL PRODUCT DETERMINED Existing Legs: None

Sr. No.	Batch	Event	Transaction Status Before Disaggregation	Transaction Leg Status Before Disaggregation	Transaction Status After Reaggregation	Transaction Leg Status After Reaggregation
6	C1-TXNVP and C1-TXNEX	Transaction in the COMPLETED status was disaggregated. It had four transaction legs – two in the COMPLETED status and other two in the IGNORED status. A transaction leg in the COMPLETED status was disaggregated. During reaggregation, the effective pricing was not found for the transaction leg.	COMPLETED	COMPLETED, IGNORED	ERROR	Derived Leg: ERROR Existing Legs: COMPLETED and IGNORED
7	C1-TXNVP and C1-TXNEX	Transaction in the ERROR status was disaggregated. It had no transaction legs. During reaggregation, the effective pricing is found for the transaction legs.	ERROR	No Transaction Legs Exist	INITIAL PRODUCT DETERMINED	Derived Legs: INITIAL PRODUCT DETERMINED Existing Legs: None
8	C1-TXNVP and C1-TXNEX	Transaction in the COMPLETED status was disaggregated. It had four transaction legs – two in the COMPLETED status and other two in the IGNORED status. A transaction leg in the COMPLETED status was disaggregated due to change in the effective pricing (i.e. Ignore Transaction flag is set to Y).	COMPLETED	COMPLETED, IGNORED	COMPLETED	Derived Leg: IGNORED Existing Legs: COMPLETED and IGNORED

Sr. No.	Batch	Event	Transaction Status Before Disaggregation	Transaction Leg Status Before Disaggregation	Transaction Status After Reaggregation	Transaction Leg Status After Reaggregation
9	C1-TXNVP and C1-TXNEX	Transaction in the COMPLETED status was disaggregated. It had one transaction leg in the COMPLETED status and all other transaction legs in the IGNORED status. The leg in the COMPLETED status was disaggregated due to change in the effective pricing (i.e. Ignore Transaction flag is set to Y).	COMPLETED	COMPLETED, IGNORED	IGNORED	Derived Leg: IGNORED Existing Legs: IGNORED
10	C1-TXNSQ and C1-TXNCM	While reaggregating transaction legs, SQIs are not defined for the product — division combination, Transaction aggregation rule is not defined for the SQI, or Exchange rate is not available during currency conversion.	COMPLETED, ERROR, IGNORED Note: There must be no legs for the transaction in the IGNORED status.	COMPLETED, ERROR	ERROR	Derived Legs: ERROR Existing Legs: No change in the status
11	C1-TXNSQ and C1-TXNCM	Billable charges are created successfully for all transaction legs which were earlier disaggregated and now reaggregated.	COMPLETED, ERROR, IGNORED Note: There must be no legs for the transaction in the IGNORED status.	COMPLETED, ERROR	COMPLETED	Derived Leg: COMPLETED Existing Legs: No change in the status

Transaction Data File

You can upload a transaction data file in the following formats:

- Comma Separated Values
- JavaScript Object Notation
- Fixed Position
- Pipe Separated Values
- Tilde Separated Values
- Extensible Markup Language

Before uploading a transaction data file, you need to ensure that it contains the following:

- **File Header** - Every file must have one header record. It should contain the following details:

Header Data	Description	Mandatory (Yes or No)
Transaction Source	Used to specify the source from where the transactions are received.	Yes
Header Date (YYYYMMDD)	Used to specify the header date.	Yes
Transaction Header ID	Used to specify the external transaction header ID.	Yes
File Name	Used to specify the file name.	Yes
Number of Transactions	Used to specify the total number of transaction records in the file.	Yes
Total Transaction Volume	Used to specify the total transaction volume.	Yes
Total Transaction Amount	Used to specify the total transaction amount.	Yes

- **Transaction Record** - Every file must have one or more transaction records. It should contain the following details:

Record Data	Description	Mandatory (Yes or No)
Transaction Record Type	Used to specify the record type of the transaction.	Yes
Transaction Source	Used to specify the source from where the transaction is received.	Yes
Transaction Date (YYYYMMDD)	Used to specify the date when the transaction was performed.	Yes
External Reference Number	Used to specify the external reference number of the transaction.	Yes
Customer Reference Number	Used to indicate the customer who has performed the transaction.	No
Division	Used to specify the division to which the transaction belongs.	Yes
Transaction Volume	Used to specify the transaction volume.	Yes
Transaction Amount	Used to specify the transaction amount.	Yes

Record Data	Description	Mandatory (Yes or No)
Transaction Currency	Used to specify the currency in which the transaction was performed.	Yes
	Note: If you specify a currency other than the pricing currency, the system will do the currency conversion when the appropriate exchange rate is available in the system.	
Credit/Debit Indicator	Used to indicate whether the transaction is a debit or a credit transaction. The valid values are: <ul style="list-style-type: none"> • Plus (+) • Minus (-) 	Yes
Account Identifier Type	Used to indicate the account identifier type.	Yes
Account Identifier	Used to indicate the account for which the transaction was performed.	Yes
UDF_NUM_1, UDF_NUM_2, UDF_NUM_3, ..., UDF_NUM_20	Used to specify additional information about the transaction.	No
UDF_AMT_1, UDF_AMT_2, UDF_AMT_3, ..., UDF_AMT_10	Used to specify additional transaction amount.	Yes (Conditional)
		Note: The UDF_AMT_N is required when the corresponding UDF_CCY_N is specified.
UDF_CCY_1, UDF_CCY_2, UDF_CCY_3,, UDF_CCY_10	Used to specify additional transaction currency. Note: If you specify a currency other than the pricing currency, the system will do the currency conversion when the appropriate exchange rate is available in the system.	Yes (Conditional)
		Note: The UDF_CCY_N is required when the corresponding UDF_AMT_N is specified.
UDF_DTTM_1, UDF_DTTM_2,, UDF_DTTM_5	Used to specify additional information about the transaction.	No
UDF_CHAR_1, UDF_CHAR_2, UDF_CHAR_3, ..., UDF_CHAR_50	Used to specify additional information about the transaction. Note: If the data in these columns will be used for price item parameter mapping, you must not use the equal to (=) and tilde (~) symbols in these columns.	No

Error List

The following table lists the errors that may occur while executing various batches in the transaction feed management process. It also indicates how you can resolve these errors.

Batch Name	Message Number	Error Message	Message Category	Possible Issues
C1-TXNHV	102	{Checksum Validation Required} field invalid.	11001	The possible issues could be: <ul style="list-style-type: none"> The value other than 'Y', 'y', 'N' or 'n' is specified for the Checksum Validation Required parameter.
C1-TXNHV	102	{Duplicate Check Required} field invalid.	11001	The possible issues could be: <ul style="list-style-type: none"> The value other than 'Y', 'y', 'N' or 'n' is specified for the Duplicate Check Required parameter.
C1-TXNHV	1314	The Transaction Source is mandatory.	17000	The possible issues could be: <ul style="list-style-type: none"> The data is not available in the Transaction Source column.
C1-TXNHV	1332	Sum of transaction records in the header does not match the total number of records in the file.	17000	The possible issues could be: <ul style="list-style-type: none"> Inappropriate file is uploaded in the system.
C1-TXNHV	1333	Sum of transaction volume in the header does not match the total transaction volume in the file.	17000	The possible issues could be: <ul style="list-style-type: none"> Inappropriate file is uploaded in the system.
C1-TXNHV	1334	Sum of transaction amount in the header does not match the total transaction amount in the file.	17000	The possible issues could be: <ul style="list-style-type: none"> Inappropriate file is uploaded in the system.
C1-TXNHV	1338	The Transaction Header ID already exists in the system. Please enter unique header ID.	17000	The possible issues could be: <ul style="list-style-type: none"> The same file is uploaded multiple times in the system.
C1-TXNHV	1341	Exception occurred during the transaction header validation.	17000	The possible issues could be: <ul style="list-style-type: none"> The data is not available in the required format.
C1-TXNHV	1421	Transaction records does not exist in the file. Please check.	17000	The possible issues could be: <ul style="list-style-type: none"> Inappropriate file is uploaded in the system.

Batch Name	Message Number	Error Message	Message Category	Possible Issues
C1-TXNHV	1422	Sum of transaction records in the header cannot be zero. Please enter valid data in the header.	17000	The possible issues could be: <ul style="list-style-type: none"> The value available in the Number of Transactions column is less than or equal to zero.
C1-TXNHV	1423	Sum of transaction volume in the header cannot be zero. Please enter valid data in the header.	17000	The possible issues could be: <ul style="list-style-type: none"> The value available in the Total Transaction Volume column is less than or equal to zero.
C1-TXNHV	1663	Transaction Header External Id is missing.	17000	The possible issues could be: <ul style="list-style-type: none"> The data is not available in the Transaction Header ID column.
C1-TXNHV	1664	Header Transaction Amount should be greater than 0.	17000	The possible issues could be: <ul style="list-style-type: none"> The value available in the Total Transaction Amount column is less than or equal to zero.
C1-TXNIP	102	{Chunk Size} field invalid	11001	The possible issues could be: <ul style="list-style-type: none"> The value specified for the Chunk Size parameter is less than or equal to one.
C1-TXNIP	102	{ Maximum Batch Size } field invalid	11001	The possible issues could be: <ul style="list-style-type: none"> The value specified for the Maximum Batch Count parameter is greater than the value specified for the Chunk Size parameter.
C1-TXNIP	106	Value { Given Transaction Header Id } too long for field { transactionHeaderId }. Maximum length: 14. Found: { Length of given Transaction Header Id}	11001	The possible issues could be: <ul style="list-style-type: none"> The value specified for the Transaction Header ID parameter exceeds the maximum length of 14 characters.
C1-TXNIP	106	Value { Given Transaction Source Code } too long for field { transactionSource }. Maximum length: 30. Found: { Length of given Transaction Source Code}	11001	The possible issues could be: <ul style="list-style-type: none"> The value specified for the Transaction Source parameter exceeds the maximum length of 30 characters.
C1-TXNIP	106	Value { Given Transaction Division } too long for field { division }. Maximum length: 5 Found: { Length of given Transaction Division}	11001	The possible issues could be: <ul style="list-style-type: none"> The value specified for the Division parameter exceeds the maximum length of 5 characters.

Batch Name	Message Number	Error Message	Message Category	Possible Issues
C1-TXNIP	1301	The account with the specified identifier does not exist in the system. Enter a valid identifier.	17000	The possible issues could be: <ul style="list-style-type: none"> The account with the specified account identifier is not found in the system.
C1-TXNIP	1302	UDF_CURRENCY_1 is mandatory when UDF_AMT_1 is non-zero. Enter a valid currency code.	17000	The possible issues could be: <ul style="list-style-type: none"> The currency is not available in the UDF_CURRENCY_CD_1 column of the CI_TXN_DETAIL table.
C1-TXNIP	1303	UDF_AMT_1 is mandatory when UDF_CURRENCY_1 is specified. Enter the amount.	17000	The possible issues could be: <ul style="list-style-type: none"> The amount is not available in the UDF_AMT_1 column of the CI_TXN_DETAIL table.
C1-TXNIP	1304	UDF_CURRENCY_2 is mandatory when UDF_AMT_2 is non-zero. Enter a valid currency code.	17000	The possible issues could be: <ul style="list-style-type: none"> The currency is not available in the UDF_CURRENCY_CD_2 column of the CI_TXN_DETAIL table.
C1-TXNIP	1305	UDF_AMT_2 is mandatory when UDF_CURRENCY_2 is specified. Enter the amount.	17000	The possible issues could be: <ul style="list-style-type: none"> The amount is not available in the UDF_AMT_2 column of the CI_TXN_DETAIL table.
C1-TXNIP	1306	UDF_CURRENCY_3 is mandatory when UDF_AMT_3 is non-zero. Enter a valid currency code.	17000	The possible issues could be: <ul style="list-style-type: none"> The currency is not available in the UDF_CURRENCY_CD_3 column of the CI_TXN_DETAIL table.
C1-TXNIP	1307	UDF_AMT_3 is mandatory when UDF_CURRENCY_3 is specified. Enter the amount.	17000	The possible issues could be: <ul style="list-style-type: none"> The amount is not available in the UDF_AMT_3 column of the CI_TXN_DETAIL table.
C1-TXNIP	1308	UDF_CURRENCY_4 is mandatory when UDF_AMT_4 is non-zero. Enter a valid currency code.	17000	The possible issues could be: <ul style="list-style-type: none"> The currency is not available in the UDF_CURRENCY_CD_4 column of the CI_TXN_DETAIL table.
C1-TXNIP	1309	UDF_AMT_4 is mandatory when UDF_CURRENCY_4 is specified. Enter the amount.	17000	The possible issues could be: <ul style="list-style-type: none"> The amount is not available in the UDF_AMT_4 column of the CI_TXN_DETAIL table.
C1-TXNIP	1310	UDF_CURRENCY_5 is mandatory when UDF_AMT_5 is non-zero. Enter a valid currency code.	17000	The possible issues could be: <ul style="list-style-type: none"> The currency is not available in the UDF_CURRENCY_CD_5 column of the CI_TXN_DETAIL table.

Batch Name	Message Number	Error Message	Message Category	Possible Issues
C1-TXNIP	1311	UDF_AMT_5 is mandatory when UDF_CURRENCY_5 is specified. Enter the amount.	17000	The possible issues could be: <ul style="list-style-type: none"> The amount is not available in the UDF_AMT_5 column of the CI_TXN_DETAIL table.
C1-TXNIP	1312	UDF_CURRENCY_6 is mandatory when UDF_AMT_6 is non-zero. Enter a valid currency code.	17000	The possible issues could be: <ul style="list-style-type: none"> The currency is not available in the UDF_CURRENCY_CD_6 column of the CI_TXN_DETAIL table.
C1-TXNIP	1313	UDF_AMT_6 is mandatory when UDF_CURRENCY_6 is specified. Enter the amount.	17000	The possible issues could be: <ul style="list-style-type: none"> The amount is not available in the UDF_AMT_6 column of the CI_TXN_DETAIL table.
C1-TXNIP	1314	UDF_CURRENCY_7 is mandatory when UDF_AMT_7 is non-zero. Enter a valid currency code.	17000	The possible issues could be: <ul style="list-style-type: none"> The currency is not available in the UDF_CURRENCY_CD_7 column of the CI_TXN_DETAIL table.
C1-TXNIP	1315	UDF_AMT_7 is mandatory when UDF_CURRENCY_7 is specified. Enter the amount.	17000	The possible issues could be: <ul style="list-style-type: none"> The amount is not available in the UDF_AMT_7 column of the CI_TXN_DETAIL table.
C1-TXNIP	1316	UDF_CURRENCY_8 is mandatory when UDF_AMT_8 is non-zero. Enter a valid currency code.	17000	The possible issues could be: <ul style="list-style-type: none"> The currency is not available in the UDF_CURRENCY_CD_8 column of the CI_TXN_DETAIL table.
C1-TXNIP	1317	UDF_AMT_8 is mandatory when UDF_CURRENCY_8 is specified. Enter the amount.	17000	The possible issues could be: <ul style="list-style-type: none"> The amount is not available in the UDF_AMT_8 column of the CI_TXN_DETAIL table.
C1-TXNIP	1318	UDF_CURRENCY_9 is mandatory when UDF_AMT_9 is non-zero. Enter a valid currency code.	17000	The possible issues could be: <ul style="list-style-type: none"> The currency is not available in the UDF_CURRENCY_CD_9 column of the CI_TXN_DETAIL table.
C1-TXNIP	1319	UDF_AMT_9 is mandatory when UDF_CURRENCY_9 is specified. Enter the amount.	17000	The possible issues could be: <ul style="list-style-type: none"> The amount is not available in the UDF_AMT_9 column of the CI_TXN_DETAIL table.

Batch Name	Message Number	Error Message	Message Category	Possible Issues
C1-TXNIP	1320	UDF_CURRENCY_10 is mandatory when UDF_AMT_10 is non-zero. Enter a valid currency code.	17000	The possible issues could be: <ul style="list-style-type: none"> The currency is not available in the UDF_CURRENCY_CD_10 column of the CI_TXN_DETAIL table.
C1-TXNIP	1321	UDF_AMT_10 is mandatory when UDF_CURRENCY_10 is specified. Enter the amount.	17000	The possible issues could be: <ul style="list-style-type: none"> The amount is not available in the UDF_AMT_10 column of the CI_TXN_DETAIL table.
C1-TXNIP	1347	Could not derive a price item from the rules engine.	17000	The possible issues could be: <ul style="list-style-type: none"> There is some technical issue while executing the rule or while processing the rule output. No rules are effective on the processing date. The rule type is not defined for the transaction source and transaction record type combination in the system.
C1-TXNIP	1349	Division is invalid. Please enter a valid division for the transaction.	17000	The possible issues could be: <ul style="list-style-type: none"> Division (to which the transaction belongs) is not defined in the system.
C1-TXNIP	1351	Transaction Currency is invalid. Please enter a valid currency code.	17000	The possible issues could be: <ul style="list-style-type: none"> The currency in which the transaction was performed is not available in the Transaction Currency column. Currency is not defined in the system.
C1-TXNIP	1362	UDF Currency 1 is invalid. Please enter a valid currency code.	17000	The possible issues could be: <ul style="list-style-type: none"> Currency is not defined in the system.
C1-TXNIP	1363	UDF Currency 2 is invalid. Please enter a valid currency code.	17000	The possible issues could be: <ul style="list-style-type: none"> Currency is not defined in the system.
C1-TXNIP	1364	UDF Currency 3 is invalid. Please enter a valid currency code.	17000	The possible issues could be: <ul style="list-style-type: none"> Currency is not defined in the system.

Batch Name	Message Number	Error Message	Message Category	Possible Issues
C1-TXNIP	1365	UDF Currency 4 is invalid. Please enter a valid currency code.	17000	The possible issues could be: <ul style="list-style-type: none"> Currency is not defined in the system.
C1-TXNIP	1366	UDF Currency 5 is invalid. Please enter a valid currency code.	17000	The possible issues could be: <ul style="list-style-type: none"> Currency is not defined in the system.
C1-TXNIP	1377	Transaction currency is mandatory when transaction amount is non-zero. Enter a valid currency code.	17000	The possible issues could be: <ul style="list-style-type: none"> The currency is not available in the Transaction Currency column.
C1-TXNIP	1378	Transaction amount is mandatory when transaction currency is specified. Enter the amount.	17000	The possible issues could be: <ul style="list-style-type: none"> The amount is not available in the Transaction Amount column.
C1-TXNIP	1379	The user does not exist in the system. Please enter a valid user ID.	17000	The possible issues could be: <ul style="list-style-type: none"> The user is not defined in the system.
C1-TXNIP	1380	The value entered in the Credit/Debit Indicator column is incorrect. Enter either "+" or "-".	17000	The possible issues could be: <ul style="list-style-type: none"> The value other than '+' or '-' is available in the HOW_TO_USE_TXN_FLG column of the CI_TXN_DETAIL table.
C1-TXNIP	1381	The value entered in the Manual Switch field is incorrect. Enter either "Y" or "N".	17000	The possible issues could be: <ul style="list-style-type: none"> The value other than 'Y' or 'N' is available in the MANUAL_SW column of the CI_TXN_DETAIL table.
C1-TXNIP	1556	{Maximum Batch Size} field should be greater than zero	17000	The possible issues could be: <ul style="list-style-type: none"> The value specified for the Maximum Batch Count parameter is less than or equal to zero.
C1-TXNIP	1636	Invalid batch run [%1] for [%2] division(s). %3 Note: [%1] stands for batch code; [%2] stands for division; [%3] stands for expected batch code	17000	The possible issues could be: <ul style="list-style-type: none"> You are trying to execute the C1-TXNVP, C1-TXNEX, C1-TXNSQ, C1-TXNCM or C1-TXNCU batch instead of the C1-TXNIP batch (which is first mandatory batch in the transaction aggregation cycle).

Batch Name	Message Number	Error Message	Message Category	Possible Issues
C1-TXNIP	1637	<p>Batch [%1] is already executed for [%2] division(s). Please complete pending batch runs before starting new cycle for [%3] division(s).</p> <p>Note: [%1] stands for batch code; [%2] and [%3] stands for division</p>	17000	<p>The possible issues could be:</p> <ul style="list-style-type: none"> You are trying to execute this batch once again with the same division (for example, D1) after executing any other batch in the transaction aggregation cycle which is already initiated for D1.
C1-TXNIP	1638	Transaction Feed Management cycle for individual division(s) is not yet complete. Please complete pending batch runs before starting new cycle for processing [ALL] divisions.	17000	<p>The possible issues could be:</p> <ul style="list-style-type: none"> You are trying to execute this batch for all divisions before completing the transaction aggregation cycle which is initiated for a particular division.
C1-TXNIP	1639	<p>Transaction Feed Management cycle for [ALL] divisions is not yet complete. Please complete pending batch runs before starting new cycle for individual division [%1].</p> <p>Note: [%1] stands for division</p>	17000	<p>The possible issues could be:</p> <ul style="list-style-type: none"> You are trying to execute this batch for a particular division before completing the transaction aggregation cycle which is initiated for all divisions.
C1-TXNIP	1646	Value for mandatory parameter is missing.	17000	<p>The possible issues could be:</p> <ul style="list-style-type: none"> No value is defined for the mandatory price item parameter in the rule.
C1-TXNIP	1647	Mandatory parameter is missing.	17000	<p>The possible issues could be:</p> <ul style="list-style-type: none"> The mandatory price item parameter is not defined as the output parameter in the rule.
C1-TXNIP	1648	Account Number derived by the rule is invalid.	17000	<p>The possible issues could be:</p> <ul style="list-style-type: none"> No value is defined for either Account Identifier (ACCT_NOX_Val) or Account Identifier Column Name (ACCT_NOX_Col) output parameter in the rule.

Batch Name	Message Number	Error Message	Message Category	Possible Issues
C1-TXNIP	1649	Account Number type code derived by the rule is invalid.	17000	The possible issues could be: <ul style="list-style-type: none"> No value is defined for either Account Identifier Type (ACCT_NO_TYPEX_Val) or Account Identifier Type Column Name (ACCT_NO_TYPEX_Col) output parameter in the rule.
C1-TXNIP	1650	Division derived by the rule is invalid.	17000	The possible issues could be: <ul style="list-style-type: none"> No value is defined for either Account Division (DIVISIONX_VAL) or Account Division Column Name (DIVISIONX_COL) output parameter in the rule.
C1-TXNIP	1651	Not able to derive account ID.	17000	The possible issues could be: <ul style="list-style-type: none"> The account with the specified account identifier type, account identifier, and division is not found in the system.
C1-TXNIP	1652	Product derived by the rule is invalid.	17000	The possible issues could be: <ul style="list-style-type: none"> No value is defined for either Product Name (PRODUCTX_Y_Val) or Product Column Name (PRODUCTX_Y_Col) output parameter in the rule.
C1-TXNIP	1653	Length of the derived product is greater than 10.	17000	The possible issues could be: <ul style="list-style-type: none"> The value specified for the Product Name (PRODUCTX_Y_Val) or Product Column Name (PRODUCTX_Y_Col) output parameter in the rule exceeds the maximum length of 10 characters.
C1-TXNIP	1654	Length of the derived variance parameter is greater than 8.	17000	The possible issues could be: <ul style="list-style-type: none"> The value specified for the TOU (TOUX_Y_Val) or TOU Column Name (TOUX_Y_Col) output parameter in the rule exceeds the maximum length of 8 characters.

Batch Name	Message Number	Error Message	Message Category	Possible Issues
C1-TXNIP	1656	Length of the product parameter value derived by the rule is greater than 254.	17000	The possible issues could be: <ul style="list-style-type: none"> The value specified for the Parameter Value (PVLX_Y_Z_VAL) or Parameter Value Column Name (PVLX_Y_Z_COL) output parameter in the rule exceeds the maximum length of 254 characters.
C1-TXNIP	1657	Length of the product parameter code derived by the rule is greater than 30.	17000	The possible issues could be: <ul style="list-style-type: none"> The value specified for the Parameter Code (PCDX_Y_Z_VAL) output parameter in the rule exceeds the maximum length of 30 characters.
C1-TXNIP	2002	Transaction is in EROR due to one or more reasons.	17000	The possible issues could be: <ul style="list-style-type: none"> There might be one or more reasons why the status of the transaction is set to Error (EROR).
C1-TXNIP	2007	%1 cannot be blank. Note: [%1] stands for division	17000	The possible issues could be: <ul style="list-style-type: none"> The division to which the transaction belongs is not available in the Division column.
C1-TXNIP	2007	%1 cannot be blank. Note: [%1] stands for user ID	17000	The possible issues could be: <ul style="list-style-type: none"> No data exists in the USER_ID column of the CI_TXN_DETAIL table when the MANUAL_SW column is set to Y.
C1-TXNIP	2011	%1 is mandatory when %2 is non-zero. Enter a valid currency code. Note: [%1] stands for "Currency Code"; [%2] stands for "Transaction Amount"	17000	The possible issues could be: <ul style="list-style-type: none"> The currency in which the transaction was performed is not available in the CURRENCY_CD column of the CI_TXN_DETAIL table.

Batch Name	Message Number	Error Message	Message Category	Possible Issues
C1-TXNIP	2011	<p>%1 is mandatory when %2 is non-zero. Enter a valid currency code.</p> <p>Note:</p> <p>[%1] stands for “Amount 1 Currency Code”;</p> <p>[%2] stands for “Additional Amount 1”</p>	17000	<p>The possible issues could be:</p> <ul style="list-style-type: none"> The currency is not available in the UDF_CURRENCY_CD_1 column of the CI_TXN_DETAIL table.
C1-TXNIP	2011	<p>%1 is mandatory when %2 is non-zero. Enter a valid currency code.</p> <p>Note:</p> <p>[%1] stands for “Amount 2 Currency Code”;</p> <p>[%2] stands for “Additional Amount 2”</p>	17000	<p>The possible issues could be:</p> <ul style="list-style-type: none"> The currency is not available in the UDF_CURRENCY_CD_2 column of the CI_TXN_DETAIL table.
C1-TXNIP	2011	<p>%1 is mandatory when %2 is non-zero. Enter a valid currency code.</p> <p>Note:</p> <p>[%1] stands for “Amount 3 Currency Code”;</p> <p>[%2] stands for “Additional Amount 3”</p>	17000	<p>The possible issues could be:</p> <ul style="list-style-type: none"> The currency is not available in the UDF_CURRENCY_CD_3 column of the CI_TXN_DETAIL table.
C1-TXNIP	2011	<p>%1 is mandatory when %2 is non-zero. Enter a valid currency code.</p> <p>Note:</p> <p>[%1] stands for “Amount 4 Currency Code”;</p> <p>[%2] stands for “Additional Amount 4”</p>	17000	<p>The possible issues could be:</p> <ul style="list-style-type: none"> The currency is not available in the UDF_CURRENCY_CD_4 column of the CI_TXN_DETAIL table.

Batch Name	Message Number	Error Message	Message Category	Possible Issues
C1-TXNIP	2011	<p>%1 is mandatory when %2 is non-zero. Enter a valid currency code.</p> <p>Note:</p> <p>[%1] stands for “Amount 5 Currency Code”;</p> <p>[%2] stands for “Additional Amount 5”</p>	17000	<p>The possible issues could be:</p> <ul style="list-style-type: none"> The currency is not available in the UDF_CURRENCY_CD_5 column of the CI_TXN_DETAIL table.
C1-TXNIP	2011	<p>%1 is mandatory when %2 is non-zero. Enter a valid currency code.</p> <p>Note:</p> <p>[%1] stands for “Amount 6 Currency Code”;</p> <p>[%2] stands for “Additional Amount 6”</p>	17000	<p>The possible issues could be:</p> <ul style="list-style-type: none"> The currency is not available in the UDF_CURRENCY_CD_6 column of the CI_TXN_DETAIL table.
C1-TXNIP	2011	<p>%1 is mandatory when %2 is non-zero. Enter a valid currency code.</p> <p>Note:</p> <p>[%1] stands for “Amount 7 Currency Code”;</p> <p>[%2] stands for “Additional Amount 7”</p>	17000	<p>The possible issues could be:</p> <ul style="list-style-type: none"> The currency is not available in the UDF_CURRENCY_CD_7 column of the CI_TXN_DETAIL table.
C1-TXNIP	2011	<p>%1 is mandatory when %2 is non-zero. Enter a valid currency code.</p> <p>Note:</p> <p>[%1] stands for “Amount 8 Currency Code”;</p> <p>[%2] stands for “Additional Amount 8”</p>	17000	<p>The possible issues could be:</p> <ul style="list-style-type: none"> The currency is not available in the UDF_CURRENCY_CD_8 column of the CI_TXN_DETAIL table.

Batch Name	Message Number	Error Message	Message Category	Possible Issues
C1-TXNIP	2011	<p>%1 is mandatory when %2 is non-zero. Enter a valid currency code.</p> <p>Note:</p> <p>[%1] stands for “Amount 9 Currency Code”;</p> <p>[%2] stands for “Additional Amount 9”</p>	17000	<p>The possible issues could be:</p> <ul style="list-style-type: none"> The currency is not available in the UDF_CURRENCY_CD_9 column of the CI_TXN_DETAIL table.
C1-TXNIP	2011	<p>%1 is mandatory when %2 is non-zero. Enter a valid currency code.</p> <p>Note:</p> <p>[%1] stands for “Amount 10 Currency Code”;</p> <p>[%2] stands for “Additional Amount 10”</p>	17000	<p>The possible issues could be:</p> <ul style="list-style-type: none"> The currency is not available in the UDF_CURRENCY_CD_10 column of the CI_TXN_DETAIL table.
C1-TXNIP	2012	<p>%1 %2 is invalid. Please enter a valid currency code.</p> <p>Note:</p> <p>[%1] stands for “Currency Code”;</p> <p>[%2] stands for transaction currency</p>	17000	<p>The possible issues could be:</p> <ul style="list-style-type: none"> Currency is not defined in the system.
C1-TXNIP	2012	<p>%1 %2 is invalid. Please enter a valid currency code.</p> <p>Note:</p> <p>[%1] stands for “Amount 1 Currency Code”;</p> <p>[%2] stands for UDF_CURRENCY_CD_1</p>	17000	<p>The possible issues could be:</p> <ul style="list-style-type: none"> Currency is not defined in the system.

Batch Name	Message Number	Error Message	Message Category	Possible Issues
C1-TXNIP	2012	% 1 %2 is invalid. Please enter a valid currency code. Note: [%1] stands for “Amount 2 Currency Code”; [%2] stands for UDF_CURRENCY_CD_2	17000	The possible issues could be: <ul style="list-style-type: none"> • Currency is not defined in the system.
C1-TXNIP	2012	% 1 %2 is invalid. Please enter a valid currency code. Note: [%1] stands for “Amount 3 Currency Code”; [%2] stands for UDF_CURRENCY_CD_3	17000	The possible issues could be: <ul style="list-style-type: none"> • Currency is not defined in the system.
C1-TXNIP	2012	% 1 %2 is invalid. Please enter a valid currency code. Note: [%1] stands for “Amount 4 Currency Code”; [%2] stands for UDF_CURRENCY_CD_4	17000	The possible issues could be: <ul style="list-style-type: none"> • Currency is not defined in the system.
C1-TXNIP	2012	% 1 %2 is invalid. Please enter a valid currency code. Note: [%1] stands for “Amount 5 Currency Code”; [%2] stands for UDF_CURRENCY_CD_5	17000	The possible issues could be: <ul style="list-style-type: none"> • Currency is not defined in the system.
C1-TXNIP	2012	% 1 %2 is invalid. Please enter a valid currency code. Note: [%1] stands for “Amount 6 Currency Code”; [%2] stands for UDF_CURRENCY_CD_6	17000	The possible issues could be: <ul style="list-style-type: none"> • Currency is not defined in the system.

Batch Name	Message Number	Error Message	Message Category	Possible Issues
C1-TXNIP	2012	% 1 %2 is invalid. Please enter a valid currency code. Note: [%1] stands for “Amount 7 Currency Code”; [%2] stands for UDF_CURRENCY_CD_7	17000	The possible issues could be: <ul style="list-style-type: none"> • Currency is not defined in the system.
C1-TXNIP	2012	% 1 %2 is invalid. Please enter a valid currency code. Note: [%1] stands for “Amount 8 Currency Code”; [%2] stands for UDF_CURRENCY_CD_8	17000	The possible issues could be: <ul style="list-style-type: none"> • Currency is not defined in the system.
C1-TXNIP	2012	% 1 %2 is invalid. Please enter a valid currency code. Note: [%1] stands for “Amount 9 Currency Code”; [%2] stands for UDF_CURRENCY_CD_9	17000	The possible issues could be: <ul style="list-style-type: none"> • Currency is not defined in the system.
C1-TXNIP	2012	% 1 %2 is invalid. Please enter a valid currency code. Note: [%1] stands for “Amount 10 Currency Code”; [%2] stands for UDF_CURRENCY_CD_10	17000	The possible issues could be: <ul style="list-style-type: none"> • Currency is not defined in the system.
C1-TXNIP	2013	The user %1 does not exist in the system. Please enter a valid user ID. Note: [%1] stands for user ID	17000	The possible issues could be: <ul style="list-style-type: none"> • The user is not defined in the system.

Batch Name	Message Number	Error Message	Message Category	Possible Issues
C1-TXNIP	2014	<p>%1 derived using %2 by the rule is invalid.</p> <p>Note: [%1] stands for “Account Number” [%2] stands for the ACCT_NOX_Val or ACCT_NOX_Col output parameter</p>	17000	<p>The possible issues could be:</p> <ul style="list-style-type: none"> No value is defined for either Account Identifier (ACCT_NOX_Val) or Account Identifier Column Name (ACCT_NOX_Col) output parameter in the rule.
C1-TXNIP	2014	<p>%1 derived using %2 by the rule is invalid.</p> <p>Note: [%1] stands for “Account Identifier Type” [%2] stands for the ACCT_NO_TYPEX_Val or ACCT_NO_TYPEX_Col output parameter</p>	17000	<p>The possible issues could be:</p> <ul style="list-style-type: none"> No value is defined for either Account Identifier Type (ACCT_NO_TYPEX_Val) or Account Identifier Type Column Name (ACCT_NO_TYPEX_Col) output parameter in the rule.
C1-TXNIP	2014	<p>%1 derived using %2 by the rule is invalid.</p> <p>Note: [%1] stands for “Division” [%2] stands for the DIVISIONX_VAL or DIVISIONX_COL output parameter</p>	17000	<p>The possible issues could be:</p> <ul style="list-style-type: none"> No value is defined for either Account Division (DIVISIONX_VAL) or Account Division Column Name (DIVISIONX_COL) output parameter in the rule.
C1-TXNIP	2014	<p>%1 derived using %2 by the rule is invalid.</p> <p>Note: [%1] stands for “Initial Product Code” [%2] stands for the PRODUCTX_Y_Val or PRODUCTX_Y_Col output parameter</p>	17000	<p>The possible issues could be:</p> <ul style="list-style-type: none"> No value is defined for either Product Name (PRODUCTX_Y_Val) or Product Column Name (PRODUCTX_Y_Col) output parameter in the rule.

Batch Name	Message Number	Error Message	Message Category	Possible Issues
C1-TXNIP	2015	<p>Not able to derive account id for given Account Number %1, Account Number Type Code %2 and Division %3.</p> <p>Note:</p> <p>[%1] stands for account identifier;</p> <p>[%2] stands for account identifier type;</p> <p>[%3] stands for division</p>	17000	<p>The possible issues could be:</p> <ul style="list-style-type: none"> The account with the specified account identifier type, account identifier and division is not found in the system.
C1-TXNIP	2016	<p>Length of the derived %1 using %2 by the rule is greater than %3.</p> <p>Note:</p> <p>[%1] stands for “Initial Product Code”;</p> <p>[%2] stands for PRODUCTX_Y_Val or PRODUCTX_Y_Col output parameter;</p> <p>[%3] stands for length of product code (i.e. 30)</p>	17000	<p>The possible issues could be:</p> <ul style="list-style-type: none"> The value specified for the Product Name (PRODUCTX_Y_Val) or Product Column Name (PRODUCTX_Y_Col) output parameter in the rule exceeds the maximum length of 30 characters.
C1-TXNIP	2016	<p>Length of the derived %1 using %2 by the rule is greater than %3.</p> <p>Note:</p> <p>[%1] stands for “Variance Parameter”;</p> <p>[%2] stands for TOUX_Y_Val or TOUX_Y_Col output parameter;</p> <p>[%3] stands for length of variance parameter (i.e. 8)</p>	17000	<p>The possible issues could be:</p> <ul style="list-style-type: none"> The value specified for the TOU (TOUX_Y_Val) or TOU Column Name (TOUX_Y_Col) output parameter in the rule exceeds the maximum length of 8 characters.

Batch Name	Message Number	Error Message	Message Category	Possible Issues
C1-TXNIP	2016	<p>Length of the derived %1 using %2 by the rule is greater than %3.</p> <p>Note: [%1] stands for “Parameter”; [%2] stands for PCDX_Y_Z_VAL output parameter; [%3] stands for length of parameter (i.e. 30)</p>	17000	<p>The possible issues could be:</p> <ul style="list-style-type: none"> The value specified for the Parameter Code (PCDX_Y_Z_VAL) output parameter in the rule exceeds the maximum length of 30 characters.
C1-TXNIP	2016	<p>Length of the derived %1 using %2 by the rule is greater than %3.</p> <p>Note: [%1] stands for “Parameter Value”; [%2] stands for PVLX_Y_Z_VAL or PVLX_Y_Z_COL output parameter; [%3] stands for length of parameter value (i.e. 254)</p>	17000	<p>The possible issues could be:</p> <ul style="list-style-type: none"> The value specified for the Parameter Value Column Name (PVLX_Y_Z_COL) output parameter in the rule exceeds the maximum length of 254 characters.
C1-TXNIP	2017	<p>Mandatory parameter %1 is missing for %2 %3 and processing date %4.</p> <p>Note: [%1] stands for the product parameter code; [%2] stands for “Initial Product Code” [%3] stands for the product code [%4] stands for the processing date</p>	17000	<p>The possible issues could be:</p> <ul style="list-style-type: none"> The mandatory product parameter is not defined as the output parameter in the rule.

Batch Name	Message Number	Error Message	Message Category	Possible Issues
C1-TXNIP	2018	Value for mandatory parameter %1 is missing for product %2 and processing date %3. Note: [%1] stands for product parameter code; [%2] stands for product code; [%3] stands for processing date	17000	The possible issues could be: <ul style="list-style-type: none"> No value is defined for the mandatory product parameter in the rule.
C1-TXNIP	2019	Value of the derived %1 %2 contains '~' or '='. Note: [%1] stands for parameter code [%2] stands for parameter value	17000	The possible issues could be: <ul style="list-style-type: none"> The parameter code or value contains the equal to (=) and tide (~) symbols.
C1-TXNIP	2037	Error during executing rules for transaction record type %1, transaction source %2 and processing date %3. Note: [%1] stands for transaction record type; [%2] stands for transaction source; [%3] stands for processing date	17000	The possible issues could be: <ul style="list-style-type: none"> There is some technical issue while executing the rule or while processing the rule output. No rules are effective on the processing date. The rule type is not defined for the transaction source and transaction record type combination in the system.
C1-TXNIP	2043	Unable to derive Rule Type with Transaction Source %1 and Transaction Record Type %2. Note: [%1] stands for transaction source; [%2] stands for transaction record type	17000	The possible issues could be: <ul style="list-style-type: none"> The rule type is not defined for the transaction source and transaction record type combination in the system.

Batch Name	Message Number	Error Message	Message Category	Possible Issues
C1-TXNIP	2087	Division %1 is invalid. Please enter a valid division for the transaction.	17000	The possible issues could be: <ul style="list-style-type: none"> Division (to which the transaction belongs) is not defined in the system.
		Note: [%1] stands for division		
C1-TXNVP	102	{Chunk Size} field invalid	11001	The possible issues could be: <ul style="list-style-type: none"> The value specified for the Chunk Size parameter is less than or equal to one.
C1-TXNVP	106	Value { Given Transaction Header Id } too long for field { transactionHeaderId }. Maximum length: 14. Found: { Length of given Transaction Header Id}	11001	The possible issues could be: <ul style="list-style-type: none"> The value specified for the Transaction Header ID parameter exceeds the maximum length of 14 characters.
C1-TXNVP	106	Value { Given Transaction Source Code } too long for field { transactionSource }. Maximum length: 30. Found: { Length of given Transaction Source Code}	11001	The possible issues could be: <ul style="list-style-type: none"> The value specified for the Transaction Source parameter exceeds the maximum length of 30 characters.
C1-TXNVP	106	Value { Given Transaction Division } too long for field { division }. Maximum length: 5 Found: { Length of given Transaction Division}	11001	The possible issues could be: <ul style="list-style-type: none"> The value specified for the Division parameter exceeds the maximum length of 5 characters.
C1-TXNVP	1636	Invalid batch run [%1] for [%2] division(s). %3	17000	The possible issues could be: <ul style="list-style-type: none"> You are trying to execute the C1-TXNVP batch before executing the C1-TXNIP batch (which is first mandatory batch in the transaction aggregation cycle). You are trying to execute the C1-TXNVP batch in between the C1-TXNCM and C1-TXNCU batches during the transaction aggregation cycle.
		Note: [%1] stands for batch code; [%2] stands for division; [%3] stands for expected batch code		
C1-TXNVP	1638	Transaction Feed Management cycle for individual division(s) is not yet complete. Please complete pending batch runs before starting new cycle for processing [ALL] divisions.	17000	The possible issues could be: <ul style="list-style-type: none"> You are trying to execute this batch for all divisions before completing the transaction aggregation cycle which is initiated for a particular division.

Batch Name	Message Number	Error Message	Message Category	Possible Issues
C1-TXNVP	1639	Transaction Feed Management cycle for [ALL] divisions is not yet complete. Please complete pending batch runs before starting new cycle for individual division [%1]. Note: [%1] stands for division	17000	The possible issues could be: <ul style="list-style-type: none"> You are trying to execute this batch for a particular division before completing the transaction aggregation cycle which is initiated for all divisions.
C1-TXNVP	1644	Transaction Feed Management cycle for division(s) [%1] is already in progress with filter [Source= %2, Header= %3] criteria. Filter criteria must be same for complete cycle. Note: [%1] stands for division; [%2] stands for transaction source; [%3] stands for transaction header ID	17000	The possible issues could be: <ul style="list-style-type: none"> You are trying to execute this batch once again with the same division and different parameters.
C1-TXNEX	102	{ Chunk Size } field invalid	11001	The possible issues could be: <ul style="list-style-type: none"> The value specified for the Chunk Size parameter is less than or equal to one.
C1-TXNEX	102	{ Maximum Batch Size } field invalid	11001	The possible issues could be: <ul style="list-style-type: none"> The value specified for the Maximum Batch Count parameter is greater than the value specified for the Chunk Size parameter.
C1-TXNEX	106	Value { Given Transaction Header Id } too long for field { transactionHeaderId }. Maximum length: 14. Found: { Length of given Transaction Header Id }	11001	The possible issues could be: <ul style="list-style-type: none"> The value specified for the Transaction Header ID parameter exceeds the maximum length of 14 characters.
C1-TXNEX	106	Value { Given Transaction Source Code } too long for field { transactionSource }. Maximum length: 30. Found: { Length of given Transaction Source Code }	11001	The possible issues could be: <ul style="list-style-type: none"> The value specified for the Transaction Source parameter exceeds the maximum length of 30 characters.

Batch Name	Message Number	Error Message	Message Category	Possible Issues
C1-TXNEX	106	Value { Given Transaction Division } too long for field { division }. Maximum length: 5 Found: { Length of given Transaction Division }	11001	The possible issues could be: <ul style="list-style-type: none"> The value specified for the Division parameter exceeds the maximum length of 5 characters.
C1-TXNEX	790	The selected Member account does not have active Contracts.	17000	The possible issues could be: <ul style="list-style-type: none"> There are no contracts for the account in Active, Pending Stop, or Stop status on the transaction date.
C1-TXNEX	1336	Effective pricing is not available for the product. Please check.	17000	The possible issues could be: <ul style="list-style-type: none"> The effective pricing is not available for the product.
C1-TXNEX	1392	Invalid configuration of Price Search Algorithm Parameters or Contracts or Schedule Periods.	17000	The possible issues could be: <ul style="list-style-type: none"> The parameter values are either not defined or invalid in the Price Assignment Search algorithm (which is associated with the division). The period in which the transaction date falls is not defined in the aggregation schedule. There are multiple effective contracts of the same contract type (available on the transaction date) in Active, Pending Stop, or Stop status.
C1-TXNEX	1556	{Maximum Batch Size} field should be greater than zero	17000	The possible issues could be: <ul style="list-style-type: none"> The value specified for the Maximum Batch Count parameter is less than or equal to zero.
C1-TXNEX	1588	No Schedule Period found for the transaction date.	17000	The possible issues could be: <ul style="list-style-type: none"> The period in which the transaction date falls is not defined in the aggregation schedule.
C1-TXNEX	1611	Division specific Price Search Algorithm is not configured.	17000	The possible issues could be: <ul style="list-style-type: none"> The Price Assignment Search algorithm is not defined for the division.

Batch Name	Message Number	Error Message	Message Category	Possible Issues
C1-TXNEX	1612	Price Search Algorithm parameters are not set or are invalid.	17000	The possible issues could be: <ul style="list-style-type: none"> The parameter values are either not defined or invalid in the Price Assignment Search algorithm (which is associated with the division).
C1-TXNEX	1613	Multiple contracts in Active, Pending Stop, Stop status exists for same contract type.	17000	The possible issues could be: <ul style="list-style-type: none"> There are multiple effective contracts of the same contract type in Active, Pending Stop, or Stop status on the transaction date.
C1-TXNEX	1636	Invalid batch run [% 1] for [%2] division(s). %3 Note: [% 1] stands for batch code; [%2] stands for division; [%3] stands for expected batch code	17000	The possible issues could be: <ul style="list-style-type: none"> You are trying to execute the C1-TXNEX batch before executing the C1-TXNIP batch (which is first mandatory batch in the transaction aggregation cycle). You are trying to execute the C1-TXNEX batch in between the C1-TXNCM and C1-TXNCU batches during the transaction aggregation cycle.
C1-TXNEX	1638	Transaction Feed Management cycle for individual division(s) is not yet complete. Please complete pending batch runs before starting new cycle for processing [ALL] divisions.	17000	The possible issues could be: <ul style="list-style-type: none"> You are trying to execute this batch for all divisions before completing the transaction aggregation cycle which is initiated for a particular division.
C1-TXNEX	1639	Transaction Feed Management cycle for [ALL] divisions is not yet complete. Please complete pending batch runs before starting new cycle for individual division [% 1]. Note: [% 1] stands for division	17000	The possible issues could be: <ul style="list-style-type: none"> You are trying to execute this batch for a particular division before completing the transaction aggregation cycle which is initiated for all divisions.

Batch Name	Message Number	Error Message	Message Category	Possible Issues
C1-TXNEX	1644	<p>Transaction Feed Management cycle for division(s) [%1] is already in progress with filter [Source= %2, Header= %3] criteria. Filter criteria must be same for complete cycle.</p> <p>Note: [%1] stands for division; [%2] stands for transaction source; [%3] stands for transaction header ID</p>	17000	<p>The possible issues could be:</p> <ul style="list-style-type: none"> You are trying to execute this batch once again with the same division and different parameters.
C1-TXNIP	2003	<p>One or more Sub Transactions are in EROR state.</p>	17000	<p>The possible issues could be:</p> <ul style="list-style-type: none"> One or more transaction legs are in the Error (EROR) status.
C1-TXNEX	2006	<p>No active contract exists for account %1, product %2 and transaction date %3.</p> <p>Note: [%1] stands for derived account; [%2] stands for derived product; and [%3] stands for transaction date</p>	17000	<p>The possible issues could be:</p> <ul style="list-style-type: none"> There is no contract with the specified contract type available on the transaction date. The contract is inactive.
C1-TXNEX	2020	<p>Invalid configuration of Price Search Algorithm Parameters or Contracts or Schedule Periods for division %1, account %2, product %3, transaction date %4 and processing date %5.</p> <p>Note: [%1] stands for derived division; [%2] stands for derived account; [%3] stands for derived product; [%4] stands for transaction date; [%5] stands for processing date</p>	17000	<p>The possible issues could be:</p> <ul style="list-style-type: none"> The parameter values are either not defined or invalid in the Price Assignment Search algorithm (which is associated with the division). The period in which the transaction date falls is not defined in the aggregation schedule. There are multiple effective contracts of the same contract type (available on the transaction date) in Active, Pending Stop, or Stop status.

Batch Name	Message Number	Error Message	Message Category	Possible Issues
C1-TXNEX	2021	<p>Division specific Price Search Algorithm is not configured for division %1 and processing date %2.</p> <p>Note: [%1] stands for derived division; [%2] stands for processing date</p>	17000	<p>The possible issues could be:</p> <ul style="list-style-type: none"> The Price Assignment Search algorithm is not defined for the derived division on the processing date.
C1-TXNEX	2022	<p>Price Search Algorithm parameters are not set or are invalid for division %1 and processing date %2.</p> <p>Note: [%1] stands for derived division; [%2] stands for processing date</p>	17000	<p>The possible issues could be:</p> <ul style="list-style-type: none"> The parameter values are either not defined or invalid in the Price Assignment Search algorithm which is associated with the derived division on the processing date.
C1-TXNEX	2023	<p>Effective pricing is not available for account %1, product %2, parameters %3 and processing date %4.</p> <p>Note: [%1] stands for derived account; [%2] stands for derived product; [%3] stands for derived product parameter; [%4] stands for processing date</p>	17000	<p>The possible issues could be:</p> <ul style="list-style-type: none"> The effective pricing is not available for the account, product and product parameters combination on the processing date.
C1-TXNEX	2024	<p>No Schedule Period found for product %1, price assignment id %2 and transaction date %3.</p> <p>Note: [%1] stands for derived product; [%2] stands for price assignment ID; [%3] stands for transaction date</p>	17000	<p>The possible issues could be:</p> <ul style="list-style-type: none"> The period in which the transaction date falls is not defined in the aggregation schedule (which is used in the product pricing).

Batch Name	Message Number	Error Message	Message Category	Possible Issues
C1-TXNEX	2025	<p>Multiple contracts in Active, Pending Stop, Stop status exists for same contract type against account %1, product %2 and transaction date %3.</p> <p>Note: [%1] stands for derived account; [%2] stands for derived product; [%3] stands for transaction date</p>	17000	<p>The possible issues could be:</p> <ul style="list-style-type: none"> There are multiple effective contracts of the same contract type in Active, Pending Stop, or Stop status on the transaction date.
C1-TXNEX	2026	<p>No active contract exists for account %1, product %2 and transaction date %3.</p> <p>Note: [%1] stands for derived account; [%2] stands for derived product; [%3] stands for transaction date</p>	17000	<p>The possible issues could be:</p> <ul style="list-style-type: none"> There are no contracts for the account in Active, Pending Stop, or Stop status on the transaction date.
C1-TXNSQ	102	{ Maximum Batch Size } field invalid	11001	<p>The possible issues could be:</p> <ul style="list-style-type: none"> The value specified for the Maximum Batch Count parameter is greater than the value specified for the Chunk Size parameter.
C1-TXNSQ	102	{ Chunk Size } field invalid	11001	<p>The possible issues could be:</p> <ul style="list-style-type: none"> The value specified for the Chunk Size parameter is less than or equal to one.
C1-TXNSQ	106	Value { Given Transaction Header Id } too long for field { transactionHeaderId }. Maximum length: 14. Found: { Length of given Transaction Header Id }	11001	<p>The possible issues could be:</p> <ul style="list-style-type: none"> The value specified for the Transaction Header ID parameter exceeds the maximum length of 14 characters.
C1-TXNSQ	106	Value { Given Transaction Source Code } too long for field { transactionSource }. Maximum length: 30. Found: { Length of given Transaction Source Code }	11001	<p>The possible issues could be:</p> <ul style="list-style-type: none"> The value specified for the Transaction Source parameter exceeds the maximum length of 30 characters.

Batch Name	Message Number	Error Message	Message Category	Possible Issues
C1-TXNSQ	106	Value { Given Transaction Division } too long for field { division }. Maximum length: 5 Found: { Length of given Transaction Division }	11001	The possible issues could be: <ul style="list-style-type: none"> The value specified for the Division parameter exceeds the maximum length of 5 characters.
C1-TXNSQ	1388	Data configuration error for { ENV_ID }.	17000	The possible issues could be: <ul style="list-style-type: none"> No data exists in the ENV_ID column of the CI_INSTALLATION table. The data available in the ENV_ID column of the CI_INSTALLATION table is not properly cached.
C1-TXNSQ	1388	Data configuration error for { SQI Fragment }.	17000	The possible issues could be: <ul style="list-style-type: none"> No data exists in the SQL_FRAG, TXN_PRM, SQL_CD, and SQL_FUNC columns of the CI_TXN_SQI_FRAG table. The data available in the SQL_FRAG, TXN_PRM, SQL_CD, and SQL_FUNC columns of the CI_TXN_SQI_FRAG table is not properly cached.
C1-TXNSQ	1388	Data configuration error for { Price Item SQI }.	17000	The possible issues could be: <ul style="list-style-type: none"> No data exists in the PRICEITEM_CD, CIS_DIVISION, and SQL_CD columns of the CI_PRICEITEM_SQI table. The data available in the PRICEITEM_CD, CIS_DIVISION, and SQL_CD columns of the CI_PRICEITEM_SQI table is not properly cached.
C1-TXNSQ	1556	{Maximum Batch Size} field should be greater than zero	17000	The possible issues could be: <ul style="list-style-type: none"> The value specified for the Maximum Batch Count parameter is less than or equal to zero.

Batch Name	Message Number	Error Message	Message Category	Possible Issues
C1-TXNSQ	1636	Invalid batch run [% 1] for [%2] division(s). %3 Note: [%1] stands for batch code; [%2] stands for division; [%3] stands for expected batch code	17000	The possible issues could be: <ul style="list-style-type: none"> You are trying to execute the C1-TXNSQ batch before executing the C1-TXNIP batch (which is first mandatory batch in the transaction aggregation cycle). You are trying to execute the C1-TXNSQ batch in between the C1-TXNCM and C1-TXNCU batches during the transaction aggregation cycle.
C1-TXNSQ	1638	Transaction Feed Management cycle for individual division(s) is not yet complete. Please complete pending batch runs before starting new cycle for processing [ALL] divisions.	17000	The possible issues could be: <ul style="list-style-type: none"> You are trying to execute this batch for all divisions before completing the transaction aggregation cycle which is initiated for a particular division.
C1-TXNSQ	1639	Transaction Feed Management cycle for [ALL] divisions is not yet complete. Please complete pending batch runs before starting new cycle for individual division [%1]. Note: [% 1] stands for division	17000	The possible issues could be: <ul style="list-style-type: none"> You are trying to execute this batch for a particular division before completing the transaction aggregation cycle which is initiated for all divisions.
C1-TXNSQ	1644	Transaction Feed Management cycle for division(s) [%1] is already in progress with filter [Source= %2, Header= %3] criteria. Filter criteria must be same for complete cycle. Note: [%1] stands for division; [%2] stands for transaction source; [%3] stands for transaction header ID	17000	The possible issues could be: <ul style="list-style-type: none"> You are trying to execute this batch once again with the same division and different parameters.
C1-TXNSQ	2003	One or more Sub Transactions are in EROR state.	17000	The possible issues could be: <ul style="list-style-type: none"> One or more transaction legs are in the Error (EROR) status.

Batch Name	Message Number	Error Message	Message Category	Possible Issues
C1-TXNSQ	2026	<p>SQIs not configured for product %1 and division %2.</p> <p>Note:</p> <p>[%1] stands for final product code;</p> <p>[%2] stands for derived division</p>	17000	<p>The possible issues could be:</p> <ul style="list-style-type: none"> The SQIs are not defined for the product — division combination.
C1-TXNSQ	2027	Currency Conversion from Currency [%1] to Currency [%2] not successful.	17000	<p>The possible issues could be:</p> <ul style="list-style-type: none"> The exchange rate is not available during currency conversion.
C1-TXNCM	102	{Chunk Size} field invalid	11001	<p>The possible issues could be:</p> <ul style="list-style-type: none"> The value specified for the Chunk Size parameter is less than or equal to one.
C1-TXNCM	102	{ Maximum Batch Size } field invalid	11001	<p>The possible issues could be:</p> <ul style="list-style-type: none"> The value specified for the Maximum Batch Count parameter is greater than the value specified for the Chunk Size parameter.
C1-TXNCM	106	Value { Given Transaction Header Id } too long for field { transactionHeaderId }. Maximum length: 14. Found: { Length of given Transaction Header Id }	11001	<p>The possible issues could be:</p> <ul style="list-style-type: none"> The value specified for the Transaction Header ID parameter exceeds the maximum length of 14 characters.
C1-TXNCM	106	Value { Given Transaction Source Code } too long for field { transactionSource }. Maximum length: 30. Found: { Length of given Transaction Source Code }	11001	<p>The possible issues could be:</p> <ul style="list-style-type: none"> The value specified for the Transaction Source parameter exceeds the maximum length of 30 characters.
C1-TXNCM	106	Value { Given Transaction Division } too long for field { division }. Maximum length: 5 Found: { Length of given Transaction Division }	11001	<p>The possible issues could be:</p> <ul style="list-style-type: none"> The value specified for the Division parameter exceeds the maximum length of 5 characters.

Batch Name	Message Number	Error Message	Message Category	Possible Issues
C1-TXNCM	1393	Either the transaction feed management setup is incomplete, or there is no active contract available.	17000	The possible issues could be: <ul style="list-style-type: none"> The SQIs are not defined for the product — division combination. The transaction aggregation rule is not defined for the SQL. There is no contract with the specified contract type available in the system. The contract is inactive.
C1-TXNCM	1556	{Maximum Batch Size} field should be greater than zero	17000	The possible issues could be: <ul style="list-style-type: none"> The value specified for the Maximum Batch Count parameter is less than or equal to zero.
C1-TXNCM	1636	Invalid batch run [% 1] for [%2] division(s). %3 Note: [% 1] stands for batch code; [%2] stands for division; [%3] stands for expected batch code	17000	The possible issues could be: <ul style="list-style-type: none"> You are trying to execute the C1-TXNCM batch before executing the C1-TXNIP batch.
C1-TXNCM	1638	Transaction Feed Management cycle for individual division(s) is not yet complete. Please complete pending batch runs before starting new cycle for processing [ALL] divisions.	17000	The possible issues could be: <ul style="list-style-type: none"> You are trying to execute this batch for all divisions before completing the transaction aggregation cycle which is initiated for a particular division.
C1-TXNCM	1639	Transaction Feed Management cycle for [ALL] divisions is not yet complete. Please complete pending batch runs before starting new cycle for individual division [% 1]. Note: [% 1] stands for division	17000	The possible issues could be: <ul style="list-style-type: none"> You are trying to execute this batch for a particular division before completing the transaction aggregation cycle which is initiated for all divisions.

Batch Name	Message Number	Error Message	Message Category	Possible Issues
C1-TXNCM	1644	Transaction Feed Management cycle for division(s) [%1] is already in progress with filter [Source= %2, Header= %3] criteria. Filter criteria must be same for complete cycle. Note: [%1] stands for division; [%2] stands for transaction source; [%3] stands for transaction header ID	17000	The possible issues could be: <ul style="list-style-type: none"> You are trying to execute this batch once again with the same division and different parameters.
C1-TXNCM	2003	One or more Sub Transactions are in EROR state.	17000	The possible issues could be: <ul style="list-style-type: none"> One or more transaction legs are in the Error (EROR) status.
C1-TXNCM	2026	SQIs not configured for product %1 and division %2. Note: [%1] stands for final product code; [%2] stands for derived division	17000	The possible issues could be: <ul style="list-style-type: none"> The SQIs are not defined for the product — division combination.
C1-TXNCM	2027	Currency Conversion from Currency [%1] to Currency [%2] not successful.	17000	The possible issues could be: <ul style="list-style-type: none"> The exchange rate is not available during currency conversion.
C1-TXNCU	101	{ Disaggregation From Date } field missing	11001	The possible issues could be: <ul style="list-style-type: none"> No value is specified for the Disaggregate Transactions From Date parameter when the request type is set to DISAGG.
C1-TXNCU	101	{ Request Type } field missing	11001	The possible issues could be: <ul style="list-style-type: none"> No value is specified for the Request Type parameter.
C1-TXNCU	101	{ Transaction Header Id } field missing	11001	The possible issues could be: <ul style="list-style-type: none"> No value is specified for the Transaction Header ID parameter when the request type is set to CNCL.

Batch Name	Message Number	Error Message	Message Category	Possible Issues
C1-TXNCU	102	{ Chunk Size } field invalid	11001	The possible issues could be: <ul style="list-style-type: none"> The value specified for the Chunk Size parameter is less than or equal to one.
C1-TXNCU	102	{ Maximum Batch Size } field invalid	11001	The possible issues could be: <ul style="list-style-type: none"> The value specified for the Maximum Batch Count parameter is greater than the value specified for the Chunk Size parameter.
C1-TXNCU	102	{ Request Type } field invalid	11001	The possible issues could be: <ul style="list-style-type: none"> The value other than 'EROR', 'CNCL' or 'DISAGG' is specified for the Request Type parameter.
C1-TXNCU	102	{ Transaction Division } field invalid	11001	The possible issues could be: <ul style="list-style-type: none"> The value for the Division parameter is specified when the request type is set to CNCL.
C1-TXNCU	102	{ Transaction Source Code } field invalid	11001	The possible issues could be: <ul style="list-style-type: none"> The value for the Transaction Source parameter is specified when the request type is set to CNCL.
C1-TXNCU	102	{ Account Id } field invalid	11001	The possible issues could be: <ul style="list-style-type: none"> The value for the Account ID parameter is specified when the request type is set to CNCL.
C1-TXNCU	102	{ Bill Cycle Code } field invalid	11001	The possible issues could be: <ul style="list-style-type: none"> The value for the Bill Cycle parameter is specified when the request type is set to CNCL.
C1-TXNCU	102	{ Disaggregation From Date } field invalid	11001	The possible issues could be: <ul style="list-style-type: none"> The value for the Disaggregate Transactions From Date parameter is specified when the request type is set to CNCL.
C1-TXNCU	102	{ Account Id } field invalid	11001	The possible issues could be: <ul style="list-style-type: none"> The value for the Account ID parameter is specified when the request type is set to EROR.

Batch Name	Message Number	Error Message	Message Category	Possible Issues
C1-TXNCU	102	{Bill Cycle Code } field invalid	11001	The possible issues could be: <ul style="list-style-type: none"> The value for the Bill Cycle parameter is specified when the request type is set to EROR.
C1-TXNCU	102	{Disaggregation From Date } field invalid	11001	The possible issues could be: <ul style="list-style-type: none"> The value for the Disaggregate Transactions From Date parameter is specified when the request type is set to EROR.
C1-TXNCU	102	{Transaction Header Id } field invalid	11001	The possible issues could be: <ul style="list-style-type: none"> The value for the Transaction Header ID parameter is specified when the request type is set to DISAGG.
C1-TXNCU	102	{ Transaction Source Code } field invalid	11001	The possible issues could be: <ul style="list-style-type: none"> The value for the Transaction Source parameter is specified when the request type is set to DISAGG.
C1-TXNCU	106	Value { Given Transaction Header Id } too long for field { transactionHeaderId }. Maximum length: 14. Found: { Length of given Transaction Header Id}	11001	The possible issues could be: <ul style="list-style-type: none"> The value specified for the Transaction Header ID parameter exceeds the maximum length of 14 characters.
C1-TXNCU	106	Value { Given Transaction Source Code } too long for field { transactionSource }. Maximum length: 30. Found: { Length of given Transaction Source Code}	11001	The possible issues could be: <ul style="list-style-type: none"> The value specified for the Transaction Source parameter exceeds the maximum length of 30 characters.
C1-TXNCU	106	Value { Given Transaction Division } too long for field { division }. Maximum length: 5 Found: { Length of given Transaction Division}	11001	The possible issues could be: <ul style="list-style-type: none"> The value specified for the Division parameter exceeds the maximum length of 5 characters.
C1-TXNCU	1388	Data configuration error for { SQI Fragment }.	17000	The possible issues could be: <ul style="list-style-type: none"> No data exists in the SQL_FRAG, TXN_PRM, SQI_CD, and SQL_FUNC columns of the CI_TXN_SQI_FRAG table. The data available in the SQL_FRAG, TXN_PRM, SQI_CD, and SQL_FUNC columns of the CI_TXN_SQI_FRAG table is not properly cached.

Batch Name	Message Number	Error Message	Message Category	Possible Issues
C1-TXNCU	1388	Data configuration error for { Price Item SQI }.	17000	The possible issues could be: <ul style="list-style-type: none"> No data exists in the PRICEITEM_CD, CIS_DIVISION, and SQI_CD columns of the CI_PRICEITEM_SQI table. The data available in the PRICEITEM_CD, CIS_DIVISION, and SQI_CD columns of the CI_PRICEITEM_SQI table is not properly cached.
C1-TXNCU	1391	Bill is completed hence cant cancel the header.	17000	The possible issues could be: <ul style="list-style-type: none"> You are trying to cancel a transaction feed for which a bill with the Complete status already exists in the system.
C1-TXNCU	1424	There are pending bills for the feed you want to cancel. Please execute the Pending Bill Deletion (C1-DELBL) batch.	17000	The possible issues could be: <ul style="list-style-type: none"> The Pending Bill Deletion (C1-DELBL) batch is not yet executed to delete the bills (generated for the feed) which are in the Pending status.
C1-TXNCU	1556	{Maximum Batch Size} field should be greater than zero	17000	The possible issues could be: <ul style="list-style-type: none"> The value specified for the Maximum Batch Count parameter is less than or equal to zero.
C1-TXNCU	1636	Invalid batch run [%1] for [%2] division(s). %3 Note: [%1] stands for batch code; [%2] stands for division; [%3] stands for expected batch code	17000	The possible issues could be: <ul style="list-style-type: none"> You are trying to execute the C1-TXNCU batch before executing the C1-TXNIP or C1-TXNCM batch.
C1-TXNCU	1638	Transaction Feed Management cycle for individual division(s) is not yet complete. Please complete pending batch runs before starting new cycle for processing [ALL] divisions.	17000	The possible issues could be: <ul style="list-style-type: none"> You are trying to execute this batch for all divisions before completing the transaction aggregation cycle which is initiated for a particular division.

Batch Name	Message Number	Error Message	Message Category	Possible Issues
C1-TXNCU	1639	Transaction Feed Management cycle for [ALL] divisions is not yet complete. Please complete pending batch runs before starting new cycle for individual division [%1].	17000	The possible issues could be: <ul style="list-style-type: none"> You are trying to execute this batch for a particular division before completing the transaction aggregation cycle which is initiated for all divisions.
		Note: [%1] stands for division		
C1-TXNCU	1644	Transaction Feed Management cycle for division(s) [%1] is already in progress with filter [Source= %2, Header= %3] criteria. Filter criteria must be same for complete cycle.	17000	The possible issues could be: <ul style="list-style-type: none"> You are trying to execute this batch once again with the same division and different parameters.
		Note: [%1] stands for division; [%2] stands for transaction source; [%3] stands for transaction header ID		
C1-TXNRB	102	{ Chunk Size } field invalid	11001	The possible issues could be: <ul style="list-style-type: none"> The value specified for the Chunk Size parameter is less than or equal to one.
C1-TXNRB	102	{ Maximum Batch Size } field invalid	11001	The possible issues could be: <ul style="list-style-type: none"> The value specified for the Maximum Batch Count parameter is greater than the value specified for the Chunk Size parameter.
C1-TXNRB	102	{ Status Value } field invalid	11001	The possible issues could be: <ul style="list-style-type: none"> The value other than 'ERROR' or 'IGNR' is specified for the Transaction Status parameter.
C1-TXNRB	102	{ RollBack From Date } field invalid	11001	The possible issues could be: <ul style="list-style-type: none"> The date specified in the Rollback From Date parameter is later than the date specified in the Rollback To Date parameter.
C1-TXNRB	1556	{Maximum Batch Size} field should be greater than zero	17000	The possible issues could be: <ul style="list-style-type: none"> The value specified for the Maximum Batch Count parameter is less than or equal to zero.

Batch Name	Message Number	Error Message	Message Category	Possible Issues
C1-DELBL	101	{ Transaction Header Id } field missing	11001	The possible issues could be: <ul style="list-style-type: none"> No value is specified for the Transaction Header ID parameter.
C1-DELBL	102	{ Chunk Size } field invalid	11001	The possible issues could be: <ul style="list-style-type: none"> The value specified for the Chunk Size parameter is less than or equal to one.
C1-DELBL	106	Value { Given Transaction Header Id } too long for field { transactionHeaderId }. Maximum length: 14. Found: { Length of given Transaction Header Id }	11001	The possible issues could be: <ul style="list-style-type: none"> The value specified for the Transaction Header ID parameter exceeds the maximum length of 14 characters.
C1-DELBL	1391	Bill is completed or bill segment is frozen or pending-cancelled hence can not cancel the header.	17000	The possible issues could be: <ul style="list-style-type: none"> You are trying to cancel a transaction feed for which a bill with the Pending status is already generated in the system. This pending bill has a bill segment in either Frozen or Pending Cancel status.
C1-DELBL	1556	{ Maximum Batch Size } field should be greater than zero	17000	The possible issues could be: <ul style="list-style-type: none"> The value specified for the Maximum Batch Count parameter is less than or equal to zero.
C1-TXCNC	101	{ Transaction Header Id } field missing	11001	The possible issues could be: <ul style="list-style-type: none"> No value is specified for the Transaction Header ID parameter.
C1-TXCNC	102	{ Chunk Size } field invalid	11001	The possible issues could be: <ul style="list-style-type: none"> The value specified for the Chunk Size parameter is less than or equal to one.
C1-TXCNC	102	{ Maximum Batch Size } field invalid	11001	The possible issues could be: <ul style="list-style-type: none"> The value specified for the Maximum Batch Count parameter is greater than the value specified for the Chunk Size parameter.

Batch Name	Message Number	Error Message	Message Category	Possible Issues
C1-TXCNC	1391	Bill is completed or bill segment is frozen or pending-cancelled hence can not cancel the header.	17000	The possible issues could be: <ul style="list-style-type: none"> You are trying to cancel a transaction feed for which a bill with the Pending status is already generated in the system. This pending bill has a bill segment in either Frozen or Pending Cancel status.
C1-TXCNC	1424	There are pending bills for the feed you want to cancel. Please execute the Pending Bill Deletion (C1-DELBL) batch.	17000	The possible issues could be: <ul style="list-style-type: none"> The Pending Bill Deletion (C1-DELBL) batch is not yet executed to delete the bills (generated for the feed) which are in the Pending status.
C1-TXCNC	1556	{Maximum Batch Size} field should be greater than zero	17000	The possible issues could be: <ul style="list-style-type: none"> The value specified for the Maximum Batch Count parameter is less than or equal to zero.
C1-DISTG	102	{Division} field invalid	11001	The possible issues could be: <ul style="list-style-type: none"> Division is not defined in the system.
C1-DISTG	102	{ Billing Cycle Code } field invalid	11001	The possible issues could be: <ul style="list-style-type: none"> Bill cycle is not defined in the system.
C1-IDENT	102	{Chunk Size} field invalid	11001	The possible issues could be: <ul style="list-style-type: none"> The value specified for the Chunk Size parameter is less than or equal to one.
C1-IDENT	1660	Disaggregate Transactions From Date would impose partial disaggregation for some billable charges	17000	The possible issues could be: <ul style="list-style-type: none"> The identified aggregated billable charges aggregate transactions whose transaction date falls before the disaggregate transactions from date.
C1-DRSUA	102	{Chunk Size} field invalid	11001	The possible issues could be: <ul style="list-style-type: none"> The value specified for the Chunk Size parameter is less than or equal to one.
C1-DRSUA	102	{Chunk Size} field invalid	11001	The possible issues could be: <ul style="list-style-type: none"> The value specified for the Chunk Size parameter is less than or equal to one.

Batch Name	Message Number	Error Message	Message Category	Possible Issues
C1-PDTXN	102	{ Chunk Size } field invalid	11001	The possible issues could be: <ul style="list-style-type: none"> The value specified for the Chunk Size parameter is less than or equal to one.
C1-PDTXN	102	{ Maximum Batch Size } field invalid	11001	The possible issues could be: <ul style="list-style-type: none"> The value specified for the Maximum Batch Count parameter is greater than the value specified for the Chunk Size parameter.
C1-PDTXN	1556	{ Maximum Batch Size } field should be greater than zero	17000	The possible issues could be: <ul style="list-style-type: none"> The value specified for the Maximum Batch Count parameter is less than or equal to zero.

Alert Notification for Transaction Feed Management

Oracle Revenue Management and Billing enables you to configure alert notification for the **Transaction Feed Management** feature. At present, the system supports the following two alert notifications:

- To Do Creation
- Email Notification

The objective of these notifications is to create an alert for the records which are in the **Ignored** or **Error** status. Once a To Do is created, it indicates the number of records which are in the **Ignored** or **Error** status. However, the email notification provides the error summary statistics.

A new batch named **C1-ERRAL** is introduced in this release. While executing the **C1-ERRAL** batch, you need to set the **To Do Created For** parameter to **TFM**. In addition, you need to specify the transaction status (for example, EROR or IGNR) for which you want to create an alert notification. On executing the **C1-ERRAL** batch, the system creates a To Do using the **C1-TXNER** To Do type.

The **C1-ERRAL** batch must be executed only after all the transaction feed management batches are executed successfully. If the **C1-ERRAL** batch is executed for the first time, the system considers all the transactions whose **CURR_SYS_PRS_DT** is earlier than or equal to the batch business date. However, in the subsequent execution, the system considers only those transactions whose **CURR_SYS_PRS_DT** is later than the last To Do generation date and earlier than or equal to the batch business date.

On clicking the To Do notification in the **To Do List** screen, you can view the error records in the **Feed Management Dashboard** screen. Note that the system will not create a new To Do when the To Do for the same drill key combination already exists in the **Open** status.

To create an email notification, you need to attach an algorithm which is created using the **C1-TFMERREML** algorithm type to the **To Do Post-Processing** system event of the **C1-TXNER** To Do type. On creating a To Do, the batch creates an email outbound message which contains the error summary statistics.

Feed Management Dashboard

The **Feed Management Dashboard** screen allows you to view the details of a transaction feed. It allows you to drill down and view:

- Transaction volume details of a feed at the division level
- Transactions in a feed which belong to a division
- Legs of a transaction
- SQIs which are associated with the price item-division combination to which a transaction is mapped
- Calculation lines generated for a transaction leg
- Characteristics of each calculation line

The **Feed Management Dashboard** screen contains the following zones:

- [Search](#) on page 1244
- [Division Level Information](#) on page 1250
- [Transaction Level Information](#) on page 1251
- [Transaction Leg Information](#) on page 1252
- [Transaction Leg Service Quantity](#) on page 1253
- [Transaction Leg Calculation Lines](#) on page 1254
- [Transaction Leg Calc Line Characteristics](#) on page 1255

Search

The **Search** zone allows you to search for a transaction feed using various search criteria. It also allows you to view the details of a transaction feed which is already uploaded in the system. It contains the following two sections:

- **Search Criteria** - The **Search Criteria** section contains the following fields:

Field Name	Field Description	Mandatory (Yes or No)
Search By	Used to indicate whether you want to search for the transaction volume details of a feed at the division level or transaction level. The valid values are: <ul style="list-style-type: none"> • Feed Level Details - Used to indicate that you want to search for the transaction volume details of a feed at the division level. • Transaction Level Details - Used to indicate that you want to search for the transaction volume details of a feed at the transaction level. 	Yes (Conditional)
	Note: By default, the Feed Level Details option is selected.	Note: This field is required for searching the transaction volume details at the division or transaction level.
Feed Header Date From	Used to search for transaction feeds having header date later than or equal to the specified date.	No
Transaction Source	Used to search for transaction feeds received from a particular transaction source.	No
Feed Header Date To	Used to search for transaction feeds having header date earlier than or equal to the specified date.	No

Field Name	Field Description	Mandatory (Yes or No)
File Name	Used to search for a transaction feed based on the file name.	No
Feed Load Date From	Used to search for transaction feeds which are uploaded on or later than the specified date.	No
Transaction Header ID	Used to search for a transaction feed based on the header ID.	No
Feed Load Date To	Used to search for transaction feeds which are uploaded on or earlier than the specified date.	No
Account Identifier Type	Used to indicate the identifier type based on which you want to search transaction feed details of an account. Note: This field appears when you select the Transaction Level Details option from the Search By field.	Yes (Conditional) Note: If you enter the primary account identifier as a search criteria, you have to select the account identifier type.
Primary Account Identifier	Used to search transaction feed for a particular account. Note: This field appears when you select the Transaction Level Details option from the Search By field.	Yes (Conditional) Note: If you select the account identifier type as a search criteria, you have to enter the primary account identifier.
Transaction Record Type	Used to search transaction feeds for transactions with a particular record type. Note: This field appears when you select the Transaction Level Details option from the Search By field.	No
Transaction Source	Used to search transaction feeds received from a particular transaction source. Note: This field appears when you select the Transaction Level Details option from the Search By field.	No
Transaction ID	Used to search for a particular transaction feed. Note: This field appears when you select the Transaction Level Details option from the Search By field.	No
Transaction Date From	Used to search transaction feeds for transactions which are performed on or later than the specified date. Note: This field appears when you select the Transaction Level Details option from the Search By field.	No

Field Name	Field Description	Mandatory (Yes or No)
External Reference Number	Used to search transaction feed with a particular external reference number.	No
	Note: This field appears when you select the Transaction Level Details option from the Search By field.	
Transaction Date To	Used to search transaction feeds for transactions which are performed on or earlier than the specified date.	No
	Note: This field appears when you select the Transaction Level Details option from the Search By field.	
Transaction Status	Used to search transaction feeds for transactions which are in a particular status. The valid values are: <ul style="list-style-type: none"> • Cancelled • Completed • Error • Ignored • Initial Product Derived • Invalid • Uploaded 	No
	Note: This field appears when you select the Transaction Level Details option from the Search By field.	
Division	Used to search transaction feeds that belong to a particular division.	No
	Note: This field appears when you select the Transaction Level Details option from the Search By field. You can view only those divisions to which you have access in the Division list.	
Error Code/Message	Used to search transaction feeds for transactions which are in the Error status and with a particular error message or error code.	No
	Note: This field appears when you select the Transaction Level Details option from the Search By field.	

Field Name	Field Description	Mandatory (Yes or No)
Error Category	Used to search transaction feeds for transactions which are in the Error status and which belong to a particular error category.	No
	Note: This field appears when you select the Transaction Level Details option from the Search By field.	

Note: You must specify at least one search criterion while searching for a transaction feed.

- **Search Results** - On clicking the **Search** button, the search results appear based on the specified search criteria. The **Search Results** section contains the following columns:

Column Name	Column Description
File Name	Displays the name of the file from where the transaction feed is uploaded.
Transaction Source	Displays the transaction source from where the transaction feed is received.
Transaction Header ID	Displays the transaction header ID.
	Note: The transaction header ID is generated automatically when the file is uploaded.
Transaction Header External ID	Displays the ID mentioned in the file header.
Feed Header Date	Displays the date mentioned in the file header.
Feed Load Date	Displays the date when the transaction feed was uploaded in the system.
Feed Status	Displays the status of the transaction feed. The valid values are: <ul style="list-style-type: none"> • Uploaded - Indicates that the transaction feed is uploaded. • Validated - Indicates that the file header is validated. • Cancelled - Indicates that the transaction feed is cancelled. • Invalid - Indicates that the file header validation failed.
Error Message	Indicates the reason why the file header validation failed.
Total Volume	Displays the total transaction volume of the feed.
Uploaded Volume	Displays the total transaction volume which is uploaded in the system.
Price Item Determined	Displays the total transaction volume which is validated and for which price item is determined in the system.
Completed Volume	Displays the total transaction volume for which billable charges are created and completed in the system.
Error Volume	Displays the total transaction volume which could not pass through the validation, price item determination, or billable charge creation process.
Cancelled Volume	Displays the total transaction volume which is cancelled in the system.
Ignored Volume	Displays the total transaction volume which is ignored in the system.
Invalid Volume	Displays the total transaction volume which is invalid.

Column Name	Column Description
Transactions Archived	Displays the total transaction volume which is archived in the system.
Transaction ID	<p>Displays the transaction record number for which the transaction information is saved in the system.</p> <p>Note: This column appears when you select the Transaction Level Details option from the Search By field.</p>
External Reference Number	<p>Displays the external reference number of the transaction.</p> <p>Note: This column appears when you select the Transaction Level Details option from the Search By field.</p>
Division	<p>Indicates the division to which the transaction belongs.</p> <p>Note: This column appears when you select the Transaction Level Details option from the Search By field.</p>
Transaction Record Type	<p>Displays the record type of the transaction.</p> <p>Note: This column appears when you select the Transaction Level Details option from the Search By field.</p>
Transaction Date	<p>Displays the date when the transaction is performed.</p> <p>Note: This column appears when you select the Transaction Level Details option from the Search By field.</p>
Processing Date	<p>Displays the date when the transaction is processed in the system.</p> <p>Note: This column appears when you select the Transaction Level Details option from the Search By field.</p>
Account Information	<p>Displays the concatenated string of information about the account for which the transaction is performed separated by a comma (,).</p> <p>Note:</p> <p>It has a link. On clicking the link, the Account screen appears where you can view the details of the respective account.</p> <p>This column appears when you select the Transaction Level Details option from the Search By field.</p>
Account Identifier Type	<p>Indicates the identifier type based on which the transaction is created for the account.</p> <p>Note: This column appears when you select the Transaction Level Details option from the Search By field.</p>
Primary Account Identifier	<p>Indicates the account for which the transaction is performed.</p> <p>Note: This column appears when you select the Transaction Level Details option from the Search By field.</p>

Column Name	Column Description
Transaction Volume	Displays the total transaction volume of the account.
	Note: This column appears when you select the Transaction Level Details option from the Search By field.
Transaction Amount	Displays the total transaction amount of the account.
	Note: This column appears when you select the Transaction Level Details option from the Search By field.
Credit/Debit Indicator	Indicates whether the transaction is a debit or credit transaction.
	Note: This column appears when you select the Transaction Level Details option from the Search By field.
Customer Reference Number	Indicates the customer who has performed the transaction.
	Note: This column appears when you select the Transaction Level Details option from the Search By field.
Transaction Status	Indicates the status of the transaction.
	Note: This column appears when you select the Transaction Level Details option from the Search By field.
Rule	Indicates the rule which was met while determining the initial price item for the transaction.
	<p>Note:</p> <p>It has a link. On clicking the link, the Rule window appears where you can view the details of the rule that was applied while determining the initial price item for the transaction.</p> <p>This column appears when you select the Transaction Level Details option from the Search By field.</p>
Transaction Information	Displays the concatenated string of information about the transaction separated by a comma (,).
	<p>Note:</p> <p>It has a link. On clicking the link, the Transaction Detail View window appears where you can view the details of the respective transaction.</p> <p>This column appears when you select the Transaction Level Details option from the Search By field.</p>

Note: Pagination is used to display limited number of records in the **Search Results** section. You can use the navigation links, such as **Previous** and **Next** to navigate between pages.

On clicking the **Broadcast** (📡) icon corresponding to the transaction feed in the **Search Results** section, the **Division Level Information** zone or the **Transaction Leg Information** zone appears depending on whether you select the **Feed Level Details** or the **Transaction Level Details** option from the **Search By** field respectively.

Related Topics

For more information on...	See...
How to search for a transaction feed	Searching for a Transaction Feed on page 1255
Division Level Information zone	Division Level Information on page 1250
Transaction Leg Information zone	Transaction Leg Information on page 1252

Division Level Information

The **Division Level Information** zone allows you to drill down and view the transaction volume details of a feed at the division level. It contains the following two sections:

- **Search Criteria** - The **Search Criteria** section contains the following field:

Field Name	Field Description	Mandatory (Yes or No)
Division	Used when you want to view the transaction volume details of a particular division received through the feed. Note: You can only view those divisions to which you have access in the Division list.	No

- **Search Results** - On clicking the **Search** button, the search results are filtered based on the specified search criteria. The **Search Results** section contains the following columns:

Column Name	Column Description
Division	Indicates the division.
Total Volume	Displays the total transaction volume of the division.
Uploaded Volume	Displays the total transaction volume (of the division) which is uploaded in the system.
Price Item Determined	Displays the total transaction volume (of the division) which is validated and for which price item is determined in the system.
Completed Volume	Displays the total transaction volume (of the division) for which billable charges are created and completed in the system.
Error Volume	Displays the total transaction volume (of the division) which could not pass through the validation, price item determination, or billable charge creation process.
Cancelled Volume	Displays the total transaction volume (of the division) which is cancelled in the system.
Ignored Volume	Displays the total transaction volume (of the division) which is ignored in the system.
Invalid Volume	Displays the total transaction volume (of the division) which is invalid.

By default, the **Division Level Information** zone does not appear in the **Feed Management Dashboard** screen. It appears when you select the **Feed Level Details** option from the **Search By** field and click the **Broadcast** () icon corresponding to the transaction feed in the **Search Results** section of the **Search** zone.

Related Topics

For more information on...	See...
How to view the division level details of a transaction feed	Viewing Division Level Details of a Transaction Feed on page 1256

Transaction Level Information

The **Transaction Level Information** zone lists the transactions in a feed which belong to a particular division. It contains the following columns:

Column Name	Column Description
Transaction ID	Displays the transaction ID.
External Reference Number	Displays the external reference number of the transaction.
Division	Indicates the division to which the transaction belongs.
Transaction Record Type	Displays the record type of the transaction.
Transaction Date	Displays the date when the transaction was performed.
Account Information	Displays the account for which the transaction is performed. Note: It has a link. On clicking the link, the Account screens appears where you can view the details of the respective account.
Account Identifier Type	Displays the type of account identifier.
Account Identifier	Indicates the account for which the transaction is performed.
Transaction Volume	Displays the transaction volume.
Transaction Amount	Displays the transaction amount.
Credit/Debit Indicator	Indicates whether the transaction is a debit or credit transaction.
Customer Reference Number	Indicates the customer who performed the transaction.
Transaction Status	Indicates the status of the transaction.
Error Message	Indicates the reason why the validation, price item determination, or billable charge creation process failed.
Rule	Indicates the rule which was met while determining initial price item for the transaction. Note: It has a link. On clicking the link, the Rule screen appears where you can view the details of the respective rule.
Transaction Information	Displays additional information about the transaction. Note: It has a link. On clicking the link, the Transaction Details screen appears where you can view the details of the respective transaction.

By default, the **Transaction Level Information** zone does not appear in the **Feed Management Dashboard** screen. It appears only when you click the **Broadcast** (📡) icon corresponding to a division in the **Division Level Information** zone.

On clicking the **Broadcast** (📡) icon corresponding to a transaction, the **Transaction Leg Information** zone appears where you can view a list of transaction legs of a particular transaction.

You can filter the list using various search criteria (such as, **External Reference Number**, **Primary Account Identifier**, **Account Identifier Type**, **Transaction Source**, **Transaction Record Type**, and **Transaction Status**) available in the **Filter** area. By default, the **Filter** area is hidden. You can view the **Filter** area by clicking the **Filters** (🔍) icon available in the upper right corner of this zone.

Related Topics

For more information on...	See...
How to view the transaction details of a division	Viewing Transactions that Belong to a Division on page 1256
Feed Management Dashboard screen	Feed Management Dashboard on page 1243
Transaction Leg Information zone	Transaction Leg Information on page 1252

Transaction Leg Information

The **Transaction Leg Information** zone lists the legs of a transaction. It contains the following columns:

Column Name	Column Description
Transaction ID	Indicates the transaction to which the transaction leg belongs.
Display Sequence	Displays the sequence number of transaction leg.
Account Identifier Type	Indicates the type of account identifier to which the transaction is mapped.
Primary Account Identifier	Indicates the account which will bear the charges for the transaction.
Error Message	Indicates the reason why the validation, price item determination, or billable charge creation process failed.
Price Item	Indicates the price item to which the transaction is mapped. Note: It has a link. On clicking the link, the Price Item screen appears where you can view the details of the respective price item.
Billable Charge ID	Indicates the billable charge which is created for the transaction leg. Note: The data appears in this column when the billable charge is created for the transaction leg. It has a link. On clicking the link, the Billable Charge screen appears where you can view the details of the billable charge.
Transaction Calculation ID	Displays the transaction calculation ID. Note: The data appears in this column when the transaction leg is rated before billing.
Initial Price Item Code	Indicates the initial price item to which the transaction was mapped.
Bill ID	Indicates the bill in which the transaction leg of the billable charge is included for billing.
Bill Segment ID	Indicates the bill segment to which the bill belongs.

Column Name	Column Description
Variance	Indicates the variance parameter which is used along with the price item for determining price item pricing. Note: This column appears when the Multi Price Parameter option type of the Multi Parameter Based Pricing (C1_PPARM_FLG) feature configuration is set to False .
Price Item Parameters	Displays a comma-separated list of parameter values. It indicates the price item parameters and their values which are used along with the price item for determining price item pricing. Note: This column appears when the Multi Price Parameter option type of the Multi Parameter Based Pricing (C1_PPARM_FLG) feature configuration is set to True .
Aggregation Parameter Group ID	Indicates the aggregation parameter group using which the transaction leg is aggregated in the billable charge.

Note: Pagination is used to display limited number of records in this zone. You can use the navigation links, such as **Previous** and **Next** to navigate between pages.

By default, the **Transaction Leg Information** zone does not appear in the **Feed Management Dashboard** screen. It appears when you click the **Broadcast** (📶) icon corresponding to a transaction in the **Transaction Level Information** zone.

Related Topics

For more information on...	See...
How to view the legs of a transaction	Viewing Legs of a Transaction on page 1257
Feed Management Dashboard screen	Feed Management Dashboard on page 1243
Transaction Level Information zone	Transaction Level Information on page 1251

Transaction Leg Service Quantity

The **Transaction Leg Service Quantity** zone lists the SQIs which are associated with the price item-division combination to which a transaction is mapped. It contains the following columns:

Column Name	Column Description
SQI	Indicates the service quantity identifier.
Daily Service Quantity	Displays the SQI value which is calculated using the transaction aggregation rule defined for the price item-division combination.

Note: Pagination is used to display limited number of records in this zone. You can use the navigation links, such as **Previous** and **Next** to navigate between pages.

By default, the **Transaction Leg Service Quantity** zone does not appear in the **Feed Management Dashboard** screen. It appears when you click the **Broadcast** (📶) icon corresponding to a transaction leg, which is rated before billing, in the **Transaction Leg Information** zone.

Related Topics

For more information on...	See...
How to view the SQIs calculated for a transaction leg	Viewing the SQIs Calculated for a Transaction Leg on page 1258
Feed Management Dashboard screen	Feed Management Dashboard on page 1243
Transaction Leg Information zone	Transaction Leg Information on page 1252

Transaction Leg Calculation Lines

During the pass through charge calculation, a calculation line is created for each rate component. The **Transaction Leg Calculation Lines** zone lists the calculation lines created for a transaction leg. It contains the following columns:

Column Name	Column Description
Transaction Calculation ID	Displays the transaction calculation ID.
Sequence	Indicates the sequence in which the calculation line is created. It is the sequence of the rate component which is used in the rate schedule.
Price Component ID	Indicates the price component which is used during calculation.
Rate Information	Displays the rate which is used for calculation.
SQI	Indicates the service quantity identifier.
Billable Service Quantity	Displays the SQI value used by the rates engine for calculation.
Calculated Amount	Displays the calculated charge amount which is rounded off. This amount appears in the invoice currency.
Description on Bill	Displays the summarized information about the calculation line that will be printed on the bill.
Precise Calculated Amount	Displays the calculated charge amount. This amount appears in the invoice currency.
Exempt Amount	Displays the amount of the calculated charge that the person does not have to pay due to tax exemption.
Base Amount	Displays the total amount derived from the cross-referenced line(s) that the current line is then used to calculate the charge amount.
Pricing Amount	Displays the calculated charge amount. This amount appears in the pricing currency.
Exchange Rate	Indicates the exchange rate which is used when the invoice currency is different from the pricing currency.
Print	Indicates whether information about the calculation line must be printed on the person's bill. The valid values are: <ul style="list-style-type: none"> • Y • N
Distribution Code	Indicates the distribution code associated with the rate component.
Pricing Currency	Indicates the currency in which the price item pricing is defined.
Aggregation Parameter Group ID	Indicates the aggregation parameter group using which the transaction leg is aggregated in the billable charge.

Note: Pagination is used to display limited number of records in this zone. You can use the navigation links, such as **Previous** and **Next** to navigate between pages.

By default, the **Transaction Leg Calculation Lines** zone does not appear in the **Feed Management Dashboard** screen. It appears when you click the **Broadcast** (📡) icon corresponding to a transaction leg, which is rated before billing, in the **Transaction Leg Information** zone.

Related Topics

For more information on...	See...
How to view the calculation lines of a transaction leg	Viewing the Calculation Lines of a Transaction Leg on page 1258
Feed Management Dashboard screen	Feed Management Dashboard on page 1243
Transaction Leg Information zone	Transaction Leg Information on page 1252

Transaction Leg Calc Line Characteristics

The **Transaction Leg Calc Line Characteristics** zone lists the characteristics of each calculation line. It contains the following columns:

Column Name	Column Description
Transaction Calculation ID	Displays the transaction calculation ID.
Sequence	Indicates the sequence in which the calculation line was created. It is the sequence of the rate component which is used in the rate schedule.
Characteristic Type	Indicates the characteristic type.
Characteristic Value	Displays the value of the characteristic type.

Note: Pagination is used to display limited number of records in this zone. You can use the navigation links, such as **Previous** and **Next** to navigate between pages.

By default, the **Transaction Leg Calc Line Characteristics** zone does not appear in the **Feed Management Dashboard** screen. It appears when you click the **Broadcast** (📡) icon corresponding to a transaction leg, which is rated before billing, in the **Transaction Leg Information** zone.

Related Topics

For more information on...	See...
How to view characteristics of a calculation line	Viewing Characteristics of a Calculation Line on page 1259
Feed Management Dashboard screen	Feed Management Dashboard on page 1243
Transaction Leg Information zone	Transaction Leg Information on page 1252

Searching for a Transaction Feed

Procedure

To search for a transaction feed:

1. Click the **Menu** link in the **Application** toolbar.
A list appears.
2. From the **Main** menu, select **Transaction and Audit Event Management** and then click **Feed Management Dashboard**.

The **Feed Management Dashboard** screen appears.

3. Enter the search criteria in the **Search** zone.

Note: ORMB search engine supports wildcard search, where you can substitute the percentage (%) symbol as a stand in for any word or letter in a search criteria. You can use the ‘%’ wildcard character in all input fields except the date and ID fields. The ‘%’ wildcard character is suffixed automatically at the end of the partial search criteria. Therefore, you may or may not specify the wildcard character at the end of the partial search criteria. However, you have to prefix the wildcard character manually wherever required.

4. Click **Search**.

A list of transaction feeds that meet the search criteria appears in the **Search Results** section.

Related Topics

For more information on...	See...
Feed Management Dashboard screen	Feed Management Dashboard on page 1243
Search zone	Search on page 1244

Viewing Division Level Details of a Transaction Feed

Procedure

To view the division level details of a transaction feed:

1. Ensure that the **Feed Level Details** option is selected from the **Search By** field in the **Search** zone of the **Feed Management Dashboard** screen for viewing the division level details of a transaction feed.
2. Click **Search**.
The search results appear based on the specified search criteria.
3. In the **Search Results** section, click the **Broadcast** (📡) icon corresponding to the transaction feed whose *division level details* you want to view.
The **Division Level Information** zone appears.
4. View the transaction volume details of each division in the **Division Level Information** zone.

Related Topics

For more information on...	See...
How to search for a transaction feed	Searching for a Transaction Feed on page 1255
Search zone	Search on page 1244
Feed Management Dashboard screen	Feed Management Dashboard on page 1243
Division Level Information zone	Division Level Information on page 1250

Viewing Transactions that Belong to a Division

Procedure

To view the transactions that belong to a division:

1. Ensure that the **Feed Level Details** option is selected from the **Search By** field in the **Search** zone of the **Feed Management Dashboard** screen for viewing the transactions that belong to a division.
2. Click **Search**.
The search results appear based on the specified search criteria.
3. In the **Search Results** section, click the **Broadcast** (📡) icon corresponding to the transaction feed whose details you want to view.
The **Division Level Information** zone appears.
4. Click the **Broadcast** (📡) icon corresponding to the division whose transaction details you want to view.
The **Transaction Level Information** zone appears.
5. View the list of the transactions that belong to the division in the **Transaction Level Information** zone.

Related Topics

For more information on...	See...
How to search for a transaction feed	Searching for a Transaction Feed on page 1255
Search zone	Search on page 1244
Feed Management Dashboard screen	Feed Management Dashboard on page 1243
Division Level Information zone	Division Level Information on page 1250
Transaction Level Information zone	Transaction Level Information on page 1251

Viewing Legs of a Transaction

Procedure

To view the legs of a transaction:

1. Search for the transaction feed in the **Feed Management Dashboard** screen.

Note: Ensure that the **Transaction Level Information** zone is expanded in the **Feed Management Dashboard** screen while you are viewing the division level details of a transaction feed.

2. In the **Search Results** section or the **Transaction Level Information** zone, click the **Broadcast** (📡) icon corresponding to the transaction feed whose details you want to view.
The **Transaction Leg Information** zone appears.
3. View the details of transaction legs in the **Transaction Leg Information** zone.

Related Topics

For more information on...	See...
How to search for a transaction feed	Searching for a Transaction Feed on page 1255
Feed Management Dashboard screen	Feed Management Dashboard on page 1243
Transaction Level Information zone	Transaction Level Information on page 1251
Transaction Leg Information zone	Transaction Leg Information on page 1252

Viewing the SQIs Calculated for a Transaction Leg

Procedure

To view the SQIs calculated for a transaction leg:

1. Ensure that the **Transaction Leg Information** zone is expanded in the **Feed Management Dashboard** screen.
2. Click the **Broadcast** () icon corresponding to the transaction leg (which is rated before billing) whose SQIs you want to view.

The **Transaction Leg Service Quantity**, **Transaction Leg Calculation Lines**, and **Transaction Leg Calc Line Characteristics** zones appear.

3. View the SQIs calculated for the transaction leg in the **Transaction Leg Service Quantity** zone.

Related Topics

For more information on...	See...
How to search for a transaction feed	Searching for a Transaction Feed on page 1255
Transaction Leg Information zone	Transaction Leg Information on page 1252
Feed Management Dashboard screen	Feed Management Dashboard on page 1243
Transaction Leg Service Quantity zone	Transaction Leg Service Quantity on page 1253
Transaction Leg Calculation Lines zone	Transaction Leg Calculation Lines
Transaction Leg Calc Line Characteristics zone	Transaction Leg Calc Line Characteristics on page 1255

Viewing the Calculation Lines of a Transaction Leg

Procedure

To view the calculation lines of a transaction leg:

1. Ensure that the **Transaction Leg Information** zone is expanded in the **Feed Management Dashboard** screen.
2. Click the **Broadcast** () icon corresponding to the transaction leg (which is rated before billing) whose calculation lines you want to view.

The **Transaction Leg Service Quantity**, **Transaction Leg Calculation Lines**, and **Transaction Leg Calc Line Characteristics** zones appear.

3. View the list of calculation lines generated for the transaction leg in the **Transaction Leg Calculation Lines** zone.

Related Topics

For more information on...	See...
How to search for a transaction feed	Searching for a Transaction Feed on page 1255
Transaction Leg Information zone	Transaction Leg Information on page 1252
Feed Management Dashboard screen	Feed Management Dashboard on page 1243
Transaction Leg Service Quantity zone	Transaction Leg Service Quantity on page 1253
Transaction Leg Calculation Lines zone	Transaction Leg Calculation Lines

For more information on...	See...
Transaction Leg Calc Line Characteristics zone	Transaction Leg Calc Line Characteristics on page 1255

Viewing Characteristics of a Calculation Line

Procedure

To view the characteristics of a calculation line:

1. Ensure that the **Transaction Leg Information** zone is expanded in the **Feed Management Dashboard** screen.
2. Click the **Broadcast** (📡) icon corresponding to the transaction leg (which is rated before billing) whose calculation line characteristics you want to view.

The **Transaction Leg Service Quantity**, **Transaction Leg Calculation Lines**, and **Transaction Leg Calc Line Characteristics** zones appear.

3. View the characteristics of each calculation line in the **Transaction Leg Calc Line Characteristics** zone.

Related Topics

For more information on...	See...
How to search for a transaction feed	Searching for a Transaction Feed on page 1255
Transaction Leg Information zone	Transaction Leg Information on page 1252
Feed Management Dashboard screen	Feed Management Dashboard on page 1243
Transaction Leg Service Quantity zone	Transaction Leg Service Quantity on page 1253
Transaction Leg Calculation Lines zone	Transaction Leg Calculation Lines
Transaction Leg Calc Line Characteristics zone	Transaction Leg Calc Line Characteristics on page 1255

Transaction Details

The **Transaction Details** screen allows you to search for a transaction using various search criteria. It also allows you to add and copy an existing transaction. It contains the following zones:

- [Search](#) on page 1259
- [Transaction Legs](#) on page 1263
- [Transaction Error Messages](#) on page 1266

Search

The **Search** zone allows you to search for a transaction using various search criteria. It contains the following two sections:

- **Search Criteria** - The **Search Criteria** section contains the following fields:

Field Name	Field Description	Mandatory (Yes or No)
Search By	Used to indicate whether you want to search transactions based on their current status. The valid values are: <ul style="list-style-type: none"> • Uploaded - Used to search transactions which are uploaded in the system. • Initial Price Item Determined - Used to search transactions for which a price item is determined. • Ignored - Used to search transactions which are ignored in the system. • Error - Used to search transactions with an error. • Cancelled - Used to search for transactions which are cancelled. • Completed - Used to search for transactions whose billable charge is completed. • Invalid - Used to search for invalid transactions. 	Yes (Conditional)
	Note: By default the Uploaded option is selected.	Note: This field is required for searching transactions which are in a particular status.
External Reference Number	Used to search a transaction with a particular external reference number.	No
Division	Used to search transactions that belong to a particular division.	No
	Note: You can only view those divisions to which you have access in the Division list.	
Transaction Source	Used to search transactions received from a particular transaction source.	No
Transaction Record Type	Used to search transactions with a particular record type.	No
Account Identifier Type	Used to select the identifier type based on which you want to search transactions of an account.	Yes (Conditional)
		Note: If you enter the primary account identifier as a search criteria, you have to select the account identifier type.

Field Name	Field Description	Mandatory (Yes or No)
Primary Account Identifier	Used to search transactions which are performed for a particular account.	Yes (Conditional)
		Note: If you select the account identifier type as a search criteria, you have to enter the primary account identifier.
Transaction Date	Used to search transactions which are performed on a particular date.	No
Transaction Upload Date	Used to search transactions which are uploaded in the system on a particular date.	No
Transaction Header ID	Used to search transactions which are uploaded through a particular transaction feed.	No
	Note: This field appears when you select the Uploaded, Ignored, Error, Cancelled, or Invalid options from the Search By field.	
Price Item	Used to search transactions which are mapped to a particular price item.	No
	Note: This field appears when you select the Initial Price Item Determined option from the Search By field.	
Billable Charge ID	Used to search transactions which are included in a particular billable charge.	No
	Note: This field appears when you select the Completed option from the Search By field.	
Disaggregated	Used to indicate whether you want to search transactions which are disaggregated. The valid values are: <ul style="list-style-type: none"> • Yes • No 	No

Note: You must specify at least one search criterion while searching for a transaction.

- **Search Results** - On clicking the **Search** button, the search results appear based on the specified search criteria. The **Search Results** section contains the following columns:

Column Name	Column Description
Transaction ID	Displays the transaction ID.
	Note: It has a link. On clicking the link, the Transaction Detail View screen appears where you can view the details of the respective transaction.
Transaction Source	Displays the transaction source from where the transaction is received.

Column Name	Column Description
Transaction Record Type	Displays the record type of the transaction.
Transaction Upload Date	Displays the date when the transaction is uploaded in the system. Note: This column appears when you select the Uploaded, Initial Price Item Determined, Ignored, Error, Cancelled, or Invalid options from the Search By list.
Transaction Header ID	Indicates the transaction feed through which the transaction was uploaded in the system. Note: This column appears when you select the Uploaded, Ignored, Cancelled, or Invalid options from the Search By list.
External Reference Number	Displays the external reference number of the transaction.
Customer Reference Number	Displays the reference number of the customer for the particular transaction. Note: This column appears when you select the Error option from the Search By field.
Disaggregation Status	Indicates whether the transaction was disaggregated or not. The valid values are: <ul style="list-style-type: none"> • Yes • No
Manual Entry	Indicates whether the transaction is manually added in the system. The valid values are: <ul style="list-style-type: none"> • Yes • No Note: This column appears when you select the Uploaded or Cancelled options from the Search By list.
Transaction Date	Displays the date when the transaction was performed.
Transaction Amount	Displays the transaction amount.
Transaction Volume	Displays the transaction volume.
Division	Indicates the division to which the transaction belongs.
Error Message	Displays the reason why the validation, price item determination, or billable charge creation process failed. Note: This column appears when you select the Error, or Invalid options from the Search By list.
Account Information	Displays the concatenated string of information about the account for which the transaction is performed separated by a comma (.). The string includes the account identifier type and account identifier.

Column Name	Column Description
Rule	<p>Indicates the rule which was met while determining initial price item for the transaction.</p> <p>Note:</p> <p>It has a link. On clicking the link, the Rule screen appears where you can view the details of the respective rule.</p> <p>This column appears when you select the Initial Price Item Determined, Ignored, Error, or Completed options from the Search By list.</p>
Transaction Information	<p>Displays additional information about the transaction.</p> <p>Note: It has a link. On clicking the link, the Transaction Detail View screen appears where you can view the details of the respective transaction.</p>

Note: Pagination is used to display limited number of records in the **Search Results** section. You can use the navigation links, such as **Previous** and **Next** to navigate between pages.

On clicking the **Broadcast** (📡) icon corresponding to a transaction in the **Search Results** section, the **Transaction Legs** or the **Transaction Error Messages** zone appears based on the status of the transaction.

Note: The **Broadcast** (📡) icon does not appear for transactions which are in the **Cancelled** status.

Related Topics

For more information on...	See...
How to search for a transaction	Searching for a Transaction on page 1267
How to copy a transaction	Adding a Transaction on page 1269
How to view the details of a transaction	Viewing the Transaction Details on page 1268
Transaction Legs zone	Transaction Legs on page 1263
Transaction Error Messages zone	Transaction Error Messages on page 1266

Transaction Legs

The **Transaction Legs** zone allows you to view the legs of a transaction. It contains the following columns:

Column Name	Column Description
Transaction ID	Indicates the transaction to which the transaction leg belongs.

Column Name	Column Description
Transaction Leg Status	<p>Indicates the status of the transaction leg. The valid values are:</p> <ul style="list-style-type: none"> • Uploaded • Initial Price Item Derived • Ignored • Error • Cancelled • Completed • Invalid <p>Note: This column appears only when you select the Initial Price Item Determined, Ignored, or Completed options from the Search By list.</p>
Initial Price Item Code	<p>Indicates the initial price item to which the transaction is mapped.</p> <p>Note: This column appears only when you select the Initial Price Item Determined, Ignored, or Completed options from the Search By list.</p>
Price Item Parameters	<p>Displays a comma-separated list of parameter values. It indicates the price item parameters and their values which are used along with the final price item for determining price item pricing.</p> <p>Note: This column appears only when you select the Initial Price Item Determined, Ignored, or Completed options from the Search By list and when the Multi Price Parameter option type of the Multi Parameter Based Pricing (C1_PPARM_FLG) feature configuration is set to True.</p>
Final Price Item Code	<p>Indicates the final price item to which the transaction is mapped.</p> <p>Note: This column appears only when you select the Initial Price Item Determined, Ignored, or Completed options from the Search By list.</p>
Pricing Rule Information	<p>Note: This column appears only when you select the Initial Price Item Determined option from the Search By list and when the transaction is uploaded for the health care domain.</p>
Price Assignment ID	<p>Indicates the effective pricing which is available for the account, price item or regular bundle (to which the price item belongs) or parent (regular) bundle (to which the regular bundle belongs) and/or variance parameter or price item parameters (parameter group) combination on the processing date.</p> <p>Note: This column appears only when you select the Initial Price Item Determined, Ignored, or Completed options from the Search By list.</p>

Column Name	Column Description
Aggregate Transaction	Indicates whether the transaction leg is aggregated. The valid values are: <ul style="list-style-type: none"> • Yes • No
	Note: This column appears only when you select the Initial Price Item Determined, Ignored, or Completed options from the Search By list.
Billable Charge ID	Indicates the billable charge in which the transaction leg is included for billing.
	Note: This column appears only when you select the Initial Price Item Determined, Ignored, or Completed options from the Search By list.
Transaction Source	Displays the transaction source from where the transaction is received.
Transaction Record Type	Displays the record type of the transaction.
Transaction Upload Date	Displays the date when the transaction is uploaded in the system.
External Reference Number	Displays the external reference number of the transaction.
Customer Reference Number	Displays the reference number using which the error message is created for the transaction performed by particular customer.
	Note: This column appears only when you select the Error option from the Search By list.
Disaggregation Status	Indicates whether the transaction is disaggregated or not. The valid values are: <ul style="list-style-type: none"> • Yes • No
Transaction Date	Displays the date when the transaction is performed.
Transaction Amount	Displays the transaction amount.
Transaction Volume	Displays the total transaction volume.
Division	Indicates the division to which the derived account belongs. The derived account means the account which will bear the charges for the transaction.
Sequence	Displays the sequence number of the transaction leg.
	Note: This column appears only when you select the Initial Price Item Determined, Ignored, or Completed options from the Search By list.
Error Message	Indicates the reason why the price item pricing verification or billable charge creation process failed.
	Note: This column appears only when you select the Initial Price Item Determined, Ignored, Error, or Completed options from the Search By list.

Column Name	Column Description
Account Information	Displays the concatenated string of information about the account which bears the charges for the transaction separated by a comma (.). The string includes the account identifier type, account identifier, and division (to which the derived account belongs).
	Note: This column appears only when you select the Initial Price Item Determined, Ignored, Error, or Completed options from the Search By list.
Rule	Indicates the rule which was met while determining the initial price item for the transaction.
	Note: It has a link. On clicking the link, the Rule screen appears where you can view the details of the respective rule. This column appears only when you select the Ignored, Error, or Completed options from the Search By list and when the transaction is uploaded for the financial services domain.
Transaction Information	Displays the concatenated string of information about the transaction separated by a comma (.).
	Note: It has a link. On clicking the link, the Transaction Detail View screen appears where you can view the details of the respective transaction.

Note:

The **Transaction Legs** zone does not appear for transactions which are in the **Uploaded, Cancelled, or Invalid** status. However, the **Transaction Legs** zone appears for transactions which are in the **Uploaded** status and partially disaggregated.

Related Topics

For more information on...	See...
How to search for a transaction	Searching for a Transaction on page 1267
How to view the details of a transaction	Viewing the Transaction Details on page 1268

Transaction Error Messages

The **Transaction Error Messages** zone allows you to view the reason why the transaction is in the **Error** or **Invalid** status. It contains the following column:

Column Name	Column Description
Error Message	Displays the reason why the transaction is in the Error or Invalid status.

Note: The **Transaction Error Messages** zone appears for transactions which are in the **Invalid** status only when the errors occur while executing the **Validate Transaction and Derive Price Item (C1-TXNIP)** batch. It does not appear when the errors occur while executing the **Price Item Pricing Verification (C1-TXNVP)** or **Service Quantity Calculation (C1-TXNSQ)** batch.

Related Topics

For more information on...	See...
How to search for a transaction	Searching for a Transaction on page 1267
How to view the details of a transaction	Viewing the Transaction Details on page 1268

Searching for a Transaction

Procedure

To search for a transaction:

1. Click the **Admin** link in the **Application** toolbar.
A list appears.
2. From the **Admin** menu, select **T** and then click **Transaction Details**.
The **Transaction Details** screen appears.
3. Enter the search criteria in the **Search** zone.

Note: ORMB search engine supports wildcard search, where you can substitute the percentage (%) symbol as a stand in for any word or letter in a search criteria. You can use the ‘%’ wildcard character in all input fields except the date and ID fields. The ‘%’ wildcard character is suffixed automatically at the end of the partial search criteria. Therefore, you may or may not specify the wildcard character at the end of the partial search criteria. However, you have to prefix the wildcard character manually wherever required.

4. Click **Search**.
A list of transactions that meet the search criteria appears in the **Search Results** section.

Related Topics

For more information on...	See...
Transaction Details screen	Transaction Details on page 1259
Search zone	Search on page 1259

Viewing the Transaction Legs

Procedure

To view the legs of a transaction:

1. Search for the transaction in the **Transaction Details** screen.
2. In the **Search Results** section, click the **Broadcast** () icon corresponding to the transaction whose legs you want to view.

The **Transaction Legs** zone appears.

Note:

The **Broadcast** () icon appears corresponding to a transaction which is in the **Uploaded, Initial Price Item Determined, Ignored, Error, and Completed** status. This is because you can only view legs of an uploaded, initial price item determined, ignored, error, or completed transaction

You can only view the legs of an uploaded transaction which is partially disaggregated.

3. View the details of the transaction legs in the **Transaction Legs** zone.

Related Topics

For more information on...	See...
How to search for a transaction	Searching for a Transaction on page 1267
Transaction Legs zone	Transaction Legs on page 1263

Viewing Error Messages**Procedure**

To view the error messages logged for a transaction:

1. Search for the transaction which is in the **Invalid** or **Error** status in the **Transaction Details** screen.
2. In the **Search Results** section, click the **Broadcast** () icon corresponding to the transaction whose error messages you want to view.

The **Transaction Error Messages** zone appears.

3. View the error messages in the **Transaction Error Messages** zone.

Note: The **Transaction Error Messages** zone appears for transactions which are in the **Invalid (INVL)** status only when the errors occur while executing the **Validate Transaction and Derive Price Item (C1-TXNIP)** batch. It does not appear when the errors occur while executing the **Price Item Pricing Verification (C1-TXNVP)** or **Service Quantity Calculation (C1-TXNSQ)** batch.

Related Topics

For more information on...	See...
How to search for a transaction	Searching for a Transaction on page 1267
Transaction Error Messages zone	Transaction Error Messages on page 1266

Viewing the Transaction Details**Procedure**

To view the details of a transaction:

1. Search for the transaction in the **Transaction Details** screen.
2. In the **Search Results** section, click the link in the **Transaction ID** or the **Transaction Information** column corresponding to the transaction whose details you want to view.

The **Transaction Detail View** screen appears.

3. View the details of the transaction in the **Transaction Detail View** screen.

Related Topics

For more information on...	See...
How to search for a transaction	Searching for a Transaction on page 1267
Transaction Details screen	Transaction Details on page 1259

Adding a Transaction

Prerequisites

To add a transaction manually, you should have:

- Divisions, account identifier types, transaction sources, transaction record types, and currencies defined in the application

Procedure

To add a transaction manually:

1. Click the **Admin** link in the **Application** toolbar.
A list appears.
2. From the **Admin** menu, select **T** and then click **Transaction Details**.
The **Transaction Details** screen appears.
3. Click the **Add** button in the upper right corner of the **Transaction Details** screen.

The **Transaction Details** screen appears. It contains the following fields:

Field Name	Field Description	Mandatory (Yes or No)
Transaction Source	Used to specify the transaction source from where the transaction is received.	Yes
Division	Used to specify the division to which the transaction belongs.	Yes
	Note: You can only view those divisions to which you have access in the Division list.	
Transaction Record Type	Used to specify the record type of the transaction.	Yes
Transaction Date	Used to specify the date when the transaction is performed.	Yes
Manual Entry	Indicates that the transaction is manually entered in the system.	Not applicable
Credit/Debit Indicator	Used to indicate whether the transaction is a debit or a credit transaction.	Yes
External Reference Number	Used to specify the external reference number of the transaction.	No
Customer Reference Number	Used to indicate the person who performed the transaction.	No
Account Identifier Type	Used to specify the type of account identifier.	Yes (Conditional)
		Note: If you enter the account identifier as a search criteria, you have to select the account identifier type.

Field Name	Field Description	Mandatory (Yes or No)
Primary Account Identifier	Used to indicate the account for which the transaction is performed.	Yes (Conditional)
		Note: If you specify the account identifier type as a search criteria, you have to enter the account identifier.
Transaction Amount	Used to specify the transaction amount.	Yes
Transaction Currency	Used to indicate the currency in which the transaction is performed.	Yes
Transaction Volume	Used to specify the transaction volume.	Yes
Additional Amount 1, Additional Amount 2, ..., Additional Amount 10	Used to specify additional information about the transaction.	Yes (Conditional)
	Note: These fields appear when you select the transaction source and record type from the respective list.	Note: This field is required when you are specifying the currency in the corresponding field.
Note: If the business label is defined for any of these user defined fields, the business label appears instead of the field name.		
Amount 1 Currency Code, Amount 2 Currency Code, ..., Amount 10 Currency Code	Used to specify additional information about the transaction.	Yes (Conditional)
	Note: These fields appear when you select the transaction source and record type from the respective list.	Note: This field is required when you are specifying the amount in the corresponding field.
Note: If the business label is defined for any of these user defined fields, the business label appears instead of the field name.		
Additional Date 1, Additional Date 2, ..., Additional Date 5	Used to specify additional information about the transaction.	No
	Note: These fields appear when you select the transaction source and record type from the respective list.	
Note: If the business label is defined for any of these user defined fields, the business label appears instead of the field name.		
Additional Numeric Data 1, Additional Numeric Data 2, Additional Numeric Data 3,, Additional Numeric Data 20	Used to specify additional information about the transaction.	No
	Note: These fields appear when you select the transaction source and record type from the respective list.	
Note: If the business label is defined for any of these user defined fields, the business label appears instead of the field name.		

Field Name	Field Description	Mandatory (Yes or No)
Additional Data 1, Additional Data 2, Additional Data 3,, Additional Data 50	Used to specify additional information about the transaction.	No
Note: If the business label is defined for any of these user defined fields, the business label appears instead of the field name.	Note: These fields appear when you select the transaction source and record type from the respective list.	

4. Enter the required details in the **Transaction Details** screen.

5. Click **Save**.

The transaction is added in the system.

Note:

If the following option types are set in the **Dummy Header (C1-TXNDMYID)** feature configuration, the header details including the header ID are generated automatically for the manually added transaction:

- Dummy File Name
- Dummy Header ID
- Dummy Transaction Source
- Dummy Header Date

The header ID remains same for all transactions which are manually created on a particular date. You can cancel manually added transactions using the Transaction Header ID.

Related Topics

For more information on...	See...
Transaction Details screen	Transaction Details on page 1259
How to set the Dummy Header (C1-TXNDMYID) feature configuration	Setting the C1-TXNDMYID Feature Configuration on page 3470

Copying a Transaction

Instead of creating a manual transaction from scratch, you can create a manual transaction using an existing transaction. This is possible through copying a transaction. On copying a transaction, the details including the division, account identifier type, primary account identifier, transaction source, transaction record type, external reference number, and customer reference number are also copied to the new transaction. You can then edit the details, if required.

Prerequisites

To copy a transaction, you should have:

- Transaction (whose copy you want to create) available in the application
- Divisions, account identifier types, transaction sources, transaction record types, and currencies defined in the application

Procedure

To copy a transaction:

1. Search for the transaction in the **Transaction Details** screen.
2. In the **Search Results** section, click the link in the **Transaction ID** or the **Transaction Information** column corresponding to the transaction whose copy you want to create.

The **Transaction Details** screen appears.

Note: The fields are in the read-only mode.

3. Click the **Copy** button available in the lower right corner of this screen.

The **Transaction Details** screen appears. It contains the following fields:

Field Name	Field Description	Mandatory (Yes or No)
Transaction Source	Used to specify the transaction source from where the transaction is received.	Yes
Division	Used to specify the division to which the transaction belongs.	Yes
	Note: You can only view those divisions to which you have access in the Division list.	
Transaction Record Type	Used to specify the record type of the transaction.	Yes
Transaction Date	Used to specify the date when the transaction is performed.	Yes
Manual Entry	Indicates that the transaction is manually entered in the system.	Not applicable
Credit/Debit Indicator	Used to indicate whether the transaction is a debit or a credit transaction.	Yes
External Reference Number	Used to specify the external reference number of the transaction.	No
Customer Reference Number	Used to indicate the person who performed the transaction.	No
Account Identifier Type	Used to specify the type of account identifier.	Yes (Conditional)
		Note: If you enter the account identifier as a search criteria, you have to select the account identifier type.
Primary Account Identifier	Used to indicate the account for which the transaction is performed.	Yes (Conditional)
		Note: If you specify the account identifier type as a search criteria, you have to enter the account identifier.
Transaction Amount	Used to specify the transaction amount.	Yes
Transaction Currency	Used to indicate the currency in which the transaction is performed.	Yes

Field Name	Field Description	Mandatory (Yes or No)
Transaction Volume	Used to specify the transaction volume.	Yes
Additional Amount 1, Additional Amount 2, ..., Additional Amount 10	Used to specify additional information about the transaction.	Yes (Conditional)
Note: If the business label is defined for any of these user defined fields, the business label appears instead of the field name.	Note: These fields appear when you select the transaction source and record type from the respective list.	Note: This field is required when you are specifying the currency in the corresponding field.
Amount 1 Currency Code, Amount 2 Currency Code, ..., Amount 10 Currency Code	Used to specify additional information about the transaction.	Yes (Conditional)
Note: If the business label is defined for any of these user defined fields, the business label appears instead of the field name.	Note: These fields appear when you select the transaction source and record type from the respective list.	Note: This field is required when you are specifying the amount in the corresponding field.
Additional Date 1, Additional Date 2, ..., Additional Date 5	Used to specify additional information about the transaction.	No
Note: If the business label is defined for any of these user defined fields, the business label appears instead of the field name.	Note: These fields appear when you select the transaction source and record type from the respective list.	
Additional Numeric Data 1, Additional Numeric Data 2, Additional Numeric Data 3,, Additional Numeric Data 20	Used to specify additional information about the transaction.	No
Note: If the business label is defined for any of these user defined fields, the business label appears instead of the field name.	Note: These fields appear when you select the transaction source and record type from the respective list.	
Additional Data 1, Additional Data 2, Additional Data 3, ..., Additional Data 50	Used to specify additional information about the transaction.	No
Note: If the business label is defined for any of these user defined fields, the business label appears instead of the field name.	Note: These fields appear when you select the transaction source and record type from the respective list.	

4. Enter the required details in the **Transaction Details** screen.

5. Click **Save**.

The new transaction is added in the system.

Related Topics

For more information on...	See...
How to search for a transaction	Searching for a Transaction on page 1267
Transaction Details screen	Transaction Details on page 1259

Transaction Source

The **Transaction Source** screen allows you to define, edit, delete, and copy a transaction source. It contains the following zone:

- [Search Transaction Source](#) on page 1274

Search Transaction Source

The **Search Transaction Source** zone allows you to search for a transaction source using various search criteria. It contains the following two sections:

- **Search Criteria** - The **Search Criteria** section contains the following fields:

Field name	Field Description	Mandatory (Yes or No)
Transaction Source	Used to search for a particular transaction source.	No
Description	Used to search transaction sources having a particular description.	No

- **Search Results** - On clicking the **Search** button, the search results appear based on the specified search criteria. The **Search Results** section contains the following columns:

Column Name	Column Description
Transaction Source	Displays the transaction source.
Description	Displays the description of the transaction source.
Account Identifier Type	Indicates the type of account identifier that will be received from the transaction source.
Edit	On clicking the Edit (✎) icon, the Transaction Source screen appears where you can edit the details of the existing transaction source.
Delete	On clicking the Delete (🗑) icon, you can delete the transaction source.
	Note: You can delete a transaction source only when it is not yet used in the system.
Copy	On clicking the Copy (📄) icon, the Transaction Source screen appears where you can define a new transaction source using an existing transaction source.

By default, the **Filter** area is hidden. You can view the **Filter** area by clicking the **Filters** (🔍) icon available in the upper right corner of this zone.

Related Topics

For more information on...	See...
How to search for a transaction source	Searching for a Transaction Source on page 1275
How to edit a transaction source	Editing a Transaction Source on page 1276
How to delete a transaction source	Deleting a Transaction Source on page 1277
How to copy a transaction source	Copying a Transaction Source on page 1277

Searching for a Transaction Source

Procedure

To search for a transaction source:

1. Click the **Admin** link in the **Application** toolbar.
A list appears.
2. From the **Admin** menu, select **T** and then click **Transaction Source**.
The **Transaction Source** screen appears.
3. Enter the search criteria in the **Search Transaction Source** zone.

Note: ORMB search engine supports wildcard search, where you can substitute the percentage (%) symbol as a stand in for any word or letter in a search criteria. You can use the ‘%’ wildcard character in all input fields except the date and ID fields. The ‘%’ wildcard character is suffixed automatically at the end of the partial search criteria. Therefore, you may or may not specify the wildcard character at the end of the partial search criteria. However, you have to prefix the wildcard character manually wherever required.

4. Click **Search**.

A list of transaction sources that meet the search criteria appears in the **Search Results** section.

Related Topics

For more information on...	See...
Transaction Source screen	Transaction Source on page 1274
Search Transaction Source zone	Search Transaction Source on page 1274

Defining a Transaction Source

Prerequisites

To define a transaction source, you should have:

- Account identifier types defined in the application

Procedure

To define a transaction source:

1. Click the **Admin** link in the **Application** toolbar.

A list appears.

- From the **Admin** menu, select **T** and then click **Transaction Source**.

The **Transaction Source** screen appears.

- Click the **Add** button in the upper right corner of the **Transaction Source** screen.

The **Transaction Source** screen appears. It contains the following fields:

Field Name	Field Description	Mandatory (Yes or No)
Transaction Source	Used to specify the transaction source.	Yes
	Note: You cannot specify any special character except underscore (_) in the Transaction Source field.	
Description	Used to specify the description for the transaction source.	Yes
Account Identifier Type	Used to indicate the type of account identifier that will be received from the transaction source.	Yes

- Enter the required details in the **Transaction Source** screen.

- Click **Save**.

The transaction source is defined.

Related Topics

For more information on...	See...
Transaction Source screen	Transaction Source on page 1274

Editing a Transaction Source

Prerequisites

To edit a transaction source, you should have:

- Account identifier types defined in the application

Procedure

To edit a transaction source:

- Search for the transaction source in the **Transaction Source** screen.
- In the **Search Results** section, click the **Edit** (✎) icon in the **Edit** column corresponding to the transaction source whose details you want to edit.

The **Transaction Source** screen appears. It contains the following fields:

Field Name	Field Description	Mandatory (Yes or No)
Transaction Source	Displays the transaction source.	Not applicable
Description	Used to specify the description for the transaction source.	Yes

Field Name	Field Description	Mandatory (Yes or No)
Account Identifier Type	Used to indicate the type of account identifier that will be received from the transaction source.	Yes

3. Modify the required details in the **Transaction Source** screen.
4. Click **Save**.

The changes made to the transaction source are saved.

Related Topics

For more information on...	See...
How to search for a transaction source	Searching for a Transaction Source on page 1275

Deleting a Transaction Source

Procedure

To delete a transaction source:

1. Search for the transaction source in the **Transaction Source** screen.
2. In the **Search Results** section, click the **Delete** (🗑️) icon in the **Delete** column corresponding to the transaction source that you want to delete.

A message appears confirming whether you want to delete the transaction source.

3. Click **OK**.

The transaction source is deleted.

Note: You can delete a transaction source only when it is not yet used in the system.

Related Topics

For more information on...	See...
How to search for a transaction source	Searching for a Transaction Source on page 1275

Copying a Transaction Source

Instead of creating a transaction source from scratch, you can create a new transaction source using an existing transaction source. This is possible through copying a transaction source. On copying a transaction source, the details including the description and account identifier type are also copied to the new transaction source. You can then edit the details, if required.

Prerequisites

To copy a transaction source, you should have:

- Transaction source (whose copy you want to create) defined in the application
- Account identifier types defined in the application

Procedure

To copy a transaction source:

1. Search for the transaction source in the **Transaction Source** screen.
2. In the **Search Results** section, click the **Copy** (📄) icon in the **Copy** column corresponding to the transaction source whose copy you want to create.

The **Transaction Source** screen appears. It contains the following fields:

Field Name	Field Description	Mandatory (Yes or No)
Transaction Source	Used to specify the transaction source.	Yes
	Note: You cannot specify any special character except underscore (_) in the Transaction Source field.	
Description	Used to specify the description for the transaction source.	Yes
Account Identifier Type	Used to indicate the type of account identifier that will be received from the transaction source.	Yes

3. Enter the required details in the **Transaction Source** screen.
4. Click **Save**.

The new transaction source is defined.

Related Topics

For more information on...	See...
How to search for a transaction source	Searching for a Transaction Source on page 1275
Transaction Source screen	Transaction Source on page 1274

Transaction Record Type

The **Transaction Record Type** screen allows you to define, edit, delete, and copy a transaction record type. While defining a transaction record type, you need to define a rule type. This rule type is invoked for transactions with the transaction source and record type combination. While defining a rule type, you can select the transaction detail fields that you want to use as input or output parameters in a rule.

Besides using the transaction detail fields, the system allows you to use fields which are not part of the standard transaction details. These fields are referred to as temporary fields and are defined similar to other fields, but are not associated with any ORMB tables. You need to associate temporary fields with the rule type while defining a transaction record type. Once associated, you can use the temporary field as input or output parameter while defining a rule using the rule type.

Note: At present, you can only associate a temporary field with a rule type, but cannot use the temporary field in a rule which is created using the rule type. The latter part of the functionality will be available in a future release of Oracle Revenue Management and Billing.

The **Transaction Record Type** screen consists of the following zones:

- [Search Transaction Record Type](#) on page 1279

Search Transaction Record Type

The **Search Transaction Record Type** zone allows you to search for a transaction record type. This zone contains the following two sections:

- **Search Criteria** - The **Search Criteria** section contains the following fields:

Field Name	Field Description	Mandatory (Yes or No)
Transaction Source	Used to search transaction record types defined for a particular transaction source.	No
Transaction Record Type	Used to search a particular transaction record type.	No
Description	Used to search transaction record types with a particular description.	No

- **Search Results** - On clicking the **Search** button, the search results appear based on the specified search criteria. The **Search Results** section contains the following columns:

Column Name	Column Description
Transaction Record Type	Displays the transaction record type.
Description	Displays the description of the transaction record type.
Transaction Source	Indicates the transaction source for which the transaction record type is defined.
Rule Type	Indicates the rule type that is invoked for the transaction record type. Note: It has a link. On clicking the link, the View Rule Type screen appears where you can view the details of the respective rule type.
Edit	On clicking the Edit (✎) icon, the Transaction Record Type screen appears where you can edit the details of the transaction record type.
Delete	On clicking the Delete (🗑) icon, you can delete the transaction record type. Note: You can delete a transaction record type when: <ul style="list-style-type: none"> • It is not yet used. • Rules are not yet defined using the rule type which is invoked by the transaction source and record type combination.
Copy	On clicking the Copy (📄) icon, the Transaction Record Type screen appears where you can create a new transaction record type using an existing transaction record type.

You can create a new transaction record type by clicking the **Add** link in the upper right corner of this zone.

Related Topics

For more information on...	See...
How to search for a transaction record type	Searching for a Transaction Record Type on page 1280
How to define a transaction record type	Defining a Transaction Record Type on page 1280

For more information on...	See...
How to edit a transaction record type	Editing a Transaction Record Type on page 1286
How to delete a transaction record type	Deleting a Transaction Record Type on page 1292
How to copy a transaction record type	Copying a Transaction Record Type on page 1293

Searching for a Transaction Record Type

Procedure

To search for a transaction record type:

1. Click the **Admin** link in the **Application** toolbar.
A list appears.
2. From the **Admin** menu, select **T** and then click **Transaction Record Type**.
The **Transaction Record Type** screen appears.
3. Enter the search criteria in the **Search Transaction Record Type** zone.

Note: ORMB search engine supports wildcard search, where you can substitute the percentage (%) symbol as a stand in for any word or letter in a search criteria. You can use the ‘%’ wildcard character in all input fields except the date and ID fields. The ‘%’ wildcard character is suffixed automatically at the end of the partial search criteria. Therefore, you may or may not specify the wildcard character at the end of the partial search criteria. However, you have to prefix the wildcard character manually wherever required.

4. Click **Search**.

The search results appear.

Related Topics

For more information on...	See...
Transaction Record Type screen	Transaction Record Type on page 1278
Search Transaction Record Type zone	Search Transaction Record Type on page 1279

Defining a Transaction Record Type

Prerequisites

To define a transaction record type, you should have:

- Transaction sources defined in the application
- Validation algorithm defined using the **C1-RULE-VAL** algorithm type
- Transaction Information String algorithm defined using the **C1-TXDETINFO** algorithm type
- Fields (that you want to use as input or output parameter) defined in the application

Procedure

To define a transaction record type:

1. Click the **Admin** link in the **Application** toolbar.

A list appears.

- From the **Admin** menu, select **T** and then click **Transaction Record Type**.

The **Transaction Record Type** screen appears.

- Click the **Add** link in the upper right corner of the **Search Transaction Record Type** zone.

The **Transaction Record Type** screen appears. It contains the following fields:

Field Name	Field Description	Mandatory (Yes or No)
Transaction Source	Used to indicate the transaction source for which you want to define the transaction record type.	Yes
	Note: The Search (🔍) icon appears corresponding to this field. On clicking the Search icon, the Search Transaction Source window appears.	
Transaction Record Type	Used to specify the transaction record type.	Yes
	Note: You cannot specify any special character except underscore (_) in the transaction record type.	
Description	Used to specify the description for the transaction record type.	Yes
Rule Type	Used to specify the rule type.	Yes
	Note: You cannot specify any special character except underscore (_) in the rule type.	
Rule Type Description	Used to specify the description for the rule type.	Yes
Rule Validation Algorithm	Used to specify the validation algorithm that will be triggered when a rule is defined using the rule type.	No
	Note: This algorithm checks whether: <ul style="list-style-type: none"> The values specified against the output parameters exist in the system The same price item parameter (for example, PCD1_1_1_VAL) is not used multiple times for a division, account, and price item combination The Search (🔍) icon appears corresponding to this field. On clicking the Search icon, the Algorithm Search window appears.	

Field Name	Field Description	Mandatory (Yes or No)
Info String Algorithm	<p>Used to specify the algorithm that will generate the information string which appears in the Transaction Information column throughout the application.</p> <p>Note: This algorithm concatenates the fields (related to the transaction) and delimiters specified as parameters in the algorithm.</p> <p>The Search (🔍) icon appears corresponding to this field. On clicking the Search icon, the Algorithm Search window appears.</p>	No
Maximum Accounts to be charged	<p>Used to indicate the maximum number of accounts which can bear the charges for a transaction. The valid values are:</p> <ul style="list-style-type: none"> • 01 • 02 • 03 • 04 • 05 • 06 • 07 • 08 • 09 • 10 <p>Note: At present, the system supports maximum 10 accounts which can bear the charges for a transaction.</p>	Yes

Field Name	Field Description	Mandatory (Yes or No)
Maximum Price Items to be mapped	<p>Used to indicate the maximum number of price items to which a transaction can be mapped for each account. The valid values are:</p> <ul style="list-style-type: none"> • 01 • 02 • 03 • 04 • 05 • 06 • 07 • 08 • 09 • 10 <p>Note: At present, the system supports maximum 10 price items to which a transaction can be mapped for each account.</p>	Yes

Field Name	Field Description	Mandatory (Yes or No)
Maximum Price Item Parameters	<p>Used to indicate the maximum number of parameters that can be used with each price item to determine the price item pricing. The valid values are:</p> <ul style="list-style-type: none"> • 00 • 01 • 02 • 03 • 04 • 05 • 06 • 07 • 08 • 09 • 10 • 11 • 12 • 13 • 14 • 15 	Yes
	<p>Note: At present, the system supports maximum 15 parameters that can be used with each price item to determine the price item pricing.</p>	

In addition, this screen contains the following two sections:

- **Input/Output Parameters** — Enables you to select the transaction detail fields that you can use as input or output parameter while defining a rule. It contains the following fields:

Field Name	Field Description	Mandatory (Yes or No)
Rule Input/Output	Used to indicate whether you want to use the transaction detail field as input or output parameter.	No
Transaction Field	Displays the transaction field name.	Not applicable
Business Label	<p>Used to specify a business label for the user defined fields.</p> <p>Note: The business label appears when you add, copy, or view a transaction in the Transaction Details screen. The label changes depending on the transaction source and record type combination that you have selected.</p>	No

Note: At present, you can use the following transaction fields as input or output parameter while defining a rule — Account Identifier (ACCT_NBR), Account Identifier Type (ACCT_NBR_TYPE_CD), Division (CIS_DIVISION), Currency Code (CURRENCY_CD), Customer Reference Number (CUST_REF_NBR), Do not Aggregate Switch (DO_NOT_AGG_SW), External Reference Number (EXT_TXN_NBR), Credit/Debit Indicator (HOW_TO_USE_TXN_FLG), Manual Entry (MANUAL_SW), Transaction Amount (TXN_AMT), Transaction Date (TXN_DTTM), Transaction Record Type (TXN_REC_TYPE_CD), Transaction Source (TXN_SOURCE_CD), Transaction Upload Date (TXN_UPLOAD_DTTM), Transaction Volume (TXN_VOL), Additional Amount 1 (UDF_AMT_1), Additional Amount 2 (UDF_AMT_2), Additional Amount 3 (UDF_AMT_3), Additional Amount 4 (UDF_AMT_4), Additional Amount 5 (UDF_AMT_5), Additional Amount 6 (UDF_AMT_6), Additional Amount 7 (UDF_AMT_7), Additional Amount 8 (UDF_AMT_8), Additional Amount 9 (UDF_AMT_9), Additional Amount 10 (UDF_AMT_10), Additional Data 1 (UDF_CHAR_1), Additional Data 2 (UDF_CHAR_2), Additional Data 3 (UDF_CHAR_3), Additional Data 4 (UDF_CHAR_4), Additional Data 5 (UDF_CHAR_5), Additional Data 6 (UDF_CHAR_6), Additional Data 7 (UDF_CHAR_7), Additional Data 8 (UDF_CHAR_8), Additional Data 9 (UDF_CHAR_9), Additional Data 10 (UDF_CHAR_10), Additional Data 11 (UDF_CHAR_11), Additional Data 12 (UDF_CHAR_12), Additional Data 13 (UDF_CHAR_13), Additional Data 14 (UDF_CHAR_14), Additional Data 15 (UDF_CHAR_15), Additional Data 16 (UDF_CHAR_16), Additional Data 17 (UDF_CHAR_17), Additional Data 18 (UDF_CHAR_18), Additional Data 19 (UDF_CHAR_19), Additional Data 20 (UDF_CHAR_20), Additional Data 21 (UDF_CHAR_21), Additional Data 22 (UDF_CHAR_22), Additional Data 23 (UDF_CHAR_23), Additional Data 24 (UDF_CHAR_24), Additional Data 25 (UDF_CHAR_25), Additional Data 26 (UDF_CHAR_26), Additional Data 27 (UDF_CHAR_27), Additional Data 28 (UDF_CHAR_28), Additional Data 29 (UDF_CHAR_29), Additional Data 30 (UDF_CHAR_30), Additional Data 31 (UDF_CHAR_31), Additional Data 32 (UDF_CHAR_32), Additional Data 33 (UDF_CHAR_33), Additional Data 34 (UDF_CHAR_34), Additional Data 35 (UDF_CHAR_35), Additional Data 36 (UDF_CHAR_36), Additional Data 37 (UDF_CHAR_37), Additional Data 38 (UDF_CHAR_38), Additional Data 39 (UDF_CHAR_39), Additional Data 40 (UDF_CHAR_40), Additional Data 41 (UDF_CHAR_41), Additional Data 42 (UDF_CHAR_42), Additional Data 43 (UDF_CHAR_43), Additional Data 44 (UDF_CHAR_44), Additional Data 45 (UDF_CHAR_45), Additional Data 46 (UDF_CHAR_46), Additional Data 47 (UDF_CHAR_47), Additional Data 48 (UDF_CHAR_48), Additional Data 49 (UDF_CHAR_49), Additional Data 50 (UDF_CHAR_50), Amount 1 Currency Code (UDF_CURRENCY_CD_1), Amount 2 Currency Code (UDF_CURRENCY_CD_2), Amount 3 Currency Code (UDF_CURRENCY_CD_3), Amount 4 Currency Code (UDF_CURRENCY_CD_4), Amount 5 Currency Code (UDF_CURRENCY_CD_5), Amount 6 Currency Code (UDF_CURRENCY_CD_6), Amount 7 Currency Code (UDF_CURRENCY_CD_7), Amount 8 Currency Code (UDF_CURRENCY_CD_8), Amount 9 Currency Code (UDF_CURRENCY_CD_9), Amount 10 Currency Code (UDF_CURRENCY_CD_10), Additional Date 1 (UDF_DTTM_1), Additional Date 2 (UDF_DTTM_2), Additional Date 3 (UDF_DTTM_3), Additional Date 4 (UDF_DTTM_4), Additional Date 5 (UDF_DTTM_5), Additional Numeric Data 1 (UDF_NBR_1), Additional Numeric Data 2 (UDF_NBR_2), Additional Numeric Data 3 (UDF_NBR_3), Additional Numeric Data 4 (UDF_NBR_4), Additional Numeric Data 5 (UDF_NBR_5), Additional Numeric Data 6 (UDF_NBR_6), Additional Numeric Data 7 (UDF_NBR_7), Additional Numeric Data 8 (UDF_NBR_8), Additional Numeric Data 9 (UDF_NBR_9), Additional Numeric Data 10 (UDF_NBR_10), Additional Numeric Data 11 (UDF_NBR_11), Additional Numeric Data 12 (UDF_NBR_12), Additional Numeric Data 13 (UDF_NBR_13), Additional Numeric Data 14 (UDF_NBR_14), Additional Numeric Data 15 (UDF_NBR_15), Additional Numeric Data 16 (UDF_NBR_16), Additional Numeric Data 17 (UDF_NBR_17), Additional Numeric Data 18 (UDF_NBR_18), Additional Numeric Data 19 (UDF_NBR_19), Additional Numeric Data 20 (UDF_NBR_20).

- **Temporary Fields** — Enables you to select non-transactional fields that you can use as input or output parameter while defining a rule. It contains the following fields:

Field Name	Field Description	Mandatory (Yes or No)
Temporary Field	Used to indicate the non-transactional field that you want to use as input or output parameter.	No
	<p>Note:</p> <p>The Search (🔍) icon appears corresponding to this field. On clicking the Search icon, the Transaction Record Type Tempo Field Search window appears.</p>	

- Enter the required details.

Note: You can search for a transaction source and algorithm by clicking the **Search** (🔍) icon corresponding to the respective field.

- Select the check box corresponding to the transaction fields that you want to use as input or output parameters.
- If required, you can select a non-transactional field as input or output parameter in the **Temporary Fields** section.

Note:

You can search for a field by clicking the **Search** (🔍) icon corresponding to the respective field.

If you want to add more than one temporary field to the transaction record type, click the **Add** (+) icon and then repeat step 7. However, if you want to remove a temporary field from the transaction record type, click the **Delete** (🗑️) icon corresponding to the temporary field.

- Click **Save**.

The transaction record type is defined.

Related Topics

For more information on...	See...
Transaction Record Type screen	Transaction Record Type on page 1278
Search Transaction Record Type zone	Search Transaction Record Type on page 1279

Editing a Transaction Record Type

Prerequisites

To edit a transaction record type, you should have:

- Validation algorithm defined using the **C1-RULE-VAL** algorithm type
- Transaction Information String algorithm defined using the **C1-TXDETINFO** algorithm type
- Fields (that you want to use as input or output parameter) defined in the application



Procedure

To edit a transaction record type:

- Search for the transaction record type in the **Transaction Record Type** screen.

2. In the **Search Results** section, click the **Edit**  icon in the **Edit** column corresponding to the transaction record type whose details you want to edit.

The **Transaction Record Type** screen appears. It contains the following fields:

Field Name	Field Description	Mandatory (Yes or No)
Transaction Source	Used to indicate the transaction source for which you want to define the transaction record type.	Yes
	Note: The Search  icon appears corresponding to this field. On clicking the Search icon, the Search Transaction Source window appears.	
Transaction Record Type	Used to specify the transaction record type.	Yes
	Note: You cannot specify any special character except underscore (_) in the transaction record type.	
Description	Used to specify the description for the transaction record type.	Yes
Rule Type	Used to specify the rule type.	Yes
	Note: You cannot specify any special character except underscore (_) in the rule type.	
Rule Type Description	Used to specify the description for the rule type.	Yes
Rule Validation Algorithm	Used to specify the validation algorithm that will be triggered when a rule is defined using the rule type.	No
	Note: This algorithm checks whether: <ul style="list-style-type: none"> • The values specified against the output parameters exist in the system • The same price item parameter (for example, PCD1_1_1_VAL) is not used multiple times for a division, account, and price item combination The Search  icon appears corresponding to this field. On clicking the Search icon, the Algorithm Search window appears.	

Field Name	Field Description	Mandatory (Yes or No)
Info String Algorithm	<p>Used to specify the algorithm that will generate the information string which appears in the Transaction Information column throughout the application.</p> <p>Note: This algorithm concatenates the fields (related to the transaction) and delimiters specified as parameters in the algorithm.</p> <p>The Search (🔍) icon appears corresponding to this field. On clicking the Search icon, the Algorithm Search window appears.</p>	No
Maximum Accounts to be charged	<p>Used to indicate the maximum number of accounts which can bear the charges for a transaction. The valid values are:</p> <ul style="list-style-type: none"> • 01 • 02 • 03 • 04 • 05 • 06 • 07 • 08 • 09 • 10 <p>Note: At present, the system supports maximum 10 accounts which can bear the charges for a transaction.</p>	Yes

Field Name	Field Description	Mandatory (Yes or No)
Maximum Price Items to be mapped	<p>Used to indicate the maximum number of price items to which a transaction can be mapped for each account. The valid values are:</p> <ul style="list-style-type: none"> • 01 • 02 • 03 • 04 • 05 • 06 • 07 • 08 • 09 • 10 <p>Note: At present, the system supports maximum 10 price items to which a transaction can be mapped for each account.</p>	Yes

Field Name	Field Description	Mandatory (Yes or No)
Maximum Price Item Parameters	<p>Used to indicate the maximum number of parameters that can be used with each price item to determine the price item pricing. The valid values are:</p> <ul style="list-style-type: none"> • 00 • 01 • 02 • 03 • 04 • 05 • 06 • 07 • 08 • 09 • 10 • 11 • 12 • 13 • 14 • 15 	Yes
	<p>Note: At present, the system supports maximum 15 parameters that can be used with each price item to determine the price item pricing.</p>	

In addition, this screen contains the following two sections:

- **Input/Output Parameters** — Enables you to select the transaction detail fields that you can use as input or output parameter while defining a rule. It contains the following fields:

Field Name	Field Description	Mandatory (Yes or No)
Rule Input/Output	Used to indicate whether you want to use the transaction detail field as input or output parameter.	No
Transaction Field	Displays the transaction field name.	Not applicable
Business Label	<p>Used to specify a business label for the user defined fields.</p> <p>Note: The business label appears when you add, copy, or view a transaction in the Transaction Details screen. The label changes depending on the transaction source and record type combination that you have selected.</p>	No

Note: At present, you can use the following transaction fields as input or output parameter while defining a rule — Account Identifier (ACCT_NBR), Account Identifier Type (ACCT_NBR_TYPE_CD), Division (CIS_DIVISION), Currency Code (CURRENCY_CD), Customer Reference Number (CUST_REF_NBR), Do not Aggregate Switch (DO_NOT_AGG_SW), External Reference Number (EXT_TXN_NBR), Credit/Debit Indicator (HOW_TO_USE_TXN_FLG), Manual Entry (MANUAL_SW), Transaction Amount (TXN_AMT), Transaction Date (TXN_DTTM), Transaction Record Type (TXN_REC_TYPE_CD), Transaction Source (TXN_SOURCE_CD), Transaction Upload Date (TXN_UPLOAD_DTTM), Transaction Volume (TXN_VOL), Additional Amount 1 (UDF_AMT_1), Additional Amount 2 (UDF_AMT_2), Additional Amount 3 (UDF_AMT_3), Additional Amount 4 (UDF_AMT_4), Additional Amount 5 (UDF_AMT_5), Additional Amount 6 (UDF_AMT_6), Additional Amount 7 (UDF_AMT_7), Additional Amount 8 (UDF_AMT_8), Additional Amount 9 (UDF_AMT_9), Additional Amount 10 (UDF_AMT_10), Additional Data 1 (UDF_CHAR_1), Additional Data 2 (UDF_CHAR_2), Additional Data 3 (UDF_CHAR_3), Additional Data 4 (UDF_CHAR_4), Additional Data 5 (UDF_CHAR_5), Additional Data 6 (UDF_CHAR_6), Additional Data 7 (UDF_CHAR_7), Additional Data 8 (UDF_CHAR_8), Additional Data 9 (UDF_CHAR_9), Additional Data 10 (UDF_CHAR_10), Additional Data 11 (UDF_CHAR_11), Additional Data 12 (UDF_CHAR_12), Additional Data 13 (UDF_CHAR_13), Additional Data 14 (UDF_CHAR_14), Additional Data 15 (UDF_CHAR_15), Additional Data 16 (UDF_CHAR_16), Additional Data 17 (UDF_CHAR_17), Additional Data 18 (UDF_CHAR_18), Additional Data 19 (UDF_CHAR_19), Additional Data 20 (UDF_CHAR_20), Additional Data 21 (UDF_CHAR_21), Additional Data 22 (UDF_CHAR_22), Additional Data 23 (UDF_CHAR_23), Additional Data 24 (UDF_CHAR_24), Additional Data 25 (UDF_CHAR_25), Additional Data 26 (UDF_CHAR_26), Additional Data 27 (UDF_CHAR_27), Additional Data 28 (UDF_CHAR_28), Additional Data 29 (UDF_CHAR_29), Additional Data 30 (UDF_CHAR_30), Additional Data 31 (UDF_CHAR_31), Additional Data 32 (UDF_CHAR_32), Additional Data 33 (UDF_CHAR_33), Additional Data 34 (UDF_CHAR_34), Additional Data 35 (UDF_CHAR_35), Additional Data 36 (UDF_CHAR_36), Additional Data 37 (UDF_CHAR_37), Additional Data 38 (UDF_CHAR_38), Additional Data 39 (UDF_CHAR_39), Additional Data 40 (UDF_CHAR_40), Additional Data 41 (UDF_CHAR_41), Additional Data 42 (UDF_CHAR_42), Additional Data 43 (UDF_CHAR_43), Additional Data 44 (UDF_CHAR_44), Additional Data 45 (UDF_CHAR_45), Additional Data 46 (UDF_CHAR_46), Additional Data 47 (UDF_CHAR_47), Additional Data 48 (UDF_CHAR_48), Additional Data 49 (UDF_CHAR_49), Additional Data 50 (UDF_CHAR_50), Amount 1 Currency Code (UDF_CURRENCY_CD_1), Amount 2 Currency Code (UDF_CURRENCY_CD_2), Amount 3 Currency Code (UDF_CURRENCY_CD_3), Amount 4 Currency Code (UDF_CURRENCY_CD_4), Amount 5 Currency Code (UDF_CURRENCY_CD_5), Amount 6 Currency Code (UDF_CURRENCY_CD_6), Amount 7 Currency Code (UDF_CURRENCY_CD_7), Amount 8 Currency Code (UDF_CURRENCY_CD_8), Amount 9 Currency Code (UDF_CURRENCY_CD_9), Amount 10 Currency Code (UDF_CURRENCY_CD_10), Additional Date 1 (UDF_DTTM_1), Additional Date 2 (UDF_DTTM_2), Additional Date 3 (UDF_DTTM_3), Additional Date 4 (UDF_DTTM_4), Additional Date 5 (UDF_DTTM_5), Additional Numeric Data 1 (UDF_NBR_1), Additional Numeric Data 2 (UDF_NBR_2), Additional Numeric Data 3 (UDF_NBR_3), Additional Numeric Data 4 (UDF_NBR_4), Additional Numeric Data 5 (UDF_NBR_5), Additional Numeric Data 6 (UDF_NBR_6), Additional Numeric Data 7 (UDF_NBR_7), Additional Numeric Data 8 (UDF_NBR_8), Additional Numeric Data 9 (UDF_NBR_9), Additional Numeric Data 10 (UDF_NBR_10), Additional Numeric Data 11 (UDF_NBR_11), Additional Numeric Data 12 (UDF_NBR_12), Additional Numeric Data 13 (UDF_NBR_13), Additional Numeric Data 14 (UDF_NBR_14), Additional Numeric Data 15 (UDF_NBR_15), Additional Numeric Data 16 (UDF_NBR_16), Additional Numeric Data 17 (UDF_NBR_17), Additional Numeric Data 18 (UDF_NBR_18), Additional Numeric Data 19 (UDF_NBR_19), Additional Numeric Data 20 (UDF_NBR_20).

- **Temporary Fields** — Enables you to select non-transactional fields that you can use as input or output parameter while defining a rule. It contains the following fields:

Field Name	Field Description	Mandatory (Yes or No)
Temporary Field	Used to indicate the non-transactional field that you want to use as input or output parameter.	No
	<p>Note:</p> <p>The Search (🔍) icon appears corresponding to this field. On clicking the Search icon, the Transaction Record Type Tempo Field Search window appears.</p>	

3. Modify the required details.

<p>Note:</p> <p>You can search for an algorithm and field by clicking the Search (🔍) icon corresponding to the respective field. You can edit and remove an input or output parameter from a rule type when it is not yet used in a rule (which is created using the rule type).</p> <p>If you want to add more than one temporary field to the transaction record type, click the Add (+) icon and then specify the details in the Temporary Fields section. However, if you want to remove a temporary field from the transaction record type, click the Delete (🗑️) icon corresponding to the temporary field.</p>
--

4. Click **Save**.

The changes made to the transaction record type are saved.

Related Topics

For more information on...	See...
How to search for a transaction record type	Searching for a Transaction Record Type on page 1280

Deleting a Transaction Record Type

Procedure

To delete a transaction record type:

1. Search for the transaction record type in the **Transaction Record Type** screen.
2. In the **Search Results** section, click the **Delete** (🗑️) icon in the **Delete** column corresponding to the transaction record type that you want to delete.

A message appears confirming whether you want to delete the transaction record type.

3. Click **OK**.

The transaction record type is deleted.

Note: You can delete a transaction record type only when it is not yet used in the system.

Related Topics

For more information on...	See...
How to search for a transaction record type	Searching for a Transaction Record Type on page 1280

Copying a Transaction Record Type

Instead of creating a transaction record type from scratch, you can create a new transaction record type using an existing transaction record type. This is possible through copying a transaction record type. On copying of a transaction record type, the details including the input or output parameters and temporary fields are also copied to the new transaction record type. You can then edit the details, if required.

Prerequisites

To copy a transaction record type, you should have:

- Transaction record type (whose copy you want to create) defined in the application
- Validation algorithm defined using the **C1-RULE-VAL** algorithm type
- Transaction Information String algorithm defined using the **C1-TXDETINFO** algorithm type
- Fields (that you want to use as input or output parameter) defined in the application

Procedure

To copy a transaction record type:

1. Search for the transaction record type in the **Transaction Record Type** screen.
2. In the **Search Results** section, click the **Copy** (📄) icon in the **Copy** column corresponding to the transaction record type whose copy you want to create.

The **Transaction Record Type** screen appears. It contains the following fields:

Field Name	Field Description	Mandatory (Yes or No)
Transaction Source	Used to indicate the transaction source for which you want to define the transaction record type.	Yes
	Note: The Search (🔍) icon appears corresponding to this field. On clicking the Search icon, the Search Transaction Source window appears where you can search for the required transaction source.	
Transaction Record Type	Used to specify the transaction record type.	Yes
	Note: You cannot specify any special character except underscore (_) in the transaction record type.	
Description	Used to specify the description for the transaction record type.	Yes
Rule Type	Used to specify the rule type.	Yes
	Note: You cannot specify any special character except underscore (_) in the rule type.	

Field Name	Field Description	Mandatory (Yes or No)
Rule Type Description	Used to specify the description for the rule type.	Yes
Rule Validation Algorithm	<p>Used to specify the validation algorithm that will be triggered when a rule is defined using the rule type.</p> <p>Note: This algorithm checks whether:</p> <ul style="list-style-type: none"> The values specified against the output parameters exist in the system The same price item parameter (for example, PCD1_1_1_VAL) is not used multiple times for a division, account, and price item combination <p>The Search (🔍) icon appears corresponding to this field. On clicking the Search icon, the Algorithm Search window appears where you can search for the required algorithm.</p>	No
Info String Algorithm	<p>Used to specify the algorithm that will generate the information string which appears in the Transaction Information column throughout the application.</p> <p>Note: This algorithm concatenates the fields (related to the transaction) and delimiters specified as parameters in the algorithm.</p> <p>The Search (🔍) icon appears corresponding to this field. On clicking the Search icon, the Algorithm Search window appears where you can search for the required algorithm.</p>	No
Maximum Accounts to be charged	<p>Used to indicate the maximum number of accounts which can bear the charges for a transaction. The valid values are:</p> <ul style="list-style-type: none"> 01 02 03 04 05 06 07 08 09 10 <p>Note: At present, the system supports maximum 10 accounts which can bear the charges for a transaction.</p>	Yes

Field Name	Field Description	Mandatory (Yes or No)
Maximum Price Items to be mapped	<p>Used to indicate the maximum number of price items to which a transaction can be mapped for each account. The valid values are:</p> <ul style="list-style-type: none"> • 01 • 02 • 03 • 04 • 05 • 06 • 07 • 08 • 09 • 10 <p>Note: At present, the system supports maximum 10 price items to which a transaction can be mapped for each account.</p>	Yes

Field Name	Field Description	Mandatory (Yes or No)
Maximum Price Item Parameters	<p>Used to indicate the maximum number of parameters that can be used with each price item to determine the price item pricing. The valid values are:</p> <ul style="list-style-type: none"> • 00 • 01 • 02 • 03 • 04 • 05 • 06 • 07 • 08 • 09 • 10 • 11 • 12 • 13 • 14 • 15 	Yes
	<p>Note: At present, the system supports maximum 15 parameters that can be used with each price item to determine the price item pricing.</p>	

In addition, this screen contains the following two sections:

- **Input/Output Parameters** — Enables you to select the transaction detail fields that you can use as input or output parameter while defining a rule. It contains the following fields:

Field Name	Field Description	Mandatory (Yes or No)
Rule Input/Output	Used to indicate whether you want to use the transaction detail field as input or output parameter.	No
Transaction Field	Displays the transaction field name.	Not applicable
Business Label	<p>Used to specify a business label for the user defined fields.</p> <p>Note: The business label appears when you add, copy, or view a transaction in the Transaction Details screen. The label changes depending on the transaction source and record type combination that you have selected.</p>	No

Note: At present, you can use the following transaction fields as input or output parameter while defining a rule — Account Identifier (ACCT_NBR), Account Identifier Type (ACCT_NBR_TYPE_CD), Division (CIS_DIVISION), Currency Code (CURRENCY_CD), Customer Reference Number (CUST_REF_NBR), Do not Aggregate Switch (DO_NOT_AGG_SW), External Reference Number (EXT_TXN_NBR), Credit/Debit Indicator (HOW_TO_USE_TXN_FLG), Manual Entry (MANUAL_SW), Transaction Amount (TXN_AMT), Transaction Date (TXN_DTTM), Transaction Record Type (TXN_REC_TYPE_CD), Transaction Source (TXN_SOURCE_CD), Transaction Upload Date (TXN_UPLOAD_DTTM), Transaction Volume (TXN_VOL), Additional Amount 1 (UDF_AMT_1), Additional Amount 2 (UDF_AMT_2), Additional Amount 3 (UDF_AMT_3), Additional Amount 4 (UDF_AMT_4), Additional Amount 5 (UDF_AMT_5), Additional Amount 6 (UDF_AMT_6), Additional Amount 7 (UDF_AMT_7), Additional Amount 8 (UDF_AMT_8), Additional Amount 9 (UDF_AMT_9), Additional Amount 10 (UDF_AMT_10), Additional Data 1 (UDF_CHAR_1), Additional Data 2 (UDF_CHAR_2), Additional Data 3 (UDF_CHAR_3), Additional Data 4 (UDF_CHAR_4), Additional Data 5 (UDF_CHAR_5), Additional Data 6 (UDF_CHAR_6), Additional Data 7 (UDF_CHAR_7), Additional Data 8 (UDF_CHAR_8), Additional Data 9 (UDF_CHAR_9), Additional Data 10 (UDF_CHAR_10), Additional Data 11 (UDF_CHAR_11), Additional Data 12 (UDF_CHAR_12), Additional Data 13 (UDF_CHAR_13), Additional Data 14 (UDF_CHAR_14), Additional Data 15 (UDF_CHAR_15), Additional Data 16 (UDF_CHAR_16), Additional Data 17 (UDF_CHAR_17), Additional Data 18 (UDF_CHAR_18), Additional Data 19 (UDF_CHAR_19), Additional Data 20 (UDF_CHAR_20), Additional Data 21 (UDF_CHAR_21), Additional Data 22 (UDF_CHAR_22), Additional Data 23 (UDF_CHAR_23), Additional Data 24 (UDF_CHAR_24), Additional Data 25 (UDF_CHAR_25), Additional Data 26 (UDF_CHAR_26), Additional Data 27 (UDF_CHAR_27), Additional Data 28 (UDF_CHAR_28), Additional Data 29 (UDF_CHAR_29), Additional Data 30 (UDF_CHAR_30), Additional Data 31 (UDF_CHAR_31), Additional Data 32 (UDF_CHAR_32), Additional Data 33 (UDF_CHAR_33), Additional Data 34 (UDF_CHAR_34), Additional Data 35 (UDF_CHAR_35), Additional Data 36 (UDF_CHAR_36), Additional Data 37 (UDF_CHAR_37), Additional Data 38 (UDF_CHAR_38), Additional Data 39 (UDF_CHAR_39), Additional Data 40 (UDF_CHAR_40), Additional Data 41 (UDF_CHAR_41), Additional Data 42 (UDF_CHAR_42), Additional Data 43 (UDF_CHAR_43), Additional Data 44 (UDF_CHAR_44), Additional Data 45 (UDF_CHAR_45), Additional Data 46 (UDF_CHAR_46), Additional Data 47 (UDF_CHAR_47), Additional Data 48 (UDF_CHAR_48), Additional Data 49 (UDF_CHAR_49), Additional Data 50 (UDF_CHAR_50), Amount 1 Currency Code (UDF_CURRENCY_CD_1), Amount 2 Currency Code (UDF_CURRENCY_CD_2), Amount 3 Currency Code (UDF_CURRENCY_CD_3), Amount 4 Currency Code (UDF_CURRENCY_CD_4), Amount 5 Currency Code (UDF_CURRENCY_CD_5), Amount 6 Currency Code (UDF_CURRENCY_CD_6), Amount 7 Currency Code (UDF_CURRENCY_CD_7), Amount 8 Currency Code (UDF_CURRENCY_CD_8), Amount 9 Currency Code (UDF_CURRENCY_CD_9), Amount 10 Currency Code (UDF_CURRENCY_CD_10), Additional Date 1 (UDF_DTTM_1), Additional Date 2 (UDF_DTTM_2), Additional Date 3 (UDF_DTTM_3), Additional Date 4 (UDF_DTTM_4), Additional Date 5 (UDF_DTTM_5), Additional Numeric Data 1 (UDF_NBR_1), Additional Numeric Data 2 (UDF_NBR_2), Additional Numeric Data 3 (UDF_NBR_3), Additional Numeric Data 4 (UDF_NBR_4), Additional Numeric Data 5 (UDF_NBR_5), Additional Numeric Data 6 (UDF_NBR_6), Additional Numeric Data 7 (UDF_NBR_7), Additional Numeric Data 8 (UDF_NBR_8), Additional Numeric Data 9 (UDF_NBR_9), Additional Numeric Data 10 (UDF_NBR_10), Additional Numeric Data 11 (UDF_NBR_11), Additional Numeric Data 12 (UDF_NBR_12), Additional Numeric Data 13 (UDF_NBR_13), Additional Numeric Data 14 (UDF_NBR_14), Additional Numeric Data 15 (UDF_NBR_15), Additional Numeric Data 16 (UDF_NBR_16), Additional Numeric Data 17 (UDF_NBR_17), Additional Numeric Data 18 (UDF_NBR_18), Additional Numeric Data 19 (UDF_NBR_19), Additional Numeric Data 20 (UDF_NBR_20).

- **Temporary Fields** — Enables you to select non-transactional fields that you can use as input or output parameter while defining a rule. It contains the following fields:

Field Name	Field Description	Mandatory (Yes or No)
Temporary Field	Used to indicate the non-transactional field that you want to use as input or output parameter.	No
	<p>Note:</p> <p>The Search (🔍) icon appears corresponding to this field. On clicking the Search icon, the Transaction Record Type Tempo Field Search window appears.</p>	

- Enter the required details.

Note: You can search for an algorithm by clicking the **Search** (🔍) icon corresponding to the respective field.

- Select the check box corresponding to the transaction fields that you want to use as input or output parameters.
- If required, you can select a non-transactional field as input or output parameter in the **Temporary Fields** section.

Note:

You can search for a field by clicking the **Search** (🔍) icon corresponding to the respective field.

If you want to add more than one temporary field to the transaction record type, click the **Add** (+) icon and then repeat step 5. However, if you want to remove a temporary field from the transaction record type, click the **Delete** (🗑️) icon corresponding to the temporary field.

- Click **Save**.

The new transaction record type is defined.

Related Topics

For more information on...	See...
How to search for a transaction record type	Searching for a Transaction Record Type on page 1280

Transaction Aggregation Rule

The **Transaction Aggregation Rule** screen allows you to define transaction aggregation rule for an SQL. You can also edit and delete the transaction aggregation rule of an SQL. This screen consists of the following zones:

- [Transaction Aggregation Rules](#) on page 1298

Transaction Aggregation Rules

The **Transaction Aggregation Rules** zone lists transaction aggregation rules that are already defined in the system. You can define, edit, and delete a transaction aggregation rule through this zone.

This zone contains the following columns:

Column Name	Column Description
SQI Description	Displays the description of the service quantity identifier (SQI).
Aggregation Function	Indicates the formula used in the transaction aggregation rule defined for the SQI.
Function	Indicates the function used for aggregation.
Transaction Parameter	Indicates the transaction parameter used for aggregation.
Edit	On clicking the Edit (✎) icon, the Transaction Aggregation Rule screen appears where you can edit the aggregation rule.
Delete	On clicking the Delete (🗑) icon, you can delete the transaction aggregation rule.

You can define transaction aggregation rule for an SQI by clicking the **Add** link in the upper right corner of this zone. You can also change the layout of this zone. For more information on how to change the layout, see [Changing the Layout](#) on page 3414.

Related Topics

For more information on...	See...
How to define transaction aggregation rule for an SQI	Defining Transaction Aggregation Rule for an SQI on page 1299
How to edit transaction aggregation rule of an SQI	Editing Transaction Aggregation Rule of an SQI on page 1300
How to delete transaction aggregation rule of an SQI	Deleting Transaction Aggregation Rule of an SQI on page 1301

Defining Transaction Aggregation Rule for an SQI

Prerequisites

To define transaction aggregation rule for an SQI, you should have:

- SQI defined in the application

Procedure

To define transaction aggregation rule for an SQI:

1. Click the **Admin** link in the **Application** toolbar.
A list appears.
2. From the **Admin** menu, select **T** and then click **Transaction Aggregation Rule**.
The **Transaction Aggregation Rule** screen appears.
3. Click the **Add** link in the upper right corner of the **Transaction Aggregation Rules** zone.
The **Transaction Aggregation Rule** screen appears. It contains the following fields:

Field Name	Field Description	Mandatory (Yes or No)
SQI	Used to indicate the SQI for which you want to define the transaction aggregation rule.	Yes

Field Name	Field Description	Mandatory (Yes or No)
Function	Used to indicate the function that you want to use for aggregation. The valid values are: <ul style="list-style-type: none"> SUM() MIN() MAX() COUNT() 	Yes
Transaction Parameter	Used to indicate the transaction parameter that you want to use for aggregation. The valid values are: <ul style="list-style-type: none"> TXN_AMT TXN_VOL UDF_AMT_1, UDF_AMT_2, UDF_AMT_3, ..., UDF_AMT_10 UDF_NBR_1, UDF_NBR_2, UDF_NBR_3, ..., UDF_NBR_20 	Yes

- Enter the required details.
- Click **Save**.

The transaction aggregation rule is defined for the SQL.

Related Topics

For more information on...	See...
Transaction Aggregation Rule screen	Transaction Aggregation Rule on page 1298
Transaction Aggregation Rules zone	Transaction Aggregation Rules on page 1298

Editing Transaction Aggregation Rule of an SQI

Procedure

To edit the transaction aggregation rule of an SQI:

- Click the **Admin** link in the **Application** toolbar.
A list appears.
- From the **Admin** menu, select **T** and then click **Transaction Aggregation Rule**.
The **Transaction Aggregation Rule** screen appears.
- Click the **Edit**  icon in the **Edit** column corresponding to the SQI whose transaction aggregation rule you want to edit.

The **Transaction Aggregation Rule** screen appears. It contains the following fields:

Field Name	Field Description	Mandatory (Yes or No)
SQI	Indicates the SQI for which the transaction aggregation rule is defined.	Not applicable

Field Name	Field Description	Mandatory (Yes or No)
Function	Used to indicate the function that you want to use for aggregation. The valid values are: <ul style="list-style-type: none"> SUM() MIN() MAX() COUNT() 	Yes
Transaction Parameter	Used to indicate the transaction parameter that you want to use for aggregation. The valid values are: <ul style="list-style-type: none"> TXN_AMT TXN_VOL UDF_AMT_1, UDF_AMT_2, UDF_AMT_3, ..., UDF_AMT_10 UDF_NBR_1, UDF_NBR_2, UDF_NBR_3, ..., UDF_NBR_20 	Yes

4. Modify the required details.
5. Click **Save**.

The changes made to the transaction aggregation rule are saved.

Related Topics

For more information on...	See...
Transaction Aggregation Rule screen	Transaction Aggregation Rule on page 1298
Transaction Aggregation Rules zone	Transaction Aggregation Rules on page 1298

Deleting Transaction Aggregation Rule of an SQI

Procedure

To delete the transaction aggregation rule of an SQI:

1. Click the **Admin** link in the **Application** toolbar.
A list appears.
2. From the **Admin** menu, select **T** and then click **Transaction Aggregation Rule**.
The **Transaction Aggregation Rule** screen appears.
3. Click the **Delete** (🗑️) icon in the **Delete** column corresponding to the SQI whose transaction aggregation rule you want to delete.
A message appears confirming whether you want to delete the transaction aggregation rule.
4. Click **OK**.

The transaction aggregation rule is deleted.

Related Topics

For more information on...	See...
Transaction Aggregation Rule screen	Transaction Aggregation Rule on page 1298
Transaction Aggregation Rules zone	Transaction Aggregation Rules on page 1298

Schedule

The **Schedule** screen allows you to view, define, edit, and delete a schedule. It contains the following zone:

- [Search Schedule](#) on page 1302



Search Schedule

The **Search Schedule** zone allows you to search for a schedule using various search criteria. It contains the following two sections:

- **Search Criteria** - The **Search Criteria** section contains the following fields:

Field Name	Field Description	Mandatory (Yes or No)
Aggregation Schedule	Used to search for a particular schedule.	No
Description	Used to search schedules with a particular description	No

- **Search Results** - On clicking the **Search** button, the search results appear based on the specified search criteria. The **Search Results** section contains the following columns:

Column Name	Column Description
Aggregation Schedule	Displays the schedule.
Description	Displays the description of the schedule.
View	On clicking the View () icon, the View Schedule UI Map screen appears where you can view the details of the schedule.
Edit	On clicking the Edit () icon, the Edit Schedule screen appears where you can edit the details of the schedule.
Delete	On clicking the Delete () icon, you can delete the schedule.
	Note: You can delete a schedule only when it is not yet used in the system.

By default, the **Filter** area is hidden. You can view the **Filter** area by clicking the **Filters** () icon available in the upper right corner of this zone.

Related Topics

For more information on...	See...
How to search for a schedule	Searching for a Schedule on page 1303
How to view the details of a schedule	Viewing the Schedule Details on page 1303
How to define a schedule	Defining a Schedule on page 1304

For more information on...	See...
How to edit a schedule	Editing a Schedule on page 1305
How to delete a schedule	Deleting a Schedule on page 1306

Searching for a Schedule

Procedure

To search for a schedule:

1. Click the **Admin** link in the **Application** toolbar.
A list appears.
2. From the **Admin** menu, select **S** and then click **Schedule**.
The **Schedule** screen appears.
3. Enter the search criteria in the **Search Schedule** zone.

Note: ORMB search engine supports wildcard search, where you can substitute the percentage (%) symbol as a stand in for any word or letter in a search criteria. You can use the ‘%’ wildcard character in all input fields except the date and ID fields. The ‘%’ wildcard character is suffixed automatically at the end of the partial search criteria. Therefore, you may or may not specify the wildcard character at the end of the partial search criteria. However, you have to prefix the wildcard character manually wherever required.

4. Click **Search**.
A list of schedules that meet the search criteria appears in the **Search Results** section.

Related Topics

For more information on...	See...
Schedule screen	Schedule on page 1302
Search Schedule zone	Search Schedule on page 1302

Viewing the Schedule Details

Procedure

To view the details of a schedule:

1. Search for the schedule in the **Schedule** screen.
2. In the **Search Results** section, click the **View** () icon in the **View** column corresponding to the schedule whose details you want to view.
The **View Schedule UI Map** screen appears.
3. View the details of the schedule in the **View Schedule UI Map** screen.

Related Topics

For more information on...	See...
How to search for a schedule	Searching for a Schedule on page 1303

Defining a Schedule

Prerequisites

To define a schedule, you should have:

- Schedule types defined in the application.

Procedure

To define a schedule:

1. Click the **Admin** link in the **Application** toolbar.

A list appears.

2. From the **Admin** menu, select **S** and then click **Schedule**.

The **Schedule** screen appears.

3. Click the **Add** link in the upper right corner of the **Search Schedule** zone.

The **Add/Edit Schedule UI Map** screen appears. It contains the following fields:

Field Name	Field Description	Mandatory (Yes or No)
Aggregation Schedule	Used to specify the schedule code.	Yes
Description	Used to specify the description for the schedule.	Yes

In addition, the **Add/Edit Schedule UI Map** screen contains the following two sections:

- **Schedule Periods** - Used to specify schedule periods for the schedule. It contains the following fields in a grid:

Field Name	Field Description	Mandatory (Yes or No)
Start Date	Used to specify the start date of the schedule period.	Yes
	Note: The start date cannot be later than the end date.	
End Date	Used to specify the end date of the schedule period.	Yes
	Note: The end date cannot be earlier than the start date.	

Note: At least one schedule period must be defined for the schedule. Also, ensure that the schedule periods do not have overlapping days.

- **Schedule Types** - Used to associate schedule types with the schedule. It contains the following field in a grid:

Field Name	Field Description	Mandatory (Yes or No)
Schedule Type	Used to indicate the functionality where you want to use the schedule.	Yes
	Note: You can associate multiple schedule types with a schedule.	

- Enter the required details in the **Add/Edit Schedule UI Map** screen.
- If you want to define more than one schedule period for the schedule, click the **Add (+)** icon corresponding to the schedule period and then specify the *details*.

Note: However, if you want to remove a schedule period from the schedule, click the **Delete (🗑)** icon corresponding to the schedule period.

- Similarly, If you want to associate more than one schedule type with the schedule, click the **Add (+)** icon corresponding to the schedule type and then specify the *details*.

Note: However, if you want to remove a schedule type from the schedule, click the **Delete (🗑)** icon corresponding to the schedule type.

- Click **Save**.

The schedule is defined.

Related Topics

For more information on...	See...
Schedule screen	Schedule on page 1302
Search Schedule zone	Search Schedule on page 1302

Editing a Schedule

Prerequisites

To edit a schedule, you should have:

- Schedules (which you want to edit) defined in the application
- Schedule types defined in the application.

Procedure

To edit a schedule:

- Search for the schedule in the **Schedule** screen.
- In the **Search Results** section, click the **Edit (✎)** icon in the **Edit** column corresponding to the schedule whose details you want to edit.

The **Add/Edit Schedule UI Map** screen appears. It contains the following fields:

Field Name	Field Description	Mandatory (Yes or No)
Schedule	Displays the schedule code.	Not applicable

Field Name	Field Description	Mandatory (Yes or No)
Description	Used to specify the description for the schedule.	Yes

In addition, this screen contains the following two sections:

- **Schedule Periods** - Used to add, edit, or delete the schedule periods from the schedule. It contains the following fields in a grid:

Field Name	Field Description	Mandatory (Yes or No)
Start Date	Used to specify the start date of the schedule period.	Yes
	Note: The start date cannot be later than the end date.	
End Date	Used to specify the end date of the schedule period.	Yes
	Note: The end date cannot be earlier than the start date.	

- **Schedule Types** - Used to associate or disassociate schedule types from the schedule. It contains the following field in a grid:

Field Name	Field Description	Mandatory (Yes or No)
Schedule Type	Used to indicate the functionality where you want to use the schedule.	Yes

3. Modify the required details in the **Add/Edit Schedule UI Map** screen.
4. Click **Save**.

The changes made to the schedule are saved.

Related Topics

For more information on...	See...
How to search for a schedule	Searching for a Schedule on page 1303

Deleting a Schedule

Procedure

To delete a schedule:

1. Search for the schedule in the **Schedule** screen.
2. In the **Search Results** section, click the **Delete** (🗑️) icon in the **Delete** column corresponding to the schedule that you want to delete.

A message appears confirming whether you want to delete the schedule.

Note: You can delete a schedule only when it is not yet used in the system.

3. Click **OK**.

The schedule is deleted.

Related Topics

For more information on...	See...
How to search for a schedule	Searching for a Schedule on page 1303

Disaggregation Request

Through the **Disaggregation Request Creation (C1-DISTG)** batch, you can only create a disaggregation request for an account. However, from the **Disaggregation Request** screen, you can create a disaggregation request for a person, account, price item, price assignment, billable charge, and parent accumulation group. When you create a disaggregation request for a person, the system does not create the disaggregation request for the person. Instead, the system creates the disaggregation request for all accounts of the person (where the person is the main customer) and its child persons.

The **Disaggregation Request** screen allows you to search for disaggregation requests using various search criteria. It also allows you to create and delete a disaggregation request. It contains the following zone:

- [Search Disaggregation Request](#) on page 1307

Search Disaggregation Request

The **Search Disaggregation Request** zone allows you to search for a disaggregation request using various search criteria. It contains the following two sections:

- **Search Criteria** - The **Search Criteria** section contains the following fields:

Field Name	Field Description	Mandatory (Yes or No)
Search By	Used to indicate whether you want to search for a disaggregation request using the person, account, or accumulation group details. The valid values are: <ul style="list-style-type: none"> • Person • Account • Accumulation Group 	Yes
	Note: By default, the Person option is selected.	
Person ID	Used to search disaggregation requests which are created for accounts of a particular person.	No
	Note: This field appears only when the Person option is selected from the Search By list.	

Field Name	Field Description	Mandatory (Yes or No)
Division	Used to search disaggregation requests which are created for accounts belonging to a particular division.	Yes (Conditional)
	<p>Note:</p> <p>You can only view those divisions to which you have access in the Division list.</p> <p>This field appears only when the Person or Account option is selected from the Search By list.</p>	<p>Note: This field is required while searching for a disaggregation request using the account details.</p>
Person Name	Used to search disaggregation requests which are created for accounts belonging to persons with a particular name.	No
	<p>Note: This field appears only when the Person option is selected from the Search By list.</p>	
Request Source	<p>Used to search disaggregation requests which are created using a particular process. The valid values are:</p> <ul style="list-style-type: none"> • AUTOMATIC • BATCH • MANUAL 	No
Person Identifier Type	Used to indicate the person identifier type based on which you want to search disaggregation requests created for a person.	Yes (Conditional)
	<p>Note: This field appears when the Person option is selected from the Search By list.</p>	<p>Note: If you specify the person identifier as a search criteria, you have to select the person identifier type.</p>
Person Identifier	Used to specify the value for the person identifier type based on which you want to search disaggregation requests created for a person.	Yes (Conditional)
	<p>Note: This field appears only when the Person option is selected from the Search By list.</p>	<p>Note: If you specify the person identifier type as a search criteria, you have to specify the person identifier.</p>
Request Created From	Used to search disaggregation requests which are created from a particular date onwards.	Yes (Conditional)
		<p>Note: This field is required while searching for a disaggregation request using the person or account details.</p>

Field Name	Field Description	Mandatory (Yes or No)
Request Created Until	Used to search disaggregation requests which are created till a particular date.	Yes (Conditional) Note: This field is required while searching for a disaggregation request using the person or account details.
From Processing Date	Used to search disaggregation requests which are processed from a particular date onwards.	No
To Processing Date	Used to search disaggregation requests which are processed till a particular date.	No
Request Type	Used to search disaggregation requests with a particular request type. The valid values are: <ul style="list-style-type: none"> • Account - Used to search disaggregation requests which are created for accounts. • Billable Charge - Used to search disaggregation requests which are created for billable charges. • Person - Used to search disaggregation requests which are created for all the accounts of a person. • Price Assignment - Used to search disaggregation requests which are created for price assignments. • Price Item - Used to search disaggregation requests which are created for price items. Note: This field appears only when the Person or Account option is selected from the Search By list.	No
Request Status	Used to search disaggregation requests which are in a particular status. The valid values are: <ul style="list-style-type: none"> • COMPLETE • PENDING 	No
Price Item	Used to search disaggregation request for an account or for one or more accounts of a person and its child persons where a particular price item is assigned. Note: This field appears only when the Person or Account option is selected from the Search By list.	No

Field Name	Field Description	Mandatory (Yes or No)
Billable Charge ID	Used to search disaggregation request for an account for which a particular billable charge is created.	No
	Note: This field appears only when the Person or Account option is selected from the Search By list.	
Price Assignment ID	Used to search disaggregation request for an account with a particular price assignment.	No
	Note: This field appears only when the Person or Account option is selected from the Search By list.	
Account ID	Used to search disaggregation requests which are created for a particular account.	No
	Note: This field appears only when you select the Account option from the Search By list.	
Account Identifier Type	Used to indicate the account identifier type based on which you want to search disaggregation requests created for an account.	Yes (Conditional)
	Note: This field appears when you select the Account option from the Search By list.	
Account Identifier	Used to specify the value for the account identifier type based on which you want to search disaggregation requests created for an account.	Yes (Conditional)
	Note: This field appears only when you select the Account option from the Search By list.	
Accumulation Type	Used to indicate the accumulation type based on which you want to search disaggregation requests created for an accumulation group.	No
	Note: This field appears only when you select the Accumulation Group option from the Search By list.	
Parent Accumulation Group ID	Used to search disaggregation requests created for a particular parent accumulation group.	No
	Note: This field appears only when you select the Accumulation Group option from the Search By list.	

- **Search Results** - On clicking the **Search** button, the search results appear based on the specified search criteria. The **Search Results** section contains the following columns:

Column Name	Column Description
Request ID	Displays the disaggregation request ID.
Request Creation Date	Displays the date when the disaggregation request is created.
Status	Indicates the status of the disaggregation request. The valid values are: <ul style="list-style-type: none"> • COMPLETE • PENDING
Account ID	Indicates the account for which the disaggregation request is created.
Person ID	Indicates the person for whom the disaggregation request is created.
Person Information	Displays the concatenated string of information about the person separated by a comma (.). In addition, a context menu appears corresponding to this field which helps in navigating to other screens in the application.
	Note: It has a link. On clicking the link, the Person screen appears with the details of the respective person.
Account Information	Displays the concatenated string of information about the account separated by a comma (.). In addition, a context menu appears corresponding to this field which helps in navigating to other screens in the application.
	Note: It has a link. On clicking the link, the Account screen appears with the details of the respective account. This column appears only when you select the Account option from the Search By list.
Processing Date	Displays the date when the disaggregation request is processed.
Request Type	Displays the request type based on which the disaggregation request is processed. The valid values are: <ul style="list-style-type: none"> • Account - Indicates that the disaggregation request is created for an account. • Billable Charge - Indicates that the disaggregation request is created for a billable charge. • Person - Indicates that the disaggregation request is created for a all the accounts of a person. • Price Assignment - Indicates that the disaggregation request is created for a price assignment. • Price Item - Indicates that the disaggregation request is created for a price item.

Column Name	Column Description
Price Item Information	Displays the concatenated string of information about the price item for which the disaggregation request is created separated by a comma (,).
	<p>Note:</p> <p>It has a link. On clicking the link, the Price Item screen appears where you can view the details of the respective price item.</p> <p>The information in this column appears only when the disaggregation request is created for a price item</p>
Pricing Information	Displays the pricing details using which the disaggregation request is processed.
	<p>Note: It has a link. On clicking the link, the Pricing screen appears where you can view the details of the respective pricing.</p>
Billable Charge ID	Displays the charge id billable for the processed disaggregation request.
	<p>Note: It has a link. On clicking the link, the Billable Charge ID screen appears where you can view the details of the respective billable charge.</p>
Delete	On clicking the Delete (🗑️) icon, you can delete the disaggregation request.
	<p>Note: You can delete a disaggregation request only when it is in the Pending status.</p>
Accumulation Information	Displays the accumulation information.
	<p>Note: This column appears only when you select the Accumulation Group option from the Search By list.</p>

Note: Pagination is used to display limited number of records in this zone. You can use the navigation links, such as **Previous** and **Next** to navigate between pages.

Related Topics

For more information on...	See...
How to search for a disaggregation request	Searching for a Disaggregation Request on page 1312
How to delete a disaggregation request	Deleting a Disaggregation Request on page 1342

Searching for a Disaggregation Request

Procedure

To search for a disaggregation request:

1. Click the **Menu** link in the **Application** toolbar.
A list appears.
2. From the **Main** menu, select **Transaction and Audit Event Management** and then click **Disaggregation Request**.
The **Disaggregation Request** screen appears.
3. Enter the search criteria in the **Search Disaggregation Request** zone.

Note: ORMB search engine supports wildcard search, where you can substitute the percentage (%) symbol as a stand in for any word or letter in a search criteria. You can use the ‘%’ wildcard character in all input fields except the date and ID fields. The ‘%’ wildcard character is suffixed automatically at the end of the partial search criteria. Therefore, you may or may not specify the wildcard character at the end of the partial search criteria. However, you have to prefix the wildcard character manually wherever required.

4. Click **Search**.

A list of disaggregation requests that meet the search criteria appears in the **Search Results** section.

Related Topics

For more information on...	See...
Disaggregation Request screen	Disaggregation Request on page 1307
Search Disaggregation Request zone	Search Disaggregation Request on page 1307

Creating a Disaggregation Request for a Person

Prerequisites

To create a disaggregation request for a person, you should have:

- Person (for whom you want to create the disaggregation request) defined in the application
- Person associated with the division to which the user belongs
- Price list assigned to the person (in case you want to search a person based on an assigned price list)

Procedure

To create a disaggregation request for a person:

1. Click the **Menu** link in the **Application** toolbar.

A list appears.

2. From the **Main** menu, select **Transaction and Audit Event Management** and then click **Disaggregation Request**.

The **Disaggregation Request** screen appears.

3. Click the **Add** button available in the upper right corner of the **Disaggregation Request** screen.

The **Add Disaggregation Request** screen appears. It contains the following field:

Field Name	Field Description	Mandatory (Yes or No)
Disaggregation Request Type	<p>Used to indicate the entity for which you want to create a disaggregation request. The valid values are:</p> <ul style="list-style-type: none"> • Account - Used to create a disaggregation request for an account. <div data-bbox="686 405 1125 516" style="border: 1px solid black; padding: 2px;"> <p>Note: In this case, the system will disaggregate all billable charges of the account.</p> </div> <ul style="list-style-type: none"> • Billable Charge - Used to create a disaggregation request for an account for which a particular billable charge is created. <div data-bbox="686 680 1125 791" style="border: 1px solid black; padding: 2px;"> <p>Note: In this case, the system will disaggregate a specific billable charge of the account.</p> </div> <ul style="list-style-type: none"> • Parent Accumulation Group - Used to create reseeding requests for the accounts using a parent accumulation group and by specifying the accumulation type (i.e. whether it is stop-loss or discount arrangement). <div data-bbox="686 1022 1125 1163" style="border: 1px solid black; padding: 2px;"> <p>Note: The Parent Accumulation Group option is used to create reseeding requests for accounts which belong to the healthcare domain.</p> </div> <ul style="list-style-type: none"> • Person - Used to create a disaggregation request for one or more accounts of a person and its child persons. <div data-bbox="686 1295 1125 1407" style="border: 1px solid black; padding: 2px;"> <p>Note: In this case, the system will disaggregate all billable charges of the account.</p> </div> <ul style="list-style-type: none"> • Price Assignment - Used to create a disaggregation request for an account with a particular price assignment. <div data-bbox="686 1539 1125 1680" style="border: 1px solid black; padding: 2px;"> <p>Note: In this case, the system will disaggregate only those billable charges of the account which are created using the respective price assignment.</p> </div> <ul style="list-style-type: none"> • Price Item - Used to create a disaggregation request for an account or for one or more accounts of a person and its child persons where a particular price item is assigned. <div data-bbox="686 1883 1125 1995" style="border: 1px solid black; padding: 2px;"> <p>Note: In this case, the system will disaggregate only those billable charges of the accounts which are created for the respective price item.</p> </div>	Yes

4. Select the **Person** option from the **Disaggregation Request Type** list.
5. Click **OK**.

The **Add Disaggregation Request For Person** screen appears. It contains the following two sections:

- **Search Criteria** - Used to search for a person and its child persons for whose accounts you want to create a disaggregation request. It contains the following fields:

Filed Name	Field Description	Mandatory (Yes or No)
Request Type	Indicates the entity for which you want to create the disaggregation request. The valid value is: <ul style="list-style-type: none"> • Person 	Not applicable
Division	Used to search persons which belong to a particular division. Note: You can view only those divisions to which you have access in the Division list.	Yes
Person ID	Used to search for a particular person. Note: The Search (🔍) icon appears corresponding to the Person ID field. On clicking the Search icon, the Person Search window appears where you can search for the person.	No
Person Name	Used to search persons having a particular name.	No
Person Identifier Type	Used to indicate the person identifier type based on which you want to search for a person.	Yes (Conditional) Note: If you specify the person identifier as a search criteria, you have to select the person identifier type.
Person Identifier	Used to specify the value of the person identifier type using which you want to search for a person.	Yes (Conditional) Note: If you select the person identifier type as a search criteria, you have to specify the person identifier.
Price List Assignment Start Date	Used to search for a person based on an assigned price list which is effective from a particular date onwards.	Yes (Conditional) Note: If you specify the price list assignment end date or the assigned price list as a search criteria, you have to specify the price list assignment start date.

Filed Name	Field Description	Mandatory (Yes or No)
Price List Assignment End Date	Used to search for a person based on an assigned price list which is effective till a particular date.	Yes (Conditional) Note: If you specify the price list assignment start date or the assigned price list as a search criteria, you have to specify the price list assignment end date.
Assigned Price List	Used when you want to search for a person to which a particular price list is assigned. Note: The Search (🔍) icon appears corresponding to the Assigned Price List field. On clicking the Search icon, the Price List Search window appears where you can search for the price list.	Yes (Conditional) Note: If you specify the price list assignment start date or the price list assignment end date as a search criteria, you have to specify the assigned price list.
Price Assignment ID	Used to search for a person to whom a particular price item pricing is assigned.	No
Price Item	Used to search for persons to whom a particular price item is assigned. Note: The Search (🔍) icon appears corresponding to the Price Item field. On clicking the Search icon, the Price Item Search window appears where you can search for the price item. On specifying the price item, the details of the price item appears corresponding to the Price Item field.	No
Billable Charge ID	Used to search for a person for whose accounts a particular billable charge is created. Note: The Search (🔍) icon appears corresponding to the Billable Charge ID field. On clicking the Search icon, the Billable Charge Search window appears where you can search for the billable charge. On specifying the billable charge, the details of the billable charge appears corresponding to the Billable Charge ID field.	No

- **Search Results** - On clicking the **Search** button, the search results appear based on the specified search criteria. The **Search Results** section contains the following columns:

Column Name	Column Description
Account Identifier Type	Indicates the account identifier type using which the account is defined in the system.
	Note: The data appears in this column when you search for an account.
Account Identifier	Displays the value of the account identifier type.
	Note: The data appears in this column when you search for an account.
Division	Displays the division to which the person belongs.
Person Identifier Type	Indicates the person identifier type using which the person is defined in the system.
Person Identifier	Displays the value of the person identifier type.
Person Name	Displays the name of the person.
Assigned Price List	Displays the price list assigned to the person.
	Note: The data appears in this column when you search for a person based on an assigned price list.
Price List Assignment Start Date	Displays the date from when the price list is assigned to the person.
	Note: The data appears in this column when you search for a person based on an assigned price list.
Price List Assignment End Date	Displays the date till when the price list is assigned to the person.
	Note: The data appears in this column when you search for a person based on an assigned price list.
Account Information	Displays the concatenated string of information about the account separated by a comma (,).
	Note: The data appears in this column when you search for an account.
Bill Cycle	Indicates the bill cycle defined for the account.
	Note: The data appears in this column when you search for an account.

Note:

Pagination is used to display limited number of records in the **Search Results** section. By default, 20 records are displayed in the **Search Results** section. You can change the number of records displayed per page from the **Page Limit** list, if required.

The **Page Limit** list includes only those values which are defined in the **PAGE_NUMBER** lookup field.

You can use the navigation buttons, such as **First** (<<), **Previous** (<), **Next** (>), and **Last** (>>) to navigate between pages. You can also select the page to which you want to navigate from the **Go To** list.

ORMB search engine supports wildcard search, where you can substitute the percentage (%) symbol as a stand in for any word or letter in a search criteria. You can use the '%' wildcard character in all input fields except the date and ID fields. The '%' wildcard character is suffixed automatically at the end of the partial search criteria. Therefore, you may or may not specify the wildcard character at the end of the partial search criteria. However, you have to prefix the wildcard character manually wherever required.

6. Do either of the following:

If you want to...	Then...
Create disaggregation request for one or more persons	<ol style="list-style-type: none"> 1. In the Search Results section, select the check box corresponding to the person for which you want to create a disaggregation request. 2. Click Disaggregate. A message appears confirming that the disaggregation request is created successfully. 3. Click OK. The disaggregation request is created for each account of the person (where the person is the main customer) and its child persons.
Create disaggregation request for all persons that meet the search criteria	<ol style="list-style-type: none"> 1. Click Disaggregate All. The Disaggregate All Confirmation window appears confirming whether you want to create disaggregation requests for all records. 2. Click OK. The disaggregation request is created for each account of the person (where the person is the main customer) and its child persons.

Related Topics

For more information on...	See...
Disaggregation Request screen	Disaggregation Request on page 1307
Search Disaggregation Request zone	Search Disaggregation Request on page 1307

Creating a Disaggregation Request for an Account

Prerequisites

To create a disaggregation request for an account, you should have:

- Account (for whom you want to create the disaggregation request) defined in the application
- Account associated with the division to which the user belongs
- Price list assigned to the account (in case you want to search an account based on an assigned price list)

Procedure

To create a disaggregation request for an account:

1. Click the **Menu** link in the **Application** toolbar.

A list appears.

2. From the **Main** menu, select **Transaction and Audit Event Management** and then click **Disaggregation Request**.

The **Disaggregation Request** screen appears.

3. Click the **Add** button available in the upper right corner of the **Disaggregation Request** screen.

The **Add Disaggregation Request** screen appears. It contains the following field:

Field Name	Field Description	Mandatory (Yes or No)
Disaggregation Request Type	<p>Used to indicate the entity for which you want to create a disaggregation request. The valid values are:</p> <ul style="list-style-type: none"> • Account - Used to create a disaggregation request for an account. <div data-bbox="686 405 1125 516" style="border: 1px solid black; padding: 2px;"> <p>Note: In this case, the system will disaggregate all billable charges of the account.</p> </div> <ul style="list-style-type: none"> • Billable Charge - Used to create a disaggregation request for an account for which a particular billable charge is created. <div data-bbox="686 680 1125 791" style="border: 1px solid black; padding: 2px;"> <p>Note: In this case, the system will disaggregate a specific billable charge of the account.</p> </div> <ul style="list-style-type: none"> • Parent Accumulation Group - Used to create reseeding requests for the accounts using a parent accumulation group and by specifying the accumulation type (i.e. whether it is stop-loss or discount arrangement). <div data-bbox="686 1022 1125 1163" style="border: 1px solid black; padding: 2px;"> <p>Note: The Parent Accumulation Group option is used to create reseeding requests for accounts which belong to the healthcare domain.</p> </div> <ul style="list-style-type: none"> • Person - Used to create a disaggregation request for one or more accounts of a person and its child persons. <div data-bbox="686 1295 1125 1407" style="border: 1px solid black; padding: 2px;"> <p>Note: In this case, the system will disaggregate all billable charges of the account.</p> </div> <ul style="list-style-type: none"> • Price Assignment - Used to create a disaggregation request for an account with a particular price assignment. <div data-bbox="686 1539 1125 1680" style="border: 1px solid black; padding: 2px;"> <p>Note: In this case, the system will disaggregate only those billable charges of the account which are created using the respective price assignment.</p> </div> <ul style="list-style-type: none"> • Price Item - Used to create a disaggregation request for an account or for one or more accounts of a person and its child persons where a particular price item is assigned. <div data-bbox="686 1883 1125 1995" style="border: 1px solid black; padding: 2px;"> <p>Note: In this case, the system will disaggregate only those billable charges of the accounts which are created for the respective price item.</p> </div>	Yes

4. Select the **Account** option from the **Disaggregation Request Type** list.
5. Click **OK**.

The **Add Disaggregation Request For Account** screen appears. It contains the following two sections:

- **Search Criteria** - Used to search for an account for whose billable charges you want to create a disaggregation request. It contains the following fields:

Filed Name	Field Description	Mandatory (Yes or No)
Request Type	Indicates the entity for which you want to create the disaggregation request. The valid value is: <ul style="list-style-type: none"> • Account 	Not applicable
Division	Used to search accounts which belong to a particular division. Note: You can view only those divisions to which you have access in the Division list.	Yes
Account ID	Used to search for a particular account. Note: The Search (🔍) icon appears corresponding to the Account ID field. On clicking the Search icon, the Account Search window appears where you can search for the account.	No
Bill Cycle	Used to search accounts having a particular bill cycle.	No
Account Identifier Type	Used to indicate the account identifier type based on which you want to search for an account. Note: If you specify the account identifier as a search criteria, you have to select the account identifier type.	Yes (Conditional)
Account Identifier	Used to specify the value of the account identifier type using which you want to search for an account. Note: If you select the account identifier type as a search criteria, you have to specify the account identifier.	Yes (Conditional)
Invoice Currency	Used to search accounts whose billable charges are defined using a particular invoice currency.	No

Filed Name	Field Description	Mandatory (Yes or No)
Assigned Price List	Used when you want to search for an account to which a particular price list is assigned.	Yes (Conditional)
	Note: The Search (🔍) icon appears corresponding to the Assigned Price List field. On clicking the Search icon, the Price List Search window appears where you can search for the price list.	Note: If you specify the price list assignment start date or the price list assignment end date as a search criteria, you have to specify the assigned price list.
Price List Assignment Start Date	Used to search for an account based on an assigned price list which is effective from a particular date onwards.	Yes (Conditional)
		Note: If you specify the price list assignment end date or the assigned price list as a search criteria, you have to specify the price list assignment start date.
Price List Assignment End Date	Used to search for an account based on an assigned price list which is effective till a particular date.	Yes (Conditional)
		Note: If you specify the price list assignment start date or the assigned price list as a search criteria, you have to specify the price list assignment end date.
Price Assignment ID	Used to search for an account to which a particular price item pricing is assigned.	No
Price Item	Used to search for accounts to which a particular price item is assigned.	No
	Note: The Search (🔍) icon appears corresponding to the Price Item field. On clicking the Search icon, the Price Item Search window appears where you can search for the price item. On specifying the price item, the details of the price item appears corresponding to the Price Item field.	

Filed Name	Field Description	Mandatory (Yes or No)
Billable Charge ID	Used to search for an account for which a particular billable charge is created. Note: The Search (🔍) icon appears corresponding to the Billable Charge ID field. On clicking the Search icon, the Billable Charge Search window appears where you can search for the billable charge. On specifying the billable charge, the details of the billable charge appears corresponding to the Billable Charge ID field.	No

- **Search Results** - On clicking the **Search** button, the search results appear based on the specified search criteria. The **Search Results** section contains the following columns:

Column Name	Column Description
Account Identifier Type	Indicates the account identifier type using which the account is defined in the system.
Account Identifier	Displays the value of the account identifier type.
Division	Displays the division to which the account belongs.
Person Identifier Type	Indicates the person identifier type using which the person is defined in the system. Note: The data appears in this column when you search for a person.
Person Identifier	Displays the value of the person identifier type. Note: The data appears in this column when you search for a person.
Person Name	Displays the name of the person to whom the account belongs.
Assigned Price List	Displays the price list assigned to the account. Note: The data appears in this column when you search for an account based on an assigned price list.
Price List Assignment Start Date	Displays the date from when the price list is assigned to the account. Note: The data appears in this column when you search for an account based on an assigned price list.
Price List Assignment End Date	Displays the date till when the price list is assigned to the account. Note: The data appears in this column when you search for an account based on an assigned price list.
Account Information	Displays the concatenated string of information about the account separated by a comma (,).

Column Name	Column Description
Bill Cycle	Indicates the bill cycle defined for the account.

Note:

Pagination is used to display limited number of records in the **Search Results** section. By default, 20 records are displayed in the **Search Results** section. You can change the number of records displayed per page from the **Page Limit** list, if required.

The **Page Limit** list includes only those values which are defined in the **PAGE_NUMBER** lookup field.

You can use the navigation buttons, such as **First** (<<), **Previous** (<), **Next** (>), and **Last** (>>) to navigate between pages. You can also select the page to which you want to navigate from the **Go To** list.

ORMB search engine supports wildcard search, where you can substitute the percentage (%) symbol as a stand in for any word or letter in a search criteria. You can use the '%' wildcard character in all input fields except the date and ID fields. The '%' wildcard character is suffixed automatically at the end of the partial search criteria. Therefore, you may or may not specify the wildcard character at the end of the partial search criteria. However, you have to prefix the wildcard character manually wherever required.

6. Do either of the following:

If you want to...	Then...
Create disaggregation request for one or more accounts	<ol style="list-style-type: none"> In the Search Results section, select the check box corresponding to the account for which you want to create a disaggregation request. Click Disaggregate. A message appears confirming that the disaggregation request is created successfully. Click OK. The disaggregation request is created for the selected account.
Create disaggregation request for all accounts that meet the search criteria	<ol style="list-style-type: none"> Click Disaggregate All. The Disaggregate All Confirmation window appears confirming whether you want to create disaggregation requests for all records. Click OK. The disaggregation request is created for all the accounts.

Related Topics

For more information on...	See...
Disaggregation Request screen	Disaggregation Request on page 1307
Search Disaggregation Request zone	Search Disaggregation Request on page 1307

Creating a Disaggregation Request for a Price item

Prerequisites

To create a disaggregation request for a price item, you should have:

- Price item (for which you want to create the disaggregation request) defined in the application
- Price item associated with the division to which the user belongs
- Person or accounts defined in the application (in case you want to search for a price item associated to a person or an account)
- Price item associated with the price list (in case you want to search a price item based on an assigned price list)

Procedure

To create a disaggregation request for a price item:

1. Click the **Menu** link in the **Application** toolbar.
A list appears.
2. From the **Main** menu, select **Transaction and Audit Event Management** and then click **Disaggregation Request**.
The **Disaggregation Request** screen appears.
3. Click the **Add** button available in the upper right corner of the **Disaggregation Request** screen.
The **Add Disaggregation Request** screen appears. It contains the following field:

Field Name	Field Description	Mandatory (Yes or No)
Disaggregation Request Type	<p>Used to indicate the entity for which you want to create a disaggregation request. The valid values are:</p> <ul style="list-style-type: none"> • Account - Used to create a disaggregation request for an account. <div data-bbox="686 405 1125 516" style="border: 1px solid black; padding: 2px;"> <p>Note: In this case, the system will disaggregate all billable charges of the account.</p> </div> <ul style="list-style-type: none"> • Billable Charge - Used to create a disaggregation request for an account for which a particular billable charge is created. <div data-bbox="686 680 1125 791" style="border: 1px solid black; padding: 2px;"> <p>Note: In this case, the system will disaggregate a specific billable charge of the account.</p> </div> <ul style="list-style-type: none"> • Parent Accumulation Group - Used to create reseeding requests for the accounts using a parent accumulation group and by specifying the accumulation type (i.e. whether it is stop-loss or discount arrangement). <div data-bbox="686 1022 1125 1163" style="border: 1px solid black; padding: 2px;"> <p>Note: The Parent Accumulation Group option is used to create reseeding requests for accounts which belong to the healthcare domain.</p> </div> <ul style="list-style-type: none"> • Person - Used to create a disaggregation request for one or more accounts of a person and its child persons. <div data-bbox="686 1295 1125 1407" style="border: 1px solid black; padding: 2px;"> <p>Note: In this case, the system will disaggregate all billable charges of the account.</p> </div> <ul style="list-style-type: none"> • Price Assignment - Used to create a disaggregation request for an account with a particular price assignment. <div data-bbox="686 1539 1125 1680" style="border: 1px solid black; padding: 2px;"> <p>Note: In this case, the system will disaggregate only those billable charges of the account which are created using the respective price assignment.</p> </div> <ul style="list-style-type: none"> • Price Item - Used to create a disaggregation request for an account or for one or more accounts of a person and its child persons where a particular price item is assigned. <div data-bbox="686 1881 1125 2013" style="border: 1px solid black; padding: 2px;"> <p>Note: In this case, the system will disaggregate only those billable charges of the accounts which are created for the respective price item.</p> </div>	Yes

4. Select the **Price Item** option from the **Disaggregation Request Type** list.
5. Click **OK**.

The **Add Disaggregation Request For Price Item** screen appears. It contains the following two sections:

- **Search Criteria** - Used to search for a price item assigned to an account for whose billable charges want to create a disaggregation request. It contains the following fields:

Filed Name	Field Description	Mandatory (Yes or No)
Request Type	Indicates the entity for which you want to create the disaggregation request. The valid value is: <ul style="list-style-type: none"> • Price Item 	Not applicable
Division	Used to search price items which belong to a particular division. Note: You can view only those divisions to which you have access in the Division list.	Yes
Account ID	Used to search price items which are assigned to a particular account. Note: The Search (🔍) icon appears corresponding to the Account ID field. On clicking the Search icon, the Account Search window appears where you can search for the account.	Yes (Conditional) Note: This field is required when you specify the price item in the Price Item field as a search criteria.
Person ID	Used to search price items which are assigned to a particular person. Note: The Search (🔍) icon appears corresponding to the Person ID field. On clicking the Search icon, the Person Search window appears where you can search for the person.	Yes (Conditional) Note: This field is required when you specify the price item in the Price Item field as a search criteria.
Account Identifier Type	Used to search price items assigned to accounts which are created using a particular identifier type.	Yes (Conditional) Note: If you specify the account identifier as a search criteria, you have to select the account identifier type.
Account Identifier	Used to specify the value of the account identifier type.	Yes (Conditional) Note: If you select the account identifier type as a search criteria, you have to specify the account identifier.

Filed Name	Field Description	Mandatory (Yes or No)
Person Identifier Type	Used to search price items assigned to persons which are created using a particular identifier type.	Yes (Conditional) Note: If you specify the person identifier as a search criteria, you have to select the person identifier type.
Person Identifier	Used to specify the value of the person identifier type.	Yes (Conditional) Note: If you select the person identifier type as a search criteria, you have to specify the person identifier.
Bill Cycle	Used to search price items assigned to accounts or accounts of a person having a particular bill cycle.	No
Invoice Currency	Used to search price items assigned to accounts or accounts of a person whose billable charges are defined using a particular invoice currency.	No
Price Item	Used to search for a particular price item. Note: The Search (🔍) icon appears corresponding to the Price Item field. On clicking the Search icon, the Price Item Search window appears where you can search for the price item. On specifying the price item, the details of the price item appears corresponding to the Price Item field.	Yes
Assigned Price List	Used to search price items which belong to a price list assigned to accounts or accounts of a person. Note: The Search (🔍) icon appears corresponding to the Assigned Price List field. On clicking the Search icon, the Price List Search window appears where you can search for the price list.	Yes (Conditional) Note: If you specify the price list assignment start date or the price list assignment end date as a search criteria, you have to specify the assigned price list.

Filed Name	Field Description	Mandatory (Yes or No)
Price List Assignment Start Date	Used to search for price items based on an assigned price list which is effective from a particular date onwards.	Yes (Conditional) Note: If you specify the price list assignment end date or the assigned price list as a search criteria, you have to specify the price list assignment start date.
Price List Assignment End Date	Used to search for price items based on an assigned price list which is effective till a particular date.	Yes (Conditional) Note: If you specify the price list assignment start date or the assigned price list as a search criteria, you have to specify the price list assignment end date.

- **Search Results** - On clicking the **Search** button, the search results appear based on the specified search criteria. The **Search Results** section contains the following columns:

Column Name	Column Description
Account Identifier Type	Indicates the account identifier type using which the account is defined in the system. Note: The data appears in this column when you search for a price item which is assigned to an account.
Account Identifier	Displays the value of the account identifier type. Note: The data appears in this column when you search for a price item which is assigned to an account.
Division	Displays the division to which the price item belongs.
Person Identifier Type	Indicates the person identifier type using which the person is defined in the system. Note: The data appears in this column when you search for a price item which is assigned to a person.
Person Identifier	Displays the value of the person identifier type. Note: The data appears in this column when you search for a price item which is assigned to a person.
Person Name	Displays the name of the person.
Assigned Price List	Displays the assigned price list of the account or the account of a person to which the price item is associated. Note: The data appears in this column when you search for a price item based on an assigned price list.

Column Name	Column Description
Price List Assignment Start Date	Displays the date from when the price list is assigned to the account or the account of a person. Note: The data appears in this column when you search for a price item based on an assigned price list.
Price List Assignment End Date	Displays the date till when the price list is assigned to the account or the account of a person. Note: The data appears in this column when you search for a price item based on an assigned price list.
Account Information	Displays the concatenated string of information about the account separated by a comma (,).
Bill Cycle	Indicates the bill cycle defined for the account or accounts of the person to which the price item is assigned.

Note:

Pagination is used to display limited number of records in the **Search Results** section. By default, 20 records are displayed in the **Search Results** section. You can change the number of records displayed per page from the **Page Limit** list, if required.

The **Page Limit** list includes only those values which are defined in the **PAGE_NUMBER** lookup field.

You can use the navigation buttons, such as **First** (<<), **Previous** (<), **Next** (>), and **Last** (>>) to navigate between pages. You can also select the page to which you want to navigate from the **Go To** list.

ORMB search engine supports wildcard search, where you can substitute the percentage (%) symbol as a stand in for any word or letter in a search criteria. You can use the '%' wildcard character in all input fields except the date and ID fields. The '%' wildcard character is suffixed automatically at the end of the partial search criteria. Therefore, you may or may not specify the wildcard character at the end of the partial search criteria. However, you have to prefix the wildcard character manually wherever required.

6. Do either of the following:

If you want to...	Then...
Create disaggregation request for one or more price items	<ol style="list-style-type: none"> In the Search Results section, select the check box corresponding to the person or account for which you want to create a disaggregation request. Click Disaggregate. A message appears confirming that the disaggregation request is created successfully. Click OK. The disaggregation request is created for the selected price item.
Create disaggregation request for all price items that meet the search criteria	<ol style="list-style-type: none"> Click Disaggregate All.

If you want to...	Then...
	<p>The Disaggregate All Confirmation window appears confirming whether you want to create disaggregation requests for all records.</p> <p>2. Click OK.</p> <p>The disaggregation request is created for all the price items.</p>

Related Topics

For more information on...	See...
Disaggregation Request screen	Disaggregation Request on page 1307
Search Disaggregation Request zone	Search Disaggregation Request on page 1307

Creating a Disaggregation Request for a Price Assignment

Prerequisites

To create a disaggregation request for a price assignment, you should have:

- Price item pricing (whose disaggregation request you want to create) assigned to the account or the accounts of a person or child person

Procedure

To create a disaggregation request for a price assignment:

1. Click the **Menu** link in the **Application** toolbar.
A list appears.
2. From the **Main** menu, select **Transaction and Audit Event Management** and then click **Disaggregation Request**.
The **Disaggregation Request** screen appears.
3. Click the **Add** button available in the upper right corner of the **Disaggregation Request** screen.
The **Add Disaggregation Request** screen appears. It contains the following field:

Field Name	Field Description	Mandatory (Yes or No)
Disaggregation Request Type	<p>Used to indicate the entity for which you want to create a disaggregation request. The valid values are:</p> <ul style="list-style-type: none"> • Account - Used to create a disaggregation request for an account. <div data-bbox="686 405 1125 516" style="border: 1px solid black; padding: 2px;"> <p>Note: In this case, the system will disaggregate all billable charges of the account.</p> </div> <ul style="list-style-type: none"> • Billable Charge - Used to create a disaggregation request for an account for which a particular billable charge is created. <div data-bbox="686 680 1125 791" style="border: 1px solid black; padding: 2px;"> <p>Note: In this case, the system will disaggregate a specific billable charge of the account.</p> </div> <ul style="list-style-type: none"> • Parent Accumulation Group - Used to create reseeding requests for the accounts using a parent accumulation group and by specifying the accumulation type (i.e. whether it is stop-loss or discount arrangement). <div data-bbox="686 1022 1125 1163" style="border: 1px solid black; padding: 2px;"> <p>Note: The Parent Accumulation Group option is used to create reseeding requests for accounts which belong to the healthcare domain.</p> </div> <ul style="list-style-type: none"> • Person - Used to create a disaggregation request for one or more accounts of a person and its child persons. <div data-bbox="686 1295 1125 1407" style="border: 1px solid black; padding: 2px;"> <p>Note: In this case, the system will disaggregate all billable charges of the account.</p> </div> <ul style="list-style-type: none"> • Price Assignment - Used to create a disaggregation request for an account with a particular price assignment. <div data-bbox="686 1539 1125 1680" style="border: 1px solid black; padding: 2px;"> <p>Note: In this case, the system will disaggregate only those billable charges of the account which are created using the respective price assignment.</p> </div> <ul style="list-style-type: none"> • Price Item - Used to create a disaggregation request for an account or for one or more accounts of a person and its child persons where a particular price item is assigned. <div data-bbox="686 1881 1125 2013" style="border: 1px solid black; padding: 2px;"> <p>Note: In this case, the system will disaggregate only those billable charges of the accounts which are created for the respective price item.</p> </div>	Yes

4. Select the **Price Assignment** option from the **Disaggregation Request Type** list.
5. Click **OK**.

The **Add Disaggregation Request For Price Assignment** screen appears. It contains the following two sections:

- **Search Criteria** - Used to search for an account with a particular price assignment for which you want to create a disaggregation request. It contains the following fields:

Filed Name	Field Description	Mandatory (Yes or No)
Request Type	Indicates the entity for which you want to create the disaggregation request. The valid value is: <ul style="list-style-type: none"> • Price Assignment 	Not applicable
Price Assignment ID	Used to search for an account to which a particular price item pricing is assigned.	Yes

- **Search Results** - On clicking the **Search** button, the search results appear based on the specified search criteria. The **Search Results** section contains the following columns:

Column Name	Column Description
Account Identifier Type	Indicates the account identifier type using which the account is defined in the system. Note: The data appears in this column when the price assignment belongs to an account.
Account Identifier	Displays the value of the account identifier type. Note: The data appears in this column when the price assignment belongs to an account.
Division	Displays the division to which the account belongs.
Person Identifier Type	Indicates the person identifier type using which the person is defined in the system. Note: The data appears in this column when the price assignment belongs to a persons account.
Person Identifier	Displays the value of the person identifier type. Note: The data appears in this column when the price assignment belongs to a persons account.
Person Name	Displays the name of the person to whom the account belongs.
Assigned Price List	Displays the price list assigned to the account. Note: The data appears in this column when the price item pricing is assigned through a price list.

Column Name	Column Description
Price List Assignment Start Date	Displays the date from when the price list is assigned to the account. Note: The data appears in this column when the price item pricing is assigned through a price list.
Price List Assignment End Date	Displays the date till when the price list is assigned to the account. Note: The data appears in this column when the price item pricing is assigned through a price list.
Account Information	Displays the concatenated string of information about the account separated by a comma (,).
Bill Cycle	Indicates the bill cycle defined for the account.

Note:

Pagination is used to display limited number of records in the **Search Results** section. By default, 20 records are displayed in the **Search Results** section. You can change the number of records displayed per page from the **Page Limit** list, if required.

The **Page Limit** list includes only those values which are defined in the **PAGE_NUMBER** lookup field.

You can use the navigation buttons, such as **First** (<<), **Previous** (<), **Next** (>), and **Last** (>>) to navigate between pages. You can also select the page to which you want to navigate from the **Go To** list.

ORMB search engine supports wildcard search, where you can substitute the percentage (%) symbol as a stand in for any word or letter in a search criteria. You can use the '%' wildcard character in all input fields except the date and ID fields. The '%' wildcard character is suffixed automatically at the end of the partial search criteria. Therefore, you may or may not specify the wildcard character at the end of the partial search criteria. However, you have to prefix the wildcard character manually wherever required.

6. Do either of the following:

If you want to...	Then...
Create disaggregation request for price assignment of one or more accounts	<ol style="list-style-type: none"> 1. In the Search Results section, select the check box corresponding to the account for which you want to create a disaggregation request. 2. Click Disaggregate. A message appears confirming that the disaggregation request is created successfully. 3. Click OK. The disaggregation request is created for the price assignment of the selected account.
Create disaggregation request for all accounts that meet the search criteria	<ol style="list-style-type: none"> 1. Click Disaggregate All. The Disaggregate All Confirmation window appears confirming whether you want to create disaggregation requests for all records. 2. Click OK.

If you want to...	Then...
	The disaggregation request is created for all the price assignments of all accounts.

Related Topics

For more information on...	See...
Disaggregation Request screen	Disaggregation Request on page 1307
Search Disaggregation Request zone	Search Disaggregation Request on page 1307

Creating a Disaggregation Request for a Billable Charge

Prerequisites

To create a disaggregation request for a billable charge, you should have:

- Billable charge (for which you want to create a disaggregation request) created for the account or accounts of the person or child persons

Procedure

To create a disaggregation request for a billable charge:

1. Click the **Menu** link in the **Application** toolbar.
A list appears.
2. From the **Main** menu, select **Transaction and Audit Event Management** and then click **Disaggregation Request**.
The **Disaggregation Request** screen appears.
3. Click the **Add** button available in the upper right corner of the **Disaggregation Request** screen.
The **Add Disaggregation Request** screen appears. It contains the following field:

Field Name	Field Description	Mandatory (Yes or No)
Disaggregation Request Type	<p>Used to indicate the entity for which you want to create a disaggregation request. The valid values are:</p> <ul style="list-style-type: none"> • Account - Used to create a disaggregation request for an account. <div data-bbox="686 405 1125 516" style="border: 1px solid black; padding: 2px;"> <p>Note: In this case, the system will disaggregate all billable charges of the account.</p> </div> <ul style="list-style-type: none"> • Billable Charge - Used to create a disaggregation request for an account for which a particular billable charge is created. <div data-bbox="686 682 1125 793" style="border: 1px solid black; padding: 2px;"> <p>Note: In this case, the system will disaggregate a specific billable charge of the account.</p> </div> <ul style="list-style-type: none"> • Parent Accumulation Group - Used to create reseeding requests for the accounts using a parent accumulation group and by specifying the accumulation type (i.e. whether it is stop-loss or discount arrangement). <div data-bbox="686 1024 1125 1163" style="border: 1px solid black; padding: 2px;"> <p>Note: The Parent Accumulation Group option is used to create reseeding requests for accounts which belong to the healthcare domain.</p> </div> <ul style="list-style-type: none"> • Person - Used to create a disaggregation request for one or more accounts of a person and its child persons. <div data-bbox="686 1297 1125 1409" style="border: 1px solid black; padding: 2px;"> <p>Note: In this case, the system will disaggregate all billable charges of the account.</p> </div> <ul style="list-style-type: none"> • Price Assignment - Used to create a disaggregation request for an account with a particular price assignment. <div data-bbox="686 1543 1125 1682" style="border: 1px solid black; padding: 2px;"> <p>Note: In this case, the system will disaggregate only those billable charges of the account which are created using the respective price assignment.</p> </div> <ul style="list-style-type: none"> • Price Item - Used to create a disaggregation request for an account or for one or more accounts of a person and its child persons where a particular price item is assigned. <div data-bbox="686 1885 1125 2011" style="border: 1px solid black; padding: 2px;"> <p>Note: In this case, the system will disaggregate only those billable charges of the accounts which are created for the respective price item.</p> </div>	Yes

4. Select the **Billable Charge** option from the **Disaggregation Request Type** list.
5. Click **OK**.

The **Add Disaggregation Request For Billable Charge** screen appears. It contains the following two sections:

- **Search Criteria** - Used to search for a billable charge of an account for which you want to create a disaggregation request. It contains the following fields:

Filed Name	Field Description	Mandatory (Yes or No)
Request Type	Indicates the entity for which you want to create the disaggregation request. The valid value is: <ul style="list-style-type: none"> • Billable Charge 	Not applicable
Billable Charge ID	Used to search for a particular billable charge of an account.	Yes

- **Search Results** - On clicking the **Search** button, the search results appear based on the specified search criteria. The **Search Results** section contains the following columns:

Column Name	Column Description
Account Identifier Type	Indicates the account identifier type using which the account is defined in the system. Note: The data appears in this column when the billable charge belongs to an account.
Account Identifier	Displays the value of the account identifier type. Note: The data appears in this column when the billable charge belongs to an account.
Division	Displays the division to which the account belongs.
Person Identifier Type	Indicates the person identifier type using which the person is defined in the system. Note: The data appears in this column when the billable charge belongs to an account of a person or child person.
Person Identifier	Displays the value of the person identifier type. Note: The data appears in this column when the billable charge belongs to an account of a person or child person.
Person Name	Displays the name of the person to whom the account belongs.
Assigned Price List	Displays the price list assigned to the account. Note: The data appears in this column when the price item pricing for which the billable charge is created is assigned through a price list.

Column Name	Column Description
Price List Assignment Start Date	Displays the date from when the price list is assigned to the account. Note: The data appears in this column when the price item pricing for which the billable charge is created is assigned through a price list.
Price List Assignment End Date	Displays the date till when the price list is assigned to the account. Note: The data appears in this column when the price item pricing for which the billable charge is created is assigned through a price list.
Account Information	Displays the concatenated string of information about the account separated by a comma (.).
Bill Cycle	Indicates the bill cycle defined for the account.

Note:

Pagination is used to display limited number of records in the **Search Results** section. By default, 20 records are displayed in the **Search Results** section. You can change the number of records displayed per page from the **Page Limit** list, if required.

The **Page Limit** list includes only those values which are defined in the **PAGE_NUMBER** lookup field.

You can use the navigation buttons, such as **First** (<<), **Previous** (<), **Next** (>), and **Last** (>>) to navigate between pages. You can also select the page to which you want to navigate from the **Go To** list.

ORMB search engine supports wildcard search, where you can substitute the percentage (%) symbol as a stand in for any word or letter in a search criteria. You can use the '%' wildcard character in all input fields except the date and ID fields. The '%' wildcard character is suffixed automatically at the end of the partial search criteria. Therefore, you may or may not specify the wildcard character at the end of the partial search criteria. However, you have to prefix the wildcard character manually wherever required.

6. Do either of the following:

If you want to...	Then...
Create disaggregation request for billable charge of one or more accounts	<ol style="list-style-type: none"> In the Search Results section, select the check box corresponding to the account for whose billable charge you want to create a disaggregation request. Click Disaggregate. A message appears confirming that the disaggregation request is created successfully. Click OK. The disaggregation request is created for the billable charge of the selected account.
Create disaggregation request for all billable charges that meet the search criteria	<ol style="list-style-type: none"> Click Disaggregate All. The Disaggregate All Confirmation window appears confirming whether you want to create disaggregation requests for all records. Click OK.

If you want to...	Then...
	The disaggregation request is created for all the billable charges of all accounts.

Related Topics

For more information on...	See...
Disaggregation Request screen	Disaggregation Request on page 1307
Search Disaggregation Request zone	Search Disaggregation Request on page 1307

Creating a Reseeding Request for a Parent Accumulation Group

Procedure

To create a reseeding request for a parent accumulation group:

1. Click the **Menu** link in the **Application** toolbar.
A list appears.
2. From the **Main** menu, select **Transaction and Audit Event Management** and then click **Disaggregation Request**.
The **Disaggregation Request** screen appears.
3. Click the **Add** button available in the upper right corner of the **Disaggregation Request** screen.
The **Add Disaggregation Request** screen appears. It contains the following field:

Field Name	Field Description	Mandatory (Yes or No)
Disaggregation Request Type	<p>Used to indicate the entity for which you want to create a disaggregation request. The valid values are:</p> <ul style="list-style-type: none"> • Account - Used to create a disaggregation request for an account. <div style="border: 1px solid black; padding: 2px; margin: 5px 0;"> <p>Note: In this case, the system will disaggregate all billable charges of the account.</p> </div> <ul style="list-style-type: none"> • Billable Charge - Used to create a disaggregation request for an account for which a particular billable charge is created. <div style="border: 1px solid black; padding: 2px; margin: 5px 0;"> <p>Note: In this case, the system will disaggregate a specific billable charge of the account.</p> </div> <ul style="list-style-type: none"> • Parent Accumulation Group - Used to create reseeding requests for the accounts using a parent accumulation group and by specifying the accumulation type (i.e. whether it is stop-loss or discount arrangement). <div style="border: 1px solid black; padding: 2px; margin: 5px 0;"> <p>Note: The Parent Accumulation Group option is used to create reseeding requests for accounts which belong to the healthcare domain.</p> </div> <ul style="list-style-type: none"> • Person - Used to create a disaggregation request for one or more accounts of a person and its child persons. <div style="border: 1px solid black; padding: 2px; margin: 5px 0;"> <p>Note: In this case, the system will disaggregate all billable charges of the account.</p> </div> <ul style="list-style-type: none"> • Price Assignment - Used to create a disaggregation request for an account with a particular price assignment. <div style="border: 1px solid black; padding: 2px; margin: 5px 0;"> <p>Note: In this case, the system will disaggregate only those billable charges of the account which are created using the respective price assignment.</p> </div> <ul style="list-style-type: none"> • Price Item - Used to create a disaggregation request for an account or for one or more accounts of a person and its child persons where a particular price item is assigned. <div style="border: 1px solid black; padding: 2px; margin: 5px 0;"> <p>Note: In this case, the system will disaggregate only those billable charges of the accounts which are created for the respective price item.</p> </div>	Yes

4. Select the **Parent Accumulation Group** option from the **Disaggregation Request Type** list.
5. Click **OK**.

The **Add Disaggregation Request** screen appears. It contains the following field:

Field Name	Field Description	Mandatory (Yes or No)
Accumulation Type	<p>Used to create reseeding request for a particular type of an accumulation group. The valid values are:</p> <ul style="list-style-type: none"> • Discount Arrangement - Used to create reseeding request for accounts of all bill groups of a parent customer (for whom the parent accumulation group is created) where the claim settlement is based on a discount arrangement. • Stop Loss - Used to create reseeding request for accounts of all bill groups of a parent customer (for whom the parent accumulation group is created) where changes are made to the specific stop-loss (SSL), aggregate stop-loss (ASL), or level funded pricing rule. 	Yes

6. Select the required option from the **Accumulation Type** field.

The following fields appear in the **Add Disaggregation Request** screen:

Field Name	Field Description	Mandatory (Yes or No)
Parent Accumulation Group ID	<p>Used to create reseeding request for accounts of all bill groups of a parent customer which belongs to a particular parent accumulation group.</p> <p>Note:</p> <p>The Search (🔍) icon appears corresponding to the Parent Accumulation Group ID field. On clicking the Search icon, the Parent Accumulation Group ID Search window appears where you can search for the respective parent accumulation group.</p>	Yes

Field Name	Field Description	Mandatory (Yes or No)
Disaggregate All Account	Used to indicate whether you want to create reseeding requests for accounts of all bill groups of a parent customer where the accumulation type is Stop Loss . If you do not select this option, the system creates reseeding requests for accounts of only those bill groups where the parent accumulation group is used for creating the specific stop-loss and aggregate stop-loss pricing rules.	No
	Note: This field appears only when you select the Stop Loss option from the Accumulation Type field.	

- Enter the required details in the **Add Disaggregation Request** screen.
- Click **Save**.

The **Accumulation Based Disaggregation** screen appears with a list of accounts belonging to the parent accumulation group for which the reseeding request is created.

Related Topics

For more information on...	See...
Disaggregation Request screen	Disaggregation Request on page 1307
Search Disaggregation Request zone	Search Disaggregation Request on page 1307

Deleting a Disaggregation Request

Procedure

To delete a disaggregation request:

- Search for the disaggregation request in the **Disaggregation Request** screen.
- In the **Search Results** section, click the **Delete** (🗑️) icon in the **Delete** column corresponding to the disaggregation request that you want to delete.

A message appears confirming whether you want to delete the disaggregation request.

- Click **OK**.

The disaggregation request is deleted.

Note:

You can only delete a disaggregation request which is in the **Pending** status.

If the disaggregation process is already started for a disaggregation request, we recommend you not to delete the disaggregation request from the system. Otherwise, erroneous results might occur.

Related Topics

For more information on...	See...
How to search for a disaggregation request	Searching for a Disaggregation Request on page 1312
Search zone	Search Disaggregation Request on page 1307

Chapter 15

Upload Validated Payment Data

Topics:

- [Payment Upload Process](#)
- [Prerequisites](#)
- [CSV File Format](#)
- [Payment Data File Status Transition](#)
- [Payment Record Status Transition](#)
- [Error Messages](#)
- [Payment Upload](#)

Oracle Revenue Management and Billing until now provided you with an ability to interface payments from an external source, such as remittance processor. The system supported two mechanisms to upload payment data — one using which you can populate payment upload staging records and another using which you can populate payment event upload staging records. The system now enables you to validate the payment records before you move them to the staging area. The system provides the pre-staging area where you can upload and validate the payment records. The system provides a user interface which helps you to upload a payment data file in the pre-staging area. It also helps you to perform various tasks, such as:

- Track the status of the payment records and the payment data file
- Move the payment records to the staging area
- Cancel a payment data file
- View the log of a payment data file

You can upload a payment data file in the CSV format. You need to ensure that the CSV file is in the required format; otherwise the file will not be uploaded in the system. For more information about the CSV file format, see [CSV File Format](#) on page 1349. At present, the system supports only the CSV file format. This is because the payment data mapping algorithm type shipped with the product is designed to support the CSV format. If you want to use any other file format, you need to define custom mapping algorithm type that supports the required file format.

The file type using which you upload a payment data file indicates the mapping and validation algorithms that you want to use for the payment data file. On uploading a payment data file, the mapping algorithm parses the CSV file and uploads the payments records in the pre-staging area. The validation process starts immediately after the file is uploaded in the system. During the validation process, the system and custom validations (if any) are executed. Once the validation process is complete, you can move the payment records from the pre-staging to staging area. Once the payment records are moved to the staging area, the system creates payment events, tenders, payments and payment segments through a batch process. For more information about the payment upload process, see [Payment Upload Process](#) on page 1346.

During the payment upload process, a payment data file and each record of the file goes through various statuses until the payment events and payments are created. For more information about the payment data file and payment record statuses, see [Payment Data File Status Transition](#) on page 1351 and [Payment Record Status Transition](#) on page 1351, respectively.

Payment Upload Process

The payment upload process includes the following sub-processes:

- [Upload Payment Records in the Pre-Staging Area](#) on page 1346
- [Move Payment Records to the Staging Area](#) on page 1347
- [Create Payment Events and Payments](#) on page 1347

Upload Payment Records in the Pre-Staging Area

Oracle Revenue Management and Billing allows you to validate the payment records before you move them to the staging area. You can upload and validate the payment records in the pre-staging area. You can upload a payment data file in the CSV format. You need to ensure that the CSV file is in the required format; otherwise the file will not be uploaded in the system. For more information about the CSV file format, see [CSV File Format](#) on page 1349.

While uploading a payment data file, you need to specify the file type using which you want to upload the payment data file. The file type indicates the mapping and validation algorithms that you want to use for the payment data file. Therefore, while defining a file type using which you want to upload a payment data file, you need to:

- Set the feed type to **Payment Upload Data**
- Attach mapping algorithm which is created using the **C1-CSVUPLPAY** algorithm type
- Attach validation algorithm which is created using the **C1-PUPLVALID** algorithm type

On uploading a payment data file, the mapping algorithm does the following:

1. Validates whether the file is in the CSV format
2. Validates whether at least one payment record is available in the CSV file
3. Parses the flat file in the CSV format and maps the columns in the CSV file to various tables in the database
4. Uploads the payments records in the pre-staging area

The validation process starts immediately after the payment data file is uploaded in the system. During the validation process, the system and custom validations (if any) are executed. The system checks whether:

- The data is available in the **Tender ID, Tender Amount, Payment Amount, Date Received, Bank Account, and Payment Type** columns in the CSV file.
- The data is available in the **Match Type** and **Match Value** columns in the CSV file.

Note: This validation is done when the **Is Match Type Validation Required (Y/N)** parameter is set to **Y** in the validation algorithm.

- The payee and payor accounts specified in the payment record exists in the system.
- The payee account with the specified account identifier type and account identifier combination exists in the system.
- A valid currency code is specified in the payment record.

Note: If the currency code is not specified, the currency is set to the payor account's invoice currency.

- The payment type (i.e. tender type) specified in the payment record exists in the system.
- The account identifier type specified in the payment record exists in the system.

Note: This validation is done when the payee account ID is not specified in the payment record.

- The match type specified in the payment record exists in the system.

Note: This validation is done when the **Is Match Type Validation Required (Y/N)** parameter is set to **Y** in the validation algorithm.

- The characteristic type specified in the payment record exists in the system.
- The characteristic value matches any predefined value when the characteristic value type is set to **Predefined Value**.
- The characteristic value is specified in the payment record when the characteristic type is specified and vice-versa.

You can upload a file by clicking the **Upload** link in the **Payment Upload** screen. On uploading a payment data file, the payment records are copied to the pre-staging area and the status of the payment data file is set to **Pending**. The validation process starts immediately after the payment data file is uploaded in the system. If a payment record is successfully validated, the status of the payment record is set to **Valid**. If a payment record contains incorrect or missing data, the status of the payment record is set to either **Invalid** or **Error** depending on the scenario. For more information about the scenarios when a payment record is set to the **Invalid** or **Error** status, see [Payment Record Status Transition](#) on page 1351.

Once the validation process is completed, the status of the payment data file is changed to **Validated**. Once the payment records are uploaded and validated in the pre-staging area, you can do either of the following:

- Move the payment records to the staging area
- Cancel a payment data file
- Replace the existing payment data file

Note: If a payment data file contains an invalid record, you need to correct or add missing data in the CSV file and then upload the file once again. Unless, a payment data file has no invalid records, you cannot move any record of the payment data file to the staging area.

Move Payment Records to the Staging Area

Once the payment records are uploaded and validated in the pre-staging area, you can move the records to the staging area. The system allows you to move only valid and error records of a payment data file to the staging area. If a payment data file contains an invalid record, you cannot move any record of the payment data file to the staging area. In such scenario, you need to correct the invalid payment records and upload the same file once again in the system. In addition, if you have cancelled a payment data file, you cannot move any records (including valid and error records) of the payment data file to the staging area.

You can move the payment records to the staging area by clicking the **Move to Staging** icon corresponding to the payment data file in the **Payment Upload** screen. The **Move to Staging** icon appears when:

- The status of the payment data file is **Validated**.
- There are no invalid records in the payment data file.
- The **Disable Move to Staging** check box is not selected in the respective file type.

On clicking the **Move to Staging** icon, the payment records are copied (and not moved) from the pre-staging to staging area and the status of the payment data file is changed to **In Staging**. In addition, the status of the payment records in the pre-staging area is changed to **In Staging** and the status of the deposit control, tender control, and payment tender staging records is set to **Pending**. Once you move the payment records to the staging area, you can edit the payment staging records, if required.

Create Payment Events and Payments

Once the payment records are moved to the staging area, the system creates payment events for the payment data file in the background when the **Payment Upload (PUPL)** batch is invoked. You can configure the **Payment Upload (PUPL)** batch such that it is executed at regular intervals. When the **Payment Upload (PUPL)** batch is invoked, the

system checks whether there are any deposit control, tender control, payment tender, and payment staging records in the **Pending** status. If there are staging records in the **Pending** status, the system creates the following entities:

- Deposit Control
- Tender Control
- Payment Events
- Payment Tenders
- Payments
- Payment Segments
- Financial Transactions (when the payments are frozen)

The status of the deposit control, tender control, payment tender, and payment staging records is changed to **Complete**. If any error occurs while creating payment event for a payment record, the status of the deposit control, tender control, payment tender, and payment staging records is changed to **Error**. In addition, the status of the payment record in the pre-staging area is changed to **Error in Staging**.

Traditionally, the **Payment Upload (PUPL)** batch considered staging records which are in the **Error** or **Pending** status. If a staging record is in the **Error** status, the system used to reset the status to **Pending** and then further processed the staging record. This system behavior still exists for staging records which are not uploaded through the **Payment Upload** process. If the staging records are uploaded through the **Payment Upload** process, you need to manually correct the staging records and change the status of deposit control, tender control, payment tender, and payment staging records to **Pending**. The corrected staging records will then be processed when the **Payment Upload (PUPL)** batch is invoked at subsequent interval.

Prerequisites

To setup the payment upload process, you need to do the following:

- Define the required match types with the appropriate payment distribution override and manual distribution algorithms.
- Define the required tender types in the system.
- Define the required currency codes in the system.
- Define the required tender sources in the system.
- Define the required characteristic types where the characteristic entity is set to **Payment**.
- Create a mapping algorithm using the **C1-CSVUPLPAY** algorithm type.
- Create a validation algorithm using the **C1-PUPLVALID** algorithm type.
- Define the required file types where the feed type is set to **Payment Upload Data**.
- Assign the **PUPL To Do** type to a To Do role whose users must receive the To Do generated while executing the **Payment Upload (PUPL)** batch.
- Set the batch control type of the **Payment Upload (PUPL)** batch to **Timed** and define the following attributes:
 - Time Interval
 - Timer Active
 - User ID
 - Batch Language
 - Email Address

CSV File Format

Before uploading a payment data file, you need to ensure that the CSV file contains the following columns:

Column Name	Description	Mandatory (Yes or No)
Account ID	Used to specify the payee account ID.	Yes
Match Type	Used to specify the match type using which you want to match the payment.	Yes (Conditional) Note: This data is required when the match value is specified.
Match Value	Used to specify the entity (such as bill, contract, and so on) against which you want to match the payment.	Yes (Conditional) Note: This data is required when the match type is specified.
Tender ID	Used to specify the payment tender ID. Note: If the tender ID is same for two or more payment records, the system will create multiple payments against one tender. In other words, there will be multiple payments which are created through the payment event.	Yes
Tender Amount	Used to specify the tender amount. Note: You must not specify the value less than or equal to 0. The precision specified for the tender amount must not exceed the decimal places defined for the currency in the system.	Yes
Payment Amount	Used to specify the amount paid through the tender. Note: You must not specify the value less than or equal to 0. The precision specified for the payment amount must not exceed the decimal places defined for the currency in the system.	Yes
Date Received	Used to specify the date when the payment is made. Note: You must specify the date in the MM/DD/YYYY format.	Yes
Bank Account	Used to specify the external source ID which is associated with the tender source.	Yes

Column Name	Description	Mandatory (Yes or No)
Payment Type	Used to specify the type of tender through which the payment is made.	Yes
Check Number	Used to specify the check number if the payment is made through check.	No
Currency	Used to specify the currency in which the payment is made.	No
	Note: If the currency is not specified, it is set to the payor account's invoice currency.	
Account ID Type	Used to specify the account identifier type.	Yes (Conditional)
		Note: This data is required when the account identifier is specified.
Account Identifier	Used to specify the account for which the payment is made.	Yes (Conditional)
		Note: This data is required when the account identifier type is specified.
Payment Char Type1, Payment Char Type2,, Payment Char Type5	Used to indicate the characteristic that must be defined for the payment.	Yes (Conditional)
		Note: This data is required when the characteristic value is specified.
Payment Char Value1, Payment Char Value2,, Payment Char Value5	Used to specify the value for the characteristic type.	Yes (Conditional)
		Note: This data is required when the characteristic type is specified.
MICR ID	Used to specify the MICR code.	No
Payor ID	Used to specify the payor account ID.	No
	Note: If the payor account ID is not specified, the payor account ID is set to the payee account ID assuming that the payor and payee are the same.	

Note:

If a payment data file contains column names other than those mentioned in the above table, the system will not upload the payment data file.

If a payment data file contains more than 1000 payment records, the system will not allow you to upload the payment data file in the system. Therefore, ensure that a payment data file contains less than 1000 payment records.

Payment Data File Status Transition

The following figure graphically indicates how a payment data file moves from one status to another during the payment upload process:

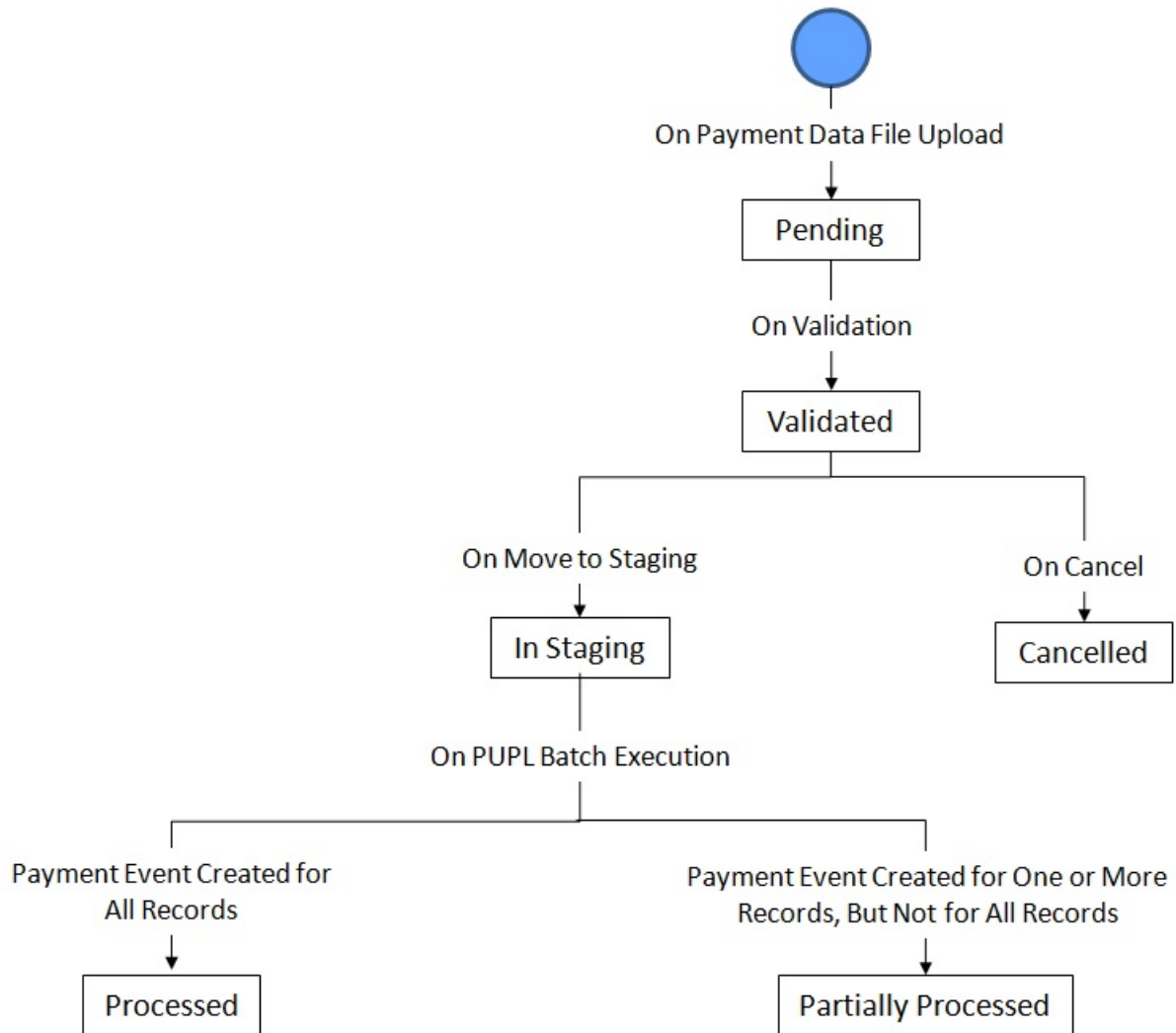

Payment Record Status Transition

The following figure graphically indicates how a payment record moves from one status to another during the payment upload process:

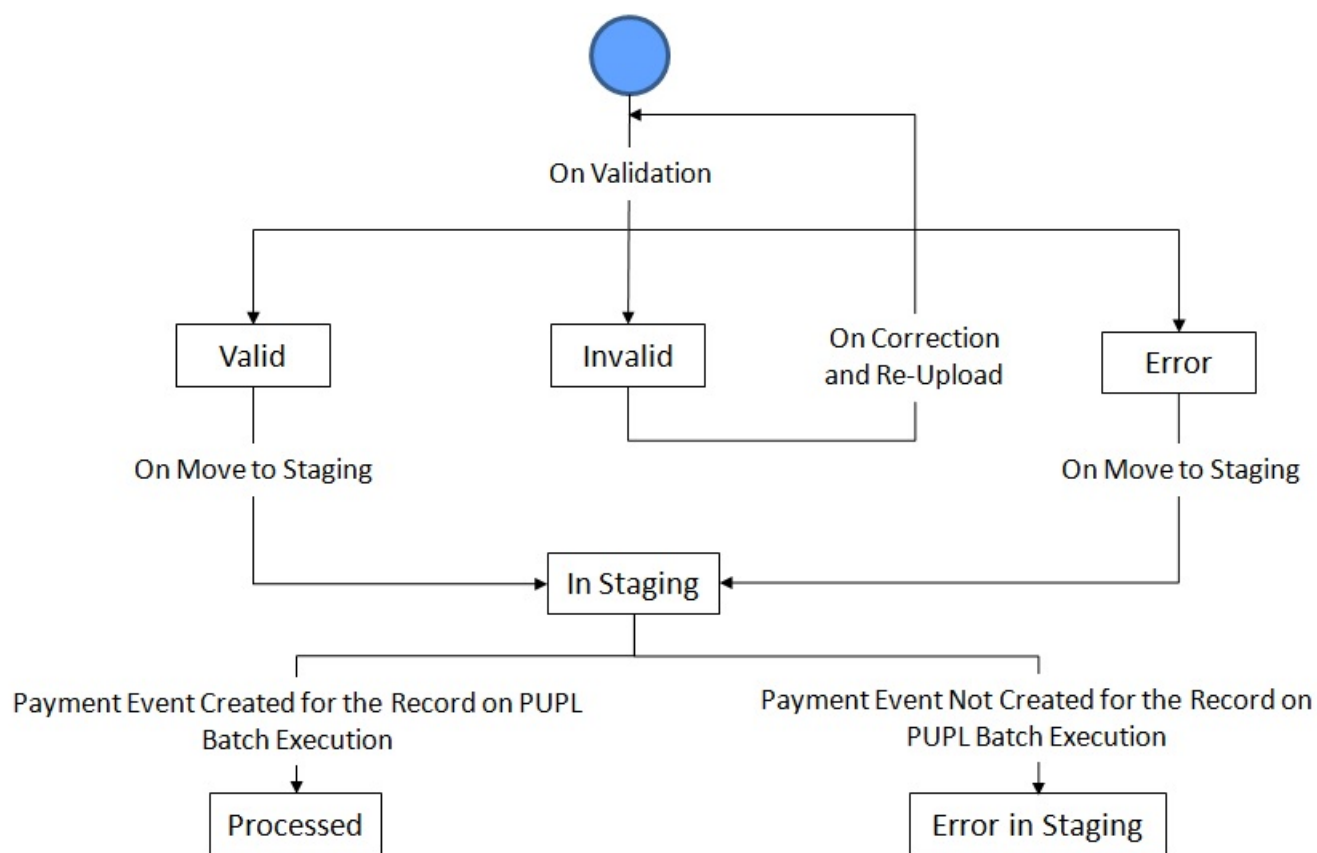

The following table lists the scenarios when a payment record is set to **Invalid** or **Error** status:

Scenario	Payment Record Status
The system could not find the payee account ID for a given account identifier type and account identifier combination when the payee account ID is not specified in the payment record.	Invalid
The payee account ID specified in the payment record does not exist in the system.	Invalid
The payee account ID, account identifier type, or account identifier are not specified in the payment record.	Invalid
The match type is not specified in the payment record.	Invalid
The match type specified in the payment record does not exist in the system.	Error
The match value is not specified in the payment record.	Invalid
The currency code does not exist in the system.	Invalid
The tender amount is either zero or not specified in the payment record.	Invalid
The payment amount is either zero or not specified in the payment record.	Invalid
The bank account is not specified in the payment record.	Invalid
The payment type (i.e. tender type) does not exist in the system.	Invalid

Scenario	Payment Record Status
The payment type is not specified in the payment record.	Invalid
The tender ID is not specified in the payment record.	Invalid
The date received is not specified in the payment record.	Invalid
The payor account ID specified in the payment record does not exist in the system.	Invalid
The characteristic type specified in the payment record does not exist in the system.	Invalid
If a characteristic type is specified, but the characteristic value is not specified in the payment record.	Invalid
If a characteristic value is specified, but the characteristic type is not specified in the payment record.	Invalid
The characteristic value does not match any predefined value when the characteristic value type is set to Predefined Value .	Invalid

Note: The system does the match type and match value related validations when the **Is Match Type Validation Required (Y/N)** parameter is set to **Y** in the validation algorithm.

Error Messages

The following table lists the errors that may occur during the payment upload process. It also indicates how you can resolve these errors.

Message Number	Error Message	Message Category	Possible Issues
80110	File cannot be reuploaded as some records have already been processed.	11111	The possible issues could be: <ul style="list-style-type: none"> You are trying to replace an existing file whose payment records are already moved to the staging area and/or for which payment events are already created.
1463	This file already exists in the system. Please check.	17000	The possible issues could be: <ul style="list-style-type: none"> You are trying to upload a file which is already uploaded in the system without selecting the Replace Existing File check box.
1465	Please upload a file in the CSV format.	17000	The possible issues could be: <ul style="list-style-type: none"> You are trying to upload a file which is not in the CSV format.
80113	Duplicate Header for column %1 in file.	11111	The possible issues could be: <ul style="list-style-type: none"> The file has two or more columns with the same header.

Message Number	Error Message	Message Category	Possible Issues																																				
80111	Length of value %1 too long for Field %2. Maximum length: %3 Found %4.	11111	<p>The possible issues could be:</p> <ul style="list-style-type: none"> The length of value specified in the column exceeds the maximum field length. The following table lists the maximum length of each field: <table border="1" data-bbox="1089 436 1461 1661"> <thead> <tr> <th data-bbox="1094 443 1317 520">Column Name</th> <th data-bbox="1317 443 1456 520">Maximum Length</th> </tr> </thead> <tbody> <tr> <td data-bbox="1094 520 1317 569">Account ID</td> <td data-bbox="1317 520 1456 569">10</td> </tr> <tr> <td data-bbox="1094 569 1317 617">Match Type</td> <td data-bbox="1317 569 1456 617">8</td> </tr> <tr> <td data-bbox="1094 617 1317 665">Match Value</td> <td data-bbox="1317 617 1456 665">30</td> </tr> <tr> <td data-bbox="1094 665 1317 714">Tender ID</td> <td data-bbox="1317 665 1456 714">12</td> </tr> <tr> <td data-bbox="1094 714 1317 762">Tender Amount</td> <td data-bbox="1317 714 1456 762">15</td> </tr> <tr> <td data-bbox="1094 762 1317 810">Payment Amount</td> <td data-bbox="1317 762 1456 810">15</td> </tr> <tr> <td data-bbox="1094 810 1317 858">Date Received</td> <td data-bbox="1317 810 1456 858">10</td> </tr> <tr> <td data-bbox="1094 858 1317 907">Bank Account</td> <td data-bbox="1317 858 1456 907">30</td> </tr> <tr> <td data-bbox="1094 907 1317 955">Payment Type</td> <td data-bbox="1317 907 1456 955">4</td> </tr> <tr> <td data-bbox="1094 955 1317 1003">Check Number</td> <td data-bbox="1317 955 1456 1003">10</td> </tr> <tr> <td data-bbox="1094 1003 1317 1052">Currency</td> <td data-bbox="1317 1003 1456 1052">3</td> </tr> <tr> <td data-bbox="1094 1052 1317 1100">Account ID Type</td> <td data-bbox="1317 1052 1456 1100">8</td> </tr> <tr> <td data-bbox="1094 1100 1317 1192">Account Identifier</td> <td data-bbox="1317 1100 1456 1192">30</td> </tr> <tr> <td data-bbox="1094 1192 1317 1381">Payment Char Type1, Payment Char Type2,, Payment Char Type5</td> <td data-bbox="1317 1192 1456 1381">8</td> </tr> <tr> <td data-bbox="1094 1381 1317 1560">Payment Char Value1, Payment Char Value2,, Payment Char Value5</td> <td data-bbox="1317 1381 1456 1560">254</td> </tr> <tr> <td data-bbox="1094 1560 1317 1608">MICR ID</td> <td data-bbox="1317 1560 1456 1608">30</td> </tr> <tr> <td data-bbox="1094 1608 1317 1656">Payor ID</td> <td data-bbox="1317 1608 1456 1656">10</td> </tr> </tbody> </table>	Column Name	Maximum Length	Account ID	10	Match Type	8	Match Value	30	Tender ID	12	Tender Amount	15	Payment Amount	15	Date Received	10	Bank Account	30	Payment Type	4	Check Number	10	Currency	3	Account ID Type	8	Account Identifier	30	Payment Char Type1, Payment Char Type2,, Payment Char Type5	8	Payment Char Value1, Payment Char Value2,, Payment Char Value5	254	MICR ID	30	Payor ID	10
Column Name	Maximum Length																																						
Account ID	10																																						
Match Type	8																																						
Match Value	30																																						
Tender ID	12																																						
Tender Amount	15																																						
Payment Amount	15																																						
Date Received	10																																						
Bank Account	30																																						
Payment Type	4																																						
Check Number	10																																						
Currency	3																																						
Account ID Type	8																																						
Account Identifier	30																																						
Payment Char Type1, Payment Char Type2,, Payment Char Type5	8																																						
Payment Char Value1, Payment Char Value2,, Payment Char Value5	254																																						
MICR ID	30																																						
Payor ID	10																																						

Message Number	Error Message	Message Category	Possible Issues
80085	Invalid value for column: %1.	11111	<p>The possible issues could be:</p> <ul style="list-style-type: none"> • The payee account ID specified in the payment record does not exist in the system. • The match type specified in the payment record does not exist in the system. • The currency code does not exist in the system. • The account identifier type specified in the payment record does not exist in the system. • The tender amount is either zero or not specified in the payment record. • The payment amount is either zero or not specified in the payment record. • The bank account is not specified in the payment record. • The payment type (i.e. tender type) does not exist in the system. • The tender ID is not specified in the payment record. • The date received is not specified in the payment record. • The characteristic type specified in the payment record does not exist in the system. • The payor account ID specified in the payment record does not exist in the system.
80100	Invalid Account Identifier and Account Identifier Type code combination.	11111	<p>The possible issues could be:</p> <ul style="list-style-type: none"> • The system could not find the payee account ID for a given account identifier type and account identifier combination when the payee account ID is not specified in the payment record.

Message Number	Error Message	Message Category	Possible Issues
80086	%1 has more decimal positions than currency code %2 supports (%3).	11111	The possible issues could be: <ul style="list-style-type: none"> The precision specified for the tender amount exceeds the decimal places defined for the currency in the system. The precision specified for the payment amount exceeds the decimal places defined for the currency in the system.
13601	Tender Source does not exist for External Source ID (%1)	11	The possible issues could be: <ul style="list-style-type: none"> The tender source does not exist for the external source ID in the system.
13603	Deposit control (%1/%2) Deposit Amount is not equal to sum of Tender Amounts	11	The possible issues could be: <ul style="list-style-type: none"> The sum of tender control staging amount does not match the deposit control staging amount.
13604	Deposit Control (%1/%2) Tender count does not equal the number of Tender controls	11	The possible issues could be: <ul style="list-style-type: none"> The number of tender control staging records does not match the total tender controls specified in the deposit control staging record.
13605	Tender control (%1/%2/%3) Total Tender Amount not equal to sum of Tender Amounts	11	The possible issues could be: <ul style="list-style-type: none"> The sum of payment tender staging amount does not match the total tender amount specified in tender control staging record.
13606	Tender control (%1/%2/%3) tender count does not equal the number of Tenders	11	The possible issues could be: <ul style="list-style-type: none"> The number of payment tender staging records does not match the total number of tenders specified in the tender control staging record.
13607	Suspense Contract does not exist for External Source ID (%1)	11	The possible issues could be: <ul style="list-style-type: none"> The suspense contract is not defined for the tender source.
13608	Many Tender Sources found for External Source ID (%1)	11	The possible issues could be: <ul style="list-style-type: none"> There are multiple tender sources in the system with the same external source ID.

Message Number	Error Message	Message Category	Possible Issues
13701	Pay Tender (%1/%2/%3/%4) Amount not equal to sum of Pay Amounts	11	The possible issues could be: <ul style="list-style-type: none"> The sum of payment staging amount does not match the total amount specified in payment tender staging record.
13705	Payment (%1/%2/%3/%4) Person ID (%5) exists on multiple accounts.	11	The possible issues could be: <ul style="list-style-type: none"> There are multiple payment records having contracts with the same old account ID but their payee account ID is different.
80194	File has no records to upload	11111	The possible issues could be: <ul style="list-style-type: none"> You are trying to upload a file without any payment records.
80195	Incorrect header: %1	11111	The possible issues could be: <ul style="list-style-type: none"> One or more column names in the payment data file are incorrect.
80196	Maximum file name size allowed is 60 characters	11111	The possible issues could be: <ul style="list-style-type: none"> The file name contains more than 60 characters.
80199	Missing value for column %1	11111	The possible issues could be: <ul style="list-style-type: none"> The match type is not specified in the payment record. The match value is not specified in the payment record. The payment type is not specified in the payment record.

Payment Upload

The **Payment Upload** screen allows you to search for a payment data file using various search criteria. Through this screen, you can:

- Upload a payment data file
- Cancel a payment data file
- View the records uploaded through a payment data file
- View the log of a payment data file
- Move the payment records to the staging area
- Edit a payment staging record
- Replace an existing payment data file
- View the reasons why the payment record is in the **Error** or **Invalid** status

This screen consists of the following zones:

- [Search Payment Data File](#) on page 1358
- [Payment Data Records](#) on page 1360
- [Payment Data File Log](#) on page 1361

Search Payment Data File

The **Search Payment Data File** zone allows you to search for a payment data file which is uploaded and/or processed in the system. This zone contains the following two sections:



- **Search Criteria** — the **Search Criteria** section contains the following fields:

Field Name	Field Description	Mandatory (Yes or No)
File Name	Used to search a particular payment data file.	No
User ID	Used to search payment data files which are uploaded by a particular user.	No
Upload From Date	Used to search payment data files which are uploaded from a particular date onwards. Note: By default, the date is set to the current date minus 7 days. You can change the date, if required.	No
To	Used to search payment data files which are uploaded till a particular date. Note: By default, the date is set to the current date. You can change the date, if required.	No
File Type	Used to search payment data files which are uploaded using a particular file type.	No
File Status	Used to search payment data files with a particular status. The valid values are: <ul style="list-style-type: none"> • Cancelled • In Staging • Partially Processed • Pending • Processed • Validated 	No

Note: You must specify at least one search criterion while searching for a payment data file.

- **Search Results** — On clicking the **Search** button, the search results appear based on the specified search criteria. The **Search Results** section contains the following columns:

Column Name	Column Description
File Name	Displays the name of the payment data file.
File Type	Indicates the type of the payment data file.
Upload Date	Displays the date and time when the payment data file was uploaded in the system.

Column Name	Column Description
Status	Indicates the status of the payment data file. The valid values are: <ul style="list-style-type: none"> Cancelled In Staging Partially Processed Pending Processed Validated
Total	Displays the total number of records that are uploaded through the payment data file.
Valid	Displays the number of records which are successfully validated in the system.
Invalid	Displays the number of records which could not pass through the validation process in the system.
Error	Displays the number of records where the data is incorrect.
In Staging	Displays the number of records which are copied from the pre-staging to staging area.
Processed	Displays the number of records for which payment events are created.
Staging Error	Displays the number of records for which payment events could not be created.
Cancel	On clicking the Cancel () icon, you can cancel the payment data file. Note: The Cancel icon appears when the status of the payment data file is Validated . In other words, you cannot cancel a payment data file when its records are moved to the staging area or when the payment events are created for the payment data file.
Move to Staging	On clicking the Move to Staging () icon, you can move the valid and error records of the payment data file to the staging area. Note: The Move to Staging icon appears when: <ul style="list-style-type: none"> The status of the payment data file is Validated. There are no invalid records in the payment data file. The Disable Move to Staging check box is not selected in the respective file type.

You can upload a payment data file by clicking the **Upload** link in the upper right corner of this zone. On clicking the **Broadcast** () icon corresponding to the payment data file, the **Payment Data Records** and **Payment Data File Log** zones appear.

Related Topics

For more information on...	See...
Payment Upload screen	Payment Upload on page 1357
How to upload a payment data file	Uploading a Payment Data File on page 1362

For more information on...	See...
How to search for a payment data file	Searching for a Payment Data File on page 1362
How to cancel a payment data file	Cancelling a Payment Data File on page 1365
How to replace an existing payment data file	Replacing an Existing File on page 1364
How to move the payment records to the staging area	Moving the Payment Records to the Staging Area on page 1365
How to edit a payment staging record	Editing a Payment Staging Record on page 1366
How to view the records of a payment data file	Viewing the Records of a Payment Data File on page 1367
How to view the log of a payment data file	Viewing the Log of a Payment Data File on page 1367

Payment Data Records

The **Payment Data Records** zone lists the records of the payment data file. This zone contains the following columns:

Column Name	Column Description
Payor Account ID	Indicates the account which made the payment.
Payee Account ID	Indicates the account for which the payment was made.
Match Type	Indicates the match type using which the payment must be matched.
Match Value	Indicates the entity (such as bill, contract, and so on) against which the payment must be matched.
Pay Tender ID	Displays the payment tender ID.
Tender Amount	Displays the tender amount.
Payment Amount	Displays the amount paid through the tender.
Currency	Indicates the currency in which the payment was made.
Date Received	Displays the date when the payment was made.
Bank Account	Displays the bank account from which the payment was made.
Tender Type	Indicates the type of tender through which the payment was made.
Check Number	Displays the check number if the payment was made through check.
MICR ID	Displays the MICR code.
Status	Indicates the status of the payment record. The valid values are: <ul style="list-style-type: none"> • Valid • Invalid • Error • In Staging • Processed • Error in Staging

Column Name	Column Description
Payment Information Event	Displays information about the payment event which is created for the payment record.
	<p>Note:</p> <p>It has a link. On clicking the link, the Payment Event screen appears with the details of the respective payment event.</p> <p>The data appears in this column when the status of the payment record is Processed.</p>
Payment Staging Record	On clicking the Edit (✎) icon, the Payment Upload Staging screen appears where you can edit the details of the payment staging record.
	<p>Note: The Edit icon appears when the status of the payment record is In Staging.</p>
Error Message	On clicking the View (🔗) icon, the Error Messages window appears where you can view the reasons why the status of the payment record is Invalid or Error .
	<p>Note: The View icon appears when the status of the payment record is Error or Invalid.</p>

Note: Pagination is used to display limited number of records in the **Payment Data Records** zone. By default, 20 records are displayed in this zone. You can use the navigation links, such as **Previous** and **Next** to navigate between pages.

By default, the **Payment Data Records** zone does not appear in the **Payment Upload** screen. It appears when you click the **Broadcast** (📡) icon corresponding to the payment data file in the **Search Payment Data File** zone.

Related Topics

For more information on...	See...
How to view the records of a payment data file	Viewing the Records of a Payment Data File on page 1367
How to view the reasons why the status of the payment record is Invalid or Error	Viewing the Error Messages on page 1368

Payment Data File Log

The **Payment Data File Log** zone lists the complete trail of actions performed on the payment data file. This zone contains the following columns:

Column Name	Column Description
Date/Time	Displays the date and time when the action was performed on the payment data file.
Log Details	Displays the details about the action performed on the payment data file.
User	Indicates the user who has performed the action on the payment data file.

By default, the **Payment Data File Log** zone does not appear in the **Payment Upload** screen. It appears when you click the **Broadcast** (📡) icon corresponding to the payment data file in the **Search Payment Data File** zone.

Related Topics

For more information on...	See...
How to view the log of a payment data file	Viewing the Log of a Payment Data File on page 1367

Searching for a Payment Data File

Prerequisites

To search for a payment data file, you should have:

- File types defined in the application (where the feed type is set to Payment Upload Data)

Procedure

To search for a payment data file:

1. Click the **Menu** link in the **Application** toolbar.
A list appears.
2. From the **Main** menu, select **Payments** and then click **Payment Upload**.
The **Payment Upload** screen appears.
3. Enter the search criteria in the **Search Payment Data File** zone.

Note: ORMB search engine supports wildcard search, where you can substitute the percentage (%) symbol as a stand in for any word or letter in a search criteria. You can use the ‘%’ wildcard character in all input fields except the date and ID fields. The ‘%’ wildcard character is suffixed automatically at the end of the partial search criteria. Therefore, you may or may not specify the wildcard character at the end of the partial search criteria. However, you have to prefix the wildcard character manually wherever required.

4. Click **Search**.

A list of payment data files that meet the search criteria appears in the **Search Results** section.

Related Topics

For more information on...	See...
Payment Upload screen	Payment Upload on page 1357
Search Payment Data File zone	Search Payment Data File on page 1358

Uploading a Payment Data File

Prerequisites

To upload a payment data file, you should have:

- File types defined in the application (where the feed type is set to Payment Upload Data)
- Payment data in the required CSV file format

Procedure

To upload a payment data file:

1. Click the **Menu** link in the **Application** toolbar.
A list appears.
2. From the **Main** menu, select **Payments** and then click **Payment Upload**.
The **Payment Upload** screen appears.
3. Click the **Upload** link in the upper right corner of the **Search Payment Data File** zone.
The **Upload Payment Data File** screen appears. It contains the following fields:

Field Name	Field Description	Mandatory (Yes or No)
File Type	Used to indicate the type of payment data file.	Yes
	Note: The list includes only those file types where the feed type is set to Payment Upload Data .	
File Name	Used to specify the name and path of the payment data file that you want to upload.	Yes
	Note: You can also click the Browse button corresponding to this field to browse to the location where the payment data file is available in the system.	
Replace Existing File	Used to indicate whether you want to replace any existing file in the system. You must select this check box when you want to upload the same file once again.	No

4. Select the type of payment data file from the **File Type** list.

5. Click the **Browse** button corresponding to the **File Name** field.

The **Choose File to Upload** dialog box appears.

6. Browse to the location where the payment data file that you want to upload is available.

7. Click **Open**.

The payment data file name and path appears in the **File Name** field.

8. Click **Upload**.

A message appears indicating that the payment data file is uploaded successfully. If an error occurs while parsing, the payment data file is not uploaded in the system.

Note: If a payment data file contains more than 1000 payment records, the system will not allow you to upload the payment data file in the system. Therefore, ensure that a payment data file contains less than 1000 payment records.

9. Click **OK** in the message box.

On uploading the payment data file, the payment records are copied to the pre-staging area and the status of the payment data file is set to **Pending**. The validation process starts immediately after the payment data file is uploaded in the system. If a payment record is successfully validated, the status of the payment record is set to **Valid**. If a payment record contains incorrect or missing data, the status of the payment record is set to either **Invalid** or **Error** depending on the scenario. For more information about the scenarios when a payment record is set to the **Invalid** or **Error** status, see [Payment Record Status Transition](#) on page 1351.

Once the validation process is completed, the status of the payment data file is changed to **Validated**. If a payment data file contains an invalid record, you need to correct or add missing data in the CSV file and then upload the file once again. Unless, a payment data file has no invalid records, you cannot move any record of the payment data file to the staging area.

Related Topics

For more information on...	See...
Payment Upload screen	Payment Upload on page 1357
Search Payment Data File zone	Search Payment Data File on page 1358

Replacing an Existing File

Prerequisites

To replace an existing payment data file, you should have:

- File types defined in the application (where the feed type is set to Payment Upload Data)
- Payment data in the required CSV file format

Procedure

To replace an existing payment data file:

1. Click the **Menu** link in the **Application** toolbar.
A list appears.
2. From the **Main** menu, select **Payments** and then click **Payment Upload**.
The **Payment Upload** screen appears.
3. Click the **Upload** link in the upper right corner of the **Search Payment Data File** zone.
The **Upload Payment Data File** screen appears.
4. Select the type of payment data file from the **File Type** list.
5. Click the **Browse** button corresponding to the **File Name** field.
The **Choose File to Upload** dialog box appears.
6. Browse to the location where the payment data file that you want to upload is available.
7. Click **Open**.
The payment data file name and path appears in the **File Name** field.
8. Select the **Replace Existing File** check box.

Note: You can replace an existing file when the payment data file is in the **Validated** status. In other words, you cannot replace a file whose payment records are already moved to the staging area and/or for which payment events are already created.

9. Click **Upload**.

A message appears indicating that the payment data file is uploaded successfully. If an error occurs while parsing, the payment data file is not uploaded in the system.

10. Click **OK** in the message box.

Once the payment data file is successfully uploaded, the status of the payment data file is set to **Pending**. The validation process starts immediately after the payment data file is uploaded in the system. If a payment record is successfully validated, the status of the payment record is changed to **Valid**. If a payment record contains incorrect or missing data, the status of the payment record is changed to either **Invalid** or **Error** depending on the scenario. For more information about the scenarios when a payment record is set to the **Invalid** or **Error** status, see [Payment Record Status Transition](#) on page 1351. You can view the details of the uploaded payment data file and its records in the **Payment Upload** screen.

Once the validation process is completed, the payment records are copied to the pre-staging area and the status of the payment data file is changed to **Validated**. If a payment data file contains an invalid record, you need to correct or add missing data in the CSV file and then upload the file once again. Unless, a payment data file has no invalid records, you cannot move any record of the payment data file to the staging area.

Related Topics

For more information on...	See...
Payment Upload screen	Payment Upload on page 1357
Search Payment Data File zone	Search Payment Data File on page 1358

Canceling a Payment Data File

There might be situations when incorrect payment data file is uploaded in the system. In such case, the system provides you with an ability to cancel the file. However, note that you can cancel a payment data file when it is in the **Validated** status. In other words, you cannot cancel a payment data file when its records are moved to the staging area or when the payment events are created for the payment data file.

Procedure

To cancel a payment data file:

1. Search for the payment data file in the **Payment Upload** screen.
2. In the **Search Results** section, click the **Cancel** () icon in the **Cancel** column corresponding to the payment data file that you want to cancel.

A message appears confirming whether you want to cancel the payment data file.

Note: The **Cancel** icon appears when the status of the payment data file is **Validated**.

3. Click **OK**.

The status of the payment data file is changed to **Cancelled**.

Related Topics

For more information on...	See...
How to search for a payment data file	Searching for a Payment Data File on page 1362

Moving the Payment Records to the Staging Area

Procedure

To move the payment records to the staging area:

1. Search for the payment data file in the **Payment Upload** screen.
2. In the **Search Results** section, click the **Move to Staging** () icon in the **Move to Staging** column corresponding to the payment data file whose records you want to move to the staging area.

A message appears confirming whether you want to move all payment records to the payment upload staging area.

Note:

The **Move to Staging** icon appears when:

- The status of the payment data file is **Validated**.
- There are no invalid records in the payment data file.
- The **Disable Move to Staging** check box is not selected in the respective file type.

The system allows you to move only valid and error records of a payment data file to the staging area. If a payment data file contains an invalid record, you cannot move any record of the payment data file to the staging area.

3. Click **OK** in the message box.

A message appears indicating that the payment records are successfully copied from the pre-staging to staging area.

4. Click **OK** in the message box.

The status of the payment data file is changed to **In Staging**. In addition, the status of the payment records in the pre-staging area is changed to **In Staging** and the status of the deposit control, tender control, and payment tender staging records is set to **Pending**.

Related Topics

For more information on...	See...
How to search for a payment data file	Searching for a Payment Data File on page 1362

Editing a Payment Staging Record

You can edit a payment record when it is moved from the pre-staging to staging area. On editing a payment record in the staging area, the system does not reflect the changes in the pre-staging area. It only reflects the changes in the staging area.

Procedure

To edit a payment staging record:

1. Search for the payment data file in the **Payment Upload** screen.
2. In the **Search Results** section, click the **Broadcast** () icon corresponding to the payment data file whose staging records you want to edit.

The **Payment Data Records** and **Payment Data File Log** zones appear.

3. In the **Payment Data Records** zone, click the **Edit** () icon in the **Payment Staging Record** column corresponding to the payment record whose details you want to edit in the staging area.

The **Payment Upload Staging** screen appears. It contains the following tabs:

- **Tender Details** — Enables you to view and edit the tender control staging details.
- **Payment Advice** — Enables you to view and edit the payment staging details.
- **Payment Characteristics** — Enables you to view and edit the payment characteristic staging details.

Note: The **Edit** icon appears when the status of the payment record is **In Staging**.

4. Modify the required details.
5. Click the **Save** link in the **Application** toolbar.

The changes made to the payment staging record are saved.

Related Topics

For more information on...	See...
How to search for a payment data file	Searching for a Payment Data File on page 1362

Viewing the Records of a Payment Data File

Procedure

To view the records of a payment data file:

1. Search for the payment data file in the **Payment Upload** screen.
2. In the **Search Results** section, click the **Broadcast** () icon corresponding to the payment data file whose records you want to view.

The **Payment Data Records** and **Payment Data File Log** zones appear.

3. View the details of the payment records, which are uploaded through the payment data file, in the **Payment Data Records** zone.

Related Topics

For more information on...	See...
How to search for a payment data file	Searching for a Payment Data File on page 1362
Payment Data Records zone	Payment Data Records on page 1360

Viewing the Log of a Payment Data File

Procedure

To view the log of a payment data file:

1. Search for the payment data file in the **Payment Upload** screen.
2. In the **Search Results** section, click the **Broadcast** () icon corresponding to the payment data file whose log you want to view.

The **Payment Data Records** and **Payment Data File Log** zones appear.

3. View the actions performed on the payment data file in the **Payment Data File Log** zone.

Related Topics

For more information on...	See...
How to search for a payment data file	Searching for a Payment Data File on page 1362
Payment Data File Log zone	Payment Data File Log on page 1361

Viewing the Error Messages

The system allows you to view the reasons why the payment record in a payment data file is in the **Error** or **Invalid** status.

Procedure

To view the error messages:

1. Search for the payment data file in the **Payment Upload** screen.
2. In the **Search Results** section, click the **Broadcast** (📡) icon corresponding to the payment data file whose payment records are in the **Error** or **Invalid** status.

The **Payment Data Records** and **Payment Data File Log** zones appear.

3. In the **Payment Data Records** zone, click the **View** (🔍) icon in the **Error Message** column corresponding to the payment record which is in the **Error** or **Invalid** status.

The **Error Messages** window appears. It lists the reasons why the payment record is in the **Error** or **Invalid** status. If the payment record is in the **Invalid** status, you need to correct or add missing data in the CSV file and then upload the file once again. Unless, a payment data file has no invalid records, you cannot move any record of the payment data file to the staging area.

Note: The **View** icon appears when the status of the payment record is **Error** or **Invalid**.

4. View the reasons in the **Error Messages** window.
5. Click **OK**.

Related Topics

For more information on...	See...
How to search for a payment data file	Searching for a Payment Data File on page 1362
Payment Data Records zone	Payment Data Records on page 1360

Chapter 16

Freeze Payments on Notification

Topics:

- [Freeze Payments on Notification Process](#)
- [Prerequisites](#)
- [Automatic Payment or Refund Clearing Staging Record Status Transition](#)
- [EDI 824 File Format](#)
- [Sample EDI 824 File Format](#)
- [Automatic Payment and Refund Upload Reason](#)
- [Automatic Payment and Refund Clearing Staging](#)

Oracle Revenue Management and Billing facilitates you to create automatic payments and refunds when the automatic payment option is enabled for an account. A clearing record is created for each automatic payment and refund in the system. You can then send the automatic payment and refund clearing records to the auto clearing house for verification. The system provides the mechanism to extract the automatic payment clearing records in a flat file. You can then send the flat file to the auto clearing house for verification. However, the implementation team will have to write the custom logic to extract the automatic refund clearing records in a file which you can then send to the auto clearing house for verification.

Once the auto clearing house reviews the automatic payment clearing records, the system allows you to upload review comments received in the EDI 824 file format. On uploading an EDI 824 file, an automatic payment clearing staging record is created for each valid automatic payment clearing ID. The data received from the auto clearing house is stored in the following staging tables:

- CI_APAY_STAGE_UP
- CI_APAY_STAGE_UP_REM
- CI_APAY_STGUP_CHAR

The implementation team will have to write the custom logic to upload review comments for automatic refund clearing records in the above mentioned staging tables. The review comments for automatic payment clearing records can be received in the form of reason (i.e. upload reason) and error codes (i.e. payment cancelation reason or NOC reason) which will help you to determine whether the automatic payment must be frozen or cancelled in the system. Similarly, the review comments for automatic refund clearing records can be received in the form of reason (i.e. upload reason) and error codes (i.e. void status reason) which will help you to determine whether the refund request must be voided and refund adjustments must be cancelled in the system.

Once the review comments are received from the auto clearing house, you can do the following:

- Freeze or cancel the automatic payments
- Void the refund requests and cancel the refund adjustments

For more detailed information about the freeze payments on notification process, see [Freeze Payments on Notification Process](#) on page 1371.

The system allows you to define upload reasons, payment cancelation reasons, NOC reasons, and void status reasons. The system also allows you to edit and delete the automatic payment and refund clearing staging records through the user interface. However, you can edit an automatic payment or refund clearing staging record when it is in the **Pending** or **Error** status, and you

can delete an automatic payment or refund clearing staging record when it is in the **Pending** status. During the freeze payments on notification process, the automatic payment and refund clearing staging records go through various statuses in its lifecycle. For more information about the statuses, see [Automatic Payment or Refund Clearing Staging Record Status Transition](#) on page 1375.

For more information on how to setup the freeze payments on notification process, see [Prerequisites](#) on page 1374.

Freeze Payments on Notification Process

The Freeze Payments on Notification process includes the following sub-processes:

1. [Creating Automatic Payments and Refunds](#) on page 1371
2. [Generating a Flat File](#) on page 1371
3. [Uploading Response from Auto Clearing House \(ACH\)](#) on page 1371
4. [Retry Automatic Payment](#) on page 1372
5. [Freezing or Canceling Automatic Payments](#) on page 1373
6. [Voiding Refund Requests and Canceling Refund Adjustments](#) on page 1373
7. [Generating To Do Entries](#) on page 1374
8. [Creating Tender Controls](#) on page 1374

Note that during the freeze payments on notification process, you need to execute the following batches in the specified order:

1. Create Automatic Payments and Refunds (APAYCRET)
2. Activate Automatic Payments (ACTVTAPY)
3. Extract Automatic Payments (APAYACH)
4. Maintain Additional Information for Staging Record (C1-APRCH)
5. Upload Response from Auto Clearing House (C1-APACK)
6. Freeze or Cancel Automatic Payments (APAYRA)
7. Cancel Automatic Refunds (AREFRA)
8. To Do Creation for Automatic Payment Exception Records (APAYUPTD)
9. Create Tender Controls for Automatic Payments (BALAPY)

For more information about these batches, see *Oracle Revenue Management and Billing Batch Guide*.

Creating Automatic Payments and Refunds

If you have configured the automatic payment option for an account, the system calculates the automatic payment amount and extract date during the bill completion and stamps these details against the bill in the **CI_BILL_ACH** table. The **Create Automatic Payments and Refunds (APAYCRET)** batch allows you to create automatic payment and refund request depending on whether the automatic payment amount is in debit or credit. It also creates a clearing record for each automatic payment and refund in the **CI_APAY_CLR_STG** and **CI_ADJ_CLR_STG** tables, respectively. For more information about the batch, see *Oracle Revenue Management and Billing Batch Guide*.

Generating a Flat File

Unless you activate a clearing record, you cannot extract the clearing record in a flat file. The **Activate Automatic Payments (ACTVTAPY)** batch allows you to activate a clearing record. It stamps the **APAYACH** batch control and incremental batch run number on the clearing record.

Once the clearing records are activated, you can extract the clearing records in a flat file. The **Extract Automatic Payments (APAYACH)** batch allows you to extract the clearing records with the latest batch run number in a flat file. The flat file is then sent to the auto clearing house for review. For more information about these batches, see *Oracle Revenue Management and Billing Batch Guide*.

Note: At present, you cannot activate and extract the automatic refund clearing records using the **Activate Automatic Payments (ACTVTAPY)** and **Extract Automatic Payments (APAYACH)** batches, respectively. The implementation team will have to write the custom logic to activate and extract automatic refund clearing records in a flat file.

Uploading Response from Auto Clearing House (ACH)

Once the auto clearing house reviews the automatic payment clearing records, the review comments can be shared in the EDI 824 file format. An EDI 824 file may contain the review comments for one or more automatic payment clearing records. You can upload these EDI 824 files and store the review comments in the staging area using the **Upload Response from Auto Clearing House (C1-APACK)** batch.

On uploading an EDI 824 file, the system checks whether the automatic payment clearing ID specified in each record exists in the system. If so, it creates an automatic payment clearing staging record for the automatic payment clearing ID in the **CI_APAY_STAGE_UP** table. If the acknowledgement code in the record is set to **TE** or **TR**, the system considers that the auto clearing house has rejected the automatic payment clearing record. The reason code (i.e. upload reason) specified in the **Reject Upload Reason** parameter of the **C1-APAY** algorithm is stored corresponding to the automatic payment clearing staging record in the **CI_APAY_STAGE_UP_REM** table. In addition, the error code (i.e. payment cancellation reason) is stored corresponding to the automatic payment clearing staging record in the **CI_APAY_STAGE_UP_REM** table.

However, if the acknowledgement code is blank or if the acknowledgement code is set to a value other than **TE** or **TR**, the system considers that the auto clearing house has accepted the automatic payment clearing record. The reason code (i.e. upload reason) specified in the **Success Upload Reason** parameter of the **C1-APAY** algorithm is stored corresponding to the automatic payment clearing staging record in the **CI_APAY_STAGE_UP_REM** table. In addition, the error code (i.e. NOC reason) is stored corresponding to the automatic payment clearing staging record in the **CI_APAY_STAGE_UP_REM** table. In this case, the record may contain more than one error code.

The status of the automatic payment clearing staging record is set to **Pending**. If the error code (i.e. payment cancellation reason or NOC reason) is invalid, the status of the automatic payment clearing staging record is set to **Error**. An exception is logged in the **CI_APAY_STGUP_EXC** table. In addition, if the status of the NOC reason is **Inactive** in the system, the status of the automatic payment clearing staging record is set to **Error** and an exception is logged in the **CI_APAY_STGUP_EXC** table.

The system sets the automatic payment distribution and freeze date (i.e. **APAY_DIST_FRZ_DT**) for each automatic payment clearing record (for which automatic payment clearing staging record is added in the system) to the payment date (which is stored on the payment event). For more information about the batch, see *Oracle Revenue Management and Billing Batch Guide*.

Note: An additional table named **CI_APAY_STGUP_CHAR** is available which the implementation team can use to store additional information about the automatic payment clearing staging record in the form of characteristics.

To ensure that the EDI 824 files are uploaded successfully, you need to set the following parameters in an algorithm which is created using the **C1-APAY** algorithm type:

- **Line Separator** - Used to indicate the character specified in the EDI 824 files to represent the end of line.
- **Field Separator** - Used to indicate the character specified in the EDI 824 files to represent the end of data record.
- **Reject Upload Reason** - Used to indicate the upload reason which you want to use when the auto clearing house has rejected the automatic payment clearing record.
- **Success Upload Reason** - Used to indicate the upload reason which you want to use when the auto clearing house has accepted the automatic payment clearing record with or without Notice to Change (NOC).

Note: You must specify an upload reason which is already defined in the system.

For more information about the EDI 824 file format, see [EDI 824 File Format](#) on page 1376.

Retry Automatic Payment

In the Freeze Payments on Notification feature, the system enables you to freeze or cancel the automatic payment based on the review comments received from the auto clearing house. Until now, the system did not allow to resend the automatic payment clearing records to the auto clearing house for review in case of rejection. Now, the system enables you to resend the rejected automatic payment clearing records to the auto clearing house for review.

To enable this feature, you need to set the **C1-APMSG** characteristic type for the required divisions. Here, you must set the maximum automatic payment reattempts allowed while using the Freeze Payments on Notification feature.

A new batch named **C1-APRCH** is introduced in this release. You need to execute this batch in between the following two batches - **C1-APACK** and **APAYRA**. The **C1-APRCH** batch considers the automatic payment clearing staging records which are in the **Pending** status from the **CI_APAY_STAGE_UP** table. The system then checks whether the **APAY_UPL_RSN_TYPE** column corresponding to the automatic payment clearing staging record is set to **SUCC** or **CANC**. If the **APAY_UPL_RSN_TYPE** column corresponding to the automatic payment clearing staging record is

set to **SUCC**, the system updates the last extract date of the automatic payment clearing staging record to the extract date which is available corresponding to the clearing record in the **CI_APAY_CLR_STG** table. However, if the **APAY_UPL_RSN_TYPE** column corresponding to the automatic payment clearing staging record is set to **CANC**, the system checks whether the number of automatic payment clearing staging records for the clearing record is equal to or greater than one. If the number of automatic payment clearing staging records for the clearing record is equal to or greater than one, the system increments the retry count of the clearing ID. If the retry count is greater than zero and less than the maximum automatic payment reattempt limit defined for the division, the system does the following:

- Recalculates the extract date and stamps it against the corresponding clearing record in the **SCHED_EXTRACT_DT** column of the **CI_APAY_CLR_STG** table
- Clears the **BATCH_NBR** column of the corresponding clearing record in the **CI_APAY_CLR_STG** table
- Clears the **APAY_DIST_FRZ_DT** column of the corresponding clearing record in the **CI_APAY_CLR_STG** table

Finally, the status of the automatic payment clearing staging record is set to **RETR**. A To Do is created using the **CI-APRET** To Do type to notify that the status of an automatic payment clearing staging record is changed to **RETR**.

Freezing or Canceling Automatic Payments

Once the review comments are received in the form of reason and error codes for an automatic payment clearing record, you need to freeze or cancel the automatic payment based on the reason code. You can freeze or cancel automatic payments through the **Freeze or Cancel Automatic Payments (APAYRA)** batch.

On executing the **Freeze or Cancel Automatic Payments (APAYRA)** batch, the system checks whether the reason code (i.e. upload reason) and error code (i.e. payment cancellation reason or NOC reason) specified in the automatic payment clearing staging record exist in the system. This batch considers only those automatic payment clearing staging records which are in the **Pending** status and for which payment freeze date is specified in the automatic payment clearing record. If the reason code and error code exist in the system, the system executes the algorithms attached to the reason code in the specified sequence. If the type of reason code is **Cancel**, the attached algorithm cancels the automatic payment and payment event. If the type of reason code is **Success**, the attached algorithm freezes the automatic payment on the payment freeze date. However, if the type of reason code is **Success** and the error code is specified along with the reason code, the attached algorithm freezes the automatic payment on the payment freeze date, stores error codes (i.e. NOC reasons) as payment tender characteristics and then creates a To Do entry to notify user about these NOC reasons. Finally, the status of the automatic payment clearing staging record is changed to **Complete**.

If the reason code and/or error code (i.e. upload reason, payment cancellation reason, or NOC reason) specified in the automatic payment clearing staging record does not exist in the system, the status of the automatic payment clearing staging record is changed to **Error**. In addition, if the status of the NOC reason is **Inactive** in the system, the status of the automatic payment clearing staging record is changed to **Error**. For more information about the batch, see *Oracle Revenue Management and Billing Batch Guide*.

Voiding Refund Requests and Canceling Refund Adjustments

Once the auto clearing house reviews the automatic refund clearing records and shares the review comments, the implementation team will have to store the review comments in the following staging tables:

- **CI_APAY_STAGE_UP** – Used to store the automatic payment or refund clearing staging record for an automatic payment or refund clearing record, respectively. The status of the automatic payment or refund clearing staging record must be set to **Pending**.
- **CI_APAY_STAGE_UP_REM** – Used to store the reason and error codes of each automatic payment or refund clearing staging record.
- **CI_APAY_STGUP_CHAR** – Used to store additional information about the automatic payment or refund clearing staging record in the form of characteristics.

The review comments must be received in the form of reason (i.e. upload reason) and error codes (i.e. void status reason) for an automatic refund clearing record. On executing the **Cancel Automatic Refunds (AREFRA)** batch, it checks whether the reason and error codes specified in the automatic refund clearing staging record exist in the system. If

the reason and error codes exist in the system, the system executes the algorithms attached to the reason code in the specified sequence. If the type of reason code is **Cancel**, the attached algorithm changes the status of the refund request to **Voided** and the corresponding refund adjustments are canceled. If the type of reason code is **Success**, no changes are made to the refund request and refund adjustments. Finally, the status of the automatic refund clearing staging record is changed to **Complete**.

If the reason code and/or error code (i.e. upload reason, void status reason) specified in the automatic refund clearing staging record does not exist in the system, the status of the automatic refund clearing staging record is changed to **Error**.

Generating To Do Entries

If an exception occurs while executing the **Freeze or Cancel Automatic Payments (APAYRA)** batch, you can notify the user about such exception. The **To Do Creation for Automatic Payment Exception Records (APAYUPTD)** batch allows you to create a To Do using the **APAYUPTD** To Do type when an exception is logged for an automatic payment clearing staging record in the **CI_APAY_STGUP_EXC** table. The system creates one To Do entry for all exceptions that have occurred for an automatic payment clearing staging record. For more information about these batches, see *Oracle Revenue Management and Billing Batch Guide*.

Note: At present, a To Do is not created when an exception is logged for an automatic refund clearing staging record in the **CI_APAY_STGUP_EXC** table while executing the **Cancel Automatic Refunds (AREFRA)** batch.

Creating Tender Controls

Once you freeze the automatic payments, you need to create tender and deposit controls. The **Create Tender Controls for Automatic Payments (BALAPY)** batch allows you to create tender and deposit controls for each automatic payment which is frozen, but not yet linked to any tender control. One tender control is created for the **APAYACH** batch control and batch run number combination. The payment tenders of these automatic payments are then linked to the tender control.

This batch also balances the open tender control records and changes the status of the tender and deposit controls, accordingly. For more information about the batch, see *Oracle Revenue Management and Billing Batch Guide*.

Prerequisites

To setup the freeze payments on notification process, you need to do the following:

- Define the automatic payment instructions for the account for which you want to enable the automatic payment option.

Note: You can either define non-rule based effective dated automatic payment instructions in the **Auto Pay** tab of the **Account** screen or define rule based effective dated automatic payment instructions through the **Auto Pay Rule** screen.

- Set the **Autopay Creation Option** field to **Freeze Payment on Notification** in the **Billing** tab of the **Installation Options** screen.
- Create an automatic payment creation algorithm using the **APAY-CREATE** algorithm type and attach it to the **Automatic Payment Creation** system event in the **Algorithms** tab of the **Installation Options - Framework** screen.
- Create an automatic refund creation algorithm using the **C1-AREF-CRET** algorithm type and attach it to the **Automatic Adjustment Creation** system event in the **Algorithms** tab of the **Installation Options - Framework** screen.
- Create a date calculation algorithm using the **APAY-DTCALC** algorithm type and attach it to the **Autopay Date Calculation Alg** spot of the auto pay route type which is specified on the account's automatic payment instruction.
- Define the required upload reasons in the system.

- Define the required payment cancelation reasons in the system.
- Define values for the **APAY_UPL_NOC_LOOKUP** lookup field.

Note: The **APAY_UPL_NOC_LOOKUP** lookup field is used to define NOC reasons. The NOC reason specified in the automatic payment clearing staging record must exist in this lookup field and its status must be **Active**. Otherwise, the status of the automatic payment clearing staging record is changed to **Error**.

- Define voided status reasons for the **C1-RefundReq** business object.
- Create an automatic payment success algorithm using the **C1-APAY-SUCC** algorithm type and attach it to the reason code where the reason type is set to **Success**.

Note: You must attach the automatic payment success algorithm to an upload reason which you want to use while freezing automatic payments.

- Create an automatic payment cancel algorithm using the **C1-APAY-CAN** algorithm type and attach it to the reason code where the reason type is set to **Cancel**.

Note: You must attach the automatic payment cancel algorithm to an upload reason which you want to use while canceling automatic payments.

- Create a void automatic refund algorithm using the **C1-AREF-VOID** algorithm type and attach it to the reason code where the reason type is set to **Cancel**.

Note: You must attach the void automatic refund algorithm to an upload reason which you want to use while voiding automatic refunds.

- Create a characteristic type where the characteristic entity is set to **Payment Tender**. And, then specify this characteristic type as the value for the **Tender Characteristic Type** parameter in an algorithm which is created using the **C1-APAY-SUCC** algorithm type.
- Assign the **C1-ACH** To Do type to a To Do role whose users must receive the To Do entries generated when automatic payments are frozen with a Notice to Change (NOC).
- Assign the **APAYUPTD** To Do type to a To Do role whose users must receive the To Do entries generated when exceptions have occurred while executing the **Freeze or Cancel Automatic Payments (APAYRA)** batch.
- Define values for the following parameters in an algorithm which is created using the **C1-APAY** algorithm type:
 - Line Separator
 - Field Separator
 - Reject Upload Reason
 - Success Upload Reason

Automatic Payment or Refund Clearing Staging Record Status Transition

The following figure graphically indicates how an automatic payment or refund clearing staging record moves from one status to another during the freeze payments on notification process:

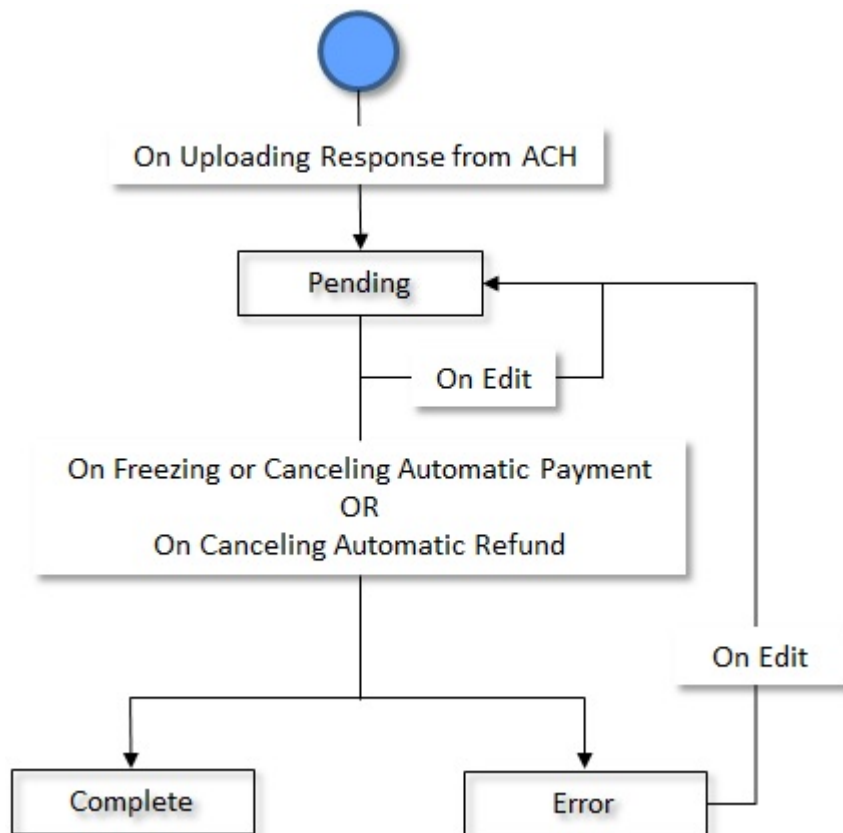

EDI 824 File Format

Before uploading the EDI 824 file, you need to ensure that the file contains the following tags and attributes:

Tag	Attribute	Description	Mandatory (Yes or No)
OTI	Reference Number	Used to specify the automatic payment clearing ID. It indicates the automatic payment clearing record for which the review comments are received from the auto clearing house.	Yes
OTI	Acknowledgement Code	Used to indicate whether the automatic payment clearing record is accepted or rejected by the auto clearing house. If you want to reject the automatic payment clearing record, you must specify TE or TR as the acknowledgement code. However, if you want to approve the automatic payment clearing record, you can either specify any value other than TE or TR or leave this attribute blank.	No

Tag	Attribute	Description	Mandatory (Yes or No)
TED	Error Code	<p>Used to indicate either of the following:</p> <ul style="list-style-type: none"> The payment cancellation reason when the automatic payment clearing record is rejected by the auto clearing house. <p>Note: You must specify a payment cancellation reason which is already defined in the system.</p> <ul style="list-style-type: none"> The Notice to Change (NOC) reason when the automatic payment clearing record is accepted by the auto clearing house with a Notice to Change (NOC). <p>Note: You must specify a NOC reason which is already defined in the APAY_UPL_NOC_LOOKUP lookup field.</p>	<p>Yes (Conditional)</p> <p>Note: This attribute is required when the automatic payment clearing record is rejected by the auto clearing house.</p>
TED	Error Description	Used to specify the reason why the automatic payment clearing record is either rejected or accepted with a Notice to Change (NOC).	No

Sample EDI 824 File Format

```

OTI*TR*TN*411302586842\
TED*WA01*WRONG ACCOUNT\
OTI*TF*TN*411302525641\
OTI*TO*TN*806152348038\
TED*BR01*Bill Reopened\
OTI*TO*TN*806152307159\
OTI*TE*TN*806152307229\
TED*WA01*WRONG ACCOUNT\

```

Here, TR, TF, TO, and TE are acknowledgement codes. TR and TE indicate that the automatic payment clearing records are rejected. And, TF and TO indicate that the automatic payment clearing records are accepted with or without a Notice to Change (NOC).

Here, 411302586842, 411302525641, 806152348038, 806152307159, and 806152307229 are automatic payment clearing records, and WA01 and BR01 are error codes. WA01 is a payment cancellation reason and BR01 is a NOC reason. The string “WRONG ACCOUNT” and “Bill Reopened” are error descriptions.

For more information about the EDI 824 file format, see [EDI 824 File Format](#) on page 1376.

Automatic Payment and Refund Upload Reason

Once the auto clearing house reviews the automatic payment and refund clearing records, an appropriate upload reason must be received for each clearing record. The upload reason indicates the following:

- Whether the automatic payment must be frozen or cancelled in the system



- Whether the automatic refund must be canceled in the system (i.e. the refund request must be voided and refund adjustments must be canceled)

The **Automatic Payment and Refund Upload Reason** screen allows you to define, edit, and delete an upload reason. It contains the following zone:

- [Upload Reasons](#) on page 1378

Upload Reasons

The **Upload Reasons** zone lists upload reasons that are already defined in the system. It contains the following columns:

Column Name	Column Description
Upload Reason	Displays the upload reason.
Reason Type	Indicates the type of upload reason. The valid values are: <ul style="list-style-type: none"> • Cancel • Success
Eligible for Processing	Indicates whether the algorithms attached to the upload reason must be triggered while executing the Freeze or Cancel Automatic Payments (APAYRA) or Cancel Automatic Refunds (AREFRA) batch. The valid values are: <ul style="list-style-type: none"> • Y • N
Description	Displays the description of the upload reason.
Edit	On clicking the Edit () icon, the Automatic Payment and Refund Upload Reason screen appears where you can edit the details of the upload reason.
Delete	On clicking the Delete () icon, you can delete the upload reason.

You can define an upload reason by clicking the **Add** link in the upper right corner of this zone.

Related Topics

For more information on...	See...
How to define an upload reason	Defining an Upload Reason on page 1378
How to edit an upload reason	Editing an Upload Reason on page 1380
How to delete an upload reason	Deleting an Upload Reason on page 1382

Defining an Upload Reason

Prerequisites

To define an upload reason, you should have:

- Automatic payment success algorithm defined using the **C1-APAY-SUCC** algorithm type
- Automatic payment cancel algorithm defined using the **C1-APAY-CAN** algorithm type
- Void automatic refund algorithm defined using the **C1-AREF-VOID** algorithm type

Procedure

To define an upload reason:

1. Click the **Admin** link in the **Application** toolbar.

A list appears.

- From the **Admin** menu, select **A** and then click **Automatic Payment and Refund Upload Reason**.

The **Automatic Payment and Refund Upload Reason** screen appears.

- Click the **Add** link in the upper right corner of the **Upload Reasons** zone.

The **Automatic Payment and Refund Upload Reason** screen appears. It contains the following fields:

Field Name	Field Description	Mandatory (Yes or No)
Upload Reason	Used to specify the upload reason.	Yes
Description	Used to specify the description for the upload reason.	Yes
Reason Type	Used to indicate the type of upload reason. The valid values are: <ul style="list-style-type: none"> Cancel — This type of upload reason indicates that you must cancel the automatic payment or refund in the system. In this case, the error code indicates the reason why the automatic payment is cancelled or the refund request is voided. Success — This type of upload reason indicates that you must freeze the automatic payment on the payment freeze date. If the error code is specified, it indicates that you must freeze the automatic payment, and at the same time notify user that the automatic payment is accepted with a Notice to Change (NOC). The NOC reason is stored as payment tender characteristic in the system. You can specify more than one error code (i.e. NOC reasons) with this type of upload reason. On freezing an automatic payment, the user is notified about these NOC reasons through a To Do entry. The system creates one To Do entry using the C1-ACH To Do type for all NOC reasons specified in the automatic payment clearing staging record. 	Yes
Eligible for Processing	Used to indicate whether the algorithms attached to the upload reason must be triggered while executing the Freeze or Cancel Automatic Payments (APAYRA) or Cancel Automatic Refunds (AREFRA) batch.	No

In addition, this screen contains a grid where you can attach algorithms to the upload reason. It contains the following columns:

Column Name	Column Description	Mandatory (Yes or No)
Sequence	Used to indicate the order in which the algorithm must be triggered.	Yes (Conditional)
		Note: This field is required when you are attaching an algorithm to the upload reason.

Column Name	Column Description	Mandatory (Yes or No)
Algorithm	Used to attach an algorithm to the upload reason. If the type of the upload reason is set to Success , you must attach the automatic payment success algorithm. However, if the type of the upload reason is set to Cancel , you must attach either automatic payment cancel or void automatic refund algorithm depending on whether the upload reason will be used for automatic payment or automatic refund cancelation.	Yes (Conditional)
	<p>Note:</p> <p>The Search (🔍) icon appears corresponding to this field. On clicking the Search icon, the Algorithm Code Search window appears.</p> <p>On specifying the algorithm code, the description of the algorithm appears corresponding to the Algorithm field.</p>	<p>Note: This field is required when you are attaching an algorithm to the upload reason.</p>

4. Enter the required details in the **Automatic Payment and Refund Upload Reason** screen.

Note: If you want to attach more than one algorithm to the upload reason, click the **Add** (+) icon and then specify the details. However, if you want to remove an algorithm from the upload reason, click the **Delete** (🗑️) icon corresponding to the algorithm.

5. Click **Save**.

The upload reason is defined.

Related Topics

For more information on...	See...
Automatic Payment and Refund Upload Reason screen	Automatic Payment and Refund Upload Reason on page 1377
Upload Reasons zone	Upload Reasons on page 1378

Editing an Upload Reason

Prerequisites

To edit an upload reason, you should have:

- Automatic payment success algorithm defined using the **C1-APAY-SUCC** algorithm type
- Automatic payment cancel algorithm defined using the **C1-APAY-CAN** algorithm type
- Void automatic refund algorithm defined using the **C1-AREF-VOID** algorithm type

Procedure

To edit an upload reason:

1. Click the **Admin** link in the **Application** toolbar.
A list appears.
2. From the **Admin** menu, select **A** and then click **Automatic Payment and Refund Upload Reason**.

The **Automatic Payment and Refund Upload Reason** screen appears.

- In the **Upload Reasons** zone, click the **Edit** (✎) icon in the **Edit** column corresponding to the upload reason whose details you want to edit.

The **Automatic Payment and Refund Upload Reason** screen appears. It contains the following fields:

Field Name	Field Description	Mandatory (Yes or No)
Upload Reason	Displays the upload reason.	Not applicable
Description	Used to specify the description for the upload reason.	Yes
Reason Type	Used to indicate the type of upload reason. The valid values are: <ul style="list-style-type: none"> Cancel — This type of upload reason indicates that you must cancel the automatic payment or refund in the system. In this case, the error code indicates the reason why the automatic payment is cancelled or the refund request is voided. Success — This type of upload reason indicates that you must freeze the automatic payment on the payment freeze date. If the error code is specified, it indicates that you must freeze the automatic payment, and at the same time notify user that the automatic payment is accepted with a Notice to Change (NOC). The NOC reason is stored as payment tender characteristic in the system. You can specify more than one error code (i.e. NOC reasons) with this type of upload reason. On freezing an automatic payment, the user is notified about these NOC reasons through a To Do entry. The system creates one To Do entry using the C1-ACH To Do type for all NOC reasons specified in the automatic payment clearing staging record. 	Yes
Eligible for Processing	Used to indicate whether the algorithms attached to the upload reason must be triggered while executing the Freeze or Cancel Automatic Payments (APAYRA) or Cancel Automatic Refunds (AREFRA) batch.	No

In addition, this screen contains a grid where you can attach algorithms to the upload reason. It contains the following columns:

Column Name	Column Description	Mandatory (Yes or No)
Sequence	Used to indicate the order in which the algorithm must be triggered.	Yes (Conditional)
		Note: This field is required when you are attaching an algorithm to the upload reason.

Column Name	Column Description	Mandatory (Yes or No)
Algorithm	Used to attach an algorithm to the upload reason. If the type of the upload reason is set to Success , you must attach the automatic payment success algorithm. However, if the type of the upload reason is set to Cancel , you must attach either automatic payment cancel or void automatic refund algorithm depending on whether the upload reason will be used for automatic payment or automatic refund cancelation.	Yes (Conditional)
	<p>Note:</p> <p>The Search (🔍) icon appears corresponding to this field. On clicking the Search icon, the Algorithm Code Search window appears.</p> <p>On specifying the algorithm code, the description of the algorithm appears corresponding to the Algorithm field.</p>	<p>Note: This field is required when you are attaching an algorithm to the upload reason.</p>

- Modify the required details in the **Automatic Payment and Refund Upload Reason** screen.

Note: If you want to attach more than one algorithm to the upload reason, click the **Add** (+) icon and then specify the details. However, if you want to remove an algorithm from the upload reason, click the **Delete** (🗑️) icon corresponding to the algorithm.

- Click **Save**.

The changes made to the upload reason are saved.

Related Topics

For more information on...	See...
Automatic Payment and Refund Upload Reason screen	Automatic Payment and Refund Upload Reason on page 1377
Upload Reasons zone	Upload Reasons on page 1378

Deleting an Upload Reason

Procedure

To delete an upload reason:

- Click the **Admin** link in the **Application** toolbar.
A list appears.
- From the **Admin** menu, select **A** and then click **Automatic Payment and Refund Upload Reason**.
The **Automatic Payment and Refund Upload Reason** screen appears.
- In the **Upload Reasons** zone, click the **Delete** (🗑️) icon in the **Delete** column corresponding to the upload reason that you want to delete.
A message appears confirming whether you want to delete the upload reason.
- Click **OK**.

The upload reason is deleted.

Related Topics

For more information on...	See...
Automatic Payment and Refund Upload Reason screen	Automatic Payment and Refund Upload Reason on page 1377
Upload Reasons zone	Upload Reasons on page 1378

Automatic Payment and Refund Clearing Staging

The **Automatic Payment and Refund Clearing Staging** screen allows you to search for automatic payment or refund clearing records using various search criteria. In addition, you can:

- View the automatic payment or refund clearing staging records associated to a clearing record
- View the upload reason and payment cancelation reason or NOC reason specified in the automatic payment clearing staging record
- View the upload reason and void status reason specified in the automatic refund clearing staging record
- View the characteristics of the automatic payment or refund clearing staging record
- Edit an automatic payment or refund clearing staging record
- Delete an automatic payment or refund clearing staging record

This screen contains the following zones:

- [Search Clearing Record](#) on page 1383
- [Associated Clearing Staging Records](#) on page 1385
- [Clearing Staging Upload Reasons](#) on page 1386
- [Clearing Staging Characteristics](#) on page 1387

Search Clearing Record

The **Search Clearing Record** zone allows you to search for automatic payment and refund clearing records using various search criteria. It contains the following two sections:

- **Search Criteria** — the **Search Criteria** section contains the following fields:

Field Name	Field Description	Mandatory (Yes or No)
Search By	Used to indicate whether you want to search for the automatic payment or refund clearing records. The valid values are: <ul style="list-style-type: none"> • Automatic Payment • Automatic Refund 	Yes
Clearing ID	Used to search a particular clearing record.	No

Field Name	Field Description	Mandatory (Yes or No)
Account ID	Used to search clearing records which are created for a particular account.	No
	Note: The Search (🔍) icon appears corresponding to this field. On clicking the Search icon, the Account Search window appears.	
Person Name	Used to search clearing records which are created for accounts of a particular person.	No
Extract From Date	Used to search clearing records that are extracted on or after a particular date.	No
Extract To Date	Used to search clearing records that are extracted on or before a particular date.	No
Bill ID	Used to search clearing records which are created against a bill.	No
Alternate Bill ID	Used to search clearing records which are created against a bill with the specified alternate bill ID.	No
Batch Control	Used to search clearing records where the APAYACH batch control is stamped. The valid value is APAYACH .	No
Batch Run Number	Used to search clearing records which are activated in a particular batch run.	No

Note: You must specify at least one search criterion while searching for a clearing record.

- **Search Results** — On clicking the **Search** button, the search results appear based on the specified search criteria. The **Search Results** section contains the following columns:

Column Name	Column Description
Clearing ID	Displays the clearing ID.
Account Information	Indicates the account for which the clearing record is created. In addition, this column has a context menu which helps in navigating to other screens in the application.
	Note: It has a link. On clicking the link, the Account screen appears with the details of the respective account.
Bill Information	Indicates the bill against which the clearing record is created. In addition, this column has a context menu which helps in navigating to other screens in the application.
	Note: It has a link. On clicking the link, the Bill screen appears with the details of the respective bill.
Payment Amount	Displays the payment amount.
	Note: This column appears only when you select the Automatic Payment option from the Search By list.

Column Name	Column Description
Pay Tender ID	Displays the payment tender ID.
	<p>Note:</p> <p>It has a link. On clicking the link, the Payment Event screen appears where you can view the details of the respective tender.</p> <p>This column appears when you select the Automatic Payment option from the Search By list.</p>
Tender Status	Indicates the current status of the payment tender. The valid values are: <ul style="list-style-type: none"> Valid Canceled
	Note: This column appears when you select the Automatic Payment option from the Search By list.
Extract Date	Displays the date when the clearing record is extracted in a flat file.
Payment Freeze Date	Displays the date when the automatic payment must be frozen in the system.
	Note: This column appears when you select the Automatic Payment option from the Search By list.
External Source ID	Indicates the tender source through which the payment was remitted.
Entity Type	Indicates the type of entity which is created for automatic refund. The valid value is: <ul style="list-style-type: none"> Refund Request
	Note: This column appears when you select the Automatic Refund option from the Search By list.
Entity ID	Displays the entity ID.
	Note: This column appears when you select the Automatic Refund option from the Search By list.
Account Number	Indicates the bank account through which the automatic payment is made.
Batch Control	Indicates the batch control which is stamped on the clearing record.
Batch Run Number	Indicates the batch run in which the clearing record was activated.
Alternate Bill ID	Indicates the bill against which the clearing record is created.

Related Topics

For more information on...	See...
How to search for a clearing record	Searching for a Clearing Record on page 1387

Associated Clearing Staging Records

The **Associated Clearing Staging Records** zone lists the automatic payment or refund clearing staging records which are added corresponding to the clearing record. You can edit and delete an automatic payment or refund clearing staging record through this zone. It contains the following columns:

Column Name	Column Description
Clearing Staging ID	Displays the clearing staging ID.
Clearing ID	Indicates the clearing record against which the clearing staging record is added.
Status	Indicates the status of the clearing staging record. The valid values are: <ul style="list-style-type: none"> • Pending • Complete • Error
Edit	On clicking the Edit (✎) icon, the Edit Clearing Staging Record screen appears where you can edit the details of the clearing staging record. Note: You can edit a clearing staging record when it is in the Pending or Error status.
Delete	On clicking the Delete (🗑) icon, you can delete the clearing staging record. Note: You can delete a clearing staging record when it is in the Pending status.

By default, the **Associated Clearing Staging Records** zone does not appear in the **Automatic Payment and Refund Clearing Staging** screen. It appears when you click the **Broadcast** (📡) icon corresponding to the clearing record in the **Search Clearing Record** zone.

Related Topics

For more information on...	See...
How to view the clearing staging records associated to a clearing record	Viewing the Clearing Staging Records Associated to a Clearing Record on page 1388
How to edit a clearing staging record	Editing a Clearing Staging Record on page 1389
How to delete a clearing staging record	Deleting a Clearing Staging Record on page 1392

Clearing Staging Upload Reasons

The **Clearing Staging Upload Reasons** zone lists the reason code (i.e. upload reason) and error code (i.e. payment cancellation reason, Notice to Change (NOC) reasons, or void status reason) specified in the automatic payment or refund clearing staging record. It contains the following columns:

Column Name	Column Description
Sequence	Indicates the sequence in which the upload reason should be considered while freezing or canceling the automatic payment or while canceling the automatic refund.
Clearing Staging ID	Displays the clearing staging ID.
Clearing ID	Indicates the clearing record against which the clearing staging record is added.
Upload Reason	Indicates whether the auto clearing house has accepted or rejected the clearing record.
Cancel Reason	Indicates the reason why the auto clearing house has rejected the clearing record. If the clearing record is created for an automatic payment, the payment cancellation reason appears in this column. However, if the clearing record is created for an automatic refund, the void status reason appears in this column.

Column Name	Column Description
NOC Reason	Indicates the reason why the auto clearing house has accepted the clearing record with a Notice to Change (NOC).
NOC Reason Description	Displays the description of the NOC reason.

By default, the **Clearing Staging Upload Reasons** zone does not appear in the **Automatic Payment and Refund Clearing Staging** screen. It appears when you click the **Broadcast** (📡) icon corresponding to the clearing staging record in the **Associated Clearing Staging Records** zone.

Related Topics

For more information on...	See...
How to view the upload reason specified in the clearing staging record	Viewing the Upload Reason Specified in the Clearing Staging Record on page 1388

Clearing Staging Characteristics

The **Clearing Staging Characteristics** zone lists the characteristics of the automatic payment or refund clearing staging record. It contains the following columns:

Column Name	Column Description
Clearing Staging ID	Displays the clearing staging ID.
Clearing ID	Indicates the clearing record against which the clearing staging record is added.
Characteristic Type	Indicates the characteristic type.
Characteristic Value	Displays the characteristic value.

By default, the **Clearing Staging Characteristics** zone does not appear in the **Automatic Payment and Refund Clearing Staging** screen. It appears when you click the **Broadcast** (📡) icon corresponding to the clearing staging record in the **Associated Clearing Staging Records** zone.

Related Topics

For more information on...	See...
How to view the characteristics of the clearing staging record	Viewing the Characteristics of the Clearing Staging Record on page 1389

Searching for a Clearing Record

Procedure

To search for a clearing record:

1. Click the **Menu** link in the **Application** toolbar.
A list appears.
2. From the **Main** menu, select **Payments** and then click **Automatic Payment and Refund Clearing Staging**.
The **Automatic Payment and Refund Clearing Staging** screen appears.
3. Enter the search criteria in the **Search Clearing Record** zone depending on whether you want to search for automatic payment or refund clearing records.

Note: ORMB search engine supports wildcard search, where you can substitute the percentage (%) symbol as a stand in for any word or letter in a search criteria. You can use the ‘%’ wildcard character in all input fields except the date and ID fields. The ‘%’ wildcard character is suffixed automatically at the end of the partial search criteria. Therefore, you may or may not specify the wildcard character at the end of the partial search criteria. However, you have to prefix the wildcard character manually wherever required.

4. Click **Search**.

A list of clearing records that meet the search criteria appears in the **Search Results** section.

Related Topics

For more information on...	See...
Automatic Payment and Refund Clearing Staging screen	Automatic Payment and Refund Clearing Staging on page 1383
Search Clearing Record zone	Search Clearing Record on page 1383

Viewing the Clearing Staging Records Associated to a Clearing Record

Procedure

To view the clearing staging records associated to a clearing record:

1. Search for the clearing record in the **Automatic Payment and Refund Clearing Staging** screen.
2. In the **Search Results** section, click the **Broadcast** (📡) icon corresponding to the clearing record whose associated clearing staging records you want to view.

The **Associated Clearing Staging Records** zone appears.

3. View the details of the clearing staging records in the **Associated Clearing Staging Records** zone.

Related Topics

For more information on...	See...
How to search for a clearing record	Searching for a Clearing Record on page 1387
Associated Clearing Staging Records zone	Associated Clearing Staging Records on page 1385

Viewing the Upload Reason Specified in the Clearing Staging Record

Procedure

To view the upload reason specified in the clearing staging record:

1. Search for the clearing record in the **Automatic Payment and Refund Clearing Staging** screen.
2. In the **Search Results** section, click the **Broadcast** (📡) icon corresponding to the clearing record whose associated clearing staging records you want to view.

The **Associated Clearing Staging Records** zone appears.

3. In the **Associated Clearing Staging Records** zone, click the **Broadcast** (📡) icon corresponding to the clearing staging record whose details you want to view.

The **Clearing Staging Upload Reasons** and **Clearing Staging Characteristics** zones appear.

- View the reason and error codes specified in the clearing staging record in the **Clearing Staging Upload Reasons** zone.

Related Topics

For more information on...	See...
How to search for a clearing record	Searching for a Clearing Record on page 1387
Associated Clearing Staging Records zone	Associated Clearing Staging Records on page 1385
Clearing Staging Upload Reasons zone	Clearing Staging Upload Reasons on page 1386

Viewing the Characteristics of the Clearing Staging Record

Procedure

To view the characteristics of the clearing staging record:

- Search for the clearing record in the **Automatic Payment and Refund Clearing Staging** screen.
- In the **Search Results** section, click the **Broadcast** () icon corresponding to the clearing record whose associated clearing staging records you want to view.

The **Associated Clearing Staging Records** zone appears.

- In the **Associated Clearing Staging Records** zone, click the **Broadcast** () icon corresponding to the clearing staging record whose details you want to view.

The **Clearing Staging Upload Reasons** and **Clearing Staging Characteristics** zones appear.

- View the characteristics of the clearing staging record in the **Clearing Staging Characteristics** zone.

Related Topics

For more information on...	See...
How to search for a clearing record	Searching for a Clearing Record on page 1387
Associated Clearing Staging Records zone	Associated Clearing Staging Records on page 1385
Clearing Staging Characteristics zone	Clearing Staging Characteristics on page 1387

Editing a Clearing Staging Record

Prerequisites

To edit a clearing staging record, you should have:

- Upload reasons defined in the application
- NOC reasons defined in the **APAY_UPL_NOC_LOOKUP** lookup field.
- Payment cancelation reasons defined in the application
- Reasons defined for the **Voided** status of the **C1-RefundReq** business object in the **Status Reason** screen

Note: You can edit a clearing staging record when it is in the **Pending** or **Error** status. On editing a clearing staging record which is in the **Error** status, the status of the clearing staging record is changed to **Pending**. Also, the exceptions logged for the clearing staging record are deleted from the **CI_APAY_STGUP_EXC** table.

Procedure

To edit a clearing staging record:

1. Search for the clearing record in the **Automatic Payment and Refund Clearing Staging** screen.
2. In the **Search Results** section, click the **Broadcast** () icon corresponding to the clearing record whose associated clearing staging record you want to edit.

The **Associated Clearing Staging Records** zone appears.

3. In the **Associated Clearing Staging Records** zone, click the **Edit** () icon in the **Edit** column corresponding to the clearing staging record whose details you want to edit.

The **Edit Clearing Staging Record** screen appears. It contains the following fields:

Field Name	Field Description	Mandatory (Yes or No)
Clearing Staging ID	Displays the clearing staging ID.	Not applicable
Clearing ID	Indicates the clearing record against which the clearing staging record is added.	Not applicable
Status	Indicates the status of the clearing staging record. The valid values are: <ul style="list-style-type: none"> • Pending • Complete • Error 	Not applicable
Upload Date	Used to specify the date when the clearing staging record was uploaded or added in the system.	Yes

In addition, this screen contains the following two sections:

- **Upload Reasons** — Used to add, edit, or remove the reason code (i.e. upload reason) and error (sub reason) codes from the clearing staging record. It contains the following fields in a grid:

Field Name	Field Description	Mandatory (Yes or No)
Upload Reason	Used to specify the upload reason. It indicates whether the auto clearing house has accepted or rejected the clearing record.	Yes
Reason Type	Used to indicate the type of upload reason. The valid values are: <ul style="list-style-type: none"> • Cancel • Success 	Yes

Field Name	Field Description	Mandatory (Yes or No)
Sub Reason Code	Used to specify either of the following: <ul style="list-style-type: none"> Payment cancelation reason or void status reason (for automatic refund) when the reason type is set to Cancel Notice to Change (NOC) reason when the reason type is set to Success 	No
Sub Reason Description	Used to specify the description of the NOC reason.	No

Note: The upload reason, payment cancelation reason, void status reason, and NOC reasons must be already defined in the system. If you specify an invalid reason and sub reason codes, the status of the clearing staging record is changed to **Error** when you execute the **Freeze or Cancel Automatic Payments (APAYRA)** or **Cancel Automatic Refunds (AREFRA)** batch.

- **Characteristics** — Used to define the characteristics for the clearing staging record.
4. Modify the required details in the **Edit Clearing Staging Record** screen.

Note: If you want to add more than one reason or sub reason code, click the **Add (+)** icon in the **Upload Reasons** section and then specify the required details. However, if you want to remove a reason or sub reason code, click the **Delete (🗑)** icon corresponding to the reason.

5. Define characteristics for the clearing staging record, if required.
6. Click **Save**.

The changes made to the clearing staging record are saved.

Related Topics

For more information on...	See...
How to search for a clearing record	Searching for a Clearing Record on page 1387
Associated Clearing Staging Records zone	Associated Clearing Staging Records on page 1385
How to define a characteristic for a clearing staging record	Defining a Characteristic for a Clearing Staging Record on page 1391

Defining a Characteristic for a Clearing Staging Record

Prerequisites

To define a characteristic for a clearing staging record, you should have:

- Characteristic types defined in the application (where the characteristic entity is set to **Auto Payment Upload**)

Procedure

To define a characteristic for a clearing staging record:

1. Ensure that the **Characteristics** section is expanded when you are editing a clearing staging record.

The **Characteristics** section contains the following fields in a grid:

Field Name	Field Description	Mandatory (Yes or No)
Effective Date	Used to specify the date from when the characteristic is effective for the clearing staging record.	Yes (Conditional)
		Note: This field is required when you are defining a characteristic for the clearing staging record.
Characteristic Type	Used to indicate the characteristic type. Note: The list includes only those characteristic types where the characteristic entity is set to Auto Payment Upload .	Yes (Conditional)
		Note: This field is required when you are defining a characteristic for the clearing staging record.
Characteristic Value	Used to specify the value for the characteristic type. Note: On specifying the value for a predefined characteristic type, the description of the characteristic value appears corresponding to the Characteristic Value field.	Yes (Conditional)
		Note: This field is required when you are defining a characteristic for the clearing staging record.

- Enter the required details in the **Characteristics** section.

Note: If you select a predefined characteristic type, the **Search** (🔍) icon appears corresponding to the **Characteristic Value** field. On clicking the **Search** icon, you can search for a predefined characteristic value.

- If you want to define more than one characteristic for the clearing staging record, click the **Add** (+) icon and then repeat step 2.

Note: However, if you want to remove a characteristic from the clearing staging record, click the **Delete** (🗑️) icon corresponding to the characteristic.

Related Topics

For more information on...	See...
How to edit a clearing staging record	Editing a Clearing Staging Record on page 1389

Deleting a Clearing Staging Record

Procedure

To delete a clearing staging record:

- Search for the clearing record in the **Automatic Payment and Refund Clearing Staging** screen.
- In the **Search Results** section, click the **Broadcast** (📡) icon corresponding to the clearing record whose associated clearing staging record you want to delete.

The **Associated Clearing Staging Records** zone appears.

- In the **Associated Clearing Staging Records** zone, click the **Delete** (🗑️) icon in the **Delete** column corresponding to the clearing staging record that you want to delete.

A message appears confirming whether you want to delete the clearing staging record.

Note: You can delete a clearing staging record when it is in the **Pending** status.

4. Click **OK**.

The clearing staging record is deleted.

Related Topics

For more information on...	See...
How to search for a clearing record	Searching for a Clearing Record on page 1387
Associated Clearing Staging Records zone	Associated Clearing Staging Records on page 1385

Chapter 17

Trial Billing

Topics:

- [Prerequisites](#)
- [Trial Bill \(Used for Searching\)](#)
- [Trial Bill \(Used for Viewing\)](#)

Oracle Revenue Management and Billing facilitates you to generate trial bills before actual bill is generated for an account. This helps to review the trial bill and make the required corrections before the actual bill is generated. The Trial Billing feature is currently designed and developed for open item accounting and not for balance forward accounting.

The process of trial and actual billing is identical. The only difference is that you cannot freeze and complete the trial bills. Also, during trial billing, the account balance is not updated. It is updated when the actual bill is generated. You can generate trial bill only in case of regular billing, and not in case of adhoc billing. The trial bills can be generated only through the batch process. To generate trial bills, you need to execute the following batches in the specified order:

1. **Pending Bill Generation (C1-PNDBL)** – This batch is used to generate pending trial or actual bills for accounts that meet the criteria.
2. **Bill Segment Generation (C1-BLGEN)** – This batch is used to generate bill segments for pending trial or actual bills.
3. **Bill Completion (C1-BLPPR)** – This batch is used to generate post-processing bill segments in the pending trial or actual bills during the bill completion process. The adjustments, if any, created on the accounts are swept onto the pending trial or actual bills. In addition, the bill routing information and bill messages are stamped on the pending trial or actual bills. If the adjustment currency is different from the account's invoice currency, the transfer adjustment is created on the pending actual bill. However, in case of pending trial bill, the currency conversion for adjustments is done, but the transfer adjustments are not created. Finally, the status of the actual bill is set to **Complete**, whereas the status of the trial bill remains as **Pending**.

Note: The adjustments which are in the **Freezable** status are not swept onto the trial bills. Only adjustments which are in the **Frozen** status are swept onto the trial bills.

The **Trial Bill** check box is added in the **Main** tab of the **Account** screen. If you leave the **Process All or Selected Accounts** parameter blank while executing the above batches, all accounts (that meet the criteria) irrespective of whether the **Trial Bill** check box is selected or not are considered for generating the trial bills. However, if the **Process All or Selected Accounts** parameter is set to **Y**, then only those accounts that meet the criteria and where the **Trial Bill** check box is selected are considered for generating the trial bills.

You can create an actual bill using a trial bill. While creating actual bills using trial bills, you need to specify the trial billing batch run number whose trial bills

you want to convert to the actual bills. To create actual bills using trial bills, you need to execute the following batches in the specified order:

1. **Pending Bill Generation (C1-PNDBL)** - This batch generates pending actual bill for accounts that meet the criteria.
2. **Bill Segment Generation (C1-BLGEN)** – This batch copies regular bill segments which are generated for the trial bill and stamps them onto the pending actual bill. It also copies the corresponding financial transactions (FTs).
3. **Bill Completion (C1-BLPPR)** – This batch copies post-processing bill segments which are generated for the trial bill and stamps them onto the pending actual bill. The bill routing information and bill messages are copied from the trial bill to the pending actual bill. The adjustment, if any, created on the account are swept onto the pending actual bill. They are not copied from the respective trial bill. If the adjustment currency is different from the account’s invoice currency, the transfer adjustment is created on the pending actual bill. Finally, the status of the actual bill is set to **Complete**.

The actual bill ID, bill segment ID and FT ID are different from the trial bill ID, bill segment ID and FT ID, respectively. If an actual bill is created using a trial bill, the system will stamp the trial bill ID on the actual bill. This helps you to track the trial bill of an actual bill.

The system allows you to view a trial bill through a user interface. It also allows you to print the trial bill in the PDF format. You can print a trial bill when Oracle Documaker is integrated with Oracle Revenue Management and Billing. For more information about the batches, see *Oracle Revenue Management and Billing Batch Guide*.

Prerequisites

To setup the trial billing feature, you need to do the following:

- Set the **Trial Bill Characteristics Conversion** option type of the **C1_FINTRANOP** feature configuration.

Related Topics

For more information on...	See...
How to setup the C1_FINTRANOP feature configuration	Setting the C1_FINTRANOP Feature Configuration on page 3450

Trial Bill (Used for Searching)

The **Trial Bill** screen allows you to search for a trial bill using various search criteria. It contains the following zone:

- [Search Trial Bill](#) on page 1397

Through this screen, you can navigate to the following screen:

- [Trial Bill \(Used for Viewing\)](#) on page 1400

Search Trial Bill

The **Search Trial Bill** zone allows you to search for trial bills using various search criteria. It contains the following two sections:

- **Search Criteria** — The criteria are grouped as indicated by line separators between the criteria. Each group is independent from the other, and only one group is used at a time for searching. If you enter criteria in more than one group, the criteria from the first group is used for searching. For example, if you enter the criteria in the Account ID and Trial Bill Description fields (which are in different criteria groups), the system searches for trial bills using the account ID. The **Search Criteria** section contains the following fields:

Field Name	Field Description	Mandatory (Yes or No)
Search By	Used to indicate whether you want to search for a trial bill using the trial bill details. The valid value is: <ul style="list-style-type: none"> • Trial Bill Details <p>Note: By default, the Trial Bill Details option is selected.</p>	Yes
Person ID	Used to search trial bills which are generated for a particular person. <p>Note: The Search (🔍) icon appears corresponding to this field. On clicking the Search icon, the Person Search window appears.</p>	No
Trial Bill ID	Used to search for a particular trial bill.	No

Field Name	Field Description	Mandatory (Yes or No)
Account ID	Used to search trial bills which are generated for a particular account.	No
	Note: The Search (🔍) icon appears corresponding to this field. On clicking the Search icon, the Account Search window appears.	
Division	Used to search trial bills which are generated for accounts belonging to a particular division.	No
From Trial Bill Date	Used to search trial bills which are generated from a particular date onwards.	No
Invoice Currency	Used to search trial bills which are generated in a particular invoice currency.	No
To Trial Bill Date	Used to search trial bills which are generated till a particular date.	No
Batch Run Date	Used to search trial bills which are generated on a particular batch run date.	No
Trial Bill Description	Used to search trial bills which are generated in a particular batch run.	Yes (Conditional)
		Note: This field is required when you are searching for trial bills using the batch run date.

Note: You must specify at least one search criterion while searching for a trial bill.

- **Search Results** — On clicking the **Search** button, the search results appear based on the specified search criteria. The **Search Results** section contains the following columns:

Column Name	Column Description
Trial Bill Information	Displays additional information about the trial bill.
	Note: It has a link. On clicking the link, the Trial Bill screen appears where you can view the details of the respective trial bill.
Current Charges	Displays the trial bill amount.
Account Information	Indicates the account for which the trial bill is generated. In addition, this column has a context menu which helps in navigating to other screens in the application.
	Note: It has a link. On clicking the link, the Account screen appears with the details of the respective account.
Person Name	Indicates the person for whom the trial bill is generated.
Division	Indicates the division to which the account belongs.
Batch Run Date	Displays the date when the batch is executed to generate the trial bill.
Batch Run Number	Indicates the batch run in which the trial bill is generated.

Related Topics

For more information on...	See...
How to search for a trial bill	Searching for a Trial Bill on page 1399
How to view the details of a trial bill	Viewing the Trial Bill Details on page 1399

Searching for a Trial Bill

Prerequisites

To search for a trial bill, you should have:

- Divisions and currencies defined in the application

Procedure

To search for a trial bill:

1. Click the **Menu** link in the **Application** toolbar.
A list appears.
2. From the **Main** menu, select **Billing Management** and then click **Trial Bill**.
The **Trial Bill** screen appears.
3. Enter the search criteria in the **Search Trial Bill** zone.

Note: ORMB search engine supports wildcard search, where you can substitute the percentage (%) symbol as a stand in for any word or letter in a search criteria. You can use the ‘%’ wildcard character in all input fields except the date and ID fields. The ‘%’ wildcard character is suffixed automatically at the end of the partial search criteria. Therefore, you may or may not specify the wildcard character at the end of the partial search criteria. However, you have to prefix the wildcard character manually wherever required.

4. Click **Search**.
A list of trial bills that meet the search criteria appears in the **Search Results** section.

Related Topics

For more information on...	See...
Trial Bill screen	Trial Bill (Used for Searching) on page 1397
Search Trial Bill zone	Search Trial Bill on page 1397

Viewing the Trial Bill Details

Procedure

To view the details of a trial bill:

1. Search for the trial bill in the **Trial Bill** screen.
2. In the **Search Results** section, click the link in the **Trial Bill Information** column corresponding to the trial bill whose details you want to view.
The **Trial Bill** screen appears.
3. View the basic details of the trial bill in the **Trial Bill** zone.
4. View the segments of the trial bill in the **Trial Bill Segments** zone.
5. View the calc lines of a trial bill segment in the **Trial Bill Segment Calc Lines** zone.

6. View the service quantity details of a trial bill segment in the **Trial Bill Segment SQ Details** zone.
7. View the financial details of a trial bill segment in the **Trial Bill Segment Financial Details** zone.

Related Topics

For more information on...	See...
How to search for a trial bill	Searching for a Trial Bill on page 1399
Trial Bill screen	Trial Bill (Used for Viewing) on page 1400
Trial Bill zone	Trial Bill on page 1400
Trial Bill Segments zone	Trial Bill Segments on page 1402
Trial Bill Segment Calc Lines zone	Trial Bill Segment Calc Lines on page 1403
Trial Bill Segment SQ Details zone	Trial Bill Segment SQ Details on page 1404
Trial Bill Segment Financial Details zone	Trial Bill Segment Financial Details on page 1405
How to view the segments of a trial bill	Viewing the Segments of a Trial Bill on page 1406
How to view the calc lines of a trial bill segment	Viewing the Calc Lines of a Trial Bill Segment on page 1407
How to view the service quantity details of a trial bill segment	Viewing the SQ Details of a Trial Bill Segment on page 1408
How to view the financial details of a trial bill segment	Viewing the Financial Details of a Trial Bill Segment on page 1408



Trial Bill (Used for Viewing)

The **Trial Bill** screen allows you to:

- View the details of a trial bill, such as the trial bill summary, trial bill messages, and trial bill characteristics
- View the segments of a trial bill
- View the calculation lines, service quantity details, and financial details of a trial bill segment
- View the details of the policy, plan, and membership for which a trial bill segment is created

It contains the following zones:

- [Trial Bill](#) on page 1400
- [Trial Bill Segments](#) on page 1402
- [Trial Bill Segment Calc Lines](#) on page 1403
- [Trial Bill Segment SQ Details](#) on page 1404
- [Trial Bill Segment Financial Details](#) on page 1405
- [Policy Details](#) on page 1405

Trial Bill

The **Trial Bill** zone displays the details of the trial bill. It contains the following sections:

- **Main** — This section provides basic information about the trial bill. It contains the following fields:

Field Name	Field Description
Trial Bill ID	Displays the trial bill ID.
Trial Bill Information	Displays additional information about the trial bill.
Trial Bill Description	Displays the description of the batch run in which the trial bill is generated.
Account Information	Indicates the account for which the trial bill is generated. In addition, a context menu appears corresponding to this field which helps in navigating to other screens in the application. Note: It has a link. On clicking the link, the Account screen appears where you can view the details of the respective account.

- **Trial Bill Summary** — This section summarizes the financial impact of the bill. It contains the following fields:

Field Name	Field Description
New Charges	Displays the total amount of frozen bill segment financial transactions which are linked to the trial bill.
Adjustments	Displays the total amount of frozen and/or canceled adjustment financial transactions which are linked to the trial bill.
Corrections	Displays the total amount of canceled and/or rebilled bill segment financial transactions which are linked to the trial bill.
Total	Displays the sum of new charges, adjustments, and corrections.
No. of Bill Segments in Error	Indicates the number of bill segments in the trial bill which are in the Error status.

- **Trial Bill Messages** — This section lists the bill messages that are stamped on the trial bill. It contains the following columns:

Column Name	Column Description
Message Code	Displays the code that uniquely identifies the bill message.
Message on Bill	Displays the bill message.
Priority	Indicates the priority which determines the order in which the bill message must be printed on the trial bill.
Insert Code	Indicates whether the bill message must be sent separately along with the trial bill.

- **Characteristics** — This section lists characteristics of the trial bill. It contains the following columns:

Column Name	Column Description
Characteristic Type	Indicates the characteristic type.
Characteristic Value	Displays the value of the characteristic type.

In addition, this zone contains a button named **Display Trial Bill** which allows you to print a trial bill in the PDF format.

Related Topics

For more information on...	See...
How to print a trial bill in the PDF format	Printing a Trial Bill in the PDF Format on page 1406

Trial Bill Segments

The **Trial Bill Segments** zone lists the segments of the trial bill. You can filter the trial bill segments using various search criteria. This zone contains the following two sections:

- **Search Criteria** - The **Search Criteria** section contains the following fields:

Field Name	Field Description	Mandatory (Yes or No)
Account ID	Used to search trial bill segments which are generated for a particular usage account.	No
	Note: The Search (🔍) icon appears corresponding to this field. On clicking the Search icon, the Account Search window appears.	
Contract Type	Used to search trial bill segments which are generated against a particular type of contract.	No
	Note: The Search (🔍) icon appears corresponding to this field. On clicking the Search icon, the Contract Type Search window appears.	
Trial Bill Segment Type	Used to search for a particular type of trial bill segments. The valid values are: <ul style="list-style-type: none"> • Post Processing • Regular 	No
Price Item	Used to search trial bill segments which are generated for a particular price item.	No
	Note: The Search (🔍) icon appears corresponding to this field. On clicking the Search icon, the Price Item Search window appears.	
Trial Bill Segment Status	Used to search trial bill segments in a particular status. The valid values are: <ul style="list-style-type: none"> • Error • Freezable 	No

- **Search Results** - On clicking the **Search** button, the search results are filtered based on the specified search criteria. The **Search Results** section contains the following columns:

Column Name	Column Description
Trial Bill Segment ID	Displays the trial bill segment ID.
Status	Indicates the status of the trial bill segment. The valid values are: <ul style="list-style-type: none"> • Error • Freezable
Start Date	Displays the start date of the trial bill segment.

Column Name	Column Description
End Date	Displays the end date of the trial bill segment.
Calculated Amount (Pricing Currency)	Displays the trial bill segment amount in the pricing currency.
Price Item	Indicates the price item for which the trial bill segment is generated.
Pricing Parameters	Indicates the price item parameters which are used along with the price item for determining the price item pricing.
Rate Schedule	Indicates the rate schedule which is used for defining the price item pricing.
Price Assignment ID	Indicates the price item pricing which is used during calculation.
Billable Charge ID	Indicates the billable charge for which the trial bill segment is generated.
	Note: It has a link. On clicking the link, the Billable Charge screen appears where you can view the details of the respective billable charge.
Construct ID	Indicates the construct through which the trial bill segment is generated.
	Note: It has a link. On clicking the link, the Construct screen appears where you can view the details of the respective construct.

On clicking the **Broadcast** (📡) icon corresponding to the trial bill segment, the **Trial Bill Segment Calc Lines**, **Trial Bill Segment SQ Details**, **Trial Bill Segment Financial Details**, and **Policy Details** zones appear with the details of the respective trial bill segment.

Related Topics

For more information on...	See...
How to view the segments of a trial bill	Viewing the Segments of a Trial Bill on page 1406
Trial Bill Segment Calc Lines zone	Trial Bill Segment Calc Lines on page 1403
Trial Bill Segment SQ Details zone	Trial Bill Segment SQ Details on page 1404
Trial Bill Segment Financial Details zone	Trial Bill Segment Financial Details on page 1405
Policy Details zone	

Trial Bill Segment Calc Lines

The **Trial Bill Segment Calc Lines** zone lists the calculation lines which indicate how the system calculated the trial bill segment amount. It contains the following columns:

Column Name	Column Description
Sequence No.	Indicates the sequence in which the calculation line is created while calculating the trial bill segment amount.
Description on Bill	Displays the summarized information about the calculation line that will be printed on the trial bill.
Calculated Amount (Pricing Currency)	Displays the calculated charge amount associated with the calculation line in the pricing currency.
Calculated Amount (Invoice Currency)	Displays the calculated charge amount associated with the calculation line in the invoice currency.

Column Name	Column Description
Print	Indicates whether information about the calculation line will be printed on the person's trial bill. The valid values are: <ul style="list-style-type: none"> • Yes • No
Appears in Summary	Indicates whether the calculation line amount will appear in the summary of the trial bill. The valid values are: <ul style="list-style-type: none"> • Yes • No
Exchange Rate	Indicates the exchange rate which is used when the invoice currency is different from the pricing currency.
Price Component ID	Indicates the price component which is used during calculation.
Service Quantity Identifier	Indicates the service quantity identifier (SQI) of the service quantity which is priced on the calculation line.
Billable Service Quantity	Displays the SQI value used by the rates engine for calculation.
Base Amount	Displays the total amount derived from the cross-referenced lines that the current line then used to calculate the charge amount.
Rate Component Sequence	Indicates the sequence of the rate component on the effective rate version which is used while calculating the line.
Exempt Amount	Displays the amount of the calculated charge that the person does not have to pay due to tax exemption.
Distribution Code	Indicates the distribution code associated with the rate component.

By default, the **Trial Bill Segment Calc Lines** zone does not appear in the **Trial Bill** screen. It appears when you click the **Broadcast** () icon corresponding to the trial bill segment in the **Trial Bill Segment** zone.

Related Topics

For more information on...	See...
How to view the calc lines of a trial bill segment	Viewing the Calc Lines of a Trial Bill Segment on page 1407

Trial Bill Segment SQ Details

The **Trial Bill Segment SQ Details** zone lists the service quantity identifiers associated with the contract against which the trial bill segment is created. It contains the following columns:

Column Name	Column Description
SQI	Indicates the service quantity identifier.
Billable Service Quantity	Displays the SQI value used by the rates engine for calculation.

By default, the **Trial Bill Segment SQ Details** zone does not appear in the **Trial Bill** screen. It appears when you click the **Broadcast** () icon corresponding to the trial bill segment in the **Trial Bill Segment** zone.

Related Topics

For more information on...	See...
How to view the service quantity details of a trial bill segment	Viewing the SQ Details of a Trial Bill Segment on page 1408

Trial Bill Segment Financial Details

The **Trial Bill Segment Financial Details** zone lists the distribution codes which indicate the GL accounts that will be affected by the trial bill segment financial transaction. It contains the following columns:

Column Name	Column Description
Sequence No.	Indicates the sequence in which the distribution code will be considered for deriving the GL account.
Distribution Code	Indicates the distribution code associated with the rate component used for calculating the trial bill segment amount.
Amount	Displays the amount that will be debited or credited to the GL account.

By default, the **Trial Bill Segment Financial Details** zone does not appear in the **Trial Bill** screen. It appears when you click the **Broadcast** (📡) icon corresponding to the trial bill segment in the **Trial Bill Segment** zone.

Related Topics

For more information on...	See...
How to view the financial details of a trial bill segment	Viewing the Financial Details of a Trial Bill Segment on page 1408

Policy Details

The **Policy Details** zone lists the policy, plan, and membership for which the trial bill segment is created. It contains the following columns:

Column Name	Column Description
Policy Information	Displays the information about the policy. Note: It has a link. On clicking the link, the Policy screen appears where you can view the details of the respective policy.
External Membership ID	Indicates the membership in which the member is included.
Member's Primary Identifier	Displays the concatenated string consisting of primary identifier type and primary identifier of the member which are separated by a colon (:).
Member Name	Indicates the member for whom the trial bill segment is generated.
Plan Information	Displays information about the policy plan. Note: It has a link. On clicking the link, the Policy Plan screen appears where you can view the details of the respective policy plan.

By default, the **Policy Details** zone does not appear in the **Trial Bill** screen. It appears when you click the **Broadcast** (📡) icon corresponding to the trial bill segment in the **Trial Bill Segment** zone.

Related Topics

For more information on...	See...
How to view the policy details of a trial bill segment	Viewing the Policy Details of a Trial Bill Segment on page 1409

Printing a Trial Bill in the PDF Format

Prerequisites

To print a trial bill in the PDF format, you should have:

- Oracle Documaker integrated with Oracle Revenue Management and Billing

Procedure

To print a trial bill in the PDF format:

1. Search for the trial bill in the **Trial Bill** screen.
2. In the **Search Results** section, click the link in the **Trial Bill Information** column corresponding to the trial bill that you want to print in the PDF format.

The **Trial Bill** screen appears.

3. Click the **Display Trial Bill** button in the **Trial Bill** zone.

The trial bill is printed in the PDF format.

Related Topics

For more information on...	See...
How to search for a trial bill	Searching for a Trial Bill on page 1399
Trial Bill screen	Trial Bill (Used for Viewing) on page 1400
Trial Bill zone	Trial Bill on page 1400

Viewing the Segments of a Trial Bill

Procedure

To view the segments of a trial bill:

1. Search for the trial bill in the **Trial Bill** screen.
2. In the **Search Results** section, click the link in the **Trial Bill Information** column corresponding to the trial bill whose details you want to view.

The **Trial Bill** screen appears.

3. View the segments of the trial bill in the **Trial Bill Segments** zone.
4. If required, you can filter the trial bill segments using various search criteria.

Related Topics

For more information on...	See...
How to search for a trial bill	Searching for a Trial Bill on page 1399
Trial Bill screen	Trial Bill (Used for Viewing) on page 1400
Trial Bill Segments zone	Trial Bill Segments on page 1402

For more information on...	See...
How to filter the trial bill segments	Filtering the Trial Bill Segments on page 1407

Filtering the Trial Bill Segments

Prerequisites

To filter the trial bill segments, you should have:

- Usage accounts, contract types, and price items defined in the application

Procedure

To filter the trial bill segments:

1. Search for the trial bill in the **Trial Bill** screen.
2. In the **Search Results** section, click the link in the **Trial Bill Information** column corresponding to the trial bill whose details you want to view.

The **Trial Bill** screen appears.

3. Enter the search criteria in the **Trial Bill Segments** zone.

Note: ORMB search engine supports wildcard search, where you can substitute the percentage (%) symbol as a stand in for any word or letter in a search criteria. You can use the ‘%’ wildcard character in all input fields except the date and ID fields. The ‘%’ wildcard character is suffixed automatically at the end of the partial search criteria. Therefore, you may or may not specify the wildcard character at the end of the partial search criteria. However, you have to prefix the wildcard character manually wherever required.

4. Click **Search**.

The search results are filtered based on the specified criteria.

Related Topics

For more information on...	See...
How to search for a trial bill	Searching for a Trial Bill on page 1399
Trial Bill screen	Trial Bill (Used for Viewing) on page 1400
Trial Bill Segments zone	Trial Bill Segments on page 1402

Viewing the Calc Lines of a Trial Bill Segment

Procedure

To view the calc lines of a trial bill segment:

1. Search for the trial bill in the **Trial Bill** screen.
2. In the **Search Results** section, click the link in the **Trial Bill Information** column corresponding to the trial bill whose details you want to view.

The **Trial Bill** screen appears.

3. If required, you can filter the trial bill segments in the **Trial Bill Segments** zone.
4. In the **Search Results** section, click the **Broadcast** (📡) icon corresponding to the trial bill segment whose details you want to view.

The **Trial Bill Segment Calc Lines**, **Trial Bill Segment SQ Details**, and **Trial Bill Segment Financial Details** zones appear.

- View the calc lines of the trial bill segment in the **Trial Bill Segment Calc Lines** zone.

Related Topics

For more information on...	See...
How to search for a trial bill	Searching for a Trial Bill on page 1399
Trial Bill screen	Trial Bill (Used for Viewing) on page 1400
How to filter the trial bill segments	Filtering the Trial Bill Segments on page 1407
Trial Bill Segment Calc Lines zone	Trial Bill Segment Calc Lines on page 1403

Viewing the SQ Details of a Trial Bill Segment

Procedure

To view the service quantity details of a trial bill segment:

- Search for the trial bill in the **Trial Bill** screen.
- In the **Search Results** section, click the link in the **Trial Bill Information** column corresponding to the trial bill whose details you want to view.

The **Trial Bill** screen appears.

- If required, you can filter the trial bill segments in the **Trial Bill Segments** zone.
- In the **Search Results** section, click the **Broadcast** (📡) icon corresponding to the trial bill segment whose details you want to view.

The **Trial Bill Segment Calc Lines**, **Trial Bill Segment SQ Details**, and **Trial Bill Segment Financial Details** zones appear.

- View the service quantity details of the trial bill segment in the **Trial Bill Segment SQ Details** zone.

Related Topics

For more information on...	See...
How to search for a trial bill	Searching for a Trial Bill on page 1399
Trial Bill screen	Trial Bill (Used for Viewing) on page 1400
How to filter the trial bill segments	Filtering the Trial Bill Segments on page 1407
Trial Bill Segment SQ Details zone	Trial Bill Segment SQ Details on page 1404

Viewing the Financial Details of a Trial Bill Segment

Procedure

To view the financial details of a trial bill segment:

- Search for the trial bill in the **Trial Bill** screen.

2. In the **Search Results** section, click the link in the **Trial Bill Information** column corresponding to the trial bill whose details you want to view.

The **Trial Bill** screen appears.

3. If required, you can filter the trial bill segments in the **Trial Bill Segments** zone.

4. In the **Search Results** section, click the **Broadcast** () icon corresponding to the trial bill segment whose details you want to view.

The **Trial Bill Segment Calc Lines**, **Trial Bill Segment SQ Details**, and **Trial Bill Segment Financial Details** zones appear.

5. View the financial details of the trial bill segment in the **Trial Bill Segment Financial Details** zone.

Related Topics

For more information on...	See...
How to search for a trial bill	Searching for a Trial Bill on page 1399
Trial Bill screen	Trial Bill (Used for Viewing) on page 1400
How to filter the trial bill segments	Filtering the Trial Bill Segments on page 1407
Trial Bill Segment Financial Details zone	Trial Bill Segment Financial Details on page 1405

Viewing the Policy Details of a Trial Bill Segment

Procedure

To view the policy details of a trial bill:

1. Search for the trial bill in the **Trial Bill** screen.
2. In the **Search Results** section, click the link in the **Trial Bill Information** column corresponding to the trial bill whose details you want to view.

The **Trial Bill** screen appears.

3. If required, you can filter the trial bill segments in the **Trial Bill Segments** zone.

4. In the **Trial Bill Segments** zone, click the **Broadcast** () icon corresponding to the trial bill segment whose policy details you want to view.

The **Trial Bill Segment Calc Lines**, **Trial Bill Segment SQ Details**, **Trial Bill Segment Financial Details**, and **Policy Details** zones appear.

5. View the policy details of the trial bill segment in the **Policy Details** zone.

Related Topics

For more information on...	See...
How to search for a trial bill	Searching for a Trial Bill on page 1399
Trial Bill screen	Trial Bill (Used for Viewing) on page 1400
Trial Bill Segments zone	Trial Bill Segments on page 1402
How to filter the trial bill segments	Filtering the Trial Bill Segments on page 1407
Trial Bill Calc Lines zone	Trial Bill Segment Calc Lines on page 1403

For more information on...	See...
Trial Bill SQ Details zone	<i>Trial Bill Segment SQ Details</i> on page 1404
Trial Bill Segment Financial Details zone	<i>Trial Bill Segment Financial Details</i> on page 1405
Policy Details zone	<i>Policy Details</i> on page 1405

Chapter 18

GL Account Validation

Topics:

- [Static GL Account Validation](#)
- [Dynamic GL Account Validation](#)

Oracle Revenue Management and Billing allows you to validate the GL account statically and dynamically. The static GL account validation means you can validate the GL account while creating or editing a distribution code. And, the dynamic GL account validation means you can validate the GL account while assigning it to trial and actual financial transactions through the batch process.

For more information about static GL account validation and dynamic GL account validation, refer to [Static GL Account Validation](#) on page 1412 and [Dynamic GL Account Validation](#) on page 1412, respectively.

Static GL Account Validation

If you want to validate the GL account while creating or editing a distribution code, you need to select the **Validate GL Account** check box in the **Distribution Code** screen. If the GL account is valid, the following string appears below the check box while saving the distribution code:

“GL Account is validated on YYYY-MM-DD”

And, if the GL account is invalid, the following string appears below the check box while saving the distribution code:

“GL Account is invalid”

If you want to enable the static GL account validation feature on the **Distribution Code** screen, you need to define an algorithm of the **C1-GLVAL** or **C1-GLVAL-COB** algorithm type and attach the algorithm to the **GL Account Validation** system event in the **Algorithms** tab of the **Installation Options – Framework** screen. Both these algorithm types have one parameter named **GL Account Length**. You need to set the value of this parameter while creating the algorithm using the **C1-GLVAL** or **C1-GLVAL-COB** algorithm type. If you attach an algorithm of the **C1-GLVAL** algorithm type, the system checks whether the length of GL account is greater than or equal to the value defined in the **GL Account Length** parameter. If the length is greater than or equal to the specified length, the GL account is considered as valid. And, if the length is less than the specified length, the GL account is considered as invalid.

And, if you attach an algorithm of the **C1-GLVAL-COB** algorithm type, the system checks whether the length of GL account is equal to the value defined in the **GL Account Length** parameter. If the length is equal to the specified length, the GL account is considered as valid. And, if the length is less than or greater than the specified length, the GL account is considered as invalid.

Dynamic GL Account Validation

If you want to validate GL account while assigning it to trial and actual financial transactions, you need to set the **Validate GL Account** parameter to **Y** while executing the batch. If the GL account is valid, the date when the GL account is validated is added in the **GLA_VAL_DT** column of the **CI_TRL_FT_GL** or **CI_FT_GL** table, respectively, depending on whether the GL account is assigned to a trial or actual financial transaction.

If you want to enable the dynamic GL account validation feature in the **C1-GLASN** or **GLASSGN2** batch, you need to define an algorithm of the **C1-GLVAL** or **C1-GLVAL-COB** algorithm type and attach the algorithm to either of the following:

- The **GL Account Validation** algorithm entity in the **Algorithms** tab of the **Division** screen
- The **GL Account Validation** system event in the **Algorithms** tab of the **Installation Options – Framework** screen

If the GL account validation algorithm is defined at both these algorithm spots, the algorithm defined at the division level always takes precedence over the algorithm defined in the installation options during dynamic GL account validation.

Chapter 19

Upload Validated Adjustment Data

Topics:

- [Prerequisites](#)
- [CSV File Format](#)
- [Adjustment Upload Request \(Without Approval\) Status Transition](#)
- [Adjustment Upload Request \(With Approval\) Status Transition](#)
- [Algorithms Used in C1-ADJUPLD](#)
- [Upload Request Type](#)
- [Adjustment Upload Request \(Used for Searching\)](#)
- [Adjustment Upload Request \(Used for Viewing\)](#)

Oracle Revenue Management and Billing until now provided you with an ability to upload adjustment data received from an external source system and create adjustments using the **C1-ADUP1** and **C1-ADUP2** batches. However, there was no user interface available through which you can upload an adjustment data file and create adjustments from the adjustment records. Now, the system provides a user interface which helps you to upload an adjustment data file.

You can upload an adjustment data file in the CSV format. You need to ensure that the CSV file is in the required format; otherwise the file will not be uploaded in the system. At present, the system supports only the CSV file format. For more information about the CSV file format, see [CSV File Format](#) on page 1415.

While uploading an adjustment data file, you need to specify the upload request type using which you want to upload the adjustment data file. It is the upload request type which helps the system to determine:

- Whether adjustments must be created in the real time (i.e. immediately) or in the deferred mode (i.e. in the background)
- Whether the size of the adjustment data file exceeds the maximum file size defined in the upload request type
- Whether the adjustment data file must be approved by the approver before creating adjustments

All records are validated before uploading an adjustment data file. During the validation process, the system and custom validations (if any) are executed. If there is any invalid record, the system does not allow you to upload the adjustment data file. The system indicates the reason why the adjustment record could not pass through the validation process. You need to first correct the adjustment record in the CSV file and then upload the adjustment data file.

An upload request of the specified upload request type is created when an adjustment data file is successfully uploaded in the system. You can track an adjustment data file through an upload request. During the adjustment upload process, an adjustment upload request goes through various statuses in its lifecycle. For more information about the adjustment upload request statuses, see [Adjustment Upload Request \(Without Approval\) Status Transition](#) on page 1416 and [Adjustment Upload Request \(With Approval\) Status Transition](#) on page 1417.

Note that the lifecycle of an adjustment upload request is driven by the business object using which the adjustment upload request is created. An adjustment upload request business object named **C1-ADJUPLD** is shipped with the product. The adjustment upload feature explained in this section is documented based on the lifecycle and logic defined in the **C1-ADJUPLD** business object.

If required, the implementation team can create a custom adjustment upload request business object.

Once the adjustment upload request is created, you can perform various tasks, such as:

- Track the status of an adjustment upload request
- View the details of an adjustment upload request
- View all records of an adjustment data file
- Cancel an adjustment data file
- Create adjustments for an adjustment data file
- Submit the adjustment data file for approval
- Approve or reject an adjustment data file based on the observations

Prerequisites

To setup the adjustment upload process, you need to do the following:

- Define the required upload request types in the system
- Create a defer algorithm using the **C1-UPLDEFEVL** algorithm type
- Create an algorithm using the **C1-MTCIALG** algorithm type if you want to create adjustments using the Contract match type
- Create an algorithm using the **C1-MTCTALG** algorithm type if you want to create adjustments using the Contract Type match type
- Define the required characteristic types where the characteristic entity is set to Upload Request Type
- Define cancellation and rejection reasons for the **C1-ADJUPLD** business object
- Assign the **C1-ADJUP** To Do type to a To Do role whose users must receive To Do entries generated while submitting an upload request (i.e. an adjustment data file) for approval
- Set the batch control type of the **Upload Request Periodic Monitor (C1-UPLRQ)** batch to **Timed** and define the following attributes:
 - Time Interval
 - Timer Active
 - User ID
 - Batch Language
 - Email Address

CSV File Format

Before uploading an adjustment data file, you need to ensure that the CSV file contains the following columns:

Column Name	Description	Mandatory (Yes or No)
Account Identifier Type	Used to specify the account identifier type.	Yes (Conditional) Note: This data is required when the match type is Contract Type and account ID is not specified.
Account Identifier	Used to specify the account identifier.	Yes (Conditional) Note: This data is required when the match type is Contract Type and account ID is not specified.
Account ID	Used to indicate the account for which the adjustment must be created.	Yes (Conditional) Note: This data is required when the match type is Contract Type and the account identifier type and account identifier are not specified.

Column Name	Description	Mandatory (Yes or No)
Match Type	Used to indicate the match type using which the adjustment must be created.	Yes
Match Value	Used to indicate the entity (such as contract, contract type, and so on) against which the adjustment must be created.	Yes
Adjustment Type	Used to indicate the adjustment type using which the adjustment must be created.	Yes
	Note: The adjustment type must be included in the adjustment type profile which is attached to the contract type.	
Adjustment Amount	Used to specify the adjustment amount.	Yes
	Note: The adjustment amount precision must match the precision (decimal positions) defined for the currency.	
Currency Code	Used to indicate the currency in which the adjustment must be created.	Yes
Comments	Used to specify additional information about the adjustment.	No
Bill ID	Used to indicate the bill on which the adjustment must be created.	No
Arrears Date	Used to specify the date from when the amount is outstanding on the bill.	No
Char Type 1, Char Type 2,, Char Type 5	Used to indicate the characteristic that must be defined for the adjustment.	Yes (Conditional)
		Note: This data is required if the characteristic value is specified.
Char Value 1, Char Value 2,, Char Value 5	Used to specify the value for the characteristic type.	Yes (Conditional)
		Note: This data is required if the characteristic type is specified.

Note: If an adjustment data file contains column names other than those mentioned in the above table, the system will not upload the adjustment data file.

Adjustment Upload Request (Without Approval) Status Transition

The following figure graphically indicates how an adjustment upload request moves from one status to another when approval workflow is off:

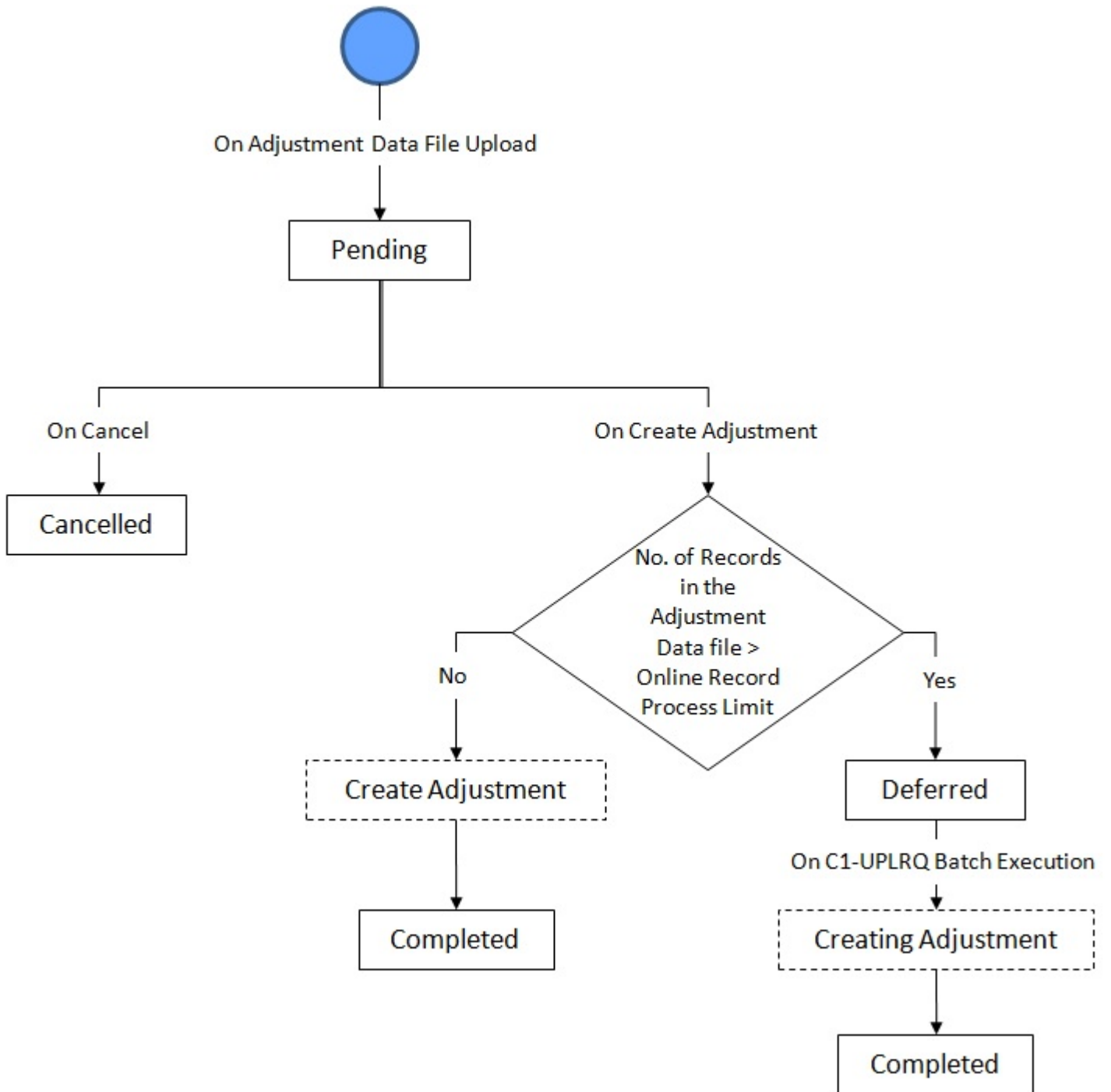

Adjustment Upload Request (With Approval) Status Transition

The following figure graphically indicates how an adjustment upload request moves from one status to another when approval workflow is on:

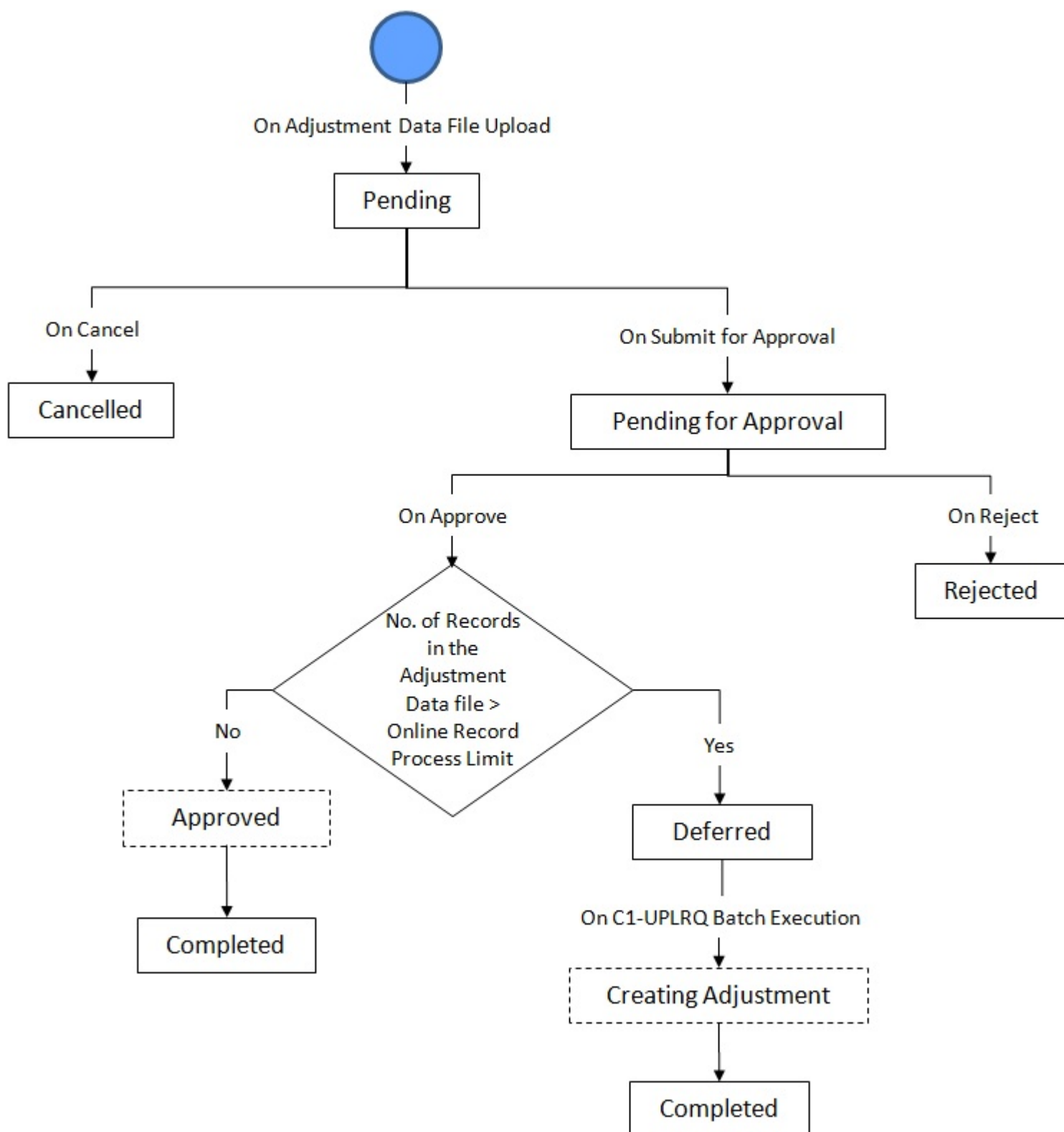

Algorithms Used in C1-ADJUPLD

The following table lists the algorithms which are attached to the **C1-ADJUPLD** business object:

System Event	Algorithm	Algorithm Type	Description
Information	C1-FLREQ-INF	C1-FLREQ-INF	<p>This algorithm formats the upload request information that appears throughout the system for the BO. The algorithm formats the information as follows: Upload Request type description, Status description, ID. This algorithm generates the upload request information string which appears throughout the application. This algorithm concatenates the following fields:</p> <ul style="list-style-type: none"> • Upload Request Type Description • Upload Request Description • Upload Request ID
Validation	C1-ADVALREQ	C1-ADVALREQ	<p>This algorithm will be called from a business service and is responsible for validating the uploaded CSV file and identify if any records are invalid. The validations to be performed are mentioned below:</p> <ol style="list-style-type: none"> 1. Mandatory column data checks 2. Check for valid values for account, match type, match value, adjustment type, adjustment characteristics type, currency and amount. 3. This algorithm will also call the match type algorithm linked to the request type to derive and validate the value for contract ID. This algorithm validates the uploaded CSV file and identifies invalid records, if any. The validations performed are as follows: <ul style="list-style-type: none"> • Validating mandatory column data • Validating values for account, match type, match value, adjustment type, adjustment characteristics type, currency and amount. • Invoke the match type algorithm linked to the request type to derive and validate the value for contract ID.

The following table lists the algorithms which are used in the lifecycle of the **C1-ADJUPLD** business object:

Status	System Event	Algorithm	Algorithm Type	Description
Draft	-	-	-	-
Cancelled	-	-	-	-

Status	System Event	Algorithm	Algorithm Type	Description
Create Adjustment	Enter	C1-ADJUPLDEF	C1-ADJUPLDEF	This algorithm will evaluate if request processing should be done in real time or deferred for offline processing. This will be invoked by the Enter Status algorithm when the Request object enters 'CREATE' or 'APPROVED' status. This algorithm evaluates and creates adjustment. It evaluates, if request should be processed in real time or deferred for offline processing. This algorithm is triggered by the Enter status algorithm when the request object is changed to Create or Approved status.
Deferred	Monitor	C1-ADJ-MNTR	C1-ADJ-MNTR	This algorithm will be invoked from the Upload Request Monitor batch. This will be responsible for BO transition from 'Deferred' to 'Creating' status. This algorithm is triggered from the Upload Request Monitor batch. This algorithm transitions the business object status from Deferred to Creating .
Pending for Approval	Enter	C1-ADJUPAPVL	C1-ADJUPAPVL	This algorithm will be responsible of creating To Do for the approver to approve or reject the uploaded file data. To Do will be created using the To Do Type linked to the request type to the approver(s) who are associated with the To Do Role linked to the request type. This will be invoked by the Enter Status algorithm when the Request object enters 'SUBMITTED - Pending For Approver' status. This algorithm creates the To Do using the To Do Type for the approver to approve or reject the uploaded file data. This To Do Type is linked to the request type to the approver(s) associated with the To Do Role linked to the request type. This algorithm is triggered by the Enter status algorithm when the request object enters Submitted - Pending For Approver status.

Status	System Event	Algorithm	Algorithm Type	Description
Approved	Enter	C1-ADJUPLDEF	C1-ADJUPLDEF	This algorithm will evaluate if request processing should be done in real time or deferred for offline processing. This will be invoked by the Enter Status algorithm when the Request object enters 'CREATE' or 'APPROVED' status. This algorithm evaluates if request should be processed in real time or deferred for offline processing. This algorithm is triggered by the Enter status algorithm when the request object is changed to Create or Approved status.
Rejected	-	-	-	-
Completed	-	-	-	-
Creating Adjustment	Enter	C1-ADJCRTION	C1-ADJCRTION	This algorithm is responsible for creating Adjustment for the uploaded file. The adjustment ID will be updated back in the request table to link the request with the adjustments. This algorithm creates an adjustment for the uploaded file. In addition, the adjustment ID is stamped on the adjustment and on the corresponding financial transaction.

Upload Request Type

Oracle Revenue Management and Billing allows you to define an upload request type using which you can upload a file. An upload request of the specified upload request type is created on uploading the file. It is the upload request type which helps the system to understand how to process the file. If you upload a file which exceeds the maximum file size, the system will not allow you to upload the file.

The **Adjustment Upload Request Type (C1-AdjRequestType)** business object is used for the maintenance of upload request types for uploading CSV data. Configurations like upload file size, approval workflow can be configured using this object. If you are going to upload adjustment data files using an upload request type, you need to specify the match types (using which the adjustments must be created) in the upload request type. At present, the following two match types are shipped with the product:

- Contract
- Contract Type

You can also define custom match types, if required. You must use the **ADJ_MATCH_TYPE** lookup field to add a new match type. You need to attach an algorithm to each match type to determine the contract against which the adjustment must be created. At present, the following algorithm types and sample algorithms are shipped with the product:

Match Type	Algorithm Type	Sample Algorithm	Algorithm Description
Contract	C1-MTCIALG	C1-MTCIALG	This algorithm fetches contract ID for each adjustment record where the match type is set to Contract (CONT) .

Match Type	Algorithm Type	Sample Algorithm	Algorithm Description
Contract Type	C1-MTCTALG	C1-MTCTALG	This algorithm fetches contract ID based on the contract type and account ID for each adjustment record where the match type is set to Contract Type (CNTY) . If there are multiple active contracts of the specified contract type on the account, the contract ID with the latest start date will be fetched.

The **Upload Request Type (C1-UplRequestType)** business object will be used for the maintenance of upload request types for uploading CSV data. Configurations like upload file size, approval workflow can be configured using this object. The system enables you to upload data for the following using the **Upload Request** feature:

- Billable Charge (Adhoc and Regular)
- Hold Request
- Refund Request
- Write Off Request
- Policy Reinstatement
- Bill Group Sort ID
- Derivation and Pricing Parameters for a Bill Group and Sort ID Combination

It also enables you to update the following information:

- Contract rider of a contract
- Bill cycle of an account

It is the upload request type which helps the system to determine:

- Whether the file must be approved by the approver before creating or updating the entities
- Which business object must be used for creating the upload request
- Which business object must be used for creating or updating entities through an upload request
- Which foreign key reference must be used for generating information string for the entity
- A set of fields using which you can search records uploaded through an upload request

You can also define custom algorithm types and algorithms, if required. The **Upload Request Type** screen allows you to define, edit, copy, and delete an upload request type. This screen consists of the following zones:

- [Upload Request Type List](#) on page 1422
- [Upload Request Type](#) on page 1423

Parent topic: [Upload Request](#) on page 1895

Upload Request Type List

The **Upload Request Type List** zone lists upload request types that are already defined in the system. It contains the following columns:

Column Name	Column Description
Upload Request Type	Displays the upload request type.
Description	Displays the description of the upload request type.
Edit	On clicking the Edit  icon, the Upload Request Type screen appears where you can edit the details of the upload request type.

Column Name	Column Description
Duplicate	On clicking the Duplicate (📄) icon, the Upload Request Type screen appears where you can define an upload request type using an existing upload request type.
Delete	On clicking the Delete (🗑️) icon, you can delete the upload request type.
	Note: You can delete an upload request type when you have not uploaded a file (i.e. created an upload request) using the upload request type.
Mapping	On clicking the Mapping (🔗) icon, the mapping screen appears where you can map the columns of CSV file with the upload request type.

On clicking the **Broadcast** (📡) icon corresponding to an upload request type, the **Upload Request Type** zone appears with the details of the respective upload request type.

Related Topics

For more information on...	See...
How to define an upload request type	Defining an Upload Request Type on page 1426
How to define a characteristic for an upload request type	Defining a Characteristic for an Upload Request Type on page 1432
How to edit an upload request type	Editing an Upload Request Type on page 1433
How to copy an upload request type	Copying an Upload Request Type on page 1436
How to delete an upload request type	Deleting an Upload Request Type on page 1441
How to map an upload request type	Mapping an Upload Request Type on page 1440
How to view the details of an upload request type	Viewing the Upload Request Type Details on page 1442

Upload Request Type

The **Upload Request Type** zone displays the details of the upload request type. This zone contains the following sections:

- **Main** – This section provides basic information about the upload request type. It contains the following fields:

Field Name	Field Description
Upload Request Type	Displays the upload request type.
Upload Request Business Object	Indicates the business object that will be used to create the upload request. In addition, a context menu appears corresponding to this field which helps in navigating to other screens in the application. Note: It has a link. On clicking the link, the Business Object screen appears where you can view the details of the respective business object.
Description	Displays the description of the upload request type.
Detailed Description	Displays additional information about the upload request type.

Field Name	Field Description
Status	<p>Indicates the status of the upload request type. The valid values are:</p> <ul style="list-style-type: none"> • Active • Inactive
File Size (KB)	<p>Displays the maximum size of file (in kilobytes) that you can upload using the upload request type. If you upload a file which exceeds the maximum file size, the system will not allow you to upload the file.</p> <p>Note: This field appears when you create upload request type using Adjustment Upload Request Type business object.</p>
Defer Algorithm	<p>Indicates the algorithm that will be triggered when you create entities (for example, adjustments) or approve the uploaded file (for example, adjustment data file). This algorithm checks whether the number of records in the uploaded file exceeds the online record process limit. If the number of records in the uploaded file does not exceed the online record process limit, the system creates the entities in the real time (i.e. immediately). However, if the number of records in the uploaded file exceeds the online record process limit, the system creates the entities (for example, adjustments) in the real time (i.e. immediately). However, if the number of records in the uploaded file exceeds the online record process limit, the system creates the entities (for example, adjustments) in the deferred mode.</p> <p>Note: This field appears when you create upload request type using Adjustment Upload Request Type business object. It has a link. On clicking the link, the Algorithm screen appears where you can view the details of the respective algorithm. In Upload Request Type, online and deferred mode is used for processing the file if approval is not required. The defer algorithm is invoked if the number of records to be processed on the respective business object is more than the count specified on the algorithm then the status for number of records is changed from Validated to Deferred Processing else the status is changed to Processed.</p>
Approval Required	<p>Indicates whether approval is required for a file which is uploaded using the upload request type.</p>
Approval To Do Type	<p>Indicates that the To Do entry of the specified To Do type must be created when you submit the upload request for approval.</p> <p>Note: This field appears when the Approval Required check box is selected. It has a link. On clicking the link, the To Do Type screen appears with the details of the respective To Do type.</p>

Field Name	Field Description
Approval To Do Role	<p>Indicates that users with the specified To Do role can only approve or reject the upload request submitted for approval.</p> <p>Note:</p> <p>This field appears when the Approval Required check box is selected.</p> <p>On selecting the To Do Type, the To Do Roles configured on the To Do Type is populated.</p> <p>It has a link. On clicking the link, the To Do Role screen appears with the details of the respective To Do role.</p>
FK Reference	<p>Indicates the foreign key reference which specifies the created upload request type.</p> <p>Note:</p> <p>This field appears when you create upload request type using Upload Request Type business object.</p> <p>It has a link. On clicking the link, the Foreign Key Reference screen appears with the details of the respective foreign key.</p>

In addition, this section has the following columns:

Column Name	Column Description
Match Type	<p>Indicates the match type using which the adjustments must be created when you upload a file using the upload request type. The valid values are:</p> <ul style="list-style-type: none"> • Contract • Contract Type <p>Note: The Match Type column is displayed for Adjustment Upload Request Business Object.</p>
Algorithm	<p>Indicates the algorithm that will be triggered when you upload an adjustment data file. This algorithm determines the contract against which the adjustment must be created.</p> <p>Note: It has a link. On clicking the link, the Algorithm screen appears with the details of the respective algorithm. The Algorithm column is displayed for Adjustment Upload Request Business Object.</p>

- **Characteristics** – This section lists the characteristics of the upload request type. It contains the following columns:

Column Name	Column Description
Characteristic Type	Indicates the characteristic type.
Characteristic Value	Displays the value of the characteristic type.

- **Record Actions** – This section contains the following buttons:

Button Name	Button Description
Edit	Used to edit the details of the upload request type.
Delete	Used to delete the upload request type. Note: You can delete an upload request type when you have not uploaded a file (i.e. created an upload request) using the upload request type.
Duplicate	Used to create a new upload request type using an existing upload request type.

- **Record Information** – This section contains the following fields:

Field Name	Field Description
Business Object	Indicates the business object using which the upload request type is created. In addition, a context menu appears corresponding to this field which helps in navigating to other screens in the application. Note: It has a link. On clicking the link, the Business Object screen appears where you can view the details of the respective business object.

By default, the **Upload Request Type** zone does not appear in the **Upload Request Type** screen. It appears when you click the **Broadcast** (📡) icon corresponding to an upload request type in the **Upload Request Type List** zone.

Related Topics

For more information on...	See...
How to define an upload request type	Defining an Upload Request Type on page 1426
How to define a characteristic for an upload request type	Defining a Characteristic for an Upload Request Type on page 1432
How to edit an upload request type	Editing an Upload Request Type on page 1433
How to copy an upload request type	Copying an Upload Request Type on page 1436
How to delete an upload request type	Deleting an Upload Request Type on page 1441
How to map an upload request type	Mapping an Upload Request Type on page 1440
How to view the details of an upload request type	Viewing the Upload Request Type Details on page 1442

Defining an Upload Request Type

Prerequisites

To define an upload request type, you should have:

- Upload request business objects defined in the application
- Defer algorithm for adjustment is defined using the **C1-UPLDEFEVL** algorithm type
- Defer algorithm for upload is defined using the **C1-DEFERUPLD** algorithm type
- Algorithm defined using the **C1-MTCIALG** algorithm type when you want to create adjustment using the **Contract** match type
- **C1-ADJUP** To Do type assigned to a To Do role whose users must receive To Do while submitting an adjustment upload request for approval

- **C1-BCUUR** To Do type assigned to a To Do role whose users must receive To Do while submitting a bill cycle update upload request for approval
- **C1-CRUUR** To Do type assigned to a To Do role whose users must receive To Do while submitting a contract rider update upload request for approval
- **C1-HLDUR** To Do type assigned to a To Do role whose users must receive To Do while submitting a hold upload request for approval
- **C1-REFUR** To Do type assigned to a To Do role whose users must receive To Do while submitting a refund upload request for approval
- **C1-WOUR** To Do type assigned to a To Do role whose users must receive To Do while submitting a write off upload request for approval
- **C1-BCUR** To Do type assigned to a To Do role whose users must receive To Do while submitting a billable charge upload request for approval
- **C1-RPUR** To Do type assigned to a To Do role whose users must receive To Do while submitting a reinstatement upload request for approval
- **C1-BGSRT** To Do type assigned to a To Do role whose users must receive To Do while submitting a bill group sorting upload request for approval
- **C1-BGDVP** To Do type assigned to a To Do role whose users must receive To Do while submitting a bill group derivation and pricing parameters upload request for approval

Procedure

To define an upload request type:

1. Click the **Admin** link in the **Application** toolbar.
A list appears.
2. From the **Admin** menu, select **U** and then click **Upload Request Type**.
A sub-menu appears.
3. Click the **Add** option from the **Upload Request Type** sub-menu.

The **Select Business Object** screen appears. It contains the following field:

Field Name	Field Description	Mandatory (Yes or No)
Upload Request Type Business Object	Used to indicate the business object that you want to use to create the upload request type.	Yes

Tip: Alternatively, you can access the **Select Business Object** screen by clicking the **Add** button in the **Page Title** area of the **Upload Request Type** screen.

Note: The **Select Business Object** screen appears when there are multiple upload request type business objects defined in the application. If there is only one upload request type business object defined in the application, the **Upload Request Type** screen appears.

4. Select the required upload request type business object from the respective field.
5. Click **OK**.

The **Upload Request Type** screen appears. It contains the following sections:

- **Main** – Used to specify basic details about the upload request type.
- **Characteristics** – Used to define the characteristics for the upload request type.

The **Main** section contains the following fields:

Field Name	Field Description	Mandatory (Yes or No)
Upload Request Type	Used to specify the upload request type.	Yes
Upload Request Type Business Object	Indicates the upload request type business object used while defining the upload request type.	Not applicable
Upload Request Business Object	Used to indicate the business object that you want to use while creating the upload request.	Yes
Description	Used to specify the description for the upload request type.	Yes
Detailed Description	Used to specify additional information about the upload request type.	No
Status	Used to indicate the status of the upload request type. The valid values are: <ul style="list-style-type: none"> • Active • Inactive 	Yes
File Size (KB)	Used to specify the maximum size of file (in kilobytes) that you can upload using the upload request type. If you upload a file which exceeds the maximum file size, the system will not allow you to upload the file.	Yes
	Note: This field appears when Adjustment Upload Request Type business object is selected.	

Field Name	Field Description	Mandatory (Yes or No)
Defer Algorithm	<p>Used to attach an algorithm that will be triggered when you create entities (for example, adjustments) or approve the uploaded file (for example, adjustment data file). This algorithm checks whether the number of records in the uploaded file exceeds the online record process limit (defined in the Defer algorithm). If the number of records in the uploaded file does not exceed the online record process limit, the system creates the entities (for example, adjustments) in the real time (i.e. immediately). However, if the number of records in the uploaded file exceeds the online record process limit, the system creates the entities (for example, adjustments) in the deferred mode.</p> <p>Note:</p> <p>Deferred mode means in the background when the Upload Request Periodic Monitor (C1-UPLRQ) batch is invoked. You can configure the Upload Request Periodic Monitor (C1-UPLRQ) batch such that it is executed at regular intervals. When the Upload Request Periodic Monitor (C1-UPLRQ) batch is invoked, the system checks whether there are any upload requests in the Deferred status. If there is an upload request in the Deferred status, the system creates the entities (for example, adjustments).</p> <p>This field appears when Adjustment Upload Request Type business object is selected.</p> <p>In Upload Request Type, online and deferred mode is used for processing the file if approval is not required. The defer algorithm is invoked if the number of records to be processed on the respective business object is more than the count specified on the algorithm then the status for number of records is changed from Validated to Deferred Processing else the status is changed to Processed.</p> <p>Note: The Search  icon appears corresponding to this field. On clicking the Search icon, the Algorithm Search window appears.</p>	Yes

Field Name	Field Description	Mandatory (Yes or No)																						
Entity Business Object	<p>Used to indicate for creating Business Object of the entity using the upload request type.</p> <p>Note:</p> <p>The Search (🔍) icon appears corresponding to this field. On clicking the Search icon, the Business Object Search window appears.</p> <p>This field appears when Upload Request Type business object is selected.</p>	No																						
Approval Required	Used to indicate whether approval is required for a file which is uploaded using the upload request type.	No																						
Approval To Do Type	<p>Used to indicate that To Do entry of the specified To Do type must be created when you submit the upload request for approval.</p> <p>Note:</p> <p>The Search (🔍) icon appears corresponding to this field. On clicking the Search icon, the To Do Type Search window appears.</p> <p>The following table lists the To Do type using which the To Do must be generated for the different upload requests:</p> <table border="1"> <thead> <tr> <th>Upload Request</th> <th>To Do Type</th> </tr> </thead> <tbody> <tr> <td>Adjustment</td> <td>C1-ADJUP</td> </tr> <tr> <td>Bill Cycle Update</td> <td>C1-BCUUR</td> </tr> <tr> <td>Billable Charge</td> <td>C1-BCUR</td> </tr> <tr> <td>Contract Rider Update</td> <td>C1-CRUUR</td> </tr> <tr> <td>Hold Request</td> <td>C1-HLDUR</td> </tr> <tr> <td>Refund Request</td> <td>C1-REFUR</td> </tr> <tr> <td>Write Off Request</td> <td>C1-WOUR</td> </tr> <tr> <td>Policy Reinstatement</td> <td>C1-RPUR</td> </tr> <tr> <td>Bill Group Sorting</td> <td>C1-BGSRT</td> </tr> <tr> <td>Bill Group Derivation and Pricing Parameters</td> <td>C1-BGDVP</td> </tr> </tbody> </table>	Upload Request	To Do Type	Adjustment	C1-ADJUP	Bill Cycle Update	C1-BCUUR	Billable Charge	C1-BCUR	Contract Rider Update	C1-CRUUR	Hold Request	C1-HLDUR	Refund Request	C1-REFUR	Write Off Request	C1-WOUR	Policy Reinstatement	C1-RPUR	Bill Group Sorting	C1-BGSRT	Bill Group Derivation and Pricing Parameters	C1-BGDVP	<p>Yes (Conditional)</p> <p>Note: This field is required when the Approval Required check box is selected.</p>
Upload Request	To Do Type																							
Adjustment	C1-ADJUP																							
Bill Cycle Update	C1-BCUUR																							
Billable Charge	C1-BCUR																							
Contract Rider Update	C1-CRUUR																							
Hold Request	C1-HLDUR																							
Refund Request	C1-REFUR																							
Write Off Request	C1-WOUR																							
Policy Reinstatement	C1-RPUR																							
Bill Group Sorting	C1-BGSRT																							
Bill Group Derivation and Pricing Parameters	C1-BGDVP																							

Field Name	Field Description	Mandatory (Yes or No)
Approval To Do Role	Used to indicate that users with the specified To Do role can only approve the upload request submitted for approval.	Yes (Conditional) Note: This field is required when the Approval Required check box is selected.
FK Reference	Used to indicate the FK Reference code to display the entity information. Note: The Search (🔍) icon appears corresponding to this field. On clicking the Search icon, the Foreign Key Search window appears. This field appears when Upload Request Type business object is selected.	No

In addition, this section contains the following fields in the grid:

Note: This field appears when **Adjustment Upload Request Type** business object is selected.

Field Name	Field Description	Mandatory (Yes or No)
Match Type	Used to indicate the match type using which you want to create adjustments when you upload a file using the upload request type. The valid values are: <ul style="list-style-type: none"> Contract Contract Type 	Yes (Conditional) Note: This field is required when you select the Adjustment Upload Request option from the Upload Request Business Object list.
Algorithm	Used to attach an algorithm that will be triggered when you upload an adjustment data file. This algorithm determines the contract against which the adjustment must be created. Note: The Search (🔍) icon appears corresponding to this field. On clicking the Search icon, the Algorithm Search window appears.	Yes (Conditional) Note: This field is required when you select the match type from the respective field.

6. Enter the required details.

Note:

You can search for an algorithm by clicking the **Search** (🔍) icon corresponding to the respective field.

If you want to associate more than one match type with the upload request type, click the **Add** (+) icon and then specify the details. However, if you want to remove a match type from the upload request type, click the **Delete** (🗑️) icon corresponding to the match type.

7. Define characteristics for the upload request type, if required.

8. Click **Save**.

The upload request type is defined.

Related Topics

For more information on...	See...
Upload Request Type screen	Upload Request Type on page 1421
Upload Request Type List zone	Upload Request Type List on page 1422
How to define a characteristic for an upload request type	Defining a Characteristic for an Upload Request Type on page 1432

Defining a Characteristic for an Upload Request Type**Prerequisites**

To define a characteristic for an upload request type, you should have:

- Characteristic types defined in the application (where the characteristic entity is set to Upload Request Type)

Procedure

To define a characteristic for an upload request type:

1. Ensure that the **Characteristics** section is expanded when you are defining, editing, or copying an upload request type.

The **Characteristics** section contains the following fields:

Field Name	Field Description	Mandatory (Yes or No)
Characteristic Type	Used to indicate the characteristic type.	Yes (Conditional)
	Note: The list includes only those characteristic types where the characteristic entity is set to Upload Request Type.	Note: This field is required when you are defining a characteristic for the upload request type.
Characteristic Value	Used to specify the value for the characteristic type.	Yes (Conditional)
	Note: On specifying the value for a predefined characteristic type, the description of the characteristic value appears corresponding to the Characteristic Value field.	Note: This field is required when you are defining a characteristic for the upload request type.

2. Enter the required details.

Note: If you select a predefined characteristic type, the **Search** (🔍) icon appears corresponding to the **Characteristic Value** field. On clicking the **Search** icon, you can search for a predefined characteristic value.

3. If you want to define more than one characteristic for the upload request type, click the **Add** (+) icon and then repeat step 2.

Note: However, if you want to remove a characteristic from the upload request type, click the **Delete** (🗑️) icon corresponding to the characteristic.

Related Topics

For more information on...	See...
How to define an upload request type	Defining an Upload Request Type on page 1426
How to edit an upload request type	Editing an Upload Request Type on page 1433
How to copy an upload request type	Copying an Upload Request Type on page 1436

Editing an Upload Request Type**Prerequisites**

To edit an upload request type, you should have:

- Upload request business objects defined in the application
- Defer algorithm for adjustment is defined using the **C1-UPLDEFEVL** algorithm type
- Defer algorithm for upload is defined using the **C1-DEFERUPLD** algorithm type
- Algorithm defined using the **C1-MTCIALG** algorithm type when you want to create adjustment using the Contract match type
- Algorithm defined using the **C1-MTCTALG** algorithm type when you want to create adjustment using the Contract Type match type
- **C1-ADJUP** To Do type assigned to a To Do role whose users must receive To Do entries generated while submitting an adjustment upload request for approval
- **C1-UPLAPPENT** To Do type assigned to a To Do role whose users must receive To Do generated while submitting an upload request for approval

Procedure

To edit an upload request type:

1. Click the **Admin** link in the **Application** toolbar.
A list appears.
2. From the **Admin** menu, select **U** and then click **Upload Request Type**.
A sub-menu appears.
3. In the **Upload Request Type List** zone, click the **Edit**  icon in the **Edit** column corresponding to the upload request type whose details you want to edit.

The **Upload Request Type** screen appears. It contains the following sections:

- **Main** – Used to specify basic details about the upload request type.
- **Characteristics** – Used to define the characteristics for the upload request type.

The **Main** section contains the following fields:

Field Name	Field Description	Mandatory (Yes or No)
Upload Request Type	Displays the upload request type.	Not applicable
Upload Request Type Business Object	Indicates the upload request type business object used while defining the upload request type.	Not applicable
Upload Request Business Object	Used to specify the business object that you want to use while creating the upload request.	Yes

Field Name	Field Description	Mandatory (Yes or No)
Description	Used to specify the description for the upload request type.	Yes
Detailed Description	Used to specify additional information about the upload request type.	No
Status	Used to indicate the status of the upload request type. The valid values are: <ul style="list-style-type: none"> Active Inactive 	Yes
File Size (KB)	Used to specify the maximum size of file (in kilobytes) that you can upload using the upload request type. If you upload a file which exceeds the maximum file size, the system will not allow you to upload the file.	Yes
	Note: This field appears when the business object is Adjustment Upload Request Type .	
Defer Algorithm	Used to attach an algorithm that will be triggered when you create entities (for example, adjustments) or approve the uploaded file (for example, adjustment data file). This algorithm checks whether the number of records in the uploaded file exceeds the online record process limit (defined in the Defer algorithm). If the number of records in the uploaded file does not exceed the online record process limit, the system creates the entities (for example, adjustments) in the real time (i.e. immediately). However, if the number of records in the uploaded file exceeds the online record process limit, the system creates the entities (for example, adjustments) in the deferred mode.	Yes
	<p>Note:</p> <p>Deferred mode means in the background when the Upload Request Periodic Monitor (C1-UPLRQ) batch is invoked. You can configure the Upload Request Periodic Monitor (C1-UPLRQ) batch such that it is executed at regular intervals. When the Upload Request Periodic Monitor (C1-UPLRQ) batch is invoked, the system checks whether there are any upload requests in the Deferred status. If there is an upload request in the Deferred status, the system creates the entities (for example, adjustments).</p> <p>This field appears when the business object is Adjustment Upload Request Type.</p>	

Field Name	Field Description	Mandatory (Yes or No)
Entity Business Object	Used to indicate for creating Business Object of the entity using the upload request type.	No
	Note: The Search (🔍) icon appears corresponding to this field. On clicking the Search icon, the Business Object Search window appears.	
Approval Required	Used to indicate whether approval is required for a file which is uploaded using the upload request type.	No
Approval To Do Type	Used to indicate that To Do entry of the specified To Do type must be created when you submit the upload request for approval.	Yes (Conditional)
	Note: The Search (🔍) icon appears corresponding to this field. On clicking the Search icon, the To Do Type Search window appears.	
Approval To Do Role	Used to indicate that users with the specified To Do role can only approve the upload request submitted for approval.	Yes (Conditional)
FK Reference	Used to indicate the FK Reference code to display the entity information.	No
	Note: The Search (🔍) icon appears corresponding to this field. On clicking the Search icon, the Foreign Key Search window appears. This field appears when the business object is Upload Request Type .	

In addition, this section contains the following fields in the grid:

Note: The below section appears when the business object is **Adjustment Upload Request Type**.

Field Name	Field Description	Mandatory (Yes or No)
Match Type	Used to indicate the match type using which you want to create adjustments when you upload a file using the upload request type. The valid values are: <ul style="list-style-type: none"> • Contract • Contract Type 	Yes (Conditional)
		Note: This field is required when you select the Adjustment Upload Request option from the Upload Request Business Object list.

Field Name	Field Description	Mandatory (Yes or No)
Algorithm	Used to attach an algorithm that will be triggered when you upload an adjustment data file. This algorithm determines the contract against which the adjustment must be created.	Yes (Conditional)
		Note: This field is required when you select the match type from the respective field.

Tip: Alternatively, you can click the **Edit** button in the **Upload Request Type** zone to edit the details of the upload request type.

4. Modify the required details.

Note:

You can search for an algorithm by clicking the **Search** (🔍) icon corresponding to the respective field.

If you want to associate more than one match type with the upload request type, click the **Add** (+) icon and then specify the details. However, if you want to remove a match type from the upload request type, click the **Delete** (🗑️) icon corresponding to the match type.

5. Define, edit, or remove characteristics of the upload request type, if required.

6. Click **Save**.

The changes made to the upload request type are saved.

Related Topics

For more information on...	See...
Upload Request Type screen	Upload Request Type on page 1421
Upload Request Type List zone	Upload Request Type List on page 1422
Upload Request Type zone	Upload Request Type on page 1423
How to define a characteristic for an upload request type	Defining a Characteristic for an Upload Request Type on page 1432

Copying an Upload Request Type

Instead of creating an upload request type from scratch, you can create a new upload request type using an existing upload request type. This is possible through copying an upload request type. On copying an upload request type, the details including the match types (only for adjustments) and characteristics are copied to the new upload request type. You can then edit the details, if required.

Prerequisites

To copy an upload request type, you should have:

- Upload request type (whose copy you want to create) defined in the application
- Upload request business objects defined in the application
- Defer algorithm defined using the **C1-UPLDEFEVL** algorithm type
- Defer algorithm for upload is defined using the **C1-DEFERUPLD** algorithm type
- Algorithm defined using the **C1-MTCIALG** algorithm type when you want to create adjustment using the Contract match type

- Algorithm defined using the **C1-MTCTALG** algorithm type when you want to create adjustment using the Contract Type match type
- **C1-ADJUP** To Do type assigned to a To Do role whose users must receive To Do entries generated while submitting an upload request for approval
- **C1-UPLAPPENT** To Do type assigned to a To Do role whose users must receive To Do generated while submitting an upload request for approval

Procedure

To copy an upload request type:

1. Click the **Admin** link in the **Application** toolbar.
A list appears.
2. From the **Admin** menu, select **U** and then click **Upload Request Type**.
A sub-menu appears.
3. In the **Upload Request Type List** zone, click the **Duplicate** (📄) icon in the **Duplicate** column corresponding to the upload request type whose copy you want to create.

The **Upload Request Type** screen appears. It contains the following sections:

- **Main** – Used to specify basic details about the upload request type.
- **Characteristics** – Used to define the characteristics for the upload request type.

The **Main** section contains the following fields:

Field Name	Field Description	Mandatory (Yes or No)
Upload Request Type	Used to specify the upload request type.	Yes
Upload Request Type Business Object	Indicates the upload request type business object used while defining the upload request type (whose copy you want to create).	Not applicable
Upload Request Business Object	Used to specify the business object that you want to use while creating the upload request.	Yes
Description	Used to specify the description for the upload request type.	Yes
Detailed Description	Used to specify additional information about the upload request type.	No
Status	Used to indicate the status of the upload request type. The valid values are: <ul style="list-style-type: none"> • Active • Inactive 	Yes
File Size (KB)	Used to specify the maximum size of file (in kilobytes) that you can upload using the upload request type. If you upload a file which exceeds the maximum file size, the system will not allow you to upload the file.	Yes
	Note: This field appears when the business object is Adjustment Upload Request Type .	

Field Name	Field Description	Mandatory (Yes or No)
Defer Algorithm	<p>Used to attach an algorithm that will be triggered when you create entities (for example, adjustments) or approve the uploaded file (for example, adjustment data file). This algorithm checks whether the number of records in the uploaded file exceeds the online record process limit (defined in the Defer algorithm). If the number of records in the uploaded file does not exceed the online record process limit, the system creates the entities (for example, adjustments) in the real time (i.e. immediately). However, if the number of records in the uploaded file exceeds the online record process limit, the system creates the entities (for example, adjustments) in the deferred mode.</p> <p>Note:</p> <p>Deferred mode means in the background when the Upload Request Periodic Monitor (C1-UPLRQ) batch is invoked. You can configure the Upload Request Periodic Monitor (C1-UPLRQ) batch such that it is executed at regular intervals. When the Upload Request Periodic Monitor (C1-UPLRQ) batch is invoked, the system checks whether there are any upload requests in the Deferred status. If there is an upload request in the Deferred status, the system creates the entities (for example, adjustments).</p> <p>This field appears when the business object is Adjustment Upload Request Type.</p>	Yes
Entity Business Object	<p>Used to indicate to create the copy of Business Object of the entity using the upload request type.</p> <p>Note:</p> <p>The Search (🔍) icon appears corresponding to this field. On clicking the Search icon, the Business Object Search window appears.</p> <p>This field appears when the business object is Upload Request Type.</p>	No
Approval Required	Used to indicate whether approval is required for a file which is uploaded using the upload request type.	No

Field Name	Field Description	Mandatory (Yes or No)
Approval To Do Type	Used to indicate that To Do entry of the specified To Do type must be created when you submit the upload request for approval.	Yes (Conditional)
	Note: The Search (🔍) icon appears corresponding to this field. On clicking the Search icon, the To Do Type Search window appears.	Note: This field is required when the Approval Required check box is selected.
Approval To Do Role	Used to indicate that users with the specified To Do role can only approve the upload request submitted for approval.	Yes (Conditional)
		Note: This field is required when the Approval Required check box is selected.
FK Reference	Used to indicate the FK Reference code to display the entity information.	No
	Note: The Search (🔍) icon appears corresponding to this field. On clicking the Search icon, the Foreign Key Search window appears. This field appears when the business object is Upload Request Type .	

In addition, this section contains the following fields in the grid:

Note: The below section appears when the business object is **Adjustment Upload Request Type**.

Field Name	Field Description	Mandatory (Yes or No)
Match Type	Used to indicate the match type using which you want to create adjustments when you upload a file using the upload request type. The valid values are: <ul style="list-style-type: none"> Contract Contract Type 	Yes (Conditional)
		Note: This field is required when you select the Adjustment Upload Request option from the Upload Request Business Object list.
Algorithm	Used to attach an algorithm that will be triggered when you upload an adjustment data file. This algorithm determines the contract against which the adjustment must be created.	Yes (Conditional)
		Note: This field is required when you select the match type from the respective field.

Tip: Alternatively, you can click the **Duplicate** button in the **Upload Request Type** zone to create a copy of the upload request type.

4. Enter the required details.

Note:

You can search for an algorithm by clicking the **Search** (🔍) icon corresponding to the respective field.

If you want to associate more than one match type with the upload request type, click the **Add** (+) icon and then specify the details. However, if you want to remove a match type from the upload request type, click the **Delete** (🗑️) icon corresponding to the match type.

5. Define, edit, or remove characteristics of the upload request type, if required.
6. Click **Save**.

The new upload request type is defined.

Related Topics

For more information on...	See...
Upload Request Type screen	Upload Request Type on page 1421
Upload Request Type List zone	Upload Request Type List on page 1422
Upload Request Type zone	Upload Request Type on page 1423
How to define a characteristic for an upload request type	Defining a Characteristic for an Upload Request Type on page 1432

Mapping an Upload Request Type**Prerequisites**

To map an upload request type, you should have:

- Upload request type (whose columns you want to map with the CSV file) defined in the application
- Upload request business objects defined in the application

Note: Once an upload request type is used for creating an upload request, then mapping for the same cannot be edited. Duplicating the upload request type will not duplicate the mapping data. You have to add the mapping details manually after duplicating an upload request type.

Procedure

To map an upload request type:

1. Click the **Admin** link in the **Application** toolbar.
A list appears.
2. From the **Admin** menu, select **U** and then click **Upload Request Type**.
A sub-menu appears.
3. In the **Upload Request Type List** zone, click the **Mapping** (🔗) icon in the **Mapping** column corresponding to the upload request type whose columns you want to map with the CSV file.

The **Upload Request Type Mapping** screen appears. It contains the following field:

Note: The **Mapping** icon is applicable only for upload request type created using **Upload Request Type (C1-UplRequestType)** business object, and it is not applicable for upload request type created using **Adjustment Upload Request Type (C1-AdjRequestType)** business object.

Field Name	Field Description	Mandatory (Yes or No)
Upload Request Type	Indicates the upload request type.	Not applicable

The **Upload Request Type Mapping** screen also contains the following columns:

Column Name	Column Description	Mandatory (Yes or No)
CSV Column Header	Used to specify the rows correspond to the columns in CSV file.	Yes (Conditional) Note: This column is required when you search the Data Records zone in the Upload Request screen.
Use for Searching	Used to indicate whether the defined CSV Column Header is searchable or not. Note: Upto 10 rows can be selected as searchable rows.	Yes (Conditional) Note: This column is required to be selected to be shown in the Data Records zone in the Upload Request screen
Sequence Number	Used to specify the sequence of the searchable fields. Note: Searchable rows should have sequence less than or equal to 10.	Yes (Conditional) Note: This column is required to be selected to be shown sequentially in the Data Records zone in the Upload Request screen

- Enter the required details.

Note: If you want to add more than one column names mapped to the upload request type, click the **Add (+)** icon and then specify the details. However, if you want to remove a column name mapped to the upload request type, click the **Delete (🗑)** icon corresponding to the column header.

- Click **Save**.

The columns are mapped to the CSV files for upload request type.

Related Topics

For more information on...	See...
Upload Request Type screen	Upload Request Type on page 1421
Upload Request Type List zone	Upload Request Type List on page 1422
Upload Request Type zone	Upload Request Type on page 1423

Deleting an Upload Request Type

Procedure

To delete an upload request type:

- Click the **Admin** link in the **Application** toolbar.

A list appears.

- From the **Admin** menu, select **U** and then click **Upload Request Type**.

A sub-menu appears.

- In the **Upload Request Type List** zone, click the **Delete** (🗑) icon in the **Delete** column corresponding to the upload request type that you want to delete.

A message appears confirming whether you want to delete the upload request type.

Note: You can delete an upload request type when you have not uploaded a file (i.e. created an upload request) using the upload request type.

Tip: Alternatively, you can click the **Delete** button in the **Upload Request Type** zone to delete the upload request type.

- Click **OK**.

The upload request type is deleted.

Related Topics

For more information on...	See...
Upload Request Type screen	Upload Request Type on page 1421
Upload Request Type List zone	Upload Request Type List on page 1422
Upload Request Type zone	Upload Request Type on page 1423

Viewing the Upload Request Type Details

Procedure

To view the details of an upload request type:

- Click the **Admin** link in the **Application** toolbar.
A list appears.
- From the **Admin** menu, select **U** and then click **Upload Request Type**.
A sub-menu appears.
- Click the **Search** option from the **Upload Request Type** sub-menu.
The **Upload Request Type** screen appears.
- In the **Upload Request Type List** zone, click the **Broadcast** (📡) icon corresponding to the upload request type whose details you want to view.
The **Upload Request Type** zone appears.
- View the details of the upload request type in the **Upload Request Type** zone.

Related Topics

For more information on...	See...
Upload Request Type screen	Upload Request Type on page 1421
Upload Request Type List zone	Upload Request Type List on page 1422
Upload Request Type zone	Upload Request Type on page 1423

Adjustment Upload Request (Used for Searching)

The **Adjustment Upload Request** screen allows you to search for an adjustment upload request using various search criteria. Through this screen, you can:

- Upload an adjustment data file
- Cancel an adjustment data file
- View the details of an adjustment upload request
- View all adjustment records which are uploaded through an adjustment data file
- Create adjustments for an adjustment data file
- Submit an adjustment data file for approval
- Approve or reject an adjustment data file
- View the log of an adjustment upload request
- Add a log entry for an adjustment upload request

This screen consists of the following zones:

- [Search Adjustment Upload Request](#) on page 1443
- [Adjustment Upload Request](#) on page 1451
- [Adjustment Data Records](#) on page 1454

Search Adjustment Upload Request

The **Search Adjustment Upload Request** zone allows you to search for an adjustment upload request using various search criteria. This zone contains the following two sections:

- **Search Criteria** — The fields in the **Search Criteria** section change depending on the query option selected. At present, there is only one query option named **Upload Request**. On selecting the **Upload Request** query option, the **Search Criteria** section contains the following fields:

Field Name	Field Description	Mandatory (Yes or No)
Upload Request Type	Used to search adjustment upload requests which are created using a particular upload request type.	No

Field Name	Field Description	Mandatory (Yes or No)
Status	Used to search adjustment upload requests with a particular status. The valid values are: <ul style="list-style-type: none"> • Approved • Cancelled • Completed • Create Adjustment • Creating Adjustment • Deferred • Pending • Rejected • Pending For Approval 	No
Upload From Date	Used to search adjustment upload requests which are created from a particular date onwards. Note: By default, the current date appears in this field.	No
To	Used to search adjustment upload requests which are created till a particular date. Note: By default, the current date appears in this field.	No
File Name	Used to search an adjustment upload request which is created while uploading an adjustment data file.	No

Note: You must specify at least one search criterion while searching for an adjustment upload request.

- **Search Results** — On clicking the **Refresh** button, the search results appear based on the specified search criteria. The **Search Results** section contains the following columns:

Column Name	Column Description
Upload Date	Displays the date and time when the adjustment data file is uploaded in the system.
Upload Request Information	Displays information about the adjustment upload request. Note: It has a link. On clicking the link, the Adjustment Upload Request screen appears where you can view the details of the respective upload request.
Status	Indicates the status of the adjustment upload request.
Upload Request Type	Indicates the upload request type using which the adjustment data file is uploaded in the system.
File Name	Displays the name of the adjustment data file.

You can upload an adjustment data file by clicking the **Upload** link in the upper right corner of this zone.

Related Topics

For more information on...	See...
How to search for an adjustment upload request	Searching for an Adjustment Upload Request on page 1445
How to upload an adjustment data file	Uploading an Adjustment Data File on page 1445
How to view the details of an adjustment upload request	Viewing the Adjustment Upload Request Details on page 1450

Searching for an Adjustment Upload Request

Prerequisites

To search for an adjustment upload request, you should have:

- Upload request types defined in the application

Procedure

To search for an adjustment upload request:

1. Click the **Menu** link in the **Actions/Navigation** area.
A list appears.
2. Select the **Main Menu** option from the list.
3. From the **Main Menu**, select **Billing Management** and then click **Adjustment Upload Request**.
The **Adjustment Upload Request** screen appears.
4. Enter the search criteria in the **Search Adjustment Upload Request** zone.

Note: ORMB search engine supports wildcard search, where you can substitute the percentage (%) symbol as a stand in for any word or letter in a search criteria. You can use the ‘%’ wildcard character in all input fields except the date and ID fields. The ‘%’ wildcard character is suffixed automatically at the end of the partial search criteria. Therefore, you may or may not specify the wildcard character at the end of the partial search criteria. However, you have to prefix the wildcard character manually wherever required.

5. Click **Search**.

A list of adjustment upload requests that meet the search criteria appears in the **Search Results** section.

Related Topics

For more information on...	See...
Adjustment Upload Request screen	Adjustment Upload Request (Used for Searching) on page 1443
Search Adjustment Upload Request zone	Search Adjustment Upload Request on page 1443

Uploading an Adjustment Data File

Prerequisites

To upload an adjustment data file, you should have:

- Upload request types defined in the application
- Adjustment data in the required CSV file format

Procedure

To upload an adjustment data file:

1. Click the **Menu** link in the **Actions/Navigation** area.
A list appears.
2. Select the **Main Menu** option from the list.
3. From the **Main Menu**, select **Billing Management** and then click **Adjustment Upload Request**.
The **Adjustment Upload Request** screen appears.
4. Click the **Upload** link in the upper right corner of the **Search Adjustment Upload Request** zone.
The **Upload Adjustment Data File** screen appears. It contains the following fields:

Field Name	Field Description	Mandatory (Yes or No)
Upload Request Type	Used to indicate the upload request type using which you want to upload the adjustment data file.	Yes
	Note: The list includes only those upload request types which are in the Active status.	
Replace Existing File	Used to indicate whether you want to replace any existing file in the system. You must select this check box when you want to upload the same file once again.	No
	Note: You can replace an existing file when the adjustment upload request is in the Pending or Cancelled status.	
File Name	Used to specify the name and path of the adjustment data file that you want to upload.	Yes
	Note: You can also click the Browse button corresponding to this field to browse to the location where the adjustment data file is available in the system.	

5. Select the upload request type using which you want to upload the adjustment data file.
6. Click the **Browse** button corresponding to the **File Name** field.
The **Choose File to Upload** dialog box appears.
7. Browse to the location where the adjustment data file that you want to upload is available.
8. Click **Open**.
The adjustment data file name and path appears in the **File Name** field.
9. Click **Submit**.

A grid appears which helps you to preview all records in the adjustment data file. It contains the following columns:

Column Name	Column Description
Errors	Indicates the reason why the adjustment record is invalid. If there are multiple reasons, the comma-separated list of error messages appears in this column.
	Note: This column appears when you click the Save button.
Account Identifier Type	Indicates the account identifier type.

Column Name	Column Description
Account Identifier	Displays the value of the account identifier type.
Account ID	Indicates the account for which the adjustment must be created.
Match Type	Indicates the match type using which the adjustment must be created.
Match Value	Indicates the entity (such as contract, contract type, and so on) against which the adjustment must be created.
Adjustment Type	Indicates the adjustment type using which the adjustment must be created.
Adjustment Amount	Displays the adjustment amount.
Currency Code	Indicates the currency in which the adjustment must be created.
Comments	Displays additional information about the adjustment.
Bill ID	Indicates the bill on which the adjustment must be created.
Arrears Date	Displays the date from when the amount is outstanding on the bill.
Char Type 1	Indicates the characteristic that must be defined for the adjustment.
Char Value 1	Displays the value of the characteristic type.
Char Type 2	Indicates the characteristic that must be defined for the adjustment.
Char Value 2	Displays the value of the characteristic type.
Char Type 3	Indicates the characteristic that must be defined for the adjustment.
Char Value 3	Displays the value of the characteristic type.
Char Type 4	Indicates the characteristic that must be defined for the adjustment.
Char Value 4	Displays the value of the characteristic type.
Char Type 5	Indicates the characteristic that must be defined for the adjustment.
Char Value 5	Displays the value of the characteristic type.

Note: If you upload an adjustment data file which exceeds the maximum file size defined in the upload request type, the system will not allow you to upload the file.

10. Click **Save**.

The validation process starts immediately. The adjustment record is considered as invalid when:

- Account ID, Account Identifier Type, Account Identifier, Adjustment Type, Currency, Bill ID, Characteristic Type, Characteristic Value, or Match Type is invalid.
- Match Type, Match Value, Adjustment Type, Adjustment Amount, Currency, or Characteristic Value is missing.
- Contract ID does not exist in the system.
- The contract is in the **Cancelled** status.
- Contract type does not exist in the system.
- Account Identifier Type, Account Identifier, or Account ID is missing when the match type is Contract Type.
- No active contract of the specified contract type is available.
- Adjustment amount precision does not match the precision (decimal positions) defined for the currency.
- The adjustment type is not included in the adjustment type profile which is attached to the contract type.

- The characteristic type is not associated with the adjustment type.

If there is an invalid record in the adjustment data file, you will not be able to upload the file.

Related Topics

For more information on...	See...
Adjustment Upload Request screen	Adjustment Upload Request (Used for Searching) on page 1443
Search Adjustment Upload Request zone	Search Adjustment Upload Request on page 1443

Replacing an Adjustment Data File

Prerequisites

To replace an existing adjustment data file, you should have:

- Upload request types defined in the application
- Adjustment data in the required CSV file format

Procedure

To replace an existing adjustment data file:

1. Click the **Menu** link in the **Actions/Navigation** area.
A list appears.
2. Select the **Main Menu** option from the list.
3. From the **Main Menu**, select **Billing Management** and then click **Adjustment Upload Request**.
The **Adjustment Upload Request** screen appears.
4. Click the **Upload** link in the upper right corner of the **Search Adjustment Upload Request** zone.

The **Adjustment Upload Data File** screen appears. It contains the following fields:

Field Name	Field Description	Mandatory (Yes or No)
Upload Request Type	Used to indicate the upload request type using which you want to upload the adjustment data file.	Yes
	Note: The list includes only those upload request types which are in the Active status.	
Replace Existing File	Used to indicate whether you want to replace any existing file in the system. You must select this check box when you want to upload the same file once again.	No
	Note: You can replace an existing file when the adjustment upload request is in the Pending or Cancelled status.	

Field Name	Field Description	Mandatory (Yes or No)
File Name	Used to specify the name and path of the adjustment data file that you want to upload.	Yes
	Note: You can also click the Browse button corresponding to this field to browse to the location where the adjustment data file is available in the system.	

5. Select the upload request type using which you want to upload the adjustment data file.
6. Select the **Replace Existing File** check box to indicate that you want to replace an existing adjustment data file.
7. Click the **Browse** button corresponding to the **File Name** field.

The **Choose File to Upload** dialog box appears.

8. Browse to the location where the adjustment data file that you want to upload is available.
9. Click **Open**.

The adjustment data file name and path appears in the **File Name** field.

10. Click **Submit**.

A grid appears which helps you to preview all records in the adjustment data file. It contains the following columns:

Column Name	Column Description
Errors	Indicates the reason why the adjustment record is invalid. If there are multiple reasons, the comma-separated list of error messages appears in this column.
	Note: This column appears when you click the Save button.
Account Identifier Type	Indicates the account identifier type.
Account Identifier	Displays the value of the account identifier type.
Account ID	Indicates the account for which the adjustment must be created.
Match Type	Indicates the match type using which the adjustment must be created.
Match Value	Indicates the entity (such as contract, contract type, and so on) against which the adjustment must be created.
Adjustment Type	Indicates the adjustment type using which the adjustment must be created.
Adjustment Amount	Displays the adjustment amount.
Currency Code	Indicates the currency in which the adjustment must be created.
Comments	Displays additional information about the adjustment.
Bill ID	Indicates the bill on which the adjustment must be created.
Arrears Date	Displays the date from when the amount is outstanding on the bill.
Char Type 1	Indicates the characteristic that must be defined for the adjustment.
Char Value 1	Displays the value of the characteristic type.
Char Type 2	Indicates the characteristic that must be defined for the adjustment.
Char Value 2	Displays the value of the characteristic type.
Char Type 3	Indicates the characteristic that must be defined for the adjustment.

Column Name	Column Description
Char Value 3	Displays the value of the characteristic type.
Char Type 4	Indicates the characteristic that must be defined for the adjustment.
Char Value 4	Displays the value of the characteristic type.
Char Type 5	Indicates the characteristic that must be defined for the adjustment.
Char Value 5	Displays the value of the characteristic type.

Note: If you upload an adjustment data file which exceeds the maximum file size defined in the upload request type, the system will not allow you to upload the file.

11. Click **Save**.

The validation process starts immediately. The adjustment record is considered as invalid when:

- Account ID, Account Identifier Type, Account Identifier, Adjustment Type, Currency, Bill ID, Characteristic Type, Characteristic Value, or Match Type is invalid.
- Match Type, Match Value, Adjustment Type, Adjustment Amount, Currency, or Characteristic Value is missing.
- Contract ID does not exist in the system.
- The contract is in the **Cancelled** status.
- Contract type does not exist in the system.
- Account Identifier Type, Account Identifier, or Account ID is missing when the match type is Contract Type.
- No active contract of the specified contract type is available.
- Adjustment amount precision does not match the precision (decimal positions) defined for the currency.
- The adjustment type is not included in the adjustment type profile which is attached to the contract type.
- The characteristic type is not associated with the adjustment type.

If there is an invalid record in the adjustment data file, you will not be able to upload the file.

Related Topics

For more information on...	See...
Adjustment Upload Request screen	Adjustment Upload Request (Used for Searching) on page 1443
Search Adjustment Upload Request zone	Search Adjustment Upload Request on page 1443

Viewing the Adjustment Upload Request Details

Procedure

To view the details of an adjustment upload request:

1. Search for an adjustment upload request in the **Adjustment Upload Request** screen.
2. In the **Search Results** section, click the link in the **Upload Request Information** column corresponding to the adjustment upload request whose details you want to view.

The **Adjustment Upload Request** screen appears. It contains the following two tabs:

- **Main** – This tab contains the following two zones:

- **Adjustment Upload Request** – Displays the details of the adjustment upload request.
 - **Adjustment Data Records** – Lists the adjustment records which are uploaded through the adjustment data file.
 - **Log** – This tab lists the complete trail of actions performed on the adjustment upload request.
3. View the details of the adjustment upload request in the **Adjustment Upload Request** zone.
 4. View the list of adjustment records which are uploaded through the adjustment data file in the **Adjustment Data Records** zone.

Related Topics

For more information on...	See...
How to search for an adjustment upload request	Searching for an Adjustment Upload Request on page 1445
Adjustment Upload Request zone	Adjustment Upload Request on page 1451
Adjustment Data Records zone	Adjustment Data Records on page 1454

Adjustment Upload Request (Used for Viewing)

The **Adjustment Upload Request** screen allows you to:

- Edit the details of an adjustment upload request
- Delete or cancel an adjustment upload request
- View the details of an adjustment upload request
- Submit an adjustment upload request for processing
- Approve or reject an adjustment upload request
- Request the submitter to resubmit an adjustment upload request for approval
- Withdraw an adjustment upload request
- View the log of an adjustment upload request
- Add a log entry for an adjustment upload request

It consists of the following tabs:

- [Adjustment Upload Request - Main](#) on page 1451
-

Adjustment Upload Request - Main

The **Main** tab displays information about the adjustment upload request. It contains the following zones:

- [Adjustment Upload Request](#) on page 1451
- [Adjustment Data Records](#) on page 1454

Adjustment Upload Request

The **Adjustment Upload Request** zone displays the details of the adjustment upload request. This zone contains the following sections:

- **Header** — This section provides basic information about the upload request. It contains the following fields:

Field Name	Field Description
Upload Request Information	<p>Displays information about the adjustment upload request. The information string contains the following comma-separated values:</p> <ul style="list-style-type: none"> • Upload Request Type Description • Status Description • Upload Request ID <p>Note: This information string is generated using the C1-FLREQ-INF algorithm which is attached to the Information system event in the adjustment upload request business object. If you want to display a different information string, you need to define a custom algorithm type and attach the algorithm in the adjustment upload request business object.</p>
Status	<p>Indicates the status of the adjustment upload request. The valid values are:</p> <ul style="list-style-type: none"> • Approved • Cancelled • Completed • Create Adjustment • Creating Adjustment • Deferred • Pending • Rejected • Pending for Approval
Status Reason	<p>Indicates the reason why the adjustment data file is cancelled or rejected.</p> <p>Note: This field appears when the adjustment upload request is in the Cancelled or Rejected status.</p>
File Name	<p>Displays the name of the adjustment data file for which the adjustment upload request is created.</p>

- **Record Actions** — This section contains the following buttons:

Button Name	Button Description
Cancel File	<p>Used to cancel an adjustment data file.</p> <p>Note: The Cancel File button appears when the adjustment upload request is in the Pending status.</p>

Button Name	Button Description
Create Adjustment	Used to create adjustments for the records which are uploaded through the adjustment data file.
	<p>Note: The Create Adjustment button appears when:</p> <ul style="list-style-type: none"> The adjustment upload request is in the Pending status. The approval workflow process is not configured for the upload request type using which the adjustment data file is uploaded.
Submit for Approval	Used to submit the adjustment data file for approval.
	<p>Note: The Submit for Approval button appears only when:</p> <ul style="list-style-type: none"> The adjustment upload request is in the Pending status. The approval workflow process is configured for the upload request type using which the adjustment data file is uploaded.
Approve	Used to approve the adjustment data file.
	<p>Note: The Approve button appears when:</p> <ul style="list-style-type: none"> The adjustment upload request is in the Pending for Approval status. A user with the approval To Do role is reviewing the adjustment data file.
Reject	Used to reject the adjustment data file.
	<p>Note: The Reject button appears when:</p> <ul style="list-style-type: none"> The adjustment upload request is in the Pending for Approval status. A user with the approval To Do role is reviewing the adjustment data file.

Note: The **Record Actions** section does not contain buttons when the status of the adjustment upload request is **Cancelled, Completed, Deferred, or Rejected**.

- **Record Information** — This section contains the following fields:

Field Name	Field Description
Business Object	Indicates the business object using which the adjustment upload request is created.
	<p>Note: It has a link. On clicking the link, the Business Object screen appears with the details of the respective business object.</p>
Status Date/Time	Displays the date and time when the adjustment upload request status is updated.
Create Date/Time	Displays the date and time when the adjustment upload request is created.

Related Topics

For more information on...	See...
How to view the details of an adjustment upload request	Viewing the Adjustment Upload Request Details on page 1450
How to cancel an adjustment data file	Cancelling an Adjustment Data File on page 1455
How to create adjustments for an adjustment data file	Creating Adjustments for an Adjustment Data File on page 1456
How to submit an adjustment data file for approval	Submitting an Adjustment Data File for Approval on page 1457
How to approve an adjustment data file	Approving an Adjustment Data File on page 1458
How to reject an adjustment data file	Rejecting an Adjustment Data File on page 1459

Adjustment Data Records

The **Adjustment Data Records** zone lists the adjustment records which are uploaded through the adjustment data file. This zone contains the following columns:

Column Name	Column Description
Adjustment Information	<p>Displays information about the adjustment that is created using the adjustment record.</p> <p>Note:</p> <p>The data appears in this column when the status of the adjustment upload request is Completed.</p> <p>It has a link. On clicking the link, the Adjustment screen appears with the details of the respective adjustment.</p> <p>The information string appears when an algorithm of the C1-ADI-INFO algorithm type is attached to the Adjustment Information system event in the Algorithms tab of the Installation Options — Framework screen.</p>
Account Identifier Type	Indicates the account identifier type.
Account Identifier	Displays the value of the account identifier type.
Account ID	Indicates the account for which the adjustment must be created.
Adjustment Match Value	Indicates the contract against which the adjustment must be created.
Adjustment Type	Indicates the adjustment type using which the adjustment must be created.
Adjustment Amount	Displays the adjustment amount.
Comments	Displays additional information about the adjustment.
Bill ID	Indicates the bill on which the adjustment must be created.
Arrears Date	Displays the date from when the amount is outstanding on the bill.
Char Type 1, Char Type 2,, Char Type 5	Indicates the characteristic that must be defined for the adjustment.
Char Value 1, Char Value 2,, Char Value 5	Displays the value of the characteristic type.

Related Topics

For more information on...	See...
How to view the details of an adjustment upload request	Viewing the Adjustment Upload Request Details on page 1450
How to view the adjustment records uploaded through an adjustment data file	Viewing All Records of an Adjustment Data File

Adjustment Upload Request - Log

The **Log** tab contains the following zone:

- [Adjustment Upload Request - Log](#) on page 1455

Adjustment Upload Request Log

The **Upload Request Log** zone lists the complete trail of actions performed on the adjustment upload request. It contains the following columns:

Column Name	Column Description
Date/Time	Displays the date and time when the action was performed on the funding request.
Details	Displays the details of the action performed on the funding request.
User	Indicates the user who has performed the action on the funding request.
Log Type	Indicates the type of log.
Related Object	Indicates the object or entity which is created when the action is performed on the funding request.
	Note: At present, no data appears in this column. The implementation team can build the custom logic to meet the business requirements.
Status Reason	Indicates the reason why the funding request was rejected by the approver.
	Note: The data appears in this column when the funding request is in the Rejected status.

Note: You can manually add a log entry for the adjustment upload request by clicking the **Add Log Entry** link in the upper right corner of the **Adjustment Upload Request Log** zone.

Related Topics

For more information on...	See...
How to view the log of an adjustment upload request	Viewing the Log of an Adjustment Upload Request on page 1460
How to add a log entry for an adjustment upload request	Adding a Log Entry for an Adjustment Upload Request on page 1461

Cancelling an Adjustment Data File

There might be situations when incorrect adjustment data file is uploaded in the system. In such case, the system provides you with an ability to cancel the file. However, note that you can cancel an adjustment data file when the adjustment upload request is in the **Pending** status.

Prerequisites

To cancel an adjustment data file, you should have:

- Cancellation reasons defined in the application

Note: While cancelling an adjustment data file, you need to specify the reason why you want to cancel the adjustment data file. You can select the appropriate cancellation reason when you have defined the reasons for the **Cancelled** status of the **C1-ADJUPLD** business object in the **Status Reason** screen.

Procedure

To cancel an adjustment data file:

1. Search for the adjustment upload request (which is created while uploading the file that you want to cancel) in the **Adjustment Upload Request** screen.
2. In the **Search Results** section, click the link in the **Upload Request Information** column corresponding to the adjustment data file that you want to cancel.

The **Adjustment Upload Request** screen appears. It contains the following two tabs:

- **Main** – This tab contains the following two zones:
 - **Adjustment Upload Request** – Displays the details of the adjustment upload request.
 - **Adjustment Data Records** – Lists the adjustment records which are uploaded through the adjustment data file.
 - **Log** – This tab lists the complete trail of actions performed on the adjustment upload request.
3. Click **Cancel File** in the **Adjustment Upload Request** zone.

The **Cancellation Information** window appears. It contains the following fields:

Field Name	Field Description	Mandatory (Yes or No)
Cancellation Reason	Used to indicate the reason why you want to cancel the adjustment data file.	Yes

Note: The **Cancel File** button appears when the adjustment upload request is in the **Pending** status.

4. Select the cancellation reason from the list.
5. Click **Save**.

The adjustment data file is cancelled. In addition, the status of the adjustment upload request is changed to **Cancelled**.

Related Topics

For more information on...	See...
How to search for an adjustment upload request	Searching for an Adjustment Upload Request on page 1445
Adjustment Upload Request zone	Adjustment Upload Request on page 1451

Creating Adjustments for an Adjustment Data File

Procedure

To create adjustments for an adjustment data file:

1. Search for the adjustment upload request (which is created while uploading the file for which you want to create adjustments) in the **Adjustment Upload Request** screen.

- In the **Search Results** section, click the link in the **Upload Request Information** column corresponding to the adjustment data file for which you want to create adjustments.

The **Adjustment Upload Request** screen appears. It contains the following two tabs:

- Main** – This tab contains the following two zones:
 - Adjustment Upload Request** – Displays the details of the adjustment upload request.
 - Adjustment Data Records** – Lists the adjustment records which are uploaded through the adjustment data file.
- Log** – This tab lists the complete trail of actions performed on the adjustment upload request.

- Click **Create Adjustment** in the **Adjustment Upload Request** zone.

The Defer algorithm attached to the upload request type using which you have uploaded the adjustment data file is triggered. If the number of records in the adjustment data file does not exceed the online record process limit (defined in the Defer algorithm), the system creates adjustments in the real time (i.e. immediately). In addition, the adjustment information string appears corresponding to each adjustment record in the **Adjustment Data Records** zone and the status of the adjustment upload request is changed to **Completed**. However, if the number of records in the adjustment data file exceeds the online record process limit, the system creates adjustments in the deferred mode and the status of the adjustment upload request is changed to **Deferred**.

Note:

Deferred mode means in the background when the **Upload Request Periodic Monitor (C1-UPLRQ)** batch is invoked. You can configure the **Upload Request Periodic Monitor (C1-UPLRQ)** batch such that it is executed at regular intervals. When the **Upload Request Periodic Monitor (C1-UPLRQ)** batch is invoked, the system checks whether there are any adjustment upload requests in the **Deferred** status. If there is an adjustment upload request in the **Deferred** status, the system creates adjustments for the adjustment data file. Once the adjustments are created, the adjustment information string appears corresponding to each adjustment record in the **Adjustment Data Records** zone and the status of the adjustment upload request is changed to **Completed**.

The **Create Adjustment** button appears when:

- The adjustment upload request is in the **Pending** status.
- The approval workflow process is not configured for the upload request type using which the adjustment data file is uploaded.

Related Topics

For more information on...	See...
How to search for an adjustment upload request	Searching for an Adjustment Upload Request on page 1445
Adjustment Upload Request zone	Adjustment Upload Request on page 1451
Adjustment Data Records zone	Adjustment Data Records on page 1454

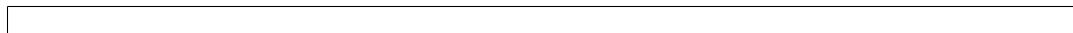

Submitting an Adjustment Data File for Approval

Procedure

To submit an adjustment data file for approval:

- Search for the adjustment upload request (which is created while uploading the file that you want to submit for approval) in the **Adjustment Upload Request** screen.

2. In the **Search Results** section, click the link in the **Upload Request Information** column corresponding to the adjustment data file that you want to submit for approval.

The **Adjustment Upload Request** screen appears. It contains the following two tabs:

- **Main** – This tab contains the following two zones:
 - **Adjustment Upload Request** – Displays the details of the adjustment upload request.
 - **Adjustment Data Records** – Lists the adjustment records which are uploaded through the adjustment data file.
- **Log** – This tab lists the complete trail of actions performed on the adjustment upload request.

3. Click **Submit for Approval** in the **Adjustment Upload Request** zone.

The status of the adjustment upload request is changed to **Pending for Approval**. A To Do is created using the **C1-ADJUP** To Do type. Users having a To Do role to which the **C1-ADJUP** To Do type is associated can view the To Do from the **To Do List** screen. On clicking the **Submitted Message** link corresponding to the To Do, the **Adjustment Upload Request** screen appears where you can review the records of the adjustment data file.

Note:

The **Submit for Approval** button appears when:

- The adjustment upload request is in the **Pending** status.
- The approval workflow process is configured for the upload request type using which the adjustment data file is uploaded.

Related Topics

For more information on...	See...
Adjustment Upload Request zone	Adjustment Upload Request on page 1451
How to search for an adjustment upload request	Searching for an Adjustment Upload Request on page 1445

Approving an Adjustment Data File

Procedure

To approve an adjustment data file:

1. Search for the adjustment upload request (which is created while uploading the file that you want to review) in the **Adjustment Upload Request** screen.
2. In the **Search Results** section, click the link in the **Upload Request Information** column corresponding to the adjustment data file that you want to review.

The **Adjustment Upload Request** screen appears. It contains the following two tabs:

- **Main** – This tab contains the following two zones:
 - **Adjustment Upload Request** – Displays the details of the adjustment upload request.
 - **Adjustment Data Records** – Lists the adjustment records which are uploaded through the adjustment data file.
- **Log** – This tab lists the complete trail of actions performed on the adjustment upload request.

3. Review the records of the adjustment data file in the **Adjustment Data Records** zone.
4. If the adjustment data file is appropriate, then click **Approve** in the **Adjustment Upload Request** zone.

The Defer algorithm attached to the upload request type using which you have uploaded the adjustment data file is triggered. If the number of records in the adjustment data file does not exceed the online record process limit (defined in the Defer algorithm), the system creates adjustments in the real time (i.e. immediately). In addition, the adjustment information string appears corresponding to each adjustment record in the **Adjustment Data Records** zone and the status of the adjustment upload request is changed to **Completed**. However, if the number of records in the adjustment data file exceeds the online record process limit, the system creates adjustments in the deferred mode and the status of the adjustment upload request is changed to **Deferred**.

Note:

Deferred mode means in the background when the **Upload Request Periodic Monitor (C1-UPLRQ)** batch is invoked. You can configure the **Upload Request Periodic Monitor (C1-UPLRQ)** batch such that it is executed at regular intervals. When the **Upload Request Periodic Monitor (C1-UPLRQ)** batch is invoked, the system checks whether there are any adjustment upload requests in the **Deferred** status. If there is an adjustment upload request in the **Deferred** status, the system creates adjustments for the adjustment data file. Once the adjustments are created, the adjustment information string appears corresponding to each adjustment record in the **Adjustment Data Records** zone and the status of the adjustment upload request is changed to **Completed**.

The **Approve** button appears when:

- The adjustment upload request is in the **Pending for Approval** status.
- A user with the approval To Do role is reviewing the adjustment data file.

Related Topics

For more information on...	See...
How to search for an adjustment upload request	Searching for an Adjustment Upload Request on page 1445
Adjustment Upload Request zone	Adjustment Upload Request on page 1451
Adjustment Data Records zone	Adjustment Data Records on page 1454

Rejecting an Adjustment Data File

Prerequisites

To reject an adjustment data file, you should have:

- Rejection reasons defined in the application

Note:

While rejecting an adjustment data file, you need to specify the reason why you want to reject the adjustment data file. You can select the appropriate rejection reason when you have defined the reasons for the **Rejected** status of the **C1-ADJUPLD** business object in the **Status Reason** screen.

The system does not allow the submitter to approve or reject the adjustment data file.

Procedure

To reject an adjustment data file:

1. Search for the adjustment upload request (which is created while uploading the file that you want to review) in the **Adjustment Upload Request** screen.
2. In the **Search Results** section, click the link in the **Upload Request Information** column corresponding to the adjustment data file that you want to review.

The **Adjustment Upload Request** screen appears. It contains the following two tabs:

- **Main** – This tab contains the following two zones:
 - **Adjustment Upload Request** – Displays the details of the adjustment upload request.
 - **Adjustment Data Records** – Lists the adjustment records which are uploaded through the adjustment data file.
 - **Log** – This tab lists the complete trail of actions performed on the adjustment upload request.
3. Review the records of the adjustment data file in the **Adjustment Data Records** zone.
 4. If the adjustment data file is not appropriate, then click **Reject** in the **Adjustment Upload Request** zone.

The **Rejection Information** window appears. It contains the following fields:

Field Name	Field Description	Mandatory (Yes or No)
Rejection Reason	Used to indicate the reason why you want to reject the adjustment data file.	Yes

Note:

The **Reject** button appears when:

- The adjustment upload request is in the **Pending for Approval** status.
- A user with the approval To Do role is reviewing the adjustment data file.

5. Select the rejection reason from the list.
6. Click **Save**.

The adjustment data file is rejected. In addition, the status of the adjustment upload request is changed to **Rejected**.

Related Topics

For more information on...	See...
Adjustment Upload Request zone	Adjustment Upload Request on page 1451
Adjustment Data Records zone	Adjustment Data Records on page 1454
How to search for an adjustment upload request	Searching for an Adjustment Upload Request on page 1445

Viewing the Log of an Adjustment Upload Request

Procedure

To view the log of an adjustment upload request:

1. Search for the adjustment upload request in the **Adjustment Upload Request** screen.
2. In the **Search Results** section, click the link in the **Upload Request Information** column corresponding to the adjustment upload request whose log you want to view.

The **Adjustment Upload Request** screen appears. It contains the following two tabs:

- **Main** – This tab contains the following two zones:
 - **Adjustment Upload Request** – Displays the details of the adjustment upload request.

- **Adjustment Data Records** – Lists the adjustment records which are uploaded through the adjustment data file.
 - **Log** – This tab lists the complete trail of actions performed on the adjustment upload request.
3. Click the **Log** tab.

The **Upload Request Log** zone in the **Log** tab contains the following columns:

Column Name	Column Description
Date/Time	Displays the date and time when the action was performed on the adjustment upload request.
Details	Displays the details about the action performed on the adjustment upload request.
User	Indicates the user who has performed the action on the adjustment upload request.
Log Type	Indicates the type of log.
Related Object	Indicates the object or entity which is generated when the action is performed on the adjustment upload request.
Status Reason	Indicates the reason why the adjustment upload request was rejected or cancelled.

Note: You can manually add a log entry for the adjustment upload request by clicking the **Add Log Entry** link in the upper right corner of the **Upload Request Log** zone.

Related Topics

For more information on...	See...
How to search for an adjustment upload request	Searching for an Adjustment Upload Request on page 1445
How to add a log entry for an adjustment upload request	Adding a Log Entry for an Adjustment Upload Request on page 1461

Adding a Log Entry for an Adjustment Upload Request

Procedure

To add a log entry for an adjustment upload request:

1. Search for the adjustment upload request in the **Adjustment Upload Request** screen.
2. In the **Search Results** section, click the link in the **Upload Request Information** column corresponding to the adjustment upload request whose log you want to edit.

The **Adjustment Upload Request** screen appears. It contains the following two tabs:

- **Main** – This tab contains the following two zones:
 - **Adjustment Upload Request** – Displays the details of the adjustment upload request.
 - **Adjustment Data Records** – Lists the adjustment records which are uploaded through the adjustment data file.
- **Log** – This tab lists the complete trail of actions performed on the adjustment upload request.

3. Click the **Log** tab.

The **Log** tab appears.

4. Click the **Add Log Entry** link in the upper right corner of the **Upload Request Log** zone.

The **Add Request Log** window appears. It contains the following fields:

Field Name	Field Description	Mandatory (Yes or No)
Request Information	Displays information about the adjustment upload request.	Not applicable
Log Details	Used to specify additional comments for the adjustment upload request.	Yes

5. Enter the comments in the **Log Details** field.

6. Click **Save**.

The log entry is added in the **Upload Request Log** zone.

Related Topics

For more information on...	See...
How to search for an adjustment upload request	Searching for an Adjustment Upload Request on page 1445

Chapter 20

Payment Request

Topics:

- [Prerequisites](#)
- [Payment Request \(Without Approval\) Status Transition](#)
- [Payment Request \(With Approval\) Status Transition](#)
- [Algorithms Used in C1-PaymentRequest](#)
- [Algorithms Used in C1-PaymentTransferRequest](#)
- [Payment Request Type](#)
- [Payment Request \(Used for Searching\)](#)
- [Payment Request \(Used for Viewing\)](#)
- [Payment Event Summary](#)

Oracle Revenue Management and Billing facilitates you to create and transfer payments through a payment request. While creating a payment creation or transfer request, you need to specify the payment request type using which you want to create the payment request. It is the payment request type which helps the system to determine:

- Whether to create payment transfer or payment creation request
- Whether payment events and payments must be created in real time (i.e. immediately) or in the deferred mode
- Whether payment creation or transfer instructions must be approved by the approver before freezing the payments

While creating a payment creation request, you need to specify the tender amount and match type details. However, while creating a payment transfer request, you need to specify the transfer amount and match type details. The **Payment Request** feature supports the following match types :

- By Bill Regular (Match Entity: Account)
- By Bill (Match Entity: Bill)
- By Bill Weighted (Match Entity: Account)
- By Bill Segments (Match Entity: Account)
- By Suspense Contract (Match Entity: Account)
- By Settlement ID (Match Entity: Account)

You can specify multiple match types along with the entity (such as account or bill) in the payment request. Depending on the match type and match entity selected, the entities (such as unpaid bills, bill segments, or contracts) of the account are considered against which you can match the tender or transfer (payment) amount. Once you update the payment amount against the required entities, you can distribute the tender or payment amount.

On distributing the tender amount, the payment event, payments, payment segments, and payment tender are created. The payments are created in the **Freezable** status. If any error occurs while creating a payment, the payment is created in the **Error** status. If all payments of a payment event are in the **Freezable** status, the status of the payment event is set to **Balanced**. However, if any payment of a payment event is in the **Error** status, the status of the payment event is set to **Unbalanced**. On distributing the payment amount (during transfer), the new payments are created in the **Freezable** status. If any error occurs while creating a new payment, the payment is created in the **Error** status. The status of the payment event is set to **Unbalanced**. The old payments in the payment event that you want to transfer remains in the **Frozen** or **Error** status.

The system allows you to view the pay segments of a payment and edit the pay segment amount, if required. You can edit the pay segment amount before submitting the payment request for approval or before freezing the payments. If the approval is not required for the payment request, you can directly freeze the payments created through the payment request. However, if the approval is required for the payment request, you need to submit the payment request for approval. Based on the observations, the approver might approve or reject the payment request. On approving a payment creation request or freezing the payments, the status of the payments is changed from **Freezable** to **Frozen**. However, on approving a payment transfer request or freezing the payments, the system does the following:

- Changes the status of the old payments which are in the **Frozen** status to **Cancelled**
- Deletes the old payments which are in the **Error** status
- Changes the status of the new payments which are in the **Freezable** status to **Frozen**
- Changes the status of the payment event to **Balanced** when there are no payments in the **Error** status

On rejecting a payment creation request, the payment event, payments, payment segments, and payment tender which are created through the payment creation request are deleted. However, on rejecting a payment transfer request, the new payments which are created through the payment transfer request are deleted.

During the payment request process, a payment creation or transfer request goes through various statuses in its lifecycle. For more information about the payment request statuses, see [Payment Request \(Without Approval\) Status Transition](#) on page 1466 and [Payment Request \(With Approval\) Status Transition](#) on page 1467.

Note that the lifecycle of a payment creation and transfer requests is driven by the respective business object using which the payment creation and transfer requests are created. The **C1-PaymentRequest** and **C1-PaymentTransferRequest** business objects are shipped with the product. The payment request feature explained in this document is articulated based on the lifecycle and logic defined in the **C1-PaymentRequest** and **C1-PaymentTransferRequest** business objects.

For more information on how to setup the payment request process, see [Prerequisites](#) on page 1465.

Prerequisites

To setup the payment request process, you need to do the following:

- Define the following match types:

Match Type	Description	Payment Distribution Override Algorithm	Manual Distribution Algorithm	Entity Type	Match Type Search Zone	Entity Flag
BILLR	By Bill Regular	C1-PDOV-PYBL	C1-MD-BILL	Account	C1_ACCTSRCH	Bill
BILLW	By Bill Weighted	C1-PDOV-WTBS	C1-MD-BILL	Account	C1_ACCTSRCH	Bill
BILL-WO	By Bill Weighted Outstanding Amount	C1-PDOV-WTOA		Account	C1_ACCT_SRCH	Bill
BILLSEG	By Bill Segment	C1-PDOV-PYBS	C1-MD-BSEG	Account	C1_ACCTSRCH	Bill Segment
BYSATY	By Suspense Contract	C1-PDOV-SATY	C1-MD-ONSA	Account	C1_ACCTSRCH	Contract
SETT-ID	By Settlement ID	C1-PDOV-PYSL	C1-MD-SID	Account	C1_ACCTSRCH	Settlement
BYBILL	By Bill	C1-PDOV-PYBL or C1-PDOV-WTBS	C1-MDBYBILL	Bill	CI_BILL	Bill
BILL-BS	By Bill - Pay By Bill Segment Oldest	C1-PDOV-BSDT		Account	C1_ACCT_SRCH	Bill

Note: The **C1-PDOV-BSDT** algorithm for the bill match type **BILL-BS** is used to distribute the amount among the bill segments of the bill in the order of bill segment start date.

Note: The **C1-PDOV-WTOA** algorithm for the bill match type **BILL-WOA** performs the bill weighted calculation based on the unpaid amount on the bill segment.

- Create a defer algorithm using the **C1-PAY-COUNT** algorithm type
- Define the required payment request types in the system
- Define the required characteristic types where the characteristic entity is set to **Payment Request Type**
- Define the required characteristic types where the characteristic entity is set to **Payment Tender**
- Define rejected status reasons for the **C1-PaymentRequest** business object
- Define rejected status reasons for the **C1-PaymentTransferRequest** business object
- Define payment cancelation or transfer reasons through the **Payment Cancel Reason** screen

- Assign the **C1-PAYRQ** To Do type to a To Do role whose users must receive To Do generated while submitting a payment request for approval
- Set the **Payment Portal Configuration (C1-PAYPORTAL)** feature configuration
- Set the **Payment Request-Sort Distribution data (C1-PYREQSRT)** feature configuration
- Set the batch control type of the **Payment Request Periodic Monitor (C1-PAYRQ)** batch to **Timed** and define the following attributes:
 - Time Interval
 - Timer Active
 - User ID
 - Batch Language
 - Email Address

Related Topics

For more information on...	See...
How to set the C1-PAYPORTAL feature configuration	Setting the C1-PAYPORTAL Feature Configuration on page 3460
How to set the C1-PYREQSRT feature configuration	Setting the C1-PYREQSRT Feature Configuration on page 3468

Payment Request (Without Approval) Status Transition

The following figure graphically indicates how a payment creation or transfer request moves from one status to another when the approval workflow is off:

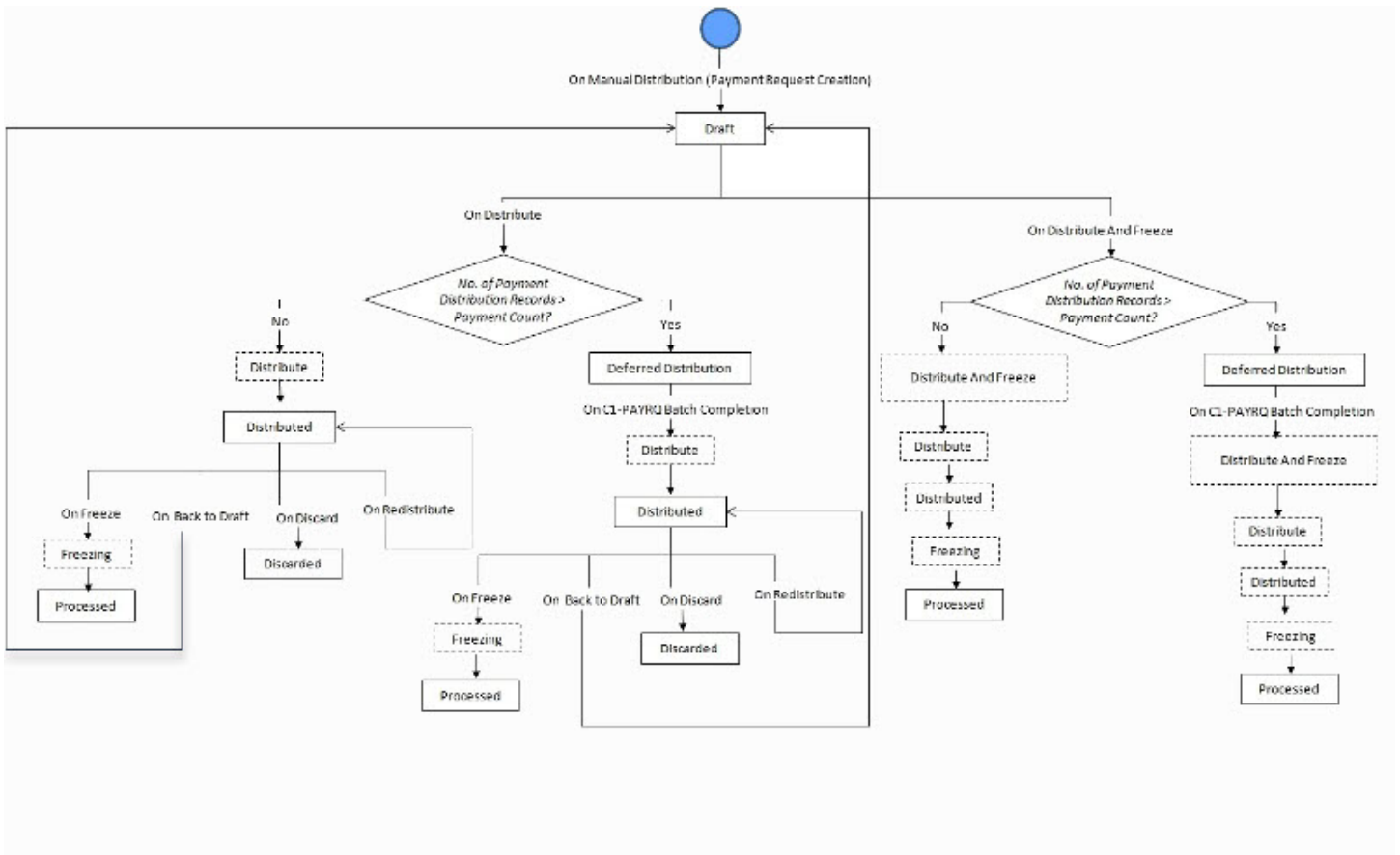

Payment Request (With Approval) Status Transition

The following figure graphically indicates how a payment creation or transfer request moves from one status to another when approval workflow is on:

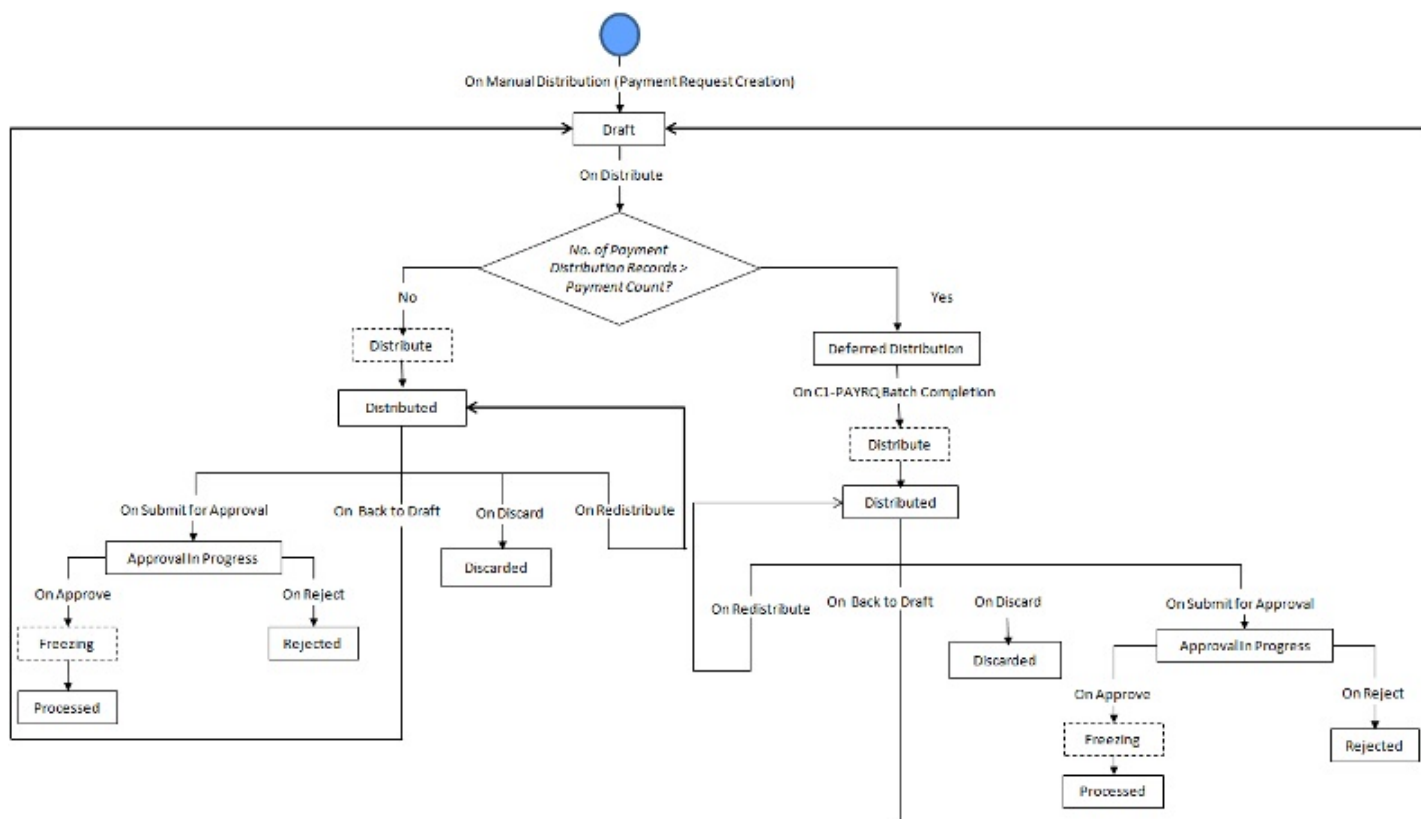

Algorithms Used in C1-PaymentRequest

The following table lists the algorithms which are attached to the **C1-PaymentRequest** business object:

System Event	Algorithm	Algorithm Type	Description
Information	C1-PAYRQ-INF	C1-PAYRQ-INF	This algorithm generates the payment request information string which appears throughout the application. This algorithm concatenates the following fields: <ul style="list-style-type: none"> • Payment Request Type Description • Payment Request Status Description • Payment Request ID
Post-Processing	C1-PAYREQPOS	C1-PAYREQPOS	This algorithm invokes the manual distribution algorithm of the match types that are newly added while editing a payment request. It also deletes the respective match type entities from the C1_PAY_DISTRIBUTION table when you remove a match type while editing a payment request.

System Event	Algorithm	Algorithm Type	Description
Validation	C1-PAYREQVAL	C1-PAYREQVAL	<p>This algorithm checks whether the mandatory data (such as payment date, payor account, tender type, tender amount, currency, match type, and match entity) is specified while creating a payment request. It also checks whether auto pay source, auto pay route type, and account number are specified when you select a tender type where the Generate Auto Pay option is selected. This algorithm is triggered when you click the Manual Distribution button.</p> <p>Note: You do not specify the tender and auto pay details while creating a payment transfer request.</p>

The following table lists the algorithms which are used in the lifecycle of the **C1-PaymentRequest** business object:

Status	System Event	Algorithm	Algorithm Type	Description
Draft	Enter	C1-PAY-DFT	C1-PAY-DFT	This algorithm invokes the manual distribution algorithm of the match types that you have selected while creating a payment request.
Draft	Exit	C1-PAYDFTEXT	C1-PAYDFTEXT	This algorithm checks whether the sum of the distributed payment amount is equal to the tender or transfer amount. This algorithm is triggered when you click the Distribute button.
Approval In Progress	Enter	C1-PAY-PFA	C1-PAY-PFA	This algorithm creates the To Do using the To Do type specified in the payment request type using which the payment request is created. The To Do is sent to the users with the approval To Do role specified in the payment request type.
Approval In Progress	Exit	C1-PAYPFAEXT	C1-PAYPFAEXT	This algorithm checks whether the approver is associated with the approval To Do role specified in the payment request type. It does not allow the submitter to approve or reject the payment request.
Approval In Progress	Exit	F1-TODOCOMPL	F1-TODOCOMPL	This algorithm type completes To Do entries that are linked to an object when the object exits a given state. The system finds all open To Do entries with drill keys for the current business object's primary key, and completes them, unless the To Do entry's type has been configured with an Exclude To Do Type Characteristic Type indicating that it should not be automatically completed.

Status	System Event	Algorithm	Algorithm Type	Description
Approved	Enter	C1-PAY-APP	C1-PAY-APP	This algorithm changes the status of the payment request to Freezing when the approver clicks the Approve button.
Distribute	Enter	C1-PAY-DIST	C1-PAY-DIST	This algorithm invokes the defer algorithm specified in the payment request type using which the payment request is created. The defer algorithm checks whether the tender or transfer amount must be distributed in the real time (i.e. immediately) or in the deferred mode. If the tender or transfer amount must be distributed in the real time, the status of the payment request is changed to Distributed . However., if the tender or transfer amount must be distributed in the deferred mode, the status of the payment request is changed to Deferred Distribution .
Deferred Distribution	Monitor	C1-PAY-MONT	C1-PAY-MONT	This algorithm is invoked from the Payment Request Periodic Monitor (C1-PAYRQ) batch. It changes the status of the payment request from Deferred Distribution to Distributed .
Distributed	Enter	C1-PAYCREATE	C1-PAYCREATE	This algorithm creates the payment event, payments, payment segments, and payment tender. A payment is created for each record in the C1_PAY_DISTRIBUTION table where the payment amount is greater than or less than zero. The status of the payments is set to Freezable . If any error occurs while creating a payment, the status of the payment is set to Error . The payment event ID is updated corresponding to the payment request in the C1_PAY_REQ table. Finally, the status of the payment request is changed to Distributed .
Distributed	Exit	C1-FRZ-VALID	C1-FRZ-VALID	This algorithm is triggered when you click the Submit for Approval or Freeze button. It checks whether the sum of payment segment amount is equal to the payment amount for each payment.

Status	System Event	Algorithm	Algorithm Type	Description
Distributed	Exit	F1-TODOCOMPL	F1-TODOCOMPL	This algorithm completes To Do entries that are linked to an object when the object exits a given state. The system finds all open To Do entries with drill keys for the current business object's primary key, and completes them, unless the To Do entry's type has been configured with an Exclude To Do Type Characteristic Type indicating that it should not be automatically completed.
Freezing	Enter	C1-PAY-V-FRZ	C1-PAY-V-FRZ	This algorithm validates whether payment already exists on the entity. It checks the unpaid amount of the entity.
Freezing	Enter	C1-PAY-FRZ	C1-PAY-FRZ	<p>This algorithm fetches the payment event created through the payment request. If you are freezing the payments of a payment creation request, this algorithm does the following:</p> <ul style="list-style-type: none"> • Changes the status of the payments which are in the Freezable status to Frozen • Changes the status of the payment event to Balanced when there are no payments in the Error status <p>However, if you are freezing the payments of a payment transfer request, this algorithm does the following:</p> <ul style="list-style-type: none"> • Changes the status of the old payments which are in the Frozen status to Cancelled • Deletes the old payments which are in the Error status • Changes the status of the new payments which are in the Freezable status to Frozen • Changes the status of the payment event to Balanced when there are no payments in the Error status
Processed	-	-	-	-

Status	System Event	Algorithm	Algorithm Type	Description
Rejected	Enter	C1-PAY-RJT	C1-PAY-RJT	This algorithm is triggered when the approver clicks the Reject button. If you are rejecting a payment creation request, this algorithm deletes the payment event, payments, payment segments, and payment tender which are created through the payment creation request. However, if you are rejecting a payment transfer request, this algorithm deletes the new payments which are created through the payment transfer request.
Discarded	Enter	C1-PAY-RJT	C1-PAY-RJT	This algorithm is triggered when the approver clicks the Reject button. If you are rejecting a payment creation request, this algorithm deletes the payment event, payments, payment segments, and payment tender which are created through the payment creation request. However, if you are rejecting a payment transfer request, this algorithm deletes the new payments which are created through the payment transfer request.
Distribute And Freeze	Enter	C1-ISFREEZE	C1-ISFREEZE	This algorithm invokes the distribute algorithm and set Flag in the payment request clob.

Algorithms Used in C1-PaymentTransferRequest

The following table lists the algorithms which are attached to the **C1-PaymentTransferRequest** business object:

System Event	Algorithm	Algorithm Type	Description
Information	C1-PAYRQ-INF	C1-PAYRQ-INF	This algorithm generates the payment request information string which appears throughout the application. This algorithm concatenates the following fields: <ul style="list-style-type: none"> • Payment Request Type Description • Payment Request Status Description • Payment Request ID
Post-Processing	C1-PAYREQPOS	C1-PAYREQPOS	This algorithm invokes the manual distribution algorithm of the match types that are newly added while editing a payment request. It also deletes the respective match type entities from the C1_PAY_DISTRIBUTION table when you remove a match type while editing a payment request.

System Event	Algorithm	Algorithm Type	Description
Validation	C1-PAYREQVAL	C1-PAYREQVAL	<p>This algorithm checks whether the mandatory data (such as payment date, payor account, tender type, tender amount, currency, match type, and match entity) is specified while creating a payment request. It also checks whether auto pay source, auto pay route type, and account number are specified when you select a tender type where the Generate Auto Pay option is selected. This algorithm is triggered when you click the Manual Distribution button.</p> <p>Note: You do not specify the tender and auto pay details while creating a payment transfer request.</p>

The following table lists the algorithms which are used in the lifecycle of the **C1-PaymentTransferRequest** business object:

Status	System Event	Algorithm	Algorithm Type	Description
Draft	Enter	C1-PAY-DFT	C1-PAY-DFT	This algorithm invokes the manual distribution algorithm of the match types that you have selected while creating a payment request.
Draft	Exit	C1-PAYDFTEXT	C1-PAYDFTEXT	This algorithm checks whether the sum of the distributed payment amount is equal to the tender or transfer amount. This algorithm is triggered when you click the Distribute button.
Approval In Progress	Enter	C1-PAY-PFA	C1-PAY-PFA	This algorithm creates the To Do using the To Do type specified in the payment request type using which the payment request is created. The To Do is sent to the users with the approval To Do role specified in the payment request type.
Approval In Progress	Exit	C1-PAYPFAEXT	C1-PAYPFAEXT	This algorithm checks whether the approver is associated with the approval To Do role specified in the payment request type. It does not allow the submitter to approve or reject the payment request.

Status	System Event	Algorithm	Algorithm Type	Description
Approval In Progress	Exit	F1-TODOCOMPL	F1-TODOCOMPL	This algorithm type completes To Do entries that are linked to an object when the object exits a given state. The system finds all open To Do entries with drill keys for the current business object's primary key, and completes them, unless the To Do entry's type has been configured with an Exclude To Do Type Characteristic Type indicating that it should not be automatically completed.
Approved	Enter	C1-PAY-APP	C1-PAY-APP	This algorithm changes the status of the payment request to Freezing when the approver clicks the Approve button.
Distribute	Enter	C1-PAY-DIST	C1-PAY-DIST	This algorithm invokes the defer algorithm specified in the payment request type using which the payment request is created. The defer algorithm checks whether the tender or transfer amount must be distributed in the real time (i.e. immediately) or in the deferred mode. If the tender or transfer amount must be distributed in the real time, the status of the payment request is changed to Distributed . However., if the tender or transfer amount must be distributed in the deferred mode, the status of the payment request is changed to Deferred Distribution .
Deferred Distribution	Monitor	C1-PAY-MONT	C1-PAY-MONT	This algorithm is invoked from the Payment Request Periodic Monitor (C1-PAYRQ) batch. It changes the status of the payment request from Deferred Distribution to Distributed .

Status	System Event	Algorithm	Algorithm Type	Description
Distributed	Enter	C1-PAYTRANS	C1-PAYTRANS	This algorithm is invoked when the status of the payment transfer request is changed to Distributed . A payment is created for each record in the C1_PAY_DISTRIBUTION table where the payment amount is greater than or less than zero. The status of the new payments is set to Freezable . If any error occurs while creating a payment, the status of the payment is set to Error . The payment event ID is updated corresponding to the payment request in the C1_PAY_REQ table. Finally, the status of the payment request is changed to Distributed .
Distributed	Exit	C1-FRZ-VALID	C1-FRZ-VALID	This algorithm is triggered when you click the Submit for Approval or Freeze button. It checks whether the sum of payment segment amount is equal to the payment amount for each payment.
Distributed	Exit	F1-TODOCOMPL	F1-TODOCOMPL	This algorithm type completes To Do entries that are linked to an object when the object exits a given state. The system finds all open To Do entries with drill keys for the current business object's primary key, and completes them, unless the To Do entry's type has been configured with an Exclude To Do Type Characteristic Type indicating that it should not be automatically completed.
Freezing	Enter	C1-PAY-V-FRZ	C1-PAY-V-FRZ	This algorithm validates the payment that already exists on the entity. It checks the unpaid amount of the entity.

Status	System Event	Algorithm	Algorithm Type	Description
Freezing	Enter	C1-PAY-FRZ	C1-PAY-FRZ	<p>This algorithm fetches the payment event created through the payment request. If you are freezing the payments of a payment creation request, this algorithm does the following:</p> <ul style="list-style-type: none"> • Changes the status of the payments which are in the Freezable status to Frozen • Changes the status of the payment event to Balanced when there are no payments in the Error status <p>However, if you are freezing the payments of a payment transfer request, this algorithm does the following:</p> <ul style="list-style-type: none"> • Changes the status of the old payments which are in the Frozen status to Cancelled • Deletes the old payments which are in the Error status • Changes the status of the new payments which are in the Freezable status to Frozen • Changes the status of the payment event to Balanced when there are no payments in the Error status
Processed	-	-	-	-
Rejected	Enter	C1-PAY-RJT	C1-PAY-RJT	<p>This algorithm is triggered when the approver clicks the Reject button. If you are rejecting a payment creation request, this algorithm deletes the payment event, payments, payment segments, and payment tender which are created through the payment creation request. However, if you are rejecting a payment transfer request, this algorithm deletes the new payments which are created through the payment transfer request.</p>

Status	System Event	Algorithm	Algorithm Type	Description
Discarded	Enter	C1-PAY-RJT	C1-PAY-RJT	This algorithm is triggered when the approver clicks the Reject button. If you are rejecting a payment creation request, this algorithm deletes the payment event, payments, payment segments, and payment tender which are created through the payment creation request. However, if you are rejecting a payment transfer request, this algorithm deletes the new payments which are created through the payment transfer request.
Distribute And Freeze	Enter	C1-ISFREEZE	C1-ISFREEZE	This algorithm invokes the distribute algorithm and set Flag in payment request clob.
Cancel	-	-	-	-

Payment Request Type

Oracle Revenue Management and Billing allows you to define a payment request type using which you can create a payment request. A payment request of the specified payment request type is created when you manually distribute the tender or payment amount. It is the payment request type which helps the system to determine:



- Whether to create payment transfer or payment creation request
- Whether payment events and payments must be created in real time (i.e. immediately) or in the deferred mode
- Whether payment creation or transfer instructions must be approved by the approver before freezing payments

The **Payment Request Type** screen allows you to define, edit, copy, and delete a payment request type. This screen consists of the following zones:

- [Payment Request Type List](#) on page 1477
- [Payment Request Type](#) on page 1478

Payment Request Type List

The **Payment Request Type List** zone lists payment request types that are already defined in the system. It contains the following columns:

Column Name	Column Description
Payment Request Type	Displays the payment request type.
Description	Displays the description of the payment request type.
Edit	On clicking the Edit  icon, the Payment Request Type screen appears where you can edit the details of the payment request type.
Duplicate	On clicking the Duplicate  icon, the Payment Request Type screen appears where you can define a payment request type using an existing payment request type.

Column Name	Column Description
Delete	On clicking the Delete (🗑️) icon, you can delete the payment request type.
	Note: You can delete a payment request type when you have not created a payment request using the payment request type.

On clicking the **Broadcast** (📡) icon corresponding to a payment request type, the **Payment Request Type** zone appears with the details of the respective payment request type.

Related Topics

For more information on...	See...
How to define a payment request type	Defining a Payment Request Type on page 1480
How to edit a payment request type	Editing a Payment Request Type on page 1484
How to copy a payment request type	Copying a Payment Request Type on page 1487
How to delete a payment request type	Deleting a Payment Request Type on page 1490
How to view the details of a payment request type	Viewing the Payment Request Type Details on page 1491

Payment Request Type

The **Payment Request Type** zone displays the details of the payment request type. This zone contains the following sections:

- **Main** — This section provides basic information about the payment request type. It contains the following fields:

Field Name	Field Description
Payment Request Type	Displays the payment request type.
Payment Request Business Object	Indicates the business object that will be used to create the payment request. Note: It has a link. On clicking the link, the Business Object screen appears where you can view the details of the respective business object.
Description	Displays the description of the payment request type.
Detailed Description	Displays additional information about the payment request type.
Status	Indicates the status of the payment request type. The valid values are: <ul style="list-style-type: none"> • Active • Inactive
Transfer	Indicates whether the payment request type will be used to create payment transfer or payment creation request.

Field Name	Field Description
Defer Algorithm	<p>Indicates the algorithm that will be triggered when you distribute tender or payment amount. This algorithm checks whether the number of payment distribution records in the payment request exceeds the payment count (defined in the Defer algorithm). If the number of payment distribution records in the payment request does not exceed the payment count, the system distributes tender or payment amount and accordingly creates payment event and payments in real time (i.e. immediately). However, if the number of payment distribution records in the payment request exceeds the payment count, the system distributes tender or payment amount in the deferred mode.</p> <p>Note:</p> <p>Number of payment distribution records = (Number of bill segments present in each bill fetched using the Bill Weighted, Bill Regular, and Bill match type algorithm) + (Number of bill segments fetched using the Bill Segment match type algorithm) + (Number of contracts fetched using the Suspense Contract match type algorithm) + (Number of settlements fetched using the Settlement match type algorithm)</p> <p>It has a link. On clicking the link, the Algorithm screen appears where you can view the details of the respective algorithm.</p>
Approval Required	Indicates whether approval is required while freezing payments of the payment requests which are created using the payment request type.
Approval To Do Type	<p>Indicates that To Do of the specified To Do type must be created when you submit the payment request for approval.</p> <p>Note:</p> <p>This field appears when the Approval Required check box is selected.</p> <p>It has a link. On clicking the link, the To Do Type screen appears with the details of the respective To Do type.</p>
Approval To Do Role	<p>Indicates that users with the specified To Do role can only approve the payment request submitted for approval.</p> <p>Note:</p> <p>This field appears when the Approval Required check box is selected.</p> <p>It has a link. On clicking the link, the To Do Role screen appears where you can view the details of the respective To Do role.</p>

- **Characteristics** — This section lists the characteristics of the payment request type. It contains the following columns:

Column Name	Column Description
Characteristic Type	Indicates the characteristic type.
Characteristic Value	Displays the value of the characteristic type.

- **Record Actions** — This section contains the following buttons:

Button Name	Button Description
Edit	Used to edit the details of the payment request type.

Button Name	Button Description
Delete	Used to delete the payment request type.
	Note: You can delete a payment request type when you have not created a payment request using the payment request type.
Duplicate	Used to create a new payment request type using an existing payment request type.

- **Record Information** — This section contains the following fields:

Field Name	Field Description
Business Object	Indicates the business object using which the payment request type is created. In addition, a context menu appears corresponding to this field which helps in navigating to other screens in the application.
	Note: It has a link. On clicking the link, the Business Object screen appears where you can view the details of the respective business object.

By default, the **Payment Request Type** zone does not appear in the **Payment Request Type** screen. It appears when you click the **Broadcast** () icon corresponding to a payment request type in the **Payment Request Type List** zone.

Related Topics

For more information on...	See...
How to define a payment request type	Defining a Payment Request Type on page 1480
How to edit a payment request type	Editing a Payment Request Type on page 1484
How to copy a payment request type	Copying a Payment Request Type on page 1487
How to delete a payment request type	Deleting a Payment Request Type on page 1490
How to view the details of a payment request type	Viewing the Payment Request Type Details on page 1491

Defining a Payment Request Type

Prerequisites

To define a payment request type, you should have:

- Payment request business objects defined in the application
- Defer algorithm defined using the **C1-PAY-COUNT** algorithm type
- **C1-PAYRQ** To Do type assigned to a To Do role whose users must receive To Do generated while submitting a payment request for approval

Procedure

To define a payment request type:

1. Click the **Admin** link in the **Application** toolbar.
A list appears.
2. From the **Admin** menu, select **P** and then click **Payment Request Type**.
A sub-menu appears.
3. Click the **Add** option from the **Payment Request Type** sub-menu.
The **Select Business Object** screen appears. It contains the following fields:

Field Name	Field Description	Mandatory (Yes or No)
Payment Request Type Business Object	Used to indicate the business object that you want to use to create the payment request type.	Yes

Tip: Alternatively, you can access the **Select Business Object** screen by clicking the **Add** button in the **Page Title** area of the **Payment Request Type** screen.

Note: The **Select Business Object** screen appears when there are multiple payment request type business objects defined in the application. If there is only one payment request type business object defined in the application, the **Payment Request Type** screen appears.

4. Select the required payment request type business object from the respective field.
5. Click **OK**.

The **Payment Request Type** screen appears. It contains the following sections:

- **Main** - Used to specify basic details about the payment request type.
- **Characteristics** - Used to define the characteristics for the payment request type.

The **Main** section contains the following fields:

Field Name	Field Description	Mandatory (Yes or No)
Payment Request Type	Used to specify the payment request type.	Yes
Business Object	Indicates the payment request type business object used while defining the payment request type.	Not applicable
Payment Request Business Object	Used to indicate the business object that you want to use while creating the payment request.	Yes
Description	Used to specify the description for the payment request type.	Yes
Detailed Description	Used to specify additional information about the payment request type.	No
Status	Used to indicate the status of the payment request type. The valid values are: <ul style="list-style-type: none"> • Active • Inactive 	Yes
Transfer	Used to indicate whether the payment request type will be used to create payment transfer or payment creation request.	No

Field Name	Field Description	Mandatory (Yes or No)
Defer Algorithm	<p>Used to attach an algorithm that will be triggered when you distribute tender or payment amount. This algorithm checks whether the number of payment distribution records in the payment request exceeds the payment count (defined in the Defer algorithm). If the number of payment distribution records in the payment request does not exceed the payment count, the system distributes tender or payment amount and accordingly creates payment event and payments in real time (i.e. immediately). However, if the number of payment distribution records in the payment request exceeds the payment count, the system distributes tender or payment amount in the deferred mode.</p> <p>Note:</p> <p>Number of payment distribution records = (Number of bill segments present in each bill fetched using the Bill Weighted, Bill Regular, and Bill match type algorithm) + (Number of bill segments fetched using the Bill Segment match type algorithm) + (Number of contracts fetched using the Suspense Contract match type algorithm) + (Number of settlements fetched using the Settlement match type algorithm)</p> <p>Deferred mode means in the background when the Payment Request Periodic Monitor (C1-PAYRQ) batch is invoked. You can configure the Payment Request Periodic Monitor (C1-PAYRQ) batch such that it is executed at regular intervals. When the Payment Request Periodic Monitor (C1-PAYRQ) batch is invoked, the system checks whether there are any payment requests in the Deferred Distribution status. If there is a payment request in the Deferred Distribution status, the system distributes tender or payment amount and accordingly creates payment event and payments.</p> <p>Note:</p> <p>The Search (🔍) icon appears corresponding to this field. On clicking the Search icon, the Algorithm Search window appears.</p>	Yes
Approval Required	Used to indicate whether approval is required while freezing payments of the payment requests which are created using the payment request type.	No
Approval To Do Type	<p>Used to indicate that To Do of the specified To Do type must be created when you submit the payment request for approval.</p> <p>Note: This field appears when the Approval Required check box is selected.</p>	<p>Yes (Conditional)</p> <p>Note: This field is required when the Approval Required check box is selected.</p>

Field Name	Field Description	Mandatory (Yes or No)
Approval To Do Role	Used to indicate that users with the specified To Do role can only approve the payment request submitted for approval.	Yes (Conditional)
	Note: This field appears when the Approval Required check box is selected.	Note: This field is required when the Approval Required check box is selected.

6. Enter the required details.

Note: You can search for an algorithm and To Do type by clicking the **Search** (🔍) icon corresponding to the respective field.

7. Define characteristics for the payment request type, if required.

8. Click **Save**.

The payment request type is defined.

Related Topics

For more information on...	See...
Payment Request Type screen	Payment Request Type on page 1477
Payment Request Type List zone	Payment Request Type List on page 1477
How to define a characteristic for a payment request type	Defining a Characteristic for a Payment Request Type on page 1483

Defining a Characteristic for a Payment Request Type

Prerequisites

To define a characteristic for a payment request type, you should have:

- Characteristic types defined in the application (where the characteristic entity is set to **Payment Request Type**)

Procedure

To define a characteristic for a payment request type:

1. Ensure that the **Characteristics** section is expanded when you are defining, editing, or copying a payment request type.

The **Characteristics** section contains the following fields:

Field Name	Field Description	Mandatory (Yes or No)
Characteristic Type	Used to indicate the characteristic type.	Yes (Conditional)
	Note: The list includes only those characteristic types where the characteristic entity is set to Payment Request Type .	Note: This field is required when you are defining a characteristic for the payment request type.

Field Name	Field Description	Mandatory (Yes or No)
Characteristic Value	Used to specify the value for the characteristic type.	Yes (Conditional)
	Note: On specifying the value for a predefined characteristic type, the description of the characteristic value appears corresponding to the Characteristic Value field.	Note: This field is required when you are defining a characteristic for the payment request type.

2. Enter the required details.

Note: If you select a predefined characteristic type, the **Search** (🔍) icon appears corresponding to the **Characteristic Value** field. On clicking the **Search** icon, you can search for a predefined characteristic value.

3. If you want to define more than one characteristic for the payment request type, click the **Add** (+) icon and then repeat step 2.

Note: However, if you want to remove a characteristic from the payment request type, click the **Delete** (🗑️) icon corresponding to the characteristic.

Related Topics

For more information on...	See...
How to define a payment request type	Defining a Payment Request Type on page 1480
How to edit a payment request type	Editing a Payment Request Type on page 1484
How to copy a payment request type	Copying a Payment Request Type on page 1487

Editing a Payment Request Type

Prerequisites

To edit a payment request type, you should have:

- Payment request business objects defined in the application
- Deferral algorithm defined using the **C1-PAY-COUNT** algorithm type
- **C1-PAYRQ To Do** type assigned to a To Do role whose users must receive To Do generated while submitting a payment request for approval

Procedure

To edit a payment request type:

1. Click the **Admin** link in the **Application** toolbar.
A list appears.
2. From the **Admin** menu, select **P** and then click **Payment Request Type**.
A sub-menu appears.
3. Click the **Search** option from the **Payment Request Type** sub-menu.
The **Payment Request Type** screen appears.
4. In the **Payment Request Type List** zone, click the **Edit** (✎) icon in the **Edit** column corresponding to the payment request type whose details you want to edit.

The **Payment Request Type** screen appears. It contains the following sections:

- **Main** - Used to specify basic details about the payment request type.
- **Characteristics** - Used to define the characteristics for the payment request type.

The **Main** section contains the following fields:

Field Name	Field Description	Mandatory (Yes or No)
Payment Request Type	Displays the payment request type.	Not applicable
Business Object	Indicates the payment request type business object used while defining the payment request type.	Not applicable
Payment Request Business Object	Used to indicate the business object that you want to use while creating the payment request.	Yes
Description	Used to specify the description for the payment request type.	Yes
Detailed Description	Used to specify additional information about the payment request type.	No
Status	Used to indicate the status of the payment request type. The valid values are: <ul style="list-style-type: none"> • Active • Inactive 	Yes
Transfer	Used to indicate whether the payment request type will be used to create payment transfer or payment creation request.	No

Field Name	Field Description	Mandatory (Yes or No)
Defer Algorithm	<p>Used to attach an algorithm that will be triggered when you distribute tender or payment amount. This algorithm checks whether the number of payment distribution records in the payment request exceeds the payment count (defined in the Defer algorithm). If the number of payment distribution records in the payment request does not exceed the payment count, the system distributes tender or payment amount and accordingly creates payment event and payments in real time (i.e. immediately). However, if the number of payment distribution records in the payment request exceeds the payment count, the system distributes tender or payment amount in the deferred mode.</p> <p>Note:</p> <p>Number of payment distribution records = (Number of bill segments present in each bill fetched using the Bill Weighted, Bill Regular, and Bill match type algorithm) + (Number of bill segments fetched using the Bill Segment match type algorithm) + (Number of contracts fetched using the Suspense Contract match type algorithm) + (Number of settlements fetched using the Settlement match type algorithm)</p> <p>Deferred mode means in the background when the Payment Request Periodic Monitor (C1-PAYRQ) batch is invoked. You can configure the Payment Request Periodic Monitor (C1-PAYRQ) batch such that it is executed at regular intervals. When the Payment Request Periodic Monitor (C1-PAYRQ) batch is invoked, the system checks whether there are any payment requests in the Deferred Distribution status. If there is a payment request in the Deferred Distribution status, the system distributes tender or payment amount and accordingly creates payment event and payments.</p> <p>Note:</p> <p>The Search (🔍) icon appears corresponding to this field. On clicking the Search icon, the Algorithm Search window appears.</p>	Yes
Approval Required	Used to indicate whether approval is required while freezing payments of the payment requests which are created using the payment request type.	No
Approval To Do Type	<p>Used to indicate that To Do of the specified To Do type must be created when you submit the payment request for approval.</p> <p>Note: This field appears when the Approval Required check box is selected.</p>	<p>Yes (Conditional)</p> <p>Note: This field is required when the Approval Required check box is selected.</p>

Field Name	Field Description	Mandatory (Yes or No)
Approval To Do Role	Used to indicate that users with the specified To Do role can only approve the payment request submitted for approval.	Yes (Conditional)
	Note: This field appears when the Approval Required check box is selected.	Note: This field is required when the Approval Required check box is selected.

Tip: Alternatively, you can click the **Edit** button in the **Payment Request Type** zone to edit the details of the payment request type.

- Modify the required details.

Note: You can search for an algorithm and To Do type by clicking the **Search**  icon corresponding to the respective field.

- Define, edit, or remove characteristics of the payment request type, if required.
- Click **Save**.

The changes made to the payment request type are saved.

Related Topics

For more information on...	See...
Payment Request Type screen	Payment Request Type on page 1477
Payment Request Type List zone	Payment Request Type List on page 1477
Payment Request Type zone	Payment Request Type on page 1478
How to define a characteristic for a payment request type	Defining a Characteristic for a Payment Request Type on page 1483

Copying a Payment Request Type

Instead of creating a payment request type from scratch, you can create a new payment request type using an existing payment request type. This is possible through copying a payment request type. On copying a payment request type, the details including the characteristics are copied to the new payment request type. You can then edit the details, if required.

Prerequisites

To copy a payment request type, you should have:

- Payment request type (whose copy you want to create) defined in the application
- Payment request business objects defined in the application
- Defer algorithm defined using the **C1-PAY-COUNT** algorithm type
- C1-PAYRQ** To Do type assigned to a To Do role whose users must receive To Do generated while submitting a payment request for approval

Procedure

To copy a payment request type:

- Click the **Admin** link in the **Application** toolbar.
A list appears.
- From the **Admin** menu, select **P** and then click **Payment Request Type**.

A sub-menu appears.

- Click the **Search** option from the **Payment Request Type** sub-menu.

The **Payment Request Type** screen appears.

- In the **Payment Request Type List** zone, click the **Duplicate** () icon in the **Duplicate** column corresponding to the payment request type whose copy you want to create.

The **Payment Request Type** screen appears. It contains the following sections:

- Main** - Used to specify basic details about the payment request type.
- Characteristics** - Used to define the characteristics for the payment request type.

The **Main** section contains the following fields:

Field Name	Field Description	Mandatory (Yes or No)
Payment Request Type	Used to specify the payment request type.	Yes
Business Object	Indicates the payment request type business object used while defining the payment request type.	Not applicable
Payment Request Business Object	Used to indicate the business object that you want to use while creating the payment request.	Yes
Description	Used to specify the description for the payment request type.	Yes
Detailed Description	Used to specify additional information about the payment request type.	No
Status	Used to indicate the status of the payment request type. The valid values are: <ul style="list-style-type: none"> Active Inactive 	Yes
Transfer	Used to indicate whether the payment request type will be used to create payment transfer or payment creation request.	No

Field Name	Field Description	Mandatory (Yes or No)
Defer Algorithm	<p>Used to attach an algorithm that will be triggered when you distribute tender or payment amount. This algorithm checks whether the number of payment distribution records in the payment request exceeds the payment count (defined in the Defer algorithm). If the number of payment distribution records in the payment request does not exceed the payment count, the system distributes tender or payment amount and accordingly creates payment event and payments in real time (i.e. immediately). However, if the number of payment distribution records in the payment request exceeds the payment count, the system distributes tender or payment amount in the deferred mode.</p> <p>Note:</p> <p>Number of payment distribution records = (Number of bill segments present in each bill fetched using the Bill Weighted, Bill Regular, and Bill match type algorithm) + (Number of bill segments fetched using the Bill Segment match type algorithm) + (Number of contracts fetched using the Suspense Contract match type algorithm) + (Number of settlements fetched using the Settlement match type algorithm)</p> <p>Deferred mode means in the background when the Payment Request Periodic Monitor (C1-PAYRQ) batch is invoked. You can configure the Payment Request Periodic Monitor (C1-PAYRQ) batch such that it is executed at regular intervals. When the Payment Request Periodic Monitor (C1-PAYRQ) batch is invoked, the system checks whether there are any payment requests in the Deferred Distribution status. If there is a payment request in the Deferred Distribution status, the system distributes tender or payment amount and accordingly creates payment event and payments.</p> <p>Note:</p> <p>The Search (🔍) icon appears corresponding to this field. On clicking the Search icon, the Algorithm Search window appears.</p>	Yes
Approval Required	Used to indicate whether approval is required while freezing payments of the payment requests which are created using the payment request type.	No
Approval To Do Type	<p>Used to indicate that To Do of the specified To Do type must be created when you submit the payment request for approval.</p> <p>Note: This field appears when the Approval Required check box is selected.</p>	<p>Yes (Conditional)</p> <p>Note: This field is required when the Approval Required check box is selected.</p>

Field Name	Field Description	Mandatory (Yes or No)
Approval To Do Role	Used to indicate that users with the specified To Do role can only approve the payment request submitted for approval.	Yes (Conditional)
	Note: This field appears when the Approval Required check box is selected.	Note: This field is required when the Approval Required check box is selected.

Tip: Alternatively, you can click the **Duplicate** button in the **Payment Request Type** zone to create a copy of the payment request type.

- Enter the required details.

Note: You can search for an algorithm and To Do type by clicking the **Search** (🔍) icon corresponding to the respective field.

- Define, edit, or remove characteristics of the payment request type, if required.
- Click **Save**.

The new payment request type is defined.

Related Topics

For more information on...	See...
Payment Request Type screen	Payment Request Type on page 1477
Payment Request Type List zone	Payment Request Type List on page 1477
Payment Request Type zone	Payment Request Type on page 1478
How to define a characteristic for a payment request type	Defining a Characteristic for a Payment Request Type on page 1483

Deleting a Payment Request Type

Procedure

To delete a payment request type:

- Click the **Admin** link in the **Application** toolbar.
A list appears.
- From the **Admin** menu, select **P** and then click **Payment Request Type**.
A sub-menu appears.
- Click the **Search** option from the **Payment Request Type** sub-menu.
The **Payment Request Type** screen appears.
- In the **Payment Request Type List** zone, click the **Delete** (🗑️) icon in the **Delete** column corresponding to the payment request type that you want to delete.
A message appears confirming whether you want to delete the payment request type.

Note: You can delete a payment request type when you have not created a payment request using the payment request type.

Tip: Alternatively, you can click the **Delete** button in the **Payment Request Type** zone to delete the payment request type.

5. Click **OK**.

The payment request type is deleted.

Related Topics

For more information on...	See...
Payment Request Type screen	Payment Request Type on page 1477
Payment Request Type List zone	Payment Request Type List on page 1477
Payment Request Type zone	Payment Request Type on page 1478

Viewing the Payment Request Type Details

Procedure

To view the details of a payment request type:

1. Click the **Admin** link in the **Application** toolbar.
A list appears.
2. From the **Admin** menu, select **P** and then click **Payment Request Type**.
A sub-menu appears.
3. Click the **Search** option from the **Payment Request Type** sub-menu.
The **Payment Request Type** screen appears.
4. In the **Payment Request Type List** zone, click the **Broadcast** () icon corresponding to the payment request type whose details you want to view.
The **Payment Request Type** zone appears.
5. View the details of the payment request type in the **Payment Request Type** zone.

Related Topics

For more information on...	See...
Payment Request Type screen	Payment Request Type on page 1477
Payment Request Type List zone	Payment Request Type List on page 1477
Payment Request Type zone	Payment Request Type on page 1478

Payment Request (Used for Searching)

The **Payment Request** screen allows you to search for a payment creation or transfer request using various search criteria. It also allows you to create payment creation and transfer requests. Through this screen, you can navigate to the following screens:

- [Payment Request \(Used for Viewing\)](#) on page 1496

This screen consists of the following zones:

- [Search Payment Request](#) on page 1492

Search Payment Request

The **Search Payment Request** zone allows you to search for a payment request using various search criteria. This zone contains the following two sections:

- **Search Criteria** — The **Search Criteria** section contains the following fields:

Field Name	Field Description	Mandatory (Yes or No)
Search By	Used to indicate whether you want to search for a payment request using request or payment details. The valid values are: <ul style="list-style-type: none"> • Request Details • Payment Details 	Yes
	Note: By default, the Request Details option is selected.	
On or Before Creation Date/Time	Used to search payment requests which are created till a particular date and time.	No
	Note: By default, the current date and time appears in this field. This field appears when you select the Request Details option from the Search By list.	
Payment Request Status	Used to search payment requests with a particular status. The valid values are: <ul style="list-style-type: none"> • Approval In Progress • Deferred Distribution • Discarded • Distribute And Freeze • Distributed • Draft • Processed • Rejected 	No
	Note: This field appears when you select the Request Details option from the Search By list.	
Payment Request Type	Used to search payment requests which are created using a particular payment request type.	No
	Note: This field appears when you select the Request Details option from the Search By list.	

Field Name	Field Description	Mandatory (Yes or No)
User ID	Used to search payment requests which are created by a particular user.	No
	Note: This field appears when you select the Request Details option from the Search By list.	
Payment Request ID	Used to search a particular payment request.	No
	Note: This field appears when you select the Request Details option from the Search By list.	
Payment Event ID	Used to search a payment request through which a payment event is created.	No
	Note: This field appears when you select the Payment Details option from the Search By list. The Search (🔍) icon appears corresponding to this field. On clicking the Search icon, the Payment Event Search window appears.	
Payor Account ID	Used to search payment requests which are created for a particular payor account.	No
	Note: This field appears when you select the Payment Details option from the Search By list. The Search (🔍) icon appears corresponding to this field. On clicking the Search icon, the Account Search window appears.	
Payor Name	Used to search payment requests which are created for a particular payor.	No
	Note: This field appears when you select the Payment Details option from the Search By list.	
Payment Date	Used to search payment requests through which payments are created on a particular date.	No
	Note: This field appears when you select the Payment Details option from the Search By list.	

Note: You must specify at least one search criterion while searching for a payment request.

- **Search Results** — On clicking the **Search** button, the search results appear based on the specified search criteria. The **Search Results** section contains the following columns:

Column Name	Column Description
Create Date/Time	Displays the date and time when the payment request was created in the system.
Payment Request Information	Displays information about the payment request.
	Note: It has a link. On clicking the link, the Payment Request screen appears where you can view the details of the respective payment request.
Status	Indicates the status of the payment request. The valid values are: <ul style="list-style-type: none"> • Approval In Progress • Deferred Distribution • Distributed • Draft • Processed • Rejected
Payment Event Information	Displays information about the payment event which is created through the payment request.
	Note: It has a link. On clicking the link, the Payment Event screen appears with the details of the respective payment event.
Created By	Indicates the user who has created the payment request.
Payor Account Information	Displays information about the payor's account for which the payment request is created. In addition, this column has a context menu which helps in navigating to other screens in the application.
	Note: It has a link. On clicking the link, the Account screen appears where you can view the details of the respective account.

Related Topics

For more information on...	See...
How to search for a payment request	Searching for a Payment Request on page 1494
How to create a payment request	Creating a Payment Creation Request on page 1505
How to view the details of a payment request	Viewing the Payment Request Details on page 1495

Searching for a Payment Request

Prerequisites

To search for a payment request, you should have:

- Payment request types defined in the application

Procedure

To search for a payment request:

1. Click the **Menu** link in the **Application** toolbar.

A list appears.

- From the **Main** menu, select **Payments** and then click **Payment Request**.

A sub-menu appears.

- Click the **Search** option from the **Payment Request** sub-menu.

The **Payment Request** screen appears.

- Enter the search criteria in the **Search Payment Request** zone.

Note: ORMB search engine supports wildcard search, where you can substitute the percentage (%) symbol as a stand in for any word or letter in a search criteria. You can use the ‘%’ wildcard character in all input fields except the date and ID fields. The ‘%’ wildcard character is suffixed automatically at the end of the partial search criteria. Therefore, you may or may not specify the wildcard character at the end of the partial search criteria. However, you have to prefix the wildcard character manually wherever required.

- Click **Search**.

A list of payment requests that meet the search criteria appears in the **Search Results** section.

Related Topics

For more information on...	See...
Payment Request screen	Payment Request (Used for Searching) on page 1491
Search Payment Request zone	Search Payment Request on page 1492

Viewing the Payment Request Details

Procedure

To view the details of a payment request:

- Search for the payment request in the **Payment Request** screen.
- In the **Search Results** section, click the link in the **Payment Request Information** column corresponding to the payment request whose details you want to view.

The **Payment Request** screen appears. It consists of the following tabs:

- **Main** – This tab contains the following two zones:
 - **Payment Request** – Displays the details of the payment request.
 - **Payment Distribution** – Lists the payment distribution records of the payment request.
 - **Log** – This tab lists the complete trail of actions performed on the payment request.
- View the details of the payment request in the **Payment Request** zone.
 - View the payment distribution records of the payment request in the **Payment Distribution** zone.

Related Topics

For more information on...	See...
How to search for a payment request	Searching for a Payment Request on page 1494
Payment Request screen	Payment Request (Used for Viewing) on page 1496
Payment Request zone	Payment Request on page 1496
Payment Distribution zone	Payment Distribution on page 1502

Payment Request (Used for Viewing)

Once you create a payment creation or transfer request, the **Payment Request** screen allows you to:

- Edit the details of a payment request
- Edit the payment amount against each entity
- Delete a payment request
- View the details of a payment request
- Distribute the tender or payment amount
- Edit the amount of a payment segment
- Freeze the payments created through a payment request
- Submit a payment request for approval before freezing payments
- Approve or reject a payment request
- View the log of a payment request
- Add a log entry for a payment request

It consists of the following tabs:

- [Payment Request - Main](#) on page 1496
- [Payment Request - Log](#) on page 1504

Payment Request - Main

The **Main** tab displays information about the payment request. It contains the following zones:

- [Payment Request](#) on page 1496
- [Payment Distribution](#) on page 1502

Payment Request

The **Payment Request** zone displays the details of the payment request. This zone contains the following sections:

- **Main** – This section provides basic information about the payment request. It contains the following fields:

Field Name	Field Description
Payment Request Information	Displays information about the payment request.
Payment Request Type	Indicates the payment request type using which the payment request is created. Note: It has a link. On clicking the link, the Payment Request Type screen appears where you can view the details of the payment request type.

Field Name	Field Description
Payment Request Status	<p>Indicates the status of the payment request. The valid values are:</p> <ul style="list-style-type: none"> • Approval In Progress • Deferred Distribution • Distributed • Draft • Processed • Rejected
Status Reason	<p>Indicates the reason why the payment request is rejected.</p> <p>Note: This field appears when the payment request is in the Rejected status. It has a link. On clicking the link, the Status Reason screen appears where you can view the details of the rejected reason.</p>
Payor Account Information	<p>Displays information about the payor's account for which the payment request is created.</p> <p>Note: This field appears when you are viewing the details of a payment creation request. It has a link. On clicking the link, the Account screen appears where you can view the details of the respective account.</p>
Payment Date	<p>Displays the date when the payment event and payments are created.</p>
Payment Event Information	<p>Displays information about the payment event. If you are viewing the details of a payment creation request, this field displays information about the payment event which is created through the payment creation request. However, if you are viewing the details of a payment transfer request, this field displays information about the payment event whose payments you want to transfer.</p> <p>Note: This field does not appear when the payment request is in the Rejected status. If you are viewing the details of a payment creation request, this field does not appear when the payment creation request is in the Draft status. It has a link. On clicking the link, the Payment Event screen appears where you can view the details of the respective payment event.</p>
Transfer Amount	<p>Displays the total payment amount which you want to transfer.</p> <p>Note: This field appears when you are viewing the details of a payment transfer request.</p>

Field Name	Field Description
Transfer Reason	Indicates the reason why you want to transfer the payment amount.
	Note: This field appears when you are viewing the details of a payment transfer request.

- **Tender Details** – This section provides details about the tender used in the payment request. This section appears when you are viewing the details of a payment creation request. It contains the following fields:

Field Name	Field Description
Tender Type	Indicates the type of tender through which the payment was made.
Tender Amount	Displays the tender amount.
Currency	Indicates the currency in which the payment was made.
Check Number	Displays the check number if the payment is made through check.
	Note: This field appears when the tender type is set to Check .
Auto Pay Route Type Code	Indicates when and how automatic payment request of the account is routed to a financial institution.
	Note: This field appears only when you select a tender type where the Generate Auto Pay check box is selected.
Schedule Extract Date	Displays the date when the automatic payment request is scheduled to be sent to a financial institution.
	Note: This field appears only when you select a tender type where the Generate Auto Pay check box is selected.
Auto Pay Source Code	Indicates the financial institution that receives the automatic payment request.
	Note: This field appears when you select a tender type where the Generate Auto Pay check box is selected.
Distribution and Freeze Date	Displays the date when the automatic payment must be distributed and frozen in the system.
	Note: This field appears when you select a tender type where the Generate Auto Pay check box is selected.
Account Number	Indicates the bank account number through which the automatic payment was made.
	Note: This field appears when you select a tender type where the Generate Auto Pay check box is selected.
Expires On	Displays the date when the tender type will expire.
	Note: This field appears when you select a tender type where the Generate Auto Pay check box is selected.

Field Name	Field Description
Name	Displays the name of the person as maintained in the financial institution's system.
	Note: This field appears when you select a tender type where the Generate Auto Pay check box is selected.
Tender Control Information	Displays information about the tender control which is created when the payment event and payments are created. In addition, a context menu appears corresponding to this field which helps in navigating to other screens in the application.
	Note: This field appears only when the payment request is in the Distributed, Approval In Progress, Processed , or Rejected status. It has a link. On clicking the link, the Tender Control screen appears where you can view the details of the respective tender control.
Deposit Control Information	Displays information about the deposit control which is created when the payment event and payments are created. In addition, a context menu appears corresponding to this field which helps in navigating to other screens in the application.
	Note: This field appears only when the payment request is in the Distributed, Approval In Progress, Processed , or Rejected status. It has a link. On clicking the link, the Deposit Control screen appears where you can view the details of the respective deposit control.
Pay Tender ID	Displays the payment tender ID.
	Note: This field appears only when the payment request is in the Processed status.
Tender Status	Indicates the current status of the tender. The valid values are: <ul style="list-style-type: none"> Valid Cancelled
	Note: This field appears when the payment request is in the Processed status.
MICR ID	Displays the MICR code on the payment.
Ext. Reference ID	Displays the external reference number of the payment on the payment upload interface record.
Person ID	Indicates the person's account ID mentioned in the payment upload interface record.
Name	Indicates the person mentioned in the payment upload interface record.

- **Characteristics** – This section lists the characteristics of the payment tender. It appears only when you are viewing the details of a payment creation request. It contains the following columns:

Column Name	Column Description
Characteristic Type	Indicates the characteristic type.
Characteristic Value	Displays the value of the characteristic type.

- **Match Types** – This section lists the match type details of the payment request. This section appears only when you are viewing the details of a payment creation request. It contains the following columns:

Column Name	Column Description
Match Type	Indicates the match type using which you want to match the payment.
Match By	Indicates the bill or account (whose entities, such as unpaid bills, unpaid bill segments, settlement IDs, or contracts) must be considered while matching the payment.

- **Payor Account Details** – This section appears when you are viewing the details of a payment transfer request. It contains the following columns:

Column Name	Column Description
Payor Account Information	Displays information about the payor's account whose payments you want to transfer.

- **Payment Details** – This section appears when you are viewing the details of a payment transfer request. It contains the **Show Payments** link. On clicking the link, the **Payment** screen appears where you can view the details of the payment that you want to transfer. In case, you want to transfer multiple payments, the **Payment Search** window appears with the list of payments selected for transfer. You can click the individual payment to view the details in the **Payment** screen. The **Show Payments** link does not appear when you are viewing the details of a payment transfer request which is in the **Processed** status. Instead, the following column appears in this section:

Column Name	Column Description
Payment(s)	Displays information about the payment which is cancelled.

- **Record Actions** – This section contains the following buttons:

Column Name	Column Description
Edit	Used to edit the details of the payment request.
	Note: The Edit button appears when the payment request is in the Draft status.
Delete	Used to delete the payment request.
	Note: The Delete button appears when the payment request is in the Draft status.
Distribute	Used to distribute the tender or payment amount.
	Note: The Distribute button appears when the payment request is in the Draft status.

Column Name	Column Description
Submit for Approval	Used to submit the payment request for approval.
	<p>Note: The Submit for Approval button appears when:</p> <ul style="list-style-type: none"> • The payment request is in the Distributed status. • The Approval Required check box is selected in the payment request type using which the payment request is created.
Freeze	Used to freeze the payments which are created through the payment request.
	<p>Note: The Freeze button appears when:</p> <ul style="list-style-type: none"> • The payment request is in the Distributed status. • The Approval Required check box is not selected in the payment request type using which the payment request is created.
Approve	Used to approve the payment request.
	<p>Note: The Approve button appears when:</p> <ul style="list-style-type: none"> • The payment request is in the Approval In Progress status. • A user with the approval To Do role is reviewing the payment request.
Reject	Used to reject the payment request.
	<p>Note: The Reject button appears when:</p> <ul style="list-style-type: none"> • The payment request is in the Approval In Progress status. • A user with the approval To Do role is reviewing the payment request.
Back to Draft	Used to change the status of the payment request to Draft .
	<p>Note: The Back to Draft button appears when the payment request is in the Distributed status.</p>
Discard	Used to discard the payment creation or transfer request.
	<p>Note: The Discard button appears when the payment request is in the Distributed status.</p>
Distribute And Freeze	Used to distribute and freeze the payments at the same time.
	<p>Note: the Distribute And Freeze button appears only when the payment request is in the Draft status.</p>

- **Record Information** – This section contains the following fields:

Field Name	Field Description
Business Object	Indicates the business object using which the payment request is created. In addition, a context menu appears corresponding to this field which helps in navigating to other screens in the application.
	Note: It has a link. On clicking the link, the Business Object screen appears where you can view the details of the respective business object.
Status Date/Time	Displays the date and time when the payment request status is updated
Create Date/Time	Displays the date and time when the payment request is created.

Payment Distribution

The **Payment Distribution** zone lists the payment distribution records of the payment request. This zone contains the following columns:

Column Name	Column Description
Match Type	Indicates the match type using which the payment was matched.
Payee Account ID	Indicates the account for which the payment was made.
	Note: It has a link. On clicking the link, the Account screen appears where you can view the details of the respective account.
Match Value	Indicates the entity (such as bill ID, bill segment ID, contract ID, or settlement ID) against which the payment was matched.
Match Entity	Indicates the type of entity against which the payment was matched. The valid values are: <ul style="list-style-type: none"> • Bill • Bill Segment • Contract • Settlement
Amount	Displays the entity amount. In case of contract, the entity amount would be zero.
Write Off Adjustment Amount	Indicates the amount which is either write up or down when the payment against the bill is within the tolerance limit.
	Note: The data appears in this column when the match type is Bill Weighted and the payment amount is within the underpayment or overpayment tolerance limit. This column does not appear when the payment request is in the Draft or Rejected status.
Paid Amount	Displays the amount which is already paid against the entity.
	Note: This column appears when the payment request is in the Draft or Rejected status.
Unpaid Amount	Displays the amount which is eligible for payment against the entity.
	Note: This column appears when the payment request is in the Draft or Rejected status.

Column Name	Column Description
Payment Amount	Displays the payment amount. If the Show Default check box is not selected against a match type while creating the payment request, the payment amount against the respective match type entities is set to zero. However, if the Show Default check box is selected against a match type while creating the payment request, the payment amount appears against the respective match type entities. The tender amount is divided among the entities in the sequence of match types (where Show Default check box is selected) followed by the sequence of bill, bill segment, or contract start date. You can edit the payment amount, if required.
Payment Currency	Indicates the currency in which the payment was made.
Payment ID	<p data-bbox="527 533 803 564">Displays the payment ID.</p> <p data-bbox="527 590 594 621">Note:</p> <p data-bbox="527 638 1466 701">It has a link. On clicking the link, the Payment screen appears with the details of the respective payment.</p> <p data-bbox="527 718 1466 749">This column does not appear when the payment request is in the Draft or Rejected status.</p>
Payment Status	<p data-bbox="527 804 1133 835">Indicates the status of the payment. The valid values are:</p> <ul data-bbox="557 852 716 1073" style="list-style-type: none"> • Canceled • Error • Freezable • Frozen • Incomplete <p data-bbox="527 1098 1466 1161">Note: This column does not appear when the payment request is in the Draft or Rejected status.</p>
Error Message	<p data-bbox="527 1203 1170 1234">Indicates the reason why the payment is in the Error status.</p> <p data-bbox="527 1260 1466 1323">Note: This column does not appear when the payment request is in the Draft or Rejected status.</p>
Detail	<p data-bbox="527 1360 1466 1423">On clicking the Detail button, the Edit Payment Segment Amount screen appears where you can edit the payment segment amount.</p> <p data-bbox="527 1449 594 1480">Note:</p> <p data-bbox="527 1497 1466 1528">This column does not appear when the payment request is in the Draft or Rejected status.</p> <p data-bbox="527 1545 1105 1577">The Detail button appears in the Detail column when:</p> <ul data-bbox="557 1593 1395 1671" style="list-style-type: none"> • The payment request is in the Distributed or Approval In Progress status • The payment is in the Freezable status. <p data-bbox="527 1688 1466 1751">However, a user with the approval To Do role will not be able to edit the payment segment amount.</p>

Column Name	Column Description
Redistribute	On clicking the Redistribute button, you can redistribute the payment amount among the payment segments.
	<p>Note:</p> <p>This column appears when the payment request is in the Distributed or Distribute and Freeze status.</p> <p>The Redistribute button appears in the Redistribute column when:</p> <ul style="list-style-type: none"> The payment request is in the Distributed or Approval In Progress status

You can edit the payment amount by clicking the **Update Payment Amount** button in the upper right corner of this zone.

Related Topics

For more information on...	See...
How to edit the payment amount against each entity	Editing the Payment Amount on page 1511

Payment Request - Log

The **Log** tab contains the following zone:

- [Payment Request Log](#) on page 1504

Payment Request Log

The **Payment Request Log** zone lists the complete trail of actions performed on the payment request. It contains the following columns:

Column Name	Column Description
Creation Date Time	Displays the date and time when the action was performed on the payment request.
Details	Displays the details about the action performed on the payment request.
User	Indicates the user who has performed the action on the payment request.
Log Type	Indicates the type of log.
Related Object	Indicates the object or entity which is created when the action is performed on the payment request.
	<p>Note: At present, no data appears in this column. The implementation team can build the custom logic to meet the business requirements.</p>
Status Reason	Indicates the reason why the status of the payment request is changed.
	<p>Note: At present, no data appears in this column. The implementation team can build the custom logic to meet the business requirements.</p>

Note: You can manually add a log entry for the payment request by clicking the **Add Log Entry** link in the upper right corner of the **Payment Request Log** zone.

Related Topics

For more information on...	See...
How to view the log of a payment request	Viewing the Log of a Payment Request on page 1527
How to add a log entry for a payment request	Adding a Log Entry for a Payment Request on page 1528

Creating a Payment Creation Request

Prerequisites

To create a payment creation request, you should have:

- Payment request types defined in the application (where the **Transfer** check box is not selected)

Procedure

To create a payment creation request:

1. Click the **Menu** link in the **Application** toolbar.
A list appears.
2. From the **Main** menu, select **Payments** and then click **Payment Request**.
A sub-menu appears.
3. Click the **Add** option from the **Payment Request** sub-menu.

The **Select Payment Request Type** screen appears. It contains the following fields:

Field Name	Field Description	Mandatory (Yes or No)
Payment Request Type	Used to indicate the payment request type using which you want to create the payment request. Note: The list includes only those payment request types where the Transfer check box is not selected.	Yes

Tip: Alternatively, you can access the **Select Payment Request Type** screen by clicking the **Add** button in the **Page Title** area of the **Payment Request** screen.

4. Select the required payment request type from the respective field.
5. Click **OK**.

The **Payment Request** screen appears. It contains the following sections:

- **Main** - Used to specify basic details about the payment request. This section contains the following fields:

Field Name	Field Description	Mandatory (Yes or No)
Payment Request Type	Indicates the payment request type using which you want to create the payment request.	Not applicable

Field Name	Field Description	Mandatory (Yes or No)
Payor Account Information	Used to indicate the payor account for which you want to create the payment request.	Yes
	<p>Note: On specify the account ID, additional information about the account appears corresponding to this field.</p> <p>The Search (🔍) icon appears corresponding to this field. On clicking the Search icon, the Account Search window appears.</p>	
Payment Date	Used to specify the date when the payment was made.	Yes
	<p>Note: By default, the current date appears in this field.</p>	

- **Tender Details** - Used to specify the tender details in the payment request. This section contains the following fields:

Field Name	Field Description	Mandatory (Yes or No)
Tender Type	Used to indicate the type of tender through which the payment was made.	Yes
Tender Amount	Used to specify the tender amount.	Yes
Currency	Used to indicate the currency in which the payment was made.	Yes
Check Number	Used to specify the check number if the payment is made through check.	No
Auto Pay Route Type Code	Used to indicate when and how automatic payment request of the account is routed to a financial institution.	Yes (Conditional)
	<p>Note: This field appears when you select a tender type where the Generate Auto Pay check box is selected.</p>	
Schedule Extract Date	Displays the date when the automatic payment request is scheduled to be sent to a financial institution.	Not applicable
	<p>Note: This field appears only when you select a tender type where the Generate Auto Pay check box is selected.</p>	
Auto Pay Source Code	Used to indicate the financial institution that receives the automatic payment request.	Yes (Conditional)
	<p>Note: This field appears when you select a tender type where the Generate Auto Pay check box is selected.</p>	

Field Name	Field Description	Mandatory (Yes or No)
Distribution and Freeze Date	Displays the date when the automatic payment must be distributed and frozen in the system.	Not applicable
	Note: This field appears when you select a tender type where the Generate Auto Pay check box is selected.	
Account Number	Used to indicate the bank account number through which the automatic payment was made.	Yes (Conditional)
	Note: This field appears when you select a tender type where the Generate Auto Pay check box is selected.	
Expires On	Used to specify the date when the tender type will expire.	No
	Note: This field appears when you select a tender type where the Generate Auto Pay check box is selected.	
Name	Used to specify the name of the person as maintained in the financial institution's system.	No
	Note: This field appears when you select a tender type where the Generate Auto Pay check box is selected.	
MICR ID	Used to specify the MICR code on the payment.	No
Ext. Reference ID	Used to specify the external reference number of the payment on the payment upload interface record.	No
Person ID	Used to indicate the person's account ID mentioned in the payment upload interface record.	No
Name	Used to indicate the person mentioned in the payment upload interface record.	No
Tender Control ID	Note: The Search (🔍) icon appears corresponding to this field. On clicking the Search icon, the Tender Control Search window appears.	

Note: If the auto pay instructions are defined for the payor account, by default, the auto pay data appears in the **Auto Pay Route Type Code**, **Auto Pay Source Code**, **Account Number**, **Expires On**, and **Name** fields.

- **Characteristics** - Used to define the characteristics for the payment tender. This section contains the following fields:

Field Name	Field Description	Mandatory (Yes or No)
Characteristic Type	Used to indicate the characteristic type.	Yes (Conditional)
	Note: The list includes only those characteristic types where the characteristic entity is set to Payment Tender .	Note: This field is required when you are defining a characteristic for the payment tender.
Characteristic Value	Used to specify the value for the characteristic type.	Yes (Conditional)
	Note: On specifying the value for a predefined characteristic type, the description of the characteristic value appears corresponding to the Characteristic Value field.	Note: This field is required when you are defining a characteristic for the payment tender.

- **Match Types** - Used to define match types for the payment request. This section contains the following fields:

Field Name	Field Description	Mandatory (Yes or No)
Match Type	Used to indicate the match type using which you want to match the payment.	Yes
Show Default	Used to indicate whether the default payment amount should be displayed against the match type entities.	No
	Note: By default, the Show Default check box is selected when you select the match type.	
Entity	<p>Indicates the match type entity. The valid values are:</p> <ul style="list-style-type: none"> • Account — Enables you to select the account whose unpaid bills, unpaid bill segments, settlement IDs, or contracts must be considered while matching the payment. • Bill — Enables you to select the unpaid bill against which you want to match the payment. <p>Note:</p> <p>The Search  icon appears corresponding to this field. On clicking the Search icon, the Account Search window appears.</p>	Not applicable
Entity ID	Used to specify the account or bill ID depending on the match type entity.	Yes

6. Enter the required details.

Note:

You can search for a payor account, auto pay route type, auto pay source, and entity by clicking the **Search** (🔍) icon corresponding to the respective field.

If you want to specify more than one match type within the payment request, click the **Add** (+) icon in the **Match Types** section and then specify the details. However, if you want to remove a match type from the payment request, click the **Delete** (🗑️) icon corresponding to the match type.

7. Define characteristics for the payment tender, if required.

8. Click **Manual Distribution**.

The payment request is created and the status of the payment request is set to **Draft**. The **Payment Request** screen appears. Depending on the match type and match entity specified while creating the payment request, the following entities are listed in the **Payment Distribution** zone:

Match Type	Match Entity	Entities
By Bill Regular	Account	Unpaid bills of the account
By Bill Weighted	Account	Unpaid bills of the account
By Bill	Bill	Unpaid bill
By Bill Segments	Account	Unpaid bill segments
By Suspense Contract	Account	Contracts of the account Note: Only contracts of the contract type where the Eligible for Billing flag is set to No and Special Role flag is set to Suspense are listed in the Payment Distribution zone. If no contracts with this specification exist for the account, the system checks whether there is any such contract type (where the Eligible for Billing flag is set to No and Special Role flag is set to Suspense) defined for the division to which the account belongs. If there is any such contract type defined for the division, the system creates the contract for the account using the respective contract type and the same is listed in Payment Distribution zone.
By Settlement	Account	Unpaid bill segments where the settlement account is stamped

If the **Show Default** check box is not selected against a match type while creating the payment request, the payment amount against the respective match type entities is set to zero. However, if the **Show Default** check box is selected against a match type, the payment amount appears against the respective match type entities. The tender amount is divided among the entities in the sequence of match types (where **Show Default** check box is selected) followed by the sequence of bill, bill segment, or contract start date. You can then edit the payment amount, if required.

Note:

If a payment request is already created for a payee account and is currently in progress, the system will not allow you to create another payment request for the payee account until the previous payment request is in the **Processed** or **Rejected** status.

The system does not allow you to create a payment request for a payee account when the respective match type entities (such as unpaid bills, unpaid bill segments, contracts, or settlement IDs do not exists for the payee account.

Related Topics

For more information on...	See...
Search Payment Request zone	Search Payment Request on page 1492
How to define a characteristic for a payment tender	Defining a Characteristic for a Payment Tender on page 1510
Payment Request screen	Payment Request (Used for Viewing) on page 1496
Payment Distribution zone	Payment Distribution on page 1502

Defining a Characteristic for a Payment Tender**Prerequisites**

To define a characteristic for a payment tender, you should have:

- Characteristic types defined in the application (where the characteristic entity is set to **Payment Tender**)

Procedure

To define a characteristic for a payment tender:

1. Ensure that the **Characteristics** section is expanded when you are defining or editing a payment request.

The **Characteristics** section contains the following fields:

Field Name	Field Description	Mandatory (Yes or No)
Characteristic Type	Used to indicate the characteristic type.	Yes (Conditional)
	Note: The list includes only those characteristic types where the characteristic entity is set to Payment Tender .	Note: This field is required when you are defining a characteristic for the payment tender.
Characteristic Value	Used to specify the value for the characteristic type.	Yes (Conditional)
	Note: On specifying the value for a predefined characteristic type, the description of the characteristic value appears corresponding to the Characteristic Value field.	Note: This field is required when you are defining a characteristic for the payment tender.

2. Enter the required details.

Note: If you select a predefined characteristic type, the **Search** (🔍) icon appears corresponding to the **Characteristic Value** field. On clicking the **Search** icon, you can search for a predefined characteristic value.

- If you want to define more than one characteristic for the payment tender, click the **Add** (+) icon and then repeat step 2.

Note: However, if you want to remove a characteristic from the payment tender, click the **Delete** (🗑️) icon corresponding to the characteristic.

Related Topics

For more information on...	See...
How to create a payment creation request	Creating a Payment Creation Request on page 1505
How to edit a payment request	Editing a Payment Request on page 1513

Editing the Payment Amount

Procedure

To edit the payment amount against each entity:

- Search for the payment request in the **Payment Request** screen.
- In the **Search Results** section, click the link in the **Payment Request Information** column corresponding to the payment request whose details you want to edit.

The **Payment Request** screen appears.

- Click the **Update Payment Amount** button in the upper right corner of the **Payment Distribution** zone.

The **Edit Payment Amount** screen appears. It contains the following two sections:

- Search Criteria** — The **Search Criteria** section allows you to filter the payment distribution records using various search criteria. It contains the following fields:

Field Name	Field Description	Mandatory (Yes or No)
Match Type	Used to search the entities which are considered using a particular match type.	Yes
	Note: By default, the All option is selected.	
Entity ID	Used to search entities which belong to a particular account.	Yes
	Note: By default, the All option is selected.	
Match Value	Used to search for a particular entity (such as bill, bill segment, contract, or settlement ID).	No
Sort By	Used to sort entity information as per the match type defined in the C1-PYREQSRT feature configuration.	No

- Search Results** — On clicking the **Search** button, the search results are filtered based on the specified search criteria. The **Search Results** section contains the following columns:

Column Name	Column Description
Match Type	Indicates the match type using which the entity is considered.
Payee Information	Displays information about the account for which the payment was made.
Entity Information	Displays information about the entity against which the payment was matched.
Amount	Displays the entity amount. In case of contract, the entity amount would be zero.
Paid Amount	Displays the amount which is already paid against the entity.
Unpaid Amount	Displays the amount which is eligible for payment against the entity.
Payment Amount	Used to specify the payment amount. Note: If the Allow Overpayment option type of the C1-PAYPORTAL feature configuration is set to true , you can specify the payment amount greater than the unpaid amount. In other words, you can make overpayment against an entity.
Payment Currency	Indicates the currency in which the payment was made.

In addition, the **Search Results** section contains the following fields:

Field Name	Field Description
Total Amount	Displays the tender or transfer amount.
Running Total	Displays the sum of payment amount specified against each entity.
Running Balance	Displays the difference between total amount and running total. The running balance is highlighted in the red color when the difference amount is non-zero.

Note: Pagination is used to display limited number of records in the **Edit Payment Amount** screen. You can change the number of records displayed per page, if required. You can use the navigation buttons, such as **First** (<<), **Previous** (), **Next** (), and **Last** () to navigate between pages. You can also select the page to which you want to navigate from the **Go To** list.

- Modify the payment amount against an entity, if required.

Note: The sum of payment amount should be equal to the tender or transfer (payment) amount.

- Click **Save**.

The changes made to the payment request are saved.

- Click **Close**.

The payment amount is updated in the **Payment Distribution** zone.

Related Topics

For more information on...	See...
How to search for a payment request	Searching for a Payment Request on page 1494
Payment Request screen	Payment Request (Used for Viewing) on page 1496

For more information on...	See...
Payment Distribution zone	<i>Payment Distribution</i> on page 1502

Editing a Payment Request

Procedure

To edit a payment request:

1. Search for the payment request in the **Payment Request** screen.
2. In the **Search Results** section, click the link in the **Payment Request Information** column corresponding to the payment request whose details you want to edit.

The **Payment Request** screen appears.

3. Click the **Edit** button in the **Payment Request** zone.

The **Payment Request** screen appears. It contains the following sections:

- **Main** - Used to specify basic details about the payment request. This section contains the following fields:

Field Name	Field Description	Mandatory (Yes or No)
Payment Request Information	Displays information about the payment request.	Not applicable
Payment Request Type	Indicates the payment request type using which the payment request is created.	Not applicable
Payor Account Information	Used to indicate the payor account for which you want to create the payment request. Note: On specify the account ID, additional information about the account appears corresponding to this field. The Search (🔍) icon appears corresponding to this field. On clicking the Search icon, the Account Search screen appears.	Yes
Payment Date	Used to specify the date when the payment was made.	Yes

- **Tender Details** - Used to specify the tender details in the payment request. This section contains the following fields:

Field Name	Field Description	Mandatory (Yes or No)
Tender Type	Used to indicate the type of tender through which the payment was made.	Yes
Tender Amount	Used to specify the tender amount.	Yes
Currency	Used to indicate the currency in which the payment was made.	Yes
Check Number	Used to specify the check number if the payment is made through check.	No

Field Name	Field Description	Mandatory (Yes or No)
Auto Pay Route Type Code	Used to indicate when and how automatic payment request of the account is routed to a financial institution.	Yes (Conditional)
	Note: This field appears when you select a tender type where the Generate Auto Pay check box is selected.	Note: This field is required when you select a tender type where the Generate Auto Pay check box is selected.
Schedule Extract Date	Displays the date when the automatic payment request is scheduled to be sent to a financial institution.	Not applicable
	Note: This field appears only when you select a tender type where the Generate Auto Pay check box is selected.	
Auto Pay Source Code	Used to indicate the financial institution that receives the automatic payment request.	Yes (Conditional)
	Note: This field appears when you select a tender type where the Generate Auto Pay check box is selected.	Note: This field is required when you select a tender type where the Generate Auto Pay check box is selected.
Distribution and Freeze Date	Displays the date when the automatic payment must be distributed and frozen in the system.	Not applicable
	Note: This field appears when you select a tender type where the Generate Auto Pay check box is selected.	
Account Number	Used to indicate the bank account number through which the automatic payment was made.	Yes (Conditional)
	Note: This field appears when you select a tender type where the Generate Auto Pay check box is selected.	Note: This field is required when you select a tender type where the Generate Auto Pay check box is selected.
Expires On	Used to specify the date when the tender type will expire.	No
	Note: This field appears when you select a tender type where the Generate Auto Pay check box is selected.	
Name	Used to specify the name of the person as maintained in the financial institution's system.	No
	Note: This field appears when you select a tender type where the Generate Auto Pay check box is selected.	
MICR ID	Used to specify the MICR code on the payment.	No

Field Name	Field Description	Mandatory (Yes or No)
Ext. Reference ID	Used to specify the external reference number of the payment on the payment upload interface record.	No
Person ID	Used to indicate the person's account ID mentioned in the payment upload interface record.	No
Name	Used to indicate the person mentioned in the payment upload interface record.	No

Note: If the auto pay instructions are defined for the payor account, by default, the auto pay data appears in the **Auto Pay Route Type Code**, **Auto Pay Source Code**, **Account Number**, **Expires On**, and **Name** fields.

- **Characteristics** - Used to define the characteristics for the payment tender. This section contains the following fields:

Field Name	Field Description	Mandatory (Yes or No)
Characteristic Type	Used to indicate the characteristic type.	Yes (Conditional)
	Note: The list includes only those characteristic types where the characteristic entity is set to Payment Tender .	Note: This field is required when you are defining a characteristic for the payment tender.
Characteristic Value	Used to specify the value for the characteristic type.	Yes (Conditional)
	Note: On specifying the value for a predefined characteristic type, the description of the characteristic value appears corresponding to the Characteristic Value field.	Note: This field is required when you are defining a characteristic for the payment tender.

- **Match Types** - Used to define match types for the payment request. This section contains the following fields:

Field Name	Field Description	Mandatory (Yes or No)
Match Type	Used to indicate the match type using which you want to match the payment.	Yes
Show Default	Used to indicate whether the default payment amount should be displayed against the match type entities.	No
	Note: By default, the Show Default check box is selected when you select the match type.	

Field Name	Field Description	Mandatory (Yes or No)
Entity	Indicates the match type entity. The valid values are: <ul style="list-style-type: none"> Account — Enables you to select the account whose unpaid bills, unpaid bill segments, settlement IDs, or contracts must be considered while matching the payment. Bill — Enables you to select the unpaid bill against which you want to match the payment. 	Not applicable
Entity ID	Used to specify the account or bill ID depending on the match type entity.	Yes

Note: The **Edit** button appears when the payment request is in the **Draft** status.

- Modify the details of the payment request, if required.

Note:

You can search for a payor account, auto pay route type, auto pay source, and entity by clicking the **Search** (🔍) icon corresponding to the respective field.

If you want to specify more than one match type within the payment request, click the **Add** (+) icon in the **Match Types** section and then specify the details. However, if you want to remove a match type from the payment request, click the **Delete** (🗑️) icon corresponding to the match type.

You cannot edit an existing row in the **Match Types** section. If you want to edit the details of an existing row, you need to first remove the row and then add it again with the updated information.

- Define, edit, or remove characteristics of the payment request, if required.
- Click **Manual Distribution**.

The changes made to the payment request are saved. Depending on the information specified in the **Match Types** section, the entities are listed in the **Payment Distribution** zone. You can edit the payment amount against each entity, if required.

Related Topics

For more information on...	See...
How to search for a payment request	Searching for a Payment Request on page 1494
Payment Request screen	Payment Request (Used for Viewing) on page 1496
Payment Request zone	Payment Request on page 1496
Payment Distribution zone	Payment Distribution on page 1502
How to define a characteristic for a payment tender	Defining a Characteristic for a Payment Tender on page 1510

Deleting a Payment Request

Procedure

To delete a payment request:

1. Search for the payment request in the **Payment Request** screen.
2. In the **Search Results** section, click the link in the **Payment Request Information** column corresponding to the payment request that you want to delete.

The **Payment Request** screen appears.

3. Click the **Delete** button in the **Payment Request** zone.

A message appears confirming whether you want to delete the payment request.

Note: The **Delete** button appears when the payment request is in the **Draft** status.

4. Click **OK**.

The payment request is deleted.

Related Topics

For more information on...	See...
How to search for a payment request	Searching for a Payment Request on page 1494
Payment Request screen	Payment Request (Used for Viewing) on page 1496
Payment Request zone	Payment Request on page 1496

Distributing the Tender or Payment Amount

Procedure

To distribute the tender or payment amount:

1. Search for the payment request in the **Payment Request** screen.
2. In the **Search Results** section, click the link in the **Payment Request Information** column corresponding to the payment request whose tender or payment amount you want to distribute.

The **Payment Request** screen appears.

3. Click the **Distribute** button in the **Payment Request** zone.

The Defer algorithm attached to the payment request type using which you have created the payment request is triggered. This algorithm checks whether the number of payment distribution records in the payment request exceeds the payment count defined in the Defer algorithm. If the number of payment distribution records in the payment request does not exceed the payment count, the system distributes the tender or payment amount in real time (i.e. immediately). However, if the number of payment distribution records in the payment request exceeds the payment count, the system distributes the tender or payment amount in the deferred mode.

Note:

Number of payment distribution records = (Number of bill segments present in each bill fetched using the Bill Weighted, Bill Regular, and Bill match type algorithm) + (Number of bill segments fetched using the Bill Segment match type algorithm) + (Number of contracts fetched using the Suspense Contract match type algorithm) + (Number of settlements fetched using the Settlement match type algorithm)

Deferred mode means in the background when the **Payment Request Periodic Monitor (C1-PAYRQ)** batch is invoked. You can configure the **Payment Request Periodic Monitor (C1-PAYRQ)** batch such that it is executed at regular intervals. When the **Payment Request Periodic Monitor (C1-PAYRQ)** batch is invoked, the system checks whether there are any payment requests in the **Deferred Distribution** status. If there is a payment request in the **Deferred Distribution** status, the system distributes the tender or payment amount.

On distributing the tender amount, the payment event, payments, payment segments, and payment tenders are created. The payments are created in the **Freezable** status. If any error occurs while creating the payment, the payment is created in the **Error** status. If all payments of a payment event are in the **Freezable** status, the status of the payment event is set to **Balanced**. However, if any payment of a payment event is in the **Error** status, the status of the payment event is set to **Unbalanced**. On distributing the payment amount (during transfer), the new payments are created in the **Freezable** status. If any error occurs while creating the new payment, the payment is created in the **Error** status. The status of the payment event is set to **Unbalanced**. The old payments in the payment event that you want to transfer remains in the **Frozen** or **Error** status.

Once the tender or payment amount is successfully distributed, the status of the payment request is changed to **Distributed**.

Note:

The **Distribute** button appears when the payment request is in the **Draft** status.

The sum of payment amount should be equal to the tender or transfer (payment) amount. Otherwise, the system will not allow you to distribute the tender or payment amount.

Related Topics

For more information on...	See...
How to search for a payment request	Searching for a Payment Request on page 1494
Payment Request screen	Payment Request (Used for Viewing) on page 1496
Payment Request zone	Payment Request on page 1496
How to edit the payment amount against each entity	Editing the Payment Amount on page 1511

Distributing and Freezing the Tender or Payment Amount

Procedure

To distribute and freeze the tender or payment amount:

1. Search for the payment request in the **Payment Request** screen.
2. In the **Search Results** section, click the link in the **Payment Request Information** column corresponding to the payment request whose tender or payment amount you want to distribute and freeze.

The **Payment Request** screen appears.

3. Click the **Distribute And Freeze** button in the **Payment Request** zone.

The Defer algorithm attached to the payment request type using which you have created the payment request is triggered. This algorithm checks whether the number of payment distribution records in the payment request exceeds the payment count defined in the Defer algorithm. If the number of payment distribution records in the payment request does not exceed the payment count, the system distributes and freezes the tender or payment amount in real time (i.e. immediately). However, if the number of payment distribution records in the payment request exceeds the payment count, the system distributes and freezes the tender or payment amount in the deferred mode.

Note:

Number of payment distribution records = (Number of bill segments present in each bill fetched using the Bill Weighted, Bill Regular, and Bill match type algorithm) + (Number of bill segments fetched using the Bill Segment match type algorithm) + (Number of contracts fetched using the Suspense Contract match type algorithm) + (Number of settlements fetched using the Settlement match type algorithm)

Deferred mode means in the background when the **Payment Request Periodic Monitor (C1-PAYRQ)** batch is invoked. You can configure the **Payment Request Periodic Monitor (C1-PAYRQ)** batch such that it is executed at regular intervals. When the **Payment Request Periodic Monitor (C1-PAYRQ)** batch is invoked, the system checks whether there are any payment requests in the **Deferred Distribution** status. If there is a payment request in the **Deferred Distribution** status, the system distributes the tender or payment amount.

On distributing and freezing the tender amount, the payment event, payments, payment segments, and payment tenders are created. The payments are created in the **Frozen** status. If any error occurs while creating the payment, the payment is created in the **Error** status. If all payments of a payment event are in the **Frozen** status, the status of the payment event is set to **Balanced**. However, if any payment of a payment event is in the **Error** status, the status of the payment event is set to **Unbalanced**. On distributing the payment amount (during transfer), the new payments are created in the **Frozen** status. If any error occurs while creating the new payment, the payment is created in the **Error** status. The status of the payment event is set to **Unbalanced**. The old payments in the payment event that you want to transfer remains in the **Frozen** or **Error** status.

Once the tender or payment amount is successfully distributed and frozen, the status of the payment request is changed to **Processed**.

Note:

The **Distribute And Freeze** button appears when the payment request is in the **Draft** status.

The sum of payment amount should be equal to the tender or transfer (payment) amount. Otherwise, the system will not allow you to distribute the tender or payment amount.

Related Topics

For more information on...	See...
How to search for a payment request	Searching for a Payment Request on page 1494
Payment Request screen	Payment Request (Used for Viewing) on page 1496
Payment Request zone	Payment Request on page 1496
How to edit the payment amount against each entity	Editing the Payment Amount on page 1511

Redistributing the Tender or Payment Amount**Procedure**

To redistribute the tender or payment amount:

1. Search for the payment request in the **Payment Request** screen.
2. In the **Search Results** section, click the link in the **Payment Request Information** column corresponding to the payment request whose tender or payment amount you want to redistribute.

The **Payment Request** screen appears.

3. In the **Payment Distribution** zone, click the **Redistribute** button in the **Redistribute** column corresponding to the payment distribution whose tender or payment amount you want to redistribute.

The required payment gets redistributed among the account's contracts.

Note: The **Redistribute** button appears when the payment status is in **Incomplete**, **Error**, or **Freezable** status.

Related Topics

For more information on...	See...
How to search for a payment request	Searching for a Payment Request on page 1494
Payment Request screen	Payment Request (Used for Viewing) on page 1496
Payment Request zone	Payment Request on page 1496
How to edit the payment amount against each entity	Editing the Payment Amount on page 1511

Editing the Payment Segment Amount

Before you freeze the payments, the system allows you to edit the pay segment amount of the payments which are in the **Freezable** status. You can edit the amount when there are multiple pay segments in a payment.

Procedure

To edit the payment segment amount:

1. Search for the payment request in the **Payment Request** screen.
2. In the **Search Results** section, click the link in the **Payment Request Information** column corresponding to the payment request whose details you want to edit.

The **Payment Request** screen appears.

3. Click the **Detail** button in the **Payment Distribution** zone.

The **Edit Payment Segment Amount** screen appears. It contains the following fields:

Field Name	Field Description
Payment Event Information	Displays information about the payment event which is created through the payment request.
Payment Information	Displays information about the payment which is created through the payment event.
Payee Account Information	Displays information about the account for which the payment is made.
Match Value	Displays information about the entity against which the payment is matched.
Payment Amount	Displays the total payment amount.
Running Total	Displays the sum of payment amount specified against each pay segment.
Running Balance	Displays the difference between total payment amount and running total. The running balance is highlighted in the red color when the difference amount is non-zero.

In addition, this section contains the following columns:

Column Name	Column Description	Mandatory (Yes or No)
Sr No	Indicates the sequence number of the pay segment.	Not applicable

Column Name	Column Description	Mandatory (Yes or No)
Entity Information	Displays information about the entity (such as bill segment or contract) against which the pay segment is created.	Not applicable
Total Amount	Displays the entity amount. If the pay segment is created against a contract, the system considers all bill segments of the bill which are created against the contract and calculates the total bill segment amount.	Not applicable
Unpaid Amount	Displays the amount which is eligible for payment. If the pay segment is created against a contract, the system considers all bill segments of the bill which are created against the contract and calculates the total unpaid bill segment amount.	Not applicable
Payment Amount	Used to specify the payment amount that you want to distribute against the pay segment. <div style="border: 1px solid black; padding: 5px;"> <p>Note: This field is non-editable when:</p> <ul style="list-style-type: none"> • There is only one pay segment in a payment. • A user with the approval To Do role is reviewing the pay segment amount. </div>	Yes
Payment Currency	Indicates the currency in which the payment was made.	Not applicable
Pay Segment ID	Displays the pay segment ID.	Not applicable

Note:

The **Detail** button appears in the **Detail** column when:

- The payment request is in the **Distributed** or **Approval In Progress** status
- The payment is in the **Freezable** status.

Pagination is used to display limited number of records in the **Edit Payment Segment Amount** screen. You can change the number of records displayed per page, if required. You can use the navigation buttons, such as **First** (<<), **Previous** (<), **Next** (>), and **Last** (>>) to navigate between pages. You can also select the page to which you want to navigate from the **Go To** list.

4. Modify the payment amount against a pay segment, if required.

Note: The sum of payment segment amount should be equal to the payment amount.

5. Click **Redistribute**.

The payment amount is redistributed among the pay segments.

Note: The **Redistribute** button is disabled when the **Payment Amount** field is non-editable.

6. Click **Close**.

Related Topics

For more information on...	See...
How to search for a payment request	Searching for a Payment Request on page 1494
Payment Request screen	Payment Request (Used for Viewing) on page 1496
Payment Distribution zone	Payment Distribution on page 1502

Freezing Payments Created Through a Payment Request

Procedure

To freeze the payments created through a payment request:

1. Search for the payment request in the **Payment Request** screen.
2. In the **Search Results** section, click the link in the **Payment Request Information** column corresponding to the payment request whose payments you want to freeze.

The **Payment Request** screen appears.

3. If required, you can edit the amount of a payment segment before freezing the payments.
4. Click the **Freeze** button in the **Payment Request** zone.

The system behaves in the following manner:

If you are...	Then
Freezing the payments created through a payment creation request	The status of the payments which are in the Freezable status is changed to Frozen . In addition, the status of the payment request is changed to Processed .
Freezing the payments created through a payment transfer request	The status of the old payments which are in the Frozen status is changed to Cancelled . The old payments which are in the Error status are deleted. The status of the new payments which are in the Freezable status is changed to Frozen . The status of the payment event is changed to Balanced when there are no new payments in the Error status. In addition, the status of the payment request is changed to Processed .

Note:

The **Freeze** button appears when:

- The payment request is in the **Distributed** status.
- The **Approval Required** check box is not selected in the payment request type using which the payment request is created.

For each payment, ensure that the sum of payment segment amount is equal to the payment amount. Otherwise, the system will not allow you to freeze the payments created through the payment request.

Related Topics

For more information on...	See...
How to search for a payment request	Searching for a Payment Request on page 1494
Payment Request screen	Payment Request (Used for Viewing) on page 1496

For more information on...	See...
Payment Request zone	Payment Request on page 1496
How to edit the amount of a payment segment	Editing the Payment Segment Amount on page 1520

Submitting a Payment Request for Approval

Procedure

To submit a payment request for approval:

1. Search for the payment request in the **Payment Request** screen.
2. In the **Search Results** section, click the link in the **Payment Request Information** column corresponding to the payment request that you want to submit for approval.

The **Payment Request** screen appears.

3. If required, you can edit the amount of a payment segment before submitting the payment request for approval.
4. Click the **Submit for Approval** button in the **Payment Request** zone.

The status of the payment request is changed to **Approval In Progress**. A To Do is created using the **C1-PAYRQ** To Do type. Users having a To Do role to which the **C1-PAYRQ** To Do type is associated can view the To Do from the **To Do List** screen.

Note:

The **Submit for Approval** button appears when:

- The payment request is in the **Distributed** status.
- The **Approval Required** check box is selected in the payment request type using which the payment request is created.

For each payment, ensure that the sum of payment segment amount is equal to the payment amount. Otherwise, the system will not allow you to submit the payment request for approval.

Related Topics

For more information on...	See...
How to search for a payment request	Searching for a Payment Request on page 1494
Payment Request screen	Payment Request (Used for Viewing) on page 1496
Payment Request zone	Payment Request on page 1496
How to edit the amount of a payment segment	Editing the Payment Segment Amount on page 1520

Approving a Payment Request

You can view the number of payment requests which are pending for approval in the **Payment Request** screen. The approver can review, and accordingly approve or reject the payment request based on the observations.

Note: The system will not allow you to approve or reject a payment request submitted by you.

Procedure

To approve a payment request:

1. Do either of the following:

If you want to	Then
Approve a payment request through the Payment Request screen	<ol style="list-style-type: none"> 1. Search for the payment request in the Payment Request screen. 2. In the Search Results section, click the link in the Payment Request Information column corresponding to the payment request which you want to review.
Approve a payment request from the To Do List screen	<ol style="list-style-type: none"> 1. Click the Menu link in the Application toolbar. A list appears. 2. From the Main menu, select To Do and then click To Do List. The To Do Type for User Search window appears. 3. Enter C1-PAYRQ in the To Do Type field. 4. Click the Search button corresponding to the To Do Type field. The To Do List screen appears. 5. Select the Open option from the Filter by list to view all unassigned To Dos. 6. Click the link in the Message column corresponding to the To Do of the payment request that you want to review.

The **Payment Request** screen appears.

2. Review the payment request details.
3. Click the **Approve** button in the **Payment Request** zone.

The system behaves in the following manner:

If you are...	Then
Approving a payment creation request	The status of the payments which are in the Freezable status is changed to Frozen . In addition, the status of the payment request is changed to Processed .
Approving a payment transfer request	The status of the old payments which are in the Frozen status is changed to Cancelled . The old payments which are in the Error status are deleted. The status of the new payments which are in the Freezable status is changed to Frozen . The status of the payment event is changed to Balanced when there are no new payments in the Error status. In addition, the status of the payment request is changed to Processed .

Note: The **Approve** button appears when:

- The payment request is in the **Approval In Progress** status.
- A user with the approval To Do role is reviewing the payment request.

Related Topics

For more information on...	See...
How to search for a payment request	Searching for a Payment Request on page 1494
Payment Request screen	Payment Request (Used for Viewing) on page 1496
Payment Request zone	Payment Request on page 1496

Rejecting a Payment Request

Prerequisites

To reject a payment request, you should have:

- Rejection reasons defined in the application

Note:

While rejecting a payment request, you need to specify the reason why you want to reject the payment request. If you are rejecting a payment creation request, you can select the appropriate rejection reason when you have defined the reasons for the **Rejected** status of the **C1-PaymentRequest** business object in the **Status Reason** screen. However, if you are rejecting a payment transfer request, you can select the appropriate rejection reason when you have defined the reasons for the **Rejected** status of the **C1-PaymentTransferRequest** business object in the **Status Reason** screen.

The system will not allow you to approve or reject a payment request submitted by you.

Procedure

To reject a payment request:

1. Do either of the following:

If you want to...	Then...
Reject a payment request through the Payment Request screen	<ol style="list-style-type: none"> 1. Search for the payment request in the Payment Request screen. 2. In the Search Results section, click the link in the Payment Request Information column corresponding to the payment request which you want to review.
Reject a payment request from the To Do List screen	<ol style="list-style-type: none"> 1. Click the Menu link in the Application toolbar. A list appears. 2. From the Main menu, select To Do and then click To Do List.

If you want to...	Then...
	<p>The To Do Type for User Search window appears.</p> <ol style="list-style-type: none"> Enter C1-PAYRQ in the To Do Type field. Click the Search button corresponding to the To Do Type field. <p>The To Do List screen appears.</p> <ol style="list-style-type: none"> Select the Open option from the Filter by list to view all unassigned To Dos. Click the link in the Message column corresponding to the To Do of the payment request that you want to review.

The **Payment Request** screen appears.

- Review the payment request details.
- If required, you can review the payment segment amount of each payment by clicking the **Detail** button in the **Detail** column corresponding to the payment in the **Payment Distribution** zone.
- Click the **Reject** button in the **Payment Request** zone.

The **Status Reason** window appears. It contains following fields:

Field Name	Field Description	Mandatory (Yes or No)
Status Reason	Used to indicate the reason why you want to reject the payment request.	Yes

Note: The **Reject** button appears when:

- The payment request is in the **Approval In Progress** status.
- A user with the approval To Do role is reviewing the payment request.

- Select the rejection reason from the **Status Reason** list.
- Click **Save**.

If the approver rejects a payment creation request, the payment event, payments, payment segments, and payment tender which are created through the payment creation request are deleted. However, if the approver rejects a payment transfer request, the new payments which are created through the payment transfer request are deleted. In addition, the status of the payment creation or transfer request is changed to **Rejected**.

Related Topics

For more information on...	See...
How to search for a payment request	Searching for a Payment Request on page 1494
Payment Request screen	Payment Request (Used for Viewing) on page 1496
Payment Request zone	Payment Request on page 1496

Discarding a Payment Request

1. Search for the payment request in the **Payment Request** screen.
2. In the **Search Results** section, click the link in the **Payment Request Information** column corresponding to the payment request which you want to discard.
3. Click the **Discard** button in the **Payment Request** zone.

Note:

The **Discard** button appears only when the payment request is in **Distributed** status.

If the approver discards a payment creation request, the payment event, payments, payment segments, and payment tender which are created through the payment creation request are deleted. However, if the approver discards a payment transfer request, the new payments which are created through the payment transfer request are deleted. In addition, the status of the payment creation or transfer request is changed to **Discarded**.

Discarding a payment request is similar to rejecting a payment request. However, you can only reject a payment request, when approval workflow is on while creating a payment request but discarding a payment request can be done in both the cases, when the approval workflow is on or off.

Related Topics

For more information on...	See...
How to search for a payment request	Searching for a Payment Request on page 1494
Payment Request screen	Payment Request (Used for Viewing) on page 1496
Payment Request zone	Payment Request on page 1496

Viewing the Log of a Payment Request

Procedure

To view the log of a payment request:

1. Search for the payment request in the **Payment Request** screen.
2. In the **Search Results** section, click the link in the **Payment Request Information** column corresponding to the payment request whose log you want to view.

The **Payment Request** screen appears. It consists of the following tabs:

- **Main** – This tab contains the following two zones:
 - **Payment Request** – Displays the details of the payment request.
 - **Payment Distribution** – Lists the payment distribution records of the payment request.
 - **Log** – This tab lists the complete trail of actions performed on the payment request.
3. Click the **Log** tab.

The **Payment Request Log** zone in the **Log** tab contains the following columns:

Column Name	Column Description
Date/Time	Displays the date and time when the action was performed on the payment request.
Details	Displays the details about the action performed on the payment request.
User	Indicates the user who has performed the action on the payment request.
Log Type	Indicates the type of log.
Related Object	Indicates the object or entity which is generated when the action is performed on the payment request.
Status Reason	Indicates the reason why the payment request was rejected.

Note: You can manually add a log entry for the payment request by clicking the **Add Log Entry** link in the upper right corner of the **Payment Request Log** zone.

Related Topics

For more information on...	See...
How to search for a payment request	Searching for a Payment Request on page 1494
How to add a log entry for a payment request	Adding a Log Entry for a Payment Request on page 1528

Adding a Log Entry for a Payment Request

Procedure

To add a log entry for a payment request:

1. Search for the payment request in the **Payment Request** screen.
2. In the **Search Results** section, click the link in the **Payment Request Information** column corresponding to the payment request whose log you want to edit.

The **Payment Request** screen appears. It consists of the following tabs:

- **Main** – This tab contains the following two zones:
 - **Payment Request** – Displays the details of the payment request.
 - **Payment Distribution** – Lists the payment distribution records of the payment request.
- **Log** – This tab lists the complete trail of actions performed on the payment request.

3. Click the **Log** tab.

The **Log** tab appears.

4. Click the **Add Log Entry** link in the upper right corner of the **Payment Request Log** zone.

The **Add Payment Request Log** window appears. It contains the following fields:

Field Name	Field Description	Mandatory (Yes or No)
Payment Request Information	Displays information about the payment request.	Not applicable

Field Name	Field Description	Mandatory (Yes or No)
Log Details	Used to specify additional comments for the payment request.	Yes

5. Enter the comments in the **Log Details** field.

6. Click **Save**.

The log entry is added in the **Payment Request Log** zone.

Related Topics

For more information on...	See...
How to search for a payment request	Searching for a Payment Request on page 1494

Payment Event Summary

The **Payment Event Summary** screen allows you to search for a payment event using various search criteria. Through this screen, you can:

- View the payments created through a payment event
- View payment segments of a payment
- Transfer one or more payments of a payment event to another payee account
- Cancel a payment event
- Delete a payment event
- Cancel a payment of a payment event
- Delete a payment of a payment event
- Refund a payment which is matched against the suspense or excess credit contract

This screen consists of following zones:

- [Search Payment Event](#) on page 1529
- [Payments](#) on page 1532
- [Payment Segments](#) on page 1534

Search Payment Event

The **Search Payment Event** zone allows you to search for a payment event using various search criteria. This zone contains the following two sections:

- **Search Criteria** — The **Search Criteria** section contains the following fields:

Field Name	Field Description	Mandatory (Yes or No)
Search By	<p>Used to indicate whether you want to search for a payment event using the payor, payment event, tender, or contract details. The valid values are:</p> <ul style="list-style-type: none"> • Payor Account/Payment Event • Tender Details • Suspense/Excess Credit Contract <p>Note: By default, the Payor Account/Payment Event option is selected.</p>	Yes
Payment Event ID	<p>Used to search a particular payment event.</p> <p>Note: This field appears when you select the Payor Account/Payment Event option from the Search By list. The Search (🔍) icon appears corresponding to this field. On clicking the Search icon, the Payment Event Search window appears.</p>	No
Payor Account ID	<p>Used to search payment events which are created for a particular payor account.</p> <p>Note: This field appears when you select the Payor Account/Payment Event option from the Search By list. The Search (🔍) icon appears corresponding to this field. On clicking the Search icon, the Account Search window appears.</p>	No
Payor Name	<p>Used to search payment events which are created for a particular payor.</p> <p>Note: This field appears when you select the Payor Account/Payment Event option from the Search By list.</p>	No
Payment Date	<p>Used to search payment events which are created on a particular date.</p> <p>Note: This field appears when you select the Payor Account/Payment Event option from the Search By list.</p>	No
Tender Type	<p>Used to search payment events where a particular tender type is used.</p> <p>Note: This field appears when you select the Tender Details option from the Search By list.</p>	No

Field Name	Field Description	Mandatory (Yes or No)
Check Number	Used to search a payment event which includes payments made through a particular check.	No
	Note: This field appears when you select the Tender Details option from the Search By list.	
MICR ID	Used to search payment events which include payments made with a particular MICR code.	No
	Note: This field appears when you select the Tender Details option from the Search By list.	
Contract ID	Used to search payment events which include payments made against a particular suspense or excess credit contract.	No
	Note: This field appears when you select the Suspense/Excess Credit Contract option from the Search By list. The Search  icon appears corresponding to this field. On clicking the Search icon, the Contract Search window appears.	

Note: You must specify at least one search criterion while searching for a payment event.

- **Search Results** — On clicking the **Search** button, the search results appear based on the specified search criteria. The **Search Results** section contains the following columns:

Column Name	Column Description
Payment Event Information	Displays additional information about the payment event.
	Note: It has a link. On clicking the link, the Payment Event screen appears where you can view the details of the respective payment event.
Transfer	On clicking the Transfer button, you can transfer all payments (which are in either Frozen and Error status) of the payment event to another payee account.
	Note: The Transfer button appears when: <ul style="list-style-type: none"> • One or more payments of the payment event are in the Frozen or Error status. • There is no payment transfer request which is currently in progress for the payment event.

Column Name	Column Description
Cancel	On clicking the Cancel button, you can cancel all payments (which are in the Frozen status) of the payment event.
	<p>Note: The Cancel button appears when:</p> <ul style="list-style-type: none"> • One or more payments of the payment event are in the Frozen status. • One or more payments of the payment event are not in the Freezable or Error status. • There is no payment transfer request which is currently in progress for the payment event.
Delete	On clicking the Delete button, you can delete the payment event.
	<p>Note: The Delete button appears when the payments of a payment event are in the Freezable, Error or Incomplete status.</p>
Additional Information	Displays information about the status of the payment event.
Payment Date	Displays the date when the payment was made.
Payor Name	Indicates the person who has made the payment.
	<p>Note: It has a link. On clicking the link, the Person screen appears where you can view the details of the respective person.</p>
Payor Account ID	Indicates the account which made the payment.
	<p>Note: It has a link. On clicking the link, the Account screen appears where you can view the details of the respective account.</p>
Tender Amount	Displays the tender amount.
Payment Event ID	Displays the payment event ID.

Related Topics

For more information on...	See...
How to search for a payment event	Searching for a Payment Event on page 1534
How to transfer payments of a payment event	Creating a Payment Transfer Request on page 1535
How to cancel a payment event	Cancelling a Payment Event on page 1539
How to delete a payment event	Deleting a Payment Event on page 1540

Payments

The **Payments** zone lists all payments created through the payment event. This zone contains the following columns:

Column Name	Column Description
Payment ID	Displays the payment ID.
	<p>Note: It has a link. On clicking the link, the Payment screen appears with the details of the respective payment.</p>

Column Name	Column Description
Payee Account Information	Displays information about the account for which the payment was made. In addition, this column has a context menu which helps in navigating to other screens in the application.
	Note: It has a link. On clicking the link, the Account screen appears with the details of the respective account.
Payment Amount	Displays the amount paid through the tender.
Payment Currency	Indicates the currency in which the payment was made.
Payment Status	Indicates the status of the payment. The valid values are: <ul style="list-style-type: none"> • Incomplete • Error • Freezable • Frozen • Canceled
Match Type	Indicates the match type using which the payment was matched.
Match Value	Indicates the entity (such as bill, bill segment, or contract) against which the payment was matched.
Error Message	Indicates the reason why the payment is in the Error status.
Payor Account ID	Indicates the account which made the payment.
Refund Amount	Displays the amount which is already refunded to the payor account.

In addition, this zone contains the following buttons:

Button Name	Button Description
Transfer	Used to transfer the payment to another payee account.
	Note: You can transfer a payment when it is in the Frozen or Error status.
Cancel	Used to cancel the payment.
	Note: You can cancel a payment when it is in the Frozen status.
Delete	Used to delete the payment.
	Note: You can delete a payment when it is in the Freezable or Error status.
Refund	Used to refund the payment amount to the payor account.
	Note: You can refund the payment amount to the payor account when: <ul style="list-style-type: none"> • The payment is matched against the suspense or excess credit contract. • The payment is in the Frozen status.

Related Topics

For more information on...	See...
How to view payments created through a payment event	Viewing Payments Created Through a Payment Event on page 1540
How to cancel a payment	Cancelling a Payment on page 1541
How to delete a payment	Deleting a Payment on page 1541
How to transfer a payment	Creating a Payment Transfer Request on page 1535
How to refund a payment	Creating a Refund Request on page 1738

Payment Segments

The **Payment Segments** zone lists payment segments of a payment. This zone contains the following columns:

Column Name	Column Description
Pay Segment ID	Displays the payment segment ID.
	Note: It has a link. On clicking the link, the Pay Segments tab of the Payment screen appears where you view the details of the payment segment.
Contract Information	Displays information about the contract against which the payment segment is created. In addition, this column has a context menu which helps in navigating to other screens in the application.
	Note: It has a link. On clicking the link, the Contract screen appears where you can view the details of the respective contract.
Payment Amount	Displays the payment segment amount.
Match Event ID	Indicates the match event which is created for the payment segment.
	Note: It has a link. On clicking the link, the Match Event screen appears where you can view the details of the respective match event.

Related Topics

For more information on...	See...
How to view payment segments of a payment	Viewing Payment Segments of a Payment on page 1542

Searching for a Payment Event

Prerequisites

To search for a payment event, you should have:

- Tender types defined in the application

Procedure

To search for a payment event:

1. Click the **Menu** link in the **Actions/Navigation** area.
A list appears.
2. Select the **Main Menu** option from the list.

- From the **Main Menu**, select **Payments** and then click **Payment Event Summary**.

The **Payment Event Summary** screen appears.

- Enter the search criteria in the **Search Payment Event** zone.

Note:

You can search for a payment event and payor account by clicking the **Search** (🔍) icon corresponding to the respective field.

ORMB search engine supports wildcard search, where you can substitute the percentage (%) symbol as a stand in for any word or letter in a search criteria. You can use the ‘%’ wildcard character in all input fields except the date and ID fields. The ‘%’ wildcard character is suffixed automatically at the end of the partial search criteria. Therefore, you may or may not specify the wildcard character at the end of the partial search criteria. However, you have to prefix the wildcard character manually wherever required.

- Click **Search**.

A list of payment events that meet the search criteria appears in the **Search Results** section.

Related Topics

For more information on...	See...
Payment Event Summary screen	Payment Event Summary on page 1529
Search Payment Event zone	Search Payment Event on page 1529

Creating a Payment Transfer Request

The system allows you to transfer payments through a payment request. You can transfer all payments or individual payment of a payment event. You can only transfer payments which are in the **Frozen** or **Error** status.

Prerequisites

To create a payment transfer request, you should have:

- Payment request types defined in the application (where the **Transfer** check box is selected)
- Payment cancel reasons defined in the application (where the **Payment Transfer** check box is selected)

Procedure

To create a payment transfer request:

- Search for the payment event (whose payments you want to transfer) in the **Payment Event Summary** screen.
- Do either of the following:

If you want to...	Then...
Transfer all payments of a payment event	<ol style="list-style-type: none"> In the Search Results section, click the Transfer button in the Transfer column corresponding to the payment event whose payments you want to transfer.

If you want to...	Then...
	<p>Note: The Transfer button appears only when:</p> <ul style="list-style-type: none"> • One or more payments of the payment event are in the Frozen or Error status. • There is no payment transfer request which is currently in progress for the payment event.
Transfer one or more payments of a payment event	<ol style="list-style-type: none"> 1. In the Search Results section, click the Broadcast () icon corresponding to the payment event whose payments you want to view. The Payments zone appears. 2. Select the check box corresponding to the payments that you want to transfer. 3. Click the Transfer button in the Payments zone. <p>Note: You can transfer a payment when it is in the Frozen or Error status.</p>

The **Select Payment Request Type** screen appears. It contains the following fields:

Field Name	Field Description	Mandatory (Yes or No)
Payment Request Type	Used to indicate the payment request type using which you want to create the payment request. Note: The list includes only those payment request types where the Transfer check box is selected.	Yes

3. Select the required payment request type from the respective field.
4. Click **OK**.
 - **Main** - Used to specify basic details about the payment request. This section contains the following fields:

Field Name	Field Description	Mandatory (Yes or No)
Payment Request Type	Indicates the payment request type using which you want to create the payment request.	Not applicable
Payment Event Information	Displays information about the payment event whose payments you want to transfer.	Not applicable
Transfer Amount	Displays the total payment amount which you want to transfer.	Not applicable

Field Name	Field Description	Mandatory (Yes or No)
Payment Date	Used to specify the date when the payment was transferred.	Yes
	Note: By default, the current date appears in this field.	
Transfer Reason	Used to indicate the reason why you want to transfer the payments.	Yes
	Note: The list includes only those payment cancel reasons where the Payment Transfer check box is selected.	

- **Payor Account Details** — This section contains the following columns:

Column Name	Column Description
Payor Account Information	Displays information about the payor's account whose payments you want to transfer.

- **Payment Details** — This section contains the following columns:

Column Name	Column Description
Payment(s)	Displays information about the payment that you want to transfer.

- **Match Types** - Used to define match types for the payment request. This section contains the following fields:

Field Name	Field Description	Mandatory (Yes or No)
Match Type	Used to indicate the match type using which you want to match the payment.	Yes
Show Default	Used to indicate whether the default payment amount should be displayed against the match type entities.	No
	Note: By default, the Show Default check box is selected when you select the match type.	
Entity	Indicates the match type entity. The valid values are: <ul style="list-style-type: none"> • Account — Enables you to select the account whose unpaid bills, unpaid bill segments, settlement IDs, or contracts must be considered while matching the payment. • Bill — Enables you to select the unpaid bill against which you want to match the payment. 	Not applicable
Entity ID	Used to specify the account or bill ID depending on the match type entity.	Yes

5. Enter the required details.

Note:

You can search for an entity (such as account or bill) by clicking the **Search** (🔍) icon corresponding to the respective field.

If you want to specify more than one match type within the payment request, click the **Add** (+) icon in the **Match Types** section and then specify the details. However, if you want to remove a match type from the payment request, click the **Delete** (🗑️) icon corresponding to the match type.

6. Click Manual Distribution.

The payment request is created and the status of the payment request is set to **Draft**. The **Payment Request** screen appears. Depending on the match type and match entity specified while creating the payment request, the following entities are listed in the **Payment Distribution** zone:

Match Type	Match Entity	Entities
By Bill Regular	Account	Unpaid bills of the account
By Bill Weighted	Account	Unpaid bills of the account
By Bill	Bill	Unpaid bill
By Bill Segments	Account	Unpaid bill segments
By Suspense Contract	Account	Contracts of the account Note: Only contracts of the contract type where the Eligible for Billing flag is set to No and Special Role flag is set to Suspense are listed in the Payment Distribution zone. If no contracts with this specification exist for the account, the system checks whether there is any such contract type (where the Eligible for Billing flag is set to No and Special Role flag is set to Suspense) defined for the division to which the account belongs. If there is any such contract type defined for the division, the system creates the contract for the account using the respective contract type and the same is listed in Payment Distribution zone.
By Settlement	Account	Unpaid bill segments where the settlement account is stamped

If the **Show Default** check box is not selected against a match type while creating the payment request, the payment amount against the respective match type entities is set to zero. However, if the **Show Default** check box is selected against a match type, the payment amount appears against the respective match type entities. The transfer amount is divided among the entities in the sequence of match types (where **Show Default** check box is selected) followed by the sequence of bill, bill segment, or contract start date. You can then edit the payment amount, if required.

Note:

If a payment request is already created for a payee account and is currently in progress, the system will not allow you to create another payment request for the payee account until the previous payment request is in the **Processed** or **Rejected** status.

The system does not allow you to create a payment request for a payee account when the respective match type entities (such as unpaid bills, unpaid bill segments, contracts, or settlement IDs) do not exist for the payee account.

Related Topics

For more information on...	See...
How to search for a payment event	Searching for a Payment Event on page 1534
Payment Request screen	Payment Request (Used for Viewing) on page 1496
Payment Distribution zone	Payment Distribution on page 1502
How to view the details of a payment transfer request	Viewing the Payment Request Details on page 1495
How to edit a payment transfer request	Editing a Payment Request on page 1513
How to delete a payment transfer request	Deleting a Payment Request on page 1516
How to edit the payment amount against each entity	Editing the Payment Amount on page 1511
How to distribute the tender or payment amount	Distributing the Tender or Payment Amount on page 1517
How to freeze the payments created through a payment transfer request	Freezing Payments Created Through a Payment Request on page 1522
How to approve a payment transfer request	Approving a Payment Request on page 1523
How to reject a payment transfer request	Rejecting a Payment Request on page 1525
How to edit the amount of a payment segment	Editing the Payment Segment Amount on page 1520
How to submit a payment transfer request for approval	Submitting a Payment Request for Approval on page 1523

Canceling a Payment Event**Prerequisites**

To cancel a payment event, you should have:

- Payment cancel reasons defined in the application

Procedure

To cancel a payment event:

1. Search for the payment event in the **Payment Event Summary** screen.
2. In the **Search Results** section, click the **Cancel** button in the **Cancel** column corresponding to the payment event that you want to cancel.

The **Cancel** window appears. It contains the following fields:

Field Name	Field Description	Mandatory (Yes or No)
Cancel Reason	Used to indicate the reason why you want to cancel the payment event.	Yes
Bank	Used to indicate the bank which should be charged for the cancellation.	Yes
Bank Account	Used to indicate the bank account which should be charged for the cancellation.	Yes

Note: The **Cancel** button appears when:

- One or more payments of the payment event are in the **Frozen** status.
- One or more payments of the payment event are not in the **Freezable** or **Error** status.
- There is no payment transfer request which is currently in progress for the payment event.

3. Select the cancel reason, bank, and bank account from the respective fields.

4. Click **OK**.

The payment tender and all payments in the payment event are cancelled.

Related Topics

For more information on...	See...
How to search for a payment event	Searching for a Payment Event on page 1534

Deleting a Payment Event

You can delete a payment event when the payment(s) of the payment event are in the **Freezable**, **Error**, or **Incomplete** status. On deleting a payment event, the payment event, payments, payment segments, and payment tender are deleted.

Procedure

To delete a payment event:

1. Search for the payment event in the **Payment Event Summary** screen.
2. In the **Search Results** section, click the **Delete** button in the **Delete** column corresponding to the payment event that you want to delete.

A message appears confirming whether you want to delete the payment event.

Note: The **Delete** button appears when the payments of a payment event are in the **Freezable**, **Error**, or **Incomplete** status.

3. Click **OK**.

The payment event is deleted.

Related Topics

For more information on...	See...
How to search for a payment event	Searching for a Payment Event on page 1534

Viewing Payments Created Through a Payment Event

Procedure

To view payments created through a payment event:

1. Search for the payment event in the **Payment Event Summary** screen.
2. In the **Search Results** section, click the **Broadcast** () icon corresponding to the payment event whose payments you want to view.

The **Payments** zone appears.

- View all payments created through the payment event in the **Payments** zone.

Related Topics

For more information on...	See...
How to search for a payment event	Searching for a Payment Event on page 1534
Payments zone	Payments on page 1532

Canceling a Payment

Prerequisites

To cancel a payment of a payment event, you should have:

- Payment cancel reasons defined in the application

Procedure

To cancel a payment of a payment event:

- Search for the payment event in the **Payment Event Summary** screen.
- In the **Search Results** section, click the **Broadcast** () icon corresponding to the payment event whose payment you want to cancel.

The **Payments** zone appears.

- Select the check box corresponding to the payment that you want to cancel.
- Click **Cancel** in the **Payments** zone.

The **Payment Cancel** window appears. It contains the following fields:

Field Name	Field Description	Mandatory (Yes or No)
Cancel Reason	Used to indicate the reason why you want to cancel the payment.	Yes

Note: You can cancel a payment when it is in the **Frozen** status.

- Select the cancel reason from the respective list.
- Click **OK**.

The status of the payment is changed to **Canceled**.

Related Topics

For more information on...	See...
How to search for a payment event	Searching for a Payment Event on page 1534
Payments zone	Payments on page 1532

Deleting a Payment

Procedure

To delete a payment of a payment event:

1. Search for the payment event in the **Payment Event Summary** screen.
2. In the **Search Results** section, click the **Broadcast** () icon corresponding to the payment event whose payment you want to delete.

The **Payments** zone appears.

3. Select the check box corresponding to the payment that you want to delete.
4. Click **Delete** in the **Payments** zone.

A message appears confirming whether you want to delete the payment.

Note: You can delete a payment when it is in the **Freezable** or **Error** status.

5. Click **OK**.



The payment is deleted.

Related Topics

For more information on...	See...
How to search for a payment event	Searching for a Payment Event on page 1534
Payments zone	Payments on page 1532

Viewing Payment Segments of a Payment**Procedure**

To view payment segments of a payment:

1. Search for the payment event (whose payment details you want to view) in the **Payment Event Summary** screen.
2. In the **Search Results** section, click the **Broadcast** () icon corresponding to the payment event whose payments you want to view.
The **Payments** zone appears.
3. Click the **Broadcast** () icon corresponding to the payment whose payment segments you want to view.
The **Payment Segments** zone appears.
4. View the payment segments of the payment in the **Payment Segments** zone.

Related Topics

For more information on...	See...
How to search for a payment event	Searching for a Payment Event on page 1534
Payment Segments zone	Payment Segments on page 1534

Chapter 21

Account Receivable Central

Topics:

- [Single Offset](#)
- [Mass Offset](#)
- [Cross Currency Offset](#)
- [Hold](#)
- [Refund](#)
- [Write Off](#)
- [Dispute](#)
- [Account Receivable Central](#)

The Account Receivable Central is a portal which facilitates user to perform Single/Mass/Cross Currency offset operation for a bill's outstanding amount with another bill or multiple bills. You can also refund/write off amount to the account using refund requests and write off requests respectively.

Account Receivable Central also enables to put bill(s) on hold for the funding purpose. It allows you to have a complete overview of the bills. Based on the search criteria, the system returns a list of bills that meet the search criteria.

Account Receivable Central is used for:

- **Single Offset** - Enables single debit bill to be offset against multiple credit bills in the same currency and vice versa.
- **Mass Offset** - Enables credit/debit bills to be offset against multiple debit and credit bills in the same currency.
- **Cross Currency Offset** - Enables single debit bills to be offset against multiple credit bills in currencies other than the bill selected for offset and vice versa.
- **Hold** - Enables bill(s) to be put on hold fully (the bill outstanding amount) or partially (the bill outstanding amount in partial) for a specific period for funding.
- **Refund** - Enables you to refund amount of credit bill or bill line item (credit bill segment or adjustment) to the account through a refund request.
- **Write Off** - Enables you to write off amount to the account through a write off request.
- **Dispute** - Enables you to dispute amount of credit/debit bill or bill item (credit/debit bill segment or adjustment) to the account through a dispute request.

The bill(s) for offsetting can belong to the same person or multiple persons depending upon the option **Allow Offsetting across Persons** set in the feature configuration **C1-OFFSETREQ** which allows offsetting in the system.

Single Offset

Single Offset enables you to search and add bill to an offset request from the **Account Receivable Central** screen. Single Offset enables single debit bill to be offset against multiple credit bills in the same currency and vice versa. The offset request is created and an offset request ID is generated for the request.

You can search and select credit/debit bills (with outstanding amount) for offsetting belonging to the same or different person. All the selected bills with their outstanding balance are displayed. The display of bills is controlled by **C1-OFFSETREQ** feature configuration. The feature configuration identifies whether offsetting is allowed for bills across persons. To offset bills belonging to different persons, set the **Allow Offsetting Across Persons** option type to **Y**. The bills are displayed having same currency with the default offset amount on the offset request after adding the bills. You can select one or multiple or all the bills displayed and add to the offset request. After you add a debit bill from **Account Receivable Central**, you cannot add more debit bills to the offset request.

Upon adding a bill to the offset request, the default offset amount algorithm **C1-OFST-AMT** configured in the offset request type is invoked. The bills in the offset request are processed based on the logic of oldest bill first. The default offset amount is populated against the selected debit and credit bills. You can also edit the offset amount from the offset request, if required. The offset adjustments for offset requests are created and distributed based on the match type set in the offset distribution algorithm.

You can configure the offset request type to be submitted for offset distribution with or without approval. Upon submitting the offset request for approval, a To Do type is created and sent to the approver for offset request approval. The status of the offset request changes from **Submitted** to **Approval In Progress** in case of offset request with approval and in case of offset request without approval it changes to **Processed**. The approver can either approve or reject the offset request. Once the approver approves the offset request, selected bills are offset and adjustments are created for the bills. The status of the offset request changes from **Approval In Progress** to **Processed**. You can also view the details of the adjustment(s) created. However, if the approver rejects an offset request, a rejection reason should be provided.

A log maintained for offset requests logs complete trail of actions performed on offset request except the actions performed while editing the offset request. On submitting, the offset request status changes to **Processed** or **Approval In Progress** depending on the configuration of the offset request type and the **Unapply** button is enabled which cancels the adjustments. Upon cancelling the adjustments, the enter status algorithm cancels the offset adjustments and the status of the request changes to **Unapplied Offset**.

Note: The **Unapply** button appears when the offset request is in the **Processed** status

Bill Information	Original Outstanding Amount	Offset Amount	Remaining Bill Balance	Comments
Bill 1	\$1200	—\$800	\$400	Bill 1 amount \$1200 is offset against Bill 2.
Bill 2	—\$1000	\$500	—\$500	From Bill 2, \$500 is offset against from Bill 1.
Bill 3	—\$300	\$300	0	From Bill 3, \$300 is offset against from Bill 1.

Mass Offset

Mass offset functions is similar to single offset, the only difference is that mass offset enables credit/debit bills to be offset against multiple debit and credit bills in the same currency.

Upon selection of a debit/credit bill from **Account Receivable Central**, you can add more credit/debit bill(s) from the search bills result in offset request. You can filter the bills using the **Bill Type** filter on the bill search zone to select debit/credit bills to be added to the offset request. While offsetting the credit/debit amount across multiple bills, the oldest bill is offset first.

A log maintained for offset requests logs complete trail of actions performed on offset request. Once you submit the offset request, the offset request status changes to **Processed** or **Approval In Progress** depending on the configuration of the offset request type. When the offset request status changes to **Processed** adjustments are created and the **Unapply** button is enabled which cancels the adjustments. Upon unapplying the offset request, the enter status algorithm cancels the offset adjustments and the status of the request changes to **Unapplied Offset**.

Bill Information	Original Outstanding Amount	Offset Amount	Remaining Bill Balance	Comments
Bill 1	\$2000	—\$700	\$1300	The Offset amount \$400 is offset against Bill 2.
Bill 2	—\$400	\$400	0	Bill 2 is offset against \$400 from Bill Outstanding amount of Bill 1 i.e. \$2000.
Bill 3	—\$300	\$300	0	Bill 3 is offset against \$300 from Bill Outstanding amount of Bill 1 i.e. \$1600.

Cross Currency Offset

Enables single debit bills to be offset against multiple credit bills in currencies other than the bill selected for offset and vice versa. Cross-currency offset enables you to offset credit/debit bills with different currencies. You can add credit/debit bills to the debit/credit bill added from **Account Receivable Central**. After you add a debit bill from **Account Receivable Central**, you cannot add more debit bills to the offset request. While offsetting the credit/debit amount across multiple bills, the oldest bill is offset first.

The **C1-OFFSUBENT** algorithm validates whether the sum of debit offset amount is equal to sum of credit offset amount for all bills selected in the offset request. After validation, status of the offset request changes to **Processed** or **Approval In Progress** depending on the configuration of the offset request type.

Bill Information	Outstanding Amount	Outstanding Amount (in Offset currency)	Offset Amount	Remaining Bill Balance	Comments
Bill 1	\$300	\$300	—\$130.1	\$169.9	Outstanding amount \$300 is offset against \$130.1 (£100). (Exchange rate: 1£=1.3\$)
Bill 2	—£100	—\$130.1	\$130.1	0	Outstanding amount £100 (\$130.1) of Bill 2 is offset against \$300 from Bill 1.

Note: In case of multiple exchange rates with same date and different timestamps, the latest timestamp is considered.

Note: The adjustments are created in the currency of the bill.

Hold

Account Receivable Central enables bill(s) to be put on hold which belongs to a person's account or all accounts of a particular person. When a bill is put on hold, specific reason must be specified; no funding related activities can be performed for the specified period.

Funding related activities are put on hold from the start date of the hold request. The hold exists till the hold request release date; however you can also release individual bills.

You can only put bills on hold which has **Completed** status. When a person/account is on hold, all the subsequent bills under them are also on hold irrespective of bill status. You can select the bill amount in a bill to be put on hold i.e. you can put the particular bill on hold with partial or full bill amount.

Hold request type is used to define the hold request. In the hold request type, the **Hold Process** is set to **Funding**, which puts hold on only the funding activities of the selected bill belonging to a person or account.

Refund

Enables you to refund amount of credit bill to account through a refund request. For creating a refund request you need to specify the refund request type using which you want to create the refund request. The refund request can be defined with (single level/multi-level) or without approval workflow. An approval profile should be defined for the approval workflow. While defining the refund request type, the adjustment type should be defined for creating refund adjustments.

Write Off

Enables you to write off the amount to the account through a write off request. For creating a write off request you need to specify the write off request type. The write off request can be defined with (single level/multi-level) or without approval workflow. An approval profile should be defined for the approval workflow. While defining the write off request type, the adjustment type should be defined for creating write off adjustments.

Dispute

Enables you to dispute amount of credit/debit bill to an account through a dispute request. For creating a dispute request you need to specify the dispute request type using which you want to create the dispute request. The dispute request can be defined with (single level/multi-level) or without approval workflow. An approval profile should be defined for the approval workflow. While defining the dispute request type, the adjustment type should be defined for creating dispute adjustments.

Account Receivable Central

The **Account Receivable Central** screen allows you to search for bills using various search criteria. This screen consists of the following zones:

- [Search Bill](#) on page 1546

Through the **Account Receivable Central** screen, you can navigate to the following screens:

- [Offset Request \(Used for Viewing\)](#) on page 1597
- [Hold Request \(Used for Viewing\)](#) on page 1847
- [Refund Request](#) on page 1744
- [Write Off Request](#) on page 1777
- [Dispute Request \(Used for Viewing\)](#)

Search Bill

The **Search Bill** zone allows you to search for bills in the **Accounts Receivable Central** screen using various search criteria. This zone contains the following two sections:

- **Search Criteria** — The **Search Criteria** section contains the following fields:

Field Name	Field Description	Mandatory (Yes or No)
Search By	Used to indicate whether you want to search bills using bill details, using account details or using person details whose account is linked to a particular bill. The valid values are: <ul style="list-style-type: none"> • Person Details • Account Details • Bill Details 	Yes
	Note: By default, the Person Details option is selected.	
Person ID	Used to select the person ID based on which you want to search for bills of a person.	No
	Note: This field appears when you select the Person Details option from the Search By list. The Search (🔍) icon appears corresponding to this field. On clicking the Search icon, the Account Search window appears.	
Person Hierarchy	Used to indicate whether to display hierarchy of the person linked to a particular bill.	No
	Note: This field appears when you select the Person Details option from the Search By list.	
Person Identifier Type	Used to select the identifier type based on which you want to search for bills of a person.	Yes (Conditional)
	Note: This field appears when you select the Person Details option from the Search By list.	
Person Identifier	Used to specify the value of the person identifier type.	Yes (Conditional)
	Note: This field appears when you select the Person Details option from the Search By list.	
Bills on Hold	Used to indicate whether the bill is on hold. The valid values are: <ul style="list-style-type: none"> • No • Yes 	No

Field Name	Field Description	Mandatory (Yes or No)
Bill Balance	Used to search bills with a particular balance amount. The valid values are: <ul style="list-style-type: none"> • Equal to Zero • Greater Than Zero • Less Than Zero • Not Equal to Zero 	No
Pending Bills	Used to indicate whether the bill is pending.	No
Account ID	Used to search for bills of a particular account. Note: This field appears when you select the Account Details option from the Search By list.	No
Account Identifier Type	Used to specify the account identifier type of the account whose bill you want to search. Note: This field appears when you select the Account Details option from the Search By list.	No
Account Identifier	Used to select the account identifier based on which you want to search for bills of a particular account. Note: This field appears when you select the Account Details option from the Search By list.	No
Bill ID	Used to search a particular bill. Note: This field appears when you select the Bill Details option from the Search By list.	No
Alternate Bill ID	Used to search a particular bill using the alternate bill ID. Note: This field appears when you select the Bill Details option from the Search By list.	No
Invoice Currency	Used to search for bills which are billed in a particular currency. Note: This field appears when you select the Bill Details option from the Search By list.	No
Bill Date From	Used to search bills which are created from a particular date onwards.	No
To	Used to search bills which are created till a particular date.	No
Bill Outstanding Amount From	Used to search bills with a particular minimum outstanding amount.	

Field Name	Field Description	Mandatory (Yes or No)
To	Used to search bills with a particular maximum outstanding amount.	

Note: You must specify at least one search criterion while searching for a bill when you select the **Person Details** or **Account Details** option from the **Search By** list.

- **Search Results** — On clicking the **Search** button, the search results appear based on the specified search criteria. The **Search Results** section contains the following columns:

Column Name	Column Description
Bill Information	Displays additional information about the bill. In addition, this column has a context menu which helps in navigating to other screens in the application. Note: It has a link. On clicking the link, the Bill screen appears with the details of the respective bill.
Original Bill Amount	Displays the bill amount when the bill was generated.
Outstanding Amount	Displays the current bill balance amount.
Bill Date	Used to specify the date on which the bill was generated.
Hold Amount	Displays the amount from the bill that is on hold.
Account Information	Displays additional information about the account. In addition, this column has a context menu which helps in navigating to other screens in the application. A tool tip appears when you hover over this column corresponding to the bill. It indicates the Current Balance, Excess Payment and Unapplied Payments and their values. Note: It has a link. On clicking the link, the Account screen appears where you can view the details of the respective bill.
Person Information	Displays additional information about the person. In addition, this column has a context menu which helps in navigating to other screens in the application. Note: It has a link. On clicking the link, the Person screen appears with the details of the respective bill.

This zone contains following buttons:

Button Name	Button Description
Single Offset	Used to add the selected bill with same currency to an offset request.
Mass Offset	Used to add the selected bills with same currency to an offset request.
Cross Currency Offset	Used to add the selected bills with different currency to an offset request.
Hold	Used to add the selected bill to hold request to be put on hold.
Write Off	Used to add the selected bill to a write off request.
Refund	Used to add the selected bill to a refund request.
Dispute	Used to add the selected bill to a dispute request.

Related Topics

For more information on...	See...
How to search for bill	Searching for a Bill on page 1551
How to view the details of a bill	Viewing the Bill Details on page 1552

Bill Information

The **Bill Information** screen allows you to view detail information of a particular bill.

This screen consists of the following zones:

- [Hold Details](#) on page 1550
- [Offset Details](#) on page 1550
- [Garnishment Details](#) on page 1551
- [Bill Line Items](#) on page 1551

Offset Details

The **Offset Details** zone displays details of the offset request. This zone contains following columns:

Column Name	Column Description
Offset Request Information	Displays additional information about the offset request.
	Note: It has a link. On clicking the link, the Offset Request screen appears where you can view the details of the respective offset request.
Offset Amount	Displays the total offset amount.
Creation Mode	Displays the mode of creation for offset request . The valid values are: <ul style="list-style-type: none"> • Automatic • Manual

Hold Details

The **Hold Details** zone displays details of the hold request on a bill. This zone contains following columns:

Column Name	Column Description
Hold Request Information	Displays additional information about the hold request.
	Note: It has a link. On clicking the link, the Hold Request screen appears where you can view the details of the respective hold request.
Status	Indicates the status of the hold request.
Entity	Displays the type of entity.
Hold Entity	Displays additional information about the bill which is put on hold.
	Note: It has a link. On clicking the link, the Bill screen appears where you can view the details of the respective bill.
Start Date	Displays the start date of the hold request.
End Date	Displays the end date of the hold request.

Garnishment Details

The **Garnishment Details** zone displays details garnishment details of the offset request. This zone contains following columns:

Column Name	Column Description
Garnishment Contract	Displays additional information about the contract created against the garnishment adjustments. In addition, this column has a context menu which helps in navigating to other screens in the application. Note: It has a link. On clicking the link, the Contract screen appears where you can view the details of the respective contract.
Garnishment Amount	Displays the total garnishment amount.

Bill Line Items

The **Bill Line Items** zone displays information about the selected bill's bill line item. This zone contains the following fields:

Field Name	Field Description
Bill Line Item	Displays the bill line item (bill segment/adjustment) of the selected bills.
Bill Line Item Information	Displays the information about the bill line item. Note: It has a link. On clicking the link, the Bill Segment screen or Adjustments screen appears with the details of the respective bill line item or adjustments.
Amount	Displays the amount of the bill line item.
Contract Information	Displays additional information about the contract against which the bill segment or adjustment is created. In addition, this column has a context menu which helps in navigating to other screens in the application. Note: It has a link. On clicking the link, the Contract screen appears where you can view the details of the respective contract.

Related Topics

For more information on...	See...
How to view the details of a bill	Viewing the Bill Details on page 1552

Searching for a Bill

Procedure

To search for a bill:

1. Click the **Menu** link in the **Application** toolbar.
A list appears.
2. From the **Main** menu, select **Accounting and Receivable** and then click **Account Receivable Central**.
The **Account Receivable Central** screen appears.

- Enter the search criteria in the **Search Bill** zone.

Note: ORMB search engine supports wildcard search, where you can substitute the percentage (%) symbol as a stand in for any word or letter in a search criteria. You can use the '%' wildcard character in all input fields except the date and ID fields. The '%' wildcard character is suffixed automatically at the end of the partial search criteria. Therefore, you may or may not specify the wildcard character at the end of the partial search criteria. However, you have to prefix the wildcard character manually wherever required.

Note: The wild card search for searching bill in the **Search Bill** zone is applicable when you select the **Bill Details** option from the **Search By** list.

- Click **Search**.

A list of bills that meet the search criteria appears in the **Search Results** section.

Related Topics

For more information on...	See...
Account Receivable Central screen	Account Receivable Central on page 1546
Search Bill zone	Search Bill on page 1546

Viewing the Bill Details

Procedure

To view the details of a bill:

- Search for the bill in the **Account Receivable Central** screen.
- In the **Search Results** section, click the **Show Context Menu** (▼) icon corresponding to the bill whose details you want to view.
A menu appears.
- Click the **Go To Bill Information** menu option.
The **Bill Information** screen appears.
- View the details of the bills in the **Bill Information** screen.

Related Topics

For more information on...	See...
Account Receivable Central screen	Account Receivable Central on page 1546
Bill Information screen	Bill Information on page 1550
How to search for a bill	Searching for a Bill on page 1551

Chapter 22

Offset Request

Topics:

- [Single Offset](#)
- [Mass Offset](#)
- [Cross Currency Offset](#)
- [Prerequisites](#)
- [Offset Request \(Without Approval\) Status Transition](#)
- [Offset Request \(With Approval\) Status Transition](#)
- [Algorithms Used in C1-OffsetRequest](#)
- [Additional Algorithms Used in Offset Request](#)
- [Offset Request Type](#)
- [Offset Request \(Used for Searching\)](#)
- [Offset Request \(Used for Viewing\)](#)

Oracle Revenue Management and Billing allows you to offset the credit and debit bills across accounts of the person and/or its hierarchy. However, you can offset bills across person's hierarchy when the **Allow Offsetting Across Persons** option type of the **C1-OFFSETREQ** feature configuration is set to **Y**.

You can offset a credit bill with a debit bill and vice-versa. You can offset one or more credit bills with one or more debit bills and vice-versa. You can offset the credit and debit bills in the same currency or in the different currencies. The system enables you to offset bills through an offset request. You can create an offset request from the following screens:

- [Account Receivable Central](#) on page 1546
- [Offset Request \(Used for Searching\)](#) on page 1590

You can create the following types of offset request from both the above screens:

- [Single Offset](#) on page 1555
- [Mass Offset](#) on page 1556
- [Cross Currency Offset](#) on page 1559

While creating an offset request, you need to specify an offset request type using which you want to create the offset request. It is the offset request type which helps the system to determine:

- The business object using which the offset request should be created in the system.
- The default adjustment type using which the transfer or offset adjustment should be created in the system.
- The algorithm which helps to calculate default offset amount when a bill is added to the offset request.
- Whether approval is required while offsetting bills through an offset request.
- Whether an offset request must be processed in the deferred mode or in real time (i.e. immediately)
- The maximum search period (in days) that you want to allow while searching bills in an offset request.
- Whether the transfer or offset adjustments should be created while offsetting bills through an offset request.

In addition, while creating an offset request, you need to specify a primary bill for which you want to create the offset request. A primary bill can be a debit

or credit bill. Once the primary bill is added to an offset request, you can never remove it from the offset request.

Once you specify an offset request type and primary bill, the offset request is created in the **Draft** status. You can then add one or more debit or credit bills in the same or different currencies to the offset request depending on whether you want to create single, mass, or cross currency offset request. These bills are called as secondary bills. You can remove a secondary bill from the offset request when it is in the **Draft** status.

Once both the debit and credit bills are added to an offset request, the default offset amount is calculated for each bill. You can then update the offset amount of a bill, if required. Once the offset amount is specified for each bill, you can submit the offset request. On submitting an offset request, the system checks whether the number of financial transactions created for the bills (which are selected in the offset request) exceeds the defer processing count (defined in the respective offset request type). If the number of financial transactions does not exceed the defer processing count, the system creates the transfer or offset adjustments in the **Frozen** status. However, if the number of financial transactions exceeds the defer processing count, the system changes the status of the offset request to **Deferred Processing**. On executing the **Offset Request Periodic Monitor (C1-OFSRQ)** batch, the system considers the offset requests which are in the **Deferred Processing** status. The batch then creates the transfer or offset adjustments for these offset requests in the **Frozen** status.

You can optionally configure the approval process for the offset request. The approver can either approve or reject an offset request based on the observations. The system also enables you to unapply (i.e. cancel) an offset request. On canceling an offset request, the transfer or offset adjustments created for bills through the offset request are canceled.

An offset request goes through various statuses in its lifecycle. For more information about the offset request statuses, see [Offset Request \(Without Approval\) Status Transition](#) on page 1562 and [Offset Request \(With Approval\) Status Transition](#) on page 1563. Note that the lifecycle of an offset request is driven by business object using which the offset request is created. An offset request business object named **C1-OffsetRequest** is shipped with the product. The offset request feature explained in this document is articulated based on the lifecycle and logic defined in the **C1-OffsetRequest** business object.

For more information on how to setup the offset request feature, see [Prerequisites](#) on page 1561.

Single Offset

Single offset means you can offset one credit bill against multiple debit bills and vice-versa in the same currency. For example, the following bills are created for Garry Smith:

Account	Bill	Due Date	Bill Segment	Contract Type Priority	Bill Segment Amount	Outstanding Bill Amount	Hold Amount
A1	Bill 1	06-18-2018	BS1	10	-\$100	-\$100	-\$20
	Bill 2	06-12-2018	BS2	10	\$30	\$30 (This is because \$20 is already paid.)	\$10
			BS3	20	\$20		
	Bill 3	06-22-2018	BS4	10	\$30	\$30	\$10
	Bill 4	06-28-2018	BS5	20	\$30	\$40	-
			BS6	30	\$10		

The system enables you to offset these bills through a single offset request. While creating a single offset request, you can add the Bill 1 as the primary bill against which you can offset the debit bills – Bill 2, Bill 3, and Bill 4. Note that you can only add completed bills to an offset request. The system then calculates the total credit and debit bill amount which is available for offsetting, as shown below:

Sum of credit bills' amount which is available for offsetting:

$$(-\$100 - (-\$20)) = (-\$100 + \$20) = -\$80$$

Sum of debit bills' amount which is available for offsetting:

$$((\$30 - \$10) + (\$30 - \$10) + (\$40)) = \$80$$

The system considers the credit or debit bills' total whichever is less as the default offset amount. You can change the offset amount of a bill, if required. However, you need to ensure the following:

- Offset amount of the selected bill is not equal to zero
- Total debit offset amount is equal to total credit offset amount in the offset request
- Negative offset amount is specified for the debit bill and positive offset amount is specified for the credit bill
- Offset amount is less than or equal to the current outstanding amount of the bill

Note: If you add or remove a bill from the offset request after updating the offset amount, the system overrides the offset amount with the default offset amount. In such scenarios, you have to update the offset amount of the bills once again.

On submitting or approving a single offset request, the system creates the transfer or offset adjustments using the adjustment type which is specified in the offset request. If the **Transfer Adjustment** option is selected in the respective offset request type, the system creates the transfer adjustments in the **Frozen** status. Considering the above example, the system will create the following transfer adjustments for the offset request:

Transfer	Transfer Adjustments
1	<ul style="list-style-type: none"> \$20 transfer adjustment is created for Bill 1 and matched to -\$100 bill segment cancellation (BS1) FT 1 -\$20 transfer adjustment is created for Bill 2 and matched to \$30 bill segment (BS2) FT 2
2	<ul style="list-style-type: none"> \$20 transfer adjustment is created for Bill 1 and matched to -\$100 bill segment cancellation (BS1) FT 1 -\$20 transfer adjustment is created for Bill 3 and matched to \$30 bill segment (BS4) FT 4
3	<ul style="list-style-type: none"> \$30 transfer adjustment is created for Bill 1 and matched to -\$100 bill segment cancellation (BS1) FT 1 -\$30 transfer adjustment is created for Bill 4 and matched to \$30 bill segment (BS5) FT 5
4	<ul style="list-style-type: none"> \$10 transfer adjustment is created for Bill 1 and matched to -\$100 bill segment cancellation (BS1) FT 1 -\$10 transfer adjustment is created for Bill 4 and matched to \$10 bill segment (BS6) FT 6

However, if the **Transfer Adjustment** option is not selected in the respective offset request type, the system creates the offset adjustments in the **Frozen** status. Considering the above example, the system will create the following offset adjustments for the offset request:

- \$80 offset adjustment is created for Bill 1 and matched to -\$100 Bill Segment Cancellation (BS1) FT 1
- \$20 offset adjustment is created for Bill 2 and matched to \$30 bill segment (BS2) FT 2
- \$20 offset adjustment is created for Bill 3 and matched to \$30 bill segment (BS4) FT 4
- \$30 offset adjustment is created for Bill 4 and matched to \$30 bill segment (BS5) FT 5
- \$10 offset adjustment is created for Bill 4 and matched to \$10 bill segment (BS6) FT 6

Similarly, the transfer or offset adjustments are created when the bills are offset across accounts of the person and its hierarchy. The system distributes the amount from the credit bill starting with the oldest due date. For more information on how the offset amount is distributed, see [CI-OFST-DIST](#) on page 1567.

You can create a single offset request through the **Account Receivables Central** and **Offset Request** screens. For more information on how to create a single offset request, see [Creating an Offset Request](#) on page 1594.

Mass Offset

Mass offset means you can offset one or more credit bills against one or more debit bills and vice-versa in the same currency. For example, the following bills are created for Juliet Hurd:

Account	Bill	Due Date	Bill Segment	Contract Type Priority	Bill Segment Amount	Outstanding Bill Amount	Hold Amount
A11	Bill 1	01-15-2019	BS1	10	-\$50	-\$100	-
			BS2	20	-\$50		

Account	Bill	Due Date	Bill Segment	Contract Type Priority	Bill Segment Amount	Outstanding Bill Amount	Hold Amount
	Bill 2	01-20-2019	BS3	10	-\$50	-\$50	-
	Bill 3	01-18-2019	BS4	10	\$30	\$50	-
			BS5	10	\$20		
A12	Bill 4	01-21-2019	BS6	10	\$30	\$30	-
	Bill 5	01-25-2019	BS7	20	\$30	\$40	-
			BS8	30	\$10		
A13	Bill 6	01-29-2019	BS9	10	\$20	\$20	-

The system enables you to offset these bills through a mass offset request. While creating a mass offset request, you can add the Bill 1 as the primary bill. Once the offset request is created, you can add another credit bill (i.e. Bill 2) and the debit bills – Bill 3, Bill 4, Bill 5, and Bill 6. Note that you can only add completed bills to an offset request. The system then calculates the total credit and debit bill amount which is available for offsetting, as shown below:

Sum of credit bills' amount which is available for offsetting:

$$(-\$100 + (-\$50)) = (-\$100 - \$50) = -\$150$$

Sum of debit bills' amount which is available for offsetting:

$$(\$50 + \$30 + \$40 + \$20) = \$140$$

The system considers the credit or debit bills' total whichever is less as the default offset amount. In this case, the default offset amount is set to \$140. You can change the offset amount of a bill, if required. However, you need to ensure the following:

- Offset amount of the selected bill is not equal to zero
- Total debit offset amount is equal to total credit offset amount in the offset request
- Negative offset amount is specified for the debit bill and positive offset amount is specified for the credit bill
- Offset amount is less than or equal to the current outstanding amount of the bill

Note: If you add or remove a bill from the offset request after updating the offset amount, the system overrides the offset amount with the default offset amount. In such scenarios, you have to update the offset amount of the bills once again.

On submitting or approving a mass offset request, the system creates the transfer or offset adjustments using the adjustment type which is specified in the offset request. If the **Transfer Adjustment** option is selected in the respective offset request type, the system creates the transfer adjustments in the **Frozen** status. Considering the above example, the system will create the following transfer adjustments for the offset request:

Transfer	Transfer Adjustments
1	<ul style="list-style-type: none"> • \$30 transfer adjustment is created for Bill 1 and matched to -\$50 bill segment cancellation (BS1) FT 1 • -\$30 transfer adjustment is created for Bill 3 and matched to \$30 bill segment (BS4) FT 4

Transfer	Transfer Adjustments
2	<ul style="list-style-type: none"> • \$20 transfer adjustment is created for Bill 1 and matched to -\$50 bill segment cancellation (BS1) FT 1 • -\$20 transfer adjustment is created for Bill 3 and matched to \$20 bill segment (BS5) FT 5
3	<ul style="list-style-type: none"> • \$30 transfer adjustment is created for Bill 1 and matched to -\$50 bill segment cancellation (BS2) FT 2 • -\$30 transfer adjustment is created for Bill 4 and matched to \$30 bill segment (BS6) FT 6
4	<ul style="list-style-type: none"> • \$20 transfer adjustment is created for Bill 1 and matched to -\$50 bill segment cancellation (BS2) FT 2 • -\$20 transfer adjustment is created for Bill 5 and matched to \$30 bill segment (BS7) FT 7
5	<ul style="list-style-type: none"> • \$10 transfer adjustment is created for Bill 2 and matched to -\$50 bill segment cancellation (BS3) FT 3 • -\$10 transfer adjustment is created for Bill 5 and matched to \$30 bill segment (BS7) FT 7
6	<ul style="list-style-type: none"> • \$10 transfer adjustment is created for Bill 2 and matched to -\$50 bill segment cancellation (BS3) FT 3 • -\$10 transfer adjustment is created for Bill 5 and matched to \$10 bill segment (BS8) FT 8
7	<ul style="list-style-type: none"> • \$20 transfer adjustment is created for Bill 2 and matched to -\$50 bill segment cancellation (BS3) FT 3 • -\$20 transfer adjustment is created for Bill 6 and matched to \$20 bill segment (BS9) FT 9

However, if the **Transfer Adjustment** option is not selected in the respective offset request type, the system creates the offset adjustments in the **Frozen** status. Considering the above example, the system will create the following offset adjustments for the offset request:

- \$50 offset adjustment is created for Bill 1 and matched to -\$50 Bill Segment Cancellation (BS1) FT 1
- \$50 offset adjustment is created for Bill 1 and matched to -\$50 Bill Segment Cancellation (BS2) FT 2
- \$40 offset adjustment is created for Bill 2 and matched to -\$50 Bill Segment Cancellation (BS3) FT 3
- -\$30 offset adjustment is created for Bill 3 and matched to \$30 bill segment (BS4) FT 4
- -\$20 offset adjustment is created for Bill 3 and matched to \$20 bill segment (BS5) FT 5
- -\$30 offset adjustment is created for Bill 4 and matched to \$30 bill segment (BS6) FT 6
- -\$30 offset adjustment is created for Bill 5 and matched to \$30 bill segment (BS7) FT 7
- -\$10 offset adjustment is created for Bill 5 and matched to \$10 bill segment (BS8) FT 8
- -\$20 offset adjustment is created for Bill 6 and matched to \$20 bill segment (BS9) FT 9

Similarly, the transfer or offset adjustments are created when the bills are offset across accounts of the person hierarchy. The system distributes the amount from the credit bill starting with the oldest due date. For more information on how the offset amount is distributed, see [CI-OFST-DIST](#) on page 1567.

You can create a mass offset request through the **Account Receivables Central** and **Offset Request** screens. For more information on how to create a mass offset request, see [Creating an Offset Request](#) on page 1594.

Cross Currency Offset

Cross currency offset means you can offset one credit bill against multiple debit bills and vice-versa in the different currencies. For example, the following bills are created for Mark Forbes:

Account	Bill	Due Date	Bill Segment	Contract Type Priority	Bill Segment Amount	Outstanding Bill Amount	Hold Amount
A1	Bill 1	09-18-2018	BS1	10	-\$250	-\$250	-
	Bill 2	09-12-2018	BS2	10	€10	€30	-
			BS3	20	€20		
	Bill 3	09-22-2018	BS4	10	€50	€50	-
	Bill 4	09-28-2018	BS5	20	€30	€70	-
			BS6	30	€40		

The system enables you to offset these bills through a cross currency offset request. While creating a cross currency offset request, you can add the Bill 1 as the primary bill against which you can offset the debit bills – Bill 2, Bill 3, and Bill 4. Note that you can only add completed bills to an offset request. In a cross currency offset request, you can offset the bills which are in the currency different from the primary bill. For example, if you have added a primary bill with credit balance in USD, you can only add the debit bills in the currency other than USD. The system then calculates the total credit and debit bill amount which is available for offsetting, as shown below:

Sum of credit bills' amount which is available for offsetting:

-\$250

Sum of credit bills' amount which is available for offsetting (in offset currency):

-€227

Sum of debit bills' amount which is available for offsetting:

(30€+50€+70€)=€150

Sum of debit bills' amount which is available for offsetting (in offset currency):

\$33+\$55+\$77=\$165

The system considers the credit or debit bills' total (in the primary bill's currency) whichever is less as the default offset amount. In this case, the default offset amount is set to \$165. You can change the offset amount of a bill, if required. However, you need to ensure the following:

- Offset amount of the selected bill is not equal to zero
- Total debit offset amount is equal to total credit offset amount in the offset request
- Negative offset amount is specified for the debit bill and positive offset amount is specified for the credit bill
- Offset amount is less than or equal to the current outstanding amount of the bill

Note: If you add or remove a bill from the offset request after updating the offset amount, the system overrides the offset amount with the default offset amount. In such scenarios, you have to update the offset amount of the bills once again.

On submitting or approving a cross currency offset request, the system creates the transfer or offset adjustments using the adjustment type which is specified in the offset request. If the **Transfer Adjustment** option is selected in the respective offset request type, the system creates the transfer adjustments in the **Frozen** status. Considering the above example, the system will create the following transfer adjustments for the offset request:

Transfer	Transfer Adjustments
1	<ul style="list-style-type: none"> \$11 transfer adjustment is created for Bill 1 and matched to -\$250 bill segment cancellation (BS1) FT 1 -€10 transfer adjustment is created for Bill 2 and matched to €10 bill segment (BS2) FT 2
2	<ul style="list-style-type: none"> \$22 transfer adjustment is created for Bill 1 and matched to -\$250 bill segment cancellation (BS1) FT 1 -€20 transfer adjustment is created for Bill 2 and matched to €20 bill segment (BS3) FT 3
3	<ul style="list-style-type: none"> \$55 transfer adjustment is created for Bill 1 and matched to -\$250 bill segment cancellation (BS1) FT 1 -€50 transfer adjustment is created for Bill 3 and matched to €50 bill segment (BS4) FT 4
4	<ul style="list-style-type: none"> \$33 transfer adjustment is created for Bill 1 and matched to -\$250 bill segment cancellation (BS1) FT 1 -€30 transfer adjustment is created for Bill 4 and matched to €30 bill segment (BS5) FT 5
5	<ul style="list-style-type: none"> \$44 transfer adjustment is created for Bill 1 and matched to -\$250 bill segment cancellation (BS1) FT 1 -€40 transfer adjustment is created for Bill 4 and matched to €40 bill segment (BS6) FT 6

However, if the **Transfer Adjustment** option is not selected in the respective offset request type, the system creates the offset adjustments in the **Frozen** status. Considering the above example, the system will create the following offset adjustments for the offset request:

- \$165 offset adjustment is created for Bill 1 and matched to -\$250 Bill Segment Cancellation (BS1) FT 1
- €10 offset adjustment is created for Bill 2 and matched to €10 bill segment (BS2) FT 2
- €20 offset adjustment is created for Bill 2 and matched to €20 bill segment (BS3) FT 3
- €50 offset adjustment is created for Bill 3 and matched to €50 bill segment (BS4) FT 4
- €30 offset adjustment is created for Bill 4 and matched to €30 bill segment (BS5) FT 5
- €40 offset adjustment is created for Bill 4 and matched to €40 bill segment (BS6) FT 6

Similarly, the transfer or offset adjustments are created when the bills are offset across accounts of the person and its hierarchy. The system distributes the amount from the credit bill starting with the oldest due date. For more information on how the offset amount is distributed, see [CI-OFST-DIST](#) on page 1567.

To use the cross currency offset request feature, you need to do the following:

- Define the required exchange rates in the system.
- Define a currency conversion algorithm for bill segments using the **C1_CURALGBS** or **C1_EXCRTBS** algorithm type and attach it to the **Currency Conversion For Bill Segments** algorithm spot of the required divisions.

- Define a currency conversion algorithm for adjustments using the **C1_CURALGAD** or **C1_EXCRTAD** algorithm type and attach it to the **Currency Conversion For Adjustments** algorithm spot of the required divisions.

You can create a cross currency offset request through the **Account Receivables Central** and **Offset Request** screens. For more information on how to create a cross currency offset request, see [Creating an Offset Request](#) on page 1594.

Prerequisites

To setup the offset request feature, you need to do the following:

- Define the required offset adjustment types where the **A/P Request Type Code** field is not set to **REFUND**.
- Define a default offset amount algorithm using the **C1-OFST-AMT** algorithm type.
- Assign the **C1-OFSRQ** To Do type to a To Do role whose users must receive a To Do while submitting an offset request for approval.
- Assign the **C1-OFSSB** To Do type to a To Do role whose users must not approve an offset request.
- Define the required offset request types in the system.
- Define the required characteristic types where the characteristic entity is set to **Offset Request Type**.
- Define the required characteristic types where the characteristic entity is set to **Offset Request**.
- Define the values for the **CAN_RSN_CD_FLG** lookup field.
- Set the parameters of the **C1-UPD-FUND**, **C1-DFRUNAPLY**, **C1-WTBS-CRBL**, and **C1-OFST-DIST** algorithms.
- Define the status reasons for the **Rejected** and **Unapplied Offset** statuses of the **C1-OffsetRequest** business object in the **Status Reason** screen.
- Set the **Allow Offsetting Across Persons** option type of the **C1-OFFSETREQ** feature configuration.
- Define the required exchange rates in the system.
- Define a currency conversion algorithm for bill segments using the **C1_CURALGBS** or **C1_EXCRTBS** algorithm type.
- Attach a currency conversion algorithm to the **Currency Conversion For Bill Segments** algorithm spot of the required divisions.
- Define a currency conversion algorithm for adjustments using the **C1_CURALGAD** or **C1_EXCRTAD** algorithm type.
- Attach a currency conversion algorithm to the **Currency Conversion For Adjustments** algorithm spot of the required divisions.
- Set the batch control type of the **Offset Request Periodic Monitor (C1-OFSRQ)** batch to **Timed** and define the following attributes:
 - Time Interval
 - Timer Active
 - User ID
 - Batch Language
 - Email Address

For more information about the **Offset Request Periodic Monitor (C1-OFSRQ)** batch, see *Oracle Revenue Management and Billing Batch Guide*.

Related Topics

For more information on...	See...
How to setup the C1-OFFSETREQ feature configuration	Setting the C1-OFFSETREQ Feature Configuration on page 3459
C1-OFST-AMT algorithm	C1-OFST-AMT on page 1569
C1-UPD-FUND algorithm	C1-UPD-FUND on page 1568
C1-DFRUNAPLY algorithm	C1-DFRUNAPLY on page 1568
C1-WTBS-CRBL algorithm	C1-WTBS-CRBL on page 1569
C1-OFST-DIST algorithm	C1-OFST-DIST on page 1567
C1_CURALGBS algorithm	C1_CURALGBS
C1_EXCRTBS algorithm	C1_EXCRTBS
C1_CURALGAD algorithm	C1_CURALGAD
C1_EXCRTAD algorithm	C1_EXCRTAD

Offset Request (Without Approval) Status Transition

The following figure graphically indicates how an offset request moves from one status to another when the approval process is not configured in the offset request type:

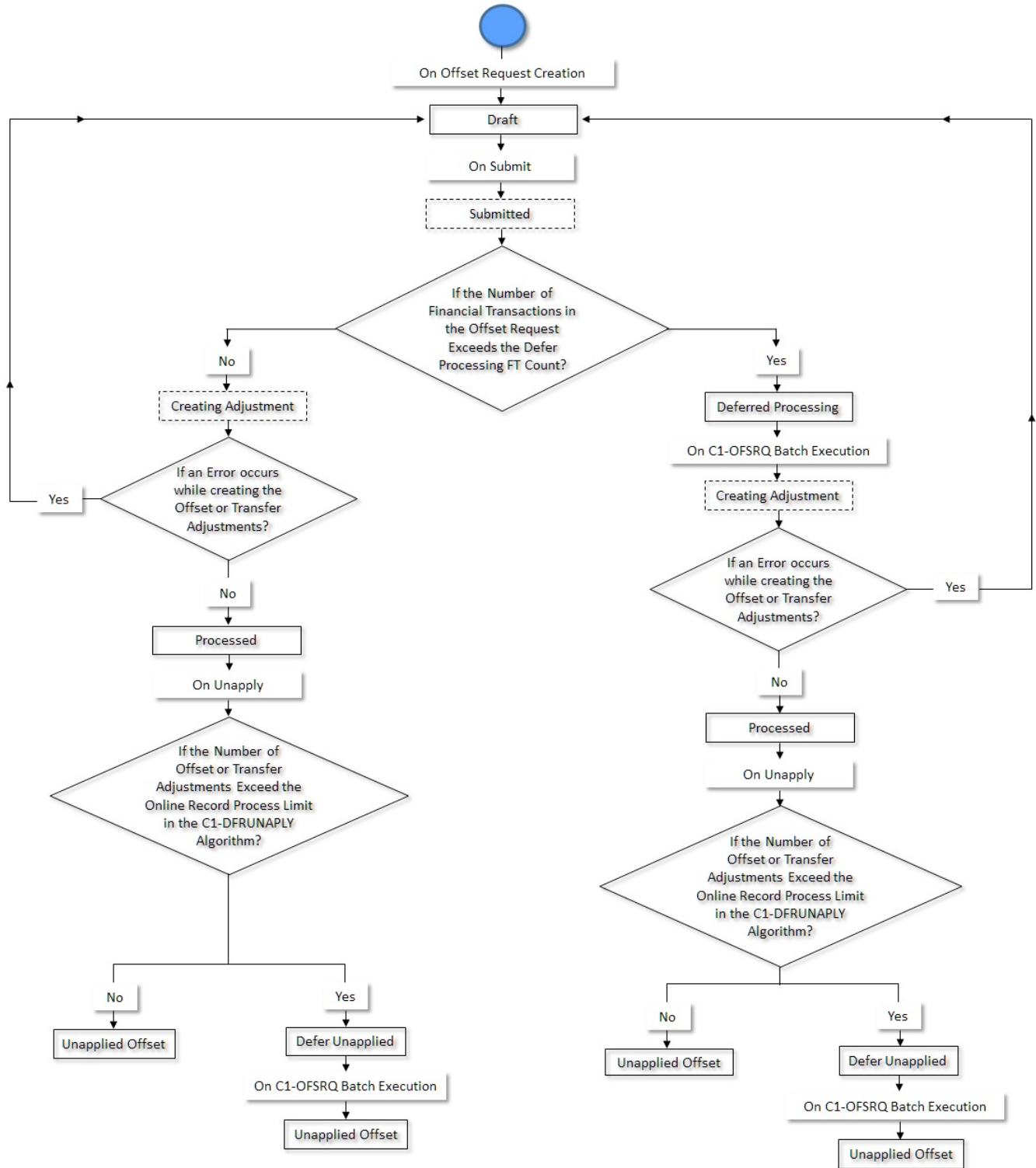

Offset Request (With Approval) Status Transition

The following figure graphically indicates how an offset request moves from one status to another when the approval process is configured in the offset request type:

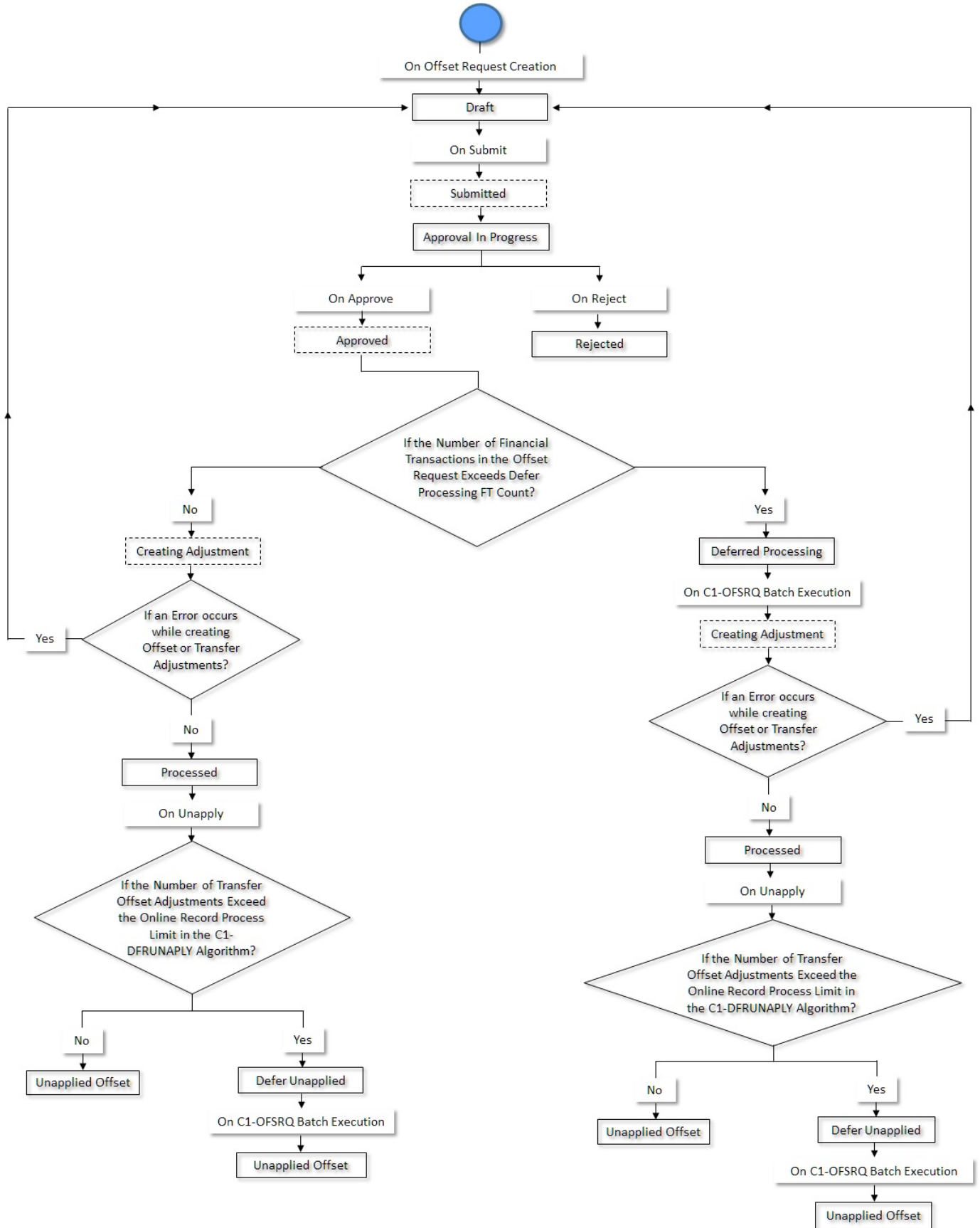

Algorithms Used in C1-OffsetRequest

The following table lists the algorithm which is attached to the **C1-OffsetRequest** business object:

System Event	Algorithm	Algorithm Type	Description
Information	C1-OFFST-INF	C1-OFFST-INF	Refer to C1-OFFST-INF on page 1566.

The following table lists the algorithms which are used in the lifecycle of the **C1-OffsetRequest** business object:

Status	System Event	Algorithm	Algorithm Type	Description
Draft	Exit	F1-TODOCOMPL	F1-TODOCOMPL	Refer to F1-TODOCOMPL on page 1566.
Submitted	Enter	C1-OFFSUBENT	C1-OFFSUBENT	Refer to C1-OFFSUBENT on page 1566.
Approval In Progress	Enter	C1-OFFAPPENT	C1-OFFAPPENT	Refer to C1-OFFAPPENT on page 1566.
	Exit	C1-OFFAPPEXT	C1-OFFAPPEXT	Refer to C1-OFFAPPEXT on page 1567.
	Exit	F1-TODOCOMPL	F1-TODOCOMPL	Refer to F1-TODOCOMPL on page 1566.
Approved	Enter	C1-OFSAPRENT	C1-OFSAPRENT	Refer to C1-OFSAPRENT on page 1567.
Rejected	-	-	-	-
Deferred Processing	Monitor	F1-AT-RQJ	F1-GEN-BOMNJ	Refer to F1-AT-RQJ on page 1567.
Creating Adjustment	Monitor	F1-AT-RQJ	F1-GEN-BOMNJ	Refer to F1-AT-RQJ on page 1567.
	Enter	C1-OFST-DIST	C1-OFST-DIST	Refer to C1-OFST-DIST on page 1567.
	Enter	C1-UPD-HOLD	C1-UPD-HOLD	Refer to C1-UPD-HOLD on page 1568.
	Enter	C1-UPD-FUND	C1-UPD-FUND	Refer to C1-UPD-FUND on page 1568.
Processed	-	-	-	-
Defer Unapplied	Monitor	F1-AT-RQJ	F1-GEN-BOMNJ	Refer to F1-AT-RQJ on page 1567.

Status	System Event	Algorithm	Algorithm Type	Description
	Enter	C1-DFRUNAPLY	C1-DFRUNAPLY	Refer to C1-DFRUNAPLY on page 1568.
Unapplied Offset	Enter	C1-UNAPOFST	C1-UNAPOFST	Refer to C1-UNAPOFST on page 1569.
	Enter	C1-UPDT-FUND	C1-UPDT-FUND	Refer to C1-UPDT-FUND on page 1569.

C1-OFFST-INF

This algorithm generates the offset request information string which appears throughout the application. It concatenates the following fields separated by a comma in the specified order:

1. Offset Request Type Description
2. Offset Request Status Description
3. Offset Request ID

F1-TODOCOMPL

This algorithm completes To Do entries that are created for the business object when the business object exits the given status. It finds and completes all open To Do entries where the business object's primary key is defined as a drill key. However, if the **Exclude To Do Entries From Auto Completion** characteristic is set to **Y** for the business object, the system does not automatically complete the respective To Do entry.

C1-OFFSUBENT

This algorithm is invoked when you click the **Submit** button. It validates the following:

- Whether the outstanding amount of the selected bills is not zero
- Whether the selected bills are in the **Complete** status
- Whether the overridden offset amount of a bill is not zero
- Whether the sum of the debit bills' offset amount is equal to the sum of the credit bills' offset amount
- Whether at least one debit and credit bills are selected in the offset request

If the validation is successful, it checks whether the **Approval Required** option is selected in the respective offset request type. If the **Approval Required** option is selected in the respective offset request type, it changes the status of the offset request to **Approval In Progress**. However, if the **Approval Required** option is not selected in the respective offset request type, it checks whether the number of financial transactions created for the bills, which are selected in the offset request, exceeds the defer processing count. If the number of financial transactions does not exceed the defer processing count, the system changes the status of the offset request to **Creating Adjustment**. However, if the number of financial transactions exceeds the defer processing count, the system changes the status of the offset request to **Deferred Processing**.

C1-OFFAPPENT

This algorithm is invoked when the status of the offset request is changed to **Approval In Progress**. It creates a To Do using the approval To Do type which is specified in the respective offset request type. Once a To Do is created, it is assigned to all users with the approval To Do role which is specified in the respective offset request type. In addition, it creates a log entry for the offset request when the To Do is created.

C1-OFFAPPEXT

This algorithm checks whether the approver is associated with the approval To Do role which is specified in the respective offset request type. If so, it allows the approver to approve or reject the offset request. It also ensures that the submitter does not approve or reject the offset request.

C1-OFSAPRENT

This algorithm is invoked when you click the **Approve** button. It checks whether the number of financial transactions created for the bills, which are selected in the offset request, exceeds the defer processing count. If the number of financial transactions does not exceed the defer processing count, the system changes the status of the offset request to **Creating Adjustment**. However, if the number of financial transactions exceeds the defer processing count, the system changes the status of the offset request to **Deferred Processing**.

F1-AT-RQJ

This algorithm transitions the current status of the business object to the specified status. It contains the following parameters:

- **Next Status** – Used when you want to override the default next status specified in the lifecycle.
- **Next Transition Condition** – Used when you want to override the default next transition condition specified in the lifecycle.

At a time, you can specify value for either the **Next Status** or **Next Transition Condition** parameter. If you don't specify any value for these parameters, the system will transition the business object to the default next status specified in its lifecycle.

C1-OFST-DIST

This algorithm is invoked when the status of the offset request is changed to **Creating Adjustment**. It creates offset adjustments using the adjustment type specified in the offset request and sets the status of the offset adjustments to **Frozen**. If the **Transfer Adjustment** option is selected in the respective offset request type, it creates transfer adjustments in the **Frozen** status.

This algorithm distributes the offset amount of a bill in the following manner:

1. **Internal Offsetting Within Each Bill** - This happens when a bill contains both debit and credit line items. The internal offsetting happens either at the bill segment or contract level depending on the value specified in the **Match Type Entity (Valid Values: BILL, BSEG, SA)** parameter. If the **Match Type Entity (Valid Values: BILL, BSEG, SA)** parameter is set to **BILL** or **SA**, the internal offsetting happens at the contract level. However, if the **Match Type Entity (Valid Values: BILL, BSEG, SA)** parameter is set to **BSEG**, the internal offsetting happens at the bill segment level. In the bill, the internal offsetting is done starting from a credit contract with highest payment priority against a debit contract with highest payment priority by creating transfer adjustments. This continues until the sum of credit or debit amount within a bill is exhausted.
2. **Offsetting Across Debit and Credit Bills** - This offsetting is always done from the credit bills to the debit bills with the objective to reduce the debit bill balance. This algorithm checks whether any match event is created for the bill. If so, it creates the offset adjustments against the bill using the existing match event. If there are no match events created for the bill, this algorithm creates match events using the value specified in the **Match Type Entity (Valid Values: BILL, BSEG, SA)** parameter. It distributes the amount from the credit bill starting with the oldest due date. This continues until the credit bill balance is exhausted.

It contains the following parameters:

- **Match Type** - Used to specify the match type using which you want to distribute the offset amount. You must specify a match type where the payment distribution override algorithm is attached.

Note: If a bill which is offset is partially paid using a match type, this algorithm uses the same match type for offset distribution. However, if no payment is received for a bill which is offset, this algorithm uses the match type which is specified in the **Match Type** parameter for offset distribution.

- **Match Type Entity (Valid Values: BILL, BSEG, SA)** - Used to indicate the entity, such as bill, bill segment, or contract, against which you want to create match event. It is used to create match events for bills which are unpaid. The valid values are:
 - **BILL** - Used when you want to stamp same match event on all financial transactions of the bill.
 - **BSEG** - Used when you want to stamp unique match event on each bill segment or adjustment financial transaction.
 - **SA** - Used when you want to stamp same match event on all financial transactions which are created for the same contract.
- **Credit Bill Distribution Algorithm** - Used to specify an algorithm which helps to create offset adjustments for a credit bill at the bill segment level. This parameter is required when the **Transfer Adjustment** option is not selected in the respective offset request type.

Note: The **C1-WTBS-CRBL** algorithm type is shipped with the product. You can attach an algorithm created using the **C1-WTBS-CRBL** algorithm type to the **Credit Bill Distribution Algorithm** parameter. For more information, see [C1-WTBS-CRBL](#) on page 1569.

C1-UPD-HOLD

This algorithm updates the hold request whenever a bill on hold is offset through an offset request. If the remaining outstanding amount of a bill after offsetting is not zero and is less than the current hold amount, this algorithm updates the hold amount to the current hold amount plus remaining outstanding bill balance. For example, if the original outstanding amount is 80\$, hold amount is 40\$, offset amount is 20\$, then the remaining outstanding amount (i.e. $80\$ - 40\$ - 20\$ = 20\$$) is less than the current hold amount (i.e. 40\$). Therefore, this algorithm updates the hold amount of the bill in the hold request to 60\$ (i.e. $40\$ + 20\$$).

However, if the remaining outstanding amount of a bill after offsetting is zero and the bill is included in any active hold request, the hold end date of the bill in the hold request is changed to the system date.

In both the above scenarios, this algorithm creates a log entry for the offset and hold requests. The bill whose hold details (i.e. either hold amount or hold end date) are updated through the offset request is maintained in its log. Similarly, the old and updated hold amount and hold end date of the bill are maintained in the respective hold request log.

C1-UPD-FUND

If a bill which is offset through an offset request is present in a funding request which is in the **Draft** status, this algorithm updates the funding amount of the bill in the funding request. If entire sum of the funding and garnishment amount of a bill is offset through the offset request, the bill is excluded from the funding request.

It contains the following parameter:

- **Funding Exclusion Reason Code** - Used to indicate the reason why you want to exclude the bill from the funding request. This parameter is mandatory while excluding a bill from a funding request. You must specify a value which is already defined in the **CAN_RSN_CD_FLG** lookup field.

C1-DFRUNAPLY

This algorithm is invoked when you click the **Unapply** button. It checks whether the number of transfer or offset adjustments created through the offset request exceeds the online record process limit defined in this algorithm. If the number of transfer or offset adjustments does not exceed the online record process limit, the system cancels the frozen transfer or offset adjustments immediately and then changes the status of the offset request to **Unapplied Offset**. However, if the number of transfer or offset adjustments exceeds the online record process limit, the system changes the status of the offset request to **Defer Unapplied**.

It contains the following parameter:

- **Online Record Process Limit** - Used to indicate the maximum number of transfer or offset adjustments you can process in the real time (i.e. immediately).

C1-UNAPOFST

This algorithm is invoked when the **Offset Request Periodic Monitor (C1-OFSRQ)** batch is executed. It cancels all transfer or offset adjustments created through the offset request and then changes the status of the offset request to **Unapplied Offset**.

C1-UPDT-FUND

Once the transfer or offset adjustments of a bill are canceled, it checks whether the bill is included in any funding request which is in the **Draft** status. If so, it updates the funding amount of the bill in the respective funding request.

C1-WTBS-CRBL

THIS ALGORITHM IS ONLY USED IF YOU PRACTICE OPEN-ITEM ACCOUNTING AND THE ACCOUNT'S CUSTOMER CLASS INDICATES OPEN-ITEM ACCOUNTING IS PRACTICED.

This algorithm is used to offset the bill segments of a credit bill. It considers the bill segments of a credit bill for offsetting based on the following parameter:

- **Bill Segment Date Type** – Used to indicate whether the system should consider the bill segments of a credit bill based on the freeze date or coverage start date. The valid values are:
 - **F** – Used when you want to consider the bill segments of a credit bill based on the order of the freeze date.
 - **C** – Used when you want to consider the bill segments of a credit bill based on the order of the coverage start date. Note that you can use this option when the coverage start date is stamped corresponding to the financial transactions in the **C1_FT_EXT** table.

It creates a unique match event for each bill segment and adjustment financial transaction.

Additional Algorithms Used in Offset Request

Besides using the algorithms attached to the lifecycle, the system uses the following algorithms for the **Offset Request** feature:

- [C1-OFST-AMT](#) on page 1569
- [C1-WTBS-CRBL](#) on page 1569

C1-OFST-AMT

This algorithm calculates the default offset amount whenever a bill is added to the offset request. The default offset amount is equal to the sum of outstanding amount of the debit or credit bills whichever is less. For example, if the following bills are added to the offset request:

- Bill 1 (-100\$) where due date is set to 01-01-2018
- Bill 2 (-100\$) where due date is set to 01-01-2019
- Bill 3 (25\$) where due date is set to 01-01-2018
- Bill 4 (25\$) where due date is set to 06-01-2018

In such case, the system sets the default offset amount of Bill 1 to 50\$.

Note: This algorithm does not calculate the default offset amount until both the debit and credit bills are added to the offset request.

C1-WTBS-CRBL

THIS ALGORITHM IS ONLY USED IF YOU PRACTICE OPEN-ITEM ACCOUNTING AND THE ACCOUNT'S CUSTOMER CLASS INDICATES OPEN-ITEM ACCOUNTING IS PRACTICED.

This algorithm is used to offset the bill segments of a credit bill. It considers the bill segments of a credit bill for offsetting based on the following parameter:

- **Bill Segment Date Type** – Used to indicate whether the system should consider the bill segments of a credit bill based on the freeze date or coverage start date. The valid values are:
 - **F** – Used when you want to consider the bill segments of a credit bill based on the order of the freeze date.
 - **C** – Used when you want to consider the bill segments of a credit bill based on the order of the coverage start date. Note that you can use this option when the coverage start date is stamped corresponding to the financial transactions in the **C1_FT_EXT** table.

It creates a unique match event for each bill segment and adjustment financial transaction.

Offset Request Type

Oracle Revenue Management and Billing allows you to define an offset request type using which you can create an offset request. It is the offset request type which helps the system to determine the following:

- The business object using which the offset request should be created in the system.
- The default adjustment type using which the transfer or offset adjustments should be created in the system.
- The algorithm which helps to calculate default offset amount when a bill is added to the offset request.
- Whether approval is required while offsetting bills through an offset request.
- Whether an offset request must be processed in the deferred mode or in real time (i.e. immediately)
- The maximum search period (in days) that you want to allow while searching bills in an offset request.
- Whether transfer or offset adjustments should be created while offsetting bills through an offset request.

The **Offset Request Type** screen allows you to define, edit, delete, and copy an offset request type. It contains the following zones:

- [Offset Request Type List](#) on page 1570
- [Offset Request Type](#) on page 1571

Offset Request Type List

The **Offset Request Type List** zone lists the offset request types that are already defined in the system. It contains the following columns:

Column Name	Column Description
Offset Request Type	Displays the offset request type.
Description	Displays the description of the offset request type.
Edit	On clicking the Edit (✎) icon, the Offset Request Type screen appears where you can edit the details of the offset request type.
Duplicate	On clicking the Duplicate (📄) icon, the Offset Request Type screen appears where you can define a new offset request type using an existing offset request type.

Column Name	Column Description
Delete	On clicking the Delete (🗑️) icon, you can delete the offset request type.
	Note: You can delete an offset request type when an offset request is not created using the offset request type.

On clicking the **Broadcast** (📡) icon corresponding to an offset request type, the **Offset Request Type** zone appears with the details of the respective offset request type.

Related Topics

For more information on...	See...
How to edit an offset request type	Editing an Offset Request Type on page 1579
How to copy an offset request type	Copying an Offset Request Type on page 1585
How to delete an offset request type	Deleting an Offset Request Type on page 1584
How to view the details of an offset request type	Viewing the Offset Request Type Details on page 1589

Offset Request Type

The **Offset Request Type** zone displays the details of the offset request type. It contains the following sections:

- **Main** - Displays basic information about the offset request type. It contains the following fields:

Field Name	Field Description
Offset Request Type	Displays the offset request type.
Description	Displays the description of the offset request type.
Offset Request Business Object	Indicates the business object using which an offset request should be created. In addition, a context menu appears corresponding to this field which helps in navigating to other screens in the application. Note: It has a link. On clicking the link, the Business Object screen appears where you can view the details of the respective business object.
Detailed Description	Displays additional information about the offset request type.
Status	Indicates the status of the offset request type. The valid values are: <ul style="list-style-type: none"> • Active • Inactive
Adjustment Type	Indicates the adjustment type using which the transfer or offset adjustments should be created. Note: It has a link. On clicking the link, the Adjustment Type screen appears where you can view the details of the respective adjustment type.
Default Offset Amount Algorithm	Indicates the algorithm using which the default offset amount should be calculated while adding a bill in an offset request. Note: It has a link. On clicking the link, the Algorithm screen appears where you can view the details of the respective algorithm.

Field Name	Field Description
Defer Processing Count	Displays the count which helps to determine whether an offset request must be processed in the deferred mode (i.e. in the background) or in real time (i.e. immediately).
Approval Required	Indicates whether approval is required while offsetting bills through an offset request.
Approval To Do Type	Indicates that the To Do entry of the specified To Do type must be created when an offset request is submitted for approval. Note: It has a link. On clicking the link, the To Do Type screen appears where you can view the details of the respective To Do Type. This field appears when the Approval Required option is selected.
Approval To Do Role	Indicates that users with the specified To Do role can only approve an offset request which is submitted for approval. Note: It has a link. On clicking the link, the To Do Role screen appears where you can view the details of the respective To Do Role. This field appears when the Approval Required option is selected.
Submitter To Do Type	Indicates the submitter To Do type. At present, the submitter To Do type is not used to create To Do entry when the approver rejects an offset request. It is only used to fetch the roles associated with the submitter To Do type while defining or editing the offset request type. Note: It has a link. On clicking the link, the To Do Type screen appears where you can view the details of the respective To Do type.
Submitter To Do Role	Indicates that users with the specified To Do role cannot approve an offset request which is submitted for approval. Note: It has a link. On clicking the link, the To Do Role screen appears where you can view the details of the respective To Do role.
Bill Search Period	Displays the maximum search period (in days) which is allowed while searching bills in an offset request.
Transfer Adjustment	Indicates whether transfer adjustments should be created while offsetting bills through an offset request.

- **Characteristics** - Lists the characteristics defined for the offset request type. It contains the following columns:

Column Name	Column Description
Characteristic Type	Indicates the characteristic type.
Characteristic Value	Displays the value of the characteristic type.

- **Record Actions** - This section contains the following buttons:

Button Name	Button Description
Edit	Used to edit the details of the offset request type.
Delete	Used to delete the offset request type. Note: You can delete an offset request type when an offset request is not created using the offset request type.
Duplicate	Used to create a new offset request type using an existing offset request type.

- **Record Information** - This section contains the following field:

Field Name	Field Description
Business Object	Indicates the business object using which the offset request type is created. In addition, a context menu appears corresponding to this field which helps in navigating to other screens in the application. Note: It has a link. On clicking the link, the Business Object screen appears where you can view the details of the respective business object.

By default, the **Offset Request Type** zone does not appear in the **Offset Request Type** screen. It appears when you click the **Broadcast** (📡) icon corresponding to an offset request type in the **Offset Request Type List** zone.

Related Topics

For more information on...	See...
How to edit an offset request type	Editing an Offset Request Type on page 1579
How to copy an offset request type	Copying an Offset Request Type on page 1585
How to delete an offset request type	Deleting an Offset Request Type on page 1584
How to view the details of an offset request type	Viewing the Offset Request Type Details on page 1589

Defining an Offset Request Type

Prerequisites

To define an offset request type, you should have:

- Offset request type business objects defined in the application
- Offset request business objects defined in the application
- Adjustment types defined in the application (where the **A/P Request Type Code** field is not set to **REFUND**)
- Default offset amount algorithm defined using the **C1-OFST-AMT** algorithm type
- Required To Do role assigned to the **C1-OFSRQ** and **C1-OFSSB** To Do types in the application
- Required match type entity specified in the **Match Type Entity (Valid Values: BILL, BSEG, SA)** parameter of the **C1-OFST-DIST** algorithm

Procedure

To define an offset request type:

1. Click the **Admin** link in the **Application** toolbar.

A list appears.

- From the **Admin** menu, select **O** and then click **Offset Request Type**.

A sub-menu appears.

- Click the **Add** option from the **Offset Request Type** sub-menu.

The **Select Business Object** screen appears. It contains the following field:

Field Name	Field Description	Mandatory (Yes or No)
Offset Request Type Business Object	Used to indicate the business object using which you want to create the offset request type.	Yes

Tip: Alternatively, you can access the **Select Business Object** screen by clicking the **Add** button in the **Page Title** area of the **Offset Request Type** screen.

Note: The **Select Business Object** screen appears when there are multiple offset request type business objects defined in the application. If there is only one offset request type business object defined in the application, the **Offset Request Type** screen appears.

- Select the required offset request type business object from the respective field.
- Click **OK**.

The **Offset Request Type** screen appears. It contains the following sections:

- Main** - Used to specify basic details about the offset request type.
- Characteristics** - Used to define the characteristics for the offset request type.

The **Main** section contains the following fields:

Field Name	Field Description	Mandatory (Yes or No)
Offset Request Type	Used to specify the offset request type.	Yes
Business Object	Indicates the business object using which you are defining the offset request type.	Not applicable
Description	Used to specify the description for the offset request type.	Yes
Offset Request Business Object	Used to indicate the business object using which you want to create the respective offset request.	Yes
Detailed Description	Used to specify additional information about the offset request type.	No
Status	Used to indicate the status of the offset request type. The valid values are: <ul style="list-style-type: none"> Active Inactive 	Yes
	Note: You cannot change the status of an offset request type to Inactive when the corresponding offset request is in a status other than Processed , Rejected , or Unapplied Offset .	

Field Name	Field Description	Mandatory (Yes or No)
Adjustment Type	<p>Used to indicate the adjustment type using which transfer or offset adjustments should be created. By default, the specified adjustment type appears when you create an offset request. You can then change the adjustment type, if required, while editing an offset request.</p> <p>Note:</p> <p>The Search (🔍) icon appears corresponding to the Adjustment Type field. On clicking the Search icon, the Adjustment Type Search window appears.</p> <p>On specifying the adjustment type, the description of the adjustment type appears corresponding to the Adjustment Type field.</p> <p>You can only specify an adjustment type where the A/P Request Type Code field is not set to REFUND.</p>	Yes
Default Offset Amount Algorithm	<p>Used to attach an algorithm using which you want to calculate default offset amount while adding a bill in an offset request.</p> <p>Note:</p> <p>The Search (🔍) icon appears corresponding to the Default Offset Amount Algorithm field. On clicking the Search icon, the Algorithm Search window appears.</p> <p>On specifying the algorithm, the description of the algorithm appears corresponding to the Default Offset Amount Algorithm field.</p> <p>You must specify an algorithm which is created using the C1-OFST-AMT algorithm type in the Default Offset Amount Algorithm field.</p>	Yes

Field Name	Field Description	Mandatory (Yes or No)
Defer Processing FT Count	<p>Used to indicate whether an offset request must be processed in the deferred mode or in real time (i.e. immediately). If the number of financial transactions created for the bills which are selected in the offset request exceeds the defer processing count, the system will process the offset request in the deferred mode. However, if the number of financial transactions created for the bills which are selected in the offset request does not exceed the defer processing count, the system will process the offset request in real time (i.e. immediately).</p> <p>Note: You cannot specify a negative value in this field.</p> <p>Deferred mode means in the background when the Offset Request Periodic Monitor (C1-OFSRQ) batch is invoked. You can configure the Offset Request Periodic Monitor (C1-OFSRQ) batch such that it is executed at regular intervals. For more information about the Offset Request Periodic Monitor (C1-OFSRQ) batch, refer to <i>Oracle Revenue Management and Billing Batch Guide</i>.</p> <p>If you set the defer processing count to zero (0), the system resets the default value to 50.</p>	No
Approval Required	Used to indicate whether approval is required while offsetting bills through an offset request.	No
Approval To Do Type	<p>Used to indicate that To Do entry of the specified To Do type must be created when you submit an offset request for approval.</p> <p>Note: The Search (🔍) icon appears corresponding to the Approval To Do Type field. On clicking the Search icon, the To Do Type Search window appears.</p> <p>On specifying the To Do type, the description of the To Do type appears corresponding to the Approval To Do Type field.</p> <p>This field appears when the Approval Required option is selected.</p> <p>The C1-OFSRQ To Do type is shipped with the product. You can use the C1-OFSRQ To Do type or a custom To Do type, if required.</p>	<p>Yes (Conditional)</p> <p>Note: This field is required when the Approval Required option is selected.</p>

Field Name	Field Description	Mandatory (Yes or No)
Approval To Do Role	Used to indicate that users with the specified To Do role can only approve an offset request submitted for approval.	Yes (Conditional)
	<p>Note:</p> <p>The list includes only those To Do roles which are associated with the approval To Do type.</p> <p>This field appears when the Approval Required option is selected.</p>	<p>Note: This field is required when the Approval Required option is selected.</p>
Submitter To Do Type	At present, the submitter To Do type is not used to create To Do entry when the approver rejects an offset request. It is only used to fetch the roles associated with the submitter To Do type.	Yes (Conditional)
	<p>Note:</p> <p>The Search (🔍) icon appears corresponding to the Submitter To Do Type field. On clicking the Search icon, the To Do Type Search window appears.</p> <p>On specifying the To Do type, the description of the To Do type appears corresponding to the Submitter To Do Type field.</p> <p>The C1-OFSSB To Do type is shipped with the product. You can use the C1-OFSSB To Do type or a custom To Do type, if required.</p>	<p>Note: This field is required when the Approval Required option is selected.</p>
Submitter To Do Role	Used to indicate that users with the specified To Do role cannot approve an offset request submitted for approval.	Yes (Conditional)
	<p>Note: The list includes only those To Do roles which are associated with the submitter To Do type.</p>	<p>Note: This field is required when the Approval Required option is selected.</p>
Bill Search Period	Used to specify the maximum search period (in days) that you want to allow while searching bills in an offset request.	No
	<p>Note: If you do not specify any value, by default, it is set to 30.</p>	

Field Name	Field Description	Mandatory (Yes or No)
Transfer Adjustment	Used to indicate whether transfer adjustments should be created while offsetting bills through an offset request. Note: By default, the Transfer Adjustment option is selected. This impacts the system performance when the match type entity is set to BSEG and volume of bill segments in the selected bills is high. Alternatively, the system enables you to create offset adjustments while offsetting bills through an offset request whenever the volume of bill segments in the selected bills is high. To create the offset adjustments while offsetting bills through an offset request, you need to ensure that the Transfer Adjustment option is not selected in the respective offset request type.	No

6. Enter the required details in the **Main** section.
7. Define characteristics for the offset request type, if required.
8. Click **Save**.

The offset request type is defined.

Related Topics

For more information on...	See...
Offset Request Type screen	Offset Request Type on page 1570
How to define a characteristic for an offset request type	Defining a Characteristic for an Offset Request Type on page 1578
C1-OFST-AMT algorithm	C1-OFST-AMT on page 1569

Defining a Characteristic for an Offset Request Type

Prerequisites

To define a characteristic for an offset request type, you should have:

- Characteristic types defined in the application (where the characteristic entity is set to **Offset Request Type**).

Procedure

To define a characteristic for an offset request type:

1. Ensure that the **Characteristics** section is expanded when you are defining, editing, or copying an offset request type.

The **Characteristics** section contains the following fields in a grid:

Field Name	Field Description	Mandatory (Yes or No)
Characteristic Type	Used to indicate the characteristic type.	Yes (Conditional)
	Note: The list includes only those characteristic types where the characteristic entity is set to Offset Request Type .	Note: This field is required when you are defining a characteristic for the offset request type.
Characteristic Value	Used to specify the value for the characteristic type.	Yes (Conditional)
	<p>Note:</p> <p>If you select a predefined characteristic type, the Search (🔍) icon appears corresponding to the Characteristic Value field. On clicking the Search icon, the Predefined Characteristic Search window appears.</p> <p>On specifying the value for a predefined characteristic type, the description of the characteristic value appears corresponding to the Characteristic Value field.</p>	Note: This field is required when you are defining a characteristic for the offset request type.

2. Enter the required details in the **Characteristics** section.
3. If you want to define more than one characteristic for the offset request type, click the **Add** (+) icon and then repeat step 2.

Note: However, if you want to remove a characteristic from the offset request type, click the **Delete** (🗑️) icon corresponding to the characteristic.

Related Topics

For more information on...	See...
How to define an offset request type	Defining an Offset Request Type on page 1573
How to edit an offset request type	Editing an Offset Request Type on page 1579
How to copy an offset request type	Copying an Offset Request Type on page 1585

Editing an Offset Request Type

Prerequisites

To edit an offset request type, you should have:

- Offset request business objects defined in the application
- Adjustment types defined in the application (where the **A/P Request Type Code** field is not set to **REFUND**)
- Default offset amount algorithm defined using the **C1-OFST-AMT** algorithm type
- Required To Do role assigned to the **C1-OFSRQ** and **C1-OFSSB** To Do types in the application
- Required match type entity specified in the **Match Type Entity (Valid Values: BILL, BSEG, SA)** parameter of the **C1-OFST-DIST** algorithm

Procedure

To edit an offset request type:

1. Click the **Admin** link in the **Application** toolbar.
A list appears.
2. From the **Admin** menu, select **O** and then click **Offset Request Type**.
A sub-menu appears.
3. Click the **Search** option from the **Offset Request Type** sub-menu.
The **Offset Request Type** screen appears.
4. In the **Offset Request Type List** zone, click the **Edit**  icon in the **Edit** column corresponding to the offset request type whose details you want to edit.
The **Offset Request Type** screen appears. It contains the following sections:
 - **Main** - Used to specify basic details about the offset request type.
 - **Characteristics** - Used to define the characteristics for the offset request type.

The **Main** section contains the following fields:

Field Name	Field Description	Mandatory (Yes or No)
Offset Request Type	Displays the offset request type.	Not applicable
Business Object	Indicates the business object which is used while defining the offset request type.	Not applicable
Description	Used to specify the description for the offset request type.	Yes
Offset Request Business Object	Used to indicate the business object using which you want to create the respective offset request.	Yes
Detailed Description	Used to specify additional information about the offset request type.	No
Status	Used to indicate the status of the offset request type. The valid values are: <ul style="list-style-type: none"> • Active • Inactive 	Yes
	Note: You cannot change the status of an offset request type to Inactive when the corresponding offset request is in a status other than Processed, Rejected, or Unapplied Offset .	

Field Name	Field Description	Mandatory (Yes or No)
Adjustment Type	<p>Used to indicate the adjustment type using which transfer or offset adjustments should be created. By default, the specified adjustment type appears when you create an offset request. You can then change the adjustment type, if required, while editing an offset request.</p> <p>Note:</p> <p>The Search (🔍) icon appears corresponding to the Adjustment Type field. On clicking the Search icon, the Adjustment Type Search window appears.</p> <p>On specifying the adjustment type, the description of the adjustment type appears corresponding to the Adjustment Type field.</p> <p>You can only specify an adjustment type where the A/P Request Type Code field is not set to REFUND.</p>	Yes
Default Offset Amount Algorithm	<p>Used to attach an algorithm using which you want to calculate default offset amount while adding a bill in an offset request.</p> <p>Note:</p> <p>The Search (🔍) icon appears corresponding to the Default Offset Amount Algorithm field. On clicking the Search icon, the Algorithm Search window appears.</p> <p>On specifying the algorithm, the description of the algorithm appears corresponding to the Default Offset Amount Algorithm field.</p> <p>You must specify an algorithm which is created using the C1-OFST-AMT algorithm type in the Default Offset Amount Algorithm field.</p>	Yes

Field Name	Field Description	Mandatory (Yes or No)
Defer Processing FT Count	<p>Used to indicate whether an offset request must be processed in the deferred mode or in real time (i.e. immediately). If the number of financial transactions created for the bills which are selected in the offset request exceeds the defer processing count, the system will process the offset request in the deferred mode. However, if the number of financial transactions created for the bills which are selected in the offset request does not exceed the defer processing count, the system will process the offset request in real time (i.e. immediately).</p> <p>Note: You cannot specify a negative value in this field.</p> <p>Deferred mode means in the background when the Offset Request Periodic Monitor (C1-OFSRQ) batch is invoked. You can configure the Offset Request Periodic Monitor (C1-OFSRQ) batch such that it is executed at regular intervals. For more information about the Offset Request Periodic Monitor (C1-OFSRQ) batch, refer to <i>Oracle Revenue Management and Billing Batch Guide</i>.</p> <p>If you set the defer processing count to zero (0), the system resets the default value to 50.</p>	No
Approval Required	Used to indicate whether approval is required while offsetting bills through an offset request.	No
Approval To Do Type	<p>Used to indicate that To Do entry of the specified To Do type must be created when you submit an offset request for approval.</p> <p>Note: The Search (🔍) icon appears corresponding to the Approval To Do Type field. On clicking the Search icon, the To Do Type Search window appears.</p> <p>On specifying the To Do type, the description of the To Do type appears corresponding to the Approval To Do Type field.</p> <p>This field appears when the Approval Required option is selected.</p> <p>The C1-OFSRQ To Do type is shipped with the product. You can use the C1-OFSRQ To Do type or a custom To Do type, if required.</p>	<p>Yes (Conditional)</p> <p>Note: This field is required when the Approval Required option is selected.</p>

Field Name	Field Description	Mandatory (Yes or No)
Approval To Do Role	Used to indicate that users with the specified To Do role can only approve an offset request submitted for approval.	Yes (Conditional)
	<p>Note:</p> <p>The list includes only those To Do roles which are associated with the approval To Do type.</p> <p>This field appears when the Approval Required option is selected.</p>	<p>Note: This field is required when the Approval Required option is selected.</p>
Submitter To Do Type	At present, the submitter To Do type is not used to create To Do entry when the approver rejects an offset request. It is only used to fetch the roles associated with the submitter To Do type.	Yes (Conditional)
	<p>Note:</p> <p>The Search (🔍) icon appears corresponding to the Submitter To Do Type field. On clicking the Search icon, the To Do Type Search window appears.</p> <p>On specifying the To Do type, the description of the To Do type appears corresponding to the Submitter To Do Type field.</p> <p>The C1-OFSSB To Do type is shipped with the product. You can use the C1-OFSSB To Do type or a custom To Do type, if required.</p>	<p>Note: This field is required when the Approval Required option is selected.</p>
Submitter To Do Role	Used to indicate that users with the specified To Do role cannot approve an offset request submitted for approval.	Yes (Conditional)
	<p>Note: The list includes only those To Do roles which are associated with the submitter To Do type.</p>	<p>Note: This field is required when the Approval Required option is selected.</p>
Bill Search Period	Used to specify the maximum search period (in days) that you want to allow while searching bills in an offset request.	No
	<p>Note: If you do not specify any value, by default, it is set to 30.</p>	

Field Name	Field Description	Mandatory (Yes or No)
Transfer Adjustment	Used to indicate whether transfer adjustments should be created while offsetting bills through an offset request.	No
	Note: This impacts the system performance when the match type entity is set to BSEG and volume of bill segments in the selected bills is high. Alternatively, the system enables you to create offset adjustments while offsetting bills through an offset request whenever the volume of bill segments in the selected bills is high. To create the offset adjustments while offsetting bills through an offset request, you need to ensure that the Transfer Adjustment option is not selected in the respective offset request type.	

Tip: Alternatively, you can access this screen by clicking the **Edit** button in the **Offset Request Type** zone.

5. Modify the required details in the **Main** section.
6. Define, edit, or remove characteristics of the offset request type, if required.
7. Click **Save**.

The changes made to the offset request type are saved.

Related Topics

For more information on...	See...
Offset Request Type screen	Offset Request Type on page 1570
Offset Request Type List zone	Offset Request Type List on page 1570
Offset Request Type zone	Offset Request Type on page 1571
How to define a characteristic for an offset request type	Defining a Characteristic for an Offset Request Type on page 1578
C1-OFST-AMT algorithm	C1-OFST-AMT on page 1569

Deleting an Offset Request Type

Procedure

To delete an offset request type:

1. Click the **Admin** link in the **Application** toolbar.
A list appears.
2. From the **Admin** menu, select **O** and then click **Offset Request Type**.
A sub-menu appears.
3. Click the **Search** option from the **Offset Request Type** sub-menu.
The **Offset Request Type** screen appears.
4. In the **Offset Request Type List** zone, click the **Delete** () icon in the **Delete** column corresponding to the offset request type that you want to delete.
A message appears confirming whether you want to delete the offset request type.

Note: You can delete an offset request type when an offset request is not created using the offset request type.

Tip: Alternatively, you can delete an offset request type by clicking the **Delete** button in the **Offset Request Type** zone.

5. Click **OK**.

The offset request type is deleted.

Related Topics

For more information on...	See...
Offset Request Type screen	<i>Offset Request Type</i> on page 1570
Offset Request Type List zone	<i>Offset Request Type List</i> on page 1570
Offset Request Type zone	<i>Offset Request Type</i> on page 1571

Copying an Offset Request Type

Instead of creating an offset request type from scratch, you can create a new offset request type using an existing offset request type. This is possible through copying an offset request type. On copying an offset request type, the details including the characteristics are copied to the new offset request type. You can then edit the details, if required.

Prerequisites

To copy an offset request type, you should have:

- Offset request type (whose copy you want to create) defined in the application
- Offset request business objects defined in the application
- Adjustment types defined in the application (where the **A/P Request Type Code** field is not set to **REFUND**)
- Default offset amount algorithm defined using the **C1-OFST-AMT** algorithm type
- Required To Do role assigned to the **C1-OFSRQ** and **C1-OFSSB** To Do types in the application
- Required match type entity specified in the **Match Type Entity (Valid Values: BILL, BSEG, SA)** parameter of the **C1-OFST-DIST** algorithm

Procedure

To copy an offset request type:

1. Click the **Admin** link in the **Application** toolbar.
A list appears.
2. From the **Admin** menu, select **O** and then click **Offset Request Type**.
A sub-menu appears.
3. Click the **Search** option from the **Offset Request Type** sub-menu.
The **Offset Request Type** screen appears.
4. In the **Offset Request Type List** zone, click the **Duplicate** () icon in the **Duplicate** column corresponding to the offset request type whose copy you want to create.

The **Offset Request Type** screen appears. It contains the following sections:

- **Main** - Used to specify basic details about the offset request type.
- **Characteristics** - Used to define the characteristics for the offset request type.

The **Main** section contains the following fields:

Field Name	Field Description	Mandatory (Yes or No)
Offset Request Type	Used to specify the offset request type.	Yes
Business Object	Indicates the business object which is used while defining the offset request type.	Not applicable
Description	Used to specify the description for the offset request type.	Yes
Offset Request Business Object	Used to indicate the business object using which you want to create the respective offset request.	Yes
Detailed Description	Used to specify additional information about the offset request type.	No
Status	<p>Used to indicate the status of the offset request type. The valid values are:</p> <ul style="list-style-type: none"> • Active • Inactive <p>Note: You cannot change the status of an offset request type to Inactive when the corresponding offset request is in a status other than Processed, Rejected, or Unapplied Offset.</p>	Yes
Adjustment Type	<p>Used to indicate the adjustment type using which transfer or offset adjustments should be created. By default, the specified adjustment type appears when you create an offset request. You can then change the adjustment type, if required, while editing an offset request.</p> <p>Note:</p> <p>The Search (🔍) icon appears corresponding to the Adjustment Type field. On clicking the Search icon, the Adjustment Type Search window appears.</p> <p>On specifying the adjustment type, the description of the adjustment type appears corresponding to the Adjustment Type field.</p> <p>You can only specify an adjustment type where the A/P Request Type Code field is not set to REFUND.</p>	Yes

Field Name	Field Description	Mandatory (Yes or No)
Default Offset Amount Algorithm	<p>Used to attach an algorithm using which you want to calculate default offset amount while adding a bill in an offset request.</p> <p>Note:</p> <p>The Search (🔍) icon appears corresponding to the Default Offset Amount Algorithm field. On clicking the Search icon, the Algorithm Search window appears.</p> <p>On specifying the algorithm, the description of the algorithm appears corresponding to the Default Offset Amount Algorithm field.</p> <p>You must specify an algorithm which is created using the C1-OFST-AMT algorithm type in the Default Offset Amount Algorithm field.</p>	Yes
Defer Processing FT Count	<p>Used to indicate whether an offset request must be processed in the deferred mode or in real time (i.e. immediately). If the number of financial transactions created for the bills which are selected in the offset request exceeds the defer processing count, the system will process the offset request in the deferred mode. However, if the number of financial transactions created for the bills which are selected in the offset request does not exceed the defer processing count, the system will process the offset request in real time (i.e. immediately).</p> <p>Note:</p> <p>You cannot specify a negative value in this field.</p> <p>Deferred mode means in the background when the Offset Request Periodic Monitor (C1-OFSRQ) batch is invoked. You can configure the Offset Request Periodic Monitor (C1-OFSRQ) batch such that it is executed at regular intervals. For more information about the Offset Request Periodic Monitor (C1-OFSRQ) batch, refer to <i>Oracle Revenue Management and Billing Batch Guide</i>.</p> <p>If you set the defer processing count to zero (0), the system resets the default value to 50.</p>	No
Approval Required	Used to indicate whether approval is required while offsetting bills through an offset request.	No

Field Name	Field Description	Mandatory (Yes or No)
Approval To Do Type	Used to indicate that To Do entry of the specified To Do type must be created when you submit an offset request for approval.	Yes (Conditional)
	<p>Note:</p> <p>The Search (🔍) icon appears corresponding to the Approval To Do Type field. On clicking the Search icon, the To Do Type Search window appears.</p> <p>On specifying the To Do type, the description of the To Do type appears corresponding to the Approval To Do Type field.</p> <p>This field appears when the Approval Required option is selected.</p> <p>The C1-OFSRQ To Do type is shipped with the product. You can use the C1-OFSRQ To Do type or a custom To Do type, if required.</p>	<p>Note: This field is required when the Approval Required option is selected.</p>
Approval To Do Role	Used to indicate that users with the specified To Do role can only approve an offset request submitted for approval.	Yes (Conditional)
	<p>Note:</p> <p>The list includes only those To Do roles which are associated with the approval To Do type.</p> <p>This field appears when the Approval Required option is selected.</p>	<p>Note: This field is required when the Approval Required option is selected.</p>
Submitter To Do Type	At present, the submitter To Do type is not used to create To Do entry when the approver rejects an offset request. It is only used to fetch the roles associated with the submitter To Do type.	Yes (Conditional)
	<p>Note:</p> <p>The Search (🔍) icon appears corresponding to the Submitter To Do Type field. On clicking the Search icon, the To Do Type Search window appears.</p> <p>On specifying the To Do type, the description of the To Do type appears corresponding to the Submitter To Do Type field.</p> <p>The C1-OFSSB To Do type is shipped with the product. You can use the C1-OFSSB To Do type or a custom To Do type, if required.</p>	<p>Note: This field is required when the Approval Required option is selected.</p>

Field Name	Field Description	Mandatory (Yes or No)
Submitter To Do Role	Used to indicate that users with the specified To Do role cannot approve an offset request submitted for approval.	Yes (Conditional) Note: This field is required when the Approval Required option is selected.
	Note: The list includes only those To Do roles which are associated with the submitter To Do type.	
Bill Search Period	Used to specify the maximum search period (in days) that you want to allow while searching bills in an offset request.	No
	Note: If you do not specify any value, by default, it is set to 30 .	
Transfer Adjustment	Used to indicate whether transfer adjustments should be created while offsetting bills through an offset request.	No
	Note: This impacts the system performance when the match type entity is set to BSEG and volume of bill segments in the selected bills is high. Alternatively, the system enables you to create offset adjustments while offsetting bills through an offset request whenever the volume of bill segments in the selected bills is high. To create the offset adjustments while offsetting bills through an offset request, you need to ensure that the Transfer Adjustment option is not selected in the respective offset request type.	

Tip: Alternatively, you can copy an offset request type by clicking the **Duplicate** button in the **Offset Request Type** zone.

5. Enter the required details in the **Main** section.
6. Define, edit, or remove characteristics of the offset request type, if required.
7. Click **Save**.

The new offset request type is defined.

Related Topics

For more information on...	See...
Offset Request Type screen	Offset Request Type on page 1570
Offset Request Type List zone	Offset Request Type List on page 1570
Offset Request Type zone	Offset Request Type on page 1571
How to define a characteristic for an offset request type	Defining a Characteristic for an Offset Request Type on page 1578
C1-OFST-AMT algorithm	C1-OFST-AMT on page 1569

Viewing the Offset Request Type Details

Procedure

To view the details of an offset request type:

1. Click the **Admin** link in the **Application** toolbar.
A list appears.
2. From the **Admin** menu, select **O** and then click **Offset Request Type**.
A sub-menu appears.
3. Click the **Search** option from the **Offset Request Type** sub-menu.
The **Offset Request Type** screen appears.
4. In the **Offset Request Type List** zone, click the **Broadcast** (📶) icon corresponding to the offset request type whose details you want to view.
The **Offset Request Type** zone appears.
5. View the details of the offset request type in the **Offset Request Type** zone.

Related Topics

For more information on...	See...
Offset Request Type screen	Offset Request Type on page 1570
Offset Request Type List zone	Offset Request Type List on page 1570
Offset Request Type zone	Offset Request Type on page 1571

Offset Request (Used for Searching)

The **Offset Request** screen allows you to search for an offset request using various search criteria. It also allows you to define an offset request. It contains the following zone:

- [Search Offset Request](#) on page 1590

Through this screen, you can navigate to the following screen:

- [Offset Request \(Used for Viewing\)](#) on page 1597

Search Offset Request

The **Search Offset Request** zone allows you to search for an offset request using various search criteria. It contains the following two sections:

- **Search Criteria** - The **Search Criteria** section contains the following fields:

Field Name	Field Description	Mandatory (Yes or No)
Search By	Used to indicate whether you want to search for an offset request using the offset request or bill details. The valid values are: <ul style="list-style-type: none"> • Request Details • Bill Details 	Yes
	Note: By default, the Request Details option is selected.	

Field Name	Field Description	Mandatory (Yes or No)
Offset Request ID	Used to search a particular offset request.	No
	Note: This field appears when the Request Details option is selected from the Search By list.	
Created From	Used to search offset requests which are created from a particular date onwards.	No
	Note: This field appears when the Request Details option is selected from the Search By list.	
User ID	Used to search offset requests which are created by a particular user.	No
	Note: This field appears when the Request Details option is selected from the Search By list.	
Created To	Used to search offset requests which are created till a particular date.	No
	Note: This field appears when the Request Details option is selected from the Search By list.	
Status	Used to search offset requests with a particular status. The valid values are: <ul style="list-style-type: none"> • Approval In Progress • Defer Unapplied • Deferred Processing • Draft • Processed • Rejected • Unapplied Offset 	No
	Note: This field appears when the Request Details option is selected from the Search By list.	
Person ID	Used to search offset requests which include bills of a particular person.	No
	Note: This field appears when the Request Details option is selected from the Search By list. The Search (🔍) icon appears corresponding to the Person ID field. On clicking the Search icon, the Person Search window appears.	

Field Name	Field Description	Mandatory (Yes or No)
Offset Request Type	Used to search offset requests which are created using a particular offset request type.	No
	Note: This field appears when the Request Details option is selected from the Search By list.	
Account ID	Used to search offset requests which include bills of a particular account.	No
	Note: This field appears when the Request Details option is selected from the Search By list. The Search (🔍) icon appears corresponding to the Account ID field. On clicking the Search icon, the Account Search window appears.	
Bill ID	Used to search offset requests which include a particular bill.	No
	Note: This field appears when the Bill Details option is selected from the Search By list. The Search (🔍) icon appears corresponding to the Bill ID field. On clicking the Search icon, the Bill Search window appears.	
Bill Date From	Used to search offset requests which include bills created from a particular date onwards.	No
	Note: This field appears when the Bill Details option is selected from the Search By list.	
Alternate Bill ID	Used to search offset requests which include a particular bill.	No
	Note: This field appears when the Bill Details option is selected from the Search By list.	
Bill Date To	Used to search offset requests which include bills created till a particular date.	No
	Note: This field appears when the Bill Details option is selected from the Search By list.	

Note: You must specify at least one search criterion while searching for an offset request.

- **Search Results** - On clicking the **Search** button, the search results appear based on the specified search criteria. The **Search Results** section contains the following columns:

Column Name	Column Description
Creation Date Time	Displays the date and time when the offset request is created.
Offset Request Information	Displays information about the offset request.
	Note: It has a link. On clicking the link, the Offset Request screen appears where you can view the details of the respective offset request.
Offset Amount	Displays the total amount which is offset through the offset request.
Status	Indicates the status of the offset request. The valid values are: <ul style="list-style-type: none"> • Approval In Progress • Defer Unapplied • Deferred Processing • Draft • Processed • Rejected • Unapplied Offset
Created By	Indicates the user who has created the offset request.
Creation Mode	Indicates whether the offset request is created manually or automatically. The valid values are: <ul style="list-style-type: none"> • Automatic • Manual
Primary Bill	Indicates the bill for which the offset request is created. In addition, this column has a context menu which helps in navigating to other screens in the application.
	Note: It has a link. On clicking the link, the Bill screen appears where you can view the details of the respective bill.

Note: Pagination is used to display limited number of records in the **Search Results** section. You can use the navigation links, such as **Previous** and **Next** to navigate between pages.

Related Topics

For more information on...	See...
How to search for an offset request	Searching for an Offset Request on page 1593
How to view the details of an offset request	Viewing the Offset Request Details on page 1596
How to create an offset request	Creating an Offset Request on page 1594

Searching for an Offset Request

Prerequisites

To search for an offset request, you should have:

- Offset request types defined in the application

Procedure

To search for an offset request:

1. Click the **Menu** link in the **Application** toolbar.
A list appears.
2. From the **Main** menu, select **Accounting and Receivable** and then click **Offset Request**.
A sub-menu appears.
3. Click the **Search** option from the **Offset Request** sub-menu.
The **Offset Request** screen appears.
4. Enter the search criteria in the **Search Offset Request** zone.

Note: ORMB search engine supports wildcard search, where you can substitute the percentage (%) symbol as a stand in for any word or letter in a search criteria. You can use the ‘%’ wildcard character in all input fields except the date and ID fields. The ‘%’ wildcard character is suffixed automatically at the end of the partial search criteria. Therefore, you may or may not specify the wildcard character at the end of the partial search criteria. However, you have to prefix the wildcard character manually wherever required.

5. Click **Search**.

A list of offset requests that meet the search criteria appears in the **Search Results** section.

Related Topics

For more information on...	See...
Offset Request screen	Offset Request (Used for Searching) on page 1590
Search Offset Request zone	Search Offset Request on page 1590

Creating an Offset Request

Prerequisites

To create an offset request, you should have:

- Offset request types defined in the application
- Bills created in the application

Procedure

To create an offset request:

1. Do either of the following:

If you want to...	Then...
Create a single offset request from the Account Receivable Central screen	<ol style="list-style-type: none"> 1. Click the Menu link in the Application toolbar. A list appears. 2. From the Main menu, select Accounting and Receivable and then click Account Receivable Central. The Account Receivable Central screen appears. 3. Search for the required bill in the Search Bill zone.

If you want to...	Then...
	<ol style="list-style-type: none"> 4. In the Search Results section, select the check box corresponding to the bill which you want to offset through a single offset request. 5. Click Single Offset.
Create a mass offset request from the Account Receivable Central screen	<ol style="list-style-type: none"> 1. Click the Menu link in the Application toolbar. A list appears. 2. From the Main menu, select Accounting and Receivable and then click Account Receivable Central. The Account Receivable Central screen appears. 3. Search for the required bill in the Search Bill zone. 4. In the Search Results section, select the check box corresponding to the bill which you want to offset through a mass offset request. 5. Click Mass Offset.
Create a cross currency offset request from the Account Receivable Central screen	<ol style="list-style-type: none"> 1. Click the Menu link in the Application toolbar. A list appears. 2. From the Main menu, select Accounting and Receivable and then click Account Receivable Central. The Account Receivable Central screen appears. 3. Search for the required bill in the Search Bill zone. 4. In the Search Results section, select the check box corresponding to the bill which you want to offset through a cross currency offset request. 5. Click Cross Currency Offset.
Create a single, mass, or cross currency offset request from the Offset Request screen	<ol style="list-style-type: none"> 1. Click the Menu link in the Application toolbar. A list appears. 2. From the Main menu, select Accounting and Receivable and then click Offset Request. A sub-menu appears. 3. Click the Add option from the Offset Request sub-menu.

The **Add Offset Request** screen appears. It contains the following fields:

Field Name	Field Description	Mandatory (Yes or No)
Offset Request Type	Used to indicate the offset request type using which you want to create the offset request.	Yes
Bill	Used to indicate the bill which you want to offset through the offset request. <div style="border: 1px solid black; padding: 5px;"> <p>Note:</p> <p>The Search (🔍) icon appears corresponding to the Bill field. On clicking the Search icon, the Bill Search window appears.</p> <p>On specifying the bill, the information about the bill appears corresponding to the Bill field.</p> </div>	Yes

Tip: Alternatively, you can access this screen by clicking the **Add** button in the **Page Title** area of the **Offset Request** screen.

- Enter the required details in the **Add Offset Request** screen.
- Click **Save**.

The offset request is created in the **Draft** status. The **Offset Request** screen appears where you can view the details of the offset request. By default, the adjustment type specified in the respective offset request type is used while creating the offset request. You can then change the adjustment type, if required.

- Add debit and/or credit bills in the offset request.
- Define characteristics for the offset request, if required.

Related Topics

For more information on...	See...
Single Offset Request	Single Offset on page 1555
Mass Offset Request	Mass Offset on page 1556
Cross Currency Offset Request	Cross Currency Offset on page 1559
Offset Request screen	Offset Request (Used for Searching) on page 1590
How to add a debit or credit bill to an offset request	Adding a Debit or Credit Bill to an Offset Request on page 1608
How to define a characteristic for an offset request	Defining a Characteristic for an Offset Request on page 1610

Viewing the Offset Request Details

Procedure

To view the details of an offset request:

- Search for the offset request in the **Offset Request** screen.
- In the **Search Results** section, click the link in the **Offset Request Information** column corresponding to the offset request whose details you want to view.

The **Offset Request** screen appears.

3. Ensure that the **Main** tab is selected.
4. View the details of the offset request in the **Offset Request** zone.

Related Topics

For more information on...	See...
How to search for an offset request	Searching for an Offset Request on page 1593
Offset Request screen	Offset Request (Used for Viewing) on page 1597
Offset Request zone	Offset Request on page 1597

Offset Request (Used for Viewing)

The **Offset Request** screen allows you to:

- View the details of the offset request
- View the debit and credit bills which are added to the offset request
- View the offset or transfer adjustments which are created through the offset request
- Add a debit or credit bill to the offset request
- Edit the details of the offset request
- Define, edit, or remove the characteristics from the offset request
- Edit the offset amount for each debit and credit bill
- Remove a debit or credit bill from the offset request
- Delete the offset request
- Submit the offset request for approval
- Approve or reject the offset request
- Unapply (i.e. cancel) the offset request
- View the log of the offset request
- Add a log entry for the offset request

It consists of the following tabs:

- [Offset Request - Main](#) on page 1597
- [Offset Request - Log](#) on page 1606

Offset Request - Main

The **Main** tab displays information about the offset request. It contains the following zones:

- [Offset Request](#) on page 1597
- [Selected Bills](#) on page 1600
- [Search Bill](#) on page 1601
- [Offset Request Adjustments](#) on page 1606

Offset Request

The **Offset Request** zone displays the details of the offset request. It contains the following sections:

- **Main** - Displays basic information about the offset request. It contains the following fields:

Field Name	Field Description
Offset Request Information	Displays information about the offset request.
Offset Request Type	Indicates the offset request type using which the offset request is created. Note: It has a link. On clicking the link, the Offset Request Type screen appears where you can view the details of the respective offset request type.
Status	Indicates the status of the offset request. The valid values are: <ul style="list-style-type: none"> • Approval In Progress • Defer Unapplied • Deferred Processing • Draft • Rejected • Processed • Unapplied Offset
Status Reason	Indicates the reason why the offset request is rejected or unapplied (i.e. canceled). Note: It has a link. On clicking the link, the Status Reason screen appears where you can view the details of the respective status reason. This field appears when the offset request is in the Rejected, Defer Unapplied, or Unapplied Offset status.
Adjustment Type	Indicates the adjustment type using which the offset or transfer adjustments should be created through the offset request. Note: It has a link. On clicking the link, the Adjustment Type screen appears where you can view the details of the respective adjustment type.
Offset Amount	Displays the total amount which is offset through the offset request.
Comments	Displays additional details specified while rejecting or unapplying (i.e. canceling) the offset request. Note: This field appears when the offset request is in the Rejected, Defer Unapplied, or Unapplied Offset status.

- **Characteristics** - Lists the characteristics defined for the offset request. It contains the following columns:

Column Name	Column Description
Effective Date	Displays the date from when the characteristic is effective for the offset request.
Characteristic Type	Indicates the characteristic type.
Characteristic Value	Displays the value of the characteristic type.

- **Record Actions** - This section contains the following buttons:

Button Name	Button Description
Edit	Used to edit the details of the offset request.
	Note: The Edit button appears when the offset request is in the Draft status.
Delete	Used to delete the offset request.
	Note: The Delete button appears when the offset request is in the Draft status.
Submit	Used to submit the offset request.
	Note: The Submit button appears when the offset request is in the Draft status.
Approve	Used to approve the offset request.
	Note: The Approve button appears when: <ul style="list-style-type: none"> • The offset request is in the Approval In Progress status. • A user with the approval To Do role is reviewing the offset request.
Reject	Used to reject the offset request.
	Note: The Reject button appears when: <ul style="list-style-type: none"> • The offset request is in the Approval In Progress status. • A user with the approval To Do role is reviewing the offset request.
Unapply	Used to unapply (i.e. cancel) the offset request.
	Note: The Unapply button appears when the offset request is in the Processed status.

- **Record Information** - This section contains the following fields:

Field Name	Field Description
Business Object	Indicates the business object using which the offset request is created. In addition, a context menu appears corresponding to this field which helps in navigating to other screens in the application.
	Note: It has a link. On clicking the link, the Business Object screen appears where you can view the details of the respective business object.
Status Date/Time	Displays the date and time when the offset request status is updated
Create Date/Time	Displays the date and time when the offset request is created.

Related Topics

For more information on...	See...
How to edit an offset request	Editing an Offset Request on page 1609
How to delete an offset request	Deleting an Offset Request on page 1613
How to submit an offset request	Submitting an Offset Request on page 1614

For more information on...	See...
How to approve an offset request	Approving an Offset Request on page 1616
How to reject an offset request	Rejecting an Offset Request on page 1618
How to unapply (i.e. cancel) an offset request	Unapplying an Offset Request on page 1620

Selected Bills

The **Selected Bills** zone lists the debit and credit bills which are added to the offset request. It contains the following columns:

Column Name	Column Description
Bill Information	Indicates the debit or credit bill which is added to the offset request. In addition, this column has a context menu which helps in navigating to other screens in the application.
	Note: It has a link. On clicking the link, the Bill screen appears where you can view the details of the respective bill.
Bill Date	Displays the date when the debit or credit bill is created.
Outstanding Amount	Displays the outstanding amount (i.e. unpaid amount) of the debit or credit bill.
Hold Amount	Displays the amount of the debit or credit bill which is kept on hold through an hold request.
Offset Amount	Displays the amount which you want to offset from the debit or credit bill.
Remaining Bill Balance	Displays the remaining outstanding amount of the debit or credit bill (i.e. Outstanding Amount - Hold Amount - Offset Amount).
	Note: This column does not appear when the offset request is in the Processed or Unapplied Offset status.
Updated Hold Amount	Displays the new hold amount (i.e. Current Hold Amount + Remaining Bill Balance) for the debit or credit bill which is derived when the remaining bill balance is less than the current hold amount.
	Note: This column does not appear when the offset request is in the Processed or Unapplied Offset status.
Account Information	Indicates the account for which the debit or credit bill is created. In addition, this column has a context menu which helps in navigating to other screens in the application.
	Note: It has a link. On clicking the link, the Account screen appears where you can view the details of the respective account.
Bill ID	Displays the bill ID.

Note: Pagination is used to display limited number of records in this zone. You can use the navigation links, such as **Previous** and **Next** to navigate between pages.

On clicking the **Broadcast** () icon corresponding to a bill, the **Offset Request Adjustments** zone appears where you can view the offset or transfer adjustments created for the bill through the offset request.

Note: The **Broadcast** () icon appears corresponding to a bill when the offset request is in the **Processed** or **Unapplied Offset** status.

You can filter the list using various search criteria (such as, **Bill Balance**, **Bill ID**, and **Account ID**) available in the **Filter** area. By default, the **Filter** area is hidden. You can view the **Filter** area by clicking the **Filters** (🔍) icon in the upper right corner of this zone.

You can change the layout of this zone. For more information on how to change the layout, see [Changing the Layout](#) on page 3414.

Related Topics

For more information on...	See...
How to view the debit or credit bills added to an offset request	Viewing the Debit and Credit Bills Added to an Offset Request on page 1607

Search Bill

The bills listed in the **Search Bill** zone varies depending on the following scenarios:

If...	Then...
The single offset request is created through the Account Receivable Central screen and the Allow Offsetting Across Persons option type of the C1-OFFSETREQ feature configuration is set to Y	The Search Bill zone lists completed bills of all accounts of the main customer (whose bill is added as the primary bill in the offset request) and completed bills of all accounts of its effective child persons. If the primary bill is a debit bill, it lists credit bills of the main customer and its child persons. However, if the primary bill is a credit bill, it lists debit bills of the main customer and its child persons. Note that it lists only those bills which are in the same currency as that of the primary bill. For example, if the primary bill is in USD, then this zone lists all completed bills of the main customer and its child persons which are in USD.
The single offset request is created through the Account Receivable Central screen and the Allow Offsetting Across Persons option type of the C1-OFFSETREQ feature configuration is set to N	The Search Bill zone lists completed bills of all accounts of the main customer (whose bill is added as the primary bill in the offset request). If the primary bill is a debit bill, it lists credit bills of the main customer. However, if the primary bill is a credit bill, it lists debit bills of the main customer. Note that it lists only those bills which are in the same currency as that of the primary bill. For example, if the primary bill is in USD, then this zone lists all completed bills of the main customer which are in USD.
The mass offset request is created through the Account Receivable Central screen and the Allow Offsetting Across Persons option type of the C1-OFFSETREQ feature configuration is set to Y	The Search Bill zone lists completed debit and credit bills of all accounts of the main customer (whose bill is added as the primary bill in the offset request) and completed debit and credit bills of all accounts of its effective child persons. Note that it lists only those debit and credit bills which are in the same currency as that of the primary bill. For example, if the primary bill is in USD, then this zone lists all completed debit and credit bills of the main customer and its child persons which are in USD.
The mass offset request is created through the Account Receivable Central screen and the Allow Offsetting Across Persons option type of the C1-OFFSETREQ feature configuration is set to N	The Search Bill zone lists completed debit and credit bills of all accounts of the main customer (whose bill is added as the primary bill in the offset request). Note that it lists only those debit and credit bills which are in the same currency as that of the primary bill. For example, if the primary bill is in USD, then this zone lists all completed debit and credit bills of the main customer which are in USD.

If...	Then...
The cross currency offset request is created through the Account Receivable Central screen and the Allow Offsetting Across Persons option type of the C1-OFFSETREQ feature configuration is set to Y	The Search Bill zone lists completed debit and credit bills of all accounts of the main customer (whose bill is added as the primary bill in the offset request) and completed debit and credit bills of all accounts of its effective child persons. Note that it lists only those debit and credit bills which are in the currency different from the primary bill. For example, if the primary bill is in USD, then this zone lists all completed debit and credit bills of the main customer and its child persons which are in the currency other than USD.
The cross currency offset request is created through the Account Receivable Central screen and the Allow Offsetting Across Persons option type of the C1-OFFSETREQ feature configuration is set to N	The Search Bill zone lists completed debit and credit bills of all accounts of the main customer (whose bill is added as the primary bill in the offset request). Note that it lists only those debit and credit bills which are in the currency different from the primary bill. For example, if the primary bill is in USD, then this zone lists all completed debit and credit bills of the main customer which are in the currency other than USD.
The offset request is created through the Offset Request screen and the Allow Offsetting Across Persons option type of the C1-OFFSETREQ feature configuration is set to Y	<p>The Search Bill zone lists completed debit and credit bills of all accounts of the main customer (whose bill is added as the primary bill in the offset request) and completed debit and credit bills of all accounts of its effective child persons. Note that it lists only those debit and credit bills which are in the same currency as that of the primary bill. For example, if the primary bill is in USD, then this zone lists all completed debit and credit bills of the main customer and its child persons which are in USD.</p> <p>Note: This zone lists the debit and credit bills in the currency different from the primary bill when the Show Cross Currency Bills option is selected.</p>
The offset request is created through the Offset Request screen and the Allow Offsetting Across Persons option type of the C1-OFFSETREQ feature configuration is set to N	<p>The Search Bill zone lists completed debit and credit bills of all accounts of the main customer (whose bill is added as the primary bill in the offset request). Note that it lists only those debit and credit bills which are in the same currency as that of the primary bill. For example, if the primary bill is in USD, then this zone lists all completed debit and credit bills of the main customer which are in USD.</p> <p>Note: This zone lists the debit and credit bills in the currency different from the primary bill only when the Show Cross Currency Bills option is selected.</p>

It also allows you to filter the bills using various search criteria. It contains the following two sections:

- **Search Criteria** - The **Search Criteria** section contains the following fields:

Field Name	Field Description	Mandatory (Yes or No)
Search By	Used to indicate whether you want to search for a completed bill using the person, account, or bill details. The valid values are: <ul style="list-style-type: none"> • Person Details • Account Details • Bill Details 	Yes
	Note: By default, the Person Details option is selected.	
Person ID	Used to search completed bills of a particular person.	No
	Note: This field appears when the Person Details option is selected from the Search By list. The Search (🔍) icon appears corresponding to the Person ID field. On clicking the Search icon, the Person Search window appears.	
Bill Date From	Used to search completed bills which are created from a particular date onwards.	Yes
	Note: By default, it is set to a date which is calculated as follows: Bill Date To - Bill Search Period (Specified in Offset Request Type)	
Bills on Hold	Used to indicate whether you want to search completed bills which are partially kept on hold. The valid values are: <ul style="list-style-type: none"> • No • Yes 	No
Bill Date To	Used to search completed bills which are created till a particular date.	Yes
	Note: By default, it is set to the current date.	

Field Name	Field Description	Mandatory (Yes or No)						
Bill Balance	<p>Used to indicate whether you want to search completed bills with a particular balance amount. The valid values are:</p> <ul style="list-style-type: none"> • Equal to Zero • Greater Than Zero • Less Than Zero • Not Equal to Zero <p>Note:</p> <p>If a single or cross currency offset request is created through the Account Receivable Central screen, this field is disabled, and by default, it is set to the following:</p> <table border="1"> <thead> <tr> <th>If the primary bill is a...</th> <th>Then, it is set to...</th> </tr> </thead> <tbody> <tr> <td>Credit Bill</td> <td>Greater Than Zero</td> </tr> <tr> <td>Debit Bill</td> <td>Less Than Zero</td> </tr> </tbody> </table>	If the primary bill is a...	Then, it is set to...	Credit Bill	Greater Than Zero	Debit Bill	Less Than Zero	No
If the primary bill is a...	Then, it is set to...							
Credit Bill	Greater Than Zero							
Debit Bill	Less Than Zero							
Show Cross Currency Bills	<p>Used to indicate whether you want to search completed bills in the currencies different from the primary bill.</p> <p>Note:</p> <p>This option is disabled when a single or cross currency offset request is created through the Account Receivable Central screen.</p> <p>By default, this option is selected when a cross currency offset request is created through the Account Receivable Central screen.</p>	No						
Account ID	<p>Used to search completed bills which created for a particular account.</p> <p>Note:</p> <p>This field appears when the Account Details option is selected from the Search By list.</p> <p>The Search (🔍) icon appears corresponding to the Account ID field. On clicking the Search icon, the Account Search window appears.</p>	Yes						

Field Name	Field Description	Mandatory (Yes or No)
Bill ID	Used to search a particular completed bill.	No
	<p>Note:</p> <p>This field appears when the Bill Details option is selected from the Search By list.</p> <p>The Search (🔍) icon appears corresponding to the Bill ID field. On clicking the Search icon, the Bill Search window appears.</p>	

- **Search Results** - On clicking the **Search** button, the search results appear based on the specified search criteria. The **Search Results** section contains the following columns:

Column Name	Column Description
Bill Information	Display information about the completed debit or credit bill. In addition, this column has a context menu which helps in navigating to other screens in the application.
	Note: It has a link. On clicking the link, the Bill screen appears where you can view the details of the respective bill.
Bill Date	Displays the date when the debit or credit bill is created.
Due Date	Displays the date when the debit or credit bill is due for payment.
Outstanding Amount	Displays the outstanding amount (i.e. unpaid amount) of the debit or credit bill.
Hold Amount	Displays the amount of the debit or credit bill which is kept on hold through an hold request.
Outstanding Amount (Offset Currency)	Displays the outstanding amount (i.e. unpaid amount) of the debit or credit bill in the currency in which the bill amount would be offset.
	Note: This column appears when the offset request is a cross-currency offset request.
Account Information	Indicates the account for which the debit or credit bill is created. In addition, this column has a context menu which helps in navigating to other screens in the application.
	Note: It has a link. On clicking the link, the Account screen appears where you can view the details of the respective account.

Note: Pagination is used to display limited number of records in the **Search Results** section. You can use the navigation links, such as **Previous** and **Next** to navigate between pages.

In addition, this section contains the following button:

Button Name	Button Description
Add	Used to add a bill to the offset request.

A check box appears corresponding to each bill. On selecting the check box, you can add the bill to the offset request. You can also select multiple bills at the same time. In addition, you can select the check box corresponding to the column header. This allows you to add all bills listed in the respective page to the offset request.

Related Topics

For more information on...	See...
How to add a debit or credit bill to an offset request	Adding a Debit or Credit Bill to an Offset Request on page 1608
How to setup the C1-OFFSETREQ feature configuration	Setting the C1-OFFSETREQ Feature Configuration on page 3459

Offset Request Adjustments

The **Offset Request Adjustments** zone lists the offset or transfer adjustments which are created for the bill through the offset request. It appears when the offset request is in the **Processed** status. It contains the following columns:

Column Name	Column Description
Adjustment Information	Displays information about the offset or transfer adjustment. Note: It has a link. On clicking the link, the Adjustment screen appears where you can view the details of the respective adjustment.
From Bill ID	Indicates the bill from where the amount is offset.
To Bill ID	Indicates the bill against which the amount is offset.
Current Amount	Displays the adjustment amount.

Related Topics

For more information on...	See...
How to view the offset or transfer adjustments created through an offset request	Viewing the Adjustments Created Through an Offset Request on page 1607

Offset Request - Log

The **Log** tab contains the following zone:

- [Offset Request Log](#) on page 1606

Offset Request Log

The **Offset Request Log** zone lists the complete trail of actions performed on the offset request. It contains the following columns:

Column Name	Column Description
Creation Date Time	Displays the date and time when the action was performed on the offset request.
Details	Displays the details about the action performed on the offset request.
User	Indicates the user who has performed the action on the offset request.
Log Type	Indicates the type of log.
Related Object	Indicates the object or entity which is created when the action is performed on the offset request. Note: At present, no data appears in this column. The implementation team can build the custom logic to meet the business requirements.
Status Reason	Indicates the reason why the offset request is rejected or unapplied (i.e. canceled).

Note: You can manually add a log entry for the offset request by clicking the **Add Log Entry** link in the upper right corner of the **Offset Request Log** zone.

Related Topics

For more information on...	See...
How to view the log of an offset request	Viewing the Log of an Offset Request on page 1621
How to add a log entry for an offset request	Adding a Log Entry for an Offset Request on page 1621

Viewing the Debit and Credit Bills Added to an Offset Request

Procedure

To view the debit and credit bills which are added to an offset request:

1. Search for the offset request in the **Offset Request** screen.
2. In the **Search Results** section, click the link in the **Offset Request Information** column corresponding to the offset request whose details you want to view.

The **Offset Request** screen appears.

3. Ensure that the **Main** tab is selected.
4. View the debit and credit bills added to the offset request in the **Selected Bills** zone.

Related Topics

For more information on...	See...
How to search for an offset request	Searching for an Offset Request on page 1593
Offset Request screen	Offset Request (Used for Viewing) on page 1597
Selected Bills zone	Selected Bills on page 1600

Viewing the Adjustments Created Through an Offset Request

Procedure

To view the adjustments created through an offset request:

1. Search for the offset request in the **Offset Request** screen.
2. In the **Search Results** section, click the link in the **Offset Request Information** column corresponding to the offset request whose details you want to view.

The **Offset Request** screen appears.

3. Ensure that the **Main** tab is selected.
4. In the **Selected Bills** zone, click the **Broadcast** (📡) icon corresponding to the bill whose offset or transfer adjustments you want to view.

The **Offset Request Adjustments** zone appears.

Note: The **Broadcast** (📡) icon appears corresponding to a bill when the offset request is in the **Processed** or **Unapplied Offset** status.

- View the offset or transfer adjustments created for the bill through the offset request in the **Offset Request Adjustments** zone.

Related Topics

For more information on...	See...
How to search for an offset request	Searching for an Offset Request on page 1593
Offset Request screen	Offset Request (Used for Viewing) on page 1597
Selected Bills zone	Selected Bills on page 1600
Offset Request Adjustments zone	Offset Request Adjustments on page 1606

Adding a Debit or Credit Bill to an Offset Request

Prerequisites

To add a debit or credit bill to an offset request, you should have:

- Completed bills for accounts of the main customer (whose bill is added as the primary bill in the offset request)
- Completed bills for effective child persons of the main customer (whose bill is added as the primary bill in the offset request)
- The **Allow Offsetting Across Persons** option type of the **C1-OFFSETREQ** feature configuration set to **Y** or **N** based on the business requirements

Procedure

To add a debit or credit bill to an offset request:

- Search for the offset request in the **Offset Request** screen.
- In the **Search Results** section, click the link in the **Offset Request Information** column corresponding to the offset request whose details you want to edit.

The **Offset Request** screen appears.

- Ensure that the **Main** tab is selected.
- Enter the search criteria in the **Search Bill** zone.

Note:

The **Search Bill** zone appears when the offset request is in the **Draft** status.

The date range specified in the **Bill Date From** and **Bill Date To** fields should not exceed the number of days specified in the **Bill Search Period** field of the respective offset request type.

ORMB search engine supports wildcard search, where you can substitute the percentage (%) symbol as a stand in for any word or letter in a search criteria. You can use the '%' wildcard character in all input fields except the date and ID fields. The '%' wildcard character is suffixed automatically at the end of the partial search criteria. Therefore, you may or may not specify the wildcard character at the end of the partial search criteria. However, you have to prefix the wildcard character manually wherever required.

- Click **Search**.
A list of completed bills that meet the search criteria appears in the **Search Results** section.
- Select the check box corresponding to a completed bill that you want to add to the offset request.
- Click the **Add** button in the **Search Bill** zone.

A message appears indicating that the bill is added to the offset request.

Note: You can only add a completed bill to an offset request when its outstanding amount is not equal to zero.

8. Click **OK**.

The completed bill is added to the offset request. You can view the completed bills which are added to the offset request in the **Selected Bills** zone.

Note: The default offset amount is calculated for each bill using the algorithm which is attached in the respective offset request type. For more information on how the default offset amount is calculated, see [CI-OFFST-AMT](#) on page 1569.

Related Topics

For more information on...	See...
How to search for an offset request	Searching for an Offset Request on page 1593
Offset Request screen	Offset Request (Used for Viewing) on page 1597
Search Bill zone	Search Bill on page 1601
Selected Bills zone	Selected Bills on page 1600
How to create an offset request	Creating an Offset Request on page 1594
How to setup the C1-OFFSETREQ feature configuration	Setting the C1-OFFSETREQ Feature Configuration on page 3459

Editing an Offset Request

Prerequisites

To edit an offset request, you should have:

- Adjustment types defined in the application (where the **A/P Request Type Code** field is not set to **REFUND**)

Procedure

To edit an offset request:

1. Search for the offset request in the **Offset Request** screen.
2. In the **Search Results** section, click the link in the **Offset Request Information** column corresponding to the offset request whose details you want to edit.

The **Offset Request** screen appears.

3. Ensure that the **Main** tab is selected.
4. Click the **Edit** button in the **Offset Request** zone.

The **Offset Request** screen appears. It contains the following sections:

- **Main** - Used to specify the basic details about the offset request.
- **Characteristics** - Used to define the characteristics for the offset request.
- **Offset Details** - Used to edit the offset amount of the bills which are added to the offset request. It also allows you to remove a bill from the offset request.

Note: You can only remove secondary debit or credit bills from the offset request. And, you cannot remove a primary debit or credit bill from the offset request throughout its lifecycle.

The **Main** section contains the following fields:

Field Name	Field Description	Mandatory (Yes or No)
Offset Request Information	Displays information about the offset request.	Not applicable
Offset Request Type	Indicates the offset request type using which the offset request is created.	Not applicable
Adjustment Type	Used to indicate the adjustment type using which transfer or offset adjustments must be created through the offset request. Note: The Search (🔍) icon appears corresponding to the Adjustment Type field. On clicking the Search icon, the Adjustment Type Search window appears. On specifying the adjustment type, the description of the adjustment type appears corresponding to the Adjustment Type field.	Yes
Comments	Used to specify additional information about the offset request.	No

Note: The **Edit** button appears when the offset request is in the **Draft** status.

5. Modify the required details in the **Main** section.
6. Define, edit, or remove characteristics of the offset request, if required.
7. Edit the offset amount of a debit or credit bill, if required.
8. Remove a debit or credit bill from the offset request, if required.
9. Click **Save**.

The changes made to the offset request are saved.

Related Topics

For more information on...	See...
How to search for an offset request	Searching for an Offset Request on page 1593
Offset Request screen	Offset Request (Used for Viewing) on page 1597
Offset Request zone	Offset Request on page 1597
How to define a characteristic for an offset request	Defining a Characteristic for an Offset Request on page 1610
How to edit the offset amount of a debit or credit bill	Editing the Offset Amount of a Debit or Credit Bill on page 1612
How to remove a debit or credit bill from an offset request	Removing a Debit or Credit Bill from an Offset Request on page 1613

Defining a Characteristic for an Offset Request

Prerequisites

To define a characteristic for an offset request, you should have:

- Characteristic types defined in the application (where the characteristic entity is set to **Offset Request**)

Procedure

To define a characteristic for an offset request:

1. Ensure that the **Characteristics** section is expanded when you are editing an offset request.

The **Characteristics** section contains the following fields in a grid:

Field Name	Field Description	Mandatory (Yes or No)
Effective Date	Used to specify the date from when the characteristic is effective for the offset request.	Yes (Conditional)
		Note: This field is required when you are defining a characteristic for the offset request.
Characteristic Type	Used to indicate the characteristic type.	Yes (Conditional)
	Note: The list includes only those characteristic types where the characteristic entity is set to Offset Request .	Note: This field is required when you are defining a characteristic for the offset request.
Characteristic Value	Used to specify the value for the characteristic type.	Yes (Conditional)
	<p>Note:</p> <p>If you select a predefined characteristic type, the Search (🔍) icon appears corresponding to the Characteristic Value field. On clicking the Search icon, the Predefined Characteristic Search window appears.</p> <p>On specifying the value for a predefined characteristic type, the description of the characteristic value appears corresponding to the Characteristic Value field.</p>	Note: This field is required when you are defining a characteristic for the offset request.

2. Enter the required details in the **Characteristics** section.
3. If you want to define more than one characteristic for the offset request, click the **Add** (+) icon and then repeat step 2.

Note: However, if you want to remove a characteristic from the offset request, click the **Delete** (🗑️) icon corresponding to the characteristic.

4. Click **Save**.

The characteristics are defined for the offset request.

Related Topics

For more information on...	See...
How to edit an offset request	Editing an Offset Request on page 1609

Editing the Offset Amount of a Debit or Credit Bill

Prerequisites

To edit the offset amount of a debit or credit bill, you should have:

- Required debit or credit bill added in the offset request

Procedure

To edit the offset amount of a debit or credit bill:

1. Ensure that the **Offset Details** section is expanded when you are editing an offset request.

The **Offset Details** section contains the following fields:

Field Name	Field Description	Mandatory (Yes or No)
Total Debit Offset Amount	Displays the total offset amount of all debit bills which are included in the offset request.	Not applicable
Total Credit Offset Amount	Displays the total offset amount of all credit bills which are included in the offset request.	Not applicable
Total Offset Amount	Displays the sum of the total debit and credit offset amount.	Not applicable

In addition, this section contains the following fields in a grid:

Field Name	Field Description	Mandatory (Yes or No)
Bill ID	Indicates the debit or credit bill which is added to the offset request.	Not applicable
Outstanding Amount	Displays the outstanding amount (i.e. unpaid amount) of the debit or credit bill.	Not applicable
Due Date	Displays the date when the debit or credit bill is due for payment.	Not applicable
Hold Amount	Displays the amount of the debit or credit bill which is kept on hold through an hold request.	Not applicable
Outstanding Amount (Offset Currency)	Displays the outstanding amount (i.e. unpaid amount) of the debit or credit bill in the currency in which the bill amount would be offset. Note: This field appears when the offset request is a cross-currency offset request.	Not applicable
Offset Amount	Used to specify the amount which you want to offset from the debit or credit bill.	Yes
Remaining Bill Balance	Displays the remaining outstanding amount of the debit or credit bill (i.e. Outstanding Amount - Hold Amount - Offset Amount).	Not applicable
Updated Hold Amount	Displays the new hold amount (i.e. Current Hold Amount + Remaining Bill Balance) for the debit or credit bill which is derived when the remaining bill balance is less than the current hold amount.	Not applicable

The **Delete** (🗑️) icon appears corresponding to the secondary debit or credit bills in the **Offset Details** section. It allows you to remove the respective bill from the offset request.

2. Modify the offset amount of the required debit or credit bill in the **Offset Details** section.
3. Click **Save**.

The changes made to the offset request are saved.

Related Topics

For more information on...	See...
How to edit an offset request	Editing an Offset Request on page 1609
How to remove a debit or credit bill from an offset request	Removing a Debit or Credit Bill from an Offset Request on page 1613

Removing a Debit or Credit Bill from an Offset Request

Procedure

To remove a debit or credit bill from an offset request:

1. Ensure that the **Offset Details** section is expanded when you are editing an offset request.
2. Click the **Delete** (🗑️) icon corresponding to the debit or credit bill that you want to remove from the offset request.

A message appears confirming whether you want to delete the bill.

Note: The **Delete** (🗑️) icon appears corresponding to the secondary debit or credit bills. It does not appear corresponding to the primary debit or credit bill. This is because you cannot remove a primary debit or credit bill from the offset request throughout its lifecycle.

3. Click **OK**.

The debit or credit bill is removed from the offset request.

Related Topics

For more information on...	See...
How to edit an offset request	Editing an Offset Request on page 1609

Deleting an Offset Request

Procedure

To delete an offset request:

1. Search for the offset request in the **Offset Request** screen.
2. In the **Search Results** section, click the link in the **Offset Request Information** column corresponding to the offset request that you want to delete.

The **Offset Request** screen appears.

3. Ensure that the **Main** tab is selected.
4. Click the **Delete** button in the **Offset Request** zone.

A message appears confirming whether you want to delete the offset request.

Note: The **Delete** button appears when the offset request is in the **Draft** status.

5. Click **OK**.

The offset request is deleted.

Related Topics

For more information on...	See...
How to search for an offset request	Searching for an Offset Request on page 1593
Offset Request screen	Offset Request (Used for Viewing) on page 1597
Offset Request zone	Offset Request on page 1597

Submitting an Offset Request

Prerequisites

To submit an offset request, you should have:

- At least one debit and credit bills added to the offset request
- Offset amount of each bill not equal to zero
- Total debit offset amount equal to total credit offset amount in the offset request
- Negative offset amount for each debit bill and positive offset amount for each credit bill
- Offset amount less than or equal to the current outstanding amount of the bill

Procedure

To submit an offset request:

1. Search for the offset request in the **Offset Request** screen.
2. In the **Search Results** section, click the link in the **Offset Request Information** column corresponding to the offset request which you want to submit.

The **Offset Request** screen appears.

3. Ensure that the **Main** tab is selected.
4. Click the **Submit** button in the **Offset Request** zone.

The system behaves in the following manner:

If...	Then
The Approval Required option is selected in the respective offset request type	A To Do of the C1-OFSRQ To Do type is created and sent to the approver. The status of the offset request is then changed to Approval In Progress .

If...	Then
<p>The Approval Required option is not selected in the respective offset request type and the number of financial transactions created for the bills (which are selected in the offset request) exceeds the defer processing count (defined in the respective offset request type)</p>	<p>The status of the offset request is changed to Deferred Processing. On executing the Offset Request Periodic Monitor (C1-OFSRQ) batch, the system considers the offset requests which are in the Deferred Processing status. If the Transfer Adjustment option is selected in the respective offset request type, the system creates the transfer adjustments using the adjustment type which is specified in the offset request. The status of the transfer adjustments is set to Frozen. However, if the Transfer Adjustment option is not selected in the respective offset request type, the system creates the offset adjustments using the adjustment type which is specified in the offset request. The status of the offset adjustments is set to Frozen. Finally, the status of the offset request is changed to Processed.</p> <p>Note: If a match event exists for the match type entity (i.e. bill, bill segment, or contract), the existing match event is stamped on the offset or transfer adjustment and on the corresponding bill segment or bill segment cancellation financial transaction. However, if a match event does not exist, a new match event is created and stamped on the offset or transfer adjustment and on the corresponding bill segment or bill segment cancellation financial transaction. In case of partial offset, the status of the corresponding match event is set to Open. However, if the entire match type entity amount is offset, the status of the corresponding match event is set to Balanced. For more information on how the offset amount is distributed, see C1-OFST-DIST on page 1567.</p>
<p>The Approval Required option is not selected in the respective offset request type and the number of financial transactions created for the bills (which are selected in the offset request) does not exceed the defer processing count (defined in the respective offset request type)</p>	<p>If the Transfer Adjustment option is selected in the respective offset request type, the system creates the transfer adjustments using the adjustment type which is specified in the offset request. The status of the transfer adjustments is set to Frozen. However, if the Transfer Adjustment option is not selected in the respective offset request type, the system creates the offset adjustments using the adjustment type which is specified in the offset request. The status of the offset adjustments is set to Frozen. Finally, the status of the offset request is changed to Processed.</p> <p>Note: If a match event exists for the match type entity (i.e. bill, bill segment, or contract), the existing match event is stamped on the offset or transfer adjustment and on the corresponding bill segment or bill segment cancellation financial transaction. However, if a match event does not exist, a new match event is created and stamped on the offset or transfer adjustment and on the corresponding bill segment or bill segment cancellation financial transaction. In case of partial offset, the status of the corresponding match event is set to Open. However, if the entire match type entity amount is offset, the status of the corresponding match event is set to Balanced. For more information on how the offset amount is distributed, see C1-OFST-DIST on page 1567.</p>

Note: The **Submit** button appears when the offset request is in the **Draft** status.

Related Topics

For more information on...	See...
How to search for an offset request	Searching for an Offset Request on page 1593
Offset Request screen	Offset Request (Used for Viewing) on page 1597
Offset Request zone	Offset Request on page 1597

Approving an Offset Request

You can view the number of offset requests which are pending for approval in the **Offset Request** screen. The approver can review, and accordingly approve or reject the offset request based on the observations.

Note: The system will not allow you to approve or reject an offset request submitted by you.

Prerequisites

To approve an offset request, you should have:

- Approval To Do role assigned in the system

Procedure

To approve an offset request:

1. Do either of the following:

If you want to...	Then...
Approve an offset request through the Offset Request screen	<ol style="list-style-type: none"> 1. Search for the offset request in the Offset Request screen. 2. In the Search Results section, click the link in the Offset Request Information column corresponding to the offset request which you want to review.
Approve an offset request through the To Do List screen	<ol style="list-style-type: none"> 1. Click the Menu link in the Application toolbar. A list appears. 2. From the Main menu, select To Do and then click To Do List. The To Do Type for User Search window appears. 3. Enter C1-OFSRQ in the To Do Type field. 4. Click the Search button corresponding to the To Do Type field. The To Do List screen appears. 5. Select the Open option from the Filter by list to view all unassigned To Dos. 6. Click the link in the Message column corresponding to the To Do of the offset request that you want to review.

The **Offset Request** screen appears.

2. Review the details in the **Offset Request** screen.
3. If the information in the offset request is accurate, click the **Approve** button in the **Offset Request** zone.

The system behaves in the following manner:

If...	Then
<p>The number of financial transactions created for the bills (which are selected in the offset request) exceeds the defer processing count (defined in the respective offset request type)</p>	<p>The status of the offset request is changed to Deferred Processing. On executing the Offset Request Periodic Monitor (C1-OFSRQ) batch, the system considers the offset requests which are in the Deferred Processing status. If the Transfer Adjustment option is selected in the respective offset request type, the system creates the transfer adjustments using the adjustment type which is specified in the offset request. The status of the transfer adjustments is set to Frozen. However, if the Transfer Adjustment option is not selected in the respective offset request type, the system creates the offset adjustments using the adjustment type which is specified in the offset request. The status of the offset adjustments is set to Frozen. Finally, the status of the offset request is changed to Processed.</p> <p>Note: If a match event exists for the match type entity (i.e. bill, bill segment, or contract), the existing match event is stamped on the offset or transfer adjustment and on the corresponding bill segment or bill segment cancelation financial transaction. However, if a match event does not exist, a new match event is created and stamped on the offset or transfer adjustment and on the corresponding bill segment or bill segment cancelation financial transaction. In case of partial offset, the status of the corresponding match event is set to Open. However, if the entire match type entity amount is offset, the status of the corresponding match event is set to Balanced. For more information on how the offset amount is distributed, see C1-OFST-DIST on page 1567.</p>

If...	Then
The number of financial transactions created for the bills (which are selected in the offset request) does not exceed the defer processing count (defined in the respective offset request type)	<p>If the Transfer Adjustment option is selected in the respective offset request type, the system creates the transfer adjustments using the adjustment type which is specified in the offset request. The status of the transfer adjustments is set to Frozen. However, if the Transfer Adjustment option is not selected in the respective offset request type, the system creates the offset adjustments using the adjustment type which is specified in the offset request. The status of the offset adjustments is set to Frozen. Finally, the status of the offset request is changed to Processed.</p> <p>Note: If a match event exists for the match type entity (i.e. bill, bill segment, or contract), the existing match event is stamped on the offset or transfer adjustment and on the corresponding bill segment or bill segment cancellation financial transaction. However, if a match event does not exist, a new match event is created and stamped on the offset or transfer adjustment and on the corresponding bill segment or bill segment cancellation financial transaction. In case of partial offset, the status of the corresponding match event is set to Open. However, if the entire match type entity amount is offset, the status of the corresponding match event is set to Balanced. For more information on how the offset amount is distributed, see C1-OFS-DIST on page 1567.</p>

Note: The **Approve** button appears when:

- The offset request is in the **Approval In Progress** status.
- A user with the approval To Do role is reviewing the offset request.

Related Topics

For more information on...	See...
How to search for an offset request	Searching for an Offset Request on page 1593
Offset Request screen	Offset Request (Used for Viewing) on page 1597
Offset Request zone	Offset Request on page 1597

Rejecting an Offset Request

Prerequisites

To reject an offset request, you should have:

- Reasons defined for the **Rejected** status of the **C1-OffsetRequest** business object in the **Status Reason** screen

Note: The system will not allow you to approve or reject an offset request submitted by you.

Procedure

To reject an offset request:

1. Do either of the following:

If you want to...	Then...
Reject an offset request through the Offset Request screen	<ol style="list-style-type: none"> 1. Search for the offset request in the Offset Request screen. 2. In the Search Results section, click the link in the Offset Request Information column corresponding to the offset request which you want to review.
Reject an offset request through the To Do List screen	<ol style="list-style-type: none"> 1. Click the Menu link in the Application toolbar. A list appears. 2. From the Main menu, select To Do and then click To Do List. The To Do Type for User Search window appears. 3. Enter C1-OFSRQ in the To Do Type field. 4. Click the Search button corresponding to the To Do Type field. The To Do List screen appears. 5. Select the Open option from the Filter by list to view all unassigned To Dos. 6. Click the link in the Message column corresponding to the To Do of the offset request that you want to review.

The **Offset Request** screen appears.

2. Review the details in the **Offset Request** screen.
3. If the information in the offset request is incorrect, click the **Reject** button in the **Offset Request** zone.

The **Reject Offset Request** window appears. It contains following fields:

Field Name	Field Description	Mandatory (Yes or No)
Status Reason	Used to indicate the reason why you want to reject the offset request.	Yes
Comments	Used to specify additional information while rejecting the offset request.	No

Note: The **Reject** button appears when:

- The offset request is in the **Approval In Progress** status.
- A user with the approval To Do role is reviewing the offset request.

4. Select the reason for rejecting the offset request from the **Status Reason** list.
5. Click **Save**.

The status of the offset request is changed to **Rejected**.

Related Topics

For more information on...	See...
How to search for an offset request	Searching for an Offset Request on page 1593

For more information on...	See...
Offset Request screen	Offset Request (Used for Viewing) on page 1597
Offset Request zone	Offset Request on page 1597

Unapplying an Offset Request

There might be situations when an incorrect offset request is processed in the system. In such case, the system provides you with an ability to unapply (i.e. cancel) the offset request. However, note that you can cancel an offset request when the offset request is in the **Processed** status.

Prerequisites

To cancel an offset request, you should have:

- Reasons defined for the **Unapplied Offset** status of the **C1-OffsetRequest** business object in the **Status Reason** screen

Procedure

To cancel an offset request:

- Search for the offset request in the **Offset Request** screen.
- In the **Search Results** section, click the link in the **Offset Request Information** column corresponding to the offset request that you want to cancel.

The **Offset Request** screen appears.

- Click the **Unapply** button in the **Offset Request** zone.

The **Unapply Reason** window appears. It contains the following fields:

Field Name	Field Description	Mandatory (Yes or No)
Unapply Reason	Used to indicate the reason why you want to cancel the offset request.	Yes
Comments	Used to specify additional information while canceling the offset request.	No

Note: The **Unapply** button appears when the offset request is in the **Processed** status.

- Select the reason for canceling the offset request from the **Unapply Reason** list.
- Click **Save**.

The system behaves in the following manner:

If...	Then...
The number of transfer or offset adjustments does not exceed the online record process limit (which is defined in the C1-DFRUNAPLY algorithm)	The system cancels the frozen transfer or offset adjustments immediately and then changes the status of the offset request to Unapplied Offset .

If...	Then...
The number of transfer or offset adjustments exceeds the online record process limit (which is defined in the C1-DFRUNAPLY algorithm)	The system changes the status of the offset request to Defer Unapplied . On executing the Offset Request Periodic Monitor (C1-OFSRQ) batch, the system considers the offset requests which are in the Defer Unapplied status. The system then cancels the frozen transfer or offset adjustments of the offset request and changes the status of the offset request to Unapplied Offset .

Related Topics

For more information on...	See...
How to search for an offset request	Searching for an Offset Request on page 1593
Offset Request screen	Offset Request (Used for Viewing) on page 1597
Offset Request zone	Offset Request on page 1597

Viewing the Log of an Offset Request

Procedure

To view the log of an offset request:

1. Search for the offset request in the **Offset Request** screen.
2. In the **Search Results** section, click the link in the **Offset Request Information** column corresponding to the offset request whose details you want to view.
The **Offset Request** screen appears.
3. Click the **Log** tab.
The **Log** tab appears.
4. View the complete trail of actions performed on the offset request in the **Offset Request Log** zone.

Related Topics

For more information on...	See...
How to search for an offset request	Searching for an Offset Request on page 1593
Offset Request screen	Offset Request (Used for Viewing) on page 1597
Offset Request Log zone	Offset Request Log on page 1606
How to add a log entry for an offset request	Adding a Log Entry for an Offset Request on page 1621

Adding a Log Entry for an Offset Request

Procedure

To add a log entry for an offset request:

1. Search for the offset request in the **Offset Request** screen.
2. In the **Search Results** section, click the link in the **Offset Request Information** column corresponding to the offset request for which you want to add a log entry.
The **Offset Request** screen appears.

3. Click the **Log** tab.

The **Log** tab appears.

4. Click the **Add Log Entry** link in the upper right corner of the **Offset Request Log** zone.

The **Add Request Log** window appears. It contains the following fields:

Field Name	Field Description	Mandatory (Yes or No)
Request Information	Displays information about the offset request.	Not applicable
Log Details	Used to specify additional comments for the offset request.	Yes

5. Enter the comments in the **Log Details** field.

6. Click **Save**.

The log entry is added in the **Offset Request Log** zone.

Related Topics

For more information on...	See...
How to search for an offset request	Searching for an Offset Request on page 1593
Offset Request screen	Offset Request (Used for Viewing) on page 1597
Offset Request Log zone	Offset Request Log on page 1606

Chapter 23

Funding Request

Topics:

- [Prerequisites](#)
- [Funding Request \(Without Approval\) Status Transition](#)
- [Funding Request \(With Approval\) Status Transition](#)
- [Algorithms Used in C1-FundingReq](#)
- [Funding Request Type](#)
- [Funding Request \(Used for Searching\)](#)
- [Funding Request \(Used for Viewing\)](#)

Oracle Revenue Management and Billing provides the automatic payment facility for an account. The system automatically calculates the automatic payment amount during the bill completion and stamps these details against the bill in the **CI_BILL_ACH** table. However, there might be situations when you would like to do the following before stamping the automatic payment amount against the bill in the **CI_BILL_ACH** table:

- Hold certain amount on the bill through a hold request
- Offset the bill against another bill through an offset request
- Transfer the amount on the credit bill to one or more garnishment contracts of the account

The system enables you to change the automatic payment amount through the funding process. The funding process supports all three automatic payment creation options (i.e. Create At Bill Completion, Create On Extract Date, and Freeze Payment on Notification).

While creating a funding request, you need to specify a funding request type using which you want to create the funding request. It is the funding request type which helps the system to determine:

- The business object using which the funding request should be created in the system.
- The currency in which the total debit and credit amount should be calculated.
- The account funding currency characteristic type which must be defined on the account. This characteristic indicates that the funding amount of the account's bills should be calculated in the specified currency.
- The default funding adjustment type using which the A/P adjustment should be created against a credit bill.

Note: In the **Default Funding Adjustment Type** field, you can only specify an adjustment type where the **A/P Request Type Code** field is set to **REFUND**.

- The default garnishment adjustment type using which the garnishment adjustment should be created when the amount from the credit bill is transferred to the garnishment contract of the account.

Note: In the **Default Garnishment Adjustment Type** field, you can only specify an adjustment type where the **A/P Request Type Code** field is not set to **REFUND**.

- Whether the approval is required for the funding request.

- An algorithm which helps to calculate the threshold range for a bill based on the number of payments made for the bill in the specified period.
- Whether a funding request must be processed in the deferred mode when the number of bills in the funding request exceeds the defer processing count.
- The currency conversion algorithms which must be used while determining the approval hierarchy for the funding request.

Note: The **Funding Request (C1-FundingReq)** business object is shipped with the product.

Once you specify a funding request type, the funding request is created in the **Draft** status. You can then add one or more debit or credit bills in the funding request. Note that you can only add bills of those accounts for which the **Defer Auto Pay** option is selected on the customer class. Once the bills are added, you can submit a funding request. Before you submit a funding request, you can do the following:

- Hold certain amount on the bill through a hold request
- Offset the bill against another bill through an offset request
- Transfer the amount on the credit bill to one or more garnishment contracts of the account

Note: The garnishment contract is a contract which is created using a contract type where the **Special Role Flag** field is set to **Garnishment**.

The system calculates the funding amount in the following manner:

Bill Type	Funding Amount for the Bill
Debit Bill	Outstanding Bill Amount – Hold Amount (set on the bill in a hold request) – Offset Amount (set on the bill in an offset request)
Credit Bill	Outstanding Bill Amount – Hold Amount (set on the bill in a hold request) – Offset Amount (set on the bill in an offset request) – Garnishment Amount (set on the bill in the funding request)

You can delete, cancel, or submit a funding request which is in the **Draft** status. On canceling a funding request, the status of all records in the funding request is changed to **Excluded** and the status of the funding request is changed to **Canceled**. On submitting a funding request, the status of the funding request is changed to either **Deferred Processing** or **Create Funding** depending on whether the number of bills in the funding request exceeds the defer processing count. Once the **Funding Request Periodic Monitor (C1-FNDRQ)** batch is executed, it checks whether there are any funding requests in the **Deferred Processing** status. If so, it changes the status of the funding request to **Create Funding**.

Once the status of a funding request is changed to **Create Funding**, the system creates the A/P adjustment against a bill when the funding amount of the bill is in credit. It also creates non A/P adjustments using the garnishment adjustment type when the funding amount of a credit bill is transferred to the garnishment contracts of the account. However, if the funding amount of a bill is in debit, the funding amount is stamped as the automatic payment amount against the bill in the **CI_BILL_ACH** table. Then, on executing the **Create Automatic**

Payments and Refunds (APAYCRET) batch, the system creates automatic payment and payment event for such bill.

You can optionally configure the approval process for the funding request. If the **Approval Required** option is selected in the funding request type, the status of the funding request is changed to **Approval In Progress** on submitting the funding request. The system calculates the sum of total debit and credit amount in the funding request. Depending on whether the sum total is debit or credit, the system uses the debit or credit hierarchy in the approval profile (which is specified in the funding request type), respectively. If the sum total is less than the minimum threshold amount, the system automatically approves the funding request and changes the status of the funding request to either **Deferred Processing** or **Create Funding** depending on whether the number of bills in the funding request exceeds the defer processing count. However, if the sum total is equal to or greater than the threshold amount specified at the first level in the approval hierarchy, the system creates a To Do using the To Do type specified in the approval profile and assigns it to the users with the To Do role defined at the first level in the approval hierarchy.

Once the approver at the first level in the approval hierarchy approves the funding request, the system checks whether the sum total of the debit and credit amount is equal to or greater than the threshold amount specified at the next level in the approval hierarchy. If the sum total of the debit and credit amount is equal to or greater than the threshold amount specified at the next level in the approval hierarchy, the system changes the status of the funding request to **Approval In Progress**. However, if the sum total of the debit and credit amount is less than the threshold amount specified at the next level in the approval hierarchy, the system changes the status of the funding request to either **Deferred Processing** or **Create Funding** depending on whether the number of bills in the funding request exceeds the defer processing count.

If an approver rejects a funding request, the status of the funding request is changed to **Rejected**. And, if an approver requests to resubmit a funding request for approval, the status of the funding request is changed to **Draft**. You can then edit the funding request and resubmit it for approval. The system allows the submitter to withdraw the funding request when it is in the **Approval In Progress** status. On withdrawing a funding request, the status of the funding request is changed to **Draft**.

If a funding request is created automatically through a custom batch, the system allows you to manually exclude some bills from the funding request when it is in the **Draft** status. You can exclude a bill from a funding request by changing its status to **Excluded**.

For more information on how to setup the funding request process, see [Prerequisites](#) on page 1626.

Prerequisites

To setup the funding request process, you need to do the following:

- Define the required funding request types in the system
- Define the required funding adjustment types where the **A/P Request Type Code** field is set to **REFUND**
- Define the required garnishment adjustment types where the **A/P Request Type Code** field is not set to **REFUND**
- Define the required characteristic types where the characteristic entity is set to **Funding Request Type**
- Define the required characteristic types where the characteristic entity is set to **Funding Request**
- Define the required approval profiles with the debit and credit approval hierarchy in the system
- Specify the **C1-FNDAP** To Do type in the approval profile which you want to use in the funding request's approval process
- Specify the **C1-FNDSB** as the submitter To Do type in the funding request types
- Define the status reasons for the **Rejected** status of the **C1-FundingRequest** business object in the **Status Reason** screen
- Assign the **C1-FNDAP** To Do type to a To Do role whose users must receive a To Do while submitting a funding request for approval
- Assign the **C1-FNDSB** To Do type to a To Do role whose users must receive a To Do when an approver requests to resubmit the funding request for approval
- Select the **Defer Auto Pay** option on the customer class of the accounts for which you want to use the funding process
- Define the values for the **CAN_RSN_CD_FLG** lookup field
- Define the **Funding Currency** characteristic type where the characteristic entity is set to **Account**
- Define a currency conversion algorithm for payments using the **C1_CURALGPY** algorithm type
- Define a currency conversion algorithm for adjustments using the **C1_CURALGAD** algorithm type
- Attach the currency conversion algorithms to the **Currency Conversion For Adjustments** and **Currency Conversion For Payments** algorithm spots to the required divisions
- Set the batch control type of the **Funding Request Periodic Monitor (C1-FNDRQ)** batch to **Timed** and define the following attributes:
 - Time Interval
 - Timer Active
 - User ID
 - Batch Language
 - Email Address

Funding Request (Without Approval) Status Transition

The following figure graphically indicates how a funding request moves from one status to another when the approval process is not configured in the funding request type:

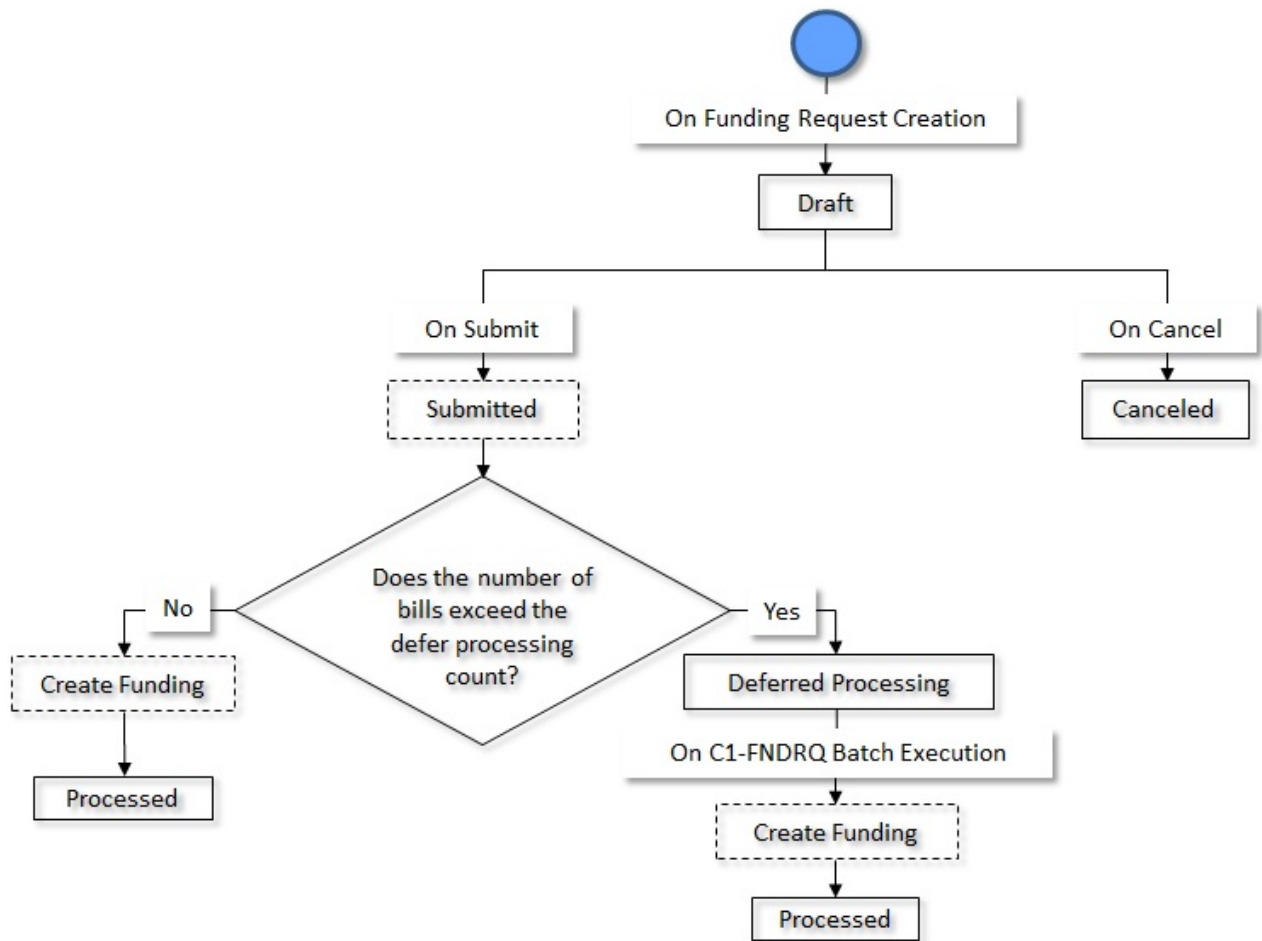

Funding Request (With Approval) Status Transition

The following figure graphically indicates how a funding request moves from one status to another when the approval process is configured in the funding request type:

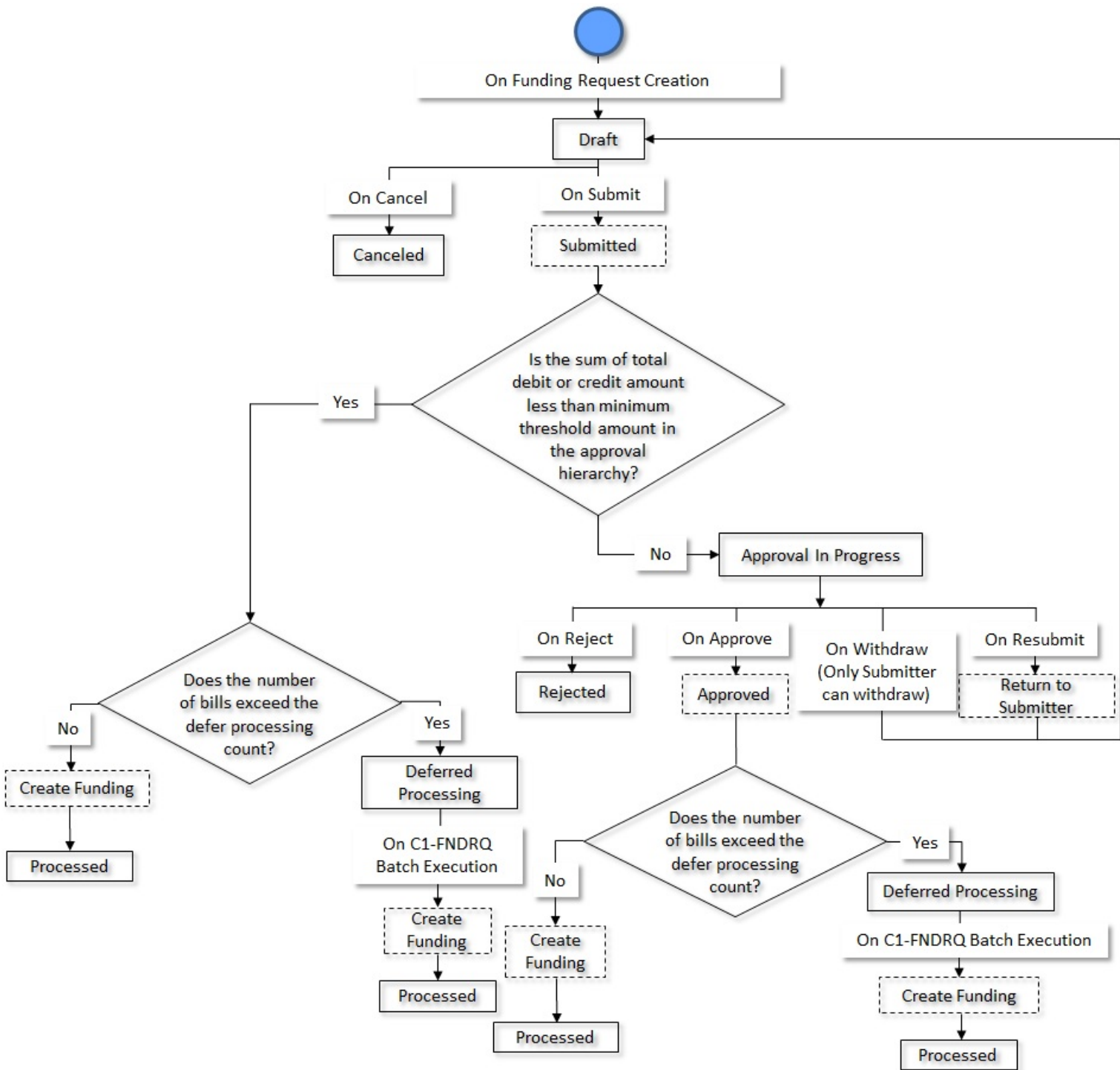

Algorithms Used in C1-FundingReq

The following table lists the algorithm which is attached to the **C1-FundingReq** business object:

System Event	Algorithm	Algorithm Type	Description
Information	C1-FUNDINFO	C1-FUNDINFO	Refer to C1-FUNDINFO on page 1629

The following table lists the algorithms which are used in the lifecycle of the **C1-FundingReq** business object:

Status	System Event	Algorithm	Algorithm Type	Description
Draft	Exit	F1-TODOCOMPL	F1-TODOCOMPL	Refer to F1-TODOCOMPL on page 1566
Submitted	Enter	C1-FUNDSUBMT	C1-FUNDSUBMT	Refer to C1-FUNDSUBMT on page 1629
Approval In Progress	Enter	C1-FUNDAPP	C1-FUNDAPP	Refer to C1-FUNDAPP on page 1630
Approval In Progress	Exit	F1-TODOCOMPL	F1-TODOCOMPL	Refer to F1-TODOCOMPL on page 1566
Approved	Enter	C1-FUNDAPRVD	C1-FUNDAPRVD	Refer to C1-FUNDAPRVD on page 1630
Rejected	-	-	-	-
Deferred Processing	Monitor	F1-AT-RQJ	F1-AT-RQJ	Refer to F1-AT-RQJ on page 1567
Return to Submitter	Enter	C1-FNDRESUBM	C1-FNDRESUBM	Refer to C1-FNDRESUBM on page 1631
Creating Funding	Monitor	F1-AT-RQJ	F1-AT-RQJ	Refer to F1-AT-RQJ on page 1567
Creating Funding	Enter	C1-FUNDVAL	C1-FUNDVAL	Refer to C1-FUNDVAL on page 1631
Creating Funding	Enter	C1-FUNDAPAY	C1-FUNDAPAY	Refer to C1-FUNDAPAY on page 1631
Creating Funding	Enter	C1-FUNDADJCR	C1-FUNDADJCR	Refer to C1-FUNDADJCR on page 1631
Processed	-	-	-	-
Canceled	Enter	C1-FUNDCANCL	C1-FUNDCANCL	Refer to C1-FUNDCANCL on page 1632

C1-FUNDINFO

This algorithm generates the funding request information string which appears throughout the application. It concatenates the following fields separated by a comma in the specified order:

1. Funding Request Type Description
2. Funding Request Status Description
3. Funding Request ID

C1-FUNDSUBMT

This algorithm is invoked when you submit a funding request. If the approval process is not configured in the funding request type, it changes the status of the funding request to either **Deferred Processing** or **Create Funding** depending on whether the number of bills in the funding request exceeds the defer processing count. If the approval process is configured in the funding request type, it calculates the sum of total debit and credit amount in the funding request. Depending on whether the sum total is debit or credit, it uses the debit or credit hierarchy in the approval profile (which is specified in the funding request type), respectively. If the sum total is less than the minimum threshold amount in the approval hierarchy, the funding request is automatically approved by the system and the status of the funding request is changed to either **Deferred Processing** or **Create Funding** depending on whether the number of bills in the funding

request exceeds the defer processing count. However, if the sum total is equal to or greater than the threshold amount specified at the first level in the approval hierarchy, the status of the funding request is changed to **Approval In Progress**.

Note: If the **Currency Conversion Required** option is selected in the approval profile, the system does currency conversion when the sum total of the debit and credit amount is in a currency which is different from the installation options currency. During the currency conversion of the sum total which is in debit, the system uses the currency conversion algorithm specified in the **Currency Conversion Payment Algorithm** field of the funding request type. However, during the currency conversion of the sum total which is in credit, the system uses the currency conversion algorithm specified in the **Currency Conversion Adjustment Algorithm** field of the funding request type.

C1-FUNDAPP

This algorithm is invoked when the status of the funding request is changed to **Approval In Progress**. It creates a To Do using the To Do type specified in the approval profile and assigns it to the users with the To Do role defined at the first level in the approval hierarchy. In addition, a log entry is created for the funding request when the To Do is created.

Note: If a funding request needs approval from the subsequent level in the approval hierarchy, this algorithm creates a To Do and assigns it to the users with the To Do role defined at the subsequent level in the approval hierarchy.

C1-FUNDAPRVD

This algorithm is invoked when you approve a funding request. It checks whether the sum total of the debit and credit amount is equal to or greater than the threshold amount specified at the next level in the approval hierarchy. If the sum total of the debit and credit amount is equal to or greater than the threshold amount specified at the next level in the approval hierarchy, the status of the funding request is changed to **Approval In Progress**. However, if the sum total of the debit and credit amount is less than the threshold amount specified at the next level in the approval hierarchy, the status of the funding request is changed to either **Deferred Processing** or **Create Funding** depending on whether the number of bills in the funding request exceeds the defer processing count.

Note: If the **Currency Conversion Required** option is selected in the approval profile, the system does currency conversion when the sum total of the debit and credit amount is in a currency which is different from the installation options currency. During the currency conversion of the sum total which is in debit, the system uses the currency conversion algorithm specified in the **Currency Conversion Payment Algorithm** field of the funding request type. However, during the currency conversion of the sum total which is in credit, the system uses the currency conversion algorithm specified in the **Currency Conversion Adjustment Algorithm** field of the funding request type.

F1-TODOCOMPL

This algorithm completes To Do entries that are created for the business object when the business object exits the given status. It finds and completes all open To Do entries where the business object's primary key is defined as a drill key. However, if the **Exclude To Do Entries From Auto Completion** characteristic is set to **Y** for the business object, the system does not automatically complete the respective To Do entry.

F1-AT-RQJ

This algorithm transitions the current status of the business object to the specified status. It contains the following parameters:

- **Next Status** – Used when you want to override the default next status specified in the lifecycle.
- **Next Transition Condition** – Used when you want to override the default next transition condition specified in the lifecycle.

At a time, you can specify value for either the **Next Status** or **Next Transition Condition** parameter. If you don't specify any value for these parameters, the system will transition the business object to the default next status specified in its lifecycle.

C1-FNDRESUBM

This algorithm is invoked when the status of the funding request is changed to **Return to Submitter**. It changes the status of the funding request to **Draft**. The submitter can then make the required changes and resubmit the funding request for approval. In addition, it creates a To Do using the submitter To Do type which is specified in the funding request type. Once a To Do is created, it is assigned to all users with a submitter To Do role which is specified in the funding request type.

C1-FUNDVAL

This algorithm is invoked when the status of the funding request is changed to **Create Funding**. It checks whether the funding amount of a debit bill is equal to the bill outstanding amount minus hold and offset amount set on the bill (i.e. $\text{Funding Amount} = \text{Outstanding Bill Amount} - \text{Hold Amount} - \text{Offset Amount}$). Similarly, it checks whether the funding amount of a credit bill is equal to the bill outstanding amount minus hold, offset, and garnishment amount set on the bill (i.e. $\text{Funding Amount} = \text{Outstanding Bill Amount} - \text{Hold Amount} - \text{Offset Amount} - \text{Garnishment Amount}$). If so, it executes the next algorithm. However, if the funding amount is incorrect, the status of the record in the funding request is changed to **Error**.

C1-FUNDAPAY

If the funding amount of a bill is in debit, it stamps the funding amount as the automatic payment amount against the bill in the **CI_BILL_ACH** table. Then, on executing the **Create Automatic Payments and Refunds (APAYCRET)** batch, the system creates automatic payment and payment event for such bill.

It considers the records in the funding request which are in the **Pending** status. Once the **CI_BILL_ACH** table is updated, the status of the record in the funding request is changed to **Processed**. If any error occurs while updating the **CI_BILL_ACH** table, the status of the record in the funding request is changed to **Error**.

C1-FUNDADJCR

If the funding amount of a bill is in credit, it creates the A/P adjustments using the funding adjustment type. It also creates non A/P adjustments using the garnishment adjustment type when the funding amount of a credit bill is transferred to the garnishment contracts of the account.

It considers the records in the funding request which are in the **Pending** status. Once the adjustments are created, the status of the record in the funding request is changed to **Processed**. If any error occurs while creating the adjustments, the status of the record in the funding request is changed to **Error**.

Points to Note:

- The system uses the funding and garnishment adjustment types from the funding request.
- The main customer's address is used while creating the A/P adjustment for a credit bill.
- The garnishment adjustments are created against the garnishment contracts of the account. A garnishment contract is a contract which is created using a contract type where the **Special Role Flag** field is set to **Garnishment**.
- The system allows you to transfer funding amount to multiple garnishment contracts of the account. Accordingly, the number of non A/P adjustments will be created using the garnishment adjustment type.

It contains the following parameters:

- **Adjustment Type** - Used to indicate the adjustment type using which the adjustment should be created against the credit bill for internal offsetting.
- **Match Type Entity Flag** - Used to indicate the match type entity on which a new match event must be created when no payment exists for the credit bill. The valid values are:
 - **BILL** - Used when you want to create the same match event on all financial transactions of a bill.
 - **BSEG** - Used when you want to create a unique match event for each bill line item (such as, bill segment or adjustment).

- **SA** - Used when you want to create the same match event on the bill line items which are created against the same contract.

C1-FUNDCANCL

This algorithm is invoked when you cancel a funding request. It excludes all debit and credit bills from the funding request and changes the status of each record in the funding request to **Excluded**. In addition, the status of the funding request is changed to **Canceled**.

Funding Request Type

Oracle Revenue Management and Billing allows you to define a funding request type using which you can create a funding request. It is the funding request type which helps the system to determine the following:

- The business object using which the funding request should be created in the system.
- The currency in which the funding amount should be calculated.
- The default funding adjustment type using which the A/P adjustment should be created against a credit bill on submitting the funding request.

Note: In the **Default Funding Adjustment Type** field, you can only specify an adjustment type where the **A/P Request Type Code** field is set to **REFUND**.

- The default garnishment adjustment type using which the garnishment adjustment should be created when the amount from the credit bill is moved to the garnishment contract of the account.

Note: In the **Default Garnishment Adjustment Type** field, you can only specify an adjustment type where the **A/P Request Type Code** field is not set to **REFUND**.

- Whether the approval is required for the funding request.
- An algorithm which helps to calculate the threshold range for a bill based on the number of payments made for the bill in the specified period.
- Whether a funding request must be processed in the deferred mode when the number of bills in the funding request exceeds the defer processing count.

The **Funding Request Type** screen allows you to define, edit, delete, and copy a funding request type. It contains the following zones:

- [Funding Request Type List](#) on page 1632
- [Funding Request Type](#) on page 1633

Funding Request Type List

The **Funding Request Type List** zone lists the funding request types that are already defined in the system. It contains the following columns:

Column Name	Column Description
Funding Request Type	Displays the funding request type.
Description	Displays the description of the funding request type.
Edit	On clicking the Edit (✎) icon, the Funding Request Type screen appears where you can edit the details of the funding request type.

Column Name	Column Description
Duplicate	On clicking the Duplicate (📄) icon, the Funding Request Type screen appears where you can define a new funding request type using an existing funding request type.
Delete	On clicking the Delete (🗑️) icon, you can delete the funding request type.
	Note: You can delete a funding request type when you have not created a funding request using the funding request type.

On clicking the **Broadcast** (📡) icon corresponding to a funding request type, the **Funding Request Type** zone appears with the details of the respective funding request type.

Related Topics

For more information on...	See...
How to edit a funding request type	Editing a Funding Request Type on page 1644
How to copy a funding request type	Copying a Funding Request Type on page 1652
How to delete a funding request type	Deleting a Funding Request Type on page 1651
How to view the details of a funding request type	Viewing the Funding Request Type Details on page 1659

Funding Request Type

The **Funding Request Type** zone displays the details of the funding request type. It contains of the following sections:

- **Main** - Displays the basic information about the funding request type. It contains the following fields:

Field Name	Field Description
Funding Request Type	Displays the funding request type.
Description	Displays the description of the funding request type.
Funding Request Business Object	Indicates the business object that will be used to create the funding request. In addition, a context menu appears corresponding to this field which helps in navigating to other screens in the application.
	Note: It has a link. On clicking the link, the Business Object screen appears where you can view the details of the respective business object.
Detailed Description	Displays additional information about the funding request type.
Status	Indicates the status of the funding request type. The valid values are: <ul style="list-style-type: none"> • Active • Inactive
Funding Amount Currency	Indicates the currency in which the total debit and credit amount should be calculated in the funding request. The total debit and credit amount appears in the Statistics section of the Funding Request zone.
Account Funding Currency Characteristic Type	Indicates the characteristic type which should be defined on the account. This characteristic indicates that the funding amount of the account's bills should be converted in the specified currency.

Field Name	Field Description
Default Funding Adjustment Type	Indicates the adjustment type using which the funding adjustments must be created.
	Note: It has a link. On clicking the link, the Adjustment Type screen appears where you can view the details of the respective adjustment type.
Default Garnishment Adjustment Type	Indicates the garnishment adjustment type using which the garnishment adjustments must be created.
	Note: It has a link. On clicking the link, the Adjustment Type screen appears with the details of the respective adjustment type.
Threshold Range Algorithm	Indicates the threshold range for a bill based on the payments done for the bill.
	Note: It has a link. On clicking the link, the Algorithm screen appears where you can view the details of the respective algorithm.
Defer Processing Count	Displays the number of bills to determine if the funding request will be processed in deferred mode.
	Note: If the number of bills is less than the Defer Processing Count , the funding request will be processed in real time (i.e. immediately).
Approval Required	Indicates whether approval is required while creating the funding adjustments using the funding request type.
Approval Profile	Indicates the approval profile which must be used to define approval hierarchy for the funding request type.
	Note: The Approval Profile field appears when the Approval Required check box is selected. It has a link. On clicking the link, the Approval Profile screen appears where you can view the details of the respective approval profile.
Submitter To Do Type	Indicates the To Do type for the submitter when the funding request type is resubmitted by the approver.
	Note: The Submitter To Do Type field appears when the Approval Required check box is selected. It has a link. On clicking the link, the To Do Type screen appears where you can view the details of the respective To Do type.

Field Name	Field Description
Submitter To Do Role	<p>Indicates the To Do role for the submitter when the funding request type is resubmitted by the approver.</p> <p>Note:</p> <p>The Submitter To Do Role field appears when the Approval Required check box is selected.</p> <p>It has a link. On clicking the link, the To Do Role screen appears where you can view the details of the respective To Do role.</p>
Currency Conversion Adjustment Algorithm	Indicates the currency conversion algorithm. It is used while determining the approval hierarchy for a funding request when the sum total of the debit and credit amount (i.e. which is in credit) is different from the installation options currency.
Currency Conversion Payment Algorithm	Indicates the currency conversion algorithm. It is used while determining the approval hierarchy for a funding request when the sum total of the debit and credit amount (i.e. which is in debit) is different from the installation options currency.

- **Characteristics** - The **Characteristics** section lists the characteristics of the funding request type. It contains the following columns:

Column Name	Column Description
Characteristic Type	Indicates the characteristic type.
Characteristic Value	Displays the value of the characteristic type.

- **Record Actions** - The **Record Actions** section contains the following buttons:

Button Name	Button Description
Edit	Used to edit the details of the funding request type.
Delete	<p>Used to delete the funding request type.</p> <p>Note: You can delete a funding request type when you have not created a funding request using the funding request type.</p>
Duplicate	Used to create a new funding request type using an existing funding request type.

- **Record Information** - The **Record Information** section contains the following fields:

Field Name	Field Description
Business Object	<p>Indicates the business object using which the funding request type is created. In addition, a context menu appears corresponding to this field which helps in navigating to other screens in the application.</p> <p>Note: It has a link. On clicking the link, the Business Object screen appears where you can view the details of the respective business object.</p>

By default, the **Funding Request Type** zone does not appear in the **Funding Request Type** screen. It appears when you click the **Broadcast** (📢) icon corresponding to the funding request type in the **Funding Request Type List** zone.

Related Topics

For more information on...	See...
How to define a funding request type	Defining a Characteristic for a Funding Request Type on page 1643
How to edit a funding request type	Editing a Funding Request Type on page 1644
How to copy a funding request type	Copying a Funding Request Type on page 1652
How to delete a funding request type	Deleting a Funding Request Type on page 1651
How to view the details of a funding request type	Viewing the Funding Request Type Details on page 1659

Defining a Funding Request Type**Prerequisites**

To define a funding request type, you should have:

- Funding request type business objects defined in the application
- Funding request business objects defined in the application
- Currencies defined in the application
- Funding adjustment types defined in the application (where the **A/P Request Type Code** field is set to **REFUND**)
- Garnishment adjustment types defined in the application (where the **A/P Request Type Code** field is not set to **REFUND**)
- A threshold range algorithm defined using the **C1-FDRTTR** algorithm type
- Required approval profiles defined in the application
- A To Do role assigned to the **C1-FNDSB** To Do type in the application
- Funding currency characteristic type defined in the application (where the characteristic entity is set to **Account**)
- A currency conversion algorithm defined for payments and adjustments using the **C1_CURALGPY** and **C1_CURALGAD** algorithm type, respectively

Procedure

To define a funding request type:

1. Click the **Admin** link in the **Application** toolbar.
A list appears.
2. From the **Admin** menu, select **F** and then click **Funding Request Type**.
A sub-menu appears.
3. Click the **Add** option from the **Funding Request Type** sub-menu.

The **Select Business Object** screen appears. It contains the following field:

Field Name	Field Description	Mandatory (Yes or No)
Funding Request Type Business Object	Used to indicate the business object using which you want to create the funding request type.	Yes

Tip: Alternatively, you can access the **Select Business Object** screen by clicking the **Add** button in the **Page Title** area of the **Funding Request Type** screen.

Note: The **Select Business Object** screen appears when there are multiple funding request type business objects defined in the application. If there is only one funding request type business object defined in the application, the **Funding Request Type** screen appears.

4. Select the required funding request type business object from the respective field.
5. Click **OK**.

The **Funding Request Type** screen appears. It contains the following sections:

- **Main** - Used to specify basic details about the funding request type.
- **Characteristics** - Used to define the characteristics for the funding request type.

The **Main** section contains the following fields:



Field Name	Field Description	Mandatory (Yes or No)
Funding Request Type	Used to specify the funding request type.	Yes
Business Object	Indicates the business object using which you are defining the funding request type.	Not applicable
Description	Used to specify the description for the funding request type.	Yes
Funding Request Business Object	Used to indicate the business object using which you want to create the funding request.	Yes
Detailed Description	Used to specify additional information about the funding request type.	No
Status	Used to indicate the status of the funding request type. The valid values are: <ul style="list-style-type: none"> • Active • Inactive 	Yes
	Note: You cannot change the status of a funding request type to Inactive when the corresponding funding request is in a status other than Processed or Rejected .	

Field Name	Field Description	Mandatory (Yes or No)
Funding Amount Currency	<p>Used to indicate the currency in which the total debit and credit amount should be calculated in the funding request. The total debit and credit amount appears in the Statistics section of the Funding Request zone.</p> <p>Note:</p> <p>The list includes only those currencies which are defined in the system.</p> <p>If the currency specified in this field is different from the bill's currency, the system does currency conversion before calculating the total debit and credit amount in the funding request. The total debit amount is the sum of funding amount of all bills whose funding amount is in debit. However, the total credit amount is the sum of funding amount and garnishment amount of all bills whose funding amount is in credit. While calculating the total debit amount, the system uses the currency conversion algorithm attached to the Currency Conversion For Payments algorithm spot of the account's division. However, while calculating the total credit amount, the system uses the currency conversion algorithm attached to the Currency Conversion For Adjustments algorithm spot of the account's division.</p>	Yes

Field Name	Field Description	Mandatory (Yes or No)
Account Funding Currency Characteristic Type	<p>Used to indicate the characteristic type. This characteristic should be defined on the account. This characteristic indicates that the funding amount of the account's bills should be converted in the specified currency.</p> <p>Note:</p> <p>The Search (🔍) icon appears corresponding to the Account Funding Currency Characteristic Type field. On clicking the Search icon, the Characteristic Type Search window appears.</p> <p>You must specify a characteristic type where the characteristic entity is set to Account.</p> <p>The converted amount appears in the Funding Currency Amount column of the Selected Bills zone in the Funding Request screen.</p> <p>If the funding amount is in debit, the system uses the currency conversion algorithm attached to the Currency Conversion For Payments algorithm spot of the account's division. However, if the funding amount is in credit, the system uses the currency conversion algorithm attached to the Currency Conversion For Adjustments algorithm spot of the account's division.</p>	Yes
Default Funding Adjustment Type	<p>Used to indicate the adjustment type using which the A/P adjustment should be created against a credit bill on submitting the funding request.</p> <p>Note:</p> <p>The Search (🔍) icon appears corresponding to the Default Funding Adjustment Type field. On clicking the Search icon, the Adjustment Type Search window appears.</p> <p>In the Default Funding Adjustment Type field, you can only specify an adjustment type where the A/P Request Type Code field is set to REFUND.</p>	Yes

Field Name	Field Description	Mandatory (Yes or No)
Default Garnishment Adjustment Type	<p>Used to indicate the adjustment type using which the garnishment adjustment should be created when the amount from the credit bill is transferred to the garnishment contract of the account.</p> <p>Note:</p> <p>The Search (🔍) icon appears corresponding to the Default Garnishment Adjustment Type field. On clicking the Search icon, the Adjustment Type Search window appears.</p> <p>In the Default Garnishment Adjustment Type field, you can only specify an adjustment type where the A/P Request Type Code field is not set to REFUND.</p>	Yes
Threshold Range Algorithm	<p>Used to attach an algorithm which helps to calculate the threshold range for a bill based on the number of payments made for the bill in the specified period.</p> <p>Note:</p> <p>You must specify an algorithm which is created using the C1-FDRTTR algorithm type in the Threshold Range Algorithm field.</p> <p>The Search (🔍) icon appears corresponding to the Threshold Range Algorithm field. On clicking the Search icon, the Algorithm Search window appears.</p>	No

Field Name	Field Description	Mandatory (Yes or No)
Defer Processing Count	<p>Used to indicate whether a funding request must be processed in the deferred mode (i.e. in the background) when the number of bills in the funding request exceeds the defer processing count.</p> <p>Note:</p> <p>You cannot specify a negative value in the Defer Processing Count field.</p> <p>Deferred mode means in the background when the Funding Request Periodic Monitor (C1-FNDRQ) batch is invoked. You can configure the Funding Request Periodic Monitor (C1-FNDRQ) batch such that it is executed at regular intervals. For more information about the Funding Request Periodic Monitor (C1-FNDRQ) batch, refer to <i>Oracle Revenue Management and Billing Batch Guide</i>.</p> <p>If the number of bills in a funding request does not exceed the defer processing count, the system will process the funding request in real time (i.e. immediately).</p>	No
Approval Required	Used to indicate whether the approval is required before creating payments for debit bills and A/P adjustments for credit bills through the funding request.	No
Approval Profile	<p>Used to indicate the approval profile using which the system should determine the debit or credit hierarchy level from where the approval is required. The system considers the debit or credit hierarchy level where the funding amount of the debit or credit bill falls within the threshold limit.</p> <p>Note: This field appears when the Approval Required option is selected.</p>	<p>Yes (Conditional)</p> <p>Note: This field is required when the Approval Required option is selected.</p>

Field Name	Field Description	Mandatory (Yes or No)
Submitter To Do Type	Used to indicate that To Do entry of the specified To Do type must be created when the approver rejects the funding request or raises the request for resubmitting the funding request.	Yes (Conditional)
	<p>Note:</p> <p>You must specify the C1-FNDSB To Do type in the Submitter To Do Type field.</p> <p>The Search  icon appears corresponding to the Submitter To Do Type field. On clicking the Search icon, the To Do Type Search window appears.</p> <p>This field appears when the Approval Required option is selected.</p>	<p>Note: This field is required when the Approval Required option is selected.</p>
Submitter To Do Role	Used to indicate that the users with the specified To Do role must receive a To Do when the approver rejects the funding request or raises the request for resubmitting the funding request.	Yes (Conditional)
	<p>Note:</p> <p>This field appears when the Approval Required option is selected.</p> <p>The list includes only those To Do roles which are associated to the specified submitter To Do type.</p>	<p>Note: This field is required when the Approval Required option is selected.</p>
Currency Conversion Adjustment Algorithm	Used to indicate the currency conversion algorithm. It is used while determining the approval hierarchy for a funding request when the sum total of the debit and credit amount (i.e. which is in credit) is different from the installation options currency.	Yes (Conditional)
	<p>Note:</p> <p>This field appears when the Approval Required option is selected.</p> <p>The Search  icon appears corresponding to the Currency Conversion Adjustment Algorithm field. On clicking the Search icon, the Algorithm Search window appears.</p>	<p>Note: This field is required when the Currency Conversion Required option is selected in the approval profile.</p>

Field Name	Field Description	Mandatory (Yes or No)
Currency Conversion Payment Algorithm	Used to indicate the currency conversion algorithm. It is used while determining the approval hierarchy for a funding request when the sum total of the debit and credit amount (i.e. which is in debit) is different from the installation options currency.	Yes (Conditional)
	<p>Note: This field is required when the Currency Conversion Required option is selected in the approval profile.</p> <p>Note: This field appears when the Approval Required option is selected.</p> <p>The Search  icon appears corresponding to the Currency Conversion Payment Algorithm field. On clicking the Search icon, the Algorithm Search window appears.</p>	

6. Enter the required details in the **Main** section.
7. Define characteristics for the funding request type, if required.
8. Click **Save**.

The funding request type is defined.

Related Topics

For more information on...	See...
Funding Request Type screen	Funding Request Type on page 1632
How to define a characteristic for a funding request type	Defining a Characteristic for a Funding Request Type on page 1643

Defining a Characteristic for a Funding Request Type

Prerequisites

To define a characteristic for a funding request type, you should have:

- Characteristic types defined in the application (where the characteristic entity is set to **Funding Request Type**)

Procedure

To define a characteristic for a funding request type:

1. Ensure that the **Characteristics** section is expanded when you are defining, editing, or copying a funding request type.

The **Characteristics** section contains the following fields in a grid:

Field Name	Field Description	Mandatory (Yes or No)
Characteristic Type	Used to indicate the characteristic type.	Yes (Conditional)
	Note: The list includes only those characteristic types where the characteristic entity is set to Funding Request Type .	Note: This field is required when you are defining a characteristic for the funding request type.
Characteristic Value	Used to specify the value for the characteristic type.	Yes (Conditional)
	Note: If you select a predefined characteristic type, the Search (🔍) icon appears corresponding to the Characteristic Value field. On clicking the Search icon, you can search for a predefined characteristic value. On specifying the value for a predefined characteristic type, the description of the characteristic value appears corresponding to the Characteristic Value field.	Note: This field is required when you are defining a characteristic for the funding request type.

- Enter the required details in the **Characteristics** section.
- If you want to define more than one characteristic for the funding request type, click the **Add** (+) icon and then repeat step 2.

Note: However, if you want to remove a characteristic from the funding request type, click the **Delete** (🗑️) icon corresponding to the characteristic.

Related Topics

For more information on...	See...
How to define a funding request type	Defining a Funding Request Type on page 1636
How to edit a funding request type	Editing a Funding Request Type on page 1644
How to copy a funding request type	Copying a Funding Request Type on page 1652

Editing a Funding Request Type

Prerequisites

To edit a funding request type, you should have:

- Funding request business objects defined in the application
- Currencies defined in the application
- Funding adjustment types defined in the application (where the **A/P Request Type Code** field is set to **REFUND**)

- Garnishment adjustment types defined in the application (where the **A/P Request Type Code** field is not set to **REFUND**)
- A threshold range algorithm defined using the **C1-FDRTTR** algorithm type
- Required approval profiles defined in the application
- A To Do role assigned to the **C1-FNDSB** To Do type in the application
- Funding currency characteristic type defined in the application (where the characteristic entity is set to **Account**)
- A currency conversion algorithm defined for payments and adjustments using the **C1_CURALGPY** and **C1_CURALGAD** algorithm type, respectively

Procedure

To edit a funding request type:

1. Click the **Admin** link in the **Application** toolbar.
A list appears.
2. From the **Admin** menu, select **F** and then click **Funding Request Type**.
A sub-menu appears.
3. Click the **Search** option from the **Funding Request Type** sub-menu.
The **Funding Request Type** screen appears.
4. In the **Funding Request Type List** zone, click the **Edit**  icon in the **Edit** column corresponding to the funding request type whose details you want to edit.



The **Funding Request Type** screen appears. It contains the following sections:



- **Main** - Used to specify basic details about the funding request type.
- **Characteristics** - Used to define the characteristics for the funding request type.

The **Main** section contains the following fields:



Field Name	Field Description	Mandatory (Yes or No)
Funding Request Type	Displays the funding request type.	Not applicable
Business Object	Indicates the business object using which you are defining the funding request type.	Not applicable
Description	Used to specify the description for the funding request type.	Yes
Funding Request Business Object	Used to indicate the business object using which you want to create the funding request.	Yes
Detailed Description	Used to specify additional information about the funding request type.	No

Field Name	Field Description	Mandatory (Yes or No)
Status	Used to indicate the status of the funding request type. The valid values are: <ul style="list-style-type: none"> • Active • Inactive 	Yes
	Note: You cannot change the status of a funding request type to Inactive when the corresponding funding request is in a status other than Processed or Rejected .	
Funding Amount Currency	Used to indicate the currency in which the total debit and credit amount should be calculated in the funding request. The total debit and credit amount appears in the Statistics section of the Funding Request zone. Note: <p>The list includes only those currencies which are defined in the system.</p> <p>If the currency specified in this field is different from the bill's currency, the system does currency conversion before calculating the total debit and credit amount in the funding request. The total debit amount is the sum of funding amount of all bills whose funding amount is in debit. However, the total credit amount is the sum of funding amount and garnishment amount of all bills whose funding amount is in credit. While calculating the total debit amount, the system uses the currency conversion algorithm attached to the Currency Conversion For Payments algorithm spot of the account's division. However, while calculating the total credit amount, the system uses the currency conversion algorithm attached to the Currency Conversion For Adjustments algorithm spot of the account's division.</p>	Yes

Field Name	Field Description	Mandatory (Yes or No)
Account Funding Currency Characteristic Type	<p>Used to indicate the characteristic type. This characteristic should be defined on the account. This characteristic indicates that the funding amount of the account's bills should be converted in the specified currency.</p> <p>Note:</p> <p>The Search  icon appears corresponding to the Account Funding Currency Characteristic Type field. On clicking the Search icon, the Characteristic Type Search window appears.</p> <p>You must specify a characteristic type where the characteristic entity is set to Account.</p> <p>The converted amount appears in the Funding Currency Amount column of the Selected Bills zone in the Funding Request screen.</p> <p>If the funding amount is in debit, the system uses the currency conversion algorithm attached to the Currency Conversion For Payments algorithm spot of the account's division. However, if the funding amount is in credit, the system uses the currency conversion algorithm attached to the Currency Conversion For Adjustments algorithm spot of the account's division.</p>	Yes
Default Funding Adjustment Type	<p>Used to indicate the adjustment type using which the A/P adjustment should be created against a credit bill on submitting the funding request.</p> <p>Note:</p> <p>The Search  icon appears corresponding to the Default Funding Adjustment Type field. On clicking the Search icon, the Adjustment Type Search window appears.</p> <p>In the Default Funding Adjustment Type field, you can only specify an adjustment type where the A/P Request Type Code field is set to REFUND.</p>	Yes

Field Name	Field Description	Mandatory (Yes or No)
Default Garnishment Adjustment Type	<p>Used to indicate the adjustment type using which the garnishment adjustment should be created when the amount from the credit bill is transferred to the garnishment contract of the account.</p> <p>Note:</p> <p>The Search  icon appears corresponding to the Default Garnishment Adjustment Type field. On clicking the Search icon, the Adjustment Type Search window appears.</p> <p>In the Default Garnishment Adjustment Type field, you can only specify an adjustment type where the A/P Request Type Code field is not set to REFUND.</p>	Yes
Threshold Range Algorithm	<p>Used to attach an algorithm which helps to calculate the threshold range for a bill based on the number of payments made for the bill in the specified period.</p> <p>Note:</p> <p>You must specify an algorithm which is created using the C1-FDRTTR algorithm type in the Threshold Range Algorithm field.</p> <p>The Search  icon appears corresponding to the Threshold Range Algorithm field. On clicking the Search icon, the Algorithm Search window appears.</p>	No

Field Name	Field Description	Mandatory (Yes or No)
Defer Processing Count	Used to indicate whether a funding request must be processed in the deferred mode (i.e. in the background) when the number of bills in the funding request exceeds the defer processing count.	No
	<p>Note:</p> <p>You cannot specify a negative value in the Defer Processing Count field.</p> <p>Deferred mode means in the background when the Funding Request Periodic Monitor (C1-FNDRQ) batch is invoked. You can configure the Funding Request Periodic Monitor (C1-FNDRQ) batch such that it is executed at regular intervals. For more information about the Funding Request Periodic Monitor (C1-FNDRQ) batch, refer to <i>Oracle Revenue Management and Billing Batch Guide</i>.</p> <p>If the number of bills in a funding request does not exceed the defer processing count, the system will process the funding request in real time (i.e. immediately).</p>	
Approval Required	Used to indicate whether the approval is required before creating payments for debit bills and A/P adjustments for credit bills through the funding request.	No
Approval Profile	Used to indicate the approval profile using which the system should determine the debit or credit hierarchy level from where the approval is required. The system considers the debit or credit hierarchy level where the funding amount of the debit or credit bill falls within the threshold limit.	Yes (Conditional)
	<p>Note: This field appears when the Approval Required option is selected.</p>	<p>Note: This field is required when the Approval Required option is selected.</p>

Field Name	Field Description	Mandatory (Yes or No)
Submitter To Do Type	Used to indicate that To Do entry of the specified To Do type must be created when the approver rejects the funding request or raises the request for resubmitting the funding request.	Yes (Conditional)
	<p>Note:</p> <p>You must specify the C1-FNDSB To Do type in the Submitter To Do Type field.</p> <p>The Search  icon appears corresponding to the Submitter To Do Type field. On clicking the Search icon, the To Do Type Search window appears.</p> <p>This field appears when the Approval Required option is selected.</p>	Note: This field is required when the Approval Required option is selected.
Submitter To Do Role	Used to indicate that the users with the specified To Do role must receive a To Do when the approver rejects the funding request or raises the request for resubmitting the funding request.	Yes (Conditional)
	<p>Note:</p> <p>This field appears when the Approval Required option is selected.</p> <p>The list includes only those To Do roles which are associated to the specified submitter To Do type.</p>	Note: This field is required when the Approval Required option is selected.
Currency Conversion Adjustment Algorithm	Used to indicate the currency conversion algorithm. It is used while determining the approval hierarchy for a funding request when the sum total of the debit and credit amount (i.e. which is in credit) is different from the installation options currency.	Yes (Conditional)
	<p>Note:</p> <p>This field appears when the Approval Required option is selected.</p> <p>The Search  icon appears corresponding to the Currency Conversion Adjustment Algorithm field. On clicking the Search icon, the Algorithm Search window appears.</p>	Note: This field is required when the Currency Conversion Required option is selected in the approval profile.

Field Name	Field Description	Mandatory (Yes or No)
Currency Conversion Payment Algorithm	Used to indicate the currency conversion algorithm. It is used while determining the approval hierarchy for a funding request when the sum total of the debit and credit amount (i.e. which is in debit) is different from the installation options currency.	Yes (Conditional)
	<p>Note:</p> <p>This field appears when the Approval Required option is selected.</p> <p>The Search  icon appears corresponding to the Currency Conversion Payment Algorithm field. On clicking the Search icon, the Algorithm Search window appears.</p>	<p>Note: This field is required when the Currency Conversion Required option is selected in the approval profile.</p>

Tip: Alternatively, you can edit the details of a funding request type by clicking the **Edit** button in the **Funding Request Type** zone.

5. Modify the details in the **Main** section, if required.
6. Define, edit, or remove characteristics of the funding request type, if required.
7. Click **Save**.

The changes made to the funding request type are saved.

Related Topics

For more information on...	See...
Funding Request Type screen	Funding Request Type on page 1632
Funding Request Type List zone	Funding Request Type List on page 1632
Funding Request Type zone	Funding Request Type on page 1633
How to define a characteristic for a funding request type	Defining a Characteristic for a Funding Request Type on page 1643

Deleting a Funding Request Type

Procedure

To delete a funding request type:

1. Click the **Admin** link in the **Application** toolbar.
A list appears.
2. From the **Admin** menu, select **F** and then click **Funding Request Type**.
A sub-menu appears.
3. Click the **Search** option from the **Funding Request Type** sub-menu.
The **Funding Request Type** screen appears.

- In the **Funding Request Type List** zone, click the **Delete** (🗑️) icon in the **Delete** column corresponding to the funding request type that you want to delete.

A message appears confirming whether you want to delete the funding request type.

Note: You can delete a funding request type when you have not created a funding request using the funding request type.

Tip: Alternatively, you can delete a funding request type by clicking the **Delete** button in the **Funding Request Type** zone.

- Click **OK**.

The funding request type is deleted.

Related Topics

For more information on...	See...
Funding Request Type screen	Funding Request Type on page 1632
Funding Request Type List zone	Funding Request Type List on page 1632
Funding Request Type zone	Funding Request Type on page 1633

Copying a Funding Request Type

Instead of creating a funding request type from scratch, you can create a new funding request type using an existing funding request type. This is possible through copying a funding request type. On copying a funding request type, the details including the characteristics are copied to the new funding request type. You can then edit the details, if required.

Prerequisites

To copy a funding request type, you should have:

- Funding request type (whose copy you want to create) defined in the application
- Funding request business objects defined in the application
- Currencies defined in the application
- Funding adjustment types defined in the application (where the **A/P Request Type Code** field is set to **REFUND**)
- Garnishment adjustment types defined in the application (where the **A/P Request Type Code** field is not set to **REFUND**)
- A threshold range algorithm defined using the **C1-FDRTTR** algorithm type
- Required approval profiles defined in the application
- A To Do role assigned to the **C1-FNDSB** To Do type in the application
- Funding currency characteristic type defined in the application (where the characteristic entity is set to **Account**)
- A currency conversion algorithm defined for payments and adjustments using the **C1_CURALGPY** and **C1_CURALGAD** algorithm type, respectively

Procedure

To copy a funding request type:

- Click the **Admin** link in the **Application** toolbar.
A list appears.
- From the **Admin** menu, select **F** and then click **Funding Request Type**.
A sub-menu appears.

3. Click the **Search** option from the **Funding Request Type** sub-menu.

The **Funding Request Type** screen appears.

4. In the **Funding Request Type List** zone, click the **Duplicate** () icon in the **Duplicate** column corresponding to the funding request type whose copy you want to create.

The **Funding Request Type** screen appears. It contains the following sections:

- **Main** - Used to specify basic details about the funding request type.
- **Characteristics** - Used to define the characteristics for the funding request type.

The **Main** section contains the following fields:



Field Name	Field Description	Mandatory (Yes or No)
Funding Request Type	Used to specify the funding request type.	Yes
Business Object	Indicates the business object using which you are defining the funding request type.	Not applicable
Description	Used to specify the description for the funding request type.	Yes
Funding Request Business Object	Used to indicate the business object using which you want to create the funding request.	Yes
Detailed Description	Used to specify additional information about the funding request type.	No
Status	Used to indicate the status of the funding request type. The valid values are: <ul style="list-style-type: none"> • Active • Inactive 	Yes
	Note: You cannot change the status of a funding request type to Inactive when the corresponding funding request is in a status other than Processed or Rejected .	

Field Name	Field Description	Mandatory (Yes or No)
Funding Amount Currency	<p data-bbox="695 212 1149 401">Used to indicate the currency in which the total debit and credit amount should be calculated in the funding request. The total debit and credit amount appears in the Statistics section of the Funding Request zone.</p> <p data-bbox="695 428 1149 1220">Note: The list includes only those currencies which are defined in the system. If the currency specified in this field is different from the bill's currency, the system does currency conversion before calculating the total debit and credit amount in the funding request. The total debit amount is the sum of funding amount of all bills whose funding amount is in debit. However, the total credit amount is the sum of funding amount and garnishment amount of all bills whose funding amount is in credit. While calculating the total debit amount, the system uses the currency conversion algorithm attached to the Currency Conversion For Payments algorithm spot of the account's division. However, while calculating the total credit amount, the system uses the currency conversion algorithm attached to the Currency Conversion For Adjustments algorithm spot of the account's division.</p>	Yes

Field Name	Field Description	Mandatory (Yes or No)
Account Funding Currency Characteristic Type	<p>Used to indicate the characteristic type. This characteristic should be defined on the account. This characteristic indicates that the funding amount of the account's bills should be converted in the specified currency.</p> <p>Note:</p> <p>The Search (🔍) icon appears corresponding to the Account Funding Currency Characteristic Type field. On clicking the Search icon, the Characteristic Type Search window appears.</p> <p>You must specify a characteristic type where the characteristic entity is set to Account.</p> <p>The converted amount appears in the Funding Currency Amount column of the Selected Bills zone in the Funding Request screen.</p> <p>If the funding amount is in debit, the system uses the currency conversion algorithm attached to the Currency Conversion For Payments algorithm spot of the account's division. However, if the funding amount is in credit, the system uses the currency conversion algorithm attached to the Currency Conversion For Adjustments algorithm spot of the account's division.</p>	Yes
Default Funding Adjustment Type	<p>Used to indicate the adjustment type using which the A/P adjustment should be created against a credit bill on submitting the funding request.</p> <p>Note:</p> <p>The Search (🔍) icon appears corresponding to the Default Funding Adjustment Type field. On clicking the Search icon, the Adjustment Type Search window appears.</p> <p>In the Default Funding Adjustment Type field, you can only specify an adjustment type where the A/P Request Type Code field is set to REFUND.</p>	Yes

Field Name	Field Description	Mandatory (Yes or No)
Default Garnishment Adjustment Type	<p>Used to indicate the adjustment type using which the garnishment adjustment should be created when the amount from the credit bill is transferred to the garnishment contract of the account.</p> <p>Note:</p> <p>The Search (🔍) icon appears corresponding to the Default Garnishment Adjustment Type field. On clicking the Search icon, the Adjustment Type Search window appears.</p> <p>In the Default Garnishment Adjustment Type field, you can only specify an adjustment type where the A/P Request Type Code field is not set to REFUND.</p>	Yes
Threshold Range Algorithm	<p>Used to attach an algorithm which helps to calculate the threshold range for a bill based on the number of payments made for the bill in the specified period.</p> <p>Note:</p> <p>You must specify an algorithm which is created using the C1-FDRTTR algorithm type in the Threshold Range Algorithm field.</p> <p>The Search (🔍) icon appears corresponding to the Threshold Range Algorithm field. On clicking the Search icon, the Algorithm Search window appears.</p>	No

Field Name	Field Description	Mandatory (Yes or No)
Defer Processing Count	Used to indicate whether a funding request must be processed in the deferred mode (i.e. in the background) when the number of bills in the funding request exceeds the defer processing count.	No
	<p>Note:</p> <p>You cannot specify a negative value in the Defer Processing Count field.</p> <p>Deferred mode means in the background when the Funding Request Periodic Monitor (C1-FNDRQ) batch is invoked. You can configure the Funding Request Periodic Monitor (C1-FNDRQ) batch such that it is executed at regular intervals. For more information about the Funding Request Periodic Monitor (C1-FNDRQ) batch, refer to <i>Oracle Revenue Management and Billing Batch Guide</i>.</p> <p>If the number of bills in a funding request does not exceed the defer processing count, the system will process the funding request in real time (i.e. immediately).</p>	
Approval Required	Used to indicate whether the approval is required before creating payments for debit bills and A/P adjustments for credit bills through the funding request.	No
Approval Profile	Used to indicate the approval profile using which the system should determine the debit or credit hierarchy level from where the approval is required. The system considers the debit or credit hierarchy level where the funding amount of the debit or credit bill falls within the threshold limit.	Yes (Conditional)
	<p>Note: This field appears when the Approval Required option is selected.</p>	<p>Note: This field is required when the Approval Required option is selected.</p>

Field Name	Field Description	Mandatory (Yes or No)
Submitter To Do Type	Used to indicate that To Do entry of the specified To Do type must be created when the approver rejects the funding request or raises the request for resubmitting the funding request.	Yes (Conditional)
	<p>Note:</p> <p>You must specify the C1-FNDSB To Do type in the Submitter To Do Type field.</p> <p>The Search  icon appears corresponding to the Submitter To Do Type field. On clicking the Search icon, the To Do Type Search window appears.</p> <p>This field appears when the Approval Required option is selected.</p>	<p>Note: This field is required when the Approval Required option is selected.</p>
Submitter To Do Role	Used to indicate that the users with the specified To Do role must receive a To Do when the approver rejects the funding request or raises the request for resubmitting the funding request.	Yes (Conditional)
	<p>Note:</p> <p>This field appears when the Approval Required option is selected.</p> <p>The list includes only those To Do roles which are associated to the specified submitter To Do type.</p>	<p>Note: This field is required when the Approval Required option is selected.</p>
Currency Conversion Adjustment Algorithm	Used to indicate the currency conversion algorithm. It is used while determining the approval hierarchy for a funding request when the sum total of the debit and credit amount (i.e. which is in credit) is different from the installation options currency.	Yes (Conditional)
	<p>Note:</p> <p>This field appears when the Approval Required option is selected.</p> <p>The Search  icon appears corresponding to the Currency Conversion Adjustment Algorithm field. On clicking the Search icon, the Algorithm Search window appears.</p>	<p>Note: This field is required when the Currency Conversion Required option is selected in the approval profile.</p>

Field Name	Field Description	Mandatory (Yes or No)
Currency Conversion Payment Algorithm	Used to indicate the currency conversion algorithm. It is used while determining the approval hierarchy for a funding request when the sum total of the debit and credit amount (i.e. which is in debit) is different from the installation options currency.	Yes (Conditional)
	<p>Note:</p> <p>This field appears when the Approval Required option is selected.</p> <p>The Search  icon appears corresponding to the Currency Conversion Payment Algorithm field. On clicking the Search icon, the Algorithm Search window appears.</p>	<p>Note: This field is required when the Currency Conversion Required option is selected in the approval profile.</p>

Tip: Alternatively, you can copy a funding request type by clicking the **Duplicate** button in the **Funding Request Type** zone.

5. Enter the required details in the **Main** section.
6. Define, edit, or remove characteristics of the funding request type, if required.
7. Click **Save**.

The new funding request type is defined.

Related Topics

For more information on...	See...
Funding Request Type screen	Funding Request Type on page 1632
Funding Request Type List zone	Funding Request Type List on page 1632
Funding Request Type zone	Funding Request Type on page 1633
How to define a characteristic for a funding request type	Defining a Characteristic for a Funding Request Type on page 1643

Viewing the Funding Request Type Details

Procedure

To view the details of a funding request type:

1. Click the **Admin** link in the **Application** toolbar.
A list appears.
2. From the **Admin** menu, select **F** and then click **Funding Request Type**.
A sub-menu appears.
3. Click the **Search** option from the **Funding Request Type** sub-menu.
The **Funding Request Type** screen appears.

- In the **Funding Request Type List** zone, click the **Broadcast** () icon corresponding to the funding request type whose details you want to view.

The **Funding Request Type** zone appears.

- View the details of the funding request type in the **Funding Request Type** zone.

Related Topics

For more information on...	See...
Funding Request Type screen	Funding Request Type on page 1632
Funding Request Type List zone	Funding Request Type List on page 1632
Funding Request Type zone	Funding Request Type on page 1633

Funding Request (Used for Searching)

The **Funding Request** screen allows you to search for a funding request using various search criteria. It also allows you to create a funding request. It contains the following zone:

- [Search Funding Request](#) on page 1660

Through this screen, you can navigate to the following screen:

- [Funding Request \(Used for Viewing\)](#) on page 1665

Search Funding Request

The **Search Funding Request** zone allows you to search for a funding request using various search criteria. It contains the following two sections:

- Search Criteria** - The **Search Criteria** section contains the following fields:

Field Name	Field Description	Mandatory (Yes or No)
Search By	Used to indicate whether you want to search for a funding request using the funding request or bill details. The valid values are: <ul style="list-style-type: none"> Request Details Bill Details 	Yes
	Note: By default, the Request Details option is selected.	
Created From	Used to search funding requests which are created from a particular date onwards.	No
	Note: This field appears when the Request Details option is selected from the Search By list.	

Field Name	Field Description	Mandatory (Yes or No)
Status	Used to search funding requests with a particular status. The valid values are: <ul style="list-style-type: none"> • Approval In Progress • Deferred Processing • Draft • Processed • Rejected 	No
	Note: This field appears when the Request Details option is selected from the Search By list.	
Created To	Used to search funding requests which are created till a particular date.	No
	Note: This field appears when the Request Details option is selected from the Search By list.	
User ID	Used to search funding requests which are created by a particular user.	No
	Note: This field appears when the Request Details option is selected from the Search By list.	
Funding Request Type	Used to search funding requests which are created using a particular funding request type.	No
	Note: This field appears when the Request Details option is selected from the Search By list.	
Person Name	Used to search funding requests which includes bills of a particular person.	No
	Note: This field appears when the Request Details option is selected from the Search By list.	
Funding Request ID	Used to search a particular funding request.	No
	Note: This field appears when the Request Details option is selected from the Search By list.	
Creation Mode	Used to search funding requests which are created in a particular mode. The valid values are: <ul style="list-style-type: none"> • Automatic • Manual 	No
	Note: This field appears when the Request Details option is selected from the Search By list.	

Field Name	Field Description	Mandatory (Yes or No)
Bill ID	Used to search funding requests which include a particular bill.	No
	<p>Note:</p> <p>This field appears when the Bill Details option is selected from the Search By list.</p> <p>The Search (🔍) icon appears corresponding to the Bill ID field. On clicking the Search icon, the Bill Search window appears.</p>	
Bill Date From	Used to search funding requests which include bills that are created from a particular date onwards.	No
	<p>Note: This field appears when the Bill Details option is selected from the Search By list.</p>	
Alternate Bill ID	Used to search funding requests which include a particular bill.	No
	<p>Note: This field appears when the Bill Details option is selected from the Search By list.</p>	
Bill Date To	Used to search funding requests which include bills that are created till a particular date.	No
	<p>Note: This field appears when the Bill Details option is selected from the Search By list.</p>	
Division	Used to search funding requests which includes bills of accounts which belong to a particular division.	No
	<p>Note:</p> <p>This field appears when the Bill Details option is selected from the Search By list.</p> <p>You can only view those divisions to which you have access in the Division list.</p>	

Note: You must specify at least one search criterion while searching for a funding request.

- **Search Results** - On clicking the **Search** button, the search results appear based on the specified search criteria. The **Search Results** section contains the following columns:

Column Name	Column Description
Create Date Time	Displays the date and time when the funding request is created.
Funding Request Information	Displays information about the funding request.
	<p>Note: It has a link. On clicking the link, the Funding Request screen appears where you can view the details of the respective funding request.</p>

Column Name	Column Description
Status	Indicates the status of the funding request. The valid values are: <ul style="list-style-type: none"> • Approval In Progress • Deferred Processing • Draft • Processed • Rejected
Total Debit Amount	Displays the total amount of the debit bills which are added in the funding request.
Total Credit Amount	Displays the total amount of the credit bills which are added in the funding request.
Created By	Indicates the user who has created the funding request.
Creation Mode	Indicates how the funding request is created. The valid values are: <ul style="list-style-type: none"> • Automatic • Manual

Note: Pagination is used to display limited number of records in the **Search Results** section. You can use the navigation links, such as **Previous** and **Next** to navigate between pages.

Related Topics

For more information on...	See...
How to search for a funding request	Searching for a Funding Request on page 1663

Searching for a Funding Request

Prerequisites

To search for a funding request, you should have:

- Funding request types defined in the application

Procedure

To search for a funding request:

1. Click the **Menu** link in the **Application** toolbar.
A list appears.
2. From the **Main** menu, select **Accounting and Receivable** and then click **Funding Request**.
A sub-menu appears.
3. Click the **Search** option from the **Funding Request** sub-menu.
The **Funding Request** screen appears.
4. Enter the search criteria in the **Search Funding Request** zone.

Note: ORMB search engine supports wildcard search, where you can substitute the percentage (%) symbol as a stand in for any word or letter in a search criteria. You can use the ‘%’ wildcard character in all input fields except the date and ID fields. The ‘%’ wildcard character is suffixed automatically at the end of the partial search criteria. Therefore, you may or may not specify the wildcard character at the end of the partial search criteria. However, you have to prefix the wildcard character manually wherever required.

5. Click **Search**.

A list of funding requests that meet the search criteria appears in the **Search Results** section.

Related Topics

For more information on...	See...
Funding Request screen	Funding Request (Used for Searching) on page 1660
Search Funding Request zone	Search Funding Request on page 1660

Creating a Funding Request

Prerequisites

To create a funding request, you should have:

- Funding request types defined in the application

Procedure

To create a funding request:

1. Click the **Menu** link in the **Application** toolbar.
A list appears.
2. From the **Main** menu, select **Accounting and Receivable** and then click **Funding Request**.
A sub-menu appears.
3. Click the **Add** option from the **Funding Request** sub-menu.

The **Add Funding Request** screen appears. It contains the following field:

Field Name	Field Description	Mandatory (Yes or No)
Funding Request Type	Used to indicate the funding request type using which you want to create the funding request.	Yes

Tip: Alternatively, you can access this screen by clicking the **Add** button in the **Page Title** area of the **Funding Request** screen.

4. Select the required funding request type from the respective field.
5. Click **OK**.

The funding request is created in the **Draft** status.

Related Topics

For more information on...	See...
Funding Request screen	Funding Request (Used for Searching) on page 1660
How to add a debit or credit bill to the funding request	Adding a Debit or Credit Bill to a Funding Request on page 1678
How to define a characteristic for a funding request	Defining a Characteristic for a Funding Request on page 1683

Viewing the Funding Request Details

Procedure

To view the details of a funding request:

1. Search for the funding request in the **Funding Request** screen.
2. In the **Search Results** section, click the link in the **Funding Request Information** column corresponding to the funding request whose details you want to view.

The **Funding Request** screen appears.

3. Ensure that the **Main** tab is selected.
4. View the details of the funding request in the **Funding Request** zone.
5. View the credit and/or debit bills added in the funding request in the **Selected Bills** zone.

Related Topics

For more information on...	See...
How to search for a funding request	Searching for a Funding Request on page 1663
Funding Request screen	Funding Request (Used for Viewing) on page 1665
Funding Request zone	Funding Request on page 1666
Selected Bills zone	Selected Bills on page 1673

Funding Request (Used for Viewing)

The **Funding Request** screen allows you to:

- Edit the details of a funding request
- Delete or cancel a funding request
- View the details of a funding request
- Submit a funding request for processing
- Approve or reject a funding request
- Request the submitter to resubmit a funding request for approval
- Withdraw a funding request
- View the log of a funding request
- Add a log entry for a funding request

It consists of the following tabs:

- [Funding Request - Main](#) on page 1665
- [Funding Request - Bills](#) on page 1673
- [Funding Request - Log](#) on page 1677

Funding Request - Main

The **Main** tab displays information about the funding request. It contains the following zones:

- [Funding Request](#) on page 1666
- [Search Bill](#) on page 1669

Funding Request

The **Funding Request** zone displays the details of the funding request. It contains the following sections:

- **Main** - Displays basic information about the funding request. It contains the following fields:

Field Name	Field Description
Funding Request Information	Displays information about the funding request.
Funding Request Type	Indicates the funding request type using which the funding request is created. Note: It has a link. On clicking the link, the Funding Request Type screen appears where you can view the details of the respective funding request type.
Status	Indicates the status of the funding request. The valid values are: <ul style="list-style-type: none"> • Approval In Progress • Deferred Processing • Draft • Processed • Rejected
Status Reason	Indicates the reason why the funding request is rejected. Note: This field appears when the funding request is in the Rejected status. It has a link. On clicking the link, the Status Reason screen appears where you can view the details of the respective status reason.
Funding Adjustment Type	Indicates the adjustment type using which the A/P adjustment is created against a credit bill. Note: It has a link. On clicking the link, the Adjustment Type screen appears where you can view the details of the respective adjustment type.
Garnishment Adjustment Type	Indicates the adjustment type using which the garnishment adjustment is created when the amount from the credit bill is transferred to the garnishment contract of the account. Note: It has a link. On clicking the link, the Adjustment Type screen appears where you can view the details of the respective adjustment type.
Comments	Displays additional information entered while rejecting the funding request. Note: This field appears when the funding request is in the Rejected status.
Creation Mode	Indicates whether the funding request is created automatically or manually. The valid values are: <ul style="list-style-type: none"> • Automatic • Manual

- **Statistics** - Displays analytical information about the funding request. It contains the following fields:

Field Name	Field Description
Total Records	Displays the total number of debit or credit bills which are added in the funding request.
Total Records Processed	Displays the total number of debit or credit bills for which payments or adjustments are successfully created in the system.
Total Records Excluded	Displays the total number of debit or credit bills which are excluded from the automatic funding request.
Total Records In Error	Displays the total number of debit or credit bills for which payments or adjustments was not successfully created in the system.
Total Payment Incoming Events Created	Displays the total number of payment events created against the debit bills in the funding request.
Total Adjustments Created	Displays the total number of adjustments created against the credit bills in the funding request.
Total Credit Funding Amount	<p>Displays the sum of funding amount and garnishment amount of all bills whose funding amount is in credit. The sum total is calculated in the funding amount currency which is specified in the funding request type.</p> <p>Note: If the credit bill's currency is different from the funding amount currency, the system does the currency conversion before calculating the sum total. The system uses the currency conversion algorithm attached to the Currency Conversion For Adjustments algorithm spot of the account's division.</p>
Total Debit Funding Amount	<p>Displays the sum of funding amount of all bills whose funding amount is in debit. The sum total is calculated in the funding amount currency which is specified in the funding request type.</p> <p>Note: If the debit bill's currency is different from the funding amount currency, the system does the currency conversion before calculating the sum total. The system uses the currency conversion algorithm attached to the Currency Conversion For Payments algorithm spot of the account's division.</p>

- **Record Actions** - This section contains the following buttons:

Button Name	Button Description
Edit	Used to edit the details of the funding request.
	Note: The Edit button appears when the funding request is in the Draft status.
Delete	Used to delete the funding request.
	Note: The Delete button appears when the funding request is in the Draft status.
Submit	Used to submit the funding request.
	Note: The Submit button appears when the funding request is in the Draft status.

Button Name	Button Description
Cancel	Used to cancel the funding request.
	Note: The Cancel button appears when the funding request is in the Draft status.
Approve	Used to approve the funding request.
	Note: The Approve button appears when: <ul style="list-style-type: none"> The funding request is in the Approval In Progress status. A user with the approval To Do role is reviewing the funding request.
Reject	Used to reject the funding request.
	Note: The Reject button appears when: <ul style="list-style-type: none"> The funding request is in the Approval In Progress status. A user with the approval To Do role is reviewing the funding request.
Re Submit	Used to request for resubmitting the funding request.
	Note: The Re Submit button appears when: <ul style="list-style-type: none"> The funding request is in the Approval In Progress status. A user with the approval To Do role is reviewing the funding request.
Withdraw	Used to withdraw the funding request.
	Note: The Withdraw button appears when: <ul style="list-style-type: none"> The funding request is in the Approval In Progress status. A user with the submitter To Do role is viewing the funding request.

- **Record Information** - This section contains the following fields:

Field Name	Field Description
Business Object	Indicates the business object using which the funding request is created. In addition, a context menu appears corresponding to this field which helps in navigating to other screens in the application.
	Note: It has a link. On clicking the link, the Business Object screen appears where you can view the details of the respective business object.
Status Date/Time	Displays the date and time when the funding request status is updated
Create Date/Time	Displays the date and time when the funding request is created.

- **Characteristics** - Lists the characteristics defined for the funding request. It contains the following columns:

Column Name	Column Description
Effective Date	Displays the date from when the characteristic is effective for the funding request.
Characteristic Type	Indicates the characteristic type.
Characteristic Value	Displays the value of the characteristic type.

Related Topics

For more information on...	See...
How to edit a funding request	Editing a Funding Request on page 1681
How to delete a funding request	Deleting a Funding Request on page 1684
How to submit a funding request	Submitting a Funding Request on page 1686
How to cancel a funding request	Cancelling a Funding Request on page 1685
How to approve a funding request	Approving a Funding Request on page 1688
How to reject a funding request	Rejecting a Funding Request on page 1690
How to request for resubmitting a funding request	Requesting to Resubmit a Funding Request on page 1692
How to withdraw a funding request	Withdrawing a Funding Request on page 1693

Search Bill

The **Search Bill** zone allows you to search for a bill using various search criteria. It appears when the funding request is in the **Draft** status and the creation mode is set to **Manual**. It contains the following two sections:

- **Search Criteria** - The **Search Criteria** section contains the following fields:

Field Name	Field Description	Mandatory (Yes or No)
Search By	Used to indicate whether you want to search for a bill using the person, account, or bill details. The valid values are: <ul style="list-style-type: none"> • Bill Details • Account Details • Person Details <p>Note: By default, the Bill Details option is selected.</p>	Yes
Bill ID	Used to search a particular bill. <p>Note: This field appears when the Bill Details option is selected from the Search By list.</p> <p>The Search (🔍) icon appears corresponding to the Bill ID field. On clicking the Search icon, the Bill Search window appears.</p>	No

Field Name	Field Description	Mandatory (Yes or No)
Bill Date From	Used to search bills which are created from a particular date onwards.	Yes
	<p>Note:</p> <p>This field appears when the Bill Details option is selected from the Search By list.</p> <p>By default, the current date appears in this field.</p>	
Alternate Bill ID	Used to search a particular bill.	No
	<p>Note: This field appears when the Bill Details option is selected from the Search By list.</p>	
Bill Date To	Used to search bills which are created till a particular date.	Yes
	<p>Note:</p> <p>This field appears when the Bill Details option is selected from the Search By list.</p> <p>By default, the current date appears in this field.</p>	
Bill Balance	Used to indicate whether you want to search bills with debit or credit balance. The valid values are:	No
	<ul style="list-style-type: none"> • Credit • Debit <p>Note: This field appears when the Bill Details option is selected from the Search By list.</p>	
Bill Due Date From	Used to search bills which are due from a particular date onwards.	No
	<p>Note: This field appears when the Bill Details option is selected from the Search By list.</p>	
Division	Used to search bills of accounts which belong to a particular division.	No
	<p>Note:</p> <p>You can only view those divisions to which you have access in the Division list.</p> <p>This field appears when the Bill Details option is selected from the Search By list.</p>	

Field Name	Field Description	Mandatory (Yes or No)
Bill Due Date To	Used to search bills which are due till a particular date.	No
	Note: This field appears when the Bill Details option is selected from the Search By list.	
Account ID	Used to search bills of a particular account.	Yes (Conditional)
	Note: This field appears when the Account Details option is selected from the Search By list.	Note: This field is required when the Account Details option is selected from the Search By list.
Person ID	Used to search bills which belong to a particular person.	Yes (Conditional)
	Note: This field appears when the Person Details option is selected from the Search By list.	Note: This field is required when: <ul style="list-style-type: none"> • The Person Details option is selected from the Search By list. • The person name is not specified in the search criteria.
Person Name	Used to search bills which are created for accounts of a particular person.	Yes (Conditional)
	Note: This field appears when the Person Details option is selected from the Search By list.	Note: This field is required when: <ul style="list-style-type: none"> • The Person Details option is selected from the Search By list. • The person ID is not specified in the search criteria.
Country	Used to search bills of persons who reside in a particular country.	No
	Note: This field appears when the Person Details option is selected from the Search By list.	

Note: You must specify at least one search criterion while searching for a bill.

- **Search Results** - On clicking the **Search** button, the search results appear based on the specified search criteria. The **Search Results** section contains the following columns:

Column Name	Column Description						
Bill Information	Displays additional information about the bill. In addition, this column has a context menu which helps in navigating to other screens in the application.						
	Note: It has a link. On clicking the link, the Bill screen appears where you can view the details of the respective bill.						
Due Date	Displays the date when the bill is due for payment.						
Outstanding Amount	Displays the unpaid amount of the bill.						
Hold Amount	Displays the amount of the bill which is kept on hold through a hold request.						
Funding Amount	Displays the bill amount which can be used for the funding process. It is calculated in the following manner:						
	<table border="1"> <thead> <tr> <th>Bill Type</th> <th>Funding Amount for the Bill</th> </tr> </thead> <tbody> <tr> <td>Debit Bill</td> <td>Outstanding Bill Amount – Hold Amount (set on the bill in a hold request) – Offset Amount (set on the bill in an offset request)</td> </tr> <tr> <td>Credit Bill</td> <td>Outstanding Bill Amount – Hold Amount (set on the bill in a hold request) – Offset Amount (set on the bill in an offset request) – Garnishment Amount (set on the bill in a funding request)</td> </tr> </tbody> </table>	Bill Type	Funding Amount for the Bill	Debit Bill	Outstanding Bill Amount – Hold Amount (set on the bill in a hold request) – Offset Amount (set on the bill in an offset request)	Credit Bill	Outstanding Bill Amount – Hold Amount (set on the bill in a hold request) – Offset Amount (set on the bill in an offset request) – Garnishment Amount (set on the bill in a funding request)
	Bill Type	Funding Amount for the Bill					
Debit Bill	Outstanding Bill Amount – Hold Amount (set on the bill in a hold request) – Offset Amount (set on the bill in an offset request)						
Credit Bill	Outstanding Bill Amount – Hold Amount (set on the bill in a hold request) – Offset Amount (set on the bill in an offset request) – Garnishment Amount (set on the bill in a funding request)						
Person Name	Indicates the person to whom the bill belongs. In addition, this column has a context menu which helps in navigating to other screens in the application.						
	Note: It has a link. On clicking the link, the Person screen appears where you can view the details of the respective person.						
Bill ID	Displays the bill ID.						
Defer Auto Pay	Indicates whether the Defer Auto Pay option is selected on the customer class of the account for which the bill is created. The valid values are: <ul style="list-style-type: none"> • N • Y 						

Note: Pagination is used to display limited number of records in the **Search Results** section. You can use the navigation links, such as **Previous** and **Next** to navigate between pages.

In addition, this section contains the following button:

Button Name	Button Description
Add	Used to add a bill to the funding request.

A check box appears corresponding to each bill. On selecting the check box, you can add the bill to the funding request. You can also select multiple bills at the same time. In addition, you can select the check box corresponding to the column header. This allows you to add all bills listed in the respective page to the funding request.

Related Topics

For more information on...	See...
How to add a debit or credit bill to a funding request	Adding a Debit or Credit Bill to a Funding Request on page 1678

Funding Request - Bills

The **Bills** tab lists the bills which are added in the funding request. It contains the following zones:

- [Currency Statistics](#) on page 1673
- [Selected Bills](#) on page 1673
- [Funding Payment Details](#) on page 1676

Note: This zone appears when the funding request is in the **Processed** status and the funding amount of the bill is in debit.

- [Funding Adjustments](#) on page 1677

Note: This zone appears when the funding request is in the **Processed** status and the funding amount of the bill is in credit.

Currency Statistics

A funding request might include bills in different currencies. The **Currency Statistics** zone lists the sum total of various amount of bills which are created in the same currency. It contains the following columns:

Column Name	Column Description
Currency Code	Indicates the currency in which the sum total is calculated.
	Note: Here, the system lists those currencies in which the bills added to the funding request are created.
Total Outstanding Amount	Displays the sum of outstanding amount of all bills which are created in the respective currency.
Total Hold Amount	Displays the sum of hold amount of all bills which are created in the respective currency.
Total Garnishment Amount	Displays the sum of garnishment amount of all bills which are created in the respective currency.
Total Debit Funding Amount	Displays the sum of funding amount (which is in debit) of all bills which are created in the respective currency.
Total Credit Funding Amount	Displays the sum of funding amount (which is in credit) of all bills which are created in the respective currency.

Selected Bills

The **Selected Bills** zone lists the debit and credit bills which are added to the funding request. It contains the following columns:

Column Name	Column Description
Bill Date	Displays the date when the bill is created.
Person Identifier	Displays the primary identifier of the person for whom the bill is created.
Person Country	Indicates the country where the person is located.

Column Name	Column Description						
Invoice Account Identifier	Displays the primary identifier of the account for which the bill is created.						
Funding Amount	<p>Displays the bill amount which can be used for the funding process. It is calculated in the following manner:</p> <table border="1"> <thead> <tr> <th>Bill Type</th> <th>Funding Amount for the Bill</th> </tr> </thead> <tbody> <tr> <td>Debit Bill</td> <td>Outstanding Bill Amount – Hold Amount (set on the bill in a hold request) – Offset Amount (set on the bill in an offset request)</td> </tr> <tr> <td>Credit Bill</td> <td>Outstanding Bill Amount – Hold Amount (set on the bill in a hold request) – Offset Amount (set on the bill in an offset request) – Garnishment Amount (set on the bill in a funding request)</td> </tr> </tbody> </table> <p>Note: The funding amount is calculated in the bill's currency.</p>	Bill Type	Funding Amount for the Bill	Debit Bill	Outstanding Bill Amount – Hold Amount (set on the bill in a hold request) – Offset Amount (set on the bill in an offset request)	Credit Bill	Outstanding Bill Amount – Hold Amount (set on the bill in a hold request) – Offset Amount (set on the bill in an offset request) – Garnishment Amount (set on the bill in a funding request)
Bill Type	Funding Amount for the Bill						
Debit Bill	Outstanding Bill Amount – Hold Amount (set on the bill in a hold request) – Offset Amount (set on the bill in an offset request)						
Credit Bill	Outstanding Bill Amount – Hold Amount (set on the bill in a hold request) – Offset Amount (set on the bill in an offset request) – Garnishment Amount (set on the bill in a funding request)						
Currency Code	Indicates the currency in which the funding amount is calculated.						
Hold Amount	Displays the amount of the bill which is kept on hold through a hold request.						
Offset Amount	Displays the amount of the bill which is offset against another bill through an offset request.						
Garnishment Amount	Displays the amount of the credit bill which is transferred to the garnishment contracts of the account through the funding request.						
Original Outstanding Amount	Displays the original outstanding amount when the bill was added in the funding request.						
Bill ID	<p>Displays the bill ID.</p> <p>Note: It has a link. On clicking the link, the Bill screen appears where you can view the details of the respective bill.</p>						
Open Bills	<p>Indicates whether there are any unpaid bills of the person. The valid values are:</p> <ul style="list-style-type: none"> • Y • N 						
Garnishment Contract	<p>Indicates whether the garnishment contract exists for the account. The valid values are:</p> <ul style="list-style-type: none"> • Y • N <p>Note:</p> <p>This column appears when the funding request is in the Draft status.</p> <p>The data appears in this column when a credit bill is added to the funding request.</p> <p>It has a link. On clicking the link, the Edit Garnishment Details screen appears where you can transfer the funding amount from the credit bill to one or more garnishment contracts of the account.</p>						

Column Name	Column Description
Garnishment	<p>On clicking the View (🔗) icon, the View Garnishment Details screen appears where you can view the funding amount transferred to the different garnishment contracts of the account.</p> <p>Note: This column does not appear when the funding request is in the Draft status. The View (🔗) icon appears in this column when the funding request is in the Processed status.</p>
Record Status	<p>Indicates the status of the bill record in the funding request. The valid values are:</p> <ul style="list-style-type: none"> • Excluded • Invalid • Masked • Pending • Processed • Valid • Error
Threshold Range	Indicates the threshold range for a bill which is calculated based on the number of payments made for the bill in the specified period.
Person Name	Indicates the person whose bill is added in the funding request.
Bill Information	Displays the information about the bill.
Split Banking	<p>Indicates whether the split automatic payment feature is used for the account. The valid values are:</p> <ul style="list-style-type: none"> • Y • N
Funding Currency Amount	Displays the funding amount which is converted in the funding currency defined on the account.

Note: Pagination is used to display limited number of records in the **Search Results** section. You can use the navigation links, such as **Previous** and **Next** to navigate between pages.

In addition, this section contains the following button:

Button Name	Button Description
Delete	Used to delete a bill from the funding request.
	Note: The Delete button appears when the funding request is created manually and it is in the Draft status.

Button Name	Button Description
Edit	Used to exclude a debit or credit bill from the funding request.
	Note: The Edit button appears when the funding request is created automatically and it is in the Draft status.
Hold	Used to create a hold request for one or more bills. However, you cannot select more than 20 bills. On activating or releasing a hold request, the funding amount is automatically updated in the funding request.
	Note: The Hold button appears only when the funding request is in the Draft status.
Offset	Used to create an offset request for a bill. On processing or unapplying an offset request, the funding amount is automatically updated in the funding request.
	Note: The Offset button appears when the funding request is in the Draft status.

A check box appears corresponding to each bill when the funding request is in the **Draft** status. On selecting the check box, you can delete the bill from the funding request. You can also select multiple bills at the same time. In addition, you can select the check box corresponding to the column header. This allows you to delete all bills listed in the respective page from the funding request.

On clicking the **Broadcast** () icon corresponding to a debit or credit bill, the **Funding Payment Details** or **Funding Adjustments** zone appears, respectively.

Note: The **Broadcast** icon does not appear when the funding request is in the **Draft** status.

You can filter the list using various search criteria (such as, **Bill ID**, **Alternate Bill ID**, **Record Status**, **Bill Balance**, **Funding Amount From**, **Person ID**, **Funding Amount To**, **Currency**, **Funding Amount Threshold Range**, and **Country**) available in the **Filter** area. By default, the **Filter** area is hidden. You can view the **Filter** area by clicking the **Filters** () icon in the upper right corner of this zone.

Related Topics

For more information on...	See...
How to delete a debit or credit bill from a funding request	Deleting a Debit or Credit Bill from a Funding Request on page 1679
Funding Payment Details zone	Funding Payment Details on page 1676
Funding Adjustments zone	Funding Adjustments on page 1677
How to transfer the funding amount of a credit bill to a garnishment contract	Transferring the Funding Amount of a Credit Bill to a Garnishment Contract on page 1694
How to view the garnishment details of a credit bill	Viewing the Garnishment Details of a Credit Bill on page 1695
How to exclude a debit or credit bill from a funding request	Excluding a Bill from a Funding Request on page 1679

Funding Payment Details

The **Funding Payment Details** zone lists the payment events which are created for a debit bill through the funding request. It appears when the funding request is in the **Processed** status. It contains the following columns:

Column Name	Column Description
Payment Event Information	Displays information about the payment event.
	Note: It has a link. On clicking the link, the Payment Event screen appears where you can view the details of the respective payment event.
Payment Amount	Displays the amount for which automatic payment is created.

Note: Pagination is used to display limited number of records in the **Search Results** section. You can use the navigation links, such as **Previous** and **Next** to navigate between pages.

Funding Adjustments

The **Funding Adjustments** zone lists the funding and garnishment adjustments which are created for a credit bill through the funding request. It appears when the funding request is in the **Processed** status. It contains the following columns:

Column Name	Column Description
Adjustment Information	Displays information about the funding or garnishment adjustment.
	Note: It has a link. On clicking the link, the Adjustment screen appears where you can view the details of the respective adjustment.
Adjustment Amount	Displays the adjustment amount.

Note: Pagination is used to display limited number of records in the **Search Results** section. You can use the navigation links, such as **Previous** and **Next** to navigate between pages.

Funding Request - Log

The **Log** tab contains the following zone:

- [Funding Request Log](#) on page 1677

Funding Request Log

The **Funding Request Log** zone lists the complete trail of actions performed on the funding request. It contains the following columns:

Column Name	Column Description
Date/Time	Displays the date and time when the action was performed on the funding request.
Details	Displays the details of the action performed on the funding request.
User	Indicates the user who has performed the action on the funding request.
Log Type	Indicates the type of log.
Related Object	Indicates the object or entity which is created when the action is performed on the funding request.
	Note: At present, no data appears in this column. The implementation team can build the custom logic to meet the business requirements.

Column Name	Column Description
Status Reason	Indicates the reason why the funding request was rejected by the approver.
	Note: The data appears in this column when the funding request is in the Rejected status.

Note: You can manually add a log entry for the funding request by clicking the **Add Log Entry** link in the upper right corner of the **Funding Request Log** zone.

Related Topics

For more information on...	See...
How to view the log of a funding request	Viewing the Log of a Funding Request on page 1697
How to add a log entry for a funding request	Adding a Log Entry for a Funding Request on page 1698

Adding a Debit or Credit Bill to a Funding Request

In a funding request, you can only add the debit or credit bills of the accounts for which the **Defer Auto Pay** option is selected on the respective customer class.

Procedure

To add a debit or credit bill to a funding request:

1. Search for the funding request in the **Funding Request** screen.
2. In the **Search Results** section, click the link in the **Funding Request Information** column corresponding to the funding request whose details you want to edit.

The **Funding Request** screen appears.

3. Ensure that the **Main** tab is selected.
4. Enter the search criteria in the **Search Bill** zone.

Note:

The **Search Bill** zone appears when the funding request is in the **Draft** status.

ORMB search engine supports wildcard search, where you can substitute the percentage (%) symbol as a stand in for any word or letter in a search criteria. You can use the ‘%’ wildcard character in all input fields except the date and ID fields. The ‘%’ wildcard character is suffixed automatically at the end of the partial search criteria. Therefore, you may or may not specify the wildcard character at the end of the partial search criteria. However, you have to prefix the wildcard character manually wherever required.

5. Click **Search**.

A list of bills that meet the search criteria appears in the **Search Results** section.

6. Select the check box corresponding to a bill that you want to add to the funding request.
7. Click the **Add** button in the **Search Bill** zone.

A message appears indicating that the bill is added to the funding request.

Note: You can only add a debit or credit bill of an account for which the **Defer Auto Pay** option is selected on the respective customer class.

8. Click **OK**.

The bill is added to the funding request. The status of the bill record in the funding request is set to **Pending**.

Related Topics

For more information on...	See...
How to search for a funding request	Searching for a Funding Request on page 1663
Funding Request screen	Funding Request (Used for Viewing) on page 1665
Search Bill zone	Search Bill on page 1669
How to create a funding request	Creating a Funding Request on page 1664

Deleting a Debit or Credit Bill from a Funding Request

Procedure

To delete a debit or credit bill from a funding request:

1. Search for the funding request in the **Funding Request** screen.
2. In the **Search Results** section, click the link in the **Funding Request Information** column corresponding to the funding request whose details you want to edit.

The **Funding Request** screen appears.

3. Click the **Bills** tab.

The **Bills** tab appears.

4. In the **Selected Bills** zone, select the check box corresponding to a bill that you want to delete from the funding request.

5. Click the **Delete** button in the **Selected Bills** zone.

A message appears confirming whether you want to delete the bill from the funding request.

Note: The **Delete** button appears when the funding request is in the **Draft** status.

6. Click **OK**.

The debit or credit bill is deleted from the funding request.

Related Topics

For more information on...	See...
How to search for a funding request	Searching for a Funding Request on page 1663
Funding Request screen	Funding Request (Used for Viewing) on page 1665
Selected Bills zone	Selected Bills on page 1673

Excluding a Bill from a Funding Request

If the funding request is manually created through the user interface, you add or delete bills from the funding request when it is in the **Draft** status. However, if the funding request is automatically created through a custom logic, the system allows you to exclude the required bills from the funding request when it is in the **Draft** status. In such case, the status of the record in the funding request is changed to **Excluded**. The excluded bills can then be included in some other funding request.

Prerequisites

To exclude a bill from a funding request, you should have:

- Values defined for the **CAN_RSN_CD_FLG** lookup field

Procedure

To exclude a bill from a funding request:

1. Search for the funding request in the **Funding Request** screen.
2. In the **Search Results** section, click the link in the **Funding Request Information** column corresponding to the funding request whose details you want to edit.

The **Funding Request** screen appears.

3. Click the **Bills** tab.

The **Bills** tab appears.

4. In the **Selected Bills** zone, select the check box corresponding to a bill that you want to exclude from the funding request.

5. Click the **Edit** button in the **Selected Bills** zone.

The **Edit Funding Request Details** screen appears. It contains the following field:

Field Name	Field Description
Funding Request Information	Displays the information about the funding request.

In addition, this screen contains the following fields in a grid:

Field Name	Field Description	Mandatory (Yes or No)						
Bill Information	Displays the information about the bill.	Not applicable						
Garnishment Amount	Displays the funding amount which is transferred to the garnishment contracts of the account.	Not applicable						
Funding Amount	<p>Displays the bill amount which can be used for the funding process. It is calculated in the following manner:</p> <table border="1"> <thead> <tr> <th>Bill Type</th> <th>Funding Amount for the Bill</th> </tr> </thead> <tbody> <tr> <td>Debit Bill</td> <td>Outstanding Bill Amount – Hold Amount (set on the bill in a hold request) – Offset Amount (set on the bill in an offset request)</td> </tr> <tr> <td>Credit Bill</td> <td>Outstanding Bill Amount – Hold Amount (set on the bill in a hold request) – Offset Amount (set on the bill in an offset request) – Garnishment Amount (set on the bill in a funding request)</td> </tr> </tbody> </table>	Bill Type	Funding Amount for the Bill	Debit Bill	Outstanding Bill Amount – Hold Amount (set on the bill in a hold request) – Offset Amount (set on the bill in an offset request)	Credit Bill	Outstanding Bill Amount – Hold Amount (set on the bill in a hold request) – Offset Amount (set on the bill in an offset request) – Garnishment Amount (set on the bill in a funding request)	Not applicable
Bill Type	Funding Amount for the Bill							
Debit Bill	Outstanding Bill Amount – Hold Amount (set on the bill in a hold request) – Offset Amount (set on the bill in an offset request)							
Credit Bill	Outstanding Bill Amount – Hold Amount (set on the bill in a hold request) – Offset Amount (set on the bill in an offset request) – Garnishment Amount (set on the bill in a funding request)							

Field Name	Field Description	Mandatory (Yes or No)
Status	Used to indicate the status of the record in the funding request. The valid values are: <ul style="list-style-type: none"> Excluded Invalid Masked Pending Processed Valid 	Yes
Cancel Reason	Used to indicate the reason why you want to exclude the bill from the funding request.	Yes (Conditional)
	Note: The list includes only those values which are defined in the CAN_RSN_CD_FLG lookup field.	Note: This field is required when you want to exclude the bill from the funding request.

Note: The **Edit** button appears when the creation mode of the funding request is set to **Automatic** and the funding request is in the **Draft** status.

6. Select the **Excluded** option from the **Status** field.
7. Select the required cancel reason from the respective field.
8. Click **Save**.

The bill is excluded from the funding request. The status of the bill record in the funding request is set to **Excluded**.

Related Topics

For more information on...	See...
How to search for a funding request	Searching for a Funding Request on page 1663
Funding Request screen	Funding Request (Used for Viewing) on page 1665
Selected Bills zone	Selected Bills on page 1673

Editing a Funding Request

Prerequisites

To edit a funding request, you should have:

- Funding adjustment types defined in the application (where the **A/P Request Type Code** field is set to **REFUND**)
- Garnishment adjustment types defined in the application (where the **A/P Request Type Code** field is not set to **REFUND**)

Procedure

To edit a funding request:

1. Search for the funding request in the **Funding Request** screen.
2. In the **Search Results** section, click the link in the **Funding Request Information** column corresponding to the funding request whose details you want to edit.

The **Funding Request** screen appears.

3. Click the **Edit** button in the **Funding Request** zone.

The **Edit Funding Request** screen appears. It contains the following sections:

- **Main** - Used to specify basic details about the funding request.
- **Characteristics** - Used to define the characteristics for the funding request.

The **Main** section contains the following fields:

Field Name	Field Description	Mandatory (Yes or No)
Funding Request Information	Displays information about the funding request.	Not applicable
Funding Adjustment Type	Used to indicate the adjustment type using which the A/P adjustment should be created against a credit bill. Note: The Search (🔍) icon appears corresponding to the Funding Adjustment Type field. On clicking the Search icon, the Adjustment Type Search window appears. In the Funding Adjustment Type field, you can only specify an adjustment type where the A/P Request Type Code field is set to REFUND .	Yes (Conditional) Note: This field is required while creating an A/P adjustment against a credit bill.
Garnishment Adjustment Type	Used to indicate the adjustment type using which the garnishment adjustment should be created when the amount from the credit bill is transferred to the garnishment contract of the account. Note: The Search (🔍) icon appears corresponding to the Garnishment Adjustment Type field. On clicking the Search icon, the Adjustment Type Search window appears. In the Garnishment Adjustment Type field, you can only specify an adjustment type where the A/P Request Type Code field is not set to REFUND .	Yes (Conditional) Note: This field is required while creating garnishment adjustments for a credit bill.
Comments	Used to specify additional information about the funding request.	No

Note: The **Edit** button appears when the funding request is in the **Draft** status.

4. Modify the details of the funding request, if required.
5. Define, edit, or remove characteristics of the funding request, if required.

6. Click **Save**.

The changes made to the funding request are saved.

Related Topics

For more information on...	See...
How to search for a funding request	Searching for a Funding Request on page 1663
Funding Request screen	Funding Request (Used for Viewing) on page 1665
Funding Request zone	Funding Request on page 1666
How to define a characteristic for a funding request	Defining a Characteristic for a Funding Request on page 1683

Defining a Characteristic for a Funding Request

Prerequisites

To define a characteristic for a funding request, you should have:

- Characteristic types defined in the application (where the characteristic entity is set to **Funding Request**)

Procedure

To define a characteristic for a funding request:

1. Ensure that the **Characteristics** section is expanded when you are editing a funding request.

The **Characteristics** section contains the following fields in a grid:

Field Name	Field Description	Mandatory (Yes or No)
Effective Date	Used to specify the date from when the characteristic is effective for the funding request.	Yes (Conditional)
		Note: This field is required when you are defining a characteristic for the funding request.
Characteristic Type	Used to indicate the characteristic type. Note: The list includes only those characteristic types where the characteristic entity is set to Funding Request .	Yes (Conditional)
		Note: This field is required when you are defining a characteristic for the funding request.

Field Name	Field Description	Mandatory (Yes or No)
Characteristic Value	Used to specify the value for the characteristic type.	Yes (Conditional)
	<p>Note:</p> <p>If you select a predefined characteristic type, the Search (🔍) icon appears corresponding to the Characteristic Value field. On clicking the Search icon, you can search for a predefined characteristic value.</p> <p>On specifying the value for a predefined characteristic type, the description of the characteristic value appears corresponding to the Characteristic Value field.</p>	<p>Note: This field is required when you are defining a characteristic for the funding request.</p>

- Enter the required details in the **Characteristics** section.
- If you want to define more than one characteristic for the funding request, click the **Add** (+) icon and then repeat step 2.

Note: However, if you want to remove a characteristic from the funding request, click the **Delete** (🗑️) icon corresponding to the characteristic.

Related Topics

For more information on...	See...
How to edit a funding request	Editing a Funding Request on page 1681

Deleting a Funding Request

Procedure

To delete a funding request:

- Search for the funding request in the **Funding Request** screen.
- In the **Search Results** section, click the link in the **Funding Request Information** column corresponding to the funding request that you want to delete.

The **Funding Request** screen appears.

- Click the **Delete** button in the **Funding Request** zone.

A message appears confirming whether you want to delete the funding request.

Note: The **Delete** button appears when the funding request is in the **Draft** status.

- Click **OK**.

The funding request is deleted.

Related Topics

For more information on...	See...
How to search for a funding request	Searching for a Funding Request on page 1663
Funding Request screen	Funding Request (Used for Viewing) on page 1665
Funding Request zone	Funding Request on page 1666

Canceling a Funding Request

Prerequisites

To cancel a funding request, you should have:

- Reasons defined for the **Canceled** status of the **C1-FundingRequest** business object in the **Status Reason** screen

Procedure

To cancel a funding request:

- Search for the funding request in the **Funding Request** screen.
- In the **Search Results** section, click the link in the **Funding Request Information** column corresponding to the funding request that you want to cancel.

The **Funding Request** screen appears.

- Click the **Cancel** button in the **Funding Request** zone.

The **Funding Request** window appears. It contains the following field:

Field Name	Field Description	Mandatory (Yes or No)
Status Reason	Used to indicate the reason why you want to cancel the funding request.	Yes
	Note: The list includes only those reasons which are defined for the Canceled status of the C1-FundingRequest business object in the Status Reason screen.	

Note: The **Cancel** button appears when the funding request is in the **Draft** status.

- Select the cancellation reason from the **Status Reason** list.
- Click **Save**.

The status of all records in the funding request is changed to **Excluded** and the status of the funding request is changed to **Canceled**. The excluded bills can then be included in some other funding request.

Related Topics

For more information on...	See...
How to search for a funding request	Searching for a Funding Request on page 1663
Funding Request screen	Funding Request (Used for Viewing) on page 1665
Funding Request zone	Funding Request on page 1666

Submitting a Funding Request

Prerequisites

To submit a funding request, you should have:

- At least one debit or credit bill in the funding request
- Funding and garnishment adjustment types defined in the funding request
- Funding adjustment type defined in the application (where the **A/P Request Type Code** field is set to **REFUND**)
- Garnishment adjustment type defined in the application (where the **A/P Request Type Code** field is not set to **REFUND**)

Procedure

To submit a funding request:

1. Search for the funding request in the **Funding Request** screen.
2. In the **Search Results** section, click the link in the **Funding Request Information** column corresponding to the funding request that you want to submit.

The **Funding Request** screen appears.

3. Click the **Submit** button in the **Funding Request** zone.

The system behaves in the following manner:

If...	Then...				
<p>The Approval Required option is selected in the funding request type using which the funding request is created</p>	<p>It calculates the sum of total debit and credit amount in the funding request. Depending on whether the sum total is debit or credit, it uses the debit or credit hierarchy in the approval profile (which is specified in the funding request type), respectively. Depending on the sum total amount, the system behaves in the following manner:</p>				
	<table border="1"> <thead> <tr> <th data-bbox="889 466 1177 506">If...</th> <th data-bbox="1182 466 1466 506">Then...</th> </tr> </thead> <tbody> <tr> <td data-bbox="889 510 1177 898"> <p>The sum total is less than the minimum threshold amount in the approval hierarchy</p> </td> <td data-bbox="1182 510 1466 898"> <p>The system automatically approves the funding request and changes the status of the funding request to either Deferred Processing or Create Funding depending on whether the number of bills in the funding request exceeds the defer processing count.</p> </td> </tr> </tbody> </table>	If...	Then...	<p>The sum total is less than the minimum threshold amount in the approval hierarchy</p>	<p>The system automatically approves the funding request and changes the status of the funding request to either Deferred Processing or Create Funding depending on whether the number of bills in the funding request exceeds the defer processing count.</p>
	If...	Then...			
<p>The sum total is less than the minimum threshold amount in the approval hierarchy</p>	<p>The system automatically approves the funding request and changes the status of the funding request to either Deferred Processing or Create Funding depending on whether the number of bills in the funding request exceeds the defer processing count.</p>				
<p>The sum total is equal to or greater than the threshold amount specified at the first level in the approval hierarchy</p>	<p>The system changes the status of the funding request to Approval In Progress. It creates a To Do using the To Do type specified in the approval profile and assigns it to the users with the To Do role defined at the first level in the approval hierarchy. In addition, it creates a log entry for the funding request when the To Do is created.</p>				

If...	Then...
<p>The Approval Required option is not selected in the funding request type using which the funding request is created</p>	<p>The system changes the status of the funding request to either Deferred Processing or Create Funding depending on whether the number of bills in the funding request exceeds the defer processing count.</p> <p>Once the Funding Request Periodic Monitor (C1-FNDRQ) batch is executed, it checks whether there are any funding requests in the Deferred Processing status. If so, it changes the status of the funding request to Create Funding.</p> <p>Once the status of a funding request is changed to Create Funding, the system creates the A/P adjustment against a bill when the funding amount of the bill is in credit. It also creates non A/P adjustments using the garnishment adjustment type when the funding amount of a credit bill is transferred to the garnishment contracts of the account. However, if the funding amount of a bill is in debit, the funding amount is stamped as the automatic payment amount against the bill in the CI_BILL_ACH table. Then, on executing the Create Automatic Payments and Refunds (APAYCRET) batch, the system creates automatic payment and payment event for such bill.</p> <p>Note: The funding and garnishment adjustments are created in the Frozen status.</p>

Note: The **Submit** button appears when the funding request is in the **Draft** status.

Related Topics

For more information on...	See...
How to search for a funding request	Searching for a Funding Request on page 1663
Funding Request screen	Funding Request (Used for Viewing) on page 1665
Funding Request zone	Funding Request on page 1666

Approving a Funding Request

You can view the number of funding requests which are pending for approval in the **Funding Request** screen. The approver can review, and accordingly approve, reject, or ask the submitter to resubmit the funding request based on the observations.

Note: The system will not allow you to approve, reject or resubmit a funding request submitted by you.

Procedure

To approve a funding request:

1. Do either of the following:

If you want to...	Then...
Approve a funding request through the Funding Request screen	<ol style="list-style-type: none"> 1. Search for the funding request in the Funding Request screen. 2. In the Search Results section, click the link in the Funding Request Information column corresponding to the funding request which you want to review.
Approve a funding request from the To Do List screen	<ol style="list-style-type: none"> 1. Click the Menu link in the Application toolbar. A list appears. 2. From the Main menu, select To Do and then click To Do List. The To Do Type for User Search window appears. 3. Enter C1-FNDAP in the To Do Type field. 4. Click the Search button corresponding to the To Do Type field. The To Do List screen appears. 5. Select the Open option from the Filter by list to view all unassigned To Dos. 6. Click the link in the Message column corresponding to the To Do of the funding request that you want to review.

The **Funding Request** screen appears.

2. Review the details in the **Funding Request** screen.
3. If the information in the funding request is accurate, then click the **Approve** button in the **Funding Request** zone.

The system behaves in the following manner:

If...	Then...
The sum total of the debit and credit amount is equal to or greater than the threshold amount specified at the next level in the approval hierarchy	The system changes the status of the funding request to Approval In Progress . It creates a To Do using the To Do type specified in the approval profile and assigns it to the users with the To Do role defined at the next level in the approval hierarchy. In addition, it creates a log entry for the funding request when the To Do is created.

If...	Then...
<p>The sum total of the debit and credit amount is less than the threshold amount specified at the next level in the approval hierarchy</p>	<p>The system changes the status of the funding request to either Deferred Processing or Create Funding depending on whether the number of bills in the funding request exceeds the defer processing count.</p> <p>Once the Funding Request Periodic Monitor (C1-FNDRQ) batch is executed, it checks whether there are any funding requests in the Deferred Processing status. If so, it changes the status of the funding request to Create Funding.</p> <p>Once the status of a funding request is changed to Create Funding, the system creates the A/P adjustment against a bill when the funding amount of the bill is in credit. It also creates non A/P adjustments using the garnishment adjustment type when the funding amount of a credit bill is transferred to the garnishment contracts of the account. However, if the funding amount of a bill is in debit, the funding amount is stamped as the automatic payment amount against the bill in the CI_BILL_ACH table. Then, on executing the Create Automatic Payments and Refunds (APAYCRET) batch, the system creates automatic payment and payment event for such bill.</p> <p>Note: The funding and garnishment adjustments are created in the Frozen status.</p>

Note: The **Approve** button appears when:

- The funding request is in the **Approval In Progress** status.
- A user with the approval To Do role is reviewing the funding request.

Related Topics

For more information on...	See...
How to search for a funding request	Searching for a Funding Request on page 1663
Funding Request screen	Funding Request (Used for Viewing) on page 1665
Funding Request zone	Funding Request on page 1666

Rejecting a Funding Request

Prerequisites

To reject a funding request, you should have:

- Reasons defined for the **Rejected** status of the **C1-FundingRequest** business object in the **Status Reason** screen

Note: The system will not allow you to approve, reject or resubmit a funding request submitted by you.

Procedure

To reject a funding request:

1. Do either of the following:

If you want to...	Then...
Reject a funding request through the Funding Request screen	<ol style="list-style-type: none"> 1. Search for the funding request in the Funding Request screen. 2. In the Search Results section, click the link in the Funding Request Information column corresponding to the funding request which you want to review.
Reject a funding request from the To Do List screen	<ol style="list-style-type: none"> 1. Click the Menu link in the Application toolbar. A list appears. 2. From the Main menu, select To Do and then click To Do List. The To Do Type for User Search window appears. 3. Enter C1-FNDAP in the To Do Type field. 4. Click the Search button corresponding to the To Do Type field. The To Do List screen appears. 5. Select the Open option from the Filter by list to view all unassigned To Dos. 6. Click the link in the Message column corresponding to the To Do of the funding request that you want to review.

The **Funding Request** screen appears.

2. Review the details in the **Funding Request** screen.
3. If the information in the funding request is incorrect, then click the **Reject** button in the **Funding Request** zone.

The **Reject Funding Request** window appears. It contains following fields:

Field Name	Field Description	Mandatory (Yes or No)
Status Reason	<p>Used to indicate the reason why you want to reject the funding request.</p> <p>Note: The list includes only those reasons which are defined for the Rejected status of the C1-FundingRequest business object in the Status Reason screen.</p>	Yes
Comments	Used to specify additional information while rejecting the funding request.	No

Note: The **Reject** button appears when:

- The funding request is in the **Approval In Progress** status.
- A user with the approval To Do role is reviewing the funding request.

4. Select the rejection reason from the **Status Reason** list.
5. Click **Save**.

The status of the funding request is changed to **Rejected**.

Related Topics

For more information on...	See...
How to search for a funding request	Searching for a Funding Request on page 1663
Funding Request screen	Funding Request (Used for Viewing) on page 1665
Funding Request zone	Funding Request on page 1666

Requesting to Resubmit a Funding Request

Procedure

To request for resubmitting a funding request:

1. Do either of the following:

If you want to...	Then...
Request for resubmitting a funding request through the Funding Request screen	<ol style="list-style-type: none"> 1. Search for the funding request in the Funding Request screen. 2. In the Search Results section, click the link in the Funding Request Information column corresponding to the funding request which you want to review.
Request for resubmitting a funding request from the To Do List screen	<ol style="list-style-type: none"> 1. Click the Menu link in the Application toolbar. A list appears. 2. From the Main menu, select To Do and then click To Do List. The To Do Type for User Search window appears. 3. Enter C1-FNDAP in the To Do Type field. 4. Click the Search button corresponding to the To Do Type field. The To Do List screen appears.

If you want to...	Then...
	<ol style="list-style-type: none"> 5. Select the Open option from the Filter by list to view all unassigned To Dos. 6. Click the link in the Message column corresponding to the To Do of the funding request that you want to review.

The **Funding Request** screen appears.

2. Review the details in the **Funding Request** screen.
3. If the information in the funding request is incomplete and you want the submitter to make the required changes and resubmit it, click the **Re Submit** button in the **Funding Request** zone.

The **Resubmit Funding Request** window appears. It contains the following field:

Field Name	Field Description	Mandatory (Yes or No)
Comments	Used to specify the changes which the submitter should make in the funding request before resubmitting it for approval.	Yes

Note: The **Re Submit** button appears when:

- The funding request is in the **Approval In Progress** status.
- A user with the approval To Do role is reviewing the funding request.

4. Enter the comments in the respective field and then click **Save**.

A To Do is created using the submitter To Do type and assigned to all users with a submitter To Do role specified in the funding request type. In addition, the status of the funding request is changed to **Draft**.

Related Topics

For more information on...	See...
How to search for a funding request	Searching for a Funding Request on page 1663
Funding Request screen	Funding Request (Used for Viewing) on page 1665
Funding Request zone	Funding Request on page 1666

Withdrawing a Funding Request

Prerequisites

To withdraw a funding request, you should have:

- Submitter To Do role (which is specified in the funding request type) associated with the **C1-FNDAP** To Do type

Procedure

To withdraw a funding request:

1. Search for the funding request in the **Funding Request** screen.

- In the **Search Results** section, click the link in the **Funding Request Information** column corresponding to the funding request that you want to withdraw.

The **Funding Request** screen appears.

- If you want to make some changes in the funding request which is already sent for approval, click the **Withdraw** button in the **Funding Request** zone.

The status of the funding request is changed to **Draft**. The submitter can then make the required changes and resubmit the funding request for approval. The To Do for approver is automatically closed when the submitter withdraws the funding request. Note that the To Do for approver is automatically closed when the submitter To Do role is associated with the To Do type specified in the approval profile.

Note: The **Withdraw** button appears when:

- The funding request is in the **Approval In Progress** status.
- A user with the submitter To Do role is viewing the funding request.

Related Topics

For more information on...	See...
How to search for a funding request	Searching for a Funding Request on page 1663
Funding Request screen	Funding Request (Used for Viewing) on page 1665
Funding Request zone	Funding Request on page 1666

Transferring the Funding Amount of a Credit Bill to a Garnishment Contract

Prerequisites

To transfer the funding amount of a credit bill to a garnishment contract, you should have:

- At least one garnishment contract on the account

Note: The garnishment contract is a contract which is created using a contract type where the **Special Role Flag** field is set to **Garnishment**.

Procedure

To transfer the funding amount of a credit bill to a garnishment contract:

- Search for the funding request in the **Funding Request** screen.
- In the **Search Results** section, click the link in the **Funding Request Information** column corresponding to the funding request whose details you want to edit.

The **Funding Request** screen appears.

- Click the **Bills** tab.

The **Bills** tab appears.

- In the **Selected Bills** zone, click the link on the value **Y** in the **Garnishment Contract** column corresponding to a credit bill whose funding amount you want to transfer to a garnishment contract of the account.

The **Edit Garnishment Details** screen appears. It contains the following field:

Field Name	Field Description
Bill Information	Indicates the credit bill whose funding amount you want to transfer to a garnishment contract of the account.

In addition, this screen contains the following fields in a grid:

Field Name	Field Description	Mandatory (Yes or No)
Garnishment Contract	Used to indicate the garnishment contract of the account.	Yes
Garnishment Amount	Used to specify the amount that you want to transfer to the garnishment contract.	Yes

- Enter the required details in the **Edit Garnishment Details** screen.
- If you want to transfer the funding amount of the credit bill to more than one garnishment contract of the account, click the **Add (+)** icon and then repeat step 5.

Note: However, if you want to remove a garnishment record from the funding request, click the **Delete** (🗑️) icon corresponding to the garnishment record.

- Click **Save**.

The changes made to the funding request are saved.

Related Topics

For more information on...	See...
How to search for a funding request	Searching for a Funding Request on page 1663
Funding Request screen	Funding Request (Used for Viewing) on page 1665
Selected Bills zone	Selected Bills on page 1673

Viewing the Garnishment Details of a Credit Bill

Procedure

To view the garnishment details of a credit bill:

- Search for the funding request in the **Funding Request** screen.
- In the **Search Results** section, click the link in the **Funding Request Information** column corresponding to the funding request whose details you want to view.

The **Funding Request** screen appears.

- Click the **Bills** tab.

The **Bills** tab appears.

- In the **Selected Bills** zone, click the **Broadcast** (📡) icon in the **Garnishment** column corresponding to the credit bill whose garnishment details you want to view.

The **View Garnishment Details** screen appears. It contains the following field:

Field Name	Field Description
Bill Info	Indicates the credit bill whose garnishment details you are viewing.

In addition, this screen contains the following columns:

Column Name	Column Description
Garnishment Contract	Indicates the garnishment contract of the account against which amount from the credit bill is transferred.
Garnishment Amount	Displays the amount which is transferred to the garnishment contract.

Note:

The **Garnishment** column does not appear when the funding request is in the **Draft** status.

The **View** () icon appears in the **Garnishment** column only when the funding request is in the **Processed** status.

Related Topics

For more information on...	See...
How to search for a funding request	Searching for a Funding Request on page 1663
Funding Request screen	Funding Request (Used for Viewing) on page 1665
Selected Bills zone	Selected Bills on page 1673

Viewing the Payments Created Through a Funding Request**Procedure**

To view the payments created through a funding request:

1. Search for the funding request in the **Funding Request** screen.
2. In the **Search Results** section, click the link in the **Funding Request Information** column corresponding to the funding request whose details you want to view.

The **Funding Request** screen appears.

3. Click the **Bills** tab.

The **Bills** tab appears.

4. In the **Selected Bills** zone, click the **Broadcast** () icon corresponding to a debit bill whose payment details you want to view.

The **Funding Payments Details** zone appears.

Note: The **Broadcast** () icon appears when the funding request is in the **Processed** status.

5. View the payments created for the debit bill through the funding request in the **Funding Payments Details** zone.

Note: The data appears in the **Funding Payments Details** zone when the **Create Automatic Payments and Refunds (APAYCRET)** batch is executed to create the automatic payment and payment event for the debit bill. For more information about the batch, refer to *Oracle Revenue Management and Billing Batch Guide*.

Related Topics

For more information on...	See...
How to search for a funding request	Searching for a Funding Request on page 1663
Funding Request screen	Funding Request (Used for Viewing) on page 1665

For more information on...	See...
Selected Bills zone	Selected Bills on page 1673
Funding Payments Details zone	Funding Payment Details on page 1676

Viewing the Adjustments Created Through a Funding Request

Procedure

To view the adjustments created through a funding request:

1. Search for the funding request in the **Funding Request** screen.
2. In the **Search Results** section, click the link in the **Funding Request Information** column corresponding to the funding request whose details you want to view.

The **Funding Request** screen appears.

3. Click the **Bills** tab.

The **Bills** tab appears.

4. In the **Selected Bills** zone, click the **Broadcast** () icon corresponding to a credit bill whose adjustment details you want to view.

The **Funding Adjustments** zone appears.

Note: The **Broadcast** () icon appears when the funding request is in the **Processed** status.

5. View the A/P adjustments and garnishment adjustments (if any) created for the credit bill through the funding request in the **Funding Adjustments** zone.

Related Topics

For more information on...	See...
How to search for a funding request	Searching for a Funding Request on page 1663
Funding Request screen	Funding Request (Used for Viewing) on page 1665
Selected Bills zone	Selected Bills on page 1673
Funding Adjustments zone	Funding Adjustments on page 1677

Viewing the Log of a Funding Request

Procedure

To view the log of a funding request:

1. Search for the funding request in the **Funding Request** screen.
2. In the **Search Results** section, click the link in the **Funding Request Information** column corresponding to the funding request whose log you want to view.

The **Funding Request** screen appears.

3. Click the **Log** tab.

The **Log** tab appears.

4. View the complete trail of actions performed on the funding request in the **Funding Request Log** zone.

Related Topics

For more information on...	See...
How to search for a funding request	Searching for a Funding Request on page 1663
How to add a log entry for a funding request	Adding a Log Entry for a Funding Request on page 1698
Funding Request screen	Funding Request (Used for Viewing) on page 1665
Funding Request Log zone	Funding Request Log on page 1677

Adding a Log Entry for a Funding Request**Procedure**

To add a log entry for a funding request:

1. Search for the funding request in the **Funding Request** screen.
2. In the **Search Results** section, click the link in the **Funding Request Information** column corresponding to the funding request whose log you want to edit.

The **Funding Request** screen appears.

3. Click the **Log** tab.

The **Log** tab appears.

4. Click the **Add Log Entry** link in the upper right corner of the **Funding Request Log** zone.

The **Add Request Log** window appears. It contains the following fields:

Field Name	Field Description	Mandatory (Yes or No)
Request Information	Displays information about the funding request.	Not applicable
Log Details	Used to specify additional comments for the funding request.	Yes

5. Enter the comments in the **Log Details** field.
6. Click **Save**.

The log entry is added in the **Funding Request Log** zone.

Related Topics

For more information on...	See...
How to search for a funding request	Searching for a Funding Request on page 1663
Funding Request screen	Funding Request (Used for Viewing) on page 1665
Funding Request Log zone	Funding Request Log on page 1677

Chapter

24

Refund/Write Off Request

Topics:

- [Refund Request \(Without Approval\) Status Transition](#)
- [Refund Request \(With Approval\) Status Transition](#)
- [Write Off Request \(Without Approval\) Status Transition](#)
- [Write Off Request \(With Approval\) Status Transition](#)
- [Algorithms Used in C1-RefundReq](#)
- [Algorithms Used in C1-WORequest](#)
- [Prerequisites](#)
- [Refund/Write Off Request Type](#)
- [Refund/Write Off Request](#)
- [Refund Request](#)
- [Write Off Request](#)

Oracle Revenue Management and Billing allows you to refund and write off amount to the account. If the amount received from the payor account is matched against the suspense or excess credit contract, the system facilitates you to refund the amount to the payor. In addition, you can refund the amount of a credit bill line item, such as credit bill segment or adjustment, if required. To refund the amount to the account holder, you need to create refund adjustments through a refund request. While creating a refund request, you need to specify the refund request type using which you want to create the refund request. It is the refund request type which helps the system to determine:

- Whether the refund request must be approved before creating refund adjustments in the system
- Approval profile using which the refund request must be approved
- Whether multi-level or single-level approval is required while creating refund adjustments in the system
- Tolerance limit for refund (i.e. minimum refund amount)
- Adjustment type using which the write up adjustment must be created when the total refund amount is less than the minimum refund amount
- Default adjustment type using which refund adjustments must be created

The system allows you to create refund adjustments only using those adjustment types where A/P request type is defined. Once the refund adjustments are created, the A/P Extract process will extract the information and accordingly refund the amount to the payor. During the refund request process, a refund request goes through various statuses in its lifecycle. For more information about the refund request statuses, see [Refund Request \(Without Approval\) Status Transition](#) on page 1701 and [Refund Request \(With Approval\) Status Transition](#) on page 1701.

Note that the lifecycle of a refund request is driven by the business object using which the refund request is created. A refund request business object named **C1-RefundReq** is shipped with the product. The refund request feature explained in this document is articulated based on the lifecycle and logic defined in the **C1-RefundReq** business object.

Similarly, the system facilitates you to write off the amount to the account through a write off request. While creating a write off request, you need to specify the write off request type using which you want to create the write off request. It is the write off request type which helps the system to determine:

- Whether the write off request must be approved before creating write off adjustments in the system
- Approval profile using which the write off request must be approved

- Whether multi-level or single-level approval is required while creating write off adjustments in the system
- Default adjustment type using which write off adjustments must be created

The system allows you to create write off adjustments only using those adjustment types where A/P request type is not defined. During the write off request process, a write off request goes through various statuses in its lifecycle. For more information about the write off request statuses, see [Write Off Request \(Without Approval\) Status Transition](#) on page 1702 and [Write Off Request \(With Approval\) Status Transition](#) on page 1703.

Note that the lifecycle of a write off request is driven by the business object using which the write off request is created. A write off request business object named **C1-WORequest** is shipped with the product. The write off request feature explained in this document is articulated based on the lifecycle and logic defined in the **C1-WORequest** business object.

For more information on how to setup the refund and write off request processes, see [Prerequisites](#) on page 1713.

Refund Request (Without Approval) Status Transition

The following figure graphically indicates how a refund request moves from one status to another when approval workflow is off:

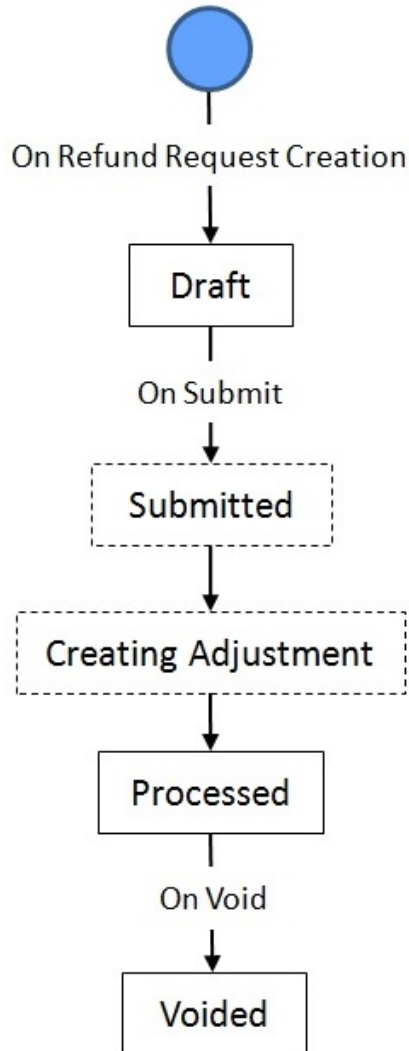

Refund Request (With Approval) Status Transition

The following figure graphically indicates how a refund request moves from one status to another when approval workflow is on:

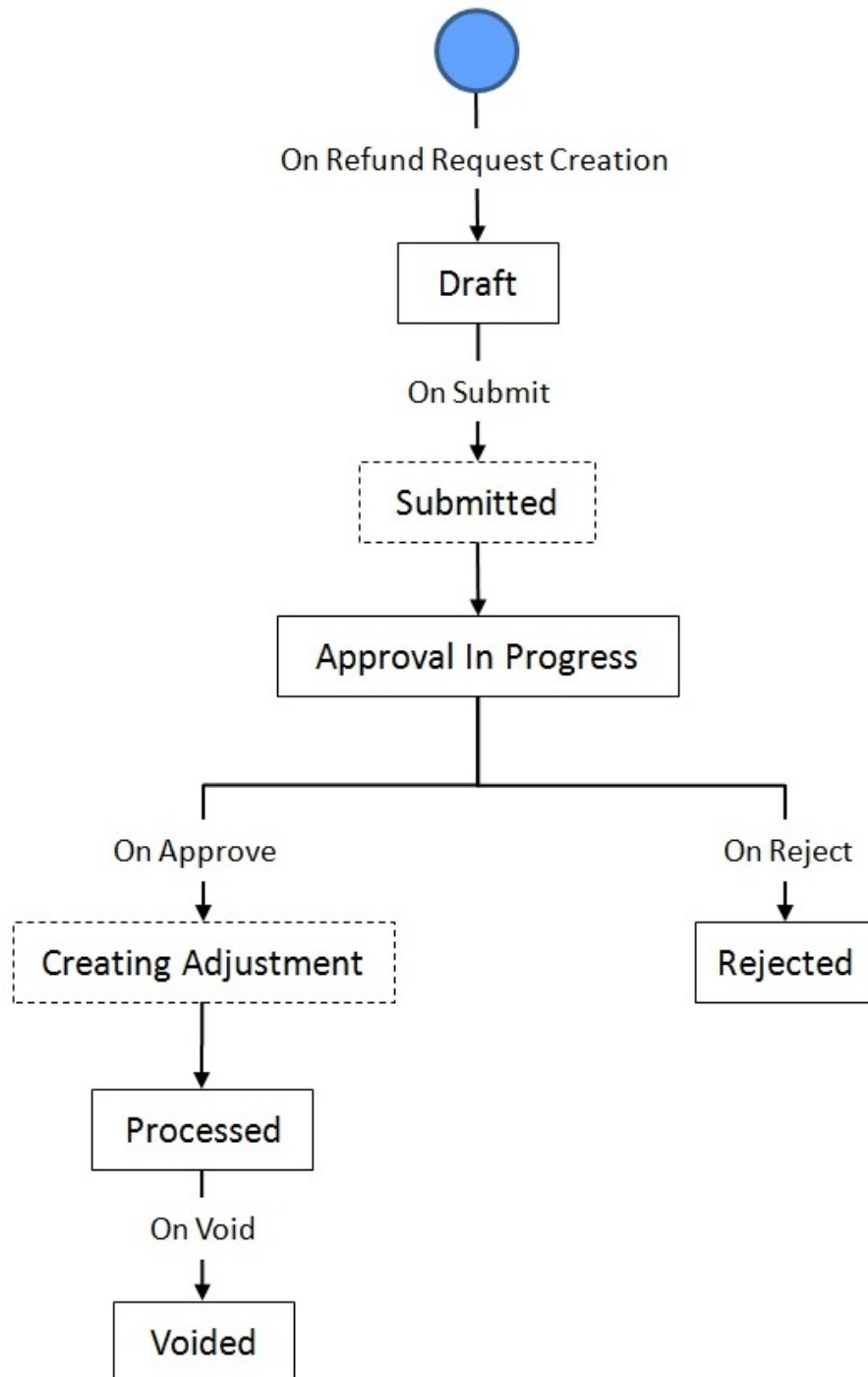

Write Off Request (Without Approval) Status Transition

The following figure graphically indicates how a write off request moves from one status to another when approval workflow is off:

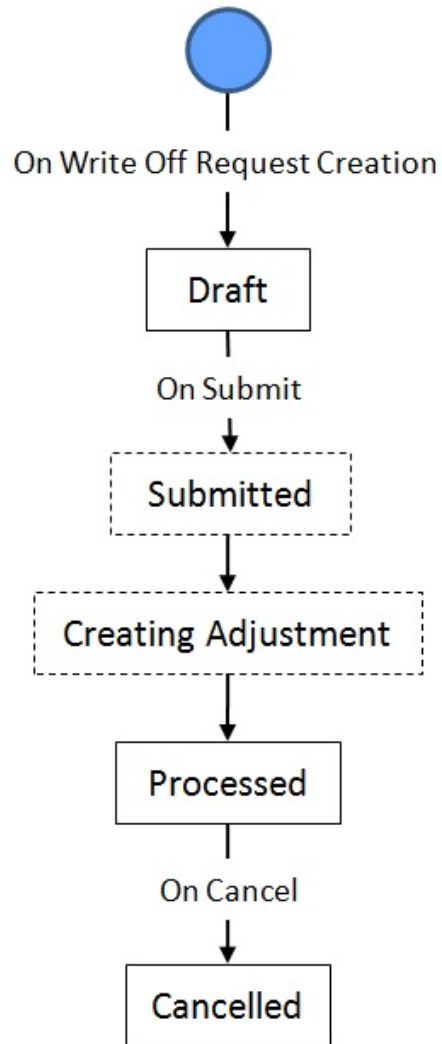

Write Off Request (With Approval) Status Transition

The following figure graphically indicates how a write off request moves from one status to another when approval workflow is on:

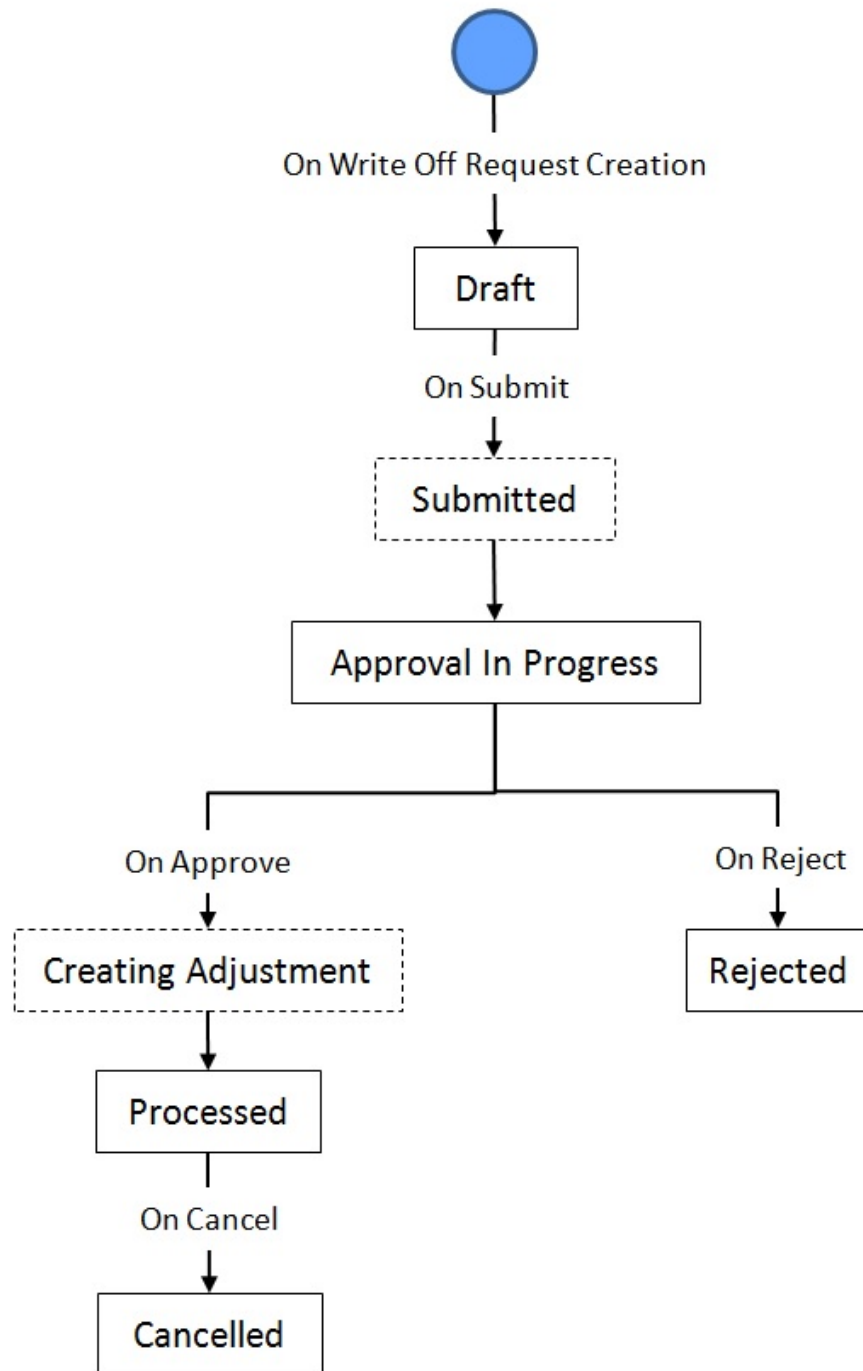

Algorithms Used in C1-RefundReq

The following table lists the algorithms which are attached to the **C1-RefundReq** business object:

System Event	Algorithm	Algorithm Type	Description
Information	C1-REFREQINF	C1-REFREQINF	<p>This algorithm generates the refund and write off request information string which appears throughout the application. It concatenates the following fields:</p> <ul style="list-style-type: none"> • Refund or Write Off Request Type Description • Refund or Write Off Request Status Description • Refund or Write Off Request ID
Post-Processing	C1-REFWOPOSP	C1-REFWOPOSP	<p>This algorithm recalculates and updates the total refund amount in the Refund Request zone when you change the refund amount against an entity while editing a refund request.</p>
Validation	C1-REFUNDVAL	C1-REFUNDVAL	<p>This algorithm validates the following for each entity that you have selected in the refund request:</p> <ul style="list-style-type: none"> • The mandatory data, such as refund amount and adjustment type, is specified. • The refund amount is not less than zero. • The refund amount is not greater than the entity amount. • The refund amount is not greater than the eligible refund amount. • The partial refund is not done at the payment event or bill level.

The following table lists the algorithms which are used in the lifecycle of the **C1-RefundReq** business object:

Status	System Event	Algorithm	Algorithm Type	Description
Draft	Enter	C1-REF-DFT	C1-REF-DFT	<p>This algorithm fetches the account's main customer's name and address and displays in the Refund Request zone. In addition, when you refund the payments from the Payment Event Summary screen, this algorithm does the following:</p> <ul style="list-style-type: none"> • The total eligible refund amount is calculated and accordingly displayed in the Refund Request screen. • The default refund adjustment type specified in the refund request type is fetched and displayed against the selected payment event or payments. • On selecting a payment event for refund, if all payments in the payment event are matched against the same suspense or excess credit contract, the payment event is added in the Refund Details zone. However, if the payments in the payment event are matched against different suspense or excess credit contracts, the payments of the payment event are added in the Refund Details zone.
Submitted	Enter	C1-REFUNDSUB	C1-REFUNDSUB	<p>This algorithm checks the following:</p> <ul style="list-style-type: none"> • Whether the approval is required for the refund request. If the approval is required for a refund request, the status of the refund request is changed to Approval In Progress. However, if the approval is not required for a refund request, the status of the refund request is changed to Creating Adjustment. • At least one entity, such as payment event, payment, or credit bill line item (such as credit bill segment or adjustment) is selected in the refund request. • Whether the approval profile attached to the refund request type has the credit hierarchy and C1-REFRQ To Do type defined.

Status	System Event	Algorithm	Algorithm Type	Description
Approval In Progress	Enter	C1-REFUNDAPP	C1-REFUNDAPP	<p>This algorithm creates the following:</p> <ul style="list-style-type: none"> • A To Do using the To Do type specified in the approval profile which is attached to the refund request type. The To Do is sent to the appropriate users in the approval hierarchy depending on whether hierarchical approval is required or not. • A log entry is added when a To Do is created using the To Do type.
Approved	Enter	C1-REFAPPRVD	C1-REFAPPRVD	<p>This algorithm is triggered when the approver clicks the Approve button. It checks whether the approval is required from users at the next level in the approval hierarchy. If the approval is required from the next level in the approval hierarchy, the status of the refund request is changed to Approval In Progress and the algorithm attached to the Approval In Progress status is invoked. If further approval is not required, the status of the refund request is changed to Creating Adjustment.</p>
Rejected	-	-	-	-

Status	System Event	Algorithm	Algorithm Type	Description
Creating Adjustment	Enter	C1-REFADJCRI	C1-REFADJCRI	<p>This algorithm does the following:</p> <ul style="list-style-type: none"> Creates the refund adjustments for the refund request. These refund adjustments are created in the Frozen status. The adjustment ID is displayed corresponding to the entity in the Refund Details zone. Stamps the bill ID of credit line item on the adjustment and the corresponding financial transaction. If a match event is present for the credit bill line item and for payments which are matched against the excess credit contract, the existing match event is stamped on the refund or write up adjustment and the corresponding financial transaction. However, when a match event is not present for payments which are matched against the suspense contract or if the match event does not exist, a new match event is created and stamped on the refund or write up adjustment and the corresponding financial transaction. If you are doing a partial refund for any entity, the corresponding match event status is set to Open. However, if you are refunding the entire eligible amount, the corresponding match event status is set to Balanced. The details of the refund adjustments are added in the A/P Check Request (CL_ADJ_APREQ) table. If a write up adjustment is created, the write up adjustment type specified in the refund request type is displayed corresponding to the entity in the Refund Details zone.
Processed	-	-	-	-

Status	System Event	Algorithm	Algorithm Type	Description
Voided	Enter	C1-REFVOID	C1-REFVOID	<p>This algorithm is invoked on click of the Void button for a refund request which is in processed state.</p> <p>The algorithm cancels all the frozen adjustments created for the refund request.</p> <p>The algorithm fetches the adjustment cancel reason required for cancelling the adjustments in the status reason characteristics (F1_BUS_OBJ_STATUS_RSN_CHAR table). If the reason is not found, it will use the status reason selected by the user</p>

Algorithms Used in C1-WORequest

The following table lists the algorithms which are attached to the **C1-WORequest** business object:

System Event	Algorithm	Algorithm Type	Description
Information	C1-REFREQINF	C1-REFREQINF	<p>This algorithm generates the refund and write off request information string which appears throughout the application. It concatenates the following fields:</p> <ul style="list-style-type: none"> • Refund or Write Off Request Type Description • Refund or Write Off Request Status Description • Refund or Write Off Request ID
Post-Processing	C1-WOPOSP	C1-WOPOSP	<p>This algorithm recalculates and updates the total write off amount in the Write Off Request zone when you change the write off amount against an entity while editing a write off request.</p>

System Event	Algorithm	Algorithm Type	Description
Validation	C1-WOBOVAL	C1-WOBOVAL	<p>This algorithm validates the following for each entity that you have selected in the write off request:</p> <ul style="list-style-type: none"> • The mandatory data, such as write off amount and adjustment type, is specified. • The write off amount is not less than zero. • The write off amount is not greater than the entity amount. • The write off amount is not greater than the eligible write off amount. • The partial write off is not done at the bill level. • The A/P Request Type is not defined in the selected adjustment type.

The following table lists the algorithms which are used in the lifecycle of the **C1-WORequest** business object:

Status	System Event	Algorithm	Algorithm Type	Description
Draft	-	-	-	-
Submitted	Enter	C1-WOSUBMIT	C1-WOSUBMIT	<p>This algorithm checks the following:</p> <ul style="list-style-type: none"> • Whether the approval is required for the write off request. If the approval is required for a write off request, the status of the write off request is changed to Approval In Progress. However, if the approval is not required for a write off request, the status of the write off request is changed to Creating Adjustment. • At least one debit bill line item (such as debit bill segment or adjustment) is selected in the write off request. • Whether the approval profile attached to the write off request type has the debit hierarchy and C1-WOREQ To Do type defined.

Status	System Event	Algorithm	Algorithm Type	Description
Approval In Progress	Enter	C1-WOAPPROVL	C1-WOAPPROVL	<p>This algorithm creates the following:</p> <ul style="list-style-type: none"> • A To Do using the To Do type specified in the approval profile which is attached to the write off request type. The To Do is sent to the appropriate users in the approval hierarchy depending on whether hierarchical approval is required or not. • A log entry is added when a To Do is created using the To Do type.
Approved	Enter	C1-WOAPPROVD	C1-WOAPPROVD	<p>This algorithm is triggered when the approver clicks the Approve button. It checks whether the approval is required from users at the next level in the approval hierarchy. If the approval is required from the next level in the approval hierarchy, the status of the write off request is changed to Approval In Progress and the algorithm attached to the Approval In Progress status is invoked. If further approval is not required, the status of the write off request is changed to Creating Adjustment.</p>
Rejected	-	-	-	-

Status	System Event	Algorithm	Algorithm Type	Description
Creating Adjustment	Enter	C1-WOADCRT	C1-WOADCRT	<p>This algorithm does the following:</p> <ul style="list-style-type: none"> Creates the write off adjustments for the write off request. These write off adjustments are created in the Frozen status. The adjustment ID is displayed corresponding to the entity in the Write Off Details zone. Stamps the bill ID of debit line item on the adjustment and the corresponding financial transaction. If a match event is present for the debit bill line item, the existing match event is stamped on the write off adjustment and the corresponding financial transaction. However, if the match event does not exist, a new match event is created and stamped on the write off adjustment and the corresponding financial transaction. If you are doing a partial write off for any entity, the corresponding match event status is set to Open. However, if the entire eligible amount is written off, the corresponding match event status is set to Balanced.
Processed	-	-	-	-
Cancelled	Enter	C1-WOCANCEL	C1-WOCANCEL	<p>This algorithm is invoked on click of the Cancel button for a write off request which is in the Processed state.</p> <p>This algorithm cancels all the frozen adjustments created for the write off request.</p> <p>The algorithm fetches the adjustment cancel reason required for cancelling the adjustments in the status reason characteristics (F1_BUS_OBJ_STATUS_RSN_CHAR table). If the reason is not found, it will use the status reason selected by the user.</p>

Prerequisites

To setup the refund request process, you need to do the following:

- Define the required adjustment types (for creating refund adjustments) where A/P request type is defined
- Define the required adjustment types (for creating write up adjustments) where A/P request type is not defined
- Define the required characteristic types where the characteristic entity is set to **Refund Write Off Request Type**
- Define the required characteristic types where the characteristic entity is set to **Refund Write Off Request**
- Define voided and rejected status reasons for the **C1-RefundReq** business object
- Assign the **C1-REFRQ** To Do type to a To Do role whose users must receive To Do generated while submitting a refund request for approval
- Define the required approval profiles with the credit hierarchy and **C1-REFRQ** To Do type
- Define an algorithm of the **C1-ADI-INFO** algorithm type and attach to the **Adjustment Information** system event in the **Algorithms** tab of the **Installation Options — Framework** screen
- Define the required refund request types in the system

To setup the write off request process, you need to do the following:

- Define the required adjustment types (for creating write off adjustments) where A/P request type is not defined
- Define the required characteristic types where the characteristic entity is set to **Refund Write Off Request Type**
- Define the required characteristic types where the characteristic entity is set to **Refund Write Off Request**
- Define cancelled and rejected status reasons for the **C1-WOREquest** business object
- Assign the **C1-WOREQ** To Do type to a To Do role whose users must receive To Do generated while submitting a write off request for approval
- Define the required approval profiles with the debit hierarchy and **C1-WOREQ** To Do type
- Define an algorithm of the **C1-ADI-INFO** algorithm type and attach to the **Adjustment Information** system event in the **Algorithms** tab of the **Installation Options — Framework** screen
- Define the required write off request types in the system

Refund/Write Off Request Type

Oracle Revenue Management and Billing allows you to define:

- **Refund Request Type** — It is used to create a refund request. You can define multiple refund request types in the system. A refund request type helps the system to determine:
 - Whether the refund request must be approved before creating refund adjustments in the system
 - Approval profile using which the refund request must be approved
 - Whether multi-level or single-level approval is required while creating refund adjustments in the system
 - Tolerance limit for refund (i.e. minimum refund amount)
 - Adjustment type using which the write up adjustment must be created when the total refund amount is less than the minimum refund amount
 - Default adjustment type using which refund adjustments must be created

- **Write Off Request Type** — It is used to create a write off request. You can define multiple write off request types in the system. A write off request type helps the system to determine:
 - Whether the write off request must be approved before creating write off adjustments in the system
 - Approval profile using which the write off request must be approved
 - Whether multi-level or single-level approval is required while creating write off adjustments in the system
 - Default adjustment type using which write off adjustments must be created

While defining a refund or write off request type where approval workflow is required, you need to select the **Approval Required** check box. If the **Approval Required** check box is selected, the refund or write off request (which is created using the refund or write off request type) is sent for approval before creating the refund or write off adjustments. However, if the **Approval Required** check box is not selected, the refund or write off adjustments are created immediately on submitting a refund or write off request. The approval process is configured through the approval profile. The approval profile allows you to define the approval hierarchy. You can define a debit and credit hierarchy in the approval profile using the threshold amount. The debit approval hierarchy is used for approving write off request and credit approval hierarchy is used for approving refund request. Therefore, while defining an approval profile for refund, you need to define credit hierarchy and set the To Do Type to **C1-REFRQ**. However, while defining an approval profile for write off, you need to define debit hierarchy and set the To Do Type to **C1-WOREQ**.

You can define an approval hierarchy where users with different To Do role at each level can approve or reject the refund or write off request. For example, you can define an approval profile called A1 with two levels of approval. At the first level, a user with the *Manager* To Do role will approve or reject the refund or write off request, and at the second level, a user with the *Senior Manager* To Do role will approve or reject the refund or write off request. On submitting a refund or write off request where approval is required, a notification in the form of To Do is sent to all users with the To Do role defined at the first level in the hierarchy. Once the request is approved at the first level, a notification is sent to all users with the To Do role defined at the next level in the hierarchy. This process continues till the approval is received from all levels in the hierarchy. Once users at all levels approve the refund or write off request, the refund or write off adjustments are created. However, if an approver at any level in the hierarchy rejects the request, the refund or write off adjustments are not created.

The approval hierarchy is controlled by the threshold amount. For example, you define an approval profile called A1 with two levels of approval — First Level (Threshold Amount: 300, To Do Role: *Manager*) and Second Level (Threshold Amount: 500, To Do Role: *Senior Manager*). Now, if the total refund or write off amount is equal to 300 or less than 500, then the approval is required only from the first level in the hierarchy and not from the second level in the hierarchy. However, if the total refund or write off amount is equal to or greater than 500, then the approval is required from the first level and then from the second level in the hierarchy. But, if the total refund or write off amount is less than 300, then the approval is not required from any levels in the hierarchy. The system will automatically approve the refund or write off request and create the refund or write off adjustments.

The system supports both single-level and multi-level approval process while approving refund or write off request. If the **Hierarchical Approval** check box is selected while defining a refund or write off request type, the approval hierarchy defined in the approval profile is followed based on the threshold limit. However, if the **Hierarchical Approval** check box is not selected while defining a refund or write off request type, the approval is required only from the approval level where the total refund or write off amount falls within the threshold limit. Let us understand this with the help of some examples.

Example 1

Refund Request Type	Approval Profile	Approval Hierarchy	Hierarchical Approval								
R1	Refund Analyst	<p>Credit Hierarchy</p> <table border="1"> <thead> <tr> <th>Threshold Amount</th> <th>To Do Role</th> </tr> </thead> <tbody> <tr> <td>\$500</td> <td>Senior Analyst</td> </tr> <tr> <td>\$750</td> <td>Manager</td> </tr> <tr> <td>\$1500</td> <td>Senior Manager</td> </tr> </tbody> </table>	Threshold Amount	To Do Role	\$500	Senior Analyst	\$750	Manager	\$1500	Senior Manager	Yes
Threshold Amount	To Do Role										
\$500	Senior Analyst										
\$750	Manager										
\$1500	Senior Manager										
R2	Refund Analyst	<p>Credit Hierarchy</p> <table border="1"> <thead> <tr> <th>Threshold Amount</th> <th>To Do Role</th> </tr> </thead> <tbody> <tr> <td>\$500</td> <td>Senior Analyst</td> </tr> <tr> <td>\$750</td> <td>Manager</td> </tr> <tr> <td>\$1500</td> <td>Senior Manager</td> </tr> </tbody> </table>	Threshold Amount	To Do Role	\$500	Senior Analyst	\$750	Manager	\$1500	Senior Manager	No
Threshold Amount	To Do Role										
\$500	Senior Analyst										
\$750	Manager										
\$1500	Senior Manager										

The following table indicates how the system will behave in different refund scenarios:

Refund Request	Refund Request Type	Total Refund Amount (\$)	Comments
RR1	R1	200	This refund request is automatically approved by the system because the total refund amount is less than \$500.
RR2	R1	750	<p>The To Do is sent for approval to the following users in the specified order:</p> <ol style="list-style-type: none"> 1. Users with the Senior Analyst To Do role 2. Users with the Manager To Do role <p>This is because the total refund amount is either equal to \$750 or less than \$1500 and hierarchical approval is required.</p>
RR3	R1	2000	<p>The To Do is sent for approval to the following users in the specified order:</p> <ol style="list-style-type: none"> 1. Users with the Senior Analyst To Do role 2. Users with the Manager To Do role 3. Users with the Senior Manager To Do role <p>This is because the total refund amount is greater than \$1500 and hierarchical approval is required.</p>
RR4	R2	200	This refund request is automatically approved by the system because the total refund amount is less than \$500.

Refund Request	Refund Request Type	Total Refund Amount (\$)	Comments
RR5	R2	750	The To Do is sent for approval to users with the Manager To Do role. This is because the total refund amount is either equal to \$750 or less than \$1500 and hierarchical approval is not required.
RR6	R2	2000	The To Do is sent for approval to users with the Senior Manager To Do role. This is because the total refund amount is greater than \$1500 and hierarchical approval is not required.

Example 2

Write Off Request Type	Approval Profile	Approval Hierarchy	Hierarchical Approval	
W1	Write Off Analyst	Debit Hierarchy	Yes	
		Threshold Amount		To Do Role
		\$100		Senior Analyst
		\$200		Manager
		\$300		Senior Manager
W2	Write Off Analyst	Debit Hierarchy	No	
		Threshold Amount		To Do Role
		\$100		Senior Analyst
		\$200		Manager
		\$300		Senior Manager

The following table indicates how the system will behave in different write off scenarios:

Write Off Request	Write Off Request Type	Total Write Off Amount (\$)	Comments
WO1	W1	90	This write off request is automatically approved by the system because the total write off amount is less than \$100.
WO2	W1	250	<p>The To Do is sent for approval to the following users in the specified order:</p> <ol style="list-style-type: none"> 1. Users with the Senior Analyst To Do role 2. Users with the Manager To Do role <p>This is because the total write off amount is either equal to \$200 or less than \$300 and hierarchical approval is required.</p>

Write Off Request	Write Off Request Type	Total Write Off Amount (\$)	Comments
WO3	W1	500	<p>The To Do is sent for approval to the following users in the specified order:</p> <ol style="list-style-type: none"> 1. Users with the Senior Analyst To Do role 2. Users with the Manager To Do role 3. Users with the Senior Manager To Do role <p>This is because the total write off amount is greater than \$300 and hierarchical approval is required.</p>
WO4	W2	90	This write off request is automatically approved by the system because the total write off amount is less than \$100.
WO5	W2	250	The To Do is sent for approval to users with the Manager To Do role. This is because the total write off amount is either equal to \$200 or less than \$300 and hierarchical approval is not required.
WO6	W2	500	The To Do is sent for approval to users with the Senior Manager To Do role. This is because the total write off amount is greater than \$300 and hierarchical approval is not required.

The **Refund/Write Off Request Type** screen allows you to define, edit, delete, and copy a refund and write off request type. This screen consists of the following zones:

- [Refund/Write Off Request Type List](#) on page 1717
- [Refund/Write Off Request Type](#) on page 1718

Refund/Write Off Request Type List

The **Refund/Write Off Request Type List** zone lists refund and write off request types that are already defined in the system. It contains the following columns:

Column Name	Column Description
Refund/Write Off Request Type	Displays the refund or write off request type.
Description	Displays the description of the refund or write off request type.
Edit	On clicking the Edit (✎) icon, the Refund/Write Off Request Type screen appears where you can edit the details of the refund and write off request type.
Duplicate	On clicking the Duplicate (📄) icon, the Refund/Write Off Request Type screen appears where you can define a refund and write off request type using an existing refund and write off request type.
Delete	On clicking the Delete (🗑) icon, you can delete the refund or write off request type.
	Note: You can delete a refund or write off request type when you have not created a refund or write off request using the refund or write off request type.

On clicking the **Broadcast** (📡) icon corresponding to refund or write off request type, the **Refund/Write Off Request Type** zone appears with the details of the respective refund or write off request type.

Related Topics

For more information on...	See...
How to define a refund or write off request type	Defining a Refund or Write Off Request Type on page 1720
How to edit a refund or write off request type	Editing a Refund or Write Off Request Type on page 1724
How to copy a refund or write off request type	Copying a Refund or Write Off Request Type on page 1728
How to delete a refund or write off request type	Deleting a Refund or Write Off Request Type on page 1731
How to view the details of a refund or write off request type	Viewing the Refund or Write Off Request Type Details on page 1732

Refund/Write Off Request Type

The **Refund/Write Off Request Type** zone displays the details of the refund or write off request type. This zone consists of the following sections:

- **Main** — This section provides basic information about the refund or write off request type. It contains the following fields:

Field Name	Field Description
Refund/Write Off Request Type	Displays the refund or write off request type.
Refund/Write Off Request Business Object	Indicates the business object that will be used to create the refund or write off request. Note: It has a link. On clicking the link, the Business Object screen appears with the details of the respective business object.
Description	Displays the description of the refund or write off request type.
Detailed Description	Displays additional information about the refund or write off request type.
Status	Indicates the status of the refund or write off request type. The valid values are: <ul style="list-style-type: none"> • Active • Inactive
Action	Indicates whether the request type is created for refund or write off. The valid values are: <ul style="list-style-type: none"> • Refund • Write Off
Minimum Refund Amount	Displays the minimum refund amount. Note: This field appears when the Action field is set to Refund .

Field Name	Field Description
Write Up Adjustment Type	Indicates the adjustment type using which the write up adjustment must be created when the total refund amount is less than the minimum refund amount.
	Note: This field appears when the Action field is set to Refund .
Approval Required	Indicates whether approval is required while creating the refund or write off adjustments using the refund or write off request type.
Approval Profile	Indicates the approval profile which must be used to define approval hierarchy for the refund or write off request type.
	Note: This field appears when the Approval Required check box is selected. It has a link. On clicking the link, the Approval Profile screen appears with the details of the respective approval profile.
Hierarchical Approval	Indicates whether multi-level or single approval is required while creating the refund or write off adjustments using the refund or write off request type.
	Note: This field appears when the Approval Required check box is selected.
Adjustment Type	Indicates the adjustment type using which the refund or write off adjustments must be created.
	Note: It has a link. On clicking the link, the Adjustment Type screen appears with the details of the respective adjustment type.

- **Characteristics** — This section lists the characteristics of the refund or write off request type. It contains the following columns:

Column Name	Column Description
Characteristic Type	Indicates the characteristic type.
Characteristic Value	Displays the value of the characteristic type.

- **Record Actions** — This section contains the following buttons:

Button Name	Button Description
Edit	Used to edit the details of the refund or write off request type.
Delete	Used to delete the refund or write off request type.
	Note: You can delete a refund or write off request type when you have not created a refund or write off request using the refund or write off request type.
Duplicate	Used to create a new refund or write off request type using an existing refund or write off request type.

- **Record Information** — This section contains the following fields:

Field Name	Field Description
Business Object	Indicates the business object using which the refund or write off request type is created. In addition, a context menu appears corresponding to this field which helps in navigating to other screens in the application.
	Note: It has a link. On clicking the link, the Business Object screen appears where you can view the details of the respective business object.

By default, the **Refund/Write Off Request Type** zone does not appear in the **Refund/Write Off Request Type** screen. It appears when you click the **Broadcast** () icon corresponding to the refund or write off request type in the **Refund/Write Off Request Type List** zone.

Related Topics

For more information on...	See...
How to define a refund or write off request type	Defining a Refund or Write Off Request Type on page 1720
How to edit a refund or write off request type	Editing a Refund or Write Off Request Type on page 1724
How to copy a refund or write off request type	Copying a Refund or Write Off Request Type on page 1728
How to delete a refund or write off request type	Deleting a Refund or Write Off Request Type on page 1731
How to view the details of a refund or write off request type	Viewing the Refund or Write Off Request Type Details on page 1732

Defining a Refund or Write Off Request Type

Prerequisites

To define a refund or write off request type, you should have:

- Refund or Write Off request business objects defined in the application
- Approval profiles defined in the application
- Adjustment types with and without A/P request type defined in the application

Procedure

To define a refund or write off request type:

1. Click the **Admin** link in the **Application** toolbar.
A list appears.
2. From the **Admin** menu, select **R** and then click **Refund/Write Off Request Type**.
A sub-menu appears.
3. Click the **Add** option from the **Refund/Write Off Request Type** sub-menu.

The **Select Business Object** screen appears. It contains the following fields:

Field Name	Field Description	Mandatory (Yes or No)
Refund/Write Off Request Type Business Object	Used to indicate the business object that you want to use to create the refund or write off request type.	Yes

Tip: Alternatively, you can access the **Select Business Object** screen by clicking the **Add** button in the **Page Title** area of the **Refund/Write Off Request Type** screen.

Note: The **Select Business Object** screen appears when there are multiple refund and write off request type business objects defined in the application. If there is only one refund and write off request type business object defined in the application, the **Refund/Write Off Request Type** screen appears.

4. Select the required refund and write off request type business object from the respective field.
5. Click **OK**.

The **Refund/Write Off Request Type** screen appears. It contains the following sections:

- **Main** - Used to specify basic details about the refund or write off request type.
- **Characteristics** - Used to define the characteristics for the refund or write off request type.

The **Main** section contains the following fields:

Field Name	Field Description	Mandatory (Yes or No)
Refund/Write Off Request Type	Used to specify the refund or write off request type.	Yes
Business Object	Indicates the refund and write off request type business object used while defining the refund or write off request type.	Not applicable
Refund/Write Off Request Business Object	Used to indicate the business object that you want to use while creating the refund or write off request.	Yes
Description	Used to specify the description for the refund or write off request type.	Yes
Detailed Description	Used to specify additional information about the refund or write off request type.	No
Status	<p>Used to indicate the status of the refund or write off request type. The valid values are:</p> <ul style="list-style-type: none"> • Active • Inactive <p>Note: You cannot change the status of a refund or write off request type to Inactive if there are refund or write off requests which are created using the refund or write off request type and are currently in the Draft or Approval In Progress status.</p>	Yes
Action	<p>Used to indicate whether the request type is created for refund or write off. The valid values are:</p> <ul style="list-style-type: none"> • Refund • Write Off 	Yes

Field Name	Field Description	Mandatory (Yes or No)
Minimum Refund Amount	Used to specify the minimum refund amount. This field is used to define tolerance limit for refund. If the total refund amount in a refund request is less than the minimum refund amount, the system creates a write up adjustment. However, if the total refund amount in a refund request is equal to or greater than the minimum refund amount, the system creates a refund adjustment. Note: This field appears when the Action field is set to Refund .	Yes
Write Up Adjustment Type	Used to indicate the adjustment type using which the write up adjustment must be created when the total refund amount is less than the minimum refund amount. Note: This field appears when the Action field is set to Refund . You can create write up adjustments only using those adjustment types where A/P request type is not defined.	Yes
Approval Required	Used to indicate whether approval is required while creating the refund or write off adjustments using the refund or write off request type.	No
Approval Profile	Used to indicate the approval profile which must be used to define approval hierarchy for the refund or write off request type. Note: This field appears when the Approval Required check box is selected.	Yes (Conditional) Note: This field is required when the Approval Required check box is selected.
Hierarchical Approval	Used to indicate whether multi-level or single-level approval is required while creating the refund or write off adjustments using the refund or write off request type. Note: This field appears only when the Approval Required check box is selected.	No

Field Name	Field Description	Mandatory (Yes or No)
Refund Adjustment Type	Used to indicate the adjustment type using which the refund adjustments must be created. This default adjustment type appears when you select the payments or credit bill line items for refund. You can then change the adjustment type, if required, while editing a refund request.	Yes
	<p>Note:</p> <p>This field appears when the Action field is set to Refund.</p> <p>The list includes only those adjustment types where A/P request type is defined.</p>	
Write Off Adjustment Type	Used to indicate the adjustment type using which the write off adjustments must be created. This default adjustment type appears when you select the debit bill line items for write off. You can then change the adjustment type, if required, while editing a write off request.	Yes
	<p>Note:</p> <p>This field appears when the Action field is set to Write Off.</p> <p>You can create write off adjustments only using those adjustment types where A/P request type is not defined.</p>	

6. Enter the required details depending on whether you want to define refund or write off request type.

Note: You can search for an adjustment type by clicking the **Search** (🔍) icon corresponding to the respective field.

7. Define characteristics for the refund or write off request type, if required.
8. Click **Save**.

The refund or write off request type is defined.

Related Topics

For more information on...	See...
Refund/Write Off Request Type screen	Refund/Write Off Request Type on page 1713
How to define a characteristic for a refund or write off request type	Defining a Characteristic for a Refund or Write Off Request Type on page 1723

Defining a Characteristic for a Refund or Write Off Request Type

Prerequisites

To define a characteristic for a refund or write off request type, you should have:

- Characteristic types defined in the application (where the characteristic entity is set to **Refund Write Off Request Type**)

Procedure

To define a characteristic for a refund or write off request type:

1. Ensure that the **Characteristics** section is expanded when you are defining, editing, or copying a refund or write off request type.

The **Characteristics** section contains the following fields:

Field Name	Field Description	Mandatory (Yes or No)
Characteristic Type	Used to indicate the characteristic type.	Yes (Conditional)
	Note: The list includes only those characteristic types where the characteristic entity is set to Refund Write Off Request Type .	Note: This field is required when you are defining a characteristic for the refund or write off request type.
Characteristic Value	Used to specify the value for the characteristic type.	Yes (Conditional)
	Note: On specifying the value for a predefined characteristic type, the description of the characteristic value appears corresponding to the Characteristic Value field.	Note: This field is required when you are defining a characteristic for the refund or write off request type.

2. Enter the required details in the **Characteristics** section.

Note: If you select a predefined characteristic type, the **Search** (🔍) icon appears corresponding to the **Characteristic Value** field. On clicking the **Search** icon, you can search for a predefined characteristic value.

3. If you want to define more than one characteristic for the refund or write off request type, click the **Add** (+) icon and then repeat step 2.

Note: However, if you want to remove a characteristic from the refund or write off request type, click the **Delete** (🗑️) icon corresponding to the characteristic.

Related Topics

For more information on...	See...
How to define a refund or write off request type	Defining a Refund or Write Off Request Type on page 1720
How to edit a refund or write off request type	Editing a Refund or Write Off Request Type on page 1724
How to copy a refund or write off request type	Copying a Refund or Write Off Request Type on page 1728

Editing a Refund or Write Off Request Type

Prerequisites

To edit a refund or write off request type, you should have:

- Refund or Write Off request business objects defined in the application
- Approval profiles defined in the application

- Adjustment types with and without A/P request type defined in the application

Procedure

To edit a refund or write off request type:

1. Click the **Admin** link in the **Application** toolbar.
A list appears.
2. From the **Admin** menu, select **R** and then click **Refund/Write Off Request Type**.
A sub-menu appears.
3. Click the **Search** option from the **Refund/Write Off Request Type** sub-menu.
The **Refund/Write Off Request Type** screen appears.
4. In the **Refund/Write Off Request Type List** zone, click the **Edit**  icon in the **Edit** column corresponding to the refund or write off request type whose details you want to edit.

The **Refund/Write Off Request Type** screen appears. It contains the following sections:

- **Main** - Used to specify basic details about the refund or write off request type.
- **Characteristics** - Used to define the characteristics for the refund or write off request type.

The **Main** section contains the following fields:

Field Name	Field Description	Mandatory (Yes or No)
Refund/Write Off Request Type	Displays the refund or write off request type.	Not applicable
Business Object	Indicates the refund and write off request type business object used while defining the refund or write off request type.	Not applicable
Refund/Write Off Request Business Object	Used to indicate the business object that you want to use while creating the refund or write off request.	Yes
Description	Used to specify the description for the refund or write off request type.	Yes
Detailed Description	Used to specify additional information about the refund or write off request type.	No
Status	Used to indicate the status of the refund or write off request type. The valid values are: <ul style="list-style-type: none"> • Active • Inactive <div style="border: 1px solid black; padding: 5px; margin-top: 10px;"> <p>Note: You cannot change the status of a refund or write off request type to Inactive if there are refund or write off requests which are created using the refund or write off request type and are currently in the Draft or Approval In Progress status.</p> </div>	Yes

Field Name	Field Description	Mandatory (Yes or No)
Action	<p>Indicates whether the request type is created for refund or write off. The valid values are:</p> <ul style="list-style-type: none"> • Refund • Write Off 	Not applicable
Minimum Refund Amount	<p>Used to specify the minimum refund amount. This field is used to define tolerance limit for refund. If the total refund amount in a refund request is less than the minimum refund amount, the system creates a write up adjustment. However, if the total refund amount in a refund request is equal to or greater than the minimum refund amount, the system creates a refund adjustment.</p> <p>Note: This field appears when the Action field is set to Refund.</p>	Yes
Write Up Adjustment Type	<p>Used to indicate the adjustment type using which the write up adjustment must be created when the total refund amount is less than the minimum refund amount.</p> <p>Note: This field appears when the Action field is set to Refund. You can create write up adjustments only using those adjustment types where A/P request type is not defined.</p>	Yes
Approval Required	Used to indicate whether approval is required while creating the refund or write off adjustments using the refund or write off request type.	No
Approval Profile	<p>Used to indicate the approval profile which must be used to define approval hierarchy for the refund or write off request type.</p> <p>Note: This field appears when the Approval Required check box is selected.</p>	<p>Yes (Conditional)</p> <p>Note: This field is required when the Approval Required check box is selected.</p>

Field Name	Field Description	Mandatory (Yes or No)
Hierarchical Approval	Used to indicate whether multi-level or single-level approval is required while creating the refund or write off adjustments using the refund or write off request type.	No
	Note: This field appears only when the Approval Required check box is selected.	
Refund Adjustment Type	Used to indicate the adjustment type using which the refund adjustments must be created. This default adjustment type appears when you select the payments or credit bill line items for refund. You can then change the adjustment type, if required, while editing a refund request.	Yes
	Note: This field appears when the Action field is set to Refund . The list includes only those adjustment types where A/P request type is defined.	
Write Off Adjustment Type	Used to indicate the adjustment type using which the write off adjustments must be created. This default adjustment type appears when you select the debit bill line items for write off. You can then change the adjustment type, if required, while editing a write off request.	Yes
	Note: This field appears when the Action field is set to Write Off . You can create write off adjustments only using those adjustment types where A/P request type is not defined.	

Tip: Alternatively, you can click the **Edit** button in the **Refund/Write Off Request Type** zone to edit the details of the refund or write off request type.

5. Modify the required details in the **Main** section.

Note: You can search for an adjustment type by clicking the **Search** (🔍) icon corresponding to the respective field.

6. Define, edit, or remove characteristics of the refund or write off request type, if required.
7. Click **Save**.

The changes made to the refund or write off request type are saved.

Related Topics

For more information on...	See...
Refund/Write Off Request Type screen	Refund/Write Off Request Type on page 1713
Refund/Write Off Request Type List zone	Refund/Write Off Request Type List on page 1717
Refund/Write Off Request Type zone	Refund/Write Off Request Type on page 1718
How to define a characteristic for a refund or write off request type	Defining a Characteristic for a Refund or Write Off Request Type on page 1723

Copying a Refund or Write Off Request Type

Instead of creating a refund or write off request type from scratch, you can create a new refund or write off request type using an existing refund or write off request type. This is possible through copying a refund or write off request type. On copying a refund or write off request type, the details including the characteristics are copied to the new refund or write off request type. You can then edit the details, if required.

Prerequisites

To copy a refund or write off request type, you should have:

- Refund or Write Off request type (whose copy you want to create) defined in the application
- Refund or Write Off request business objects defined in the application
- Approval profiles defined in the application
- Adjustment types with and without A/P request type defined in the application

Procedure

To copy a refund or write off request type:

1. Click the **Admin** link in the **Application** toolbar.
A list appears.
2. From the **Admin** menu, select **R** and then click **Refund/Write Off Request Type**.
A sub-menu appears.
3. Click the **Search** option from the **Refund/Write Off Request Type** sub-menu.
The **Refund/Write Off Request Type** screen appears.
4. In the **Refund/Write Off Request Type List** zone, click the **Duplicate**  icon in the **Duplicate** column corresponding to the refund or write off request type whose copy you want to create.

The **Refund/Write Off Request Type** screen appears. It contains the following sections:

- **Main** - Used to specify basic details about the refund or write off request type.
- **Characteristics** - Used to define the characteristics for the refund or write off request type.

The **Main** section contains the following fields:

Field Name	Field Description	Mandatory (Yes or No)
Refund/Write Off Request Type	Used to specify the refund or write off request type.	Yes

Field Name	Field Description	Mandatory (Yes or No)
Business Object	Indicates the refund and write off request type business object used while defining the refund or write off request type.	Not applicable
Refund/Write Off Request Business Object	Used to indicate the business object that you want to use while creating the refund or write off request.	Yes
Description	Used to specify the description for the refund or write off request type.	Yes
Detailed Description	Used to specify additional information about the refund or write off request type.	No
Status	<p>Used to indicate the status of the refund or write off request type. The valid values are:</p> <ul style="list-style-type: none"> • Active • Inactive <p>Note: You cannot change the status of a refund or write off request type to Inactive if there are refund or write off requests which are created using the refund or write off request type and are currently in the Draft or Approval In Progress status.</p>	Yes
Action	<p>Used to indicate whether the request type is created for refund or write off. The valid values are:</p> <ul style="list-style-type: none"> • Refund • Write Off 	Yes
Minimum Refund Amount	<p>Used to specify the minimum refund amount. This field is used to define tolerance limit for refund. If the total refund amount in a refund request is less than the minimum refund amount, the system creates a write up adjustment. However, if the total refund amount in a refund request is equal to or greater than the minimum refund amount, the system creates a refund adjustment.</p> <p>Note: This field appears when the Action field is set to Refund.</p>	Yes

Field Name	Field Description	Mandatory (Yes or No)
Write Up Adjustment Type	Used to indicate the adjustment type using which the write up adjustment must be created when the total refund amount is less than the minimum refund amount.	Yes
	<p>Note:</p> <p>This field appears when the Action field is set to Refund.</p> <p>You can create write up adjustments only using those adjustment types where A/P request type is not defined.</p>	
Approval Required	Used to indicate whether approval is required while creating the refund or write off adjustments using the refund or write off request type.	No
Approval Profile	Used to indicate the approval profile which must be used to define approval hierarchy for the refund or write off request type.	Yes (Conditional)
	<p>Note: This field appears when the Approval Required check box is selected.</p>	
Hierarchical Approval	Used to indicate whether multi-level or single-level approval is required while creating the refund or write off adjustments using the refund or write off request type.	No
	<p>Note: This field appears only when the Approval Required check box is selected.</p>	
Refund Adjustment Type	Used to indicate the adjustment type using which the refund adjustments must be created. This default adjustment type appears when you select the payments or credit bill line items for refund. You can then change the adjustment type, if required, while editing a refund request.	Yes
	<p>Note:</p> <p>This field appears when the Action field is set to Refund.</p> <p>The list includes only those adjustment types where A/P request type is defined.</p>	

Field Name	Field Description	Mandatory (Yes or No)
Write Off Adjustment Type	Used to indicate the adjustment type using which the write off adjustments must be created. This default adjustment type appears when you select the debit bill line items for write off. You can then change the adjustment type, if required, while editing a write off request.	Yes
	<p>Note:</p> <p>This field appears when the Action field is set to Write Off.</p> <p>You can create write off adjustments only using those adjustment types where A/P request type is not defined.</p>	

Tip: Alternatively, you can click the **Duplicate** button in the **Refund/Write Off Request Type** zone to create a copy of the refund or write off request type.

- Enter the required details in the **Main** section.

Note: You can search for an adjustment type by clicking the **Search** (🔍) icon corresponding to the respective field.

- Define, edit, or remove characteristics of the refund or write off request type, if required.
- Click **Save**.

The new refund or write off request type is defined.

Related Topics

For more information on...	See...
Refund/Write Off Request Type screen	Refund/Write Off Request Type on page 1713
Refund/Write Off Request Type List zone	Refund/Write Off Request Type List on page 1717
Refund/Write Off Request Type zone	Refund/Write Off Request Type on page 1718
How to define a characteristic for a refund or write off request type	Defining a Characteristic for a Refund or Write Off Request Type on page 1723

Deleting a Refund or Write Off Request Type

Procedure

To delete a refund or write off request type:

- Click the **Admin** link in the **Application** toolbar.
A list appears.
- From the **Admin** menu, select **R** and then click **Refund/Write Off Request Type**.
A sub-menu appears.
- Click the **Search** option from the **Refund/Write Off Request Type** sub-menu.
The **Refund/Write Off Request Type** screen appears.

- In the **Refund/Write Off Request Type List** zone, click the **Delete** () icon in the **Delete** column corresponding to the refund or write off request type that you want to delete.

A message appears confirming whether you want to delete the refund or write off request type.

Note: You can delete a refund or write off request type when you have not defined a refund or write off request using the refund or write off request type.

Tip: Alternatively, you can click the **Delete** button in the **Refund/Write Off Request Type** zone to delete the refund or write off request type.

- Click **OK**.

The refund or write off request type is deleted.

Related Topics

For more information on...	See...
Refund/Write Off Request Type screen	Refund/Write Off Request Type on page 1713
Refund/Write Off Request Type List zone	Refund/Write Off Request Type List on page 1717
Refund/Write Off Request Type zone	Refund/Write Off Request Type on page 1718

Viewing the Refund or Write Off Request Type Details

Procedure

To view the details of a refund or write off request type:

- Click the **Admin** link in the **Application** toolbar.
A list appears.
- From the **Admin** menu, select **R** and then click **Refund/Write Off Request Type**.
A sub-menu appears.
- Click the **Search** option from the **Refund/Write Off Request Type** sub-menu.
The **Refund/Write Off Request Type** screen appears.
- In the **Refund/Write Off Request Type List** zone, click the **Broadcast** () icon corresponding to the refund or write off request type whose details you want to view.
The **Refund/Write Off Request Type** zone appears.
- View the details of the refund or write off request type in the **Refund/Write Off Request Type** zone.

Related Topics

For more information on...	See...
Refund/Write Off Request Type screen	Refund/Write Off Request Type on page 1713
Refund/Write Off Request Type List zone	Refund/Write Off Request Type List on page 1717
Refund/Write Off Request Type zone	Refund/Write Off Request Type on page 1718

Refund/Write Off Request

The **Refund/Write Off Request** screen allows you to search for a refund and write off request using various search criteria. It also allows you to create a refund and write off requests. Through this screen, you can navigate to the following screens:

- [Refund Request](#) on page 1744
- [Write Off Request](#) on page 1777

This screen consists of the following zones:

- [Search Refund/Write Off Request](#) on page 1733

Search Refund/Write Off Request

The **Search Refund/Write Off Request** zone allows you to search for refund and write off requests using various search criteria. This zone contains the following two sections:

- **Search Criteria** — The **Search Criteria** section contains the following fields:

Field Name	Field Description	Mandatory (Yes or No)
Search By	<p>Used to indicate whether you want to search for a refund or write off request using request, payment, or bill details. The valid values are:</p> <ul style="list-style-type: none"> • Request Details — Used when you want to search for refund and/or write off requests. • Payment Details — Used when you want to search for refund requests. • Bill Details — Used when you want to search for refund and/or write off requests. <p>Note: By default, the Request Details option is selected.</p>	Yes
Action	<p>Used to indicate whether you want to search for refund or write off requests. The valid values are:</p> <ul style="list-style-type: none"> • Refund • Write Off <p>Note: This field appears when you select the Request Details or Bill Details option from the Search By list.</p>	No

Field Name	Field Description	Mandatory (Yes or No)
Refund/Write Off Request Type	Used to search refund or write off requests which are created using a particular refund or write off request type.	No
	<p>Note:</p> <p>This field appears when you select the Request Details option from the Search By list.</p> <p>The refund or write off request types are listed when you set the Action field to either Refund or Write Off.</p>	
Status	Used to search refund or write off requests with a particular status. The valid values are: <ul style="list-style-type: none"> • Approval In Progress • Cancelled • Draft • Processed • Rejected • Voided 	No
	<p>Note:</p> <p>This field appears when you select the Request Details option from the Search By list.</p> <p>The Voided status is applicable while searching for refund requests and the Cancelled status is applicable while searching for write off requests.</p>	
User ID	Used to search refund or write off requests which are created by a particular user.	No
	<p>Note: This field appears when you select the Request Details option from the Search By list.</p>	
Created From	Used to search refund or write off requests which are created from a particular date onwards.	No
	<p>Note: This field appears when you select the Request Details option from the Search By list.</p>	
To	Used to search refund or write off requests which are created till a particular date.	No
	<p>Note:</p> <p>By default, the current date appears in this field.</p> <p>This field appears when you select the Request Details option from the Search By list.</p>	

Field Name	Field Description	Mandatory (Yes or No)
Refund/Write Off Request ID	Used to search a particular refund or write off request.	No
	Note: This field appears when you select the Request Details option from the Search By list.	
Payment Event ID	Used to search refund requests which includes a particular payment event for refund.	No
	Note: This field appears when you select the Payment Details option from the Search By list.	
Payor Account ID	Used to search refund requests which are created for a particular payor account.	No
	Note: This field appears when you select the Payment Details option from the Search By list.	
Payor Name	Used to search refund requests which are created for a particular payor.	No
	Note: This field appears when you select the Payment Details option from the Search By list.	
Payment Date	Used to search refund requests which includes payments made on a particular date.	No
	Note: This field appears when you select the Payment Details option from the Search By list.	
MICR ID	Used to search refund requests which includes payments made with a particular MICR code.	No
	Note: This field appears when you select the Payment Details option from the Search By list.	
Check Number	Used to search refund request which includes payment made through a particular check.	No
	Note: This field appears when you select the Payment Details option from the Search By list.	
Bill ID	Used to search refund or write off requests which includes bill segments or adjustments of a particular bill.	No
	Note: This field appears when you select the Bill Details option from the Search By list.	

Field Name	Field Description	Mandatory (Yes or No)
Bill Date From	Used to search refund or write off requests which includes bill segments or adjustments of bills which are created from a particular date onwards. Note: This field appears when you select the Bill Details option from the Search By list.	No
To	Used to search refund or write off requests which includes bill segments or adjustments of bills which are created till a particular date. Note: By default, the current date appears in this field. This field appears when you select the Bill Details option from the Search By list.	No

Note: You must specify at least one search criterion while searching for a refund or write off request.

- **Search Results** — On clicking the **Search** button, the search results appear based on the specified search criteria. The **Search Results** section contains the following columns:

Column Name	Column Description
Create Date/Time	Displays the date and time when the refund or write off request is created.
Refund/Write Off Request Information	Displays information about the refund or write off request. Note: It has a link. On clicking the link, the Refund Request or Write Off Request screen appears depending on whether the request is for refund or write off.
Status	Indicates the status of the refund or write off request.
Action	Indicates whether the request is created for refund or write off. The valid values are: <ul style="list-style-type: none"> • Refund • Write Off Note: This column appears when you select the Request Details or Bill Details option from the Search By list.
Refund/Write Off Amount	Displays the total refund or write off amount. Note: This column appears when you select the Request Details or Bill Details option from the Search By list.
Refund Amount	Displays the total refund amount. Note: This column appears when you select the Payment Details option from the Search By list.

Column Name	Column Description
Account Information	Displays additional information about the account for which the refund or write off request is created.
	Note: It has a link. On clicking the link, the Account screen appears with the details of the respective account.
Created By	Indicates the user who has created the refund or write off request.

Related Topics

For more information on...	See...
How to search for a refund or write off request	Searching for a Refund or Write Off Request on page 1737
How to view the details of a refund request	Viewing the Refund Request Details on page 1743
How to view the details of a write off request	Viewing the Write Off Request Details on page 1743
How to create a refund request	Creating a Refund Request on page 1738
How to create a write off request	Creating a Write Off Request on page 1740

Searching for a Refund or Write Off Request

Prerequisites

To search for a refund or write off request, you should have:

- Refund or Write Off request types defined in the application

Procedure

To search for a refund or write off request:

1. Click the **Menu** link in the **Application** toolbar.
A list appears.
2. From the **Main** menu, select **Accounting and Receivable** and then click **Refund/Write Off Request**.
A sub-menu appears.
3. Click the **Search** option from the **Refund/Write Off Request** sub-menu.
The **Refund/Write Off Request** screen appears.
4. Enter the search criteria in the **Search Refund/Write Off Request** zone depending on whether you want to search for a refund or write off request.

Note: ORMB search engine supports wildcard search, where you can substitute the percentage (%) symbol as a stand in for any word or letter in a search criteria. You can use the ‘%’ wildcard character in all input fields except the date and ID fields. The ‘%’ wildcard character is suffixed automatically at the end of the partial search criteria. Therefore, you may or may not specify the wildcard character at the end of the partial search criteria. However, you have to prefix the wildcard character manually wherever required.

5. Click **Search**.

A list of refund or write off requests that meet the search criteria appears in the **Search Results** section.

Related Topics

For more information on...	See...
Refund/Write Off Request screen	Refund/Write Off Request on page 1733
Search Refund/Write Off Request zone	Search Refund/Write Off Request on page 1733

Creating a Refund Request

Prerequisites

To create a refund request, you should have:

- Refund request types defined in the application

Procedure

To create a refund request:

1. Do either of the following:

If you want to...	Then...
Define a refund request from the Account Receivable Central screen	<ol style="list-style-type: none"> 1. Click the Main link in the Application toolbar. A list appears. 2. From the Main menu, select Accounting and Receivable and then click Account Receivable Central. 3. Search for the bill in the Account Receivable Central screen. 4. In the Search Results section, select the required bill and then click Refund. <p>Note: Only one bill at a time is allowed to select for Refund Request from the Account Receivable Central screen.</p>
Define a refund request from the Refund Request screen	<ol style="list-style-type: none"> 1. Click the Main link in the Application toolbar. A list appears. 2. From the Main menu, select Accounting and Receivable and then click Refund/Write Off Request. A sub-menu appears. 3. Click the Add option from the Refund/Write Off Request sub-menu.

The **Select Request Type** screen appears. It contains the following fields:

Field Name	Field Description	Mandatory (Yes or No)
Action	<p>Displays the type of request (refund or write off) to be created.</p> <p>Note:</p> <p>This field is pre-populated if the refund request is created from the Account Receivable Central screen.</p> <p>This field is editable if the refund request is created from the Refund/Write Off Request screen.</p>	Not applicable
Refund/Write Off Request Type	<p>Used to indicate the request type using which you want to create the refund or write off request.</p> <p>Note: The refund request types are listed when you set the Action field to Refund and the write off request types are listed when you set the Action field to Write Off.</p>	Yes
Account	<p>Used to indicate the account for which you want to create the refund or write off request.</p> <p>Note:</p> <p>This field is pre-populated if the refund request is created from the Account Receivable Central screen.</p> <p>This field is editable if the refund request is created from the Refund/Write Off Request screen.</p> <p>You can search for an account by clicking the Search (🔍) icon corresponding to the respective field.</p>	Yes

Tip:

Alternatively, you can access the **Select Request Type** screen:

- By clicking the **Add** button in the **Page Title** area of **Refund/Write Off Request** screen.
- By selecting the payment which you want to refund in the **Payment Event Summary** screen and then clicking the **Refund** button. Note that the system will allow you to refund only those payments which are in the **Frozen** status and matched against the suspense or excess credit contract.

2. Select the required refund request type from the respective field.
3. Click **Save**.

The refund request is defined and the status of the refund request is set to **Draft**. The **Refund Request** screen appears where you can view the details of the refund request. It contains the following tabs:

Note: The refund request can be created only for bill with outstanding amount lesser than zero.

- **Main** – Displays information about the refund request. It contains the following zones:
 - **Refund Request** – Displays the details of the refund request.
 - **Refund Details** – Lists the entities, such as payment events, payments, and/or credit bill line items (such as credit bill segments and adjustments), of the account which must be refunded.
 - **Payments** — Used to search payment events or individual payments that you want to refund. This tab appears only when the refund request is in the **Draft** status.
 - **Bills** — Used to search bills with credit line items, such as credit bill segments and adjustments, that you want to refund. This tab appears when the refund request is in the **Draft** status.
 - **Log** – Lists the complete trail of actions performed on the refund request.
- 4. Add payment events, payments, or credit bill line items that you want to refund.
- 5. Edit the refund amount of each entity, if required.
- 6. Define characteristics for the refund request, if required.
- 7. Override the address if you want to sent the refund to an address other than the account’s main customer address.

Related Topics

For more information on...	See...
Refund Request screen	Refund Request on page 1744
Account Receivable Central screen	Account Receivable Central on page 1546
How to add a payment event to the refund request	Adding a Payment Event to the Refund Request on page 1758
How to add a payment to the refund request	Adding a Payment to the Refund Request on page 1759
How to add a credit bill line item to the refund request	Adding a Credit Bill Line Item to the Refund Request on page 1761
How to edit a refund request	Editing a Refund Request on page 1762
How to define a characteristic for a refund request	Defining a Characteristic for a Refund Request on page 1757

Creating a Write Off Request

Prerequisites

To create a write off request, you should have:

- Write off request types defined in the application

Procedure

To create a write off request:

1. Do either of the following:

If you want to...	Then...
Define a write off request from the Account Receivable Central screen	<ol style="list-style-type: none"> 1. Click the Main link in the Application toolbar. A list appears.

If you want to...	Then...
	<ol style="list-style-type: none"> 2. From the Main menu, select Accounting and Receivable and then click Account Receivable Central. 3. Search for the bill in the Account Receivable Central screen. 4. In the Search Results section, select the required bill and then click Write Off. <p>Note: Only one bill at a time is allowed to select for Write Off Request from the Account Receivable Central screen.</p>
Define a write off request from the Write Off Request screen	<ol style="list-style-type: none"> 1. Click the Main link in the Application toolbar. A list appears. 2. From the Main menu, select Accounting and Receivable and then click Refund/Write Off Request. A sub-menu appears. 3. Click the Add option from the Refund/Write Off Request sub-menu.

The **Select Request Type** screen appears. It contains the following fields:

Field Name	Field Description	Mandatory (Yes or No)
Action	<p>Displays the type of request (refund or write off) to be created.</p> <p>Note: This field is pre-populated if the write off request is created from the Account Receivable Central screen. This field is editable if the write off request is created from the Refund/Write Off Request screen.</p>	Yes
Refund/Write Off Request Type	<p>Used to indicate the request type using which you want to create the refund or write off request.</p> <p>Note: The refund request types are listed when you set the Action field to Refund and the write off request types are listed when you set the Action field to Write Off.</p>	Yes

Field Name	Field Description	Mandatory (Yes or No)
Account	Used to indicate the account for which you want to create the refund or write off request. Note: This field is pre-populated if the write off request is created from the Account Receivable Central screen. This field is editable if the write off request is created from the Refund/Write Off Request screen. You can search for an account by clicking the Search (🔍) icon corresponding to the respective field.	Yes

Tip: Alternatively, you can access the **Select Request Type** screen by clicking the **Add** button in the **Page Title** area of the **Refund/Write Off Request** screen.

2. Select the required write off request type and account from the respective fields.
3. Click **Save**.

The write off request is defined and the status of the write off request is set to **Draft**. The **Write Off Request** screen appears with the details of the write off request. It contains the following tabs:

Note: The write off request can be created only for bill with outstanding amount greater than zero.

- **Main** – Displays information about the write off request. It contains the following zones:
 - **Write Off Request** – Displays the details of the write off request.
 - **Write Off Details** – Lists the debit bill line items (such as debit bill segments and adjustments) of the account which must be written off.
 - **Bills** — Used to search bills with debit line items, such as debit bill segments and adjustments, that you want to write off. This tab appears when the write off request is in the **Draft** status.
 - **Log** – Lists the complete trail of actions performed on the write off request.
4. Add debit bill line items that you want to write off.
 5. Edit the write off amount of each entity, if required.
 6. Define characteristics for the write off request, if required.

Related Topics

For more information on...	See...
Write Off Request screen	Write Off Request on page 1777
Account Receivable Central screen	Account Receivable Central on page 1546
How to add a debit bill line item to the write off request	Adding a Debit Bill Line Item to the Write Off Request on page 1790
How to edit a write off request	Editing a Write Off Request on page 1791
How to define a characteristic for a write off request	Defining a Characteristic for a Write Off Request on page 1787

Viewing the Refund Request Details

Procedure

To view the details of a refund request:

1. Search for the refund request in the **Refund/Write Off Request** screen.
2. In the **Search Results** section, click the link in the **Refund/Write Off Request Information** column corresponding to the refund request whose details you want to view.

The **Refund Request** screen appears. It consists of the following tabs:

- **Main** – Displays information about the refund request. It contains the following zones:
 - **Refund Request** – Displays the details of the refund request.
 - **Refund Details** – Lists the entities, such as payment events, payments, and/or credit bill line items (such as credit bill segments and adjustments), of the account which must be refunded.
 - **Payments** — Used to search payment events or individual payments that you want to refund. This tab appears only when the refund request is in the **Draft** status.
 - **Bills** — Used to search bills with credit line items, such as credit bill segments and adjustments, that you want to refund. This tab appears when the refund request is in the **Draft** status.
 - **Log** – Lists the complete trail of actions performed on the refund request.
3. View the details of the refund request in the **Refund Request** zone.
 4. View the entities (such as payment events, payments, or credit bill line items) which must be refunded in the **Refund Details** zone.

Related Topics

For more information on...	See...
Refund Request screen	Refund Request on page 1744
Refund Request zone	Refund Request on page 1745
Refund Details zone	Refund Details on page 1747
How to search for a refund request	Searching for a Refund or Write Off Request on page 1737

Viewing the Write Off Request Details

Procedure

To view the details of a write off request:

1. Search for the write off request in the **Refund/Write Off Request** screen.
2. In the **Search Results** section, click the link in the **Refund/Write Off Request Information** column corresponding to the write off request whose details you want to view.

The **Write Off Request** screen appears. It consists of the following tabs:

- **Main** – Displays information about the write off request. It contains the following zones:
 - **Write Off Request** – Displays the details of the write off request.

- **Write Off Details** – Lists the debit bill line items, such as debit bill segments and adjustments, of the account which must be written off.
 - **Bills** — Used to search bills with debit line items, such as debit bill segments and adjustments, that you want to write off. This tab appears when the write off request is in the **Draft** status.
 - **Log** – Lists the complete trail of actions performed on the write off request.
3. View the details of the write off request in the **Write Off Request** zone.
 4. View the entities (such as debit bill segments and adjustments) which must be written off in the **Write Off Details** zone.

Related Topics

For more information on...	See...
Write Off Request screen	Write Off Request on page 1777
Write Off Request zone	Write Off Request on page 1778
Write Off Details zone	Write Off Details on page 1780
How to search for a write off request	Searching for a Refund or Write Off Request on page 1737

Refund Request

Once you create a refund request, the **Refund Request** screen allows you to:

- Edit and delete a refund request
- View the details of a refund request
- Submit a refund request for approval
- Approve or reject a refund request
- View the log of a refund request
- Add a log entry for a refund request
- Void a refund request

This screen consists of the following tabs:

- **Main** – Displays information about the refund request. It contains the following zones:
 - **Refund Request** – Displays the details of the refund request.
 - **Refund Details** – Lists the entities, such as payment events, payments, and/or credit bill line items (such as credit bill segments and adjustments), of the account which must be refunded.
 - **Bill Line Items** — Displays the details of the bill which must be refunded.

Note: This zone appears when you click the Broadcast () icon corresponding to the entity type as **Bill** in the **Refund Details** zone.

- **Bills** — Used to search bills with credit line items, such as credit bill segments and adjustments, that you want to refund. It contains the following zones:
 - **Search Bills** — Lists completed bills of the account which are either with credit balance or have one or more credit line items, such as bill segments and adjustments. You can filter the bills using various search criteria.

- **Bill Line Items** — Lists the debit and credit bill segments and adjustments of the bill.

This tab appears when the refund request is in the **Draft** status.

- **Payments** — Used to search payment events or individual payments that you want to refund. It contains the following zones:
 - **Search Payment Event** — Lists the payment events which are created for the account. You can filter the payment events using various search criteria.
 - **Payments** — Lists all payments created through the payment event.

This tab appears when the refund request is in the **Draft** status.

- **Log** – Lists the complete trail of actions performed on the refund request.

Refund Request - Main

The **Main** tab displays information about the refund request. It contains the following zones:

- [Refund Request](#) on page 1745
- [Refund Details](#) on page 1747
- [Bill Line Items](#) on page 1748

Refund Request

The **Refund Request** zone displays the details of the refund request. This zone contains the following sections:

- **Main** — This section provides basic information about the refund request. It contains the following fields:

Field Name	Field Description
Refund Request Information	Displays information about the refund request.
Refund Request Type	Indicates the refund request type using which the refund request is created. Note: It has a link. On clicking the link, the Refund/Write Off Request Type screen appears where you can view the details of the refund request type.
Status	Indicates the status of the refund request. The valid values are: <ul style="list-style-type: none"> • Draft • Approval In Progress • Rejected • Processed • Voided
Status Reason	Indicates the reason why the refund request is rejected or voided. Note: This field appears when the refund request is in the Rejected or Voided status. It has a link. On clicking the link, the Status Reason screen appears where you can view the details of the rejected or voided reason.

Field Name	Field Description
Account Information	Indicates the account for which the refund request is created.
	Note: It has a link. On clicking the link, the Account screen appears where you can view the details of the respective account.
Person Name	Indicates the person for whom the refund request is created.
Override Address	Indicates whether the account's mailing address is overridden.
Address 1	Displays the house number and apartment name.
Address 2	Displays the street name.
Address 3	Indicates the landmark, if available.
Address 4	Displays the village, town, or city name.
City	Displays the city name.
State	Displays the state name.
Country	Displays the country name.
Postal	Displays the postal or zip code.
Comments	Displays additional information about the refund request.
Total Refund Amount	Displays the total refund amount.

- **Characteristics** — Lists the characteristics defined for the refund request. It contains the following fields:

Field Name	Field Description
Effective Date	Indicates the date from when the characteristic is effective for the refund request.
Characteristic Type	Indicates the characteristic type.
Characteristic Value	Displays the value of the characteristic type.

- **Record Actions** — This section contains the following buttons:

Button Name	Button Description
Edit	Used to edit the details of the refund request.
	Note: The Edit button appears when the refund request is in the Draft status.
Delete	Used to delete the refund request.
	Note: The Delete button appears when the refund request is in the Draft status.
Submit	Used to submit the refund request for approval.
	Note: The Submit button appears when the refund request is in the Draft status.

Button Name	Button Description
Approve	Used to approve the refund request.
	<p>Note: The Approve button appears when:</p> <ul style="list-style-type: none"> The refund request is in the Approval In Progress status. A user with the approval To Do role is reviewing the refund request.
Reject	Used to reject the refund request.
	<p>Note: The Reject button appears when:</p> <ul style="list-style-type: none"> The refund request is in the Approval In Progress status. A user with the approval To Do role is reviewing the refund request.
Void	Used to void the refund request.
	<p>Note: The Void button appears when the refund request is in the Processed status.</p>

- **Record Information** — This section contains the following fields:

Field Name	Field Description
Business Object	Indicates the business object using which the refund request is created. In addition, a context menu appears corresponding to this field which helps in navigating to other screens in the application.
	<p>Note: It has a link. On clicking the link, the Business Object screen appears where you can view the details of the respective business object.</p>
Status Date/Time	Displays the date and time when the refund request status is updated
Create Date/Time	Displays the date and time when the refund request is created.

Refund Details

The **Refund Details** zone lists the payment events, payments, and credit bill line items (such as bill segments and adjustments) that you have added to the refund request. This zone contains the following columns:

Column Name	Column Description
Entity ID	Displays the entity ID.
Entity Type	Indicates whether the entity is a payment event, payment, bill, bill segment, or an adjustment.
Currency	Indicates the currency in which the entity was created.
Entity Amount	Displays the entity amount.
Refund Amount	Displays the amount that must be refunded.
	<p>Note: By default, the amount which is eligible for refund appears in this column. You can edit the amount, if required. However, you cannot specify the amount greater than the eligible amount.</p>

Column Name	Column Description
Contract Information	Displays additional information about the contract against which the bill segment or adjustment is created or against which the payment is matched. In addition, this column has a context menu which helps in navigating to other screens in the application.
	Note: It has a link. On clicking the link, the Contract screen appears where you can view the details of the respective contract.
Adjustment Type	Indicates the adjustment type using which the refund adjustment must be created.
	Note: By default, the adjustment type specified in the refund request type appears in this column. You can change the adjustment type, if required, by editing the refund request.
Adjustment Information	Displays information about the refund adjustment.
	<p>Note:</p> <p>It has a link. On clicking the link, the Adjustment screen appears where you can view the details of the respective adjustment.</p> <p>The data appears in this column when the status of the refund request is Processed.</p> <p>The information string appears when an algorithm of the C1-ADI-INFO algorithm type is attached to the Adjustment Information system event in the Algorithms tab of the Installation Options — Framework screen.</p>

Note: On clicking the Broadcast () icon corresponding to the entity type as **Bill**, the **Bill Line Items** zone appears with the details of the respective bill.

In addition to above columns, this screen contains following buttons:

Button Name	Button Description
Edit	Used to edit the details of bill line items.
Delete	Used to delete the bill line items.

Bill Line Items

The **Bill Line Items** zone lists the debit and credit bill segments and adjustments of the bill. This zone contains the following columns:

Column Name	Column Description
Bill ID	Displays the bill ID.
Entity ID	Displays the bill segment or adjustment ID.
Entity Type	Indicates whether the entity is a bill, bill segment or an adjustment.
Currency	Displays the currency in which the entity was created.
Entity Amount	Displays the bill segment or adjustment amount.

Column Name	Column Description
Request Amount	Displays the bill segment or adjustment amount which is eligible for refund. In other words, it means entity amount minus amount refunded.
	Note: If the bill segment or adjustment has debit balance, the eligible amount for refund would be zero.
Contract Information	Displays additional information about the contract against which the bill segment or adjustment is created. In addition, this column has a context menu which helps in navigating to other screens in the application.
	Note: It has a link. On clicking the link, the Contract screen appears where you can view the details of the respective contract.
Adjustment Type	Indicates the adjustment type using which the refund adjustment must be created.
	Note: It has a link. On clicking the link, the Adjustment Type screen appears where you can view the details of the respective adjustment type.
Adjustment Information	Displays information about the refund adjustment.

By default, the **Bill Line Items** zone does not appear in the **Main** tab. It appears only when you click the **Broadcast** (📢) icon corresponding to the bill in the **Refund Details** zone.

Related Topics

For more information on...	See...
How to add a credit bill line item to the refund request	Adding a Credit Bill Line Item to the Refund Request on page 1761

Refund Request - Bills

The **Bills** tab allows you to search bills with credit line items, such as credit bill segments and adjustments, that you want to refund. It contains the following zones:

- [Search Bills](#) on page 1749
- [Bill Line Items](#) on page 1751

Search Bills

The **Search Bills** zone lists completed bills of the account which are either with credit balance or have one or more credit line items, such as bill segments and adjustments. You can filter the bills using various search criteria. This zone contains the following two sections:

- **Search Criteria** — The **Search Criteria** section contains the following fields:

Field Name	Field Description	Mandatory (Yes or No)
Search By	Used to indicate whether you want to search for a bill using bill or bill and price item details. The valid values are: <ul style="list-style-type: none"> • Bill Details • Bill and Price Item Details 	Yes
	Note: By default, the Bill Details option is selected.	
Bill ID	Used to search a particular bill.	No
Bill Date From	Used to search bills which are created from a particular date onwards.	No
To	Used to search bills which are created till a particular date.	No
Price Item	Used to search bills which are created for a particular price item.	No
	Note: This field appears when you select Bill and Price Item Details option from the Search By list. You can search for a price item by clicking the search (🔍) icon corresponding to the field.	

- **Search Results** — On clicking the **Search** button, the search results are filtered based on the specified search criteria. The **Search Results** section contains the following columns:

Column Name	Column Description
Bill ID	Displays the bill ID.
Bill Information	Displays additional information about the bill. In addition, this column has a context menu which helps in navigating to other screens in the application.
	Note: It has a link. On clicking the link, the Bill screen appears with the details of the respective bill.
Amount	Displays the total bill amount.

If you want to refund a bill with credit balance and all credit line items, you need to select the check box corresponding to the bill and then click the **Add** button in the **Search Results** section. All credit bill segments and adjustments of the bill are added in the **Refund Details** zone on the **Main** tab. However, if you select a bill (with credit balance) which contains one or more debit line items or if you select a bill (with debit balance) which contains one or more credit line items, the system will not allow you to add the credit line items by directly adding the bill. In such case, you need to individually select the credit bill segments and adjustments of the bill and then add them to the refund request.

Note: If a refund request is currently in progress for a credit bill segment or adjustment of a bill, those bills of the account are not listed in the **Search Bills** zone. In addition, a bill with all debit line items are not listed in the **Search Bills** zone.

Related Topics

For more information on...	See...
How to add a credit bill line item to the refund request	Adding a Credit Bill Line Item to the Refund Request on page 1761

Bill Line Items

The **Bill Line Items** zone lists the debit and credit bill segments and adjustments of the bill. This zone contains the following columns:

Column Name	Column Description
Entity ID	Displays the bill segment or adjustment ID.
Entity Type	Indicates whether the entity is a bill segment or an adjustment.
Entity Information	Displays additional information about the bill segment or adjustment. If the entity is a bill segment, the context menu appears in the column which helps in navigating to other screens in the application. Note: It has a link. If the entity is a bill segment, the Bill Segment screen appears where you can view the details of the respective bill segment on clicking the link. However, if the entity is an adjustment, the Adjustment screen appears with the details of the respective adjustment on clicking the link.
Entity Amount	Displays the bill segment or adjustment amount.
Eligible Amount	Displays the bill segment or adjustment amount which is eligible for refund. In other words, it means entity amount minus amount refunded. Note: If the bill segment or adjustment has debit balance, the eligible amount for refund would be zero.
Amount Refunded	Displays the amount which is already refunded to the account.
Contract Information	Displays additional information about the contract against which the bill segment or adjustment is created. In addition, this column has a context menu which helps in navigating to other screens in the application. Note: It has a link. On clicking the link, the Contract screen appears where you can view the details of the respective contract.

You can select one or more credit bill segments or adjustments and click the **Add** button in this zone to add selected credit bill segments or adjustments to the refund request.

By default, the **Bill Line Items** zone does not appear in the **Bills** tab. It appears only when you click the **Broadcast** (📡) icon corresponding to the bill in the **Search Bills** zone.

Related Topics

For more information on...	See...
How to add a credit bill line item to the refund request	Adding a Credit Bill Line Item to the Refund Request on page 1761

Refund Request - Payments

The **Payments** tab allows you to search payment events or individual payments that you want to refund. It contains the following zones:

- [Search Payment Event](#) on page 1752
- [Payments](#) on page 1753

Search Payment Event

The **Search Payment Event** zone lists the payment events which are created for the account. You can filter the payment events using various search criteria. This zone contains the following two sections:

- **Search Criteria** — The **Search Criteria** section contains the following fields:

Field Name	Field Description	Mandatory (Yes or No)
Search By	Used to indicate that you want to search for a payment event using the payment details. The valid values are: <ul style="list-style-type: none"> • Payment Details 	Yes
	Note: By default, the Payment Details option is selected.	
Payment Event ID	Used to search a particular payment event.	No
Suspense/Excess Credit Contract	Used to search payment events which include payments made against a particular suspense or excess credit contract.	No
	Note: The suspense and excess credit contracts are listed when these contracts are associated with the account	
Check Number	Used to search a payment event which includes payment made through a particular check.	No
Payment Date	Used to search payment events which include payments created from a particular date onwards.	No
To	Used to search payment events which include payments created till a particular date.	No
MICR ID	Used to search payment events which include payments made with a particular MICR code.	No

- **Search Results** — On clicking the **Search** button, the search results are filtered based on the specified search criteria. The **Search Results** section contains the following columns:

Column Name	Column Description
Payment Event Information	Displays additional information about the payment event.
	Note: It has a link. On clicking the link, the Payment Event screen appears where you can view the details of the respective payment event.
Payment Date	Displays the date when the payments were created.
Tender Amount	Displays the tender amount.
Payment Event ID	Displays the payment event ID.

If you want to refund all payments of a payment event, you need to select the check box corresponding to the payment event and then click the **Add** button in the **Search Results** section. If all payments in the payment event are matched against the same suspense or excess credit contract, the payment event is added in the **Refund Details**

zone on the **Main** tab. However, if the payments in the payment event are matched against different suspense or excess credit contracts, the payments of the payment event are added in the **Refund Details** zone.

Note: If a refund request is currently in progress for a payment event or for any payment of a payment event, those payments events of the account are not listed in the **Search Payment Event** zone.

Related Topics

For more information on...	See...
How to add a payment event to the refund request	Adding a Payment Event to the Refund Request on page 1758

Payments

The **Payments** zone lists only those payments which are created through the payment event and are currently in the **Frozen** status. This zone contains the following columns:

Column Name	Column Description
Payment ID	Displays the payment ID.
	Note: It has a link. On clicking the link, the Payment screen appears where you can view the details of the respective payment.
Payee Account Information	Displays additional information about the account for which the payment was made.
	Note: It has a link. On clicking the link, the Account screen appears where you can view the details of the respective account.
Payment Amount	Displays the payment amount.
Payment Currency	Indicates the currency in which the payment was made.
Payment Status	Indicates the status of the payment.
Match Type	Indicates the match type using which the payment was matched.
Match Value	Indicates the entity (such as bill, contract, and so on) against which the payment was matched.
Amount Refunded	Displays the amount which is already refunded to the payor account.

You can select one or more payments and click the **Add** button in this zone to add selected payments to the refund request.

By default, the **Payments** zone does not appear in the **Payments** tab. It appears when you click the **Broadcast** (📡) icon corresponding to the payment event in the **Search Payment Event** zone.

Related Topics

For more information on...	See...
How to add a payment to the refund request	Adding a Payment to the Refund Request on page 1759

Refund Request - Log

The **Log** tab contains the following zone:

- [Refund Request Log](#) on page 1754

Refund Request Log

The **Refund Request Log** zone lists the complete trail of actions performed on the refund request. This zone contains the following columns:

Column Name	Column Description
Date/Time	Displays the date and time when the action was performed on the refund request.
Details	Displays the details about the action performed on the refund request.
User	Indicates the user who has performed the action on the refund request.
Log Type	Indicates the type of log.
Related Object	Indicates the object or entity which is generated when the action is performed on the refund request.
Status Reason	Displays the status reason of action performed on the refund request.

Note: You can manually add a log entry for the refund request by clicking the **Add Log Entry** link in the upper right corner of the **Refund Request Log** zone.

The **Add Request Log** window appears. Enter **Log Details** and click **Save**. The refund request log is added.

Related Topics

For more information on...	See...
How to view the log of a refund request	Viewing the Log of a Refund Request on page 1774

Creating a Refund Request

Prerequisites

To create a refund request, you should have:

- Refund request types defined in the application

Procedure

To create a refund request:

1. Do either of the following:

If you want to...	Then...
Define a refund request from the Account Receivable Central screen	<ol style="list-style-type: none"> 1. Click the Main link in the Application toolbar. A list appears. 2. From the Main menu, select Accounting and Receivable and then click Account Receivable Central. 3. Search for the bill in the Account Receivable Central screen. 4. In the Search Results section, select the required bill and then click Refund.

If you want to...	Then...
	<p>Note: Only one bill at a time is allowed to select for Refund Request from the Account Receivable Central screen.</p>
Define a refund request from the Refund Request screen	<ol style="list-style-type: none"> 1. Click the Main link in the Application toolbar. A list appears. 2. From the Main menu, select Accounting and Receivable and then click Refund/Write Off Request. A sub-menu appears. 3. Click the Add option from the Refund/Write Off Request sub-menu.

The **Select Request Type** screen appears. It contains the following fields:

Field Name	Field Description	Mandatory (Yes or No)
Action	<p>Displays the type of request (refund or write off) to be created.</p> <p>Note: This field is pre-populated if the refund request is created from the Account Receivable Central screen. This field is editable if the refund request is created from the Refund/Write Off Request screen.</p>	Not applicable
Refund/Write Off Request Type	<p>Used to indicate the request type using which you want to create the refund or write off request.</p> <p>Note: The refund request types are listed when you set the Action field to Refund and the write off request types are listed when you set the Action field to Write Off.</p>	Yes

Field Name	Field Description	Mandatory (Yes or No)
Account	Used to indicate the account for which you want to create the refund or write off request. Note: This field is pre-populated if the refund request is created from the Account Receivable Central screen. This field is editable if the refund request is created from the Refund/Write Off Request screen. You can search for an account by clicking the Search (🔍) icon corresponding to the respective field.	Yes

Tip:

Alternatively, you can access the **Select Request Type** screen:

- By clicking the **Add** button in the **Page Title** area of **Refund/Write Off Request** screen.
- By selecting the payment which you want to refund in the **Payment Event Summary** screen and then clicking the **Refund** button. Note that the system will allow you to refund only those payments which are in the **Frozen** status and matched against the suspense or excess credit contract.

2. Select the required refund request type from the respective field.
3. Click **Save**.

The refund request is defined and the status of the refund request is set to **Draft**. The **Refund Request** screen appears where you can view the details of the refund request. It contains the following tabs:

Note: The refund request can be created only for bill with outstanding amount lesser than zero.

- **Main** – Displays information about the refund request. It contains the following zones:
 - **Refund Request** – Displays the details of the refund request.
 - **Refund Details** – Lists the entities, such as payment events, payments, and/or credit bill line items (such as credit bill segments and adjustments), of the account which must be refunded.
 - **Payments** — Used to search payment events or individual payments that you want to refund. This tab appears only when the refund request is in the **Draft** status.
 - **Bills** — Used to search bills with credit line items, such as credit bill segments and adjustments, that you want to refund. This tab appears when the refund request is in the **Draft** status.
 - **Log** – Lists the complete trail of actions performed on the refund request.
4. Add payment events, payments, or credit bill line items that you want to refund.
 5. Edit the refund amount of each entity, if required.
 6. Define characteristics for the refund request, if required.
 7. Override the address if you want to sent the refund to an address other than the account’s main customer address.

Related Topics

For more information on...	See...
Refund Request screen	Refund Request on page 1744
Account Receivable Central screen	Account Receivable Central on page 1546
How to add a payment event to the refund request	Adding a Payment Event to the Refund Request on page 1758
How to add a payment to the refund request	Adding a Payment to the Refund Request on page 1759
How to add a credit bill line item to the refund request	Adding a Credit Bill Line Item to the Refund Request on page 1761
How to edit a refund request	Editing a Refund Request on page 1762
How to define a characteristic for a refund request	Defining a Characteristic for a Refund Request on page 1757

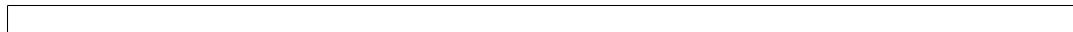

Defining a Characteristic for a Refund Request

Prerequisites

To define a characteristic for a refund request, you should have:

- Characteristic types defined in the application (where the characteristic entity is set to **Refund Write Off Request**)

Procedure

To define a characteristic for a refund request:

1. Search for the refund request in the **Refund/Write Off Request** screen.
2. In the **Search Results** section, click the link in the **Refund/Write Off Request Information** column corresponding to the refund request whose details you want to edit.

The **Refund Request** screen appears.

3. Click the **Edit** button in the **Refund Request** zone.

The **Edit Refund Request** screen appears.

Note: The **Edit** button appears only when the refund request is in the **Draft** status.

4. Ensure that the **Characteristics** section is expanded when you are editing the refund request.

The **Characteristics** section contains the following fields:

Field Name	Field Description	Mandatory (Yes or No)
Effective Date	Used to specify the date from when the characteristic is effective for the refund request.	Yes (Conditional) Note: This field is required when you are defining a characteristic for the refund request.
Characteristic Type	Used to indicate the characteristic type. Note: The list includes only those characteristic types where the characteristic entity is set to Refund Write Off Request .	Yes (Conditional) Note: This field is required when you are defining a characteristic for the refund request.

Field Name	Field Description	Mandatory (Yes or No)
Characteristic Value	Used to specify the value for the characteristic type.	Yes (Conditional)
	Note: On specifying the value for a predefined characteristic type, the description of the characteristic value appears corresponding to the Characteristic Value field.	Note: This field is required when you are defining a characteristic for the refund request.

5. Enter the required details in the **Characteristics** section.

Note: If you select a predefined characteristic type, the **Search** (🔍) icon appears corresponding to the **Characteristic Value** field. On clicking the **Search** icon, you can search for a predefined characteristic value.

6. If you want to define more than one characteristic for the refund request, click the **Add** (+) icon and then repeat step 5.

Note: However, if you want to remove a characteristic from the refund request, click the **Delete** (🗑️) icon corresponding to the characteristic.

Related Topics

For more information on...	See...
How to search for a refund request	Searching for a Refund or Write Off Request on page 1737
How to create a refund request	Creating a Refund Request on page 1738

Adding a Payment Event to the Refund Request

Prerequisites

To add a payment event to the refund request, you should have:

- Payments made by the account for which you need to create the refund request

Procedure

To add a payment event to the refund request:

1. Click the **Payments** tab in the **Refund Request** screen.

The **Payments** tab appears.

2. Filter the payment events, if required, in the **Search Payment Event** zone.

Note: You can only refund payments, which are matched against suspense or excess credit contracts, to the payor account. Therefore, you can only view payment events which includes payments matched against suspense or excess credit contracts. If a refund request is currently in progress for a payment event or for any payment of a payment event, those payments events of the account are not listed in the **Search Payment Event** zone.

3. Select the check box corresponding to the payment event, whose payments you want to refund, in the **Search Results** section.

Note: You can add more than one payment event to the refund request at the same time.

4. Click **Add**.

A message appears indicating that the selected payment events are added to the refund request.

5. Click **OK**.

Note that the entity is added in the **Refund Details** zone on the **Main** tab.

Note:

You can only refund payments which are in the **Frozen** status.

If all payments in the payment event are matched against the same suspense or excess credit contract, the payment event is added in the **Refund Details** zone. However, if the payments in the payment event are matched against different suspense or excess credit contracts, the payments of the payment event are added in the **Refund Details** zone.

Related Topics

For more information on...	See...
How to create a refund request	Creating a Refund Request on page 1738

Adding a Payment to the Refund Request

Prerequisites

To add a payment to the refund request, you should have:

- Payments made by the account for which you need to create the refund request

Procedure

To add a payment to the refund request:

1. Click the **Payments** tab in the **Refund Request** screen.
The **Payments** tab appears.
2. Filter the payment events, if required, in the **Search Payment Event** zone.

Note: You can only refund payments, which are matched against suspense or excess credit contracts, to the payor account. Therefore, you can only view payment events which includes payments matched against suspense or excess credit contracts. If a refund request is currently in progress for a payment event or for any payment of a payment event, those payments events of the account are not listed in the **Search Payment Event** zone.

3. In the **Search Results** section, click the **Broadcast** (📡) icon corresponding to the payment event whose payments you want to view.
The **Payments** zone appears.
4. Select the check box corresponding to the payment that you want to refund.

Note: You can add more than one payment to the refund request at the same time.

5. Click **Add**.

A message appears indicating that the selected payments are added to the refund request.

6. Click **OK**.

Note that the payments are added in the **Refund Details** zone on the **Main** tab.

Note: You can only refund payments which are in the **Frozen** status.

Related Topics

For more information on...	See...
How to create a refund request	Creating a Refund Request on page 1738

Adding a Credit Bill to the Refund Request

You can refund the credit bills to the account.

Prerequisites

To add a credit bill to the refund request, you should have:

- Completed bills for the account with one or more credit line items

Procedure

To add a credit bill to the refund request:

1. Click the **Bills** tab in the **Refund Request** screen.

The **Bills** tab appears.

2. Filter the bills, if required, in the **Search Bills** zone.

Note: If a refund request is currently in progress for a credit bill segment or adjustment of a bill, those bills of the account are not listed in the **Search Bills** zone. In addition, a bill with all debit line items are not listed in the **Search Bills** zone.

3. Do either of the following:

If...	Then...
A bill has all credit line items and you want to add the credit bill to the refund request	<ol style="list-style-type: none"> 1. In the Search Bills zone, select the bills that you want to refund. 2. Click the Add button available at the upper left corner of the Search Bills zone. <p>Note: Default adjustment type selected in the write off request type should be non A/P.</p>
A bill has credit balance and one or more debit line items and you want to add the credit bill to the refund request	<ol style="list-style-type: none"> 1. In the Search Bills zone, select the bills that you want to refund. 2. Click the Add button available at the upper left corner of the Search Bills zone. <p>Note: Default adjustment type selected in the write off request type should be non A/P.</p>

4. Click **Add**.

A message appears indicating that the selected bills are added to the refund request.

Note: If you select a bill (with credit balance) which contains one or more debit line items or if you select a bill (with debit balance) which contains one or more credit line items, the system will not allow you to add the credit line items by directly adding the bill. In such case, you need to individually select the credit bill segments and adjustments of the bill and then add them to the refund request.

5. Click **OK**.

Note that all the credit bill segments or adjustments of the bills are added in the **Refund Details** zone on the **Main** tab.

Note:

Irrespective of whether you select a credit bill, or credit bill segments or adjustments, the credit bill segments or adjustments are added in the **Refund Details** zone. The credit bill is not added to the **Refund Details** zone.

The system will not allow you to add a debit line item to the **Refund Details** zone.

Related Topics

For more information on...	See...
How to create a refund request	Creating a Refund Request on page 1738

Adding a Credit Bill Line Item to the Refund Request

You can refund the credit bill line items, such as bill segments and adjustments, to the account. While adding a credit bill line item to the refund request, you can either:

- Directly add all credit line items of a bill to the refund request by adding the bill which has all bill segments and adjustments in credit
- Individually add a credit bill segment or adjustment of a bill (with one or more credit line items) to the refund request

Prerequisites

To add a credit bill line item to the refund request, you should have:

- Completed bills for the account with one or more credit line items

Procedure

To add a credit bill line item to the refund request:

1. Click the **Bills** tab in the **Refund Request** screen.

The **Bills** tab appears.

2. Filter the bills, if required, in the **Search Bills** zone.

Note: If a refund request is currently in progress for a credit bill segment or adjustment of a bill, those bills of the account are not listed in the **Search Bills** zone. In addition, a bill with all debit line items are not listed in the **Search Bills** zone.

3. Do either of the following:

If...	Then...
A bill has all credit line items and you want to add a particular credit bill line item to the refund request	<ol style="list-style-type: none"> 1. In the Search Bills zone, click the Broadcast  icon corresponding to the bill whose line items you want to view. The Bill Line Items zone appears.

If...	Then...
	<ol style="list-style-type: none"> 2. Select the check box corresponding to the credit bill segment or adjustment that you want to refund.
A bill has credit balance and one or more debit line items	<ol style="list-style-type: none"> 1. In the Search Bills zone, click the Broadcast (📡) icon corresponding to the bill whose line items you want to view. The Bill Line Items zone appears. 2. Select the check box corresponding to the credit bill segment or adjustment that you want to refund.
A bill has debit balance and one or more credit line items	<ol style="list-style-type: none"> 1. In the Search Bills zone, click the Broadcast (📡) icon corresponding to the bill whose line items you want to view. The Bill Line Items zone appears. 2. Select the check box corresponding to the credit bill segment or adjustment that you want to refund.

4. Click **Add**.

A message appears indicating that the selected bill segments or adjustments are added to the refund request.

Note: If you select a bill (with credit balance) which contains one or more debit line items or if you select a bill (with debit balance) which contains one or more credit line items, the system will not allow you to add the credit line items by directly adding the bill. In such case, you need to individually select the credit bill segments and adjustments of the bill and then add them to the refund request.

5. Click **OK**.

Note that the credit bill segments or adjustments are added in the **Refund Details** zone on the **Main** tab.

Note:

Irrespective of whether you select a credit bill, or credit bill segments or adjustments, the credit bill segments or adjustments are added in the **Refund Details** zone. The credit bill is not added to the **Refund Details** zone.

The system will not allow you to add a debit line item to the **Refund Details** zone.

Related Topics

For more information on...	See...
How to create a refund request	Creating a Refund Request on page 1738

Editing a Refund Request

Prerequisites

To edit a refund request, you should have:

- Adjustment types with A/P request type defined in the application

Procedure

To edit a refund request:

1. Search for the refund request in the **Refund/Write Off Request** screen.
2. In the **Search Results** section, click the link in the **Refund/Write Off Request Information** column corresponding to the refund request whose details you want to edit.

The **Refund Request** screen appears.

3. Click the **Edit** button in the **Refund Request** zone.

The **Edit Refund Request** screen appears. It contains the following section:

Field Name	Field Description	Mandatory (Yes or No)
Refund Request Information	Displays information about the refund request.	Not applicable
Account Information	Indicates the account for which the refund request is created.	Not applicable
Person Name	Used to indicate the person for whom the refund request is created. Note: The system maintains a log when you edit the person name in a refund request. A log is created in the following format: Person Name is changed; Old Value: <OLD NAME>; New Value: <NEW NAME>	No
Override Address	Used to indicate whether the account's mailing address must be overridden. Note: By default, the account's main customer's address appears in the following fields — Address 1, Address 2, Address 3, Address 4, City, Country, State, and Postal. You can override the address in these fields, if required. The system maintains a log when you edit the address in a refund request. A log is created in the following format: Address is changed; Old Value: <OLD ADDRESS>; New Value: <NEW ADDRESS>	No
Address 1	Used to specify the house number and apartment name.	No
Address 2	Used to specify the street name.	No
Address 3	Used to specify any landmark, if available.	No

Field Name	Field Description	Mandatory (Yes or No)
Address 4	Used to specify the village, town, or city name.	No
City	Used to specify the city name.	No
Country	Used to specify the country name.	No
State	Used to specify the state name.	No
Postal	Used to specify the postal or zip code.	No
Comments	Used to specify additional information about the refund request.	No

In addition, this screen contains the following two sections:

- **Characteristics** — Used to define the characteristics for the refund request. It contains the following fields:

Field Name	Field Description	Mandatory (Yes or No)
Effective Date	Used to specify the date from when the characteristic is effective for the refund request.	Yes (Conditional)
		Note: This field is required when you are defining a characteristic for the refund request.
Characteristic Type	Used to indicate the characteristic type.	Yes (Conditional)
	Note: The list includes only those characteristic types where the characteristic entity is set to Refund Write Off Request .	Note: This field is required when you are defining a characteristic for the refund request.
Characteristic Value	Used to specify the value for the characteristic type.	Yes (Conditional)
	Note: On specifying the value for a predefined characteristic type, the description of the characteristic value appears corresponding to the Characteristic Value field.	Note: This field is required when you are defining a characteristic for the refund request.

4. Modify the details of the refund request, if required.
5. Define, edit, or remove characteristics of the refund request, if required.
6. Click **Save**.

The changes made to the refund request are saved.

Related Topics

For more information on...	See...
How to search for a refund request	Searching for a Refund or Write Off Request on page 1737
Refund Request screen	Refund Request on page 1744
Refund Request zone	Refund Request on page 1745

For more information on...	See...
How to define a characteristic for a refund request	Defining a Characteristic for a Refund Request on page 1757

Editing the Refund Details

Prerequisites

To edit the refund details, you should have:

- Adjustment types with A/P request type defined in the application

Procedure

To edit the refund details:

1. Search for the refund request in the **Refund/Write Off Request** screen.
2. In the **Search Results** section, click the link in the **Refund/Write Off Request Information** column corresponding to the refund request whose bill line item details you want to edit.

The **Refund Request** screen appears. You can edit the bill line items by either of the following ways:

If...	Then
Select the bill whose details you want to edit in the Refund Details zone and click the Edit button available in the upper left corner of this zone.	The Edit Request Details screen appears.
In the Refund Details zone, click the Broadcast () icon corresponding to the bill whose line items details you want to edit.	The Bill Line Items zone appears.
	<p>Note: This zone appears when the Entity Type is Bill.</p> <ol style="list-style-type: none"> 1. Select the bill line item whose details you want to edit in the Bill Line Items zone and click the Edit button available in the upper left corner of this zone. <p>The Edit Request Details screen appears.</p>

Note: A bill line item from the refund request can be edited when the refund request is in the **Draft** status.

The **Edit Request Details** screen contains the following fields:

Field Name	Field Description	Mandatory (Yes or No)
Request ID	Displays the refund request ID.	Not applicable
Account Information	Displays additional information about the account.	Not applicable
Adjustment Type	Indicates the adjustment type of the refund request type. You can search for an adjustment type by clicking the Search () icon corresponding to the field.	No

In addition to these fields, this screen contains following columns:

Column Name	Column Description
Entity Type	Indicates the entity type. The valid values are <ul style="list-style-type: none"> • Adjustments • Bill • Bill Segment • Payment Event • Payment
Entity ID	Displays the entity ID.
Entity Amount	Displays the entity amount.
Currency	Displays the currency in which the entity was created.
Request Amount	Displays the amount that must be refunded.
Adjustment Type	Indicates the adjustment type using which the refund adjustment must be created. <div style="border: 1px solid black; padding: 5px; margin-top: 10px;"> <p>Note:</p> <p>You can search for an account by clicking the Search (🔍) icon corresponding to the field.</p> </div>
Bill ID	Displays the bill ID.

In addition to the above columns, the screen has following button:

Button Name	Button Description
Override	Used to override an adjustment type of the refund request.

Note:

In the **Bill Line Items** zone, click the **Broadcast** (📢) icon corresponding to the bill line item which you want to delete

Pagination is used to display limited number of records in the **Search Results** section. By default, 10 records are displayed in the **Search Results** section. You can change the number of records displayed per page, if required.

You can use the navigation buttons, such as **First** (⏪), **Previous** (⏴), **Next** (⏵), and **Last** (⏩) to navigate between pages. You can also select the page to which you want to navigate from the **Go To** list.

The values appear in the **Page Limit** list when you define values for the **PAGE_NUMBER** lookup field.

3. Modify the details of the bill line items.
4. Click **Save**.

The changes made to the refund bill line items are saved.

Related Topics

For more information on...	See...
Refund Request screen	Refund Request on page 1744
Refund Request zone	Refund Request on page 1745
How to search for a refund request	Searching for a Refund or Write Off Request on page 1737

Deleting a Refund Request

Procedure

To delete a refund request:

1. Search for the refund request in the **Refund/Write Off Request** screen.
2. In the **Search Results** section, click the link in the **Refund/Write Off Request Information** column corresponding to the refund request that you want to delete.

The **Refund Request** screen appears.

3. Click the **Delete** button in the **Refund Request** zone.

A message appears confirming whether you want to delete the refund request.

Note: The **Delete** button appears when the refund request is in the **Draft** status.

4. Click **OK**.

The refund request is deleted.

Related Topics

For more information on...	See...
How to search for a refund request	Searching for a Refund or Write Off Request on page 1737
Refund Request screen	Refund Request on page 1744
Refund Request zone	Refund Request on page 1745

Deleting a Bill from the Refund Request

Procedure

To delete a bill from the refund request:

1. Search for the refund request in the **Refund/Write Off Request** screen.
2. In the **Search Results** section, click the link in the **Refund/Write Off Request Information** column corresponding to the refund request whose bill you want to delete.

The **Refund Request** screen appears.

3. In the **Refund Details** zone, select the bills and click the **Delete** button available in the upper left corner of this zone.

A message appears confirming whether you want to delete the bill from the refund request.

Note: You can delete bill from the refund request when the request is in the **Draft** status.

4. Click **OK**.

The selected bill gets deleted from the refund request.

Related Topics

For more information on...	See...
Refund Request screen	Refund Request on page 1744
Refund Request zone	Refund Request on page 1745
How to search for a refund request	Searching for a Refund or Write Off Request on page 1737

Deleting a Bill Line Item from the Refund Request**Procedure**

To delete a bill line item from the refund request:

1. Search for the refund request in the **Refund/Write Off Request** screen.
2. In the **Search Results** section, click the link in the **Refund/Write Off Request Information** column corresponding to the refund request whose bill line items you want to delete.

The **Refund Request** screen appears.

3. In the **Refund Details** zone, click the **Broadcast** (📢) icon corresponding to the bill whose line items details you want to delete.

The **Bill Line Items** zone appears.

4. In the **Bill Line Items** zone, select the bill line items which you want to delete and click the **Delete** button available in the upper left corner of this zone.

A message appears confirming whether you want to delete the bill line items from the refund request.

Note:

You can delete a bill line item from the refund request when the request is in the **Draft** status.

5. Click **OK**.

The selected bill line items gets deleted from the refund request.

Related Topics

For more information on...	See...
Refund Request screen	Refund Request on page 1744
Refund Request zone	Refund Request on page 1745
How to search for a refund request	Searching for a Refund or Write Off Request on page 1737

Submitting a Refund Request**Prerequisites**

To submit a refund request, you should have:

- Payment events, payments, or credit bill line items added in the refund request

Procedure

To submit a refund request:

1. Search for the refund request in the **Refund/Write Off Request** screen.
2. In the **Search Results** section, click the link in the **Refund/Write Off Request Information** column corresponding to the refund request that you want to submit.

The **Refund Request** screen appears.

3. Click the **Submit** button in the **Refund Request** zone.

The system behaves in the following manner:

If...	Then...
The Approval Required and Hierarchical Approval check boxes are selected in the refund request type using which the refund request is created	A To Do of the C1-REFRQ To Do type is created and sent to the approver at the first level in the approval hierarchy, and the status of the refund request is changed to Approval In Progress .
The Approval Required check box is selected, but the Hierarchical Approval check box is not selected in the refund request type using which the refund request is created	A To Do of the C1-REFRQ To Do type is created and sent to the approver at the hierarchy level where the total refund amount falls within the threshold limit. In addition, the status of the refund request is changed to Approval In Progress .
The Approval Required check box is not selected in the refund request type using which the refund request is created	<p>The refund adjustments are created using the specified adjustment types and the status of the refund request is changed to Processed.</p> <p>Note: The refund adjustments are created in the Frozen status. If a match event is present for the credit bill line items (such as bill segments and adjustments) and for the payments which are matched against the excess credit contract, the existing match event is stamped on the refund adjustments and on the corresponding financial transactions. However, when a match event is not present for the payments which are matched against the suspense contract or if the match events does not exist, a new match event is created and stamped on the refund adjustments and on the corresponding financial transactions. If you are doing a partial refund for any entity, the corresponding match event status is set to Open. However, if you are refunding the entire eligible amount, the corresponding match event status is set to Balanced.</p>

If...	Then...
The total refund amount is less than minimum refund amount	<p>The write up adjustment is created using the write up adjustment type specified in the refund request type. In addition, the status of the refund request is changed to Processed.</p> <p>Note: The write up adjustment is created in the Frozen status. If a match event is present for the credit bill line items (such as bill segments and adjustments) and for the payments which are matched against the excess credit contract, the existing match event is stamped on the write up adjustment and on the corresponding financial transaction. However, when a match event is not present for the payments which are matched against the suspense contract or if the match events does not exist, a new match event is created and stamped on the write up adjustment and on the corresponding financial transaction. If you are doing a partial refund for any entity, the corresponding match event status is set to Open. However, if you are refunding the entire eligible amount, the corresponding match event status is set to Balanced.</p>
The total refund amount is less than the minimum threshold amount	<p>The refund request is automatically approved by the system and refund adjustments are created using the specified adjustment types. In addition, the status of the refund request is changed to Processed.</p> <p>Note: The refund adjustments are created in the Frozen status. If a match event is present for the credit bill line items (such as bill segments and adjustments) and for the payments which are matched against the excess credit contract, the existing match event is stamped on the refund adjustments and on the corresponding financial transactions. However, when a match event is not present for the payments which are matched against the suspense contract or if the match events does not exist, a new match event is created and stamped on the refund adjustments and on the corresponding financial transactions. If you are doing a partial refund for any entity, the corresponding match event status is set to Open. However, if you are refunding the entire eligible amount, the corresponding match event status is set to Balanced.</p>

Note: The **Submit** button appears when the refund request is in the **Draft** status.

Related Topics

For more information on...	See...
How to search for a refund request	Searching for a Refund or Write Off Request on page 1737
Refund Request screen	Refund Request on page 1744

For more information on...	See...
Refund Request zone	Refund Request on page 1745

Approving a Refund Request

You can view the number of refund requests which are pending for approval in the **Refund/Write Off Request** screen. The approver can review, and accordingly approve or reject the refund request based on the observations.

Note: The system will not allow you to approve or reject a refund request submitted by you.

Procedure

To approve a refund request:

1. Do either of the following:

If you want to...	Then...
Approve a refund request through the Refund/Write Off Request screen	<ol style="list-style-type: none"> 1. Search for the refund request in the Refund/Write Off Request screen. 2. In the Search Results section, click the link in the Refund/Write Off Request Information column corresponding to the refund request which you want to review.
Approve a refund request from the To Do List screen	<ol style="list-style-type: none"> 1. Click the Menu link in the Application toolbar. A list appears. 2. From the Main menu, select To Do and then click To Do List. The To Do Type for User Search window appears. 3. Enter C1-REFRQ in the To Do Type field. 4. Click the Search button corresponding to the To Do Type field. The To Do List screen appears. 5. Select the Open option from the Filter by list to view all unassigned To Dos. 6. Click the link in the Message column corresponding to the To Do of the refund request that you want to review.

The **Refund Request** screen appears.

2. Review the refund request details.
3. Click the **Approve** button in the **Refund Request** zone.

The system behaves in the following manner:

If...	Then
<p>The Hierarchical Approval check box is selected in the refund request type using which the refund request is created and the total refund amount is greater than the threshold amount specified at the next level in the approval hierarchy</p>	<p>A To Do of the C1-REFRQ To Do type is created and sent to the approver at the next level in the approval hierarchy, and the status of the refund request remains as Approval In Progress.</p>
<p>The Hierarchical Approval check box is selected in the refund request type using which the refund request is created and the total refund amount is less than the threshold amount specified at the next level in the approval hierarchy</p>	<p>The refund adjustments are created using the specified adjustment types and the status of the refund request is changed to Processed.</p> <p>Note: The refund adjustments are created in the Frozen status. If a match event is present for the credit bill line items (such as bill segments and adjustments) and for the payments which are matched against the excess credit contract, the existing match event is stamped on the refund adjustments and on the corresponding financial transactions. However, when a match event is not present for the payments which are matched against the suspense contract or if the match events does not exist, a new match event is created and stamped on the refund adjustments and on the corresponding financial transactions. If you are doing a partial refund for any entity, the corresponding match event status is set to Open. However, if you are refunding the entire eligible amount, the corresponding match event status is set to Balanced.</p>
<p>The Hierarchical Approval check box is not selected in the refund request type using which the refund request is created</p>	<p>The refund adjustments are created using the specified adjustment types and the status of the refund request is changed to Processed.</p> <p>Note: The refund adjustments are created in the Frozen status. If a match event is present for the credit bill line items (such as bill segments and adjustments) and for the payments which are matched against the excess credit contract, the existing match event is stamped on the refund adjustments and on the corresponding financial transactions. However, when a match event is not present for the payments which are matched against the suspense contract or if the match events does not exist, a new match event is created and stamped on the refund adjustments and on the corresponding financial transactions. If you are doing a partial refund for any entity, the corresponding match event status is set to Open. However, if you are refunding the entire eligible amount, the corresponding match event status is set to Balanced.</p>

Note: The **Approve** button appears when:

- The refund request is in the **Approval In Progress** status.
- A user with the approval To Do role is reviewing the refund request.

Related Topics

For more information on...	See...
How to search for a refund request	Searching for a Refund or Write Off Request on page 1737
Refund Request screen	Refund Request on page 1744
Refund Request zone	Refund Request on page 1745

Rejecting a Refund Request

Prerequisites

To reject a refund request, you should have:

- Rejection reasons defined in the application

Note:

While rejecting a refund request, you need to specify the reason why you want to reject the refund request. You can select the appropriate rejection reason when you have defined the reasons for the **Rejected** status of the **C1-RefundReq** business object in the **Status Reason** screen.

The system will not allow you to approve or reject a refund request submitted by you.

Procedure

To reject a refund request:

1. Do either of the following:

If you want to...	Then...
Reject a refund request through the Refund/Write Off Request screen	<ol style="list-style-type: none"> 1. Search for the refund request in the Refund/Write Off Request screen. 2. In the Search Results section, click the link in the Refund/Write Off Request Information column corresponding to the refund request which you want to review.
Reject a refund request from the To Do List screen	<ol style="list-style-type: none"> 1. Click the Menu link in the Application toolbar. A list appears. 2. From the Main menu, select To Do and then click To Do List. The To Do Type for User Search window appears.

If you want to...	Then...
	<ol style="list-style-type: none"> 3. Enter C1-REFRQ in the To Do Type field. 4. Click the Search button corresponding to the To Do Type field. The To Do List screen appears. 5. Select the Open option from the Filter by list to view all unassigned To Dos. 6. Click the link in the Message column corresponding to the To Do of the refund request that you want to review.

The **Refund Request** screen appears.

2. Review the refund request details.
3. Click the **Reject** button in the **Refund Request** zone.

The **Reject Refund Request** window appears. It contains following fields:

Field Name	Field Description	Mandatory (Yes or No)
Status Reason	Used to indicate the reason why you want to reject the refund request.	Yes
Comments	Used to specify additional information while rejecting the refund request.	No

Note: The **Reject** button appears when:

- The refund request is in the **Approval In Progress** status.
- A user with the approval To Do role is reviewing the refund request.

4. Select the rejection reason from the **Status Reason** list.
5. Click **Save**.

The status of the refund request is changed to **Rejected**.

Related Topics

For more information on...	See...
How to search for a refund request	Searching for a Refund or Write Off Request on page 1737
Refund Request screen	Refund Request on page 1744
Refund Request zone	Refund Request on page 1745

Viewing the Log of a Refund Request

Procedure

To view the log of a refund request:

1. Search for the refund request in the **Refund/Write Off Request** screen.
2. In the **Search Results** section, click the link in the **Refund/Write Off Request Information** column corresponding to the refund request whose log you want to view.

The **Refund Request** screen appears. It consists of the following tabs:

- **Main** – Displays information about the refund request. It contains the following zones:
 - **Refund Request** – Displays the details of the refund request.
 - **Refund Details** – Lists the entities, such as payment events, payments, and/or credit bill line items (such as credit bill segments and adjustments), of the account which must be refunded.
 - **Bill Line Items** — Displays the details of the bill which must be refunded.

Note:

This zone appears when you click the Broadcast (📡) icon corresponding to the entity type as **Bill** in the **Refund Details** zone.

- **Payments** — Used to search payment events or individual payments that you want to refund. This tab appears only when the refund request is in the **Draft** status.
 - **Bills** — Used to search bills with credit line items, such as credit bill segments and adjustments, that you want to refund. This tab appears when the refund request is in the **Draft** status.
 - **Log** – Lists the complete trail of actions performed on the refund request.
3. Click the **Log** tab.
 4. View the log of the refund request in the **Refund Request Log** zone.

Note: You can manually add a log entry for the refund request by clicking the **Add Log Entry** link in the upper right corner of the **Refund Request Log** zone.

Related Topics

For more information on...	See...
How to search for a refund request	Searching for a Refund or Write Off Request on page 1737
How to add a log entry for a refund request	Adding a Log Entry for a Refund Request on page 1775
Refund Request Log zone	Refund Request Log on page 1754

Adding a Log Entry for a Refund Request

Procedure

To add a log entry for a refund request:

1. Search for the refund request in the **Refund/Write Off Request** screen.
2. In the **Search Results** section, click the link in the **Refund/Write Off Request Information** column corresponding to the refund request whose log you want to edit.

The **Refund Request** screen appears. It consists of the following tabs:

- **Main** – Displays information about the refund request. It contains the following zones:
 - **Refund Request** – Displays the details of the refund request.

- **Refund Details** – Lists the entities, such as payment events, payments, and/or credit bill line items (such as credit bill segments and adjustments), of the account which must be refunded.
 - **Payments** — Used to search payment events or individual payments that you want to refund. This tab appears only when the refund request is in the **Draft** status.
 - **Bills** — Used to search bills with credit line items, such as credit bill segments and adjustments, that you want to refund. This tab appears when the refund request is in the **Draft** status.
 - **Log** – Lists the complete trail of actions performed on the refund request.
3. Click the **Log** tab.
The **Log** tab appears.
 4. Click the **Add Log Entry** link in the upper right corner of the **Refund Request Log** zone.
The **Add Request Log** window appears. It contains the following fields:

Field Name	Field Description	Mandatory (Yes or No)
Request Information	Displays information about the refund request.	Not applicable
Log Details	Used to specify additional comments for the refund request.	Yes

5. Enter the comments in the **Log Details** field.
6. Click **Save**.
The log entry is added in the **Refund Request Log** zone.

Related Topics

For more information on...	See...
How to search for a refund request	Searching for a Refund or Write Off Request on page 1737

Voiding a Refund Request

There might be situations when incorrect refund request is processed in the system. In such case, the system provides you with an ability to void or cancel the refund request. However, note that you can void a refund request when the refund request is in the **Processed** status.

Prerequisites

To void a refund request, you should have:

- Void reasons defined in the application

Note: While voiding a refund request, you need to specify the reason why you want to void the refund request. You can select the appropriate void reason when you have defined the reasons for the **Voided** status of the **C1-RefundReq** business object in the **Status Reason** screen.

Procedure

To void a refund request:

1. Search for the refund request in the **Refund/Write Off Request** screen.
2. In the **Search Results** section, click the link in the **Refund/Write Off Request Information** column corresponding to the refund request that you want to void.

The **Refund Request** screen appears.

- Click the **Void** button in the **Refund Request** zone.

The **Void Reason** window appears. It contains the following fields:

Field Name	Field Description	Mandatory (Yes or No)
Status Reason	Used to indicate the reason why you want to void the refund request.	Yes
Comments	Used to specify additional information while voiding the refund request.	No

Note: The **Void** button appears when the refund request is in the **Processed** status.

- Select the void reason from the **Status Reason** list.
- Click **Save**.

The status of the refund request is changed to **Voided**.

Note: The **C1-REFVOID** algorithm cancels all the frozen adjustments created for the refund request which is in the **Processed** state.

Related Topics

For more information on...	See...
How to search for a refund request	Searching for a Refund or Write Off Request on page 1737
Refund Request screen	Refund Request on page 1744
Refund Request zone	Refund Request on page 1745

Write Off Request

Once you create a write off request, the **Write Off Request** screen allows you to:

- Edit and delete a write off request
- View the details of a write off request
- Submit a write off request for approval
- Approve or reject a write off request
- View the log of a write off request
- Add a log entry for a write off request
- Cancel a write off request

This screen consists of the following tabs:

- Main** – Displays information about the write off request. It contains the following zones:
 - Write Off Request** – Displays the details of the write off request.
 - Write Off Details** – Lists the debit bill line items (such as debit bill segments and adjustments) of the account which must be written off.
 - Bill Line Items** — Displays the details of the bill which must be written off.

Note:

This zone appears when you click the Broadcast () icon corresponding to the entity type as **Bill** in the **Write Off Details** zone.

- **Bills** — Used to search bills with debit line items, such as debit bill segments and adjustments, that you want to write off. It contains the following zones:
 - **Search Bills** — Lists completed bills of the account which are either with debit balance or have one or more debit line items, such as bill segments and adjustments. You can filter the bills using various search criteria.
 - **Bill Line Items** — Lists the debit and credit bill segments and adjustments of the bill.

This tab appears when the write off request is in the **Draft** status.

- **Log** – Lists the complete trail of actions performed on the write off request.

Write Off Request - Main

The **Main** tab displays information about the write off request. It contains the following zones:

- [Write Off Request](#) on page 1778
- [Write Off Details](#) on page 1780
- [Bill Line Items](#) on page 1781

Write Off Request

The **Write Off Request** zone displays the details of the write off request. This zone contains the following sections:

- **Main** — This section provides basic information about the write off request. It contains the following fields:

Field Name	Field Description
Write Off Request Information	Displays information about the write off request.
Write Off Request Type	Indicates the write off request type using which the write off request is created. Note: It has a link. On clicking the link, the Refund/Write Off Request Type screen appears where you can view the details of the write off request type.
Status	Indicates the status of the write off request. The valid values are: <ul style="list-style-type: none"> • Draft • Approval In Progress • Rejected • Processed • Cancelled

Field Name	Field Description
Status Reason	Indicates the reason why the write off request is rejected or cancelled. Note: This field appears when the write off request is in the Rejected or Cancelled status. It has a link. On clicking the link, the Status Reason screen appears where you can view the details of the rejected or cancelled reason.
Account Information	Indicates the account for which the write off request is created. Note: It has a link. On clicking the link, the Account screen appears where you can view the details of the respective account.
Comments	Displays additional information about the write off request.
Total Write Off Amount	Displays the total write off amount.

- **Characteristics** — Lists the characteristics defined for the write off request. It contains the following fields:

Field Name	Field Description
Effective Date	Indicates the date from when the characteristic is effective for the write off request.
Characteristic Type	Indicates the characteristic type.
Characteristic Value	Displays the value of the characteristic type.

- **Record Actions** — This section contains the following buttons:

Button Name	Button Description
Edit	Used to edit the details of the write off request. Note: The Edit button appears when the write off request is in the Draft status.
Delete	Used to delete the write off request. Note: The Delete button appears when the write off request is in the Draft status.
Submit	Used to submit the write off request for approval. Note: The Submit button appears when the write off request is in the Draft status.
Approve	Used to approve the write off request. Note: The Approve button appears when: <ul style="list-style-type: none"> • The write off request is in the Approval In Progress status. • A user with the approval To Do role is reviewing the write off request.

Button Name	Button Description
Reject	Used to reject the write off request.
	<p>Note: The Reject button appears when:</p> <ul style="list-style-type: none"> • The write off request is in the Approval In Progress status. • A user with the approval To Do role is reviewing the write off request.
Cancel	Used to cancel the write off request.
	<p>Note: The Cancel button appears when the write off request is in the Processed status.</p>

- **Record Information** — This section contains the following fields:

Field Name	Field Description
Business Object	Indicates the business object using which the write off request is created. In addition, a context menu appears corresponding to this field which helps in navigating to other screens in the application.
	<p>Note: It has a link. On clicking the link, the Business Object screen appears where you can view the details of the respective business object.</p>
Status Date/Time	Displays the date and time when the write off request status is updated
Create Date/Time	Displays the date and time when the write off request is created.

Write Off Details

The **Write Off Details** zone lists the debit bill line items (such as bill segments and adjustments) that you have added to the write off request. This zone contains the following columns:

Column Name	Column Description
Entity ID	Displays the entity ID.
Entity Type	Indicates whether the entity is a bill, bill segment or an adjustment.
Currency	Indicates the currency in which the entity was created.
Entity Amount	Displays the entity amount.
Write Off Amount	Displays the amount that must be written off.
	<p>Note: By default, the amount which is eligible for write off appears in this column. You can edit the amount, if required. However, you cannot specify the amount greater than the eligible amount.</p>
Contract Information	Displays additional information about the contract against which the bill segment or adjustment is created. In addition, this column has a context menu which helps in navigating to other screens in the application.
	<p>Note: It has a link. On clicking the link, the Contract screen appears where you can view the details of the respective contract.</p>

Column Name	Column Description
Adjustment Type	Indicates the adjustment type using which the write off adjustment must be created.
	Note: By default, the adjustment type specified in the write off request type appears in this column. You can change the adjustment type, if required, by editing the write off request.
Adjustment Information	Displays information about the write off adjustment.
	Note: It has a link. On clicking the link, the Adjustment screen appears where you can view the details of the respective adjustment. The data appears in this column when the status of the write off request is Processed . The information string appears when an algorithm of the C1-ADI-INFO algorithm type is attached to the Adjustment Information system event in the Algorithms tab of the Installation Options — Framework screen.

Note:

On clicking the **Broadcast** () icon corresponding to the entity type as **Bill**, the **Bill Line Items** zone appears with the details of the respective bill.

In addition to above columns, this screen contains following buttons:

Button Name	Button Description
Edit	Used to edit the details of bill line items.
Delete	Used to delete the bill line items.

Bill Line Items

The **Bill Line Items** zone lists the debit and credit bill segments and adjustments of the bill. This zone contains the following columns:

Column Name	Column Description
Bill ID	Displays the bill ID.
Entity ID	Displays the bill segment or adjustment ID.
Entity Type	Indicates whether the entity is a bill, bill segment or an adjustment.
Currency	Displays the currency in which the entity was created.
Entity Amount	Displays the bill segment or adjustment amount.
Request Amount	Displays the bill segment or adjustment amount which is eligible for refund. In other words, it means entity amount minus amount refunded.
	Note: If the bill segment or adjustment has debit balance, the eligible amount for refund would be zero.

Column Name	Column Description
Contract Information	Displays additional information about the contract against which the bill segment or adjustment is created. In addition, this column has a context menu which helps in navigating to other screens in the application.
	Note: It has a link. On clicking the link, the Contract screen appears where you can view the details of the respective contract.
Adjustment Type	Indicates the adjustment type using which the refund adjustment must be created.
	Note: It has a link. On clicking the link, the Adjustment Type screen appears where you can view the details of the respective adjustment type.
Adjustment Information	Displays information about the refund adjustment.

By default, the **Bill Line Items** zone does not appear in the **Main** tab. It appears only when you click the **Broadcast** () icon corresponding to the bill in the **Write Off Details** zone.

Related Topics

For more information on...	See...
How to add a debit bill line item to the write off request	Adding a Debit Bill Line Item to the Write Off Request on page 1790

Write Off Request - Bills

The **Bills** tab allows you to search bills with debit line items, such as debit bill segments and adjustments, that you want to write off. It contains the following zones:

- [Search Bill](#)
- [Bill Line Items](#) on page 1783

Search Bills

The **Search Bills** zone lists completed bills of the account which are either with debit balance or have one or more debit line items, such as bill segments and adjustments. You can filter the bills using various search criteria. This zone contains the following two sections:

- **Search Criteria** — The **Search Criteria** section contains the following fields:

Field Name	Field Description	Mandatory (Yes or No)
Search By	Used to indicate that you want to search for a bill using the bill details. The valid values are: <ul style="list-style-type: none"> • Bill Details • Bill and Price Item Details 	Yes
	Note: By default, the Bill Details option is selected.	
Bill ID	Used to search a particular bill.	No
Bill Date From	Used to search bills which are created from a particular date onwards.	No

Field Name	Field Description	Mandatory (Yes or No)
To	Used to search bills which are created till a particular date.	No
Price Item	Used to search bills which are created for a particular price item.	No
	Note: This field appears when you select Bill and Price Item Details option from the Search By list. You can search for a price item by clicking the search (🔍) icon corresponding to the field.	

- **Search Results** — On clicking the **Search** button, the search results are filtered based on the specified search criteria. The **Search Results** section contains the following columns:

Column Name	Column Description
Bill ID	Displays the bill ID.
Bill Information	Displays additional information about the bill. In addition, this column has a context menu which helps in navigating to other screens in the application.
	Note: It has a link. On clicking the link, the Bill screen appears with the details of the respective bill.
Amount	Displays the total bill amount.

If you want to write off a bill with debit balance and all debit line items, you need to select the check box corresponding to the bill and then click the **Add** button in the **Search Results** section. All debit bill segments and adjustments of the bill are added in the **Write Off Details** zone on the **Main** tab. However, if you select a bill (with debit balance) which contains one or more credit line items or if you select a bill (with credit balance) which contains one or more debit line items, the system will not allow you to add the debit line items by directly adding the bill. In such case, you need to individually select the debit bill segments and adjustments of the bill and then add them to the write off request.

Note: If a write off request is currently in progress for a debit bill segment or adjustment of a bill, those bills of the account are not listed in the **Search Bills** zone. In addition, a bill with all credit line items are not listed in the **Search Bills** zone.

Related Topics

For more information on...	See...
How to add a debit bill line item to the write off request	Adding a Debit Bill Line Item to the Write Off Request on page 1790

Bill Line Items

The **Bill Line Items** zone lists the debit and credit bill segments and adjustments of the bill. This zone contains the following columns:

Column Name	Column Description
Entity ID	Displays the bill segment or adjustment ID.

Column Name	Column Description
Entity Type	Indicates whether the entity is a bill segment or an adjustment.
Entity Information	Displays additional information about the bill segment or adjustment. If the entity is a bill segment, the context menu appears in the column which helps in navigating to other screens in the application. Note: It has a link. If the entity is a bill segment, the Bill Segment screen appears where you can view the details of the respective bill segment on clicking the link. However, if the entity is an adjustment, the Adjustment screen appears with the details of the respective adjustment on clicking the link.
Entity Amount	Displays the bill segment or adjustment amount.
Eligible Amount	Displays the bill segment or adjustment amount which is eligible for write off. In other words, it means entity amount minus amount written off. Note: If the bill segment or adjustment has credit balance, the eligible amount for write off would be zero.
Amount Written Off	Displays the amount which is already written off to the account.
Contract Information	Displays additional information about the contract against which the bill segment or adjustment is created. In addition, this column has a context menu which helps in navigating to other screens in the application. Note: It has a link. On clicking the link, the Contract screen appears where you can view the details of the respective contract.

You can select one or more debit bill segments or adjustments and click the **Add** button in this zone to add selected debit bill segments or adjustments to the write off request.

By default, the **Bill Line Items** zone does not appear in the **Bills** tab. It appears only when you click the **Broadcast** (📡) icon corresponding to the bill in the **Search Bills** zone.

Related Topics

For more information on...	See...
How to add a debit bill line item to the write off request	Adding a Debit Bill Line Item to the Write Off Request on page 1790

Write Off Request - Log

The **Log** tab contains the following zone:

- [Write Off Request Log](#) on page 1784

Write Off Request Log

The **Write Off Request Log** zone lists the complete trail of actions performed on the write off request. This zone contains the following columns:

Column Name	Column Description
Date/Time	Displays the date and time when the action was performed on the write off request.
Details	Displays the details about the action performed on the write off request.

Column Name	Column Description
User	Indicates the user who has performed the action on the write off request.
Log Type	Indicates the type of log.
Related Object	Indicates the object or entity which is generated when the action is performed on the write off request.
Status Reason	Displays the status reason of action performed on the write off request.

Note: You can manually add a log entry for the write off request by clicking the **Add Log Entry** link in the upper right corner of the **Write Off Request Log** zone.

The **Add Request Log** window appears. Enter **Log Details** and click **Save**. The write off request log is added.

Related Topics

For more information on...	See...
How to view the log of a write off request	Viewing the Log of a Write Off Request on page 1801

Creating a Write Off Request

Prerequisites

To create a write off request, you should have:

- Write off request types defined in the application

Procedure

To create a write off request:

1. Do either of the following:

If you want to...	Then...
Define a write off request from the Account Receivable Central screen	<ol style="list-style-type: none"> 1. Click the Main link in the Application toolbar. A list appears. 2. From the Main menu, select Accounting and Receivable and then click Account Receivable Central. 3. Search for the bill in the Account Receivable Central screen. 4. In the Search Results section, select the required bill and then click Write Off. <p>Note: Only one bill at a time is allowed to select for Write Off Request from the Account Receivable Central screen.</p>
Define a write off request from the Write Off Request screen	<ol style="list-style-type: none"> 1. Click the Main link in the Application toolbar. A list appears.

If you want to...	Then...
	<p>2. From the Main menu, select Accounting and Receivable and then click Refund/Write Off Request.</p> <p>A sub-menu appears.</p> <p>3. Click the Add option from the Refund/Write Off Request sub-menu.</p>

The **Select Request Type** screen appears. It contains the following fields:

Field Name	Field Description	Mandatory (Yes or No)
Action	<p>Displays the type of request (refund or write off) to be created.</p> <p>Note:</p> <p>This field is pre-populated if the write off request is created from the Account Receivable Central screen.</p> <p>This field is editable if the write off request is created from the Refund/Write Off Request screen.</p>	Yes
Refund/Write Off Request Type	<p>Used to indicate the request type using which you want to create the refund or write off request.</p> <p>Note: The refund request types are listed when you set the Action field to Refund and the write off request types are listed when you set the Action field to Write Off.</p>	Yes
Account	<p>Used to indicate the account for which you want to create the refund or write off request.</p> <p>Note:</p> <p>This field is pre-populated if the write off request is created from the Account Receivable Central screen.</p> <p>This field is editable if the write off request is created from the Refund/Write Off Request screen.</p> <p>You can search for an account by clicking the Search (🔍) icon corresponding to the respective field.</p>	Yes

Tip: Alternatively, you can access the **Select Request Type** screen by clicking the **Add** button in the **Page Title** area of the **Refund/Write Off Request** screen.

2. Select the required write off request type and account from the respective fields.
3. Click **Save**.

The write off request is defined and the status of the write off request is set to **Draft**. The **Write Off Request** screen appears with the details of the write off request. It contains the following tabs:

Note: The write off request can be created only for bill with outstanding amount greater than zero.

- **Main** – Displays information about the write off request. It contains the following zones:
 - **Write Off Request** – Displays the details of the write off request.
 - **Write Off Details** – Lists the debit bill line items (such as debit bill segments and adjustments) of the account which must be written off.
 - **Bills** — Used to search bills with debit line items, such as debit bill segments and adjustments, that you want to write off. This tab appears when the write off request is in the **Draft** status.
 - **Log** – Lists the complete trail of actions performed on the write off request.
4. Add debit bill line items that you want to write off.
 5. Edit the write off amount of each entity, if required.
 6. Define characteristics for the write off request, if required.

Related Topics

For more information on...	See...
Write Off Request screen	Write Off Request on page 1777
Account Receivable Central screen	Account Receivable Central on page 1546
How to add a debit bill line item to the write off request	Adding a Debit Bill Line Item to the Write Off Request on page 1790
How to edit a write off request	Editing a Write Off Request on page 1791
How to define a characteristic for a write off request	Defining a Characteristic for a Write Off Request on page 1787

Defining a Characteristic for a Write Off Request

Prerequisites

To define a characteristic for a write off request, you should have:

- Characteristic types defined in the application (where the characteristic entity is set to **Refund Write Off Request**)

Procedure

To define a characteristic for a write off request:

1. Search for the write off request in the **Refund/Write Off Request** screen.
2. In the **Search Results** section, click the link in the **Refund/Write Off Request Information** column corresponding to the write off request whose details you want to edit.

The **Write Off Request** screen appears.

3. Click the **Edit** button in the **Write Off Request** zone.

The **Edit Write Off Request** screen appears.

Note: The **Edit** button appears only when the write off request is in the **Draft** status.

4. Ensure that the **Characteristics** section is expanded when you are editing the write off request.

The **Characteristics** section contains the following fields:

Field Name	Field Description	Mandatory (Yes or No)
Effective Date	Used to specify the date from when the characteristic is effective for the write off request.	Yes (Conditional)
		Note: This field is required when you are defining a characteristic for the write off request.
Characteristic Type	Used to indicate the characteristic type. Note: The list includes only those characteristic types where the characteristic entity is set to Refund Write Off Request .	Yes (Conditional)
		Note: This field is required when you are defining a characteristic for the write off request.
Characteristic Value	Used to specify the value for the characteristic type. Note: On specifying the value for a predefined characteristic type, the description of the characteristic value appears corresponding to the Characteristic Value field.	Yes (Conditional)
		Note: This field is required when you are defining a characteristic for the write off request.

5. Enter the required details in the **Characteristics** section.

Note: If you select a predefined characteristic type, the **Search** (🔍) icon appears corresponding to the **Characteristic Value** field. On clicking the **Search** icon, you can search for a predefined characteristic value.

6. If you want to define more than one characteristic for the write off request, click the **Add** (+) icon and then repeat step 5.

Note: However, if you want to remove a characteristic from the write off request, click the **Delete** (🗑️) icon corresponding to the characteristic.

Related Topics

For more information on...	See...
How to search for a write off request	Searching for a Refund or Write Off Request on page 1737
How to create a write off request	Creating a Write Off Request on page 1740

Adding a Debit Bill to the Write Off Request

Prerequisites

To add a debit bill to the write off request, you should have:

- Completed bills for the account with one or more debit line items

Procedure

To add a debit bill to the write off request:

1. Click the **Bills** tab in the **Write Off Request** screen.

The **Bills** tab appears.

2. Filter the bills, if required, in the **Search Bills** zone.

Note: If a write off request is currently in progress for a debit bill segment or adjustment of a bill, those bills of the account are not listed in the **Search Bills** zone. In addition, a bill with all credit line items are not listed in the **Search Bills** zone.

3. Do either of the following:

If...	Then...
A bill has all debit line items and you want to add the debit bill to the write off request	<ol style="list-style-type: none"> 1. In the Search Bills zone, select the bills that you want to write off. 2. Click the Add button available at the upper left corner of the Search Bills zone. <p>Note: Default adjustment type selected in the write off request type should be non A/P.</p>
A bill has debit balance and one or more credit line items and you want to add the debit bill to the write off request	<ol style="list-style-type: none"> 1. In the Search Bills zone, select the bills that you want to write off. 2. Click the Add button available at the upper left corner of the Search Bills zone. <p>Note: Default adjustment type selected in the write off request type should be non A/P.</p>

4. Click **Add**.

A message appears indicating that the selected bills are added to the write off request.

Note: If you select a bill (with credit balance) which contains one or more debit line items or if you select a bill (with debit balance) which contains one or more credit line items, the system will not allow you to add the debit line items by directly adding the bill. In such case, you need to individually select the debit bill segments and adjustments of the bill and then add them to the write off request.

5. Click **OK**.

Note that the debit bill segments or adjustments are added in the **Write Off Details** zone on the **Main** tab.

Note:

Irrespective of whether you select a debit bill, or debit bill segments or adjustments, the debit bill segments or adjustments are added in the **Write Off Details** zone. The debit bill is not added to the **Write Off Details** zone. The system will not allow you to add a credit line item to the **Write Off Details** zone.

Related Topics

For more information on...	See...
How to create a write off request	Creating a Write Off Request on page 1740

--

Adding a Debit Bill Line Item to the Write Off Request

You can write off the debit bill line items, such as bill segments and adjustments, of the account. While adding a debit bill line item to the write off request, you can either:

- Directly add all debit line items of a bill to the write off request by adding the bill which has all bill segments and adjustments in debit
- Individually add a debit bill segment or adjustment of a bill (with one or more debit line items) to the write off request

Prerequisites

To add a debit bill line item to the write off request, you should have:

- Completed bills for the account with one or more debit line items

Procedure

To add a debit bill line item to the write off request:



1. Click the **Bills** tab in the **Write Off Request** screen.

The **Bills** tab appears.

2. Filter the bills, if required, in the **Search Bills** zone.

Note: If a write off request is currently in progress for a debit bill segment or adjustment of a bill, those bills of the account are not listed in the **Search Bills** zone. In addition, a bill with all credit line items are not listed in the **Search Bills** zone.

3. Do any of the following:

If...	Then...
A bill has all debit line items and you want to add a particular debit bill line item to the write off request	<ol style="list-style-type: none"> 1. In the Search Bills zone, click the Broadcast  icon corresponding to the bill whose line items you want to view. The Bill Line Items zone appears. 2. Select the check box corresponding to the debit bill segment or adjustment that you want to write off.
A bill has debit balance and one or more credit line items	<ol style="list-style-type: none"> 1. In the Search Bills zone, click the Broadcast  icon corresponding to the bill whose line items you want to view. The Bill Line Items zone appears. 2. Select the check box corresponding to the debit bill segment or adjustment that you want to write off.
A bill has credit balance and one or more debit line items	<ol style="list-style-type: none"> 1. In the Search Bills zone, click the Broadcast  icon corresponding to the bill whose line items you want to view.

If...	Then...
	<p>The Bill Line Items zone appears.</p> <p>2. Select the check box corresponding to the debit bill segment or adjustment that you want to write off.</p>

4. Click **Add**.

A message appears indicating that the selected bill segments or adjustments are added to the write off request.

Note: If you select a bill (with credit balance) which contains one or more debit line items or if you select a bill (with debit balance) which contains one or more credit line items, the system will not allow you to add the debit line items by directly adding the bill. In such case, you need to individually select the debit bill segments and adjustments of the bill and then add them to the write off request.

5. Click **OK**.

Note that the debit bill segments or adjustments are added in the **Write Off Details** zone on the **Main** tab.

Note:

Irrespective of whether you select a debit bill, or debit bill segments or adjustments, the debit bill segments or adjustments are added in the **Write Off Details** zone. The debit bill is not added to the **Write Off Details** zone.

The system will not allow you to add a credit line item to the **Write Off Details** zone.

Related Topics

For more information on...	See...
How to create a write off request	Creating a Write Off Request on page 1740

Editing a Write Off Request

Prerequisites

To edit a write off request, you should have:

- Adjustment types without A/P request type defined in the application

Procedure

To edit a write off request:

1. Search for the write off request in the **Refund/Write Off Request** screen.
2. In the **Search Results** section, click the link in the **Refund/Write Off Request Information** column corresponding to the write off request whose details you want to edit.

The **Write Off Request** screen appears.

3. Click the **Edit** button in the **Write Off Request** zone.

The **Edit Write Off Request** screen appears. It contains the following fields:

Field Name	Field Description	Mandatory (Yes or No)
Write Off Request Information	Displays information about the write off request.	Not applicable

Field Name	Field Description	Mandatory (Yes or No)
Account Information	Indicates the account for which the write off request is created.	Not applicable
Comments	Used to specify additional information about the write off request.	No

In addition, this screen contains the following two sections:

- **Characteristics** — Used to define the characteristics for the write off request. It contains the following fields:

Field Name	Field Description	Mandatory (Yes or No)
Effective Date	Used to specify the date from when the characteristic is effective for the write off request.	Yes (Conditional)
		Note: This field is required when you are defining a characteristic for the write off request.
Characteristic Type	Used to indicate the characteristic type.	Yes (Conditional)
	Note: The list includes only those characteristic types where the characteristic entity is set to Refund Write Off Request .	Note: This field is required when you are defining a characteristic for the write off request.
Characteristic Value	Used to specify the value for the characteristic type.	Yes (Conditional)
	Note: On specifying the value for a predefined characteristic type, the description of the characteristic value appears corresponding to the Characteristic Value field.	Note: This field is required when you are defining a characteristic for the write off request.

4. Modify the details of the write off request, if required.
5. Define, edit, or remove characteristics of the write off request, if required.
6. Click **Save**.

The changes made to the write off request are saved.

Related Topics

For more information on...	See...
How to search for a write off request	Searching for a Refund or Write Off Request on page 1737
Write Off Request screen	Write Off Request on page 1777
Write Off Request zone	Write Off Request on page 1778
How to define a characteristic for a write off request	Defining a Characteristic for a Write Off Request on page 1787

Editing the Write Off Details

Prerequisites

To edit the write off details, you should have:

- Adjustment types with A/P request type defined in the application

Procedure

To edit the write off details:

1. Search for the write off request in the **Refund/Write Off Request** screen.
2. In the **Search Results** section, click the link in the **Refund/Write Off Request Information** column corresponding to the write off request whose bill line item details you want to edit.

The **Write Off Request** screen appears. You can edit the bill line items of the write off request by using either of the following ways:

If...	Then...
Select the bill whose details you want to edit in the Write Off Details zone and click the Edit button available in the upper left corner of this zone.	The Edit Request Details screen appears.
In the Write Off Details zone, click the Broadcast (📡) icon corresponding to the bill whose line items details you want to edit.	<p>The Bill Line Items zone appears.</p> <p>Note: This zone appears when the Entity Type is Bill.</p> <p>1. Select the bill line item whose details you want to edit in the Bill Line Items zone and click the Edit button available in the upper left corner of this zone.</p> <p>The Edit Request Details screen appears.</p>

Note: A bill line item from the write off request can be edited when the write off request is in the **Draft** status.

The **Edit Request Details** screen appears. It contains the following fields:

Field Name	Field Description	Mandatory (Yes or No)
Request ID	Displays the write off request ID.	Not applicable
Account Information	Displays additional information about the account.	Not applicable
Adjustment Type	<p>Indicates the adjustment type of the write off request type.</p> <p>You can search for an adjustment type by clicking the Search (🔍) icon corresponding to the field.</p>	No

In addition to these fields, this screen contains following columns:

Column Name	Column Description
Entity Type	Indicates the entity type. The valid values are <ul style="list-style-type: none"> • Adjustments • Bill • Bill Segment • Payment Event • Payment
Entity ID	Displays the entity ID.
Entity Amount	Displays the entity amount.
Currency	Displays the currency in which the entity was created.
Request Amount	Displays the amount that must be write off.
Adjustment Type	Indicates the adjustment type using which the write off adjustment must be created. Note: You can search for an account by clicking the Search (🔍) icon corresponding to the field.
Bill ID	Displays the bill ID.

In addition to the above columns, the screen has following button:

Button Name	Button Description
Override	Used to override an adjustment type of the write off request.

<p>Note:</p> <p>Pagination is used to display limited number of records in the Search Results section. By default, 10 records are displayed in the Search Results section. You can change the number of records displayed per page, if required.</p> <p>You can use the navigation buttons, such as First (◀◀), Previous (◀), Next (▶), and Last (▶▶) to navigate between pages. You can also select the page to which you want to navigate from the Go To list.</p> <p>The values appear in the Page Limit list when you define values for the PAGE_NUMBER lookup field.</p>

3. Modify the details of the bill line items.
4. Click **Save**.

The changes made to the write off bill line items are saved.

Related Topics

For more information on...	See...
Write Off Request screen	Write Off Request on page 1777
Write Off Request zone	Write Off Request on page 1778
How to search for a write off request	Searching for a Refund or Write Off Request on page 1737

Deleting a Write Off Request

Procedure

To delete a write off request:

1. Search for the write off request in the **Refund/Write Off Request** screen.
2. In the **Search Results** section, click the link in the **Refund/Write Off Request Information** column corresponding to the write off request that you want to delete.

The **Write Off Request** screen appears.

3. Click the **Delete** button in the **Write Off Request** zone.

A message appears confirming whether you want to delete the write off request.

Note: The **Delete** button appears when the write off request is in the **Draft** status.

4. Click **OK**.

The write off request is deleted.

Related Topics

For more information on...	See...
How to search for a write off request	Searching for a Refund or Write Off Request on page 1737
Write Off Request screen	Write Off Request on page 1777
Write Off Request zone	Write Off Request on page 1778

Deleting a Bill from the Write Off Request

Procedure

To delete a bill from the write off request:

1. Search for the write off request in the **Refund/Write Off Request** screen.
2. In the **Search Results** section, click the link in the **Refund/Write Off Request Information** column corresponding to the write off request whose bill you want to delete.

The **Write Off Request** screen appears.

3. In the **Write Off Details** zone, select the bills and click the **Delete** button available in the upper left corner of this zone.

A message appears confirming whether you want to delete the bill from the write off request.

Note: You can delete bill from the write off request when the request is in the **Draft** status.

4. Click **OK**.

The selected bill gets deleted from the write off request.

Related Topics

For more information on...	See...
Write Off Request screen	Write Off Request on page 1777
Write Off Request zone	Write Off Request on page 1778
How to search for a write off request	Searching for a Refund or Write Off Request on page 1737

Deleting a Bill Line Item from the Write Off Request

Procedure

To delete a bill line item from the write off request:

1. Search for the write off request in the **Refund/Write Off Request** screen.
2. In the **Search Results** section, click the link in the **Refund/Write Off Request Information** column corresponding to the write off request whose bill line items you want to delete.

The **Write Off Request** screen appears.

3. In the **Write Off Details** zone, click the **Broadcast** () icon corresponding to the bill whose line items details you want to delete.

The **Bill Line Items** zone appears.

4. In the **Bill Line Items** zone, select the bill line items which you want to delete and click the **Delete** button available in the upper left corner of this zone.

A message appears confirming whether you want to delete the bill line items from the write off request.

Note: You can delete a bill line items from the write off request when the request is in the **Draft** status.

5. Click **OK**.

The selected bill line items gets deleted from the write off request.

Related Topics

For more information on...	See...
Write Off Request screen	Write Off Request on page 1777
Write Off Request zone	Write Off Request on page 1778
How to search for a write off request	Searching for a Refund or Write Off Request on page 1737

Submitting a Write Off Request

Prerequisites

To submit a write off request, you should have:

- Debit bill line items added in the write off request

Procedure

To submit a write off request:

1. Search for the write off request in the **Refund/Write Off Request** screen.

2. In the **Search Results** section, click the link in the **Refund/Write Off Request Information** column corresponding to the write off request that you want to submit.

The **Write Off Request** screen appears.

3. Click the **Submit** button in the **Write Off Request** zone.

The system behaves in the following manner:

If...	Then
The Approval Required and Hierarchical Approval check boxes are selected in the write off request type using which the write off request is created	A To Do of the C1-WOREQ To Do type is created and sent to the approver at the first level in the approval hierarchy, and the status of the write off request is changed to Approval In Progress .
The Approval Required check box is selected, but the Hierarchical Approval check box is not selected in the write off request type using which the write off request is created	A To Do of the C1-WOREQ To Do type is created and sent to the approver at the hierarchy level where the total write off amount falls within the threshold limit. In addition, the status of the write off request is changed to Approval In Progress .
The Approval Required check box is not selected in the write off request type using which the write off request is created	<p>The write off adjustments are created using the specified adjustment types and the status of the write off request is changed to Processed.</p> <p>Note: The write off adjustments are created in the Frozen status. If a match event is present for the debit bill line items (such as bill segments and adjustments), the existing match event is stamped on the write off adjustments and on the corresponding financial transactions. However, if the match events does not exist, a new match event is created and stamped on the write off adjustments and on the corresponding financial transactions. If you are doing a partial write off for any entity, the corresponding match event status is set to Open. However, if the entire eligible amount is written off, the corresponding match event status is set to Balanced.</p>
The total write off amount is less than the minimum threshold amount	<p>The write off request is automatically approved by the system and write off adjustments are created using the specified adjustment types. In addition, the status of the write off request is changed to Processed.</p> <p>Note: The write off adjustments are created in the Frozen status. If a match event is present for the debit bill line items (such as bill segments and adjustments), the existing match event is stamped on the write off adjustments and on the corresponding financial transactions. However, if the match events does not exist, a new match event is created and stamped on the write off adjustments and on the corresponding financial transactions. If you are doing a partial write off for any entity, the corresponding match event status is set to Open. However, if the entire eligible amount is written off, the corresponding match event status is set to Balanced.</p>

Note: The **Submit** button appears when the write off request is in the **Draft** status.

Related Topics

For more information on...	See...
How to search for a write off request	Searching for a Refund or Write Off Request on page 1737
Write Off Request screen	Write Off Request on page 1777
Write Off Request zone	Write Off Request on page 1778

Approving a Write Off Request

You can view the number of write off requests which are pending for approval in the **Refund/Write Off Request** screen. The approver can review, and accordingly approve or reject the write off request based on the observations.

Note: The system will not allow you to approve or reject a write off request submitted by you.

Procedure

To approve a write off request:

1. Do either of the following:

If you want to...	Then...
Approve a write off request through the Refund/Write Off Request screen	<ol style="list-style-type: none"> 1. Search for the write off request in the Refund/Write Off Request screen. 2. In the Search Results section, click the link in the Refund/Write Off Request Information column corresponding to the write off request which you want to review.
Approve a write off request from the To Do List screen	<ol style="list-style-type: none"> 1. Click the Menu link in the Application toolbar. A list appears. 2. From the Main menu, select To Do and then click To Do List. The To Do Type for User Search window appears. 3. Enter C1-WOREQ in the To Do Type field. 4. Click the Search button corresponding to the To Do Type field. The To Do List screen appears. 5. Select the Open option from the Filter by list to view all unassigned To Dos.

If you want to...	Then...
	6. Click the link in the Message column corresponding to the To Do of the write off request that you want to review.

The **Write Off Request** screen appears.

2. Review the write off request details.
3. Click the **Approve** button in the **Write Off Request** zone.

The system behaves in the following manner:

If...	Then...
The Hierarchical Approval check box is selected in the write off request type using which the write off request is created and the total write off amount is greater than the threshold amount specified at the next level in the approval hierarchy	A To Do of the C1-WOREQ To Do type is created and sent to the approver at the next level in the approval hierarchy, and the status of the write off request remains as Approval In Progress .
The Hierarchical Approval check box is selected in the write off request type using which the write off request is created and the total write off amount is less than the threshold amount specified at the next level in the approval hierarchy	<p>The write off adjustments are created using the specified adjustment types and the status of the write off request is changed to Processed.</p> <p>Note: The write off adjustments are created in the Frozen status. If a match event is present for the debit bill line items (such as bill segments and adjustments), the existing match event is stamped on the write off adjustments and on the corresponding financial transactions. However, if the match events does not exist, a new match event is created and stamped on the write off adjustments and on the corresponding financial transactions. If you are doing a partial write off for any entity, the corresponding match event status is set to Open. However, if the entire eligible amount is written off, the corresponding match event status is set to Balanced.</p>
The Hierarchical Approval check box is not selected in the write off request type using which the write off request is created	<p>The write off adjustments are created using the specified adjustment types and the status of the write off request is changed to Processed.</p> <p>Note: The write off adjustments are created in the Frozen status. If a match event is present for the debit bill line items (such as bill segments and adjustments), the existing match event is stamped on the write off adjustments and on the corresponding financial transactions. However, if the match events does not exist, a new match event is created and stamped on the write off adjustments and on the corresponding financial transactions. If you are doing a partial write off for any entity, the corresponding match event status is set to Open. However, if the entire eligible amount is written off, the corresponding match event status is set to Balanced.</p>

Note: The **Approve** button appears when:

- The write off request is in the **Approval In Progress** status.
- A user with the approval To Do role is reviewing the write off request.

Related Topics

For more information on...	See...
How to search for a write off request	Searching for a Refund or Write Off Request on page 1737
Write Off Request screen	Write Off Request on page 1777
Write Off Request zone	Write Off Request on page 1778

Rejecting a Write Off Request

Prerequisites

To reject a write off request, you should have:

- Rejection reasons defined in the application

Note:

While rejecting a write off request, you need to specify the reason why you want to reject the write off request. You can select the appropriate rejection reason when you have defined the reasons for the **Rejected** status of the **C1-WORequest** business object in the **Status Reason** screen.

The system will not allow you to approve or reject a write off request submitted by you.

Procedure

To reject a write off request:

1. Do either of the following:

If you want to...	Then...
Reject a write off request through the Refund/Write Off Request screen	<ol style="list-style-type: none"> 1. Search for the write off request in the Refund/Write Off Request screen. 2. In the Search Results section, click the link in the Refund/Write Off Request Information column corresponding to the write off request which you want to review.
Reject a write off request from the To Do List screen	<ol style="list-style-type: none"> 1. Click the Menu link in the Application toolbar. A list appears. 2. From the Main menu, select To Do and then click To Do List. The To Do Type for User Search window appears.

If you want to...	Then...
	<ol style="list-style-type: none"> 3. Enter C1-WOREQ in the To Do Type field. 4. Click the Search button corresponding to the To Do Type field. The To Do List screen appears. 5. Select the Open option from the Filter by list to view all unassigned To Dos. 6. Click the link in the Message column corresponding to the To Do of the write off request that you want to review.

The **Write Off Request** screen appears.

2. Review the write off request details.
3. Click the **Reject** button in the **Write Off Request** zone.

The **Reject Write Off Request** window appears. It contains following fields:

Field Name	Field Description	Mandatory (Yes or No)
Status Reason	Used to indicate the reason why you want to reject the write off request.	Yes
Comments	Used to specify additional information while rejecting the write off request.	No

Note: The **Reject** button appears when:

- The write off request is in the **Approval In Progress** status.
- A user with the approval To Do role is reviewing the write off request.

4. Select the rejection reason from the **Status Reason** list.
5. Click **Save**.

The status of the write off request is changed to **Rejected**.

Related Topics

For more information on...	See...
How to search for a write off request	Searching for a Refund or Write Off Request on page 1737
Write Off Request screen	Write Off Request on page 1777
Write Off Request zone	Write Off Request on page 1778

Viewing the Log of a Write Off Request

Procedure

To view the log of a write off request:

1. Search for the write off request in the **Refund/Write Off Request** screen.
2. In the **Search Results** section, click the link in the **Refund/Write Off Request Information** column corresponding to the write off request whose log you want to view.

The **Write Off Request** screen appears. It consists of the following tabs:

- **Main** – Displays information about the write off request. It contains the following zones:
 - **Write Off Request** – Displays the details of the write off request.
 - **Write Off Details** – Lists the debit bill line items (such as debit bill segments and adjustments) of the account which must be written off.
 - **Bill Line Items** — Displays the details of the bill which must be written off.

Note:

This zone appears when you click the Broadcast (📡) icon corresponding to the entity type as **Bill** in the **Write Off Details** zone.

- **Bills** — Used to search bills with debit line items, such as debit bill segments and adjustments, that you want to write off. This tab appears when the write off request is in the **Draft** status.
 - **Log** – Lists the complete trail of actions performed on the write off request.
3. Click the **Log** tab
 4. View the log of the write off request in the **Write Off Request Log** zone.

Note: You can manually add a log entry for the write off request by clicking the **Add Log Entry** link in the upper right corner of the **Write Off Request Log** zone.

Related Topics

For more information on...	See...
How to search for a write off request	Searching for a Refund or Write Off Request on page 1737
How to add a log entry for a write off request	Adding a Log Entry for a Write Off Request on page 1802
Write Off Request Log zone	Write Off Request Log on page 1784

Adding a Log Entry for a Write Off Request

Procedure

To add a log entry for a write off request:

1. Search for the write off request in the **Refund/Write Off Request** screen.
2. In the **Search Results** section, click the link in the **Refund/Write Off Request Information** column corresponding to the write off request whose log you want to edit.

The **Write Off Request** screen appears. It consists of the following tabs:

- **Main** – Displays information about the write off request. It contains the following zones:
 - **Write Off Request** – Displays the details of the write off request.
 - **Write Off Details** – Lists the debit bill line items (such as debit bill segments and adjustments) of the account which must be written off.

- **Bills** — Used to search bills with debit line items, such as debit bill segments and adjustments, that you want to write off. This tab appears when the write off request is in the **Draft** status.
 - **Log** – Lists the complete trail of actions performed on the write off request.
3. Click the **Log** tab.

The **Log** tab appears.

4. Click the **Add Log Entry** link in the upper right corner of the **Write Off Request Log** zone.

The **Add Request Log** window appears. It contains the following fields:

Field Name	Field Description	Mandatory (Yes or No)
Request Information	Displays information about the write off request.	Not applicable
Log Details	Used to specify additional comments for the write off request.	Yes

5. Enter the comments in the **Log Details** field.
 6. Click **Save**.
- The log entry is added in the **Write Off Request Log** zone.

Related Topics

For more information on...	See...
How to search for a write off request	Searching for a Refund or Write Off Request on page 1737

Cancelling a Write Off Request

There might be situations when incorrect write off request is processed in the system. In such case, the system provides you with an ability to cancel the write off request. However, note that you can cancel a write off request when the write off request is in the **Processed** status.

Prerequisites

To cancel a write off request, you should have:

- Cancel reasons defined in the application

Note: While cancelling a write off request, you need to specify the reason why you want to cancel the write off request. You can select the appropriate cancel reason when you have defined the reasons for the **Cancelled** status of the **C1-WORequest** business object in the **Status Reason** screen.

Procedure

To cancel a write off request:

1. Search for the write off request in the **Refund/Write Off Request** screen.
2. In the **Search Results** section, click the link in the **Refund/Write Off Request Information** column corresponding to the write off request that you want to cancel.

The **Write Off Request** screen appears.

3. Click the **Cancel** button in the **Write Off Request** zone.

The **Cancel Reason** window appears. It contains the following fields:

Field Name	Field Description	Mandatory (Yes or No)
Status Reason	Used to indicate the reason why you want to cancel the write off request.	Yes
Comments	Used to specify additional information while cancelling the write off request.	No

Note: The **Cancel** button appears when the write off request is in the **Processed** status.

4. Select the cancel reason from the **Status Reason** list.
5. Click **Save**.

The status of the write off request is changed to **Cancelled**.

Note: The **C1-WOCANCEL** algorithm cancels all the frozen adjustments created for the write off request which is in the **Processed** state.

Related Topics

For more information on...	See...
How to search for a write off request	Searching for a Refund or Write Off Request on page 1737
Write Off Request screen	Write Off Request on page 1777
Write Off Request zone	Write Off Request on page 1778

Chapter 25

Hold Request

Topics:

- [Prerequisites](#)
- [Hold Request \(Without Approval\) Status Transition](#)
- [Hold Request \(With Approval\) Status Transition](#)
- [Types of Hold Processes](#)
- [Algorithms Used in C1-HoldRequest](#)
- [Hold Request Type](#)
- [Hold Request \(Used for Searching\)](#)
- [Hold Request \(Used for Viewing\)](#)

Oracle Revenue Management and Billing allows to hold a process (in case of a natural disaster) for different entities like account, bill, and person. It is a way to prevent the execution of various processes that are scheduled to happen for an entity, for a given period of time.

The processes that are to be kept on hold (for a given period of time) may certainly differ based on the reason provided for the hold, for instance, keeping the automatic payment process on hold for a particular person, until the hurricane duration is completely over. The hold period is defined as the duration between the hold request start date and hold request end date. The hold request comprises of an entity for which multiple processes are kept on hold. So, you can raise multiple hold requests for an entity with different hold processes and hold reasons.

Following entities are considered in the hold request for which a hold request is created:

- **Person:** - If you create a hold request for a person, then all the entities such as accounts and bills where the person is financially responsible are considered in the hold request.
- **Account:** - If you create a hold request for an account, then all the bills that are associated with the account are considered in the hold request.
- **Bill:** - If you create a hold request for a bill, then you can either add complete or partial bill in the hold request.

Following processes are considered in the hold request for which a hold request is created:

- **Auto Pay** - If you add the auto pay process in the hold request, the auto pay process for the bills of the respective account added in the hold request is placed on hold until the hold request is released. However, this process does not obstruct from making any manual payments. Once the hold request is activated, the **Defer Auto Pay Date** is set to the hold process end date or hold entity end date, whichever is earlier.

Note:

The auto pay process is considered in the hold request only for an account entity.

If the bill generation process is placed on hold, the system placed the auto pay process on hold.

- **Bill Generation** - If the bill generation process is placed on hold, no new bills are generated for the respective account for which the hold request is created. Once the hold request is activated, the **Bill After Date** is set to the

hold process end date or hold entity end date, whichever is earlier. Once the hold request is released, the **Bill After Date** is set as the system date.

Note: The bill generation process is considered in the hold request for the account and person entity.

- **Overdue** - If the overdue process is placed on hold, all the bills that are associated with the account are considered for hold in the hold request. Once the hold request is activated, the **Postpone Credit Review Until** date is set to the hold process end date or hold entity end date, whichever is earlier. This means that the system does not allow the overdue process to take place till the postpone credit review until date. Once the hold request is released, the system does not create a new overdue process in place of the earlier one for the respective account.

Note: The overdue process is considered in the hold request only for an account entity.

- **Funding** - If the funding process is placed on hold, a list of bills are identified (based on the bill inclusion in the funding request) where either the partial or complete bill amount is placed on hold. Once the hold request is released, the respective bills are considered in the funding request.

Note: The funding process is considered in the hold request for the account, bill, and person entity.

You need to specify the hold request type while creating a hold request. It is the hold request type which helps the system to determine:

- Whether to allow partial or complete bill to be placed on hold
- Whether hold request must be approved by the approver before considering the entities and processes for hold

It is quite possible for a given entity, such as a person or account, to be affected by hold request possessing differing periods or differing levels. For instance, a hold request is created manually for a person and another hold request exists in the system (due to some other reason) for an account associated with the person who for whom the hold request is created. In this case, the system assumes that both the hold requests are in effect for the account and the period of the account begins from the start of the earlier hold request record (for the account) until the later of the two release dates. Let us understand this scenario with an example:

Hold Request	Entities	Hold Start Date	Request
Person 1	Account 1, Account 2, Account 3	01-01-2022	
Account 1	-	05-01-2022	

In the above example, the hold request for Person 1 is scheduled on 01-01-2022 containing entities like Account 1, Account 2, and Account 3. However, another hold request is also scheduled in the system on 05-01-2022 which adds the Account 1 on hold. Now, in this scenario, system compares the hold request start date of both Person 1 and Account 1, and selects the date that arrives earlier, which happens to be 01-01-2022 belonging to Person 1. As Person 1 contains

Account 1, the system places Account 1 on hold on 01-01-2022 even though Account 1 is scheduled for hold on 05-01-2022

During the hold request process, a hold request goes through various statuses in its lifecycle. For more information about the hold request statuses, see [Hold Request \(Without Approval\) Status Transition](#) on page 1808 and [Hold Request \(With Approval\) Status Transition](#) on page 1810

Note that the lifecycle of a hold request is driven by the business object using which the hold request is created. A hold request business object named **C1-HoldRequest** is shipped with the product. The hold request feature explained in this document is articulated based on the lifecycle and logic defined in the **C1-HoldRequest** business object. In addition, you can configure the **C1-HOLDSRCH** feature configuration and define the values for account, bill, and person entity.

For more information on how to setup the hold request processes, see [Prerequisites](#) on page 1808.

Prerequisites

To setup the hold request process, you need to do the following:

- Define the required hold request types in the system
- Define the required hold reasons in the system
- Define the required characteristic types where the characteristic entity is set to **Hold Request Type**
- Define the required characteristic types where the characteristic entity is set to **Hold Request**
- Define the required values for the **HOLD_ENTITY_LVL_FLG** lookup field.
- Define the required values for the **HOLD_PROCESS_FLG** lookup field.
- Define the status reasons for the **Rejected** and **Released** statuses of the **C1-HoldRequest** business object in the **Status Reason** screen
- Assign the **C1-HLDAP** To Do type to a To Do role whose users must receive To Do generated while submitting a hold request for approval
- Assign the **C1-HOLSB** To Do type to a To Do role whose users must receive To Do when an approver requests to resubmit the hold request for approval
- Set the batch control type of the **Hold Request Periodic Monitor (C1-HLDRQ)** and **Hold Request Monitor (C1-HLMON)** batches to Timed and define the following attributes:
 - Time Interval
 - Timer Active
 - User ID
 - Batch Language
 - Email Address

Note: For more information about the batch, refer to *Oracle Revenue Management and Billing Batch Guide*

Hold Request (Without Approval) Status Transition

The following figure graphically indicates how a hold request moves from one status to another when approval workflow is off:

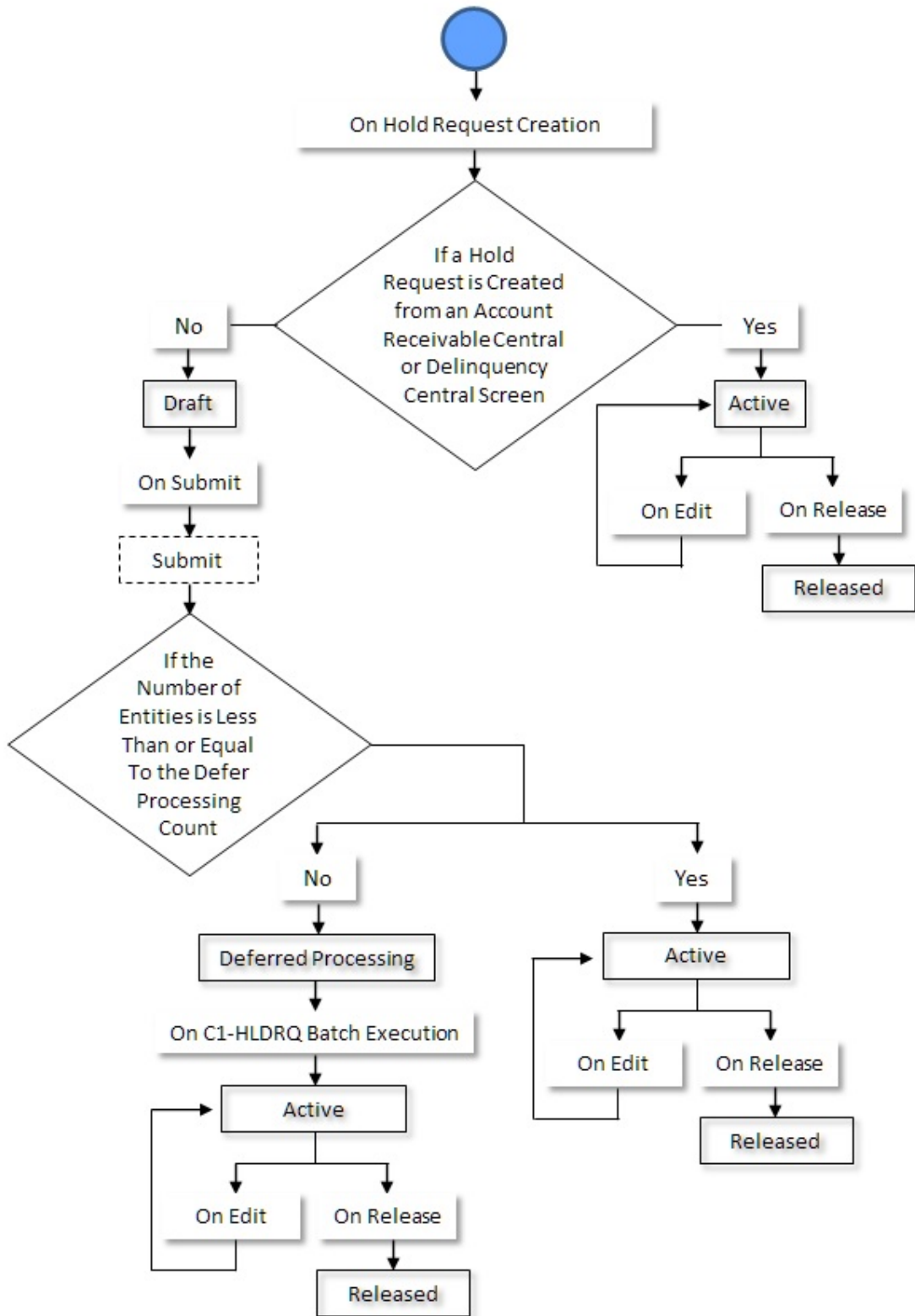

Hold Request (With Approval) Status Transition

The following figure graphically indicates how a hold request moves from one status to another when approval workflow is on:

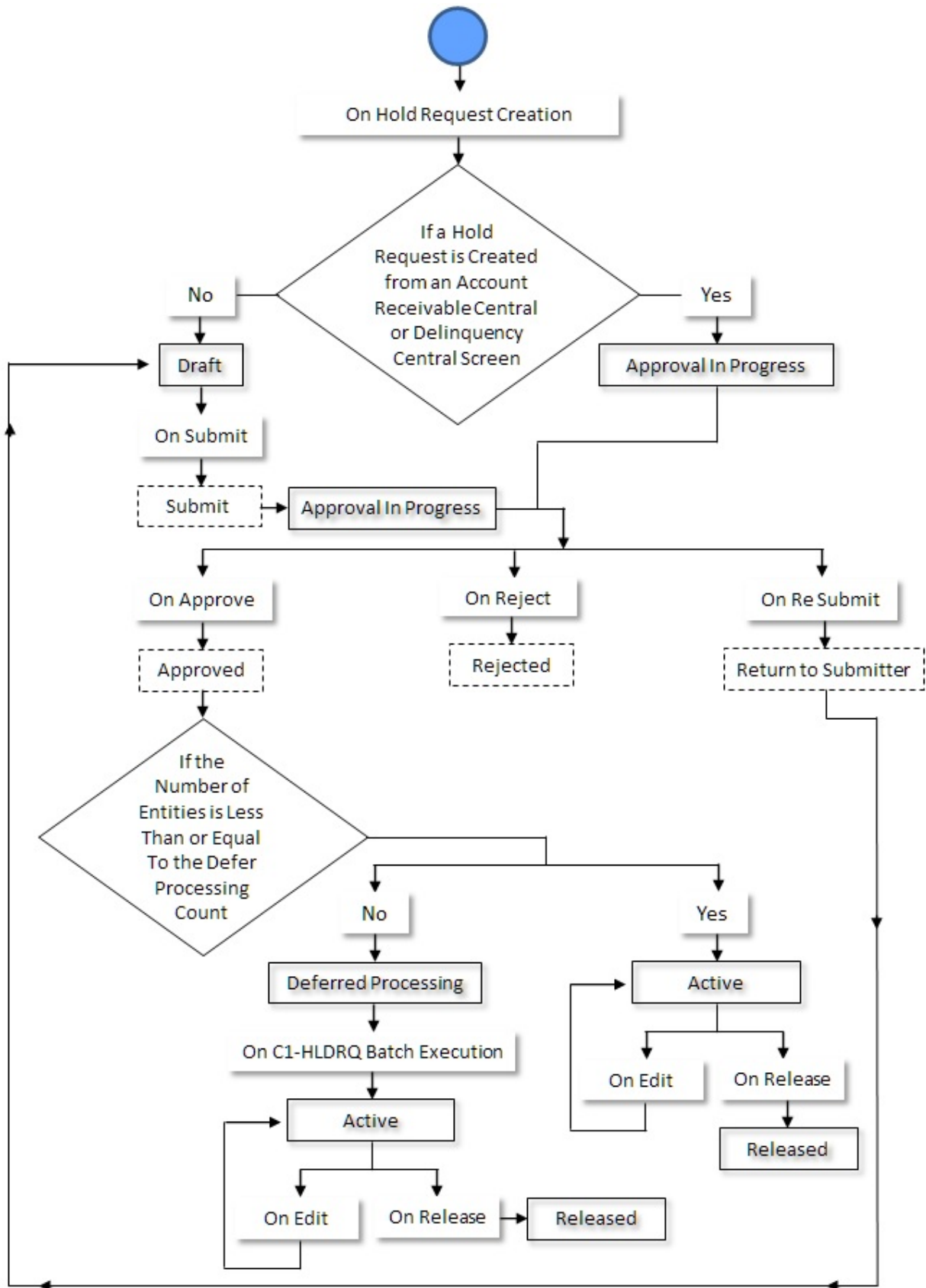

Types of Hold Processes

Oracle Revenue Management and Billing enables you to hold different types of processes for a hold request.

- [Auto Pay](#) on page 1812
- [Bill Generation](#) on page 1813
- [Funding](#) on page 1814
- [Overdue](#) on page 1816

Auto Pay

Oracle Revenue Management and Billing allows you to hold the auto pay (automatic payment) process for an account through the hold request. Once the auto pay process is on hold, the account and its respective bills become eligible for hold, until the hold request is released. Let us understand how the system behaves when the hold request (for an auto pay process) goes on activation and then on release.

Note: The auto pay process is considered in the hold request only for the account entity.

System Event	Then...
Auto Pay - On Activation	<p>The system invokes the C1-HOLDACTV algorithm attached to the Enter system event of the C1-HoldRequest business object. The algorithm updates the start date of the hold processes and hold entities to the system date.</p> <p>Once the start date is stamped, the system compares hold process and hold entity end date. Based on the comparison, the system stamps the defer auto pay date corresponding to each account in the hold request. The Defer Auto Pay Date field in the Hold Entities zone is either set to the hold process end date or hold entity end date, whichever is earlier. This means that the system does not allow processing of any automatic payments till the defer auto pay date.</p> <p>If the number of entities in a hold request is less than or equal to the defer processing count specified in the respective hold request type, the system stamps the defer auto pay date immediately for each account in the hold request. In addition, the system changes the status of the hold request to Active.</p> <p>However, if the number of entities in a hold request is greater than the defer processing count specified in the respective hold request type, the system stamps the defer auto pay date for each account in the hold request when the C1-HLMON batch is executed. In addition, the C1-HLMON batch changes the status of the hold request to Active.</p>

System Event	Then...
Auto Pay - On Release	<p>When you manually release a hold request from the user interface, the system sets the hold request, hold entities, and hold processes end dates (which are later than or equal to the system date) to the system date and then changes the status of the hold request to Released. If the number of entities in a hold request is less than or equal to the defer processing count specified in the respective hold request type, the system immediately sets the defer auto pay date (which is later than or equal to the system date) in the Defer Auto Pay Date field of the Hold Entities zone to the system date for the account in the respective hold request.</p> <p>However, if the number of accounts in a hold request is equal to or greater than the defer processing count specified in the respective hold request type, the system sets the defer auto pay date (which is later than or equal to the system date) to the system date for the account in the hold request when the C1-HLMON batch is executed. In addition, the C1-HLMON batch changes the status of the hold request to Released.</p>

Note: If you create a hold request for an account and auto pay process where the hold entity end date mentioned in the hold request is earlier than the batch business date, the system in that case updates the automatic payment details in the **CI_BILL_ACH** table.

Bill Generation

Oracle Revenue Management and Billing allows you to hold the bill generation process for the account or person through the hold request. Once the bill generation process is on hold, new bills are not created for the account that is included in the hold request, until the hold request is released. Let us understand how the system behaves when the hold request (for bill generation) goes on activation and then on release.

Note: The bill generation process is considered in the hold request only for the account and person entity.

System Event	Then...
Bill Generation - On Activation	<p>The system invokes the C1-HOLDACTV algorithm attached to the Enter system event of the C1-HoldRequest business object. The algorithm updates the start date of the hold processes and hold entities to the system date.</p> <p>Once the start date is stamped, the system compares the hold process and hold entity end date. Based on the comparison, the system stamps the bill after date corresponding to each account in the hold request. The Bill After Date field in the Hold Entities zone is either set to the hold process end date or hold entity end date, whichever is earlier. This means that the system does not allow the bill generation process to take place till the bill after date.</p> <p>If the number of entities in a hold request is less than or equal to the defer processing count specified in the respective hold request type, the system stamps the bill after date immediately for each account in the hold request. In addition, the system changes the status of the hold request to Active.</p> <p>However, if the number of entities in a hold request is greater than the defer processing count specified in the respective hold request type, the system stamps the bill after date for each account in the hold request when the C1-HLMON batch is executed. In addition, the C1-HLMON batch changes the status of the hold request to Active.</p>

System Event	Then...
Bill Generation - On Release	<p>When you manually release a hold request from the user interface, the system sets the hold request, hold entities, and hold processes end dates (which are later than or equal to the system date) to the system date and then changes the status of the hold request to Released.</p> <p>If the number of entities in a hold request is less than or equal to the defer processing count specified in the respective hold request type, the system immediately sets the bill after date (which is later than or equal to the system date) in the Bill After Date field of the Hold Entities zone to the system date for the account in the respective hold request.</p> <p>However, if the number of accounts in a hold request is equal to or greater than the defer processing count specified in the respective hold request type, the system sets the bill after date (which is later than or equal to the system date) in the Bill After Date field of the Hold Entities zone to the system date for the account in the hold request when the C1-HLMON batch is executed.</p>

Funding

Oracle Revenue Management and Billing allows you to hold the funding process for the account, bill, and person through the hold request. Once the funding process is on hold, the list of bills that are identified for the complete or partial bill amount are kept on hold, until the hold request is released. Let us understand how the system behaves when the hold request (for funding) goes on activation and then on release.

Note: The funding process is considered in the hold request for the account, bill, and person entity.

If...	System Event	Then...
<p>The hold request is created for a account or person</p>	<p>On Activation</p>	<p>The system extracts all the bill(s) related to the respective person or account for whom the hold request is created. It then invokes the C1-HOLDACTV algorithm attached to the Enter system event of the C1-HoldRequest business object. The system checks whether the bill(s) considered in the hold request are already included in any funding request and the funding request is in the initial status of its lifecycle. If the bill(s) are already included in the funding request, the system still considers the bill(s) for hold request and performs further actions, as the funding request has already been initiated for the respective bill(s).</p> <div data-bbox="799 592 1438 705" style="border: 1px solid black; padding: 5px;"> <p>Note: The system does not allow to create a funding request using the bill(s) that are already considered in the hold request.</p> </div> <p>If the Allow Partial Hold for Bill option is selected in the respective hold request type and the hold amount is mentioned while creating the hold request, the system considers the hold amount as the partial amount in the hold request. Once the partial amount is mentioned, the system does not allow the funding process to function for the total amount of the bill(s). Hence, the funding process only takes place for the amount considered in the hold request.</p> <div data-bbox="799 995 1438 1075" style="border: 1px solid black; padding: 5px;"> <p>Note: The hold amount appears in the Search Results section of the Search zone of the funding request.</p> </div> <p>The system updates the funding and garnishment amount in the funding request for the respective bill(s). Further processing of the funding request depends on the available amount, post the amount considered for hold.</p>
	<p>On Release</p>	<p>When you manually release a hold request from the user interface, the system sets the hold request, hold entities, and hold processes end dates (which are later than or equal to the system date) to the system date and then changes the status of the hold request to Released.</p> <p>However, if the number of entities in a hold request is equal to or greater than the defer processing count specified in the respective hold request type, the system sets hold request, hold entities, and hold processes end dates (which are later than or equal to the system date) to the system date in the hold request when the C1-HLMON batch is executed.</p> <div data-bbox="799 1633 1438 1747" style="border: 1px solid black; padding: 5px;"> <p>Note: Once the hold request is released, the respective bill(s) becomes eligible to be considered in the funding request.</p> </div>

Overdue

Oracle Revenue Management and Billing allows you to hold the overdue process for an account through the hold request. Once the overdue process is on hold, the bills that are associated with the respective account included in the hold request

are also eligible for hold, until the overdue process is released. Let us understand how the system behaves when the hold request (for overdue) goes on activation and then on release.

Note: The **Overdue** process is considered in the hold request only for the **Account** entity.

System Event	Then...
<p>Overdue - On Activation</p>	<p>The system invokes the C1-HOLDACTV algorithm attached to the Enter system event of the C1-HoldRequest business object. The algorithm updates the start date of the hold processes and hold entities to the system date.</p> <p>Once the start date is stamped, the system compares the hold process and hold entity end date. Based on the comparison, the system stamps the postpone credit review until date corresponding to each account in the hold request. The Postpone Credit Review Until field in the Hold Entities zone is either set to the hold process end date or hold entity end date, whichever is earlier. This means that the system does not allow the overdue process to take place till the postpone credit review until date.</p> <p>If the number of entities in a hold request is less than or equal to the defer processing count specified in the respective hold request type, the system stamps the postpone credit review until (date) immediately for each account in the hold request. In addition, the system changes the status of the hold request to Active.</p> <p>However, if the number of entities in a hold request is greater than the defer processing count specified in the respective hold request type, the system stamps the postpone credit review until (date) for each account in the hold request when the C1-HLMON batch is executed. In addition, the C1-HLMON batch changes the status of the hold request to Active.</p> <p>Note: Once the status of the hold request (for an overdue process) is changed to Active and the postpone credit review until date is stamped, the system cancels out the earlier overdue process and restricts from creating any new overdue process for the respective account.</p>
<p>Overdue - On Release</p>	<p>When you manually release a hold request from the user interface, the system sets the hold request, hold entities, and hold processes end dates (which are later than or equal to the system date) to the system date and then changes the status of the hold request to Released.</p> <p>If the number of entities in a hold request is less than or equal to the defer processing count specified in the respective hold request type, the system immediately sets the postpone credit review until (which is later than or equal to the system date) in the Postpone Credit Review Until field of the Hold Entities zone to the system date for the account in the respective hold request.</p> <p>However, if the number of accounts in a hold request is equal to or greater than the defer processing count specified in the respective hold request type, the system sets the postpone credit review (which is later than or equal to the system date) in the Postpone Credit Review Until field of the Hold Entities zone to the system date for the account in the hold request when the C1-HLMON batch is executed.</p> <p>Note: Once the status of the hold request (for an overdue process) is changed to Released, the system does not create a new overdue process for the respective account.</p>

Algorithms Used in C1-HoldRequest

The following table lists the algorithms which are attached to the **C1-HoldRequest** business object:

System Event	Algorithm	Algorithm Type	Description
Information	C1-HOLD-INF	C1-HOLD-INF	Refer to C1-HOLD-INF
Validation	C1-HLDVALDN	C1-HLDVALDN	Refer to C1-HLDVALDN

The following table lists the algorithms which are used in the lifecycle of the **C1-HoldRequest** business object:

Status	System Event	Algorithm	Algorithm Type	Description
Draft	Enter	C1-HLDARCTRN	C1-HLDARCTRN	Refer to C1-HLDARCTRN on page 1818
	Exit	F1-TODOCOMPL	F1-TODOCOMPL	Refer to F1-TODOCOMPL on page 1566
Submit	Enter	C1-HOLDSUBMT	C1-HOLDSUBMT	Refer to C1-HOLDSUBMT on page 1819
Deferred Processing	Monitor	F1-AT-RQJ	F1-AT-RQJ	Refer to F1-AT-RQJ on page 1567
Approval Progress	In Enter	C1-HOLDAPP	C1-HOLDAPP	Refer to C1-HOLDAPP on page 1819
	Exit	F1-TODOCOMPL	F1-TODOCOMPL	Refer to F1-TODOCOMPL on page 1566
Approved	Enter	C1-HOLDAPRVD	C1-HOLDAPRVD	Refer to C1-HOLDAPRVD on page 1819
Return to Submitter	Enter	C1-HLDRESUBM	C1-HLDRESUBM	Refer to C1-HLDRESUBM on page 1819
Rejected	-	-	-	-
Active	Enter	C1-HOLDACTV	C1-HOLDACTV	Refer to C1-HOLDACTV on page 1819
Released	Enter	C1-RELENTITY	C1-RELENTITY	Refer to C1-RELENTITY on page 1820
	Enter	C1-RLSHOLD	C1-RLSHOLD	Refer to C1-RLSHOLD on page 1820

C1-HLDARCTRN

If a hold request is created from the **Accounts Receivable Central** or **Delinquency Central** screen, this algorithm transitions the hold request to **Active** status, else the hold request status is transitioned to **Draft** status.

F1-TODOCOMPL

This algorithm completes To Do entries that are created for the business object when the business object exits the given status. It finds and completes all open To Do entries where the business object's primary key is defined as a drill key. However, if the **Exclude To Do Entries From Auto Completion** characteristic is set to **Y** for the business object, the system does not automatically complete the respective To Do entry.

C1-HOLDSUBMT

This algorithm is invoked when you submit a hold request. If the approval process is not configured in the hold request type, this algorithm changes the status of the hold request to either **Deferred Processing** or **Active** depending on whether the number of entities in the hold request exceeds the defer processing count. If the approval process is configured for a hold request, the status of the hold request is changed to **Approval In Progress**.

F1-AT-RQJ

This algorithm transitions the current status of the business object to the specified status. It contains the following parameters:

- **Next Status** – Used when you want to override the default next status specified in the lifecycle.
- **Next Transition Condition** – Used when you want to override the default next transition condition specified in the lifecycle.

At a time, you can specify value for either the **Next Status** or **Next Transition Condition** parameter. If you don't specify any value for these parameters, the system will transition the business object to the default next status specified in its lifecycle.

C1-HOLDAPP

This algorithm creates a To Do based on the approval To Do type configured in the hold request type.

C1-HOLDAPRVD

This algorithm is invoked when you approve a hold request. It checks whether the number of entities is less than or equal to the defer processing count configured in the hold request type. If the number of entities is less than or equal to the defer processing count, status of the hold request is changed to **Active** else it is changed to **Deferred Processing**.

C1-HLDRESUBM

This algorithm is invoked when the approver clicks the **Re Submit** button and the status of the hold request is changed to **Return to Submitter**. This algorithm changes the status of the funding request to **Draft**. The submitter can then make the required changes and resubmit the hold request for approval. In addition, it creates a To Do using the submitter To Do type which is specified in the hold request type. Once a To Do is created, it is assigned to all the users with a submitter To Do role which is specified in the hold request type.

C1-HOLDACTV

This algorithm is invoked when the status of the hold request is changed to **Active**. It checks the following conditions:

- Whether the entity start date is greater than equal to the hold request start date
- Whether the entity end date is less than equal to the hold request start date
- Whether the hold amount for the **Bill** entity is not greater than the bill outstanding amount or the bill outstanding amount is not equal to zero

It not only updates the start date of the hold processes and hold entities to the system date but also the funding and garnishment amount for the funding purposes.

It contains the following parameter:

- **Alert Type** - Used to create alerts for the accounts which are displayed in the dashboard.

Note:

The alert type has a link. On clicking the link, the **Account** screen where you can view the alerts in the **Alerts** tab.

The start and end date of the alert type is updated based on the hold requests which are associated with the account.

Following scenarios are considered while maintaining the dates:

- If the hold entity end date is not specified, the system considers the hold process end date.
- If the hold process end date and the entity end date is not specified, the system considers the hold request end date.

This algorithm cancels the overdue processes which are in the **Active** status that belong to an account kept on hold through the hold request.

C1-RELENTITY

This algorithm is invoked when you release a hold request. It updates the following type of dates to the system date for all entities in the hold request.

- **Bill After Date** - Used for bill generation process
- **Postpone Credit Review Date** - Used for overdue process
- **Defer Auto Pay Date** - Used for auto pay process

It contains the following parameter:

- **Alert Type** - Used to create alerts for the accounts which are displayed in the dashboard.

Note:

The alert type has a link. On clicking the link, the **Account** screen where you can view the alerts in the **Alerts** tab.

The start and end date of the alert type is updated based on the hold requests which are associated with the account.

C1-RLSHOLD

This algorithm is invoked when you are releasing a hold request. It updates the following information:

- The hold request end date is changed to the system date.
- The hold process end date is changed to the system date.
- The hold entities end date is changed to the system date.
- The hold request status is changed to **Released** once the release reason is accepted by the approver.

Hold Request Type

Oracle Revenue Management and Billing allows you to define a hold request type using which you can create a hold request. It is the hold request type which helps the system to determine the following:

- The business object using which the hold request should be created in the system.
- Whether partial or complete amount should be kept on hold when a bill is added to the hold request.
- Whether approval is required for the hold request.
- The various types of processes for which you want to create a hold request.

The **Hold Request Type** screen allows you to define, edit, copy, and delete a hold request type. It contains the following zones:

- [Hold Request Type List](#) on page 1821
- [Hold Request Type](#) on page 1821

Hold Request Type List

The **Hold Request Type List** zone lists the hold request types that are already defined in the system. It contains the following columns:

Column Name	Column Description
Hold Request Type	Displays the hold request type.
Description	Displays the description of the hold request type.
Edit	On clicking the Edit (✎) icon, the Hold Request Type screen appears where you can edit the details of the hold request type.
Duplicate	On clicking the Duplicate (📄) icon, the Hold Request Type screen appears where you can define a hold request type using an existing hold request type.
Delete	On clicking the Delete (🗑) icon, you can delete the hold request type.
	Note: You can delete a hold request type when you have not created a hold request using the hold request type.

Note: Pagination is used to display limited number of records in this zone. You can use the navigation links, such as **Previous** and **Next** to navigate between pages.

On clicking the **Broadcast** (📡) icon corresponding to the hold request type, the **Hold Request Type** zone appears with the details of the respective hold request type.

Related Topics

For more information on...	See...
Hold Request Type zone	Hold Request Type on page 1821
How to edit a hold request type	Editing a Hold Request Type on page 1828
How to copy a hold request type	Copying a Hold Request Type on page 1832
How to delete a hold request type	Deleting a Hold Request Type on page 1832
How to view the details of a hold request type	Viewing the Hold Request Type Details on page 1836

Hold Request Type

The **Hold Request Type** zone displays the details of the hold request type. It contains the following sections:

- **Main** - This section provides basic information about the hold request type. It contains the following fields:

Field Name	Field Description
Hold Request Type	Displays the hold request type.
Description	Displays the description of the hold request type.

Field Name	Field Description
Hold Request Business Object	Indicates the business object using which the hold request should be created. In addition, a context menu appears corresponding to this field which helps in navigating to other screens in the application.
	Note: It has a link. On clicking the link, the Business Object screen appears where you can view the details of the respective business object.
Detailed Description	Displays additional information about the hold request type.
Status	Indicates the status of the hold request type. The valid values are: <ul style="list-style-type: none"> • Active • Inactive
Allow Partial Hold for Bill	Indicates whether partial amount is accepted for a bill in the hold request.
Defer Processing Count	Displays the count which helps to determine whether the hold request must be processed in the deferred mode (i.e. in the background) or in real time (i.e. immediately)
Approval Required	Indicates whether approval is required while creating the hold request using the hold request type.
Approval To Do Type	Indicates that To Do entry of the specified To Do type must be created when the hold request is submitted for approval.
	Note: It has a link. On clicking the link, the To Do Type screen appears with the details of the respective To Do type. This field appears when the Approval Required option is selected.
Approval To Do Role	Indicates that users with the specified To Do role can only approve the hold request which is submitted for approval.
	Note: It has a link. On clicking the link, the To Do Role screen appears where you can view the details of the respective To Do role. This field appears when the Approval Required option is selected.
Submitter To Do Type	Indicates the submitter To Do type. At present, the submitter To Do type is not used to create To Do entry when the approver rejects the hold request. It is only used to fetch the roles associated with the submitter To Do type while defining or editing the hold request type.
	Note: It has a link. On clicking the link, the To Do Type screen appears where you can view the details of the respective To Do type.

Field Name	Field Description
Submitter To Do Role	Indicates that users with the specified To Do role cannot approve the hold request which is submitted for approval. Note: It has a link. On clicking the link, the To Do Role screen appears where you can view the details of the respective To Do role.

- **Hold Processes** - List the processes defined for the hold request type. It contains the following column:

Column Description
Indicates the processes for which the hold request is created using the hold request type.

- **Characteristics** - Lists the characteristics defined for the hold request type. It contains the following columns:

Column Name	Column Description
Characteristic Type	Indicates the characteristic type.
Characteristic Value	Displays the value of the characteristic type.

- **Record Actions** - This section contains the following buttons:

Button Name	Button Description
Edit	Used to edit the details of the hold request type.
Delete	Used to delete the hold request type. Note: You can delete a hold request type when you have not created a hold request using the hold request type.
Duplicate	Used to create a new hold request type using an existing hold request type.

- **Record Information** - This section contains the following field:

Field Name	Field Description
Business Object	Indicates the business object using which the hold request type is created. In addition, a context menu appears corresponding to this field which helps in navigating to other screens in the application. Note: It has a link. On clicking the link, the Business Object screen appears where you can view the details of the respective business object.

By default, the **Hold Request Type** zone does not appear in the **Hold Request Type** screen. It appears when you click the **Broadcast** () icon corresponding to the hold request type in the **Hold Request Type List** zone.

Related Topics

For more information on...	See...
How to define a hold request type	Defining a Hold Request Type on page 1824
How to edit a hold request type	Editing a Hold Request Type on page 1828
How to copy a hold request type	Copying a Hold Request Type on page 1832
How to delete a hold request type	Deleting a Hold Request Type on page 1832

For more information on...	See...
How to view the details of a hold request type	Viewing the Hold Request Type Details on page 1836

Defining a Hold Request Type

Prerequisites

To define a hold request type, you should have:

- Hold request type business objects defined in the application
- Hold request business objects defined in the application
- Values defined for the **HOLD_PROCESS_FLG** lookup field.
- Characteristic type defined in the application (where the characteristic entity is set to **Hold Request**)
- Required To Do role assigned to the **C1-HLDAP** and **C1-HOLSB** To Do types in the application

Procedure

To define a hold request type:

1. Click the **Admin** link in the **Application** toolbar.
A list appears.
2. From the **Admin** menu, select **H** and then click **Hold Request Type**.
A sub-menu appears.
3. Click the **Add** option from the **Hold Request Type** sub-menu.

The **Hold Request Type** screen appears. It contains the following sections:

- **Main** - Used to specify basic details about the hold request type.
- **Hold Processes** - Used to define the processes for the hold request type.
- **Characteristics** - Used to define the characteristics for the hold request type.

The **Main** section contains the following fields:

Field Name	Field Description	Mandatory (Yes or No)
Hold Request Type	Used to specify the hold request type.	Yes
Business Object	Indicates the business object using which you are defining the hold request type.	Not applicable
Description	Used to specify the description for the hold request type.	Yes
Hold Request Business Object	Used to indicate the business object that you want to use while creating the hold request.	Yes
Detailed Description	Used to specify additional information about the hold request type.	No

Field Name	Field Description	Mandatory (Yes or No)
Status	<p>Used to indicate the status of the hold request type. The valid values are:</p> <ul style="list-style-type: none"> • Active • Inactive <p>Note: You cannot change the status of a hold request type to Inactive when the corresponding hold request is in the Draft or Approval In Progress status.</p>	Yes
Allow Partial Hold for Bill	Used to indicate whether partial amount is accepted for a bill in the hold request.	Yes
Defer Processing Count	<p>Used to specify the count which helps to determine whether the hold request must be processed in the deferred mode (i.e. in the background) or in real time (i.e. immediately)</p> <p>Note:</p> <p>If the number of records in a hold request does not exceed the Defer Processing Count, the system will process the hold request in real time (i.e. immediately).</p> <p>Defer processing count should be a numerical value without decimal points.</p> <p>Deferred mode means in the background when the Hold Request Periodic Monitor (C1-HLDRQ) batch is invoked. You can configure the Hold Request Periodic Monitor (C1-HLDRQ) batch such that it is executed at regular intervals. When the Hold Request Periodic Monitor (C1-HLDRQ) batch is invoked, the system checks whether there are any hold requests in the Deferred status. If there is a hold request in the Deferred Processing status, the system changes the status of the hold request to Active.</p>	No
Approval Required	Used to indicate whether approval is required while creating the hold request using hold request type.	No

Field Name	Field Description	Mandatory (Yes or No)
Approval To Do Type	Used to indicate that To Do entry of the specified To Do type must be created when you submit the hold request for approval.	Yes (Conditional)
	<p>Note:</p> <p>The Search (🔍) icon appears corresponding to this field. On clicking the Search icon, the To Do Type Search window appears.</p> <p>On specifying the value for a predefined To Do type, the description of the To Do type appears corresponding to the Approval To Do Type field.</p> <p>This field appears when the Approval Required option is selected.</p>	<p>Note: This field is required when the Approval Required option is selected</p>
Approval To Do Role	Used to indicate that users with the specified To Do role can only approve the hold request which is submitted for approval.	Yes (Conditional)
	<p>Note: This field appears when the Approval Required option is selected.</p>	<p>Note: This field is required when the Approval Required option is selected</p>
Submitter To Do Type	Used to indicate the submitter To Do type. At present, the submitter To Do type is not used to create To Do entry when the approver rejects the hold request. It is only used to fetch the roles associated with the submitter To Do type.	Yes (Conditional)
	<p>Note:</p> <p>The Search (🔍) icon appears corresponding to this field. On clicking the Search icon, the To Do Type Search window appears.</p> <p>On specifying the value for a predefined To Do type, the description of the To Do type appears corresponding to the Submitter To Do Type field.</p> <p>This field appears when the Approval Required option is selected.</p>	<p>Note: This field is required when the Approval Required option is selected</p>
Submitter To Do Role	Used to indicate that users with the specified To Do role cannot approve the hold request which is submitted for approval.	Yes (Conditional)
	<p>Note:</p> <p>This field appears when the Approval Required option is selected.</p> <p>The list includes only those To Do roles which are associated with the submitter To Do type.</p>	<p>Note: This field is required when the Approval Required option is selected</p>

4. Enter the required details in the **Main** section.

- Define the hold processes for the hold request type.

Note: You must define at least one hold process for the hold request type.

- Define characteristics for the hold request type, if required.
- Click **Save**.

The hold request type is defined.

Related Topics

For more information on...	See...
Hold Request Type screen	Hold Request Type on page 1820
How to define a hold process for a hold request type	Defining Hold Process for a Hold Request Type on page 1827
How to define a characteristic for a hold request type	Defining a Characteristic for a Hold Request Type on page 1827

Defining Hold Process for a Hold Request Type

Prerequisites

To define hold process for a hold request type, you should have:

- Values defined for the **HOLD_PROCESS_FLG** lookup field.

Procedure

To define hold process for a hold request type:

- Ensure that the **Hold Processes** section is expanded when you are defining, editing, or copying a hold request type.
- Select the required hold process from the **Hold Processes** list.
- If you want to define more than one hold process for the hold request type, click the **Add (+)** icon and then repeat step 2.

Note:

You cannot add the same hold process more than once in the hold request type.

However, if you want to remove a hold process from the hold request type, click the **Delete** (🗑️) icon corresponding to the characteristic.

Related Topics

For more information on...	See...
How to define a hold request type	Defining a Hold Request Type on page 1824
How to edit a hold request type	Editing a Hold Request Type on page 1828
How to copy a hold request type	Copying a Hold Request Type on page 1832

Defining a Characteristic for a Hold Request Type

Prerequisites

To define a characteristic for a hold request type, you should have:

- Characteristic types defined in the application (where the characteristic entity is set to **Hold Request Type**)

Procedure

To define a characteristic for a hold request type:

1. Ensure that the **Characteristics** section is expanded when you are defining, editing, or copying a hold request type.

The **Characteristics** section contains the following fields:

Field Name	Field Description	Mandatory (Yes or No)
Characteristic Type	Used to indicate the characteristic type.	Yes (Conditional)
	Note: The list includes only those characteristic types where the characteristic entity is set to Hold Request Type .	Note: This field is required when you are defining a characteristic for the hold request type.
Characteristic Value	Used to specify the value for the characteristic type.	Yes (Conditional)
	Note: If you select a predefined characteristic type, the Search (🔍) icon appears corresponding to the Characteristic Value field. On clicking the Search icon, the Predefined Characteristic Search window appears. On specifying the value for a predefined characteristic type, the description of the characteristic value appears corresponding to the Characteristic Value field.	Note: This field is required when you are defining a characteristic for the hold request type.

2. Enter the required details in the **Characteristics** section.
3. If you want to define more than one characteristic for the hold request type, click the **Add** (+) icon and then repeat step 2.

Note: However, if you want to remove a characteristic from the hold request type, click the **Delete** (🗑️) icon corresponding to the characteristic.

Related Topics

For more information on...	See...
How to define a hold request type	Defining a Hold Request Type on page 1824
How to edit a hold request type	Editing a Hold Request Type on page 1828
How to copy a hold request type	Copying a Hold Request Type on page 1832

Editing a Hold Request Type

Prerequisites

To edit a hold request type, you should have:

- Hold request business objects defined in the application

- Approval profiles defined in the application

Procedure

To edit a hold request type:

1. Click the **Admin** link in the **Application** toolbar.

A list appears.

2. From the **Admin** menu, select **H** and then click **Hold Request Type**.

A sub-menu appears.

3. Click the **Search** option from the **Hold Request Type** sub-menu.

The **Hold Request Type** screen appears.

4. In the **Hold Request Type List** zone, click the **Edit**  icon in the **Edit** column corresponding to the hold request type whose details you want to edit.

The **Hold Request Type** screen appears. It contains the following sections:

- **Main** - Used to specify basic details about the hold request type.
- **Hold Processes** - Used to define the processes for the hold request type.
- **Characteristics** - Used to define the characteristics for the hold request type.

The **Main** section contains the following fields:

Field Name	Field Description	Mandatory (Yes or No)
Hold Request Type	Displays the hold request type.	Not applicable
Business Object	Indicates the hold request type business object used while defining the hold request type.	Not applicable
Description	Used to specify the description for the hold request type.	Yes
Hold Request Business Object	Used to indicate the business object using which you want to create the respective hold request.	Yes
Detailed Description	Used to specify additional information about the hold request type.	No
Status	Used to indicate the status of the hold request type. The valid values are: <ul style="list-style-type: none"> • Active • Inactive <div style="border: 1px solid black; padding: 2px; margin-top: 5px;"> Note: You cannot change the status of a hold request type to Inactive when the corresponding hold request is in the Draft or Approval In Progress status. </div>	Yes
Allow Partial Hold for Bill	Used to indicate whether partial amount is accepted for a bill in the hold request.	Yes

Field Name	Field Description	Mandatory (Yes or No)
Defer Processing Count	<p>Used to specify the count which helps to determine whether the hold request must be processed in the deferred mode (i.e. in the background) or in real time (i.e. immediately)</p> <p>Note:</p> <p>If the number of records in a hold request does not exceed the Defer Processing Count, the system will process the hold request in real time (i.e. immediately).</p> <p>Defer processing count should be a numerical value without decimal points.</p> <p>Deferred mode means in the background when the Hold Request Periodic Monitor (C1-HLDRQ) batch is invoked. You can configure the Hold Request Periodic Monitor (C1-HLDRQ) batch such that it is executed at regular intervals. When the Hold Request Periodic Monitor (C1-HLDRQ) batch is invoked, the system checks whether there are any hold requests in the Deferred status. If there is a hold request in the Deferred Processing status, the system changes the status of the hold request to Active.</p>	No
Approval Required	Used to indicate whether approval is required while creating the hold request using hold request type.	No
Approval To Do Type	<p>Used to indicate that To Do entry of the specified To Do type must be created when you submit the hold request for approval.</p> <p>Note:</p> <p>The Search (🔍) icon appears corresponding to this field. On clicking the Search icon, the To Do Type Search window appears.</p> <p>On specifying the value for a predefined To Do type, the description of the To Do type appears corresponding to the Approval To Do Type field.</p> <p>This field appears when the Approval Required option is selected.</p>	<p>Yes (Conditional)</p> <p>Note: This field is required when the Approval Required option is selected</p>
Approval To Do Role	<p>Used to indicate that users with the specified To Do role can only approve the hold request which is submitted for approval.</p> <p>Note: This field appears when the Approval Required option is selected.</p>	<p>Yes (Conditional)</p> <p>Note: This field is required when the Approval Required option is selected</p>

Field Name	Field Description	Mandatory (Yes or No)
Submitter To Do Type	Used to indicate the submitter To Do type. At present, the submitter To Do type is not used to create To Do entry when the approver rejects the hold request. It is only used to fetch the roles associated with the submitter To Do type.	Yes (Conditional)
	<p>Note:</p> <p>The Search (🔍) icon appears corresponding to this field. On clicking the Search icon, the To Do Type Search window appears.</p> <p>On specifying the value for a predefined To Do type, the description of the To Do type appears corresponding to the Submitter To Do Type field.</p> <p>This field appears when the Approval Required option is selected.</p>	<p>Note: This field is required when the Approval Required option is selected</p>
Submitter To Do Role	Used to indicate that users with the specified To Do role cannot approve the hold request which is submitted for approval.	Yes (Conditional)
	<p>Note:</p> <p>This field appears when the Approval Required option is selected.</p> <p>The list includes only those To Do roles which are associated with the submitter To Do type.</p>	<p>Note: This field is required when the Approval Required option is selected</p>

Tip: Alternatively, you can access this screen by clicking the **Edit** button in the **Hold Request Type** zone.

- Modify the required details in the **Main** section.
- Define, edit, or remove hold processes of the hold request type, if required.

Note: You must define at least one hold process for the hold request type.

- Define, edit, or remove characteristics of the hold request type, if required.
- Click **Save**.

The changes made to the hold request type are saved.

Related Topics

For more information on...	See...
Hold Request Type screen	Hold Request Type on page 1820
Hold Request Type List zone	Hold Request Type List on page 1821
Hold Request Type zone	Hold Request Type on page 1821
How to define a hold process for a hold request type	Defining Hold Process for a Hold Request Type on page 1827
How to define a characteristic for a hold request type	Defining a Characteristic for a Hold Request Type on page 1827

Deleting a Hold Request Type

Procedure

To delete a hold request type:

1. Click the **Admin** link in the **Application** toolbar.
A list appears.
2. From the **Admin** menu, select **H** and then click **Hold Request Type**.
A sub-menu appears.
3. Click the **Search** option from the **Hold Request Type** sub-menu.
The **Hold Request Type** screen appears.
4. In the **Hold Request Type List** zone, click the **Delete** (🗑️) icon in the **Delete** column corresponding to the hold request type that you want to delete.
A message appears confirming whether you want to delete the hold request type.

Note: You can delete a hold request type when you have not created a hold request using the hold request type.

Tip: Alternatively, you can delete a hold request type by clicking the **Delete** button in the **Hold Request Type** zone.

5. Click **OK**.
The hold request type is deleted.

Related Topics

For more information on...	See...
Hold Request Type screen	Hold Request Type on page 1820
Hold Request Type List zone	Hold Request Type List on page 1821
Hold Request Type zone	Hold Request Type on page 1821

Copying a Hold Request Type

Instead of creating a hold request type from scratch, you can create a new hold request type using an existing hold request type. This is possible through copying a hold request type. On copying a hold request type, the details including the hold processes and characteristics are copied to the new hold request type. You can then edit the details, if required.

Prerequisites

To copy a hold request type, you should have:

- Hold request type (whose copy you want to create) defined in the application
- Hold request business objects defined in the application
- Approval profiles defined in the application
- Values defined for the **HOLD_PROCESS_FLG** lookup field.
- Characteristic type defined in the application (where the characteristic entity is set to **Hold Request**)
- Required To Do role assigned to the **C1-HLDAP** and **C1-HOLSB** To Do types in the application

Procedure

To copy a hold request type:

1. Click the **Admin** link in the **Application** toolbar.
A list appears.
2. From the **Admin** menu, select **H** and then click **Hold Request Type**.
A sub-menu appears.
3. Click the **Search** option from the **Hold Request Type** sub-menu.
The **Hold Request Type** screen appears.
4. In the **Hold Request Type List** zone, click the **Duplicate** () icon in the **Duplicate** column corresponding to the hold request type whose copy you want to create.

The **Hold Request Type** screen appears. It contains the following sections:

- **Main** - Used to specify basic details about the hold request type.
- **Hold Processes** - Used to define the processes for the hold request type.
- **Characteristics** - Used to define the characteristics for the hold request type.

The **Main** section contains the following fields:

Field Name	Field Description	Mandatory (Yes or No)
Hold Request Type	Used to specify the hold request type.	Yes
Business Object	Indicates the business object using which you are defining the hold request type.	Not applicable
Description	Used to specify the description for the hold request type.	Yes
Hold Request Business Object	Used to indicate the business object that you want to use while creating the hold request.	Yes
Detailed Description	Used to specify additional information about the hold request type.	No
Status	Used to indicate the status of the hold request type. The valid values are: <ul style="list-style-type: none"> • Active • Inactive 	Yes
	Note: You cannot change the status of a hold request type to Inactive when the corresponding hold request is in the Draft or Approval In Progress status.	
Allow Partial Hold for Bill	Used to indicate whether partial amount is accepted for a bill in the hold request.	Yes

Field Name	Field Description	Mandatory (Yes or No)
Defer Processing Count	<p>Used to specify the count which helps to determine whether the hold request must be processed in the deferred mode (i.e. in the background) or in real time (i.e. immediately)</p> <p>Note:</p> <p>If the number of records in a hold request does not exceed the Defer Processing Count, the system will process the hold request in real time (i.e. immediately).</p> <p>Defer processing count should be a numerical value without decimal points.</p> <p>Deferred mode means in the background when the Hold Request Periodic Monitor (C1-HLDRQ) batch is invoked. You can configure the Hold Request Periodic Monitor (C1-HLDRQ) batch such that it is executed at regular intervals. When the Hold Request Periodic Monitor (C1-HLDRQ) batch is invoked, the system checks whether there are any hold requests in the Deferred status. If there is a hold request in the Deferred Processing status, the system changes the status of the hold request to Active.</p>	No
Approval Required	Used to indicate whether approval is required while creating the hold request using hold request type.	No
Approval To Do Type	<p>Used to indicate that To Do entry of the specified To Do type must be created when you submit the hold request for approval.</p> <p>Note:</p> <p>The Search (🔍) icon appears corresponding to this field. On clicking the Search icon, the To Do Type Search window appears.</p> <p>On specifying the value for a predefined To Do type, the description of the To Do type appears corresponding to the Approval To Do Type field.</p> <p>This field appears when the Approval Required option is selected.</p>	<p>Yes (Conditional)</p> <p>Note: This field is required when the Approval Required option is selected</p>
Approval To Do Role	<p>Used to indicate that users with the specified To Do role can only approve the hold request which is submitted for approval.</p> <p>Note: This field appears when the Approval Required option is selected.</p>	<p>Yes (Conditional)</p> <p>Note: This field is required when the Approval Required option is selected</p>

Field Name	Field Description	Mandatory (Yes or No)
Submitter To Do Type	Used to indicate the submitter To Do type. At present, the submitter To Do type is not used to create To Do entry when the approver rejects the hold request. It is only used to fetch the roles associated with the submitter To Do type.	Yes (Conditional) Note: This field is required when the Approval Required option is selected
	<p>Note:</p> <p>The Search (🔍) icon appears corresponding to this field. On clicking the Search icon, the To Do Type Search window appears.</p> <p>On specifying the value for a predefined To Do type, the description of the To Do type appears corresponding to the Submitter To Do Type field.</p> <p>This field appears when the Approval Required option is selected.</p>	
Submitter To Do Role	Used to indicate that users with the specified To Do role cannot approve the hold request which is submitted for approval.	Yes (Conditional) Note: This field is required when the Approval Required option is selected
	<p>Note:</p> <p>This field appears when the Approval Required option is selected.</p> <p>The list includes only those To Do roles which are associated with the submitter To Do type.</p>	

Tip: Alternatively, you can access this screen by clicking the **Duplicate** button in the **Hold Request Type** zone.

5. Enter the required details in the **Main** section.
6. Define the hold processes for the hold request type.

Note: You must define at least one hold process for the hold request type.

7. Define characteristics for the hold request type, if required.
8. Click **Save**.

The new hold request type is defined.

Related Topics

For more information on...	See...
Hold Request Type screen	Hold Request Type on page 1820
Hold Request Type List zone	Hold Request Type List on page 1821
Hold Request Type zone	Hold Request Type on page 1821
How to define a hold process for a hold request type	Defining Hold Process for a Hold Request Type on page 1827

For more information on...	See...
How to define a characteristic for a hold request type	Defining a Characteristic for a Hold Request Type on page 1827

Viewing the Hold Request Type Details

Procedure

To view the details of a hold request type:

1. Click the **Admin** link in the **Application** toolbar.
A list appears.
2. From the **Admin** menu, select **H** and then click **Hold Request Type**.
A sub-menu appears.
3. Click the **Search** option from the **Hold Request Type** sub-menu.
The **Hold Request Type** screen appears.
4. In the **Hold Request Type List** zone, click the **Broadcast** () icon corresponding to the hold request type whose details you want to view.
The **Hold Request Type** zone appears.
5. View the details of the hold request type in the **Hold Request Type** zone.

Related Topics

For more information on...	See...
Hold Request Type screen	Hold Request Type on page 1820
Hold Request Type List zone	Hold Request Type List on page 1821
Hold Request Type zone	Hold Request Type on page 1821

Hold Request (Used for Searching)

The **Hold Request** screen allows you to search for a hold request using various search criteria. It also allows you to define a hold request. It contains the following zone:

- [Search Hold Request](#) on page 1836

Through this screen, you can navigate to the following screen

- [Hold Request \(Used for Viewing\)](#) on page 1847

Search Hold Request

The **Search Hold Request** zone allows you to search for hold requests using various search criteria. This zone contains the following two sections:

- **Search Criteria** - The **Search Criteria** section contains the following fields:

Field Name	Field Description	Mandatory (Yes or No)
Search By	Used to indicate whether you want to search for a hold request using the request or bill details. The valid values are: <ul style="list-style-type: none"> Request Details Bill Details 	Yes
	Note: By default, the Request Details option is selected.	
Hold Request Type	Used to search hold requests which are created using a particular hold request type.	No
	Note: This field appears when you select the Request Details option from the Search By list.	
Entity	Used to search hold request with a particular entity. The valid values are: <ul style="list-style-type: none"> Account Person Bill 	No
	Note: This field appears when you select the Request Details option from the Search By list.	
Hold Process	Used to search hold requests which are created using a particular hold process.	No
	Note: This field appears when you select the Request Details option from the Search By list.	
User ID	Used to search hold requests which are created by a particular user.	
	Note: This field appears when you select the Request Details option from the Search By list.	
Hold Reason	Used to search hold requests which are created using a particular hold reason.	No
	Note: This field appears when you select the Request Details option from the Search By list.	
Start Date	Used to search hold requests which are created from a particular date onwards.	No
	Note: This field appears when you select the Request Details option from the Search By list.	

Field Name	Field Description	Mandatory (Yes or No)
Status	Used to search hold requests with a particular status. The valid values are: <ul style="list-style-type: none"> • Active • Draft • Released • Approval In Progress • Deferred Processing • Rejected 	No
	Note: This field appears when you select the Request Details option from the Search By list.	
End Date	Used to search hold requests which are created till a particular date.	No
	Note: This field appears when you select the Request Details option from the Search By list.	
Account ID	Used to search hold requests which are created for a particular account.	No
	Note: This field appears when you select the Request Details option from the Search By list. You can search for an account by clicking the Search (🔍) icon corresponding to the field.	
Hold Request ID	Used to search a particular hold request.	No
	Note: This field appears when you select the Request Details option from the Search By list.	
Person ID	Used to search hold requests which are created for a particular person.	No
	Note: This field appears when you select the Request Details option from the Search By list. You can search for a person by clicking the Search (🔍) icon corresponding to the field.	

Field Name	Field Description	Mandatory (Yes or No)
Bill ID	Used to search hold requests which includes bill segments or adjustments of a particular bill.	No
	<p>Note:</p> <p>This field appears only when you select the Bill Details option from the Search By list.</p> <p>You can search for a bill by clicking the Search (🔍) icon corresponding to the field.</p>	
Bill Date From	Used to search hold requests which includes bill segments or adjustments of bills which are created from a particular date onwards.	No
	<p>Note: This field appears when you select the Bill Details option from the Search By list.</p>	
To	Used to search hold requests which includes bill segments or adjustments of bills which are created till a particular date.	No
	<p>Note: This field appears when you select the Bill Details option from the Search By list.</p>	

Note: You must specify at least one search criterion while searching for a hold request.

- **Search Results** - On clicking the **Search** button, the search results appear based on the specified search criteria. The **Search Results** section contains the following columns:

Column Name	Column Description
Create Date/Time	Displays the date and time when the hold request is created.
Hold Request Information	Displays information about the hold request.
	<p>Note: It has a link. On clicking the link, the Hold Request screen appears where you can view the details of the respective hold request.</p>
Status	<p>Indicates the status of the hold request. The valid values are:</p> <ul style="list-style-type: none"> • Active • Draft • Released • Approval In Progress • Deferred Processing • Rejected
Start Date	Displays the date when the hold request is created.
End Date	Displays the date when the hold request is released.
Hold Processes	Displays the hold processes using which hold request is created.
Hold Reason	Displays the hold reason for the hold request.

Column Name	Column Description
Created By	Indicates the user who has created the hold request.

Note: Pagination is used to display limited number of records in the **Search Results** section. You can use the navigation links, such as **Previous** and **Next** to navigate between pages.

Related Topics

For more information on...	See...
How to search for a hold request	Searching for a Hold Request on page 1840
How to view the details of a hold request	Viewing the Hold Request Details on page 1846
How to create a hold request	Creating a Hold Request on page 1841

Searching for a Hold Request

Prerequisites

To search for a hold request, you should have:

- Hold request types defined in the application

Procedure

To search for a hold request:

1. Click the **Menu** link in the **Application** toolbar.
A list appears.
2. From the **Main** menu, select **Accounting and Receivable** and then click **Hold Request**.
A sub-menu appears.
3. Click the **Search** option from the **Hold Request** sub-menu.
The **Hold Request** screen appears.
4. Enter the search criteria in the **Search Hold Request** zone.

Note: ORMB search engine supports wildcard search, where you can substitute the percentage (%) symbol as a stand in for any word or letter in a search criteria. You can use the ‘%’ wildcard character in all input fields except the date and ID fields. The ‘%’ wildcard character is suffixed automatically at the end of the partial search criteria. Therefore, you may or may not specify the wildcard character at the end of the partial search criteria. However, you have to prefix the wildcard character manually wherever required.

5. Click **Search**.

A list of hold requests that meet the search criteria appears in the **Search Results** section.

Related Topics

For more information on...	See...
Hold Request screen	Hold Request (Used for Searching) on page 1836
Search Hold Request zone	Search Hold Request on page 1836

Creating a Hold Request

Prerequisites

To create a hold request, you should have:

- Hold request types defined in the application.
- Hold request reasons defined in the application.
- Hold request entities defined in the application.
- Hold request processes defined in the application.

Procedure

To create a hold request:

1. Do either of the following:

If you want to...	Then...
Define a hold request from the Account Receivable Central screen	<ol style="list-style-type: none"> 1. Click the Menu link in the Application toolbar. A list appears. 2. From the Main menu, select Accounting and Receivable and then click Account Receivable Central. The Account Receivable Central screen appears. 3. Search for the bill in the Account Receivable Central screen. 4. In the Search Results section, select the required bill and then click Hold button. <div style="background-color: #f2f2f2; padding: 5px; margin-top: 10px;"> <p>Note: Bills are selected to be on hold from Account Receivable Central. Only one bill at a time is allowed to select for Hold Request from Account Receivable Central</p> </div>
Define a hold request from the Delinquency Central screen	<ol style="list-style-type: none"> 1. Click the Menu link in the Application toolbar. A list appears. 2. From the Main menu, select Delinquency Management and then click Delinquency Central. The Delinquency Central screen appears. 3. Search for the overdue process in the Delinquency Central screen. 4. In the Search Results section, select the required overdue process and then click Create Hold Request button.

If you want to...	Then...
	<p>Note:</p> <p>Accounts are selected to be on hold from Delinquency Central screen</p> <p>Only one account at a time is allowed to select for Hold Request from Delinquency Central screen.</p>
Define a hold request from the Hold Request screen	<ol style="list-style-type: none"> 1. Click the Menu link in the Application toolbar. A list appears. 2. From the Main menu, select Accounting and Receivable and then click Hold Request. A sub-menu appears. 3. Click the Add option from the Hold Request sub-menu.

The **Add Hold Request** screen appears. It contains the following fields:

Field Name	Field Description	Mandatory (Yes or No)
Hold Request Type	Used to indicate the request type using which you want to create the hold request.	Yes

Tip: Alternatively, you can access the **Add Hold Request** screen by clicking the **Add** button in the **Page Title** area of the **Hold Request** screen.

2. Select the required hold request type from the respective field.
3. Click **OK**.

The **Hold Request** screen appears. It contains the following sections:

- **Main** – Used to specify basic details about the hold request. This section contains the following fields:

Field Name	Field Description	Mandatory (Yes or No)
Hold Request Type	Indicates the hold request type using which you want to create the hold request.	Not applicable
Start Date	Used to specify the date from when the hold request is effective.	Yes
	<p>Note:</p> <p>The hold request start date cannot be later than the hold request end date.</p> <p>By default, system date appears in this field.</p>	
End Date	Used to specify the date till when the hold request is effective.	Yes
	<p>Note: The hold request end date cannot be earlier than the hold request start date.</p>	

Field Name	Field Description	Mandatory (Yes or No)										
Hold Reason	Used to indicate the reason why you want to hold the entity.	Yes										
Entity	<p>Used to indicate the type of the entity for which you want to create the hold request. The valid values are:</p> <ul style="list-style-type: none"> Account Bill Person <p>Note:</p> <table border="1"> <thead> <tr> <th>If...</th> <th>Then</th> </tr> </thead> <tbody> <tr> <td>You are creating the hold request for an Account entity</td> <td>You can add the Auto Pay, Bill Generation, Funding, and Overdue process in the hold request.</td> </tr> <tr> <td>You are creating the hold request for a Bill entity</td> <td>You can only add the Funding process in the hold request.</td> </tr> <tr> <td>You are creating the hold request for a Person entity</td> <td>You can only add the Bill Generation and Funding process in the hold request.</td> </tr> <tr> <td>You add a bill to the hold request from the Account Receivable Central screen</td> <td>The system displays Bill as an entity and the Hold Entities section displays additional information about the bill.</td> </tr> </tbody> </table>	If...	Then	You are creating the hold request for an Account entity	You can add the Auto Pay, Bill Generation, Funding, and Overdue process in the hold request.	You are creating the hold request for a Bill entity	You can only add the Funding process in the hold request.	You are creating the hold request for a Person entity	You can only add the Bill Generation and Funding process in the hold request.	You add a bill to the hold request from the Account Receivable Central screen	The system displays Bill as an entity and the Hold Entities section displays additional information about the bill.	Yes
If...	Then											
You are creating the hold request for an Account entity	You can add the Auto Pay, Bill Generation, Funding, and Overdue process in the hold request.											
You are creating the hold request for a Bill entity	You can only add the Funding process in the hold request.											
You are creating the hold request for a Person entity	You can only add the Bill Generation and Funding process in the hold request.											
You add a bill to the hold request from the Account Receivable Central screen	The system displays Bill as an entity and the Hold Entities section displays additional information about the bill.											
Comments	Used to specify additional information about the hold request.	No										

- Enter the required details in the **Hold Request** screen.
- Define entities for the hold request.
- Define processes for the hold request.
- Define characteristics for the hold request, if required.
- Click **Save**.

The hold request is created in the **Draft** status.

Note: It is recommended that user should set the **C1-HLMON** batch every time the hold request is generated. Otherwise, alert would be shown in the dashboard which may not give the proper representation of the hold requests that are in the **Active** status.

Related Topics

For more information on...	See...
Hold Request screen	Hold Request (Used for Searching) on page 1836

For more information on...	See...
How to define an entity for a hold request	Adding an Entity in a Hold Request on page 1844
How to define a process for a hold request	Adding a Process in a Hold Request on page 1845
How to define a characteristic for a hold request	Defining a Characteristic for a Hold Request on page 1864

Adding an Entity in a Hold Request

Prerequisites

To add an entity in a hold request, you should have:

- Values defined for the **HOLD_ENTITY_LVL_FLG** lookup field.

Procedure

To add an entity in a hold request:

1. Ensure that the **Hold Entities** section is expanded when you are defining or editing the hold request.

The **Hold Entities** section contains the following columns in a grid:

Field Name	Field Description	Mandatory (Yes or No)
Hold Entity ID	Used to specify the hold entity ID. Note: You can search for an entity ID by clicking the search (🔍) icon corresponding to the field <ul style="list-style-type: none"> • If the hold entity is selected as an account, you must specify the account ID in this field. • If the hold entity is selected as bill, you must specify the bill ID in this field. • If the hold entity is selected as person, you must specify the person ID in this field 	Yes
Start Date	Used to specify the date from when you want to hold the entity. Note: By default, system date appears in this field The hold entity start date must be between the hold request start and end dates and between at least one process's start and end dates. The hold entity start date cannot be later than the hold entity end date.	Yes

Field Name	Field Description	Mandatory (Yes or No)
End Date	Used to specify the date till when you want to hold the entity.	No
	Note: The hold entity end date must be between hold request start and end dates and between the process's start and end dates. The hold entity end date cannot be earlier than the hold entity start date.	
Hold Amount	Displays the amount which is kept on hold.	Not applicable
	Note: This column appears when the hold entity is Bill .	
Hierarchy	Used to associate the hold entity with the entity hierarchy relationship.	No
	Note: This field appears only when you select the Person option from the Entity list.	

- Enter the required details in the **Hold Entities** section.
- If you want to define more than one entity for the hold request, click the **Add (+)** icon and then repeat step 2.

Note: However, if you want to remove an entity from the hold request, click the **Delete (🗑)** icon corresponding to the hold entity.

Related Topics

For more information on...	See...
How to search for a hold request	Searching for a Hold Request on page 1840
How to create a hold request	Creating a Hold Request on page 1841

Adding a Process in a Hold Request

Prerequisites

To add a process in a hold request, you should have:

- Values defined for the **HOLD_PROCESS_FLG** lookup field.

Procedure

To add a process in a hold request:

- Ensure that the **Hold Process** section is expanded when you are defining or editing the hold request.

The **Hold Process** section contains the following columns in a grid:

Field Name	Field Description	Mandatory (Yes or No)
Hold Process	Used to indicate the process which you want to keep on hold.	Yes
	Note: This list includes only those processes which are defined in the hold request type.	
Start Date	Used to specify the date from when the process is kept on hold.	Yes
	Note: By default, system date appears in this field The hold process start date cannot be later than the hold process end date The hold process start date must be between the hold request start and end dates	
End Date	Used to specify the date till when the process is kept on hold.	No
	Note: The hold process end date cannot be earlier than the hold process start date The hold process end date must be between the hold request start and end dates	

2. Enter the required details in the **Hold Processes** section.
3. If you want to define more than one process for the hold request, click the **Add (+)** icon and then repeat step 2.

Note: However, if you want to remove a process from the hold request, click the **Delete** (🗑️) icon corresponding to the hold process.

Related Topics

For more information on...	See...
How to search for a hold request	Searching for a Hold Request on page 1840
How to create a hold request	Creating a Hold Request on page 1841

Viewing the Hold Request Details

Procedure

To view the details of a hold request:

1. Search for the hold request in the **Hold Request** screen.
2. In the **Search Results** section, click the link in the **Hold Request Information** column corresponding to the hold request whose details you want to view.
3. Ensure that the **Main** tab is selected.

- View the details of the hold request in the **Hold Request** zone.

Related Topics

For more information on...	See...
How to search for a hold request	Searching for a Hold Request on page 1840
Hold Request screen	Hold Request (Used for Searching) on page 1836
Hold Request zone	Hold Request on page 1848

Hold Request (Used for Viewing)

Once you create a hold request, the **Hold Request** screen allows you to:

- View the details of a hold request
- Add entities and processes in a hold request
- View the details of the entities and processes added in a hold request
- Search for an account, bill, and person in a hold request
- Define, edit, or remove the characteristics from the hold request
- Edit the details of a hold request
- Edit the hold amount of an entity where the entity is a bill
- Delete a hold request
- Submit a hold request for approval
- Approve or reject a hold request
- Resubmit a hold request for approval
- Activate and release a hold request
- Edit the end dates of all the entities in a hold request
- Delete all the entities in a hold request
- View the log of a hold request
- Add a log entry for a hold request

It consists of the following tabs:

- [Hold Request - Main](#) on page 1847
- [Hold Request - Log](#) on page 1859

Hold Request - Main

The **Main** tab on the **Hold Request** contains the following zones:

- [Hold Request](#) on page 1848
- [Hold Entities](#) on page 1850
- [Search Account](#) on page 1851

Note: This zone appears when the hold request for an **Account** is in the **Draft** status.

- [Search Bill](#) on page 1855

Note: This zone appears when hold request for a **Bill** is in the **Draft** status.

- [Search Person](#) on page 1857

Note: This zone appears when hold request is for a **Person** is in the **Draft** status.

Hold Request

The **Hold Request** zone displays the details of the hold request. This zone contains the following sections:

- **Main** - This section provides basic information about the hold request. It contains the following fields:

Field Name	Field Description
Hold Request Information	Displays information about the hold request.
Hold Request Type	Indicates the hold request type using which the hold request is created. Note: It has a link. On clicking the link, the Hold Request Type screen appears where you can view the details of the hold request type.
Status	Indicates the status of the hold request.
Status Reason	Indicates the reason why the hold request is rejected or released. Note: This field appears when the hold request is in Rejected or Released status. It has a link. On clicking the link, the Status Reason screen appears where you can view the details of the respective status reason.
Start Date	Displays the date from when the hold request is effective.
End Date	Displays the date till when the hold request is effective.
Hold Reason	Indicates the reason for creating the hold request.
Entity	Indicates the entity for which the hold request is created.
Comments	Displays additional information about the hold request. Note: This field appears if comments are provided while defining or editing a hold request.

- **Hold Processes** - Lists the processes which are kept on hold in the hold request. It contains the following columns:

Column Name	Column Description
Hold Process	Indicates the process which is kept on hold.
Start Date	Displays the date from when the hold process is effective.
End Date	Displays the date till when the hold process is effective.

- **Record Actions** - This section contains the following buttons:

Button Name	Button Description
Edit	Used to edit the details of the hold request.
	Note: The Edit button appears when the hold request is in the Draft or Active status.
Delete	Used to delete the hold request.
	Note: The Delete button appears when the hold request is in the Draft status.
Submit	Used to activate the hold request.
	Note: The Submit button appears when the hold request is in the Draft status.
Re Submit	Used to re-submit the hold request.
	Note: The Re Submit button appears when the hold request is in the Approval In Progress status.
Approve	Used to approve the hold request.
	Note: The Approve button appears when the hold request is in the Approval In Progress status.
Reject	Used to reject the hold request.
	Note: The Reject button appears when the hold request is in the Approval In Progress status.
Release	Used to release the hold request.
	Note: The Release button appears when the hold request is in the Active status.

- **Record Information** - This section contains the following fields:

Field Name	Field Description
Business Object	Indicates the business object using which the hold request is created. In addition, a context menu appears corresponding to this field which helps in navigating to other screens in the application.
	Note: It has a link. On clicking the link, the Business Object screen appears where you can view the details of the respective business object.
Status Date/Time	Displays the date and time when the hold request status is updated.
Create Date/Time	Displays the date and time when the hold request is created.

- **Characteristics** - Lists the characteristics defined for the hold request. It contains the following columns:

Column Name	Column Description
Effective Date	Indicates the date from when the characteristic is effective.
Characteristic Type	Indicates the characteristic type.

Column Name	Column Description
Characteristic Value	Displays the value of the characteristic type.

Hold Entities

The **Hold Entities** zone lists the entities which are added to the hold request. It contains the following columns:

Column Name	Column Description
Person Information	Indicates information about the person who is added to the hold request. In addition, this column has a context menu which helps in navigating to other screens in the application.
	Note: It has a link. On clicking the link, the Person screen appears where you can view the details of the respective person.
Account Information	Indicates information about the account which is added to the hold request. In addition, this column has a context menu which helps in navigating to other screens in the application.
	Note: It has a link. On clicking the link, the Account screen appears where you can view the details of the respective account.
Bill Information	Indicates information about the bill which is added to the hold request. In addition, this column has a context menu which helps in navigating to other screens in the application.
	Note: It has a link. On clicking the link, the Bill screen appears where you can view the details of the respective bill.
Entity ID	Indicates the entity for which the hold request is created.
Start Date	Displays the date from when the entity is effective for the hold request.
End Date	Displays the date till when the entity is effective for the hold request.
	Note: When the status of the hold request is changed to released, the system updates the end date with the date when the hold request is released, ensuring that the new date resides within the start and end date of the hold request.
Hold Amount	Displays the amount of the bill which is kept on hold through a hold request.
	Note: The data in this column appears only when Bill is defined as hold entity.
Bill After Date	Displays the date after which the bill can be generated.
	Note: The data in this column appears only when Account is defined as hold entity.
Postpone Credit Review Until	Displays the date till when the overdue process remains on hold.
	Note: The data in this column appears only when Account is defined as hold entity.
Defer Auto Pay Date	Displays the date till when the auto pay process remains on hold.
	Note: The data in this column appears only when the hold request is in the Active status, where the hold entity is defined as account and the hold process is auto pay.

Column Name	Column Description
Hierarchy	Indicates whether the entity is associated with the entity hierarchy relationship.
	Note: The data in this column appears only when the person is defined as an entity.

In addition to above columns, this screen contains following buttons:

Button Name	Button Description
Edit	Used to edit the end date of hold entities.
Delete	Used to delete the hold entities.

Note:

To update the start and end date of a hold entity, select the check box corresponding to the hold entity and click the **Edit** button. You can also select multiple hold entities at the same time. In addition, you can select the check box corresponding to the column header. In such case, the system considers only those records which are present on the respective page for editing.

You can also edit the end date(s) of all the hold entities, by clicking the **Edit All** link available in the upper right corner of this zone.

To delete a hold entity, select the check box corresponding to the hold entity and click the **Delete** button. You can also select multiple hold entities at the same time. In addition, you can select the check box corresponding to the column header. This allows you to delete all the hold entities listed in the respective page.

Pagination is used to display limited number of records in this zone. You can use the navigation links, such as **Previous** and **Next** to navigate between pages.

You can filter the list using the **Entity ID** search criteria available in the **Filter** area. By default, the **Filter** area is hidden.

You can view the **Filter** area by clicking the **Filters** (∨) icon in the upper right corner of this zone.

Related Topics

For more information on...	See...
How to edit the entities of the hold request	Editing the Entity Details in a Hold Request on page 1867
Search Account	Search Account on page 1851
Search Bill	Search Bill on page 1855
Search Person	Search Person on page 1857

Search Account

The **Search Account** zone allows you to search for accounts using various search criteria. It also allows you to add the accounts in a hold request. It contains the following two sections:

- **Search Criteria** - This section contains the following fields:

Field Name	Field Description	Mandatory (Yes or No)
Search By	Used to indicate whether you want to search for an account using the account or policy details. The valid values are: <ul style="list-style-type: none"> Account Details Policy Details 	Not applicable
	Note: By default, the Account Details option is selected.	
Account ID	Used to search a particular account.	No
	Note: The Search (🔍) icon appears corresponding to the Account ID field. On clicking the Search icon, the Account Search window appears. On specifying the account, the description of the account appears corresponding to the Account ID field. This field appears when you select the Account Details option from the Search By list.	
Division	Used to search accounts which belong to a particular division.	No
	Note: This field appears when you select the Account Details option from the Search By list.	
Address Source	Used to indicate the address source of the account.	Yes (Conditional)
	Note: The list includes only those values which are defined in the BILL_ADDR_SRCE_FLG lookup field. This field appears when you select the Account Details option from the Search By list.	
Bill Cycle	Used to indicate the bill cycle of the account.	No
	Note: This field appears when you select the Account Details option from the Search By list.	
State	Used to specify the state name.	No
	Note: This field appears when you either select the Account Details or Policy Details option from the Search By list.	
Customer Class	Used to indicate the customer class to which the account belongs.	No
	Note: This field appears when you select the Account Details option from the Search By list.	

Field Name	Field Description	Mandatory (Yes or No)
County	Used to specify the county name.	No
	Note: This field appears when you either select the Account Details or Policy Details option from the Search By list.	
Postal	Used to specify the postal or zip code.	No
	Note: This field appears when you either select the Account Details or Policy Details option from the Search By list.	
Price Item	Used to search a particular price item.	No
	Note: You can search for a price item by clicking the Search  icon corresponding to the field. On clicking the Search icon, the Price Item Search window appears. This field appears when you select the Policy Details option from the Search By list.	
Policy Plan Number	Used to search accounts which belong to a particular policy plan number.	No
	Note: This field appears when you select the Policy Details option from the Search By list.	
Policy Type	Used to search accounts which belong to a particular policy type.	Yes (Conditional)
	Note: The list includes only those policy types where the policy category is set to Fully-Insured Group , Fully-Insured Individual or Self-Funded . This field appears when you select the Policy Details option from the Search By list.	Note: This field is required if you are searching for accounts using the state, country, or postal as a search criteria.
Source System	Used to search accounts which were created in a particular external system.	Yes (Conditional)
	Note: The list includes only those values which are defined in the C1-SourceSystemLookup extendable lookup. This field appears when you select the Policy Details option from the Search By list.	Note: This field is required if you are searching for accounts using the state, country, or postal as a search criteria.
Policy Number	Used to search accounts with a particular policy number.	No
	Note: This field appears when you select the Policy Details option from the Search By list.	

Field Name	Field Description	Mandatory (Yes or No)
Start Date	Used to search accounts which are associated with the policies effective from a particular date.	No
	Note: This field appears when you select the Policy Details option from the Search By list.	
End Date	Used to search accounts which are associated with the policies effective till a particular date.	No
	Note: This field appears when you select the Policy Details option from the Search By list.	
Status	Used to search accounts which are associated with a particular policy status.	No
	Note: This field appears when you select the Policy Details option from the Search By list.	
Characteristic Type	Used to search accounts which are associated with the policies belonging to a particular characteristic type.	No
	Note: This field appears when you select the Policy Details option from the Search By list.	

Note:

You must specify at least one search criterion while searching for an account. One more search criterion is required when you are searching for an account using the division and/or customer class. Similarly, one more search criterion is required when you are searching for an account (associated with the policies) using the policy type and/or source system.

ORMB search engine supports wildcard search, where you can substitute the percentage (%) symbol as a stand in for any word or letter in a search criteria. You can use the ‘%’ wildcard character in all input fields except the date and ID fields. The ‘%’ wildcard character is suffixed automatically at the end of the partial search criteria. Therefore, you may or may not specify the wildcard character at the end of the partial search criteria. However, you have to prefix the wildcard character manually wherever required.

- **Search Results** - On clicking the **Search** button, the search results appear based on the specified search criteria.

The **Search Results** section contains the following columns:

Column Name	Column Description
Account Information	Displays additional information about the account. In addition, this column has a context menu which helps in navigating to other screens in the application.
	Note: It has a link. On clicking the link, the Account screen appears where you can view the details of the respective account.
Country	Displays the country name.
State	Displays the state where the county is located.
County	Displays the county name.

Column Name	Column Description
Postal	Displays the postal or zip code.
Customer Class	Indicates the customer class to which the account belongs.
Division	Indicates the division to which the account belongs.
Entity ID	Displays the entity ID.

Note: Pagination is used to display limited number of records in the **Search Results** section. You can use the navigation links, such as **Previous** and **Next** to navigate between pages.

In addition, this section contains the following button:

Button Name	Button Description
Add	Used to add an account to the hold request.

A check box appears corresponding to each account. On selecting the check box, you can add the account to the hold request. You can also select multiple accounts at the same time. In addition, you can select the check box corresponding to the column header. This allows you to add all the accounts listed in the respective page to the hold request.

Related Topics

For more information on...	See...
How to search accounts	Searching Accounts on page 1860
How to view the log of a hold request	Viewing the Log of a Hold Request on page 1875

Search Bill

The **Search Bill** zone allows you to search for the bills using various search criteria. It also allows you to add the bills in a hold request. It contains the following two sections:

- **Search Criteria** - This section contains the following fields:

Field Name	Field Description	Mandatory (Yes or No)
Search By	Used to indicate whether you want to search for a bill using the bill details.	Not applicable
	Note: By default, the Bill Details option is selected.	
Bill ID	Used to search a particular bill.	No
	Note: The Search (🔍) icon appears corresponding to the Bill ID field. On clicking the Search icon, the Bill Search window appears. On specifying the bill, the description of the bill appears corresponding to the Bill ID field.	
Alternate Bill ID	Used to search a particular bill using the alternate bill ID.	No

Field Name	Field Description	Mandatory (Yes or No)
Address Source	Used to indicate the address source of the bill.	Yes (Conditional)
	Note: The list includes only those values which are defined in the BILL_ADDR_SRCE_FLG lookup field.	Note: This field is required if you are searching for bills using the state, country, or postal as a search criteria.
Bill Date From	Used to search bills which are created from a particular date onwards.	Yes (Conditional)
	Note: By default, the current date appears in this field.	Note: This field is required if you have specified the value in the To field.
State	Used to specify the state name.	No
To	Used to search bills which are created till a particular date.	Yes (Conditional)
	Note: By default, the current date appears in this field.	Note: This field is required if you have specified the value in the Bill Date From field.
County	Used to indicate the county name.	No
Show All Bills	Used to search all those bills where the bill amount is greater than or equal to zero.	No
	Note: If this field is not selected, the system displays only those bills where the amount is greater than zero.	
Postal	Used to indicate the postal or zip code.	No

Note:

You must specify at least one search criterion while searching for a bill.

ORMB search engine supports wildcard search, where you can substitute the percentage (%) symbol as a stand in for any word or letter in a search criteria. You can use the ‘%’ wildcard character in all input fields except the date and ID fields. The ‘%’ wildcard character is suffixed automatically at the end of the partial search criteria. Therefore, you may or may not specify the wildcard character at the end of the partial search criteria. However, you have to prefix the wildcard character manually wherever required.

- **Search Results** - On clicking the **Search** button, the search results appear based on the specified search criteria. The **Search Results** section contains the following columns:

Column Name	Column Description
Bill Information	Displays additional information about the bill. In addition, this column has a context menu which helps in navigating to other screens in the application.
	Note: It has a link. On clicking the link, the Bill screen appears where you can view the details of the respective bill.
Account Information	Displays additional information about the account. In addition, this column has a context menu which helps in navigating to other screens in the application.
	Note: It has a link. On clicking the link, the Account screen appears where you can view the details of the respective account.
Country	Displays the country name.
State	Displays the state where the county is located.
County	Displays the county name.
Postal	Displays the postal or zip code.
Entity ID	Displays the entity ID.

Note: Pagination is used to display limited number of records in the **Search Results** section. You can use the navigation links, such as **Previous** and **Next** to navigate between pages.

In addition, this section contains the following button:

Button Name	Button Description
Add	Used to add a bill to the hold request.

A check box appears corresponding to each bill. On selecting the check box, you can add the bill to the hold request. You can also select multiple accounts at the same time. In addition, you can select the check box corresponding to the column header. This allows you to add all the bills listed in the respective page to the hold request.

Related Topics

For more information on...	See...
How to search bills	Searching Bills on page 1861
How to view the log of a hold request	Viewing the Log of a Hold Request on page 1875

Search Person

The **Search Person** zone allows you to search for persons using various search criteria. It also allows you to add the persons in a hold request. It contains the following two sections:

- **Search Criteria** - This section contains the following fields:

Field Name	Field Description	Mandatory (Yes or No)
Search By	Used to indicate whether you want to search for a person using the person details.	Not applicable
	Note: By default, the Person Details option is selected.	

Field Name	Field Description	Mandatory (Yes or No)
Person ID	Used to search a particular person.	No
	Note: The Search (🔍) icon appears corresponding to the Person ID field. On clicking the Search icon, the Person Search window appears. On specifying the person, the description of the person appears corresponding to the Person ID field.	
County	Used to indicate the county name.	No
State	Used to indicate the state name.	No
Postal	Used to indicate the postal or zip code.	No

Note:

You must specify at least one search criterion while searching for a person.

ORMB search engine supports wildcard search, where you can substitute the percentage (%) symbol as a stand in for any word or letter in a search criteria. You can use the ‘%’ wildcard character in all input fields except the date and ID fields. The ‘%’ wildcard character is suffixed automatically at the end of the partial search criteria. Therefore, you may or may not specify the wildcard character at the end of the partial search criteria. However, you have to prefix the wildcard character manually wherever required.

- **Search Results** - On clicking the **Search** button, the search results appear based on the specified search criteria.

The **Search Results** section contains the following columns:

Column Name	Column Description
Person Information	Displays additional information about the person. In addition, this column has a context menu which helps in navigating to other screens in the application.
	Note: It has a link. On clicking the link, the Person screen appears where you can view the details of the respective person.
Person Identifier Type	Displays the identifier type associated with the person.
Person Identifier	Displays the value of the person identifier type.
Country	Displays the country name.
State	Displays the state where the county is located.
County	Displays the county name.
Postal	Displays the postal or zip code.
Entity ID	Displays the entity ID.

Note: Pagination is used to display limited number of records in the **Search Results** section. You can use the navigation links, such as **Previous** and **Next** to navigate between pages.

In addition, this section contains the following button:

Button Name	Button Description
Add	Used to add a person to the hold request.

A check box appears corresponding to each person. On selecting the check box, you can add the person to the hold request. You can also select multiple accounts at the same time. In addition, you can select the check box corresponding to the column header. This allows you to add all the persons listed in the respective page to the hold request.

Related Topics

For more information on...	See...
How to search persons	Searching Persons on page 1860
How to view the log of a hold request	Viewing the Log of a Hold Request on page 1875

Hold Request - Log

The **Log** tab contains the following zone:

- [Hold Request Log](#) on page 1859

Hold Request Log

The **Hold Request Log** zone on the **Hold Request** screen lists the complete trail of actions performed on the hold request. This zone contains the following columns:

Column Name	Column Description
Creation Date/Time	Displays the date and time when the action was performed on the hold request.
Details	Displays the details about the action performed on the hold request.
User	Indicates the user who has performed the action on the hold request.
Log Type	Indicates the type of log.
Related Object	Indicates the object or entity which is generated when the action is performed on the hold request.
	Note: At present, no data appears in this column. The implementation team can build the custom logic to meet the business requirements.
Status Reason	Indicates the reason why the hold request was rejected by the approver.
	Note: The data appears in this column when the hold request is in the Rejected status.

Note: You can manually add a log entry for the hold request by clicking the **Add Log Entry** link in the upper right corner of the **Hold Request Log** zone.

Related Topics

For more information on...	See...
How to view the log of a hold request	Viewing the Log of a Hold Request on page 1875

For more information on...	See...
How to add a log entry for a hold request	Adding a Log Entry for a Hold Request on page 1876

Searching Persons

Prerequisites

To search persons, you should have:

- Persons created in the application

Procedure

To search for persons:

1. Search the hold requests for **Persons** that are having **Draft** status.
2. In the **Search Results** section, click the link in the **Hold Request Information** column corresponding to the *hold request* whose details you want to search.

The **Hold Request** screen appears.

3. Enter the search criteria in the **Search Person** zone.
4. Click **Search**.

A list of persons that meet the search criteria appears in the **Search Results** section.

Related Topics

For more information on...	See...
Hold Request Screen	Hold Request (Used for Viewing) on page 1847
Hold Request Zone	Hold Request on page 1848
Adding Persons in a Hold Request	Adding Persons in a Hold Request on page 1861

Searching Accounts

Prerequisites

To search accounts, you should have:

- Accounts created in the application

Procedure

To search for accounts:

1. Search the hold requests for **Account** that are having **Draft** status.
2. In the **Search Results** section, click the link in the **Hold Request Information** column corresponding to the *hold request* whose details you want to search.

The **Hold Request** screen appears.

3. Enter the search criteria in the **Search Account** zone.
4. Click **Search**.

A list of accounts that meet the search criteria appears in the **Search Results** section.

Related Topics

For more information on...	See...
Hold Request Screen	Hold Request (Used for Viewing) on page 1847
Hold Request Zone	Hold Request on page 1848
Adding Accounts in a Hold Request	Adding Accounts in a Hold Request on page 1862

Searching Bills

Prerequisites

To search bills, you should have:

- Bills generated in the application

Procedure

To search for bills:

1. Search the hold requests for **Bill** that are having **Draft** status.
2. In the **Search Results** section, click the link in the **Hold Request Information** column corresponding to the hold request whose details you want to search.

The **Hold Request** screen appears.

3. Enter the search criteria in the **Search Bill** zone.
4. Click **Search**.

A list of bills that meet the search criteria appears in the **Search Results** section.

Related Topics

For more information on...	See...
Hold Request Screen	Hold Request (Used for Viewing) on page 1847
Hold Request Zone	Hold Request on page 1848
Adding Bills in a Hold Request	Adding Bills in a Hold Request on page 1862

Adding Persons in a Hold Request

Procedure

To add persons in a hold request:

1. Search for the hold request in the **Hold Request** screen which are having **Person** as a hold entity and **Draft as** status.
2. In the **Search Results** section, click the link in the **Hold Request Information** column corresponding to the hold request whose details you want to view.

The **Hold Request** screen appears.

3. Ensure the **Search Person** zone is expanded.
4. Enter the search criteria in the **Search Person** zone.

In the **Search Results** section, list of persons meeting the search criteria are displayed.

- Select the persons which you want to add in the hold request and then click the **Add** button available in the upper left corner.

Selected persons are added in the hold request.

Related Topics

For more information on...	See...
How to search for a hold request	Searching for a Hold Request on page 1840
How to create a hold request	Creating a Hold Request on page 1841
Search Person zone	Search Person on page 1857
How to search for persons in a Hold Request Screen	Searching Persons on page 1860

Adding Accounts in a Hold Request

Procedure

To add accounts in a hold request:

- Search for the hold request in the **Hold Request** screen which are having **Account** as a hold entity and **Draft as** status.
- In the **Search Results** section, click the link in the **Hold Request Information** column corresponding to the hold request whose details you want to view.

The **Hold Request** screen appears.

- Ensure the **Search Account** zone is expanded.
- Enter the search criteria in the **Search Account** zone.

In the **Search Results** section, list of accounts meeting the search criteria are displayed.

- Select the accounts which you want to add in the hold request and then click the **Add** button available in the upper left corner.

Selected accounts are added in the hold request.

Related Topics

For more information on...	See...
How to search for a hold request	Searching for a Hold Request on page 1840
How to create a hold request	Creating a Hold Request on page 1841
Search Account zone	Search Account on page 1851
How to search for accounts in a hold request	Searching Accounts on page 1860

Adding Bills in a Hold Request

Procedure

To add bills in a hold request:

1. Search for the hold request in the **Hold Request** screen which are having **Bill** as a hold entity and **Draft** as status.
2. In the **Search Results** section, click the link in the **Hold Request Information** column corresponding to the hold request whose details you want to view.

The **Hold Request** screen appears.

3. Ensure the **Search Bill** zone is expanded.
4. Enter the search criteria in the **Search Bill** zone.
In the **Search Results** section, list of bills meeting the search criteria are displayed.
5. Select the bills which you want to add in the hold request and then click the **Add** button available in the upper left corner.

Selected bills are added in the hold request.

Related Topics

For more information on...	See...
How to search for a hold request	Searching for a Hold Request on page 1840
How to create a hold request	Creating a Hold Request on page 1841
Search Bill zone	Search Bill on page 1855
How to search for bills in a hold request	Searching Bills on page 1861

Adding Processes in a Hold Request

Prerequisites

To add processes in a hold request, you should have:

- Hold processes defined in the application.

Procedure

To add processes in a hold request:

1. Search for the hold request in the **Hold Request** screen.
2. In the **Search Results** section, click the link in the **Hold Request Information** column corresponding to the hold request whose details you want to edit.

The **Hold Request** screen appears.

3. Click the **Edit** button in the **Hold Request** zone.

The **Hold Request** screen appears.

Note: The **Edit** button appears when the hold request is in the **Draft** or **Active** status.

4. Ensure that the **Hold Processes** section is expanded when you are editing the hold request.
5. Select the required hold processes from the **Hold Process** field.
6. If you want to define more than one hold process for the hold request, click the **Add (+)** icon and then repeat step 5.

Note:

However, if you want to remove a hold process from the hold request, click the **Delete** (🗑️) icon corresponding to the hold process.

Once we create active hold request for accounts on Overdue process, all existing active overdue processes will be inactive for those account.

- Enter the required details.

Related Topics

For more information on...	See...
How to search for a hold request	Searching for a Hold Request on page 1840
How to create a hold request	Creating a Hold Request on page 1841

Defining a Characteristic for a Hold Request**Prerequisites**

To define a characteristic for a hold request, you should have:

- Characteristic types defined in the application (where the characteristic entity is set to **Hold Request**)

Procedure

To define a characteristic for a hold request:

- Ensure that the **Characteristics** section is expanded when you are defining or editing the hold request.

The **Characteristics** section contains the following columns in a grid:

Field Name	Field Description	Mandatory (Yes or No)
Effective Date	Used to specify the date from when the characteristic is effective for the hold request.	Yes (Conditional)
		Note: This field is required when you are defining a characteristic for the hold request.
Characteristic Type	Used to indicate the characteristic type.	Yes (Conditional)
	Note: The list includes only those characteristic types where the characteristic entity is set to Hold Request .	Note: This field is required when you are defining a characteristic for the hold request.
Characteristic Value	Used to specify the value for the characteristic type.	Yes (Conditional)
	Note: On specifying the value for a predefined characteristic type, the description of the characteristic value appears corresponding to the Characteristic Value field.	Note: This field is required when you are defining a characteristic for the hold request.

- Enter the required details in the **Characteristics** section.

Note: If you select a predefined characteristic type, the **Search** (🔍) icon appears corresponding to the **Characteristic Value** field. On clicking the **Search** icon, you can search for a predefined characteristic value.

- If you want to define more than one characteristic for the hold request, click the **Add** (+) icon and then repeat step 5.

Note: However, if you want to remove a characteristic from the hold request, click the **Delete** (🗑️) icon corresponding to the characteristic.

Related Topics

For more information on...	See...
How to search for a hold request	Searching for a Hold Request on page 1840
How to create a hold request	Creating a Hold Request on page 1841

Editing a Hold Request

Procedure

To edit a hold request:

- Search for the hold request in the **Hold Request** screen.
- In the **Search Results** section, click the link in the **Hold Request Information** column corresponding to the hold request whose details you want to edit.

The **Hold Request** screen appears.

- Click the **Edit** button in the **Hold Request** zone.

The **Hold Request** screen appears. It contains the following sections:

- Main** – Used to specify basic details about the hold request.
- Hold Processes** – Used to specify the processes which are kept on hold in the hold request.
- Characteristics** – Used to define the characteristics for the hold request.
- This section contains the following fields:

Field Name	Field Description	Mandatory (Yes or No)
Hold Request Information	Displays information about the hold request.	Not applicable
Hold Request Type	Displays the hold request type using which the hold request is created.	Not applicable
Start Date	Used to specify the date from when the hold request is effective.	Yes
	Note: Once the hold request start date is defined and saved, it cannot be changed.	

Field Name	Field Description	Mandatory (Yes or No)
End Date	Used to specify the date till when the hold request is effective.	Yes
	Note: The hold request end date cannot be earlier than the hold request start date.	
Hold Reason	Used to indicate the reason why you want to hold the entity.	Yes (Conditional)
	Note: The hold reason must exist in the HOLD_REASON_FLG lookup field where its status is set to Active . This field appears read-only when the hold request is in Active status.	
Entity	Displays the hold entity.	Not applicable
	Note: This field is a read-only field.	
Comments	Used to specify additional information about the hold request.	No

Note: The **Edit** button appears when the hold request is in the **Draft** or **Active** status.

4. Modify the details of the hold request, if required.
5. Define or edit the processes for the hold request, if required.
6. Define, edit, or remove characteristics of the hold request, if required.
7. Click **Save**.

The changes made to the hold request are saved.

Related Topics

For more information on...	See...
How to search for a hold request	Searching for a Hold Request on page 1840
Hold Request screen	Hold Request (Used for Searching) on page 1836
Hold Request zone	Hold Request on page 1848
How to define a process for a hold request	Adding a Process in a Hold Request on page 1845
How to define a characteristic for a hold request	Defining a Characteristic for a Hold Request on page 1864

Editing the Entity Details in a Hold Request

Procedure

To edit the entity details in a hold request:

1. Search for the hold request in the **Hold Request** screen.
2. In the **Search Results** section, click the link in the **Hold Request Information** column corresponding to the hold request whose details you want to edit.

The **Hold Request** screen appears.

3. Ensure that the **Main** tab is selected.
4. In the **Hold Entities** zone, select the check box corresponding to the hold entity that you want to edit, and click the **Edit** button.

The **Edit Hold Request Entities** screen appears. It contains the following section:

- **Hold Request Information** - Used to specify information about the hold request. It contains the following columns:

Column Name	Column Description
Start Date	Displays the date from when the hold request is effective.
End Date	Displays the date till when the hold request is effective.

In addition, the following fields appear in the grid:

Column Name	Column Description	Mandatory (Yes or No)
Entity ID	Displays the entity ID.	Not applicable
Entity Information	Displays the information about the entity.	Not applicable
Start Date	Used to indicate the date from when the entity is effective for the hold request.	Yes (Conditional)
	Note: The hold entity start date cannot be later than the hold entity end date.	Note: This field is required when you are editing the details of a hold entity.
End Date	Used to indicate the date till when the entity is effective for the hold request.	Yes (Conditional)
	Note: The hold entity end date cannot be earlier than the hold entity start date.	Note: This field is required when you are editing the details of a hold entity.
Hold Amount	Used to indicate the hold amount for bill.	Yes (Conditional)
	Note: This field appears only when the hold entity is bill.	Note: This field is required when you are editing the details of a hold entity.

If you have clicked the **Edit All** link in the **Hold Entities** zone, the following field appears:

Column Name	Column Description	Mandatory (Yes or No)
End Date	Used to specify the date till when all the entities are effective for the hold request.	Yes

- Modify the details of the hold entities, if required.
- Click **Save**.

The changes made to the hold entities are saved.

Related Topics

For more information on...	See...
How to search for a hold request	Searching for a Hold Request on page 1840
Hold Request screen	Hold Request (Used for Searching) on page 1836
Hold Request zone	Hold Request on page 1848
How to define a characteristic for a hold request	Defining a Characteristic for a Hold Request on page 1864

Deleting an Entity from a Hold Request

Procedure

To delete an entity from a hold request:

- Search for the hold request in the **Hold Request** screen.
- In the **Search Results** section, click the link in the **Hold Request Information** column corresponding to the hold request whose details you want to delete.

The **Hold Request** screen appears.

- Ensure that the **Main** tab is selected.
- In the **Hold Entities** zone, select the check box corresponding to the **Account Information** column whose entity details you want to delete and click the **Delete** button available above the table in this zone.

A message appears confirming whether you want to delete an entity from the hold request.

Note:

You can also select multiple hold entities at the same time. In addition, you can select the check box corresponding to the column header. This allows you to delete all the hold entities listed in the respective page.

You can delete an entity from the hold request when the hold request is in **Draft** and **Active** status.

You cannot delete the entities which are in the **Active** status and are defined for a hold request from the **Account Receivable Central** or **Delinquency Central** screen.

- Click **OK**.

The entity gets deleted from the hold request.

Related Topics

For more information on...	See...
How to search for a hold request	Searching for a Hold Request on page 1840
Hold Request screen	Hold Request (Used for Viewing) on page 1847
Hold Request zone	Hold Request on page 1848
Hold Entities zone	Hold Entities on page 1850

Deleting a Hold Request

Procedure

To delete a hold request:

1. Search for the hold request in the **Hold Request** screen.
2. In the **Search Results** section, click the link in the **Hold Request Information** column corresponding to the hold request that you want to delete.

The **Hold Request** screen appears.

3. Ensure that the **Main** tab is selected.
4. Click the **Delete** button in the **Hold Request** zone.

A message appears confirming whether you want to delete the hold request.

Note: The **Delete** button appears when the hold request is in the **Draft** status.

5. Click **OK**.

The hold request is deleted.

Note:

You can delete a hold request only when the hold request is in **Draft** status.

You cannot delete the bills which are added from the **Account Receivable Central** screen in the **Hold Request** screen.

Related Topics

For more information on...	See...
How to search for a hold request	Searching for a Hold Request on page 1840
Hold Request screen	Hold Request (Used for Searching) on page 1836
Hold Request zone	Hold Request on page 1848

Submitting a Hold Request

Prerequisites

To submit a hold request, you should have:

- Hold request type defined for a hold request
- Hold entity and hold processes added in the hold request

Procedure

To submit a hold request:

1. Search for the hold request in the **Hold Request** screen.
2. In the **Search Results** section, click the link in the **Hold Request Information** column corresponding to the hold request that you want to submit.

The **Hold Request** screen appears.

3. Click the **Submit** button in the **Hold Request** zone.

The system behaves in the following manner:

If...	Then
The Approval Required option is selected in the respective hold request type	The system creates a To Do using the C1-HLDAP To Do type and assigns it to the approver(s) with the To Do role specified in the hold request type. In addition, it creates a log entry for the hold request when the To Do is created. The status of the hold request is then changed to Approval In Progress .
The Approval Required option is not selected in the respective hold request type	The system changes the status of the hold request to either Deferred Processing or Active depending on whether the number of bills of the entities which are kept on hold through the hold request exceeds the defer processing count.

Note:

The **Submit** button appears when the hold request is in the **Draft** status.

The **Release** button appears in the **Record Actions** section, once the status of the hold request is changed to **Active**

Related Topics

For more information on...	See...
How to search for a hold request	Searching for a Hold Request on page 1840
Hold Request screen	Hold Request (Used for Searching) on page 1836
Hold Request zone	Hold Request on page 1848

Approving a Hold Request

You can view the number of hold requests which are pending for approval in the **Hold Request** screen. The approver can review, and accordingly approve, reject or resubmit the hold request based on the observations.

Note: The system will not allow you to approve, reject or resubmit a hold request submitted by you.

Procedure

To approve a hold request:

1. Do either of the following:

If you want to...	Then...
Approve a hold request through the Hold Request screen	<ol style="list-style-type: none"> 1. Search for the hold request in the Hold Request screen. 2. In the Search Results section, click the link in the Hold Request Information column corresponding to the hold request which you want to review.

If you want to...	Then...
Approve a hold request from the To Do List screen	<ol style="list-style-type: none"> 1. Click the Menu link in the Application toolbar. A list appears. 2. From the Main menu, select To Do and then click To Do List. The To Do Type for User Search window appears. 3. Enter C1-HLDAP in the To Do Type field. 4. Click the Search button corresponding to the To Do Type field. The To Do List screen appears. 5. Select the Open option from the Filter by list to view all unassigned To Dos. 6. Click the link in the Message column corresponding to the To Do of the hold request that you want to review.

The **Hold Request** screen appears.

2. Review the hold request details.
3. Click the **Approve** button in the **Hold Request** zone.

The system behaves in the following manner:

If you are...	Then...
Approving a hold request	The status of the hold request is changed to Active . However, if the number of bills of the entities which are kept on hold through the hold request exceeds the defer processing count, the status of the hold request is then changed to Deferred Processing .

Note:

The **Approve** button appears when:

- The hold request is in the **Approval In Progress** status.
- A user with the approval To Do role is reviewing the hold request.

Related Topics

For more information on...	See...
Hold Request screen	Hold Request (Used for Searching) on page 1836
Hold Request zone	Hold Request on page 1848
How to search for a hold request	Searching for a Hold Request on page 1840

Releasing a Hold Request

Prerequisites

To release a hold request, you should have:

- Reasons defined for the **Released** status of the **C1-HoldRequest** business object in the **Status Reason** screen.

Procedure

To release a hold request:

1. Do either of the following:

If you want to...	Then...
Release a hold request through the Hold Request screen	<ol style="list-style-type: none"> 1. Search for the hold request in the Hold Request screen. 2. In the Search Results section, click the link in the Hold Request Information column corresponding to the hold request which you want to review.
Release a hold request from the To Do List screen	<ol style="list-style-type: none"> 1. Click the Menu link in the Application toolbar. A list appears. 2. From the Main menu, select To Do and then click To Do List. The To Do Type for User Search window appears. 3. Enter C1-HLDAP in the To Do Type field. 4. Click the Search button corresponding to the To Do Type field. The To Do List screen appears. 5. Select the Open option from the Filter by list to view all unassigned To Dos. 6. Click the link in the Message column corresponding to the To Do of the hold request that you want to review.

The **Hold Request** screen appears.

2. Review the details in the **Hold Request** screen.
3. Click the **Release** button in the **Hold Request** zone.

The **Release Reason** window appears. It contains the following fields:

Field Name	Field Description	Mandatory (Yes or No)
Release Reason	Used to indicate the reason for releasing the hold request.	Yes
Comments	Used to specify the additional comments for the release reason	No

Note:

The **Release** button appears when:

- The hold request is in the **Active** status.
- A user with the approval To Do role is reviewing the hold request.

4. Select the reason for releasing the hold request from the **Release Reason** list.
5. Enter the comments in the respective field and then click **Save**.

The status of the hold request is changed to **Released**.

Related Topics

For more information on...	See...
How to search for a hold request	Searching for a Hold Request on page 1840
How to create a hold request	Creating a Hold Request on page 1841

Rejecting a Hold Request

Prerequisites

To reject a hold request, you should have:

- Reasons defined for the **Rejected** status of the **C1-HoldRequest** business object in the **Status Reason** screen.

Procedure

To reject a hold request:

- Do either of the following:

If you want to	Then
Reject a hold request through the Hold Request screen	<ol style="list-style-type: none"> Search for the hold request in the Hold Request screen. In the Search Results section, click the link in the Hold Request Information column corresponding to the hold request which you want to review.
Reject a hold request from the To Do List screen	<ol style="list-style-type: none"> Click the Menu link in the Application toolbar. A list appears. From the Main menu, select To Do and then click To Do List. The To Do Type for User Search window appears. Enter C1-HLDAP in the To Do Type field. Click the Search button corresponding to the To Do Type field. The To Do List screen appears. Select the Open option from the Filter by list to view all unassigned To Dos. Click the link in the Message column corresponding to the To Do of the hold request that you want to review.

The **Hold Request** screen appears.

- Review the details in the **Hold Request** screen.
- If the information in the hold request is incorrect, click the **Reject** button in the **Hold Request** zone.

The **Reject Hold Request** window appears. It contains following fields:

Field Name	Field Description	Mandatory (Yes or No)
Status Reason	Used to indicate the reason why you want to reject the hold request.	Yes
Comments	Used to specify additional information while rejecting the hold request.	No

Note: The **Reject** button appears when:

- The hold request is in the **Approval In Progress** status.
- A user with the approval To Do role is reviewing the hold request.

4. Select the rejection reason from the **Status Reason** list.

5. Click **Save**.

The status of the hold request is changed to **Rejected**.

Related Topics

For more information on...	See...
How to search for a hold request	Searching for a Hold Request on page 1840
Hold Request screen	Hold Request (Used for Searching) on page 1836
Hold Request zone	Hold Request on page 1848

Resubmitting a Hold Request

Prerequisites

To resubmit a hold request, you should have:

- Entities added in the hold request where the hold request is submitted for approval.

Procedure

To resubmit a hold request:

1. Do either of the following:

If you want to	Then
Reject a hold request through the Hold Request screen	<ol style="list-style-type: none"> 1. Search for the hold request in the Hold Request screen. 2. In the Search Results section, click the link in the Hold Request Information column corresponding to the hold request which you want to review.
Reject a hold request from the To Do List screen	<ol style="list-style-type: none"> 1. Click the Menu link in the Application toolbar. A list appears. 2. From the Main menu, select To Do and then click To Do List. The To Do Type for User Search window appears. 3. Enter C1-HLDAP in the To Do Type field.

If you want to	Then
	<ol style="list-style-type: none"> 4. Click the Search button corresponding to the To Do Type field. The To Do List screen appears. 5. Select the Open option from the Filter by list to view all unassigned To Dos. 6. Click the link in the Message column corresponding to the To Do of the hold request that you want to review.

The **Hold Request** screen appears.

2. Review the details in the **Hold Request** screen.
3. If the information in the hold request is incomplete and you want the submitter to make the required changes and resubmit the **Re Submit** button in the **Hold Request** zone.

The **Resubmit Hold Request** window appears. It contains the following field:

Field Name	Field Description	Mandatory (Yes or No)
Comments	Used to specify the changes which the submitter should make in the hold request before resubmitting it for approval.	Yes

Note: The **Re Submit** button appears when:

- The hold request is in the **Approval In Progress** status.
- A user with the approval To Do role is reviewing the hold request.

Note: The **Re Submit** button appears when the hold request is in the **Approval In Progress** status.

4. Enter the comments in the respective field and click **Save**.

A To Do of the **C1-HOLSB** To Do type is created and assigned to all users using a submitter To Do role specified in the hold request type. In addition, the status of the hold request is changed to **Draft**.

Related Topics

For more information on...	See...
How to search for a hold request	Searching for a Hold Request on page 1840
Hold Request screen	Hold Request (Used for Searching) on page 1836
Hold Request zone	Hold Request on page 1848

Viewing the Log of a Hold Request

Procedure

To view the log of a hold request:

1. Search for the hold request in the **Hold Request** screen.
2. In the **Search Results** section, click the link in the **Hold Request Information** column corresponding to the hold request whose log you want to view.

The **Hold Request** screen appears. It consists of the following tabs:

- **Main** – Displays information about the hold request. It contains the following zones:
 - **Hold Request** – Displays the details of the hold request.
 - **Hold Entities** – Lists the hold entities records of the hold request.
 - **Search Account** – Searches the accounts to be put on hold.

Note: This zone appears when hold request is for **Account** and its status is **Draft**.

- **Search Bill** – Searches the bills to be put on hold.

Note: This zone appears when hold request is for **Bill** and its status is **Draft**.

- **Search Person** – Searches the persons to be put on hold.

Note: This zone appears when hold request is for **Person** and its status is **Draft**.

- **Log** – Lists the complete trail of actions performed on the hold request. This tab contains the following zone:
 - **Hold Request Log** – Displays the trail of actions performed on the particular hold request.

3. Click the **Log** tab.

The **Hold Request Log** zone in the **Log** tab contains the following columns:

Column Name	Column Description
Date/Time	Displays the date and time when the action was performed on the hold request.
Details	Displays the details about the action performed on the hold request.
User	Indicates the user who has performed the action on the hold request.
Log Type	Indicates the type of log.
Related Object	Indicates the object or entity which is generated when the action is performed on the hold request.
Status Reason	Indicates the reason why the hold request was rejected or voided.

Note: You can manually add a log entry for the hold request by clicking the **Add Log Entry** link in the upper right corner of the **Hold Request Log** zone.

Related Topics

For more information on...	See...
How to search for a hold request	Searching for a Hold Request on page 1840
How to add a log entry for a hold request	Adding a Log Entry for a Hold Request on page 1876

Adding a Log Entry for a Hold Request

Procedure

To add a log entry for a hold request:

1. Search for the hold request in the **Hold Request** screen.

- In the **Search Results** section, click the link in the **Hold Request Information** column corresponding to the hold request whose log you want to edit.

The **Hold Request** screen appears. It consists of the following tabs:

- Click the **Log** tab.

The **Log** tab appears.

- Click the **Add Log Entry** link in the upper right corner of the **Hold Request Log** zone.

The **Add Hold Request Log** window appears. It contains the following fields:

Field Name	Field Description	Mandatory (Yes or No)
Hold Request Information	Displays information about the hold request.	Not applicable
Log Details	Used to specify additional comments for the hold request.	Yes

- Enter the comments in the **Log Details** field.
- Click **Save**.

The log entry is added in the **Hold Request Log** zone.

Related Topics

For more information on...	See...
How to search for a hold request	Searching for a Hold Request on page 1840
Hold Request screen	Hold Request (Used for Searching) on page 1836
Hold Request zone	Search Hold Request on page 1836

Chapter 26

Delinquency Central

Topics:

- [Prerequisites](#)
- [Delinquency Central \(Used for Viewing\)](#)
- [Overdue Process Information for Account: {Account ID}](#)

Oracle Revenue Management and Billing provides a complete overview of the overdue bills belonging to the delinquent accounts of a particular person using the **Delinquency Central**. User can review the overdue bills and perform following actions from the delinquency central:

- Initiate customer contact
- Initiate hold on overdue process
- Create payment arrangement for an account
- Create promise to pay for person's account

The Delinquency Central assists you in identifying all the overdue processes, overdue bills & delinquent accounts using an overdue monitoring process.

For more information on how to setup the delinquency central, see [Prerequisites](#) on page 1880.

Related Topics

For more information on...	See...
Delinquency Central screen	Delinquency Central (Used for Viewing) on page 1880
Overdue Process Information for Account: {Account ID}	Overdue Process Information for Account: {Account ID} on page 1887

Prerequisites

To setup delinquency central, you need to do the following:

- Define the required characteristic types where the characteristic entity is set to overdue event.
- Define the overdue event type and overdue process template in the system.
- Promise To Pay type defined in the application.
- Customer contact type defined in the application.
- Hold request type defined in the application.

Delinquency Central (Used for Viewing)

The **Delinquency Central** screen allows you to:

- Search for an overdue process
- View the details of an overdue process
- View the details of an overdue event
- Create customer contact
- Create a hold request for an overdue process
- Create a payment arrangement for an account
- Create a promise to pay for a person's account
- Create a payment agreement request for an account

This screen consists of the following zones:

- [Search Overdue Process](#)
- [Overdue Events](#)

Search Overdue Process

The **Search Overdue Process** zone allows you to search for overdue processes using various search criteria. This zone contains the following two sections:

- **Search Criteria** — The **Search Criteria** section contains the following fields:

Field Name	Field Description	Mandatory (Yes or No)
Search By	Used to indicate whether you want to search for overdue processes using person, account, bill or overdue process. The valid values are: <ul style="list-style-type: none"> • Person • Account • Bill • Overdue Process 	No
	Note: By default, the Person option is selected.	

Field Name	Field Description	Mandatory (Yes or No)
Person ID	Used to search for overdue processes which belong to a particular person.	No
	Note: This field appears when you select the Person option from the Search By list.	
Person Identifier Type	Used to search for overdue processes with a particular person identifier type.	Yes (Conditional)
	Note: This field appears when you select the Person option from the Search By list.	
Person Identifier	Used to search for overdue processes with a specific value of the person identifier type.	Yes
	Note: This field appears when you select the Person option from the Search By list.	
Account ID	Used to search for overdue processes created for a particular account.	No
	Note: This field appears when you select the Account option from the Search By list.	
Account Identifier Type	Used to search for overdue processes with a particular account identifier type.	Yes (Conditional)
	Note: This field appears when you select the Account option from the Search By list.	
Account Identifier	Used to search for overdue processes with a particular account identifier.	Yes
	Note: This field appears when you select the Account option from the Search By list.	
Bill ID	Used to search for overdue processes with a particular bill.	No
	Note: This field appears when you select the Bill option from the Search By list.	
Alternate Bill ID	Used to search for overdue processes using an alternate bill ID.	No
	Note: This field appears when you select the Bill option from the Search By list.	

Field Name	Field Description	Mandatory (Yes or No)
Characteristic Type / Value	Used to search for overdue processes with a particular characteristic type and its value.	No
	Note: This field appears when you select the Bill option from the Search By list.	
Overdue Process Template	Used to search for overdue processes with a particular overdue process template.	No
	Note: This field appears when you select the Overdue Process option from the Search By list.	
Start Date	Used to search for overdue processes with a particular start date.	Yes
	Note: This field appears when you select the Overdue Process option from the Search By list.	
End Date	Used to search overdue process with a particular end date.	Yes
	Note: This field appears when you select the Overdue Process option from the Search By list.	
Status	Used to search for overdue processes with a particular status. The valid values are: <ul style="list-style-type: none"> • Active • Inactive 	No
	Note: This field appears when you select the Overdue Process option from the Search By list.	
On Hold	Used to search for overdue processes that are on hold.	No
	Note: This field appears when you select the Overdue Process option from the Search By list.	
Overdue Amount From	Used to search for overdue processes with a particular lower limit of the overdue amount.	No
	Note: This field appears when you select the Overdue Process option from the Search By list.	
To	Used to search for overdue processes with a particular higher limit of the overdue amount.	No
	Note: This field appears when you select the Overdue Process option from the Search By list.	

Field Name	Field Description	Mandatory (Yes or No)
Characteristic Type / Value	Used to search for overdue processes with a particular characteristic type and value.	No
	Note: This field appears when you select the Overdue Process option from the Search By list.	

- In addition to above search parameters, the screen consists of following fields in the **Person Details** or **Account Details** section:

Column Name	Column Description
Main Customer	Displays the name of the main customer to whom the account belongs.
	Note: This field appears when you select the Account option from the Search By list.
Person Name	Displays the name of the person to whom the account belongs.
	Note: This field appears when you select the Person option from the Search By list.
Person Identifier Type	Displays the person identifier type.
	Note: This field appears when you select the Person or Account option from the Search By list.
Person Identifier	Displays the value of the person identifier type.
	Note: This field appears when you select the Person or Account option from the Search By list.
Account Identifier Type	Displays the account identifier type.
	Note: This field appears when you select the Account option from the Search By list.
Account Identifier	Displays the value of the account identifier type.
	Note: This field appears when you select the Account option from the Search By list.
Overdue	Displays whether the person account(s)/bill(s) are overdue. The valid values are: <ul style="list-style-type: none"> • Yes • No
	Note: This field appears when you select the Person or Account option from the Search By list.
Number of Active Overdue processes	Displays the number of overdue processes linked to the person's account that are in active status.
	Note: This field appears when you select the Person or Account option from the Search By list.

Column Name	Column Description
Number of Hold(s) on Account(s)	Displays the number of hold requests on the particular account.
Number of Overdue Bills	Displays the total number of bills that are overdue. Note: This field appears when you select the Person or Account option from the Search By list.
Total Overdue Amount	Displays the total overdue amount for an account.
Last Payment Date	Displays date of the last payment made by the person. Note: This field appears when you select the Person or Account option from the Search By list.
Last Payment Amount	Displays the amount last paid by the person. Note: This field appears when you select the Person or Account option from the Search By list.
Number Of Payment Arrangements	Displays the number of payment arrangements for the person's account. Note: This field appears when you select the Person or Account option from the Search By list.
Total Number of Overdue Process on Hold	Displays the total number of overdue process that are on hold. Note: This field appears when you select the Person or Account option from the Search By list.
Number of Promise To Pay	Displays the number of promise to pay belonging to the person. Note: This field appears when you select the Person or Account option from the Search By list.
Number of Broken Promise To Pay	Displays the total number of promise to pay that are broken. Note: This field appears when you select the Person or Account option from the Search By list.

- **Search Results** — On clicking the **Search** button, the search results appear based on the specified search criteria. The **Search Results** section contains the following columns:

Column Name	Column Description
Overdue Process	Display additional information about the overdue process. Note: It has a link. On clicking the link, the Overdue Process screen appears where you can view the details of the overdue process.
Overdue Process Template	Displays the template that was used to create overdue process's events.

Column Name	Column Description
Account Information	Display additional information about the account. In addition, this column has a context menu which helps in navigating to other screens in the application.
	Note: It has a link. On clicking the link, the Account screen appears with the details of the account.
Person Information	Display additional information about the person. In addition, this column has a context menu which helps in navigating to other screens in the application.
	Note: It has a link. On clicking the link, the Person screen appears with the details of the person.
Overdue Amount	Displays the overdue amount under that overdue process.
On Hold	Displays whether the overdue process is on hold.
Overdue Process Details	On clicking the View () icon, the Overdue Process Details screen appears where you can view details of the overdue process.

On clicking the **Broadcast** () icon corresponding to the overdue process, the **Overdue Events** zone appears with the details of the respective overdue process.

Related Topics

For more information on...	See...
Overdue Events screen	Overdue Events on page 1885
How to search for a bill	Searching for a Bill on page 1891
How to view events of an overdue process	Viewing Events of an Overdue Process on page 1886
How to view details of an overdue process	Viewing the Overdue Process Details on page 1887

Overdue Events

The **Overdue Events** zone displays the details of the events of the overdue process on the **Delinquency Central** screen.

Column Name	Column Description
Event	Displays information about the event of the overdue process.
Event Status	Displays the status of the event.
Dependency on Other Events	Displays whether the event is dependent on other events. The valid values are: <ul style="list-style-type: none"> No Yes
Trigger Date	Displays the trigger date of the event.

Related Topics

For more information on...	See...
Delinquency Central screen	Delinquency Central (Used for Viewing) on page 1880
How to view events of an overdue process	Viewing Events of an Overdue Process on page 1886

Searching for an Overdue Process

Prerequisites

To search for an overdue process, you should have:

- Overdue process defined in the application.

Procedure

To search for an overdue process:

1. Click the **Menu** link in the **Application** toolbar
2. From the **Main** menu, select **Delinquency Management** and then click **Delinquency Central**.

The **Delinquency Central** screen appears.

3. Enter the search criteria in the **Search Overdue Process** zone.

Note: ORMB search engine supports wildcard search, where you can substitute the percentage (%) symbol as a stand in for any word or letter in a search criteria. You can use the ‘%’ wildcard character in all input fields except the date and ID fields. The ‘%’ wildcard character is suffixed automatically at the end of the partial search criteria. Therefore, you may or may not specify the wildcard character at the end of the partial search criteria. However, you have to prefix the wildcard character manually wherever required.

4. Click **Search**.

A list of overdue processes that meet the search criteria appear in the **Search Results** section.

Related Topics

For more information on...	See...
Delinquency Central screen	Delinquency Central (Used for Viewing) on page 1880
Search Overdue Process zone	Search Overdue Process on page 1880

Viewing Events of an Overdue Process

Procedure

To view events of an overdue process:

1. Search for the overdue process in the **Delinquency Central** screen.
2. In the **Search Results** section, click the **Broadcast** () icon corresponding to the overdue process whose event details you want to view.

The **Overdue Events** zone appears.

3. View the overdue event details of the overdue process in the **Overdue Events** zone.

Related Topics

For more information on...	See...
Delinquency Central screen	Delinquency Central (Used for Viewing) on page 1880
Overdue Events screen	Overdue Events on page 1885
How to search for an overdue process	Searching for an Overdue Process on page 1886

Viewing the Overdue Process Details

Procedure

To view the details of an overdue process:

1. Search for the overdue process in the **Delinquency Central** screen.
2. In the **Search Results** section, click the link in the **Overdue Process Information** column corresponding to the overdue process whose details you want to view.

The **Overdue Process** screen appears. It consists of the following tabs:

- **Main** – Displays the basic details of the overdue process.
 - **Events** – Displays the events details of the overdue process.
 - **Log** – Displays a complete trail of actions performed on the overdue process.
 - **Characteristics** – Displays the characteristics of the overdue process.
3. View the event details of the overdue process in the **Overdue Process** screen.

Related Topics

For more information on...	See...
Delinquency Central screen	Delinquency Central (Used for Viewing) on page 1880
How to search for an overdue process	Searching for an Overdue Process on page 1886

Overdue Process Information for Account: {Account ID}

The **Overdue Process Information for Account: {Account ID}** screen allows you to view detail information of the account which is linked to the overdue process.

This screen consists of the following zones:

- [Person Information](#) on page 1888
- [Account Information](#) on page 1888
- [Customer Contact Details](#) on page 1888
- [Promise To Pay](#) on page 1888
- [Hold Details](#) on page 1889
- [Overdue Bills](#) on page 1889
- [Payment Arrangement](#) on page 1890
- [Search Bill](#) on page 1890
- [Searching for a Bill](#) on page 1891
- [Adding the Customer Contact Details](#) on page 1892
- [Creating a Hold Request for an Overdue Process](#) on page 1892
- [Creating a Payment Agreement Request for an Overdue Process](#)

- [Defining a Promise To Pay for an Overdue Process](#) on page 1893

Person Information

The **Person Information** zone displays details of the person whose account is linked to the overdue process. This zone contains following columns:

Column Name	Column Description
Person Name	Displays the name of the person whose account is linked to the overdue process.
Phone Number	Displays the phone number of the person.
Address	Displays the address of the person.

Account Information

The **Account Information** zone displays the details of the account that is linked with the overdue process. This zone contains following columns:

Column Name	Column Description
Account ID	Displays the account ID.
Account Identifier Type	Displays the account identifier type.
Account Identifier	Displays the value of the account identifier type.
Last Payment Date	Displays the date of the last payment made from the account that is linked with the overdue process.
Last Payment Amount	Displays the amount last paid from the account.

Customer Contact Details

The **Customer Contact Details** zone displays the contact details of the customer whose account is linked with the overdue process. This zone contains following columns:

Column Name	Column Description
Contact Date/Time	Displays the date and time when the customer was contacted.
Customer Contact Information	Displays additional information about the customer contact.
	Note: It has a link. On clicking the link, the Customer Contact screen appears where you can view the details of the respective customer contact.
Preferred Contact Method	Displays the preferred method of contacting the customer.
Comments	Displays the comments that are placed against each customer.

Promise To Pay

The **Promise To Pay** zone displays promise to pay created for an account which is linked to the overdue process. This zone contains following columns:

Column Name	Column Description
Promise To Pay Information	Displays additional information of promise to pay.
	Note: It has a link. On clicking the link, the Promise To Pay screen appears where you can view the details of promise to pay.
Scheduled Amount	Displays the amount to be paid on the Scheduled Date .
Scheduled Date	Displays the date when the payment is expected as per promise to pay.
Status	Displays the status of promise to pay.
Created By	Displays the user ID who has created the promise to pay.

Hold Details

The **Hold Details** zone displays the details of the person whose account is linked to the overdue process. This zone contains the following columns:

Column Name	Column Description
Hold Request Information	Displays additional information about the hold request.
	Note: It has a link. On clicking the link, the Hold Request screen appears where you can view the details of the hold request.
Status	Displays the status of the hold request.
Entity	Displays the hold request entity.
Entity Information	Displays the information about the entity on hold.
	Note: It has a link. On clicking the link, the Account, Bill or Person screen appears, where you can view details of the respective account, bill or person.
Start Date	Displays the date when the hold request is created.
End Date	Displays the end date of the hold request.

Overdue Bills

The **Overdue Bills** zone displays details of the overdue bills. This zone contains following columns:

Column Name	Column Description
Bill Information	Displays additional information about the bill.
	Note: It has a link. On clicking the link, the Bill screen appears where you can view the details of the respective bill.
Original Bill Amount	Displays the bill amount when the bill was generated.
Due Date	Displays the due date of the bill.
Overdue Amount	Displays the amount that is overdue in the bill.
Days Past Due	Displays the number of days past after the bill date.

Payment Arrangement

The **Payment Arrangement** zone displays the details of the payment arrangement that is created for an account linked to the overdue process. This zone contains following columns:

Column Name	Column Description
Contract Information	Displays the payment arrangement contract information . In addition, this column has a context menu which helps in navigating to other screens in the application. Note: It has a link. On clicking the link, the Contract screen appears where you can view the details of the respective contract.
Payoff Balance	Displays the total amount that is paid against the payment arrangement contract.
Arrange Amount	Displays the amount that is paid in installments as per the payment arrangement contract.
Number of Installments	Displays the number of installments used to calculate the Arrange Amount .

Search Bill

The **Search Bill** zone allows you to search for a bill. This zone contains the following fields:

- **Search Criteria** — The **Search Criteria** section contains the following fields:

Field Name	Field Description	Mandatory (Yes or No)
Person Name	Used to specify the name of the person for whom the bill is generated.	No
Person ID	Used to specify the person ID.	No
Bills of Persons in Hierarchy	Used to indicate whether you want to search for a bills generated against a person's hierarchy.	No
Bill Cycle	Used to indicate bills where a particular bill cycle is defined.	No
Bill Currency	Used to indicate the bill currency.	No
Billing Method	Used to indicate the billing method. The valid values are: <ul style="list-style-type: none"> • Ad-Hoc Billing • Regular Billing 	No
Bill ID	Used to specify the bill ID.	No
Alternate Bill ID	Used to search a particular bill using the alternate bill ID.	No
Account ID	Used to indicate the account against which the bill is generated.	No
On or After Bill Date	Used to specify the date when the bill was completed.	No
Account Identifier Type	Used to search for bills where the account against which it is generated, a particular account identifier type is defined.	No

Field Name	Field Description	Mandatory (Yes or No)
Account Identifier	Used to search for a bill generated against an account with a particular account identifier.	No

Note: You must specify at least one search criterion while searching for the bill.

- **Search Results** — On clicking the **Search** button, the search results appear based on the specified search criteria. The **Search Results** section contains the following columns:

Column Name	Column Description
Person Name	Displays the name of the person against whom the bill is generated.
Bill ID	Displays the bill ID.
Bill Status	Displays the status of the bill. The valid values are: <ul style="list-style-type: none"> • Pending • Complete
Bill Date	Displays the date when the bill was completed.
Due Date	Displays the due date of the bill.
Current Charges	Displays the bill amount.
Bill Information	Displays additional information about the bill.

Searching for a Bill

Procedure

To search for a bill:

1. Click the **Menu** link in the **Application** toolbar.
A list appears.
2. From the **Main** menu, select **Delinquency Management** and then click **Delinquency Central**.
The **Delinquency Central** screen appears.
3. Select the **Bill** option from the **Search By** list.

Note: ORMB search engine supports wildcard search, where you can substitute the percentage (%) symbol as a stand in for any word or letter in a search criteria. You can use the ‘%’ wildcard character in all input fields except the date and ID fields. The ‘%’ wildcard character is suffixed automatically at the end of the partial search criteria. Therefore, you may or may not specify the wildcard character at the end of the partial search criteria. However, you have to prefix the wildcard character manually wherever required.

4. Click **Search**.
A list of bills that meet the search criteria appear in the **Search Results** section.

Related Topics

For more information on...	See...
Delinquency Central screen	Delinquency Central (Used for Viewing) on page 1880
Search Overdue Process zone	Search Overdue Process

Adding the Customer Contact Details

Procedure

To add customer contact details:

1. Search for an overdue process in the **Delinquency Central** screen.
2. In the **Search Results** section, select the check box corresponding to the overdue process linked to the account for which you want to add the customer contact.
3. Click **Contact Customer**.

The **Customer Contact** screen appears.

4. Enter the required details.

The fields **Person ID**, **Contact Date/Time** and **User ID** are auto-populated.

5. Click **Save**.

The customer is contacted based on the value set for **Preferred Contact Method** field on the **Customer Contact** screen.

Related Topics

For more information on...	See...
Delinquency Central screen	Delinquency Central (Used for Viewing) on page 1880

Creating a Hold Request for an Overdue Process

Procedure

To create a hold request for an overdue process:

1. Search for an overdue process in the **Delinquency Central** screen.
2. In the **Search Results** section, select the check box corresponding to the **Overdue Process Information** column for whom you want to create a hold request for an overdue process.
3. Click **Create Hold Request** button.

The **Add Hold Request** screen appears. It contains the following field:

Field Name	Field Description	Mandatory
Hold Request Type	Used to indicate the hold request type that is used for creating a hold request.	Yes

4. Select the required hold request type from the **Hold Request Type** field.
 5. Click **OK**.
- The **Hold Request** screen appears.
6. Enter the required details for an overdue process.
 7. Click **Save**.

A hold request is defined for an overdue process where the status of the hold request is set as **Draft**.

Note:

The **Hold Request** screen appears where you can view the details of the hold request.

Related Topics

For more information on...	See...
Delinquency Central screen	Delinquency Central (Used for Viewing) on page 1880
Hold Request screen	Hold Request (Used for Searching) on page 1836
How to search for an overdue process	Searching for an Overdue Process on page 1886

Creating a Payment Arrangement for an Overdue Process**Procedure**

To create a payment arrangement for an overdue process:

1. Search for the overdue process in the **Delinquency Central** screen.
2. In the **Search Results** section, select the check box corresponding to the **Overdue Process Information** column for whom you want to create a payment arrangement for an overdue process.
3. Click the **Create Payment Arrangement** button.

The **Payment Arrangement** screen appears. It contains the following tabs:

- **Main**
- **History**

4. Enter the required details in the **Payment Arrangement** screen.
5. Click the **Save** button in the **Page Title** area of the **Payment Arrangement** screen.

A payment arrangement is created with the respective payment arrangement contract.

Note: The **Payment Arrangement** screen appears with the details of the payment arrangement.

Related Topics

For more information on...	See...
Delinquency Central screen	Delinquency Central (Used for Viewing) on page 1880
How to search for an overdue process	Searching for an Overdue Process on page 1886

Defining a Promise To Pay for an Overdue Process**Procedure**

To create a promise to pay for an overdue process:

1. Search for the overdue process in the **Delinquency Central** screen.
2. In the **Search Results** section, select the check box corresponding to the **Overdue Process Information** column for whom you want to define a promise to pay for an overdue process.
3. Click the **Create Promise To Pay** button.

A message appears confirming that the promise to pay will be created for the account for which the overdue process is initiated.

4. Click OK.

The **Promise To Pay** screen appears.

5. Enter the required details in the Promise To Pay screen.

6. Click the Save button in the Page Title area of the Promise To Pay screen.

A promise to pay is created with the scheduled payment details.

Related Topics

For more information on...	See...
Delinquency Central screen	Delinquency Central (Used for Viewing) on page 1880
Promise To Pay screen	Promise To Pay
How to search for an overdue process	Searching for an Overdue Process on page 1886

Chapter 27

Upload Request

Topics:

- [Upload Request \(Without Approval\) Status Transition](#)
- [Upload Request \(With Approval\) Status Transition](#)
- [Prerequisites](#)
- [Algorithms Used in C1-BillCycleUpdateUplReq](#)
- [Algorithms Used in C1-ContractRiderUpdateUplReq](#)
- [Algorithms Used in C1-HoldUploadRequest](#)
- [Algorithms Used in C1-RefundUploadRequest](#)
- [Algorithms Used in C1-WriteOffUploadRequest](#)
- [Algorithms Used in C1-BillableChargeUploadRequest](#)
- [Algorithms Used in C1-ReinstatementUploadRequest](#)
- [Algorithms Used in C1-BillGrpSortUploadRequest](#)
- [Algorithms Used in C1-BillLevelUploadRequest](#)
- [CSV File Format for Account Bill Cycle Upload Request](#)
- [CSV File Format for Contract Rider Upload Request](#)
- [CSV File Format for Billable Charge Upload](#)
- [CSV File Format for Hold Upload Request](#)
- [CSV File Format for Refund Request Upload](#)

Oracle Revenue Management and Billing provides a generic upload feature which enables you to upload various types of data. The system enables you to upload data for the following using the **Upload Request** feature:

- Billable Charge (Adhoc and Regular)
- Hold Request
- Refund Request
- Write Off Request
- Policy Reinstatement
- Bill Group Sort ID
- Derivation and Pricing Parameters for a Bill Group and Sort ID Combination

It also enables you to update the following information:

- Contract rider of a contract
- Bill cycle of an account

While uploading data for the above supported entities, you need to specify the upload request type using which you want to upload the file. It is the upload request type which helps the system to determine:

- Whether the file must be approved by the approver before creating or updating the entities
- Which business object must be used for creating the upload request
- Which business object must be used for creating or updating entities through an upload request
- Which foreign key reference must be used for generating information string for the entity
- A set of fields using which you can search records uploaded through an upload request

You can upload a data file in the CSV format. You cannot upload data for more than one entity type through the same CSV file. For example, you cannot upload data for billable charges and hold requests using a single CSV file. An upload request of the specified upload request type is created when the file is successfully uploaded in the system. You can track a file through an upload request.

Once an upload request is created, the status of the upload request is set to **Draft**. The status of each record uploaded through an upload request is set to **Pending**. However, if the mandatory data is not available or data required for deriving

- [CSV File Format for Write Off Request Upload](#)
- [CSV File Format for Reinstatement Upload Request](#)
- [CSV File Format for Bill Group Sorting Upload Request](#)
- [CSV File Format for Bill Group Derivation and Pricing Parameters Upload Request](#)
- [Upload Request Type](#)
- [Upload Request \(Used for Searching\)](#)
- [Upload Request \(Used for Viewing\)](#)

mandatory data is incorrect in the record, the status of record is set to **Invalid**. You can then edit, delete, or validate the upload request. During the validation process, the system and custom validations (if any) are executed. The status of each record is changed to **Valid** or **Invalid** depending on whether the record was validated successfully or not.

Once the upload request is validated, you can either cancel or submit the upload request for further processing. On submitting an upload request, the system checks whether the number of valid records in the uploaded file exceed the online record process limit defined in the Defer Upload Request algorithm. If the number of valid records in the uploaded file does not exceed the online record process limit, the system creates or updates the entities in the real time (i.e. immediately). However, if the number of valid records in the uploaded file exceeds the online record process limit, the system creates or updates the entities in the deferred mode (i.e. when the **Upload Request Periodic Monitor (C1-UPLRQ)** batch is invoked).

You can optionally configure the system to use the approval workflow process for an upload request. If the **Approval Required** flag is set to **Yes** in an upload request type, then on submitting the respective upload request, the approval workflow process creates a To Do for the approver to review the upload request. Once the approver approves the upload request, the system checks whether the number of valid records in the uploaded file exceed the online record process limit defined in the Defer Upload Request algorithm. If the number of valid records in the uploaded file does not exceed the online record process limit, the system creates or updates the entities in the real time (i.e. immediately). However, if the number of valid records in the uploaded file exceeds the online record process limit, the system creates or updates the entities in the deferred mode (i.e. when the **Upload Request Periodic Monitor (C1-UPLRQ)** batch is invoked. However, if the approver rejects the upload request, the status of the upload request is set to **Rejected**.

During the upload process, an upload request goes through various statuses in its lifecycle. Note that the lifecycle of an upload request is driven by the business object using which the upload request is created. In this release, we have shipped the following upload request business objects:

- Update Bill Cycle Upload Request (C1-BillCycleUpdateUplReq)
- Billable Charge Upload Request (C1-BillableChargeUploadRequest)
- Update Contract Rider Upload Request (C1-ContractRiderUpdateUplReq)
- Hold Request Upload Request (C1-HoldUploadRequest)
- Refund Request Upload Request (C1-RefundUploadRequest)
- Write Off Request Upload Request (C1-WriteOffUploadRequest)
- Reinstatement Upload Request (C1-ReinstatementUploadRequest)
- Bill Group Sorting Upload Request (C1-BillGrpSortUploadRequest)
- Bill Group Derivation and Pricing Parameters Upload Request(C1-BillLevelUploadRequest)

During the upload request process, an upload request creation goes through various statuses in its lifecycle. For more information about the upload request statuses, see [Upload Request \(Without Approval\) Status Transition](#) on page 1898 and [Upload Request \(With Approval\) Status Transition](#) on page 1899.

Note: The lifecycle of an upload request creation is driven by the respective business object using which the request is created. The upload request feature explained in this document is articulated based on the lifecycle and logic defined in the business objects.

For more information on how to setup the upload request process, see [Prerequisites](#) on page 1900.

Upload Request (Without Approval) Status Transition

The following figure graphically indicates how an upload request moves from one status to another when the approval workflow is off:

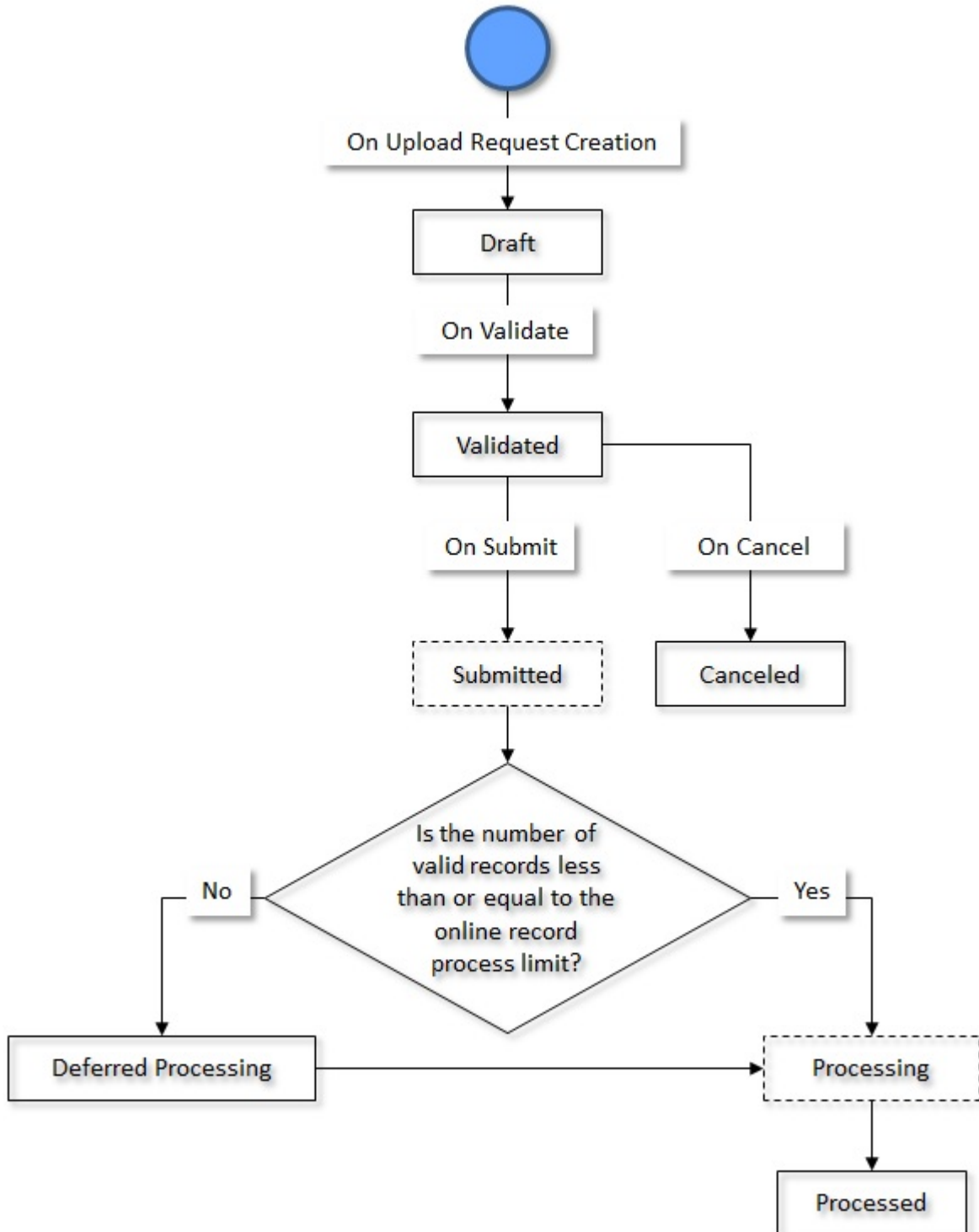

Upload Request (With Approval) Status Transition

The following figure graphically indicates how an upload request moves from one status to another when the approval workflow is on:

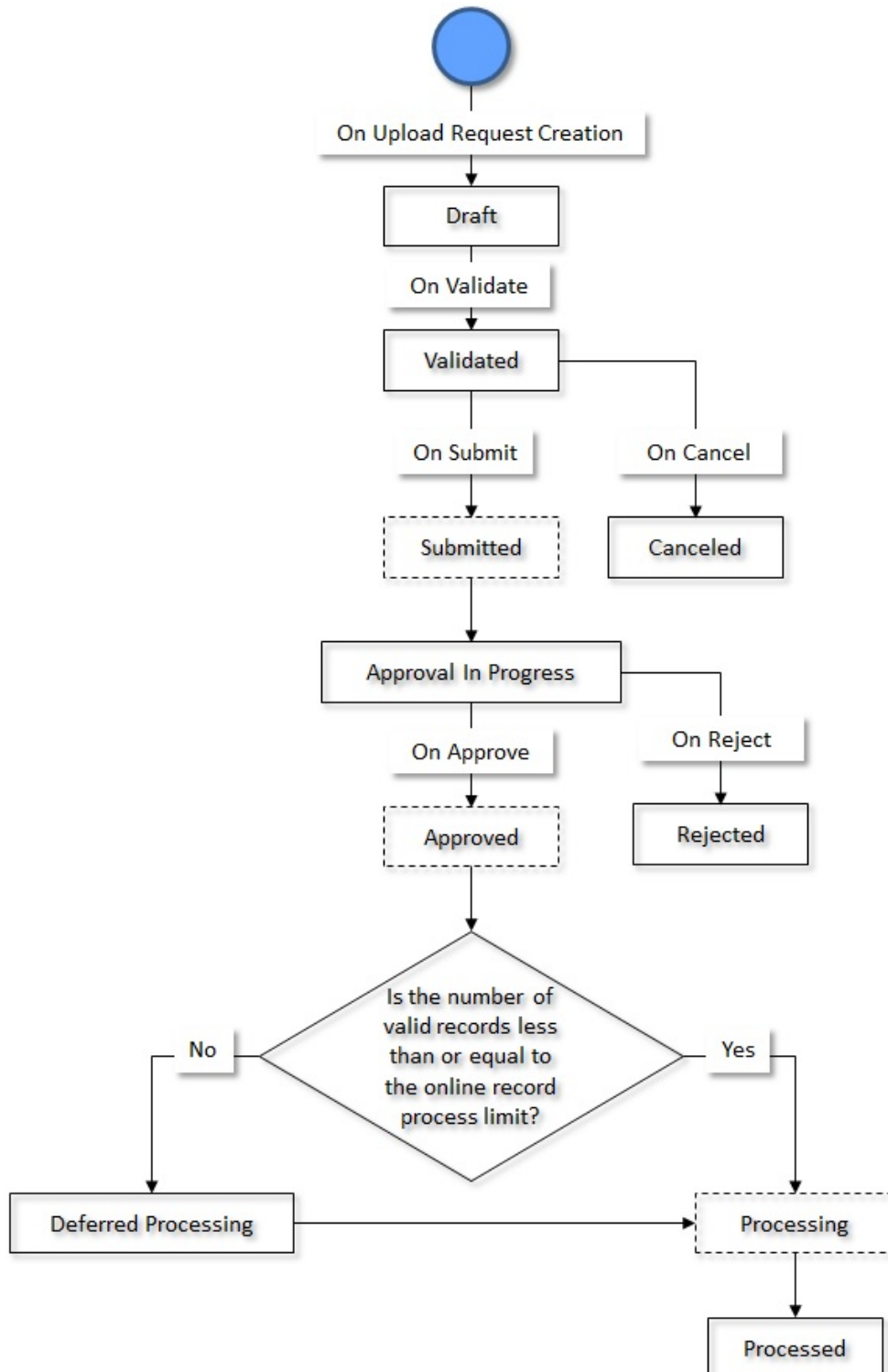

Prerequisites

To setup the upload request process, you need to do the following:

- Define the required upload request types in the system.
- Define the required characteristic types where the characteristic entity is set to **Upload Request Type**.
- Define the required characteristic types where the characteristic entity is set to **Upload Request**.
- Define the values for the following parameters in the **C1-REN-VALID** algorithm:
 - Policy Status after Processing Reinstatement Upload Request
 - Policy Reinstatement Status for Reason Verification
- Define the value for the **Online Record Process Limit** parameter in the **C1-DEFERUPLD** algorithm.
- Define the value for the **Policy Status after Processing Reinstatement Upload Request** parameter in the **C1-REN-PROC** algorithm.
- Assign the **C1-BCUUR** To Do type to a To Do role whose users must receive the To Do for approving a bill cycle update upload request.
- Assign the **C1-CRUUR** To Do type to a To Do role whose users must receive the To Do for approving a contract rider update upload request.
- Assign the **C1-HLDUR** To Do type to a To Do role whose users must receive the To Do for approving a hold upload request.
- Assign the **C1-REFUR** To Do type to a To Do role whose users must receive the To Do for approving a refund upload request.
- Assign the **C1-WOUR** To Do type to a To Do role whose users must receive the To Do for approving a write off upload request.
- Assign the **C1-BCUR** To Do type to a To Do role whose users must receive the To Do for approving a billable charge upload request.
- Assign the **C1-RPUR** To Do type to a To Do role whose users must receive the To Do for approving a reinstatement upload request.
- Create a To Do type named **C1-BGSRT** using the following information:
 - **Navigation Option** - c1upldrqTabMenu
 - **Sort Keys** - Define the following sort keys for the To Do type:

Sort Key	Use as Default	Sort Order
Upload Request ID	Yes	Descending

- **Drill Keys** - Define the following drill keys for the To Do type:

Table Name	Field Name
C1_UPLOAD_REQ	Upload Request ID

- Assign the **C1-BGSRT** To Do type to a To Do role whose users must receive the To Do for approving a bill group sorting upload request.
- Create a To Do type named **C1-BGDVP** using the following information:
 - **Navigation Option** - c1upldrqTabMenu

- **Sort Keys** - Define the following sort keys for the To Do type:

Sort Key	Use as Default	Sort Order
Upload Request ID	Yes	Descending

- **Drill Keys** - Define the following drill keys for the To Do type:

Table Name	Field Name
C1_UPLOAD_REQ	Upload Request ID

- Assign the **C1-BGDVP** To Do type to a To Do role whose users must receive the To Do for approving a bill group derivation and pricing parameters upload request.
- Set the batch control type of the **Upload Request Periodic Monitor (C1-UPLRQ)** batch to **Timed** and define the following attributes:
 - Time Interval
 - Timer Active
 - User ID
 - Batch Language
 - Email Address

Algorithms Used in C1-BillCycleUpdateUplReq

The following table lists the algorithms which are used in the lifecycle of the **C1-BillCycleUpdateUplReq** business object:

Status	System Event	Algorithm	Algorithm Type	Description
Draft	Enter	C1-BCU-DERIV	C1-BCU-DERIV	<p>This algorithm reads the data in the BO_DATA_AREA column of the C1_UPL_REQUEST table and accordingly inserts the records in the C1_UPLOAD_REQ_DTLS table. In addition, the status of each record in the C1_UPLOAD_REQ_DTLS table is set to Pending.</p> <p>It derives the account ID using the account identifier type and account identifier combination whenever the account ID is not specified in the record. Once the account ID is derived, the corresponding record is updated in the C1_UPLOAD_REQ_DTLS table. If the system could not derive the account ID using the account identifier type and account identifier combination, the status of the record in the C1_UPLOAD_REQ_DTLS table is changed to Invalid.</p>

Status	System Event	Algorithm	Algorithm Type	Description
Validated	Enter	C1-BCU-VALID	C1-BCU-VALID	<p>This algorithm is invoked when the user clicks the Validate button. It validates the records which are in the Pending status. It checks whether the account ID and bill cycle specified in the record are valid. If the account ID and bill cycle are valid and if the bill cycle is associated with the division to which the account belongs, the status of the record in the C1_UPLOAD_REQ_DTLS table is changed to Valid.</p> <p>If the account ID is invalid, it derives the account ID using the account identifier type and account identifier combination and updates the record accordingly. In addition, it changes the status of the record in the C1_UPLOAD_REQ_DTLS table to Valid. However, if the system could not derive the account ID using the account identifier type and account identifier combination, or if the bill cycle is invalid, or if the bill cycle is not associated with the division to which the account belongs, the status of the record in the C1_UPLOAD_REQ_DTLS table is changed to Invalid.</p> <p>It also checks whether there are two or more records with the same account ID. If so, it validates and changes the status of one record to Valid and the status of the remaining records is changed to Invalid.</p>
Submitted	Monitor	F1-AT-RQJ	F1-GEN-BOMNJ	<p>This algorithm transitions the current status to the specified status. You can specify the status to which you want the business object to transition in the following parameters:</p> <ul style="list-style-type: none"> • Next Status • Next Transition Condition <p>At a time, you can specify value for either the Next Status or Next Transition Condition parameter. If you don't specify any value for these parameters, the system will transition the business object to the default next status specified in its lifecycle.</p>

Status	System Event	Algorithm	Algorithm Type	Description
Submitted	Enter	C1-UPLSUBENT	C1-UPLSUBENT	This algorithm is invoked when the user clicks the Submit button. It checks whether the approval is required for the upload request. If the approval is required for an upload request, the status of the upload request is changed to Approval In Progress . However, if the approval is not required for an upload request, the status of the upload request remains in the Submitted status.
Submitted	Enter	C1-DEFERUPLD	C1-DEFERUPLD	This algorithm is invoked when the status of the upload request is changed to Submitted or Approved . It checks whether the upload request must be processed in the real time (i.e. immediately) or in the deferred mode (i.e. in the background). If the number of valid records in the upload request does not exceed the online record process limit, the system changes the status of the upload request to Processing . However, if the number of valid records in the upload request exceeds the online record process limit, the system changes the status of the upload request to Deferred Processing . It contains the following parameter: <ul style="list-style-type: none"> • Online Record Process Limit <ul style="list-style-type: none"> – Used to indicate the maximum number of valid records you can process in the real time (i.e. immediately).
Approval In Progress	Enter	C1-UPLAPPENT	C1-UPLAPPENT	This algorithm creates a To Do using the To Do type specified in the upload request type. The To Do is sent to the appropriate users with the To Do role which is specified in the upload request type. In addition, a log entry is added when a To Do is created using the To Do type.
Approval In Progress	Exit	C1-UPLAPPEXT	C1-UPLAPPEXT	This algorithm checks whether the approver is associated with the approval To Do role specified in the upload request type. If not, it does not allow the approver to approve or reject the upload request. In addition, it does not allow the submitter to approve or reject the upload request.

Status	System Event	Algorithm	Algorithm Type	Description
Approval In Progress	Exit	F1-TODOCOMPL	F1-TODOCOMPL	This algorithm completes To Do entries that are created for the business object when the business object exits the given status. It finds and completes all open To Do entries where the business object's primary key is defined as a drill key. However, if the Exclude To Do Entries From Auto Completion characteristic is defined for the business object, then the system does not automatically complete the respective To Do entry.
Approved	Enter	C1-DEFERUPLD	C1-DEFERUPLD	This algorithm is invoked when the status of the upload request is changed to Submitted or Approved . It checks whether the upload request must be processed in the real time (i.e. immediately) or in the deferred mode (i.e. in the background). If the number of valid records in the upload request does not exceed the online record process limit, the system changes the status of the upload request to Processing . However, if the number of valid records in the upload request exceeds the online record process limit, the system changes the status of the upload request to Deferred Processing . It contains the following parameter: <ul style="list-style-type: none"> • Online Record Process Limit <ul style="list-style-type: none"> – Used to indicate the maximum number of valid records you can process in the real time (i.e. immediately).
Approved	Monitor	F1-AT-RQJ	F1-GEN-BOMNJ	This algorithm transitions the current status to the specified status. You can specify the status to which you want the business object to transition in the following parameters: <ul style="list-style-type: none"> • Next Status • Next Transition Condition At a time, you can specify value for either the Next Status or Next Transition Condition parameter. If you don't specify any value for these parameters, the system will transition the business object to the default next status specified in its lifecycle.

Status	System Event	Algorithm	Algorithm Type	Description
Deferred Processing	Monitor	F1-AT-RQJ	F1-GEN-BOMNJ	<p>This algorithm transitions the current status to the specified status. You can specify the status to which you want the business object to transition in the following parameters:</p> <ul style="list-style-type: none"> • Next Status • Next Transition Condition <p>At a time, you can specify value for either the Next Status or Next Transition Condition parameter. If you don't specify any value for these parameters, the system will transition the business object to the default next status specified in its lifecycle.</p>
Processing	Enter	C1-BCU-PROC	C1-BCU-PROC	<p>This algorithm fetches a list of records which are in the Valid status. For each valid record, the system reads the account ID and bill cycle, and updates the bill cycle information of the account using the entity business object defined in the upload request type. If the record is successfully processed, the status of the record is changed to Processed. However, if the record could not be processed successfully due to any reason, the status of the record is changed to Error. Finally, the status of the upload request is changed to Processed.</p>
Processing	Monitor	F1-AT-RQJ	F1-GEN-BOMNJ	<p>This algorithm transitions the current status to the specified status. You can specify the status to which you want the business object to transition in the following parameters:</p> <ul style="list-style-type: none"> • Next Status • Next Transition Condition <p>At a time, you can specify value for either the Next Status or Next Transition Condition parameter. If you don't specify any value for these parameters, the system will transition the business object to the default next status specified in its lifecycle.</p>

Algorithms Used in C1-ContractRiderUpdateUplReq

The following table lists the algorithms which are used in the lifecycle of the **C1-ContractRiderUpdateUplReq** business object:

Status	System Event	Algorithm	Algorithm Type	Description
Draft	Enter	C1-CR-DERIV	C1-CR-DERIV	<p>This algorithm reads the data in the BO_DATA_AREA column of the C1_UPL_REQUEST table and accordingly inserts the records in the C1_UPLOAD_REQ_DTLS table. In addition, the status of each record in the C1_UPLOAD_REQ_DTLS table is set to Pending.</p> <p>It derives the account ID using the account identifier type and account identifier combination whenever the account ID is not specified in the record. Once the account ID is derived, the corresponding record is updated in the C1_UPLOAD_REQ_DTLS table. If the system could not derive the account ID using the account identifier type and account identifier combination, the status of the record in the C1_UPLOAD_REQ_DTLS table is changed to Invalid.</p>

Status	System Event	Algorithm	Algorithm Type	Description
Validated	Enter	C1-CR-VALID	C1-CR-VALID	<p>This algorithm is invoked when the user clicks the Validate button. It validates the records which are in the Pending status. It checks whether the account ID, contract ID, contract type, and bill factor specified in the record are valid. If the account ID, contract ID, contract type, and bill factor are valid, if the specified contract belongs to the account, and if the Contract Rider Applicability flag on the bill factor is set to Y, the status of the record in the C1_UPLOAD_REQ_DTLS table is changed to Valid.</p> <p>If the account ID is invalid, it derives the account ID using the account identifier type and account identifier combination and updates the record accordingly. In addition, it changes the status of the record in the C1_UPLOAD_REQ_DTLS table to Valid. However, if the system could not derive the account ID using the account identifier type and account identifier combination, or if the bill factor is invalid, or if the specified contract does not belong to the account, or if the Contract Rider Applicability flag on the bill factor is set to N, the status of the record in the C1_UPLOAD_REQ_DTLS table is changed to Invalid.</p> <p>It also checks whether there are two or more records with the same account ID and contract type combination. If so, it validates and changes the status of one record to Valid and the status of the remaining records is changed to Invalid.</p>
Submitted	Enter	C1-UPLSUBENT	C1-UPLSUBENT	<p>This algorithm is invoked when the user clicks the Submit button. It checks whether the approval is required for the upload request. If the approval is required for an upload request, the status of the upload request is changed to Approval In Progress. However, if the approval is not required for an upload request, the status of the upload request remains in the Submitted status.</p>

Status	System Event	Algorithm	Algorithm Type	Description
Submitted	Enter	C1-DEFERUPLD	C1-DEFERUPLD	<p>This algorithm is invoked when the status of the upload request is changed to Submitted or Approved. It checks whether the upload request must be processed in the real time (i.e. immediately) or in the deferred mode (i.e. in the background). If the number of valid records in the upload request does not exceed the online record process limit, the system changes the status of the upload request to Processing. However, if the number of valid records in the upload request exceeds the online record process limit, the system changes the status of the upload request to Deferred Processing.</p> <p>It contains the following parameter:</p> <ul style="list-style-type: none"> • Online Record Process Limit <ul style="list-style-type: none"> – Used to indicate the maximum number of valid records you can process in the real time (i.e. immediately).
Submitted	Monitor	F1-AT-RQJ	F1-GEN-BOMNJ	<p>This algorithm transitions the current status to the specified status. You can specify the status to which you want the business object to transition in the following parameters:</p> <ul style="list-style-type: none"> • Next Status • Next Transition Condition <p>At a time, you can specify value for either the Next Status or Next Transition Condition parameter. If you don't specify any value for these parameters, the system will transition the business object to the default next status specified in its lifecycle.</p>
Approval In Progress	Enter	C1-UPLAPPENT	C1-UPLAPPENT	<p>This algorithm creates a To Do using the To Do type specified in the upload request type. The To Do is sent to the appropriate users with the To Do role which is specified in the upload request type. In addition, a log entry is added when a To Do is created using the To Do type.</p>

Status	System Event	Algorithm	Algorithm Type	Description
Approval In Progress	Exit	C1-UPLAPPEXT	C1-UPLAPPEXT	This algorithm checks whether the approver is associated with the approval To Do role specified in the upload request type. If not, it does not allow the approver to approve or reject the upload request. In addition, it does not allow the submitter to approve or reject the upload request.
Approval In Progress	Exit	F1-TODOCOMPL	F1-TODOCOMPL	This algorithm completes To Do entries that are created for the business object when the business object exits the given status. It finds and completes all open To Do entries where the business object's primary key is defined as a drill key. However, if the Exclude To Do Entries From Auto Completion characteristic is defined for the business object, then the system does not automatically complete the respective To Do entry.
Approved	Enter	C1-DEFERUPLD	C1-DEFERUPLD	<p>This algorithm is invoked when the status of the upload request is changed to Submitted or Approved. It checks whether the upload request must be processed in the real time (i.e. immediately) or in the deferred mode (i.e. in the background). If the number of valid records in the upload request does not exceed the online record process limit, the system changes the status of the upload request to Processing. However, if the number of valid records in the upload request exceeds the online record process limit, the system changes the status of the upload request to Deferred Processing.</p> <p>It contains the following parameter:</p> <ul style="list-style-type: none"> • Online Record Process Limit <ul style="list-style-type: none"> – Used to indicate the maximum number of valid records you can process in the real time (i.e. immediately).

Status	System Event	Algorithm	Algorithm Type	Description
Approved	Monitor	F1-AT-RQJ	F1-GEN-BOMNJ	<p>This algorithm transitions the current status to the specified status. You can specify the status to which you want the business object to transition in the following parameters:</p> <ul style="list-style-type: none"> • Next Status • Next Transition Condition <p>At a time, you can specify value for either the Next Status or Next Transition Condition parameter. If you don't specify any value for these parameters, the system will transition the business object to the default next status specified in its lifecycle.</p>
Deferred Processing	Monitor	F1-AT-RQJ	F1-GEN-BOMNJ	<p>This algorithm transitions the current status to the specified status. You can specify the status to which you want the business object to transition in the following parameters:</p> <ul style="list-style-type: none"> • Next Status • Next Transition Condition <p>At a time, you can specify value for either the Next Status or Next Transition Condition parameter. If you don't specify any value for these parameters, the system will transition the business object to the default next status specified in its lifecycle.</p>

Status	System Event	Algorithm	Algorithm Type	Description
Processing	Enter	C1-CR-PROC	C1-CR-PROC	This algorithm fetches a list of records which are in the Valid status. For each valid record, the system reads the account ID and contract ID, and updates the contract rider information of the contract using the entity business object defined in the upload request type. If the contract ID is not specified in the record, then the system derives the active contract of the specified contract type on the account, and then updates the contract rider information of the contract. If the record is successfully processed, the status of the record is changed to Processed . However, if the record could not be processed successfully due to any reason, the status of the record is changed to Error . Finally, the status of the upload request is changed to Processed .
Processing	Monitor	F1-AT-RQJ	F1-GEN-BOMNJ	This algorithm transitions the current status to the specified status. You can specify the status to which you want the business object to transition in the following parameters: <ul style="list-style-type: none"> • Next Status • Next Transition Condition At a time, you can specify value for either the Next Status or Next Transition Condition parameter. If you don't specify any value for these parameters, the system will transition the business object to the default next status specified in its lifecycle.

Algorithms Used in C1-HoldUploadRequest

The following table lists the algorithms which are used in the lifecycle of the **C1-HoldUploadRequest** business object:

Status	System Event	Algorithm	Algorithm Type	Description
Draft	Enter	C1-HLD-DERIV	C1-HLD-DERIV	<p>This algorithm reads the data in the BO_DATA_AREA column of the C1_UPL_REQUEST table and accordingly inserts the records in the C1_UPLOAD_REQ_DTLS table. In addition, the status of each record in the C1_UPLOAD_REQ_DTLS table is set to Pending.</p> <p>If the hold entity is ACCT and the entity ID is not specified in the record, it derives the account ID using the account identifier type and account identifier combination. Similarly, if the hold entity is PERS and the entity ID is not specified in the record, it derives the person ID using the person identifier type and person identifier combination. Once the account ID or person ID is derived, the corresponding record is updated in the C1_UPLOAD_REQ_DTLS table. If the system could not derive the account ID using the account identifier type and account identifier combination or if the system could not derive the person ID using the person identifier type and person identifier combination, the status of the record in the C1_UPLOAD_REQ_DTLS table is changed to Invalid.</p>

Status	System Event	Algorithm	Algorithm Type	Description
Validated	Enter	C1-HLD-VALID	C1-HLD-VALID	<p>This algorithm is invoked when the user clicks the Validate button. It validates the records which are in the Pending status. It checks whether the data provided for creating a hold request is valid. If the entity ID and hold data are valid, the status of the record in the C1_UPLOAD_REQ_DTLS table is changed to Valid.</p> <p>If the hold entity is ACCT and the entity ID is invalid, it derives the account ID using the account identifier type and account identifier combination and updates the record accordingly. Similarly, if the hold entity is PERS and the entity ID is invalid, it derives the person ID using the person identifier type and person identifier combination and updates the record accordingly. In addition, it changes the status of the record in the C1_UPLOAD_REQ_DTLS table to Valid. However, if the system could not derive the account ID using the account identifier type and account identifier combination, or if the system could not derive the person ID using the person identifier type and person identifier combination, or if the hold data is invalid, the status of the record in the C1_UPLOAD_REQ_DTLS table is changed to Invalid.</p>
Submitted	Enter	C1-UPLSUBENT	C1-UPLSUBENT	<p>This algorithm is invoked when the user clicks the Submit button. It checks whether the approval is required for the upload request. If the approval is required for an upload request, the status of the upload request is changed to Approval In Progress. However, if the approval is not required for an upload request, the status of the upload request remains in the Submitted status.</p>

Status	System Event	Algorithm	Algorithm Type	Description
Submitted	Enter	C1-DEFERUPLD	C1-DEFERUPLD	<p>This algorithm is invoked when the status of the upload request is changed to Submitted or Approved. It checks whether the upload request must be processed in the real time (i.e. immediately) or in the deferred mode (i.e. in the background). If the number of valid records in the upload request does not exceed the online record process limit, the system changes the status of the upload request to Processing. However, if the number of valid records in the upload request exceeds the online record process limit, the system changes the status of the upload request to Deferred Processing.</p> <p>It contains the following parameter:</p> <ul style="list-style-type: none"> • Online Record Process Limit <ul style="list-style-type: none"> – Used to indicate the maximum number of valid records you can process in the real time (i.e. immediately).
Submitted	Monitor	F1-AT-RQJ	F1-GEN-BOMNJ	<p>This algorithm transitions the current status to the specified status. You can specify the status to which you want the business object to transition in the following parameters:</p> <ul style="list-style-type: none"> • Next Status • Next Transition Condition <p>At a time, you can specify value for either the Next Status or Next Transition Condition parameter. If you don't specify any value for these parameters, the system will transition the business object to the default next status specified in its lifecycle.</p>
Approval In Progress	Enter	C1-UPLAPPENT	C1-UPLAPPENT	<p>This algorithm creates a To Do using the To Do type specified in the upload request type. The To Do is sent to the appropriate users with the To Do role which is specified in the upload request type. In addition, a log entry is added when a To Do is created using the To Do type.</p>

Status	System Event	Algorithm	Algorithm Type	Description
Approval In Progress	Exit	C1-UPLAPPEXT	C1-UPLAPPEXT	This algorithm checks whether the approver is associated with the approval To Do role specified in the upload request type. If not, it does not allow the approver to approve or reject the upload request. In addition, it does not allow the submitter to approve or reject the upload request.
Approval In Progress	Exit	F1-TODOCOMPL	F1-TODOCOMPL	This algorithm completes To Do entries that are created for the business object when the business object exits the given status. It finds and completes all open To Do entries where the business object's primary key is defined as a drill key. However, if the Exclude To Do Entries From Auto Completion characteristic is defined for the business object, then the system does not automatically complete the respective To Do entry.
Approved	Enter	C1-DEFERUPLD	C1-DEFERUPLD	<p>This algorithm is invoked when the status of the upload request is changed to Submitted or Approved. It checks whether the upload request must be processed in the real time (i.e. immediately) or in the deferred mode (i.e. in the background). If the number of valid records in the upload request does not exceed the online record process limit, the system changes the status of the upload request to Processing. However, if the number of valid records in the upload request exceeds the online record process limit, the system changes the status of the upload request to Deferred Processing.</p> <p>It contains the following parameter:</p> <ul style="list-style-type: none"> • Online Record Process Limit <ul style="list-style-type: none"> – Used to indicate the maximum number of valid records you can process in the real time (i.e. immediately).

Status	System Event	Algorithm	Algorithm Type	Description
Approved	Monitor	F1-AT-RQJ	F1-GEN-BOMNJ	<p>This algorithm transitions the current status to the specified status. You can specify the status to which you want the business object to transition in the following parameters:</p> <ul style="list-style-type: none"> • Next Status • Next Transition Condition <p>At a time, you can specify value for either the Next Status or Next Transition Condition parameter. If you don't specify any value for these parameters, the system will transition the business object to the default next status specified in its lifecycle.</p>
Deferred Processing	Monitor	F1-AT-RQJ	F1-GEN-BOMNJ	<p>This algorithm transitions the current status to the specified status. You can specify the status to which you want the business object to transition in the following parameters:</p> <ul style="list-style-type: none"> • Next Status • Next Transition Condition <p>At a time, you can specify value for either the Next Status or Next Transition Condition parameter. If you don't specify any value for these parameters, the system will transition the business object to the default next status specified in its lifecycle.</p>

Status	System Event	Algorithm	Algorithm Type	Description
Processing	Enter	C1-HLD-PROC	C1-HLD-PROC	<p>This algorithm fetches a list of records which are in the Valid status. For each valid record with a unique combination of the hold request type, start date, end date, hold reason, hold entity, hold entity start date, hold entity end date, comments, hold process details, and hold characteristic details, it creates one hold request using the entity business object defined in the upload request type. However, if there are multiple entity IDs with the same combination, all are added in the same hold request. The hold request is created in the Draft status and then transitioned to Submit.</p> <p>From the Submit status, the status of the hold request is either changed to Approval In Progress or Active depending on whether the Approval Required flag is set to Yes. If the number of bills of the entities which are kept on hold through the hold request does not exceed the defer processing count (defined in the hold request type), the status of the hold request is changed to Active. However, if the number of bills of the entities which are kept on hold through the hold request exceeds the defer processing count, the status of the hold request is changed to Deferred Processing. If the record is successfully processed, the status of the record is changed to Processed. However, if the record could not be processed successfully due to any reason, the status of the record is changed to Error. Finally, the status of the upload request is changed to Processed.</p>

Status	System Event	Algorithm	Algorithm Type	Description
Processing	Monitor	F1-AT-RQJ	F1-GEN-BOMNJ	<p>This algorithm transitions the current status to the specified status. You can specify the status to which you want the business object to transition in the following parameters:</p> <ul style="list-style-type: none"> • Next Status • Next Transition Condition <p>At a time, you can specify value for either the Next Status or Next Transition Condition parameter. If you don't specify any value for these parameters, the system will transition the business object to the default next status specified in its lifecycle.</p>

Algorithms Used in C1-RefundUploadRequest

The following table lists the algorithms which are used in the lifecycle of the **C1-RefundUploadRequest** business object:

Status	System Event	Algorithm	Algorithm Type	Description
Validated	Enter	C1-RF-VALID	C1-RF-VALID	This algorithm validates the data uploaded in an upload request for creating refund requests before the request is submitted for processing.
Draft	Enter	C1-RF-DERIV	C1-RF-DERIV	This algorithm reads the BO_DATA_AREA in the request's primary table, derives additional data that is required for creating refund requests and inserts the records in C1_UPLOAD_REQ_DTLS table.
Submitted	Enter	C1-UPLSUBENT	C1-UPLSUBENT	This algorithm is invoked when the user clicks the Submit button. It checks whether the approval is required for the upload request. If the approval is required for an upload request, the status of the upload request is changed to Approval In Progress . However, if the approval is not required for an upload request, the status of the upload request remains in the Submitted status.

Status	System Event	Algorithm	Algorithm Type	Description
Submitted	Enter	C1-DEFERUPLD	C1-DEFERUPLD	<p>This algorithm is invoked when the status of the upload request is changed to Submitted or Approved. It checks whether the upload request must be processed in the real time (i.e. immediately) or in the deferred mode (i.e. in the background). If the number of valid records in the upload request does not exceed the online record process limit, the system changes the status of the upload request to Processing. However, if the number of valid records in the upload request exceeds the online record process limit, the system changes the status of the upload request to Deferred Processing.</p> <p>It contains the following parameter:</p> <ul style="list-style-type: none"> • Online Record Process Limit <ul style="list-style-type: none"> – Used to indicate the maximum number of valid records you can process in the real time (i.e. immediately).
Submitted	Monitor	F1-AT-RQJ	F1-GEN-BOMNJ	<p>This algorithm transitions the current status to the specified status. You can specify the status to which you want the business object to transition in the following parameters:</p> <ul style="list-style-type: none"> • Next Status • Next Transition Condition <p>At a time, you can specify value for either the Next Status or Next Transition Condition parameter. If you don't specify any value for these parameters, the system will transition the business object to the default next status specified in its lifecycle.</p>
Approval In Progress	Enter	C1-UPLAPPENT	C1-UPLAPPENT	<p>This algorithm creates a To Do using the To Do type specified in the upload request type. The To Do is sent to the appropriate users with the To Do role which is specified in the upload request type. In addition, a log entry is added when a To Do is created using the To Do type.</p>

Status	System Event	Algorithm	Algorithm Type	Description
Approval In Progress	Exit	C1-UPLAPPEXT	C1-UPLAPPEXT	This algorithm checks whether the approver is associated with the approval To Do role specified in the upload request type. If not, it does not allow the approver to approve or reject the upload request. In addition, it does not allow the submitter to approve or reject the upload request.
Approval In Progress	Exit	F1-TODOCOMPL	F1-TODOCOMPL	This algorithm completes To Do entries that are created for the business object when the business object exits the given status. It finds and completes all open To Do entries where the business object's primary key is defined as a drill key. However, if the Exclude To Do Entries From Auto Completion characteristic is defined for the business object, then the system does not automatically complete the respective To Do entry.
Approved	Enter	C1-DEFERUPLD	C1-DEFERUPLD	<p>This algorithm is invoked when the status of the upload request is changed to Submitted or Approved. It checks whether the upload request must be processed in the real time (i.e. immediately) or in the deferred mode (i.e. in the background). If the number of valid records in the upload request does not exceed the online record process limit, the system changes the status of the upload request to Processing. However, if the number of valid records in the upload request exceeds the online record process limit, the system changes the status of the upload request to Deferred Processing.</p> <p>It contains the following parameter:</p> <ul style="list-style-type: none"> • Online Record Process Limit <ul style="list-style-type: none"> – Used to indicate the maximum number of valid records you can process in the real time (i.e. immediately).

Status	System Event	Algorithm	Algorithm Type	Description
Approved	Monitor	F1-AT-RQJ	F1-GEN-BOMNJ	<p>This algorithm transitions the current status to the specified status. You can specify the status to which you want the business object to transition in the following parameters:</p> <ul style="list-style-type: none"> • Next Status • Next Transition Condition <p>At a time, you can specify value for either the Next Status or Next Transition Condition parameter. If you don't specify any value for these parameters, the system will transition the business object to the default next status specified in its lifecycle.</p>
Deferred Processing	Monitor	F1-AT-RQJ	F1-GEN-BOMNJ	<p>This algorithm transitions the current status to the specified status. You can specify the status to which you want the business object to transition in the following parameters:</p> <ul style="list-style-type: none"> • Next Status • Next Transition Condition <p>At a time, you can specify value for either the Next Status or Next Transition Condition parameter. If you don't specify any value for these parameters, the system will transition the business object to the default next status specified in its lifecycle.</p>
Processing	Enter	C1-RF-PROC	C1-RF-PROC	<p>This algorithm fetches the list of records that are in Valid status for a given request ID and invokes the entity business object for creating the refund requests. If successfully processed, then the record status will be updated to Processed, otherwise the record status will be updated to Error and error details will be logged in the exception table.</p>

Status	System Event	Algorithm	Algorithm Type	Description
Processing	Monitor	F1-AT-RQJ	F1-GEN-BOMNJ	<p>This algorithm transitions the current status to the specified status. You can specify the status to which you want the business object to transition in the following parameters:</p> <ul style="list-style-type: none"> • Next Status • Next Transition Condition <p>At a time, you can specify value for either the Next Status or Next Transition Condition parameter. If you don't specify any value for these parameters, the system will transition the business object to the default next status specified in its lifecycle.</p>

Algorithms Used in C1-WriteOffUploadRequest

The following table lists the algorithms which are used in the lifecycle of the **C1-WriteOffUploadRequest** business object:

Status	System Event	Algorithm	Algorithm Type	Description
Draft	Enter	C1-WO-DERIV	C1-WO-DERIV	This algorithm reads the BO_DATA_AREA in the request's primary table, derives additional data that is required for creating write off requests and inserts the records in C1_UPLOAD_REQ_DTLS table.
Submitted	Enter	C1-UPLSUBENT	C1-UPLSUBENT	This algorithm is invoked when the user clicks the Submit button. It checks whether the approval is required for the upload request. If the approval is required for an upload request, the status of the upload request is changed to Approval In Progress . However, if the approval is not required for an upload request, the status of the upload request remains in the Submitted status.

Status	System Event	Algorithm	Algorithm Type	Description
Submitted	Enter	C1-DEFERUPLD	C1-DEFERUPLD	<p>This algorithm is invoked when the status of the upload request is changed to Submitted or Approved. It checks whether the upload request must be processed in the real time (i.e. immediately) or in the deferred mode (i.e. in the background). If the number of valid records in the upload request does not exceed the online record process limit, the system changes the status of the upload request to Processing. However, if the number of valid records in the upload request exceeds the online record process limit, the system changes the status of the upload request to Deferred Processing.</p> <p>It contains the following parameter:</p> <ul style="list-style-type: none"> • Online Record Process Limit <ul style="list-style-type: none"> – Used to indicate the maximum number of valid records you can process in the real time (i.e. immediately).
Submitted	Monitor	F1-AT-RQJ	F1-GEN-BOMNJ	<p>This algorithm transitions the current status to the specified status. You can specify the status to which you want the business object to transition in the following parameters:</p> <ul style="list-style-type: none"> • Next Status • Next Transition Condition <p>At a time, you can specify value for either the Next Status or Next Transition Condition parameter. If you don't specify any value for these parameters, the system will transition the business object to the default next status specified in its lifecycle.</p>
Approval In Progress	Enter	C1-UPLAPPENT	C1-UPLAPPENT	<p>This algorithm creates a To Do using the To Do type specified in the upload request type. The To Do is sent to the appropriate users with the To Do role which is specified in the upload request type. In addition, a log entry is added when a To Do is created using the To Do type.</p>

Status	System Event	Algorithm	Algorithm Type	Description
Approval In Progress	Exit	C1-UPLAPPEXT	C1-UPLAPPEXT	This algorithm checks whether the approver is associated with the approval To Do role specified in the upload request type. If not, it does not allow the approver to approve or reject the upload request. In addition, it does not allow the submitter to approve or reject the upload request.
Approval In Progress	Exit	F1-TODOCOMPL	F1-TODOCOMPL	This algorithm completes To Do entries that are created for the business object when the business object exits the given status. It finds and completes all open To Do entries where the business object's primary key is defined as a drill key. However, if the Exclude To Do Entries From Auto Completion characteristic is defined for the business object, then the system does not automatically complete the respective To Do entry.
Approved	Enter	C1-DEFERUPLD	C1-DEFERUPLD	<p>This algorithm is invoked when the status of the upload request is changed to Submitted or Approved. It checks whether the upload request must be processed in the real time (i.e. immediately) or in the deferred mode (i.e. in the background). If the number of valid records in the upload request does not exceed the online record process limit, the system changes the status of the upload request to Processing. However, if the number of valid records in the upload request exceeds the online record process limit, the system changes the status of the upload request to Deferred Processing.</p> <p>It contains the following parameter:</p> <ul style="list-style-type: none"> • Online Record Process Limit <ul style="list-style-type: none"> – Used to indicate the maximum number of valid records you can process in the real time (i.e. immediately).

Status	System Event	Algorithm	Algorithm Type	Description
Approved	Monitor	F1-AT-RQJ	F1-GEN-BOMNJ	<p>This algorithm transitions the current status to the specified status. You can specify the status to which you want the business object to transition in the following parameters:</p> <ul style="list-style-type: none"> • Next Status • Next Transition Condition <p>At a time, you can specify value for either the Next Status or Next Transition Condition parameter. If you don't specify any value for these parameters, the system will transition the business object to the default next status specified in its lifecycle.</p>
Deferred Processing	Monitor	F1-AT-RQJ	F1-GEN-BOMNJ	<p>This algorithm transitions the current status to the specified status. You can specify the status to which you want the business object to transition in the following parameters:</p> <ul style="list-style-type: none"> • Next Status • Next Transition Condition <p>At a time, you can specify value for either the Next Status or Next Transition Condition parameter. If you don't specify any value for these parameters, the system will transition the business object to the default next status specified in its lifecycle.</p>
Processing	Enter	C1-WO-PROC	C1-WO-PROC	<p>This algorithm fetches the list of records that are in Valid status for a given request ID and invokes the entity business object for creating the write off requests. If successfully processed, then the record status will be updated to Processed, otherwise the record status will be updated to Error and error details will be logged in the exception table.</p>

Status	System Event	Algorithm	Algorithm Type	Description
Processing	Monitor	F1-AT-RQJ	F1-GEN-BOMNJ	<p>This algorithm transitions the current status to the specified status. You can specify the status to which you want the business object to transition in the following parameters:</p> <ul style="list-style-type: none"> • Next Status • Next Transition Condition <p>At a time, you can specify value for either the Next Status or Next Transition Condition parameter. If you don't specify any value for these parameters, the system will transition the business object to the default next status specified in its lifecycle.</p>

Algorithms Used in C1-BillableChargeUploadRequest

The following table lists the algorithms which are used in the lifecycle of the **C1-BillableChargeUploadRequest** business object:

Status	System Event	Algorithm	Algorithm Type	Description
Draft	Enter	C1-CRTUPLDTL	C1-CRTUPLDTL	<p>This algorithm reads the data in the BO_DATA_AREA column of the C1_UPL_REQUEST table and accordingly inserts the records in the C1_UPLOAD_REQ_DTLS table. In addition, the status of each record in the C1_UPLOAD_REQ_DTLS table is set to Pending.</p>
Draft	Enter	C1-BC-DERIV	C1-BC-DERIV	<p>This algorithm reads the BO_DATA_AREA in the request's primary table, derives additional data that is required for creating billable charges and inserts the records in C1_UPLOAD_REQ_DTLS table.</p>
Validated	Enter	C1-BC-VALID	C1-BC-VALID	<p>This algorithm validates the data upload in an upload request for creating billable charges before the request is submitted for processing.</p>

Status	System Event	Algorithm	Algorithm Type	Description
Submitted	Enter	C1-UPLSUBENT	C1-UPLSUBENT	This algorithm is invoked when the user clicks the Submit button. It checks whether the approval is required for the upload request. If the approval is required for an upload request, the status of the upload request is changed to Approval In Progress . However, if the approval is not required for an upload request, the status of the upload request remains in the Submitted status.
Submitted	Enter	C1-DEFERUPLD	C1-DEFERUPLD	This algorithm is invoked when the status of the upload request is changed to Submitted or Approved . It checks whether the upload request must be processed in the real time (i.e. immediately) or in the deferred mode (i.e. in the background). If the number of valid records in the upload request does not exceed the online record process limit, the system changes the status of the upload request to Processing . However, if the number of valid records in the upload request exceeds the online record process limit, the system changes the status of the upload request to Deferred Processing . It contains the following parameter: <ul style="list-style-type: none"> • Online Record Process Limit <ul style="list-style-type: none"> – Used to indicate the maximum number of valid records you can process in the real time (i.e. immediately).
Submitted	Monitor	F1-AT-RQJ	F1-GEN-BOMNJ	This algorithm transitions the current status to the specified status. You can specify the status to which you want the business object to transition in the following parameters: <ul style="list-style-type: none"> • Next Status • Next Transition Condition At a time, you can specify value for either the Next Status or Next Transition Condition parameter. If you don't specify any value for these parameters, the system will transition the business object to the default next status specified in its lifecycle.

Status	System Event	Algorithm	Algorithm Type	Description
Approval In Progress	Enter	C1-UPLAPPENT	C1-UPLAPPENT	This algorithm creates a To Do using the To Do type specified in the upload request type. The To Do is sent to the appropriate users with the To Do role which is specified in the upload request type. In addition, a log entry is added when a To Do is created using the To Do type.
Approval In Progress	Exit	C1-UPLAPPEXT	C1-UPLAPPEXT	This algorithm checks whether the approver is associated with the approval To Do role specified in the upload request type. If not, it does not allow the approver to approve or reject the upload request. In addition, it does not allow the submitter to approve or reject the upload request.
Approval In Progress	Exit	F1-TODOCOMPL	F1-TODOCOMPL	This algorithm completes To Do entries that are created for the business object when the business object exits the given status. It finds and completes all open To Do entries where the business object's primary key is defined as a drill key. However, if the Exclude To Do Entries From Auto Completion characteristic is defined for the business object, then the system does not automatically complete the respective To Do entry.

Status	System Event	Algorithm	Algorithm Type	Description
Approved	Enter	C1-DEFERUPLD	C1-DEFERUPLD	<p>This algorithm is invoked when the status of the upload request is changed to Submitted or Approved. It checks whether the upload request must be processed in the real time (i.e. immediately) or in the deferred mode (i.e. in the background). If the number of valid records in the upload request does not exceed the online record process limit, the system changes the status of the upload request to Processing. However, if the number of valid records in the upload request exceeds the online record process limit, the system changes the status of the upload request to Deferred Processing.</p> <p>It contains the following parameter:</p> <ul style="list-style-type: none"> • Online Record Process Limit <ul style="list-style-type: none"> – Used to indicate the maximum number of valid records you can process in the real time (i.e. immediately).
Approved	Monitor	F1-AT-RQJ	F1-GEN-BOMNJ	<p>This algorithm transitions the current status to the specified status. You can specify the status to which you want the business object to transition in the following parameters:</p> <ul style="list-style-type: none"> • Next Status • Next Transition Condition <p>At a time, you can specify value for either the Next Status or Next Transition Condition parameter. If you don't specify any value for these parameters, the system will transition the business object to the default next status specified in its lifecycle.</p>

Status	System Event	Algorithm	Algorithm Type	Description
Deferred Processing	Monitor	F1-AT-RQJ	F1-GEN-BOMNJ	<p>This algorithm transitions the current status to the specified status. You can specify the status to which you want the business object to transition in the following parameters:</p> <ul style="list-style-type: none"> • Next Status • Next Transition Condition <p>At a time, you can specify value for either the Next Status or Next Transition Condition parameter. If you don't specify any value for these parameters, the system will transition the business object to the default next status specified in its lifecycle.</p>
Processing	Enter	C1-BC-PROC	C1-BC-PROC	<p>This algorithm fetches the list of records that are in Valid status for a given request ID and invokes the entity business object for creating billable charge on the contract. If successfully created, then the record status will be updated to Processed, otherwise the record status will be updated to Error and error details will be logged in the exception table.</p>
Processing	Monitor	F1-AT-RQJ	F1-GEN-BOMNJ	<p>This algorithm transitions the current status to the specified status. You can specify the status to which you want the business object to transition in the following parameters:</p> <ul style="list-style-type: none"> • Next Status • Next Transition Condition <p>At a time, you can specify value for either the Next Status or Next Transition Condition parameter. If you don't specify any value for these parameters, the system will transition the business object to the default next status specified in its lifecycle.</p>

Algorithms Used in C1-ReinstatementUploadRequest

The following table lists the algorithms which are used in the lifecycle of the **C1-ReinstatementUploadRequest** business object:

Status	System Event	Algorithm	Algorithm Type	Description
Draft	Enter	C1-CRTUPLDTL	C1-CRTUPLDTL	This algorithm reads the data in the BO_DATA_AREA column of the C1_UPL_REQUEST table and accordingly inserts the records in the C1_UPLOAD_REQ_DTLS table. In addition, the status of each record in the C1_UPLOAD_REQ_DTLS table is set to Pending .
Draft	Enter	C1-REN-DERIV	C1-REN-DERIV	This algorithm reads the data in the BO_DATA_AREA column of the C1_UPLOAD_REQ_DTLS table and then derives the policy ID using the source system and policy number combination whenever the policy ID is not specified in the record. Once the policy ID is derived, the corresponding record is updated in the C1_UPLOAD_REQ_DTLS table. If the system could not derive the policy ID using the source system and policy number combination, the status of the record in the C1_UPLOAD_REQ_DTLS table is changed to Invalid .

Status	System Event	Algorithm	Algorithm Type	Description
Validated	Enter	C1-REN-VALID	C1-REN-VALID	<p>This algorithm is invoked when the user clicks the Validate button. It validates the records which are in the Pending status. It checks whether the policy ID and reinstatement reason specified in the record is valid. If the policy ID and reinstatement reason are valid, the status of the record in the C1_UPLOAD_REQ_DTLS table is changed to Valid.</p> <p>If the policy ID is invalid, it derives the policy ID using the source system and policy number combination and updates the record accordingly. In addition, it changes the status of the record in the C1_UPLOAD_REQ_DTLS table to Valid. However, if the system could not derive the policy ID using the source system and policy number combination, or if the reinstatement reason is invalid, the status of the record in the C1_UPLOAD_REQ_DTLS table is changed to Invalid.</p> <p>It also checks whether there are two or more policies with the same policy ID. If so, it validates and changes the status of one record to Valid and the status of the remaining records is changed to Invalid. It contains the following parameters:</p> <ul style="list-style-type: none"> • Policy Status after Processing Reinstatement Upload Request – Used to specify the status to which you want to transition the policy when the reinstatement upload request is processed. • Policy Reinstatement Status for Reason Verification – Used to validate the reinstatement reason. The reason should be a valid reason for the specified status.

Status	System Event	Algorithm	Algorithm Type	Description
Submitted	Monitor	F1-AT-RQJ	F1-GEN-BOMNJ	<p>This algorithm transitions the current status to the specified status. You can specify the status to which you want the business object to transition in the following parameters:</p> <ul style="list-style-type: none"> • Next Status • Next Transition Condition <p>At a time, you can specify value for either the Next Status or Next Transition Condition parameter. If you don't specify any value for these parameters, the system will transition the business object to the default next status specified in its lifecycle.</p>
Submitted	Enter	C1-UPLSUBENT	C1-UPLSUBENT	<p>This algorithm is invoked when the user clicks the Submit button. It checks whether the approval is required for the upload request. If the approval is required for an upload request, the status of the upload request is changed to Approval In Progress. However, if the approval is not required for an upload request, the status of the upload request remains in the Submitted status.</p>
Submitted	Enter	C1-DEFERUPLD	C1-DEFERUPLD	<p>This algorithm is invoked when the status of the upload request is changed to Submitted or Approved. It checks whether the upload request must be processed in the real time (i.e. immediately) or in the deferred mode (i.e. in the background). If the number of valid records in the upload request does not exceed the online record process limit, the system changes the status of the upload request to Processing. However, if the number of valid records in the upload request exceeds the online record process limit, the system changes the status of the upload request to Deferred Processing.</p> <p>It contains the following parameter:</p> <ul style="list-style-type: none"> • Online Record Process Limit – Used to indicate the maximum number of valid records you can process in the real time (i.e. immediately).
Approval In Progress	Enter	C1-UPLAPPENT	C1-UPLAPPENT	<p>This algorithm creates a To Do using the To Do type specified in the upload request type. The To Do is sent to the appropriate users with the To Do role which is specified in the upload request type. In addition, a log entry is added when a To Do is created using the To Do type.</p>

Status	System Event	Algorithm	Algorithm Type	Description
Approval In Progress	Exit	C1-UPLAPPEXT	C1-UPLAPPEXT	This algorithm checks whether the approver is associated with the approval To Do role specified in the upload request type. If not, it does not allow the approver to approve or reject the upload request. In addition, it does not allow the submitter to approve or reject the upload request.
Approval In Progress	Exit	F1-TODOCOMPL	F1-TODOCOMPL	This algorithm completes To Do entries that are created for the business object when the business object exits the given status. It finds and completes all open To Do entries where the business object's primary key is defined as a drill key. However, if the Exclude To Do Entries From Auto Completion characteristic is defined for the business object, then the system does not automatically complete the respective To Do entry.
Approved	Enter	C1-DEFERUPLD	C1-DEFERUPLD	<p>This algorithm is invoked when the status of the upload request is changed to Submitted or Approved. It checks whether the upload request must be processed in the real time (i.e. immediately) or in the deferred mode (i.e. in the background). If the number of valid records in the upload request does not exceed the online record process limit, the system changes the status of the upload request to Processing. However, if the number of valid records in the upload request exceeds the online record process limit, the system changes the status of the upload request to Deferred Processing.</p> <p>It contains the following parameter:</p> <ul style="list-style-type: none"> • Online Record Process Limit – Used to indicate the maximum number of valid records you can process in the real time (i.e. immediately).

Status	System Event	Algorithm	Algorithm Type	Description
Approved	Monitor	F1-AT-RQJ	F1-GEN-BOMNJ	<p>This algorithm transitions the current status to the specified status. You can specify the status to which you want the business object to transition in the following parameters:</p> <ul style="list-style-type: none"> • Next Status • Next Transition Condition <p>At a time, you can specify value for either the Next Status or Next Transition Condition parameter. If you don't specify any value for these parameters, the system will transition the business object to the default next status specified in its lifecycle.</p>
Deferred Processing	Monitor	F1-AT-RQJ	F1-GEN-BOMNJ	<p>This algorithm transitions the current status to the specified status. You can specify the status to which you want the business object to transition in the following parameters:</p> <ul style="list-style-type: none"> • Next Status • Next Transition Condition <p>At a time, you can specify value for either the Next Status or Next Transition Condition parameter. If you don't specify any value for these parameters, the system will transition the business object to the default next status specified in its lifecycle.</p>
Processing	Monitor	F1-AT-RQJ	F1-GEN-BOMNJ	<p>This algorithm transitions the current status to the specified status. You can specify the status to which you want the business object to transition in the following parameters:</p> <ul style="list-style-type: none"> • Next Status • Next Transition Condition <p>At a time, you can specify value for either the Next Status or Next Transition Condition parameter. If you don't specify any value for these parameters, the system will transition the business object to the default next status specified in its lifecycle.</p>

Status	System Event	Algorithm	Algorithm Type	Description
Processing	Enter	C1-REN-PROC	C1-REN-PROC	<p>This algorithm fetches a list of records which are in the Valid status. For each valid record, the system reads the policy ID and reinstatement reason, and reinstates the policy using the entity business object defined in the upload request type. On reinstating the policy, the status of the policy is changed as mentioned in this algorithm. If the record is successfully processed, the status of the record is changed to Processed. However, if the record could not be processed successfully due to any reason, the status of the record is changed to Error. Finally, the status of the upload request is changed to Processed.</p> <p>It contains the following parameter:</p> <ul style="list-style-type: none"> • Policy Status after Processing Reinstatement Upload Request - Used to specify the status to which you want to transition the policy when the reinstatement upload request is processed.

Algorithms Used in C1-BillGrpSortUploadRequest

The following table lists the algorithms which are used in the lifecycle of the **C1-BillGrpSortUploadRequest** business object:

Status	System Event	Algorithm	Algorithm Type	Description
Draft	Enter	C1-BLSRTUPLD	C1-BLSRTUPLD	Refer to C1-BLSRTUPLD on page 1937.
Draft	Enter	C1-BLSRTDERV	C1-BLSRTDERV	Refer to C1-BLSRTDERV on page 1937.
Validated	Enter	C1-BLSRTVALD	C1-BLSRTVALD	Refer to C1-BLSRTVALD on page 1937.
Canceled	—	—	—	—
Submitted	Monitor	F1-AT-RQJ	F1-GEN-BOMNJ	Refer to F1-AT-RQJ on page 1567.
Submitted	Enter	C1-UPLSUBENT	C1-UPLSUBENT	Refer to C1-UPLSUBENT on page 1938.
Submitted	Enter	C1-DEFERUPLD	C1-DEFERUPLD	Refer to C1-DEFERUPLD on page 1938.
Approval In Progress	Enter	C1-UPLAPPENT	C1-UPLAPPENT	Refer to C1-UPLAPPENT on page 1938.
Approval In Progress	Exit	C1-UPLAPPEXT	C1-UPLAPPEXT	Refer to C1-UPLAPPEXT on page 1938.

Status	System Event	Algorithm	Algorithm Type	Description
Approval In Progress	Exit	F1-TODOCOMPL	F1-TODOCOMPL	Refer to F1-TODOCOMPL on page 1566.
Approved	Monitor	F1-AT-RQJ	F1-GEN-BOMNJ	Refer to F1-AT-RQJ on page 1567.
Approved	Enter	C1-DEFERUPLD	C1-DEFERUPLD	Refer to C1-DEFERUPLD on page 1938.
Rejected	—	—	—	—
Deferred Processing	Monitor	F1-AT-RQJ	F1-GEN-BOMNJ	Refer to F1-AT-RQJ on page 1567.
Processing	Monitor	F1-AT-RQJ	F1-GEN-BOMNJ	Refer to F1-AT-RQJ on page 1567.
Processing	Enter	C1-BLSRTPROC	C1-BLSRTPROC	Refer to C1-BLSRTPROC on page 1939.
Processed	—	—	—	—

C1-BLSRTUPLD

This algorithm reads the data in the **BO_DATA_AREA** column of the **C1_UPL_REQUEST** table and accordingly inserts the records in the **C1_UPLOAD_REQ_DTLS** table. In addition, the status of each record in the **C1_UPLOAD_REQ_DTLS** table is set to **Pending**.

C1-BLSRTDERV

This algorithm reads the data in the **BO_DATA_AREA** column of the **C1_UPLOAD_REQ_DTLS** table and then derives the bill group (person) ID using the bill group (person) identifier type and bill group (person) identifier combination whenever the bill group ID is not specified in the record. Once the bill group ID is derived, the corresponding record is updated in the **C1_UPLOAD_REQ_DTLS** table. If the system could not derive the bill group ID using the bill group identifier type and bill group identifier combination, the status of the record in the **C1_UPLOAD_REQ_DTLS** table is changed to **Invalid**.

C1-BLSRTVALD

This algorithm is invoked when the user clicks the **Validate** button. It validates the records which are in the **Pending** status. It checks the following:

- The parent customer's person type is set to **Parent Customer** in the system.
- All mandatory information is available in the bill group sort record.
- The end date is not earlier than the start date and the start date is not later than the end date.
- Either the bill group (person) identifier type and bill group (person) identifier or the bill group (person) ID is available in the bill group sort record.
- The bill group identifier type is available when the bill group identifier is specified and vice versa.
- A bill group with the specified bill group ID exists in the system.
- The bill group is the child person of the parent customer.
- The bill group's person type is set to **Bill Group** in the system.
- The relationship between the bill group and parent customer is effective on the system date.
- The bill group is related to the parent customer using a relationship type which is specified in the **Person Relationship Type** option type of the **C1-ASOBLNG** feature configuration.
- A duplicate record with the bill group ID and sort ID combination does not exist in the **C1_BILL_LVL** table.

- A duplicate record with the bill group ID and sort ID combination does not exist in the **C1_UPLOAD_REQ_DTLS** table.

If the above mentioned validations are successful, the status of the record in the **C1_UPLOAD_REQ_DTLS** table is changed to **Valid**. However, if any of the above validation fails, the status of the record in the **C1_UPLOAD_REQ_DTLS** table is changed to **Invalid**.

F1-AT-RQJ

This algorithm transitions the current status of the business object to the specified status. It contains the following parameters:

- **Next Status** – Used when you want to override the default next status specified in the lifecycle.
- **Next Transition Condition** – Used when you want to override the default next transition condition specified in the lifecycle.

At a time, you can specify value for either the **Next Status** or **Next Transition Condition** parameter. If you don't specify any value for these parameters, the system will transition the business object to the default next status specified in its lifecycle.

C1-UPLSUBENT

This algorithm is invoked when the user clicks the **Submit** button. It checks whether the approval is required for the upload request. If the approval is required for an upload request, the status of the upload request is changed to **Approval In Progress**. However, if the approval is not required for an upload request, the status of the upload request remains in the **Submitted** status.

C1-DEFERUPLD

This algorithm is invoked when the status of the upload request is changed to **Submitted** or **Approved**. It checks whether the upload request must be processed in the real time (i.e. immediately) or in the deferred mode (i.e. in the background). If the number of valid records in the upload request does not exceed the online record process limit, the system changes the status of the upload request to **Processing**. However, if the number of valid records in the upload request exceeds the online record process limit, the system changes the status of the upload request to **Deferred Processing**.

It contains the following parameter:

- **Online Record Process Limit** – Used to indicate the maximum number of valid records you can process in the real time (i.e. immediately).

C1-UPLAPPENT

This algorithm creates a To Do using the To Do type specified in the upload request type. The To Do is sent to the appropriate users with the To Do role which is specified in the upload request type. In addition, a log entry is added when a To Do is created using the To Do type.

C1-UPLAPPEXT

This algorithm checks whether the approver is associated with the approval To Do role specified in the upload request type. If not, it does not allow the approver to approve or reject the upload request. In addition, it does not allow the submitter to approve or reject the upload request.

F1-TODOCOMPL

This algorithm completes To Do entries that are created for the business object when the business object exits the given status. It finds and completes all open To Do entries where the business object's primary key is defined as a drill key. However, if the **Exclude To Do Entries From Auto Completion** characteristic is set to **Y** for the business object, the system does not automatically complete the respective To Do entry.

C1-BLSRTPROC

This algorithm fetches a list of records which are in the **Valid** status. For each valid record with a unique combination of the bill group (person) ID and sort ID, it creates one bill group sort record using the entity business object defined in the upload request type. If the record is successfully processed, the status of the record is changed to **Processed**. However, if the record could not be processed successfully due to any reason, the status of the record is changed to **Error**. Finally, the status of the upload request is changed to **Processed**.

Algorithms Used in C1-BillLevelUploadRequest

The following table lists the algorithms which are used in the lifecycle of the **C1-BillLevelUploadRequest** business object:

Status	System Event	Algorithm	Algorithm Type	Description
Draft	Enter	C1-BLVUPLDTL	C1-BLVUPLDTL	Refer to C1-BLVUPLDTL on page 1940.
Draft	Enter	C1-BLVLDERIV	C1-BLVLDERIV	Refer to C1-BLVLDERIV on page 1940.
Validated	Enter	C1-BLVLVALID	C1-BLVLVALID	Refer to C1-BLVLVALID on page 1940.
Canceled	—	—	—	—
Submitted	Monitor	F1-AT-RQJ	F1-GEN-BOMNJ	Refer to F1-AT-RQJ on page 1567.
Submitted	Enter	C1-UPLSUBENT	C1-UPLSUBENT	Refer to C1-UPLSUBENT on page 1938.
Submitted	Enter	C1-DEFERUPLD	C1-DEFERUPLD	Refer to C1-DEFERUPLD on page 1938.
Approval Progress	In Enter	C1-UPLAPPENT	C1-UPLAPPENT	Refer to C1-UPLAPPENT on page 1938.
Approval Progress	In Exit	C1-UPLAPPEXT	C1-UPLAPPEXT	Refer to C1-UPLAPPEXT on page 1938.
Approval Progress	In Exit	F1-TODOCOMPL	F1-TODOCOMPL	Refer to F1-TODOCOMPL on page 1566.
Approved	Monitor	F1-AT-RQJ	F1-GEN-BOMNJ	Refer to F1-AT-RQJ on page 1567.
Approved	Enter	C1-DEFERUPLD	C1-DEFERUPLD	Refer to C1-DEFERUPLD on page 1938.
Rejected	—	—	—	—
Deferred Processing	Monitor	F1-AT-RQJ	F1-GEN-BOMNJ	Refer to F1-AT-RQJ on page 1567.
Processing	Monitor	F1-AT-RQJ	F1-GEN-BOMNJ	Refer to F1-AT-RQJ on page 1567.
Processing	Enter	C1-BLVLVLPRO	C1-BLVLVLPRO	Refer to C1-BLVLVLPRO on page 1941.
Processed	—	—	—	—

C1-BLVUPLDTL

This algorithm reads the data in the **BO_DATA_AREA** column of the **C1_UPL_REQUEST** table and accordingly inserts the records in the **C1_UPLOAD_REQ_DTLS** table. In addition, the status of each record in the **C1_UPLOAD_REQ_DTLS** table is set to **Pending**.

C1-BLVLDERIV

This algorithm reads the data in the **BO_DATA_AREA** column of the **C1_UPLOAD_REQ_DTLS** table and then derives the bill group (person) ID using the bill group (person) identifier type and bill group (person) identifier combination whenever the bill group ID is not specified in the record. Once the bill group ID is derived, the corresponding record is updated in the **C1_UPLOAD_REQ_DTLS** table. If the system could not derive the bill group ID using the bill group identifier type and bill group identifier combination, the status of the record in the **C1_UPLOAD_REQ_DTLS** table is changed to **Invalid**.

C1-BLVLVALID

This algorithm is invoked when the user clicks the **Validate** button. It validates the records which are in the **Pending** status. It checks the following:

- The parent customer's person type is set to **Parent Customer** in the system.
- All mandatory information is available in the bill group derivation and pricing parameters record.
- Either the bill group (person) identifier type and bill group (person) identifier or the bill group (person) ID is available in the bill group derivation and pricing parameters record.
- The bill group identifier type is available when the bill group identifier is specified and vice versa.
- The number of characters specified in each field does not exceed the maximum field length.
- A bill group with the specified bill group ID exists in the system.
- The bill group is the child person of the parent customer.
- The bill group's person type is set to **Bill Group** in the system.
- The relationship between the bill group and parent customer is effective on the system date.
- The bill group is related to the parent customer using the relationship type which is specified in the **Person Relationship Type** option type of the **C1-ASOBLLNG** feature configuration.
- A duplicate record with the source system, parameter 1, parameter 2, parameter 3, parameter 4, and effective date combination does not exist in the **C1_BILL_LVL** table.
- A duplicate record with the source system, parameter 1, parameter 2, parameter 3, parameter 4, and effective date combination does not exist in the **C1_UPLOAD_REQ_DTLS** table.
- The source system exists in the extendable lookup which is specified in the **Source System Extendable Lookup** parameter.
- The bill group sort record with the bill group ID and sort ID combination already exists in the system.
- The effective date specified in the record is within the date range of the effective bill group sort record.

If the above mentioned validations are successful, the status of the record in the **C1_UPLOAD_REQ_DTLS** table is changed to **Valid**. However, if any of the above validation fails, the status of the record in the **C1_UPLOAD_REQ_DTLS** table is changed to **Invalid**.

It contains the following parameter:

- **Source System Extendable Lookup** – Used to specify the source system extendable lookup business object. The bill group derivation and pricing parameters records should contain the source system which is already defined in this extendable lookup.

F1-AT-RQJ

This algorithm transitions the current status of the business object to the specified status. It contains the following parameters:

- **Next Status** – Used when you want to override the default next status specified in the lifecycle.
- **Next Transition Condition** – Used when you want to override the default next transition condition specified in the lifecycle.

At a time, you can specify value for either the **Next Status** or **Next Transition Condition** parameter. If you don't specify any value for these parameters, the system will transition the business object to the default next status specified in its lifecycle.

C1-UPLSUBENT

This algorithm is invoked when the user clicks the **Submit** button. It checks whether the approval is required for the upload request. If the approval is required for an upload request, the status of the upload request is changed to **Approval In Progress**. However, if the approval is not required for an upload request, the status of the upload request remains in the **Submitted** status.

C1-DEFERUPLD

This algorithm is invoked when the status of the upload request is changed to **Submitted** or **Approved**. It checks whether the upload request must be processed in the real time (i.e. immediately) or in the deferred mode (i.e. in the background). If the number of valid records in the upload request does not exceed the online record process limit, the system changes the status of the upload request to **Processing**. However, if the number of valid records in the upload request exceeds the online record process limit, the system changes the status of the upload request to **Deferred Processing**.

It contains the following parameter:

- **Online Record Process Limit** – Used to indicate the maximum number of valid records you can process in the real time (i.e. immediately).

C1-UPLAPPENT

This algorithm creates a To Do using the To Do type specified in the upload request type. The To Do is sent to the appropriate users with the To Do role which is specified in the upload request type. In addition, a log entry is added when a To Do is created using the To Do type.

C1-UPLAPPEXT

This algorithm checks whether the approver is associated with the approval To Do role specified in the upload request type. If not, it does not allow the approver to approve or reject the upload request. In addition, it does not allow the submitter to approve or reject the upload request.

F1-TODOCOMPL

This algorithm completes To Do entries that are created for the business object when the business object exits the given status. It finds and completes all open To Do entries where the business object's primary key is defined as a drill key. However, if the **Exclude To Do Entries From Auto Completion** characteristic is set to **Y** for the business object, the system does not automatically complete the respective To Do entry.

C1-BLVLVLPRO

This algorithm fetches a list of records which are in the **Valid** status. For each valid record with a unique combination of the source system, parameter 1, parameter 2, parameter 3, parameter 4, and effective date, it creates one bill group derivation and pricing parameters record using the entity business object defined in the upload request type. If the record

is successfully processed, the status of the record is changed to **Processed**. However, if the record could not be processed successfully due to any reason, the status of the record is changed to **Error**. Finally, the status of the upload request is changed to **Processed**.

CSV File Format for Account Bill Cycle Upload Request

Before uploading the account bill cycle file, you need to ensure that the CSV file contains the following columns:

Column Name	Description	Mandatory (Yes or No)
Account Identifier Type	Used to specify the account identifier type.	Yes (Conditional) Note: This data is required when the account ID is not specified.
Account Identifier	Used to specify the identifier of the account whose bill cycle you want to update.	Yes (Conditional) Note: This data is required when the account ID is not specified.
Account ID	Used to indicate the account whose bill cycle you want to update. Note: If you do not specify the account ID, the system derives the account ID using the account identifier type and account identifier combination.	No
Bill Cycle	Used to specify the bill cycle. Note: You must specify a valid bill cycle which is associated with the division to which the account belongs.	Yes

CSV File Format for Contract Rider Upload Request

Before uploading a contract rider file, you need to ensure that the CSV file contains the following columns:

Column Name	Description	Mandatory (Yes or No)
Account Identifier Type	Used to specify the account identifier type.	Yes (Conditional) Note: This data is required when the account ID and contract ID are not specified.
Account Identifier	Used to specify the identifier of the account whose contract you want to update.	Yes (Conditional) Note: This data is required when the account ID and contract ID are not specified.

Column Name	Description	Mandatory (Yes or No)
Account ID	Used to indicate the account whose contract you want to update.	Yes (Conditional)
		Note: This data is required when the account identifier type, account identifier, and contract ID are not specified.
Contract Type	Used to indicate the type of the contract whose details you want to update.	Yes (Conditional)
	Note: You must specify a contract type which already exists in the system.	Note: This data is required when the contract ID is not specified.
Contract ID	Used to indicate the contract whose contract rider information you want to update.	No
	Note: If you do not specify the contract ID, the system derives the active contract using the account ID and contract type combination.	
Start Date	Used to specify the date from when the bill factor is effective for the contract.	Yes
	Note: The start date cannot be later than the end date.	
End Date	Used to specify the date till when the bill factor is effective for the contract.	No
	Note: The end date cannot be earlier than the start date.	
Bill Factor	Used to specify the bill factor.	Yes
	Note: You must specify a valid bill factor where the Contract Rider Applicability flag is set to Y .	

CSV File Format for Billable Charge Upload

Before uploading a billable charge file, you need to ensure that the CSV file contains the following columns:

Column Name	Description	Mandatory (Yes or No)
Account Identifier Type	Used to specify the account identifier type.	Yes (Conditional)
		Note: This data is required when the Account ID is not specified.

Column Name	Description	Mandatory (Yes or No)
Account Identifier	Used to specify the account identifier of the account for which you want to create the billable charge.	Yes (Conditional) Note: This data is required when the Account ID is not specified.
Account ID	Used to specify the account for which you want to create the billable charge.	Yes (Conditional) Note: This data is required when the Account Identifier Type and Account Identifier is not specified.
Contract ID	Used to specify the contract against which you want to create the billable charge.	Yes (Conditional) Note: This data is required when you want to create the billable charge against a specific contract on the account. If this data is not specified then billable charge is created against a contract with highest priority.
Start Date	Used to specify the start date of billable charge.	Yes
End Date	Used to specify the end date of billable charge.	Yes
Charge Type	Used to specify the charge type for which you want to create a billable charge.	No
Description On Bill	Used to specify description for a billable charge.	Yes
Recurring Flag	Used to indicate whether recurring bill segments must be created at the intervals defined in the bill period or at the set policy invoice frequency. The valid values are: <ul style="list-style-type: none"> • BP • FR 	Yes (Conditional) Note: This data is required if Frequency or Bill Period is specified.
Frequency	Used to specify the invoice frequency at which the recurring bill segments must be created.	Yes (Conditional) Note: This data is required if Recurring Flag is FR.
Bill Period	Used to specify the bill period that you want to use for specifying the intervals at which the recurring bill segments must be created.	Yes (Conditional) Note: This data is required if Recurring Flag is BP.
Bill After	Used to specify the date after which the bill must be generated for the billable charge.	No
Adhoc Bill	Used to indicate whether the billable charge should be considered during adhoc or regular billing.	No

Column Name	Description	Mandatory (Yes or No)
Description on Bill1, Description on Bill2,, Description on Bill5	Used to specify description for the billable charge lines.	Yes (Conditional)
		Note: This data is required when the charge amount is specified.
Currency1, Currency2,, Currency5	Used to specify the currency in which the amount is charged. Note: If you specify a currency other than the account's invoice currency, the system will do the currency conversion if the appropriate exchange rate is available in the system.	Yes (Conditional)
		Note: This data is required when the charge amount is specified.
Amount1, Amount2,, Amount5	Used to specify the charge amount.	Yes (Conditional)
		Note: This data is required when the description on bill or currency is specified.
Show On Bill1, Show on Bill2,, Show On Bill5	Used to indicate whether the charge should appear on the person's printed bill or not. The valid values are: <ul style="list-style-type: none"> • true • false 	No
Summary1, Summary2,, Summary5	Used to indicate whether the charge should be included in the summary line or not. The valid value are: <ul style="list-style-type: none"> • true • false 	No
Memo Only1, Memo Only2,, Memo Only5	Used to indicate whether the charge should be included in the bill amount or not. The valid values are: <ul style="list-style-type: none"> • true • false 	No

Column Name	Description	Mandatory (Yes or No)
GL Distribution Code1, GL Distribution Code2,, GL distribution Code5	Used to specify the distribution code which indicates the GL account associated with the charge.	Yes (Conditional) Note: This data is required when false is specified in the Memo Only column corresponding to the bill line description.
Price Item	Used to specify the price item code.	Yes (Conditional) Note: This data is required when Variance Parameter or, Price Item Parameter and Price Item Parameter Value is specified.
Variance Parameter	Used to indicate the variance that must be used along with the price item for determining the price item pricing.	Yes (Conditional) Note: This data is required when Price Item is specified and Price Item Parameter and Price Item Parameter Value are not specified.
Price Item Parameter1, Price Item Parameter2,, Price Item Parameter15	Used to indicate the price item parameter that must be used along with the price item for determining the price item pricing. Note: If the data in these columns will be used for price item parameter mapping, you must not use the equal to (=) and tilde (~) symbols in these columns.	Yes (Conditional) Note: This data is required when Price Item is specified and Variance Parameter is not specified.
Price Item Parameter Value1, Price Item Parameter Value2,, Price Item Parameter Value15	Used to specify the parameter value. Note: If the data in these columns will be used for price item parameter mapping, you must not use the equal to (=) and tilde (~) symbols in these columns.	Yes (Conditional) Note: This data is required when Price Item is specified and Variance Parameter is not specified.
SQI1, SQI2,, SQI5	Used to indicate the service quantity identifier that must be used for calculating the price item charges.	Yes (Conditional) Note: This data is required when the service quantity is specified.
SQI Value1, SQI Value2,, SQI Value5	Used to specify the number of units of the service quantity.	Yes (Conditional) Note: This data is required when the SQI is specified.

Column Name	Description	Mandatory (Yes or No)
Effective Date1, Effective Date2,, Effective Date20	Used to indicate the effective date of the characteristics.	Yes (Conditional) Note: This data is required when Char Type or Char Val is specified.
Char Type1, Char Type2,, Char Type20	Used to indicate the characteristic that must be defined for the billable charge.	Yes (Conditional) Note: This data is required when Effective Date or Char Val is specified.
Char Value1, Char Value2,, Char Value20	Used to specify the value of the characteristic type.	Yes (Conditional) Note: This data is required when Effective Date or Char Type is specified.

CSV File Format for Hold Upload Request

Before uploading a hold request file, you need to ensure that the CSV file contains the following columns:

Column Name	Description	Mandatory (Yes or No)
Hold Request Type	Used to specify the hold request type. Note: You must specify a valid hold request type which is in the Active status.	Yes
Start Date	Used to specify the date from when the hold request is effective. Note: The hold request start date cannot be later than the hold request end date.	Yes
End Date	Used to specify the date till when the hold request is effective. Note: The hold request end date cannot be earlier than the hold request start date.	Yes
Hold Reason	Used to indicate the reason why you want to hold the entity. Note: The hold reason must exist in the HOLD_REASON_FLG lookup field and its status must be Active .	Yes

Column Name	Description	Mandatory (Yes or No)
Hold Entity	Used to indicate the type of the entity for which you want to create the hold request. The valid values are: <ul style="list-style-type: none"> • ACCT • BILL • PERS 	Yes
Account Identifier Type	Used to specify the account identifier type.	Yes (Conditional) Note: This data is required when the hold entity is ACCT and the entity ID is not specified.
Account Identifier	Used to specify the identifier of the account for which you want to create the hold request.	Yes (Conditional) Note: This data is required when the hold entity is ACCT and the entity ID is not specified.
Person Identifier Type	Used to specify the person identifier type.	Yes (Conditional) Note: This data is required when the hold entity is PERS and the entity ID is not specified.
Person Identifier	Used to specify the identifier of the person for which you want to create the hold request.	Yes (Conditional) Note: This data is required when the hold entity is PERS and the entity ID is not specified.
Hold Entity ID	Used to specify the entity ID. Note: If the hold entity is ACCT , you must specify the account ID in this field. If the hold entity is PERS , you must specify the person ID in this field. And, if the hold entity is BILL , you must specify the bill ID in this field. If you do not specify the account ID, the system derives the account ID using the account identifier type and account identifier combination. Similarly, if you do not specify the person ID, the system derives the person ID using the person identifier type and person identifier combination.	Yes (Conditional) Note: This data is required when the hold entity is BILL .
Comments	Used to specify additional information about the hold request.	No

Column Name	Description	Mandatory (Yes or No)
Hold Entity Start Date	Used to specify the date from when you want to hold the entity.	Yes
	<p>Note:</p> <p>The hold entity start date must be between the hold request start and end dates and between at least one process's start and end dates.</p> <p>The hold entity start date cannot be later than the hold entity end date.</p>	
Hold Entity End Date	Used to specify the date till when you want to hold the entity.	No
	<p>Note:</p> <p>The hold entity end date must be between hold request start and end dates and between the process's start and end dates.</p> <p>The hold entity end date cannot be earlier than the hold entity start date.</p>	
Hold Funding	Used to indicate whether you want to hold the funding process for the entity. The valid values are:	No
	<ul style="list-style-type: none"> • Y • N <p>Note: You can hold the funding process when the hold entity is PERS or BILL.</p>	
Hold Funding Start Date	Used to specify the date from when you want to hold the funding process.	Yes (Conditional)
	<p>Note:</p> <p>The hold funding start date must be between the hold request start and end dates.</p> <p>The hold funding start date cannot be later than the hold funding end date.</p>	
Hold Funding End Date	Used to specify the date till when you want to hold the funding process.	No
	<p>Note:</p> <p>The hold funding end date must be between the hold request start and end dates.</p> <p>The hold funding end date cannot be earlier than the hold funding start date.</p>	

Column Name	Description	Mandatory (Yes or No)
Hold Overdue	Used to indicate whether you want to hold the overdue process for the entity. The valid values are: <ul style="list-style-type: none"> • Y • N 	No
Hold Overdue Start Date	Used to specify the date from when you want to hold the overdue process. Note: The hold overdue start date must be between the hold request start and end dates. The hold overdue start date cannot be later than the hold overdue end date.	Yes (Conditional) Note: This data is required when the overdue process must be kept on hold.
Hold Overdue End Date	Used to specify the date till when you want to hold the overdue process. Note: The hold overdue end date must be between the hold request start and end dates. The hold overdue end date cannot be earlier than the hold overdue start date.	No
Hold Bill Generation	Used to indicate whether you want to hold the bill generation process for the entity. The valid values are: <ul style="list-style-type: none"> • Y • N 	No
Hold Bill Generation Start Date	Used to specify the date from when you want to hold the bill generation process. Note: The hold bill generation start date must be between the hold request start and end dates. The hold bill generation start date cannot be later than the hold bill generation end date.	Yes (Conditional) Note: This data is required when the bill generation process must be kept on hold.
Hold Bill Generation End Date	Used to specify the date till when you want to hold the bill generation process. Note: The hold bill generation end date must be between the hold request start and end dates. The hold bill generation end date cannot be earlier than the hold bill generation start date.	No

Column Name	Description	Mandatory (Yes or No)
Hold Auto Pay	Used to indicate whether you want to hold the automatic payment process for the entity. The valid values are: <ul style="list-style-type: none"> • Y • N 	No
Hold Autopay Start Date	Used to specify the date from when you want to hold the automatic payment process. <p>Note: The hold autopay start date must be between the hold request start and end dates. The hold autopay start date cannot be later than the hold autopay end date.</p>	Yes (Conditional) Note: This data is required when the automatic payment process must be kept on hold.
Hold Autopay End Date	Used to specify the date till when you want to hold the automatic payment process. <p>Note: The hold autopay end date must be between the hold request start and end dates. The hold autopay end date cannot be earlier than the hold autopay start date.</p>	No
Effective Date1, Effective Date2,, Effective Date5	Used to specify the date from when the characteristic is effective for the hold request.	Yes (Conditional) Note: This data is required when the characteristic type or characteristic value is specified.
Char Type1, Char Type2,, Char Type5	Used to indicate the characteristic that must be defined for the hold request. <p>Note: You must specify a characteristic type where the characteristic entity is set to Hold Request.</p>	Yes (Conditional) Note: This data is required when the effective date or characteristic value is specified.
Char Val1, Char Val2,, Char Val5	Used to specify the value for the characteristic type.	Yes (Conditional) Note: This data is required when the effective date or characteristic type is specified.

CSV File Format for Refund Request Upload

Before uploading a refund request file, you need to ensure that the CSV file contains the following columns:

Column Name	Description	Mandatory (Yes or No)
Refund Request Type	Used to specify the refund request type.	Yes
Account Identifier Type	Used to specify the account identifier type.	Yes (Conditional) Note: This data is required when the Account ID is not specified.
Account Identifier	Used to specify the account identifier of the account for which you want to create the refund request.	Yes (Conditional) Note: This data is required when the Account ID is not specified.
Account ID	Used to specify the account for which you want to create the refund request.	Yes (Conditional) Note: This data is required when the Account Identifier Type and Account Identifier are not specified.
Entity Type	Used to specify the entity type.	Yes
Entity ID	Used to specify the entity ID.	Yes
Adjustment Type	Used to specify the adjustment type using which the refund adjustments are created.	No
Refund Amount	Used to specify the amount that you want to refund.	Yes
Comments	Used to specify the comments which are added on the refund request.	No
Effective Date1, Effective Date2,, Effective Date5	Used to indicate the effective date of the characteristics.	Yes (Conditional) Note: This data is required when Char Type or Char Val is specified.
Char Type1, Char Type2,, Char Type5	Used to indicate the characteristic that must be defined for the refund request.	Yes (Conditional) Note: This data is required when Effective Date or Char Val is specified.
Char Val1, Char Val2,, Char Val5	Used to specify the value of the characteristic type.	Yes (Conditional) Note: This data is required when Effective Date or Char Type is specified.

CSV File Format for Write Off Request Upload

Before uploading a write off request file, you need to ensure that the CSV file contains the following columns:

Column Name	Description	Mandatory (Yes or No)
Write Off Request Type	Used to specify the write off request type.	Yes
Account Identifier Type	Used to specify the account identifier type.	Yes (Conditional) Note: This data is required when the Account ID is not specified.
Account Identifier	Used to specify the account identifier of the account for which you want to create the write off request.	Yes (Conditional) Note: This data is required when the Account ID is not specified.
Account ID	Used to specify the account for which you want to create the write off request.	Yes (Conditional) Note: This data is required when the Account Identifier Type and Account Identifier are not specified.
Entity Type	Used to specify the entity type.	Yes
Entity ID	Used to specify the entity ID.	Yes
Adjustment Type	Used to specify the adjustment type using which the write off adjustments are created.	No
Write Off Amount	Used to specify the amount that you want to write off.	Yes
Comments	Used to specify the comments which are added on the write off request.	No
Effective Date1, Effective Date2,, Effective Date5	Used to indicate the effective date of the characteristics.	Yes (Conditional) Note: This data is required when Char Type or Char Val is specified.
Char Type1, Char Type2,, Char Type5	Used to indicate the characteristic that must be defined for the write off request.	Yes (Conditional) Note: This data is required when Effective Date or Char Val is specified.
Char Val1, Char Val2,, Char Val5	Used to specify the value of the characteristic type.	Yes (Conditional) Note: This data is required when Effective Date or Char Type is specified.

CSV File Format for Reinstatement Upload Request

Before uploading a policy reinstatement file, you need to ensure that the CSV file contains the following columns:

Column Name	Description	Mandatory (Yes or No)
Policy ID	Used to indicate the policy which you want to reinstate.	No
	Note: If you do not specify the policy ID, the system derives the policy ID using the source system and policy number combination.	
Source System	Used to indicate the external system from where the policy is originated.	Yes (Conditional)
		Note: This data is required when the policy ID is not specified.
Policy Number	Used to indicate the policy number.	Yes (Conditional)
		Note: This data is required when the policy ID is not specified.
Reinstatement Reason	Used to indicate the reason why you want to reinstate the policy.	Yes
	Note: You must specify a reason which is defined for the status specified in the Policy Reinstatement Status for Reason Verification parameter of the C1-REN-VALID algorithm.	

CSV File Format for Bill Group Sorting Upload Request

Before uploading a bill group sorting file, you need to ensure that the CSV file contains the following values in the specified order separated by a comma:

Sr. No.	Value	Description	Mandatory (Yes or No)
1	Bill Group ID	Used to indicate the bill group (i.e. person) for whom you want to define the sort ID.	Yes (Conditional)
		Note: You must specify an effective child person of the parent customer for whom you are creating the bill group sorting upload request. In addition, note that you must specify a child person whose person type is set to Bill Group and who is related to the parent customer using a relationship type which is specified in the Person Relationship Type option type of the C1-ASOBLLNG feature configuration.	Note: This data is required when the bill group (i.e. person) identifier type and bill group (i.e. person) identifier are not specified.
2	Bill Group Identifier Type	Used to specify the bill group (i.e. person) identifier type.	Yes (Conditional)
			Note: This data is required when the bill group (i.e. person) ID is not specified.

Sr. No.	Value	Description	Mandatory (Yes or No)
3	Bill Group Identifier	Used to specify identifier of the bill group (i.e. person) for whom you want to define the sort ID.	Yes (Conditional)
			Note: This data is required when the bill group (i.e. person) ID is not specified.
4	Sort ID	Used to specify the sort ID.	Yes
5	Description	Used to specify the description for the sort ID.	Yes
6	Start Date	Used to specify the date from when the sort ID is effective for the bill group.	Yes
		Note: The start date cannot be later than the end date.	
7	End Date	Used to specify the date till when the sort ID is effective for the bill group.	No
		Note: The end date cannot be earlier than the start date.	

Related Topics

For more information on...	See...
How to setup the C1-ASOBLNG feature configuration	Setting the C1-ASOBLNG Feature Configuration on page 3421

CSV File Format for Bill Group Derivation and Pricing Parameters Upload Request

Before uploading a bill group derivation and pricing parameters file, you need to ensure that the CSV file contains the following values in the specified order separated by a comma:

Sr. No.	Value	Description	Mandatory (Yes or No)
1	Source System	Used to indicate the source system from where the claim and enrollment transactions are received.	Yes
		Note: You must specify a source system which already exists in the extendable lookup which is specified in the Source System Extendable Lookup parameter of the C1-BLVLVALID algorithm.	
2	Parameter 1	Used to specify the employee attribute based on which you want to derive the bill group.	Yes
		Note: You must not specify the ampersand (&) character in the parameter 1.	

Sr. No.	Value	Description	Mandatory (Yes or No)
3	Parameter 2	Used to specify the employee attribute based on which you want to derive the bill group.	No
		Note: You must not specify the ampersand (&) character in the parameter 2.	
4	Parameter 3	Used to specify the employee attribute based on which you want to derive the bill group.	No
		Note: You must not specify the ampersand (&) character in the parameter 3.	
5	Parameter 4	Used to specify the employee attribute based on which you want to derive the bill group.	No
		Note: You must not specify the ampersand (&) character in the parameter 4.	
6	Effective Date	Used to specify the date from when the derivation and pricing parameters are effective for the bill group and sort ID combination.	Yes
		Note: The effective date must be within the date range of the sort ID defined for the bill group.	
7	Bill Group ID	Used to indicate the bill group (i.e. person) for whom you want to define the derivation and pricing parameters.	Yes (Conditional)
		Note: You must specify an effective child person of the parent customer for whom you are creating the bill group derivation and pricing parameters upload request. In addition, note that you must specify a child person whose person type is set to Bill Group and who is related to the parent customer using a relationship type which is specified in the Person Relationship Type option type of the C1-ASOBLNG feature configuration.	
8	Bill Group Identifier Type	Used to specify the bill group (i.e. person) identifier type.	Yes (Conditional)
		Note: This data is required when the bill group (i.e. person) ID is not specified.	
9	Bill Group Identifier	Used to specify identifier of the bill group (i.e. person) for whom you want to define the derivation and pricing parameters.	Yes (Conditional)
		Note: This data is required when the bill group (i.e. person) ID is not specified.	

Sr. No.	Value	Description	Mandatory (Yes or No)
10	Sort ID	Used to indicate the sort ID of the bill group for which you want to define the derivation and pricing parameters.	Yes

Related Topics

For more information on...	See...
How to setup the C1-ASOBLLNG feature configuration	Setting the C1-ASOBLLNG Feature Configuration on page 3421

Upload Request Type

Oracle Revenue Management and Billing allows you to define an upload request type using which you can upload a file. An upload request of the specified upload request type is created on uploading the file. It is the upload request type which helps the system to understand how to process the file. If you upload a file which exceeds the maximum file size, the system will not allow you to upload the file.

The **Adjustment Upload Request Type (C1-AdjRequestType)** business object is used for the maintenance of upload request types for uploading CSV data. Configurations like upload file size, approval workflow can be configured using this object. If you are going to upload adjustment data files using an upload request type, you need to specify the match types (using which the adjustments must be created) in the upload request type. At present, the following two match types are shipped with the product:

- Contract
- Contract Type

You can also define custom match types, if required. You must use the **ADJ_MATCH_TYPE** lookup field to add a new match type. You need to attach an algorithm to each match type to determine the contract against which the adjustment must be created. At present, the following algorithm types and sample algorithms are shipped with the product:

Match Type	Algorithm Type	Sample Algorithm	Algorithm Description
Contract	C1-MTCIALG	C1-MTCIALG	This algorithm fetches contract ID for each adjustment record where the match type is set to Contract (CONT) .
Contract Type	C1-MTCTALG	C1-MTCTALG	This algorithm fetches contract ID based on the contract type and account ID for each adjustment record where the match type is set to Contract Type (CNTY) . If there are multiple active contracts of the specified contract type on the account, the contract ID with the latest start date will be fetched.

The **Upload Request Type (C1-UplRequestType)** business object will be used for the maintenance of upload request types for uploading CSV data. Configurations like upload file size, approval workflow can be configured using this object. The system enables you to upload data for the following using the **Upload Request** feature:

- Billable Charge (Adhoc and Regular)
- Hold Request
- Refund Request
- Write Off Request
- Policy Reinstatement

- Bill Group Sort ID
- Derivation and Pricing Parameters for a Bill Group and Sort ID Combination

It also enables you to update the following information:

- Contract rider of a contract
- Bill cycle of an account

It is the upload request type which helps the system to determine:

- Whether the file must be approved by the approver before creating or updating the entities
- Which business object must be used for creating the upload request
- Which business object must be used for creating or updating entities through an upload request
- Which foreign key reference must be used for generating information string for the entity
- A set of fields using which you can search records uploaded through an upload request

You can also define custom algorithm types and algorithms, if required. The **Upload Request Type** screen allows you to define, edit, copy, and delete an upload request type. This screen consists of the following zones:

- [Upload Request Type List](#) on page 1422
- [Upload Request Type](#) on page 1423

Parent topic: [Upload Request](#) on page 1895

Upload Request Type List

The **Upload Request Type List** zone lists upload request types that are already defined in the system. It contains the following columns:

Column Name	Column Description
Upload Request Type	Displays the upload request type.
Description	Displays the description of the upload request type.
Edit	On clicking the Edit (✎) icon, the Upload Request Type screen appears where you can edit the details of the upload request type.
Duplicate	On clicking the Duplicate (📄) icon, the Upload Request Type screen appears where you can define an upload request type using an existing upload request type.
Delete	On clicking the Delete (🗑) icon, you can delete the upload request type.
	Note: You can delete an upload request type when you have not uploaded a file (i.e. created an upload request) using the upload request type.
Mapping	On clicking the Mapping (🔗) icon, the mapping screen appears where you can map the columns of CSV file with the upload request type.

On clicking the **Broadcast** (📡) icon corresponding to an upload request type, the **Upload Request Type** zone appears with the details of the respective upload request type.

Related Topics

For more information on...	See...
How to define an upload request type	Defining an Upload Request Type on page 1426

For more information on...	See...
How to define a characteristic for an upload request type	Defining a Characteristic for an Upload Request Type on page 1432
How to edit an upload request type	Editing an Upload Request Type on page 1433
How to copy an upload request type	Copying an Upload Request Type on page 1436
How to delete an upload request type	Deleting an Upload Request Type on page 1441
How to map an upload request type	Mapping an Upload Request Type on page 1440
How to view the details of an upload request type	Viewing the Upload Request Type Details on page 1442

Upload Request Type

The **Upload Request Type** zone displays the details of the upload request type. This zone contains the following sections:

- **Main** – This section provides basic information about the upload request type. It contains the following fields:

Field Name	Field Description
Upload Request Type	Displays the upload request type.
Upload Request Business Object	Indicates the business object that will be used to create the upload request. In addition, a context menu appears corresponding to this field which helps in navigating to other screens in the application. Note: It has a link. On clicking the link, the Business Object screen appears where you can view the details of the respective business object.
Description	Displays the description of the upload request type.
Detailed Description	Displays additional information about the upload request type.
Status	Indicates the status of the upload request type. The valid values are: <ul style="list-style-type: none"> • Active • Inactive
File Size (KB)	Displays the maximum size of file (in kilobytes) that you can upload using the upload request type. If you upload a file which exceeds the maximum file size, the system will not allow you to upload the file. Note: This field appears when you create upload request type using Adjustment Upload Request Type business object.

Field Name	Field Description
Defer Algorithm	<p>Indicates the algorithm that will be triggered when you create entities (for example, adjustments) or approve the uploaded file (for example, adjustment data file). This algorithm checks whether the number of records in the uploaded file exceeds the online record process limit. If the number of records in the uploaded file does not exceed the online record process limit, the system creates the entities in the real time (i.e. immediately). However, if the number of records in the uploaded file exceeds the online record process limit, the system creates the entities (for example, adjustments) in the real time (i.e. immediately). However, if the number of records in the uploaded file exceeds the online record process limit, the system creates the entities (for example, adjustments) in the deferred mode.</p> <p>Note:</p> <p>This field appears when you create upload request type using Adjustment Upload Request Type business object.</p> <p>It has a link. On clicking the link, the Algorithm screen appears where you can view the details of the respective algorithm.</p> <p>In Upload Request Type, online and deferred mode is used for processing the file if approval is not required. The defer algorithm is invoked if the number of records to be processed on the respective business object is more than the count specified on the algorithm then the status for number of records is changed from Validated to Deferred Processing else the status is changed to Processed.</p>
Approval Required	Indicates whether approval is required for a file which is uploaded using the upload request type.
Approval To Do Type	<p>Indicates that the To Do entry of the specified To Do type must be created when you submit the upload request for approval.</p> <p>Note:</p> <p>This field appears when the Approval Required check box is selected.</p> <p>It has a link. On clicking the link, the To Do Type screen appears with the details of the respective To Do type.</p>
Approval To Do Role	<p>Indicates that users with the specified To Do role can only approve or reject the upload request submitted for approval.</p> <p>Note:</p> <p>This field appears when the Approval Required check box is selected.</p> <p>On selecting the To Do Type, the To Do Roles configured on the To Do Type is populated.</p> <p>It has a link. On clicking the link, the To Do Role screen appears with the details of the respective To Do role.</p>

Field Name	Field Description
FK Reference	Indicates the foreign key reference which specifies the created upload request type.
	<p>Note:</p> <p>This field appears when you create upload request type using Upload Request Type business object.</p> <p>It has a link. On clicking the link, the Foreign Key Reference screen appears with the details of the respective foreign key.</p>

In addition, this section has the following columns:

Column Name	Column Description
Match Type	Indicates the match type using which the adjustments must be created when you upload a file using the upload request type. The valid values are: <ul style="list-style-type: none"> Contract Contract Type
	<p>Note: The Match Type column is displayed for Adjustment Upload Request Business Object.</p>
Algorithm	Indicates the algorithm that will be triggered when you upload an adjustment data file. This algorithm determines the contract against which the adjustment must be created.
	<p>Note: It has a link. On clicking the link, the Algorithm screen appears with the details of the respective algorithm. The Algorithm column is displayed for Adjustment Upload Request Business Object.</p>

- **Characteristics** – This section lists the characteristics of the upload request type. It contains the following columns:

Column Name	Column Description
Characteristic Type	Indicates the characteristic type.
Characteristic Value	Displays the value of the characteristic type.

- **Record Actions** – This section contains the following buttons:

Button Name	Button Description
Edit	Used to edit the details of the upload request type.
Delete	Used to delete the upload request type.
	<p>Note: You can delete an upload request type when you have not uploaded a file (i.e. created an upload request) using the upload request type.</p>
Duplicate	Used to create a new upload request type using an existing upload request type.

- **Record Information** – This section contains the following fields:

Field Name	Field Description
Business Object	Indicates the business object using which the upload request type is created. In addition, a context menu appears corresponding to this field which helps in navigating to other screens in the application.
	Note: It has a link. On clicking the link, the Business Object screen appears where you can view the details of the respective business object.

By default, the **Upload Request Type** zone does not appear in the **Upload Request Type** screen. It appears when you click the **Broadcast** (📡) icon corresponding to an upload request type in the **Upload Request Type List** zone.

Related Topics

For more information on...	See...
How to define an upload request type	Defining an Upload Request Type on page 1426
How to define a characteristic for an upload request type	Defining a Characteristic for an Upload Request Type on page 1432
How to edit an upload request type	Editing an Upload Request Type on page 1433
How to copy an upload request type	Copying an Upload Request Type on page 1436
How to delete an upload request type	Deleting an Upload Request Type on page 1441
How to map an upload request type	Mapping an Upload Request Type on page 1440
How to view the details of an upload request type	Viewing the Upload Request Type Details on page 1442

Defining an Upload Request Type

Prerequisites

To define an upload request type, you should have:

- Upload request business objects defined in the application
- Defer algorithm for adjustment is defined using the **C1-UPLDEFEVL** algorithm type
- Defer algorithm for upload is defined using the **C1-DEFERUPLD** algorithm type
- Algorithm defined using the **C1-MTCIALG** algorithm type when you want to create adjustment using the **Contract** match type
- **C1-ADJUP** To Do type assigned to a To Do role whose users must receive To Do while submitting an adjustment upload request for approval
- **C1-BCUUR** To Do type assigned to a To Do role whose users must receive To Do while submitting a bill cycle update upload request for approval
- **C1-CRUUR** To Do type assigned to a To Do role whose users must receive To Do while submitting a contract rider update upload request for approval
- **C1-HLDUR** To Do type assigned to a To Do role whose users must receive To Do while submitting a hold upload request for approval
- **C1-REFUR** To Do type assigned to a To Do role whose users must receive To Do while submitting a refund upload request for approval
- **C1-WOUR** To Do type assigned to a To Do role whose users must receive To Do while submitting a write off upload request for approval

- **C1-BCUR** To Do type assigned to a To Do role whose users must receive To Do while submitting a billable charge upload request for approval
- **C1-RPUR** To Do type assigned to a To Do role whose users must receive To Do while submitting a reinstatement upload request for approval
- **C1-BGSRT** To Do type assigned to a To Do role whose users must receive To Do while submitting a bill group sorting upload request for approval
- **C1-BGDVP** To Do type assigned to a To Do role whose users must receive To Do while submitting a bill group derivation and pricing parameters upload request for approval

Procedure

To define an upload request type:

1. Click the **Admin** link in the **Application** toolbar.
A list appears.
2. From the **Admin** menu, select **U** and then click **Upload Request Type**.
A sub-menu appears.
3. Click the **Add** option from the **Upload Request Type** sub-menu.

The **Select Business Object** screen appears. It contains the following field:

Field Name	Field Description	Mandatory (Yes or No)
Upload Request Type Business Object	Used to indicate the business object that you want to use to create the upload request type.	Yes

Tip: Alternatively, you can access the **Select Business Object** screen by clicking the **Add** button in the **Page Title** area of the **Upload Request Type** screen.

Note: The **Select Business Object** screen appears when there are multiple upload request type business objects defined in the application. If there is only one upload request type business object defined in the application, the **Upload Request Type** screen appears.

4. Select the required upload request type business object from the respective field.
5. Click **OK**.

The **Upload Request Type** screen appears. It contains the following sections:

- **Main** – Used to specify basic details about the upload request type.
- **Characteristics** – Used to define the characteristics for the upload request type.

The **Main** section contains the following fields:

Field Name	Field Description	Mandatory (Yes or No)
Upload Request Type	Used to specify the upload request type.	Yes
Upload Request Type Business Object	Indicates the upload request type business object used while defining the upload request type.	Not applicable
Upload Request Business Object	Used to indicate the business object that you want to use while creating the upload request.	Yes
Description	Used to specify the description for the upload request type.	Yes

Field Name	Field Description	Mandatory (Yes or No)
Detailed Description	Used to specify additional information about the upload request type.	No
Status	Used to indicate the status of the upload request type. The valid values are: <ul style="list-style-type: none"> • Active • Inactive 	Yes
File Size (KB)	Used to specify the maximum size of file (in kilobytes) that you can upload using the upload request type. If you upload a file which exceeds the maximum file size, the system will not allow you to upload the file.	Yes
	Note: This field appears when Adjustment Upload Request Type business object is selected.	

Field Name	Field Description	Mandatory (Yes or No)
Defer Algorithm	<p>Used to attach an algorithm that will be triggered when you create entities (for example, adjustments) or approve the uploaded file (for example, adjustment data file). This algorithm checks whether the number of records in the uploaded file exceeds the online record process limit (defined in the Defer algorithm). If the number of records in the uploaded file does not exceed the online record process limit, the system creates the entities (for example, adjustments) in the real time (i.e. immediately). However, if the number of records in the uploaded file exceeds the online record process limit, the system creates the entities (for example, adjustments) in the deferred mode.</p> <p>Note:</p> <p>Deferred mode means in the background when the Upload Request Periodic Monitor (C1-UPLRQ) batch is invoked. You can configure the Upload Request Periodic Monitor (C1-UPLRQ) batch such that it is executed at regular intervals. When the Upload Request Periodic Monitor (C1-UPLRQ) batch is invoked, the system checks whether there are any upload requests in the Deferred status. If there is an upload request in the Deferred status, the system creates the entities (for example, adjustments).</p> <p>This field appears when Adjustment Upload Request Type business object is selected.</p> <p>In Upload Request Type, online and deferred mode is used for processing the file if approval is not required. The defer algorithm is invoked if the number of records to be processed on the respective business object is more than the count specified on the algorithm then the status for number of records is changed from Validated to Deferred Processing else the status is changed to Processed.</p> <p>Note: The Search  icon appears corresponding to this field. On clicking the Search icon, the Algorithm Search window appears.</p>	Yes

Field Name	Field Description	Mandatory (Yes or No)																						
Entity Business Object	<p>Used to indicate for creating Business Object of the entity using the upload request type.</p> <p>Note:</p> <p>The Search (🔍) icon appears corresponding to this field. On clicking the Search icon, the Business Object Search window appears.</p> <p>This field appears when Upload Request Type business object is selected.</p>	No																						
Approval Required	Used to indicate whether approval is required for a file which is uploaded using the upload request type.	No																						
Approval To Do Type	<p>Used to indicate that To Do entry of the specified To Do type must be created when you submit the upload request for approval.</p> <p>Note:</p> <p>The Search (🔍) icon appears corresponding to this field. On clicking the Search icon, the To Do Type Search window appears.</p> <p>The following table lists the To Do type using which the To Do must be generated for the different upload requests:</p> <table border="1" data-bbox="662 1104 1136 1787"> <thead> <tr> <th>Upload Request</th> <th>To Do Type</th> </tr> </thead> <tbody> <tr> <td>Adjustment</td> <td>C1-ADJUP</td> </tr> <tr> <td>Bill Cycle Update</td> <td>C1-BCUUR</td> </tr> <tr> <td>Billable Charge</td> <td>C1-BCUR</td> </tr> <tr> <td>Contract Rider Update</td> <td>C1-CRUUR</td> </tr> <tr> <td>Hold Request</td> <td>C1-HLDUR</td> </tr> <tr> <td>Refund Request</td> <td>C1-REFUR</td> </tr> <tr> <td>Write Off Request</td> <td>C1-WOUR</td> </tr> <tr> <td>Policy Reinstatement</td> <td>C1-RPUR</td> </tr> <tr> <td>Bill Group Sorting</td> <td>C1-BGSRT</td> </tr> <tr> <td>Bill Group Derivation and Pricing Parameters</td> <td>C1-BGDVP</td> </tr> </tbody> </table>	Upload Request	To Do Type	Adjustment	C1-ADJUP	Bill Cycle Update	C1-BCUUR	Billable Charge	C1-BCUR	Contract Rider Update	C1-CRUUR	Hold Request	C1-HLDUR	Refund Request	C1-REFUR	Write Off Request	C1-WOUR	Policy Reinstatement	C1-RPUR	Bill Group Sorting	C1-BGSRT	Bill Group Derivation and Pricing Parameters	C1-BGDVP	<p>Yes (Conditional)</p> <p>Note: This field is required when the Approval Required check box is selected.</p>
Upload Request	To Do Type																							
Adjustment	C1-ADJUP																							
Bill Cycle Update	C1-BCUUR																							
Billable Charge	C1-BCUR																							
Contract Rider Update	C1-CRUUR																							
Hold Request	C1-HLDUR																							
Refund Request	C1-REFUR																							
Write Off Request	C1-WOUR																							
Policy Reinstatement	C1-RPUR																							
Bill Group Sorting	C1-BGSRT																							
Bill Group Derivation and Pricing Parameters	C1-BGDVP																							

Field Name	Field Description	Mandatory (Yes or No)
Approval To Do Role	Used to indicate that users with the specified To Do role can only approve the upload request submitted for approval.	Yes (Conditional) Note: This field is required when the Approval Required check box is selected.
FK Reference	Used to indicate the FK Reference code to display the entity information. Note: The Search (🔍) icon appears corresponding to this field. On clicking the Search icon, the Foreign Key Search window appears. This field appears when Upload Request Type business object is selected.	No

In addition, this section contains the following fields in the grid:

Note: This field appears when **Adjustment Upload Request Type** business object is selected.

Field Name	Field Description	Mandatory (Yes or No)
Match Type	Used to indicate the match type using which you want to create adjustments when you upload a file using the upload request type. The valid values are: <ul style="list-style-type: none"> Contract Contract Type 	Yes (Conditional) Note: This field is required when you select the Adjustment Upload Request option from the Upload Request Business Object list.
Algorithm	Used to attach an algorithm that will be triggered when you upload an adjustment data file. This algorithm determines the contract against which the adjustment must be created. Note: The Search (🔍) icon appears corresponding to this field. On clicking the Search icon, the Algorithm Search window appears.	Yes (Conditional) Note: This field is required when you select the match type from the respective field.

6. Enter the required details.

Note:

You can search for an algorithm by clicking the **Search** (🔍) icon corresponding to the respective field.

If you want to associate more than one match type with the upload request type, click the **Add** (+) icon and then specify the details. However, if you want to remove a match type from the upload request type, click the **Delete** (🗑️) icon corresponding to the match type.

7. Define characteristics for the upload request type, if required.

8. Click **Save**.

The upload request type is defined.

Related Topics

For more information on...	See...
Upload Request Type screen	Upload Request Type on page 1421
Upload Request Type List zone	Upload Request Type List on page 1422
How to define a characteristic for an upload request type	Defining a Characteristic for an Upload Request Type on page 1432

Defining a Characteristic for an Upload Request Type**Prerequisites**

To define a characteristic for an upload request type, you should have:

- Characteristic types defined in the application (where the characteristic entity is set to Upload Request Type)

Procedure

To define a characteristic for an upload request type:

1. Ensure that the **Characteristics** section is expanded when you are defining, editing, or copying an upload request type.

The **Characteristics** section contains the following fields:

Field Name	Field Description	Mandatory (Yes or No)
Characteristic Type	Used to indicate the characteristic type.	Yes (Conditional)
	Note: The list includes only those characteristic types where the characteristic entity is set to Upload Request Type.	Note: This field is required when you are defining a characteristic for the upload request type.
Characteristic Value	Used to specify the value for the characteristic type.	Yes (Conditional)
	Note: On specifying the value for a predefined characteristic type, the description of the characteristic value appears corresponding to the Characteristic Value field.	Note: This field is required when you are defining a characteristic for the upload request type.

2. Enter the required details.

Note: If you select a predefined characteristic type, the **Search** (🔍) icon appears corresponding to the **Characteristic Value** field. On clicking the **Search** icon, you can search for a predefined characteristic value.

3. If you want to define more than one characteristic for the upload request type, click the **Add** (+) icon and then repeat step 2.

Note: However, if you want to remove a characteristic from the upload request type, click the **Delete** (🗑️) icon corresponding to the characteristic.

Related Topics

For more information on...	See...
How to define an upload request type	Defining an Upload Request Type on page 1426
How to edit an upload request type	Editing an Upload Request Type on page 1433
How to copy an upload request type	Copying an Upload Request Type on page 1436

Editing an Upload Request Type**Prerequisites**

To edit an upload request type, you should have:

- Upload request business objects defined in the application
- Defer algorithm for adjustment is defined using the **C1-UPLDEFEVL** algorithm type
- Defer algorithm for upload is defined using the **C1-DEFERUPLD** algorithm type
- Algorithm defined using the **C1-MTCIALG** algorithm type when you want to create adjustment using the Contract match type
- Algorithm defined using the **C1-MTCTALG** algorithm type when you want to create adjustment using the Contract Type match type
- **C1-ADJUP** To Do type assigned to a To Do role whose users must receive To Do entries generated while submitting an adjustment upload request for approval
- **C1-UPLAPPENT** To Do type assigned to a To Do role whose users must receive To Do generated while submitting an upload request for approval

Procedure

To edit an upload request type:

1. Click the **Admin** link in the **Application** toolbar.
A list appears.
2. From the **Admin** menu, select **U** and then click **Upload Request Type**.
A sub-menu appears.
3. In the **Upload Request Type List** zone, click the **Edit**  icon in the **Edit** column corresponding to the upload request type whose details you want to edit.

The **Upload Request Type** screen appears. It contains the following sections:

- **Main** – Used to specify basic details about the upload request type.
- **Characteristics** – Used to define the characteristics for the upload request type.

The **Main** section contains the following fields:

Field Name	Field Description	Mandatory (Yes or No)
Upload Request Type	Displays the upload request type.	Not applicable
Upload Request Type Business Object	Indicates the upload request type business object used while defining the upload request type.	Not applicable
Upload Request Business Object	Used to specify the business object that you want to use while creating the upload request.	Yes

Field Name	Field Description	Mandatory (Yes or No)
Description	Used to specify the description for the upload request type.	Yes
Detailed Description	Used to specify additional information about the upload request type.	No
Status	Used to indicate the status of the upload request type. The valid values are: <ul style="list-style-type: none"> Active Inactive 	Yes
File Size (KB)	Used to specify the maximum size of file (in kilobytes) that you can upload using the upload request type. If you upload a file which exceeds the maximum file size, the system will not allow you to upload the file.	Yes
	Note: This field appears when the business object is Adjustment Upload Request Type .	
Defer Algorithm	Used to attach an algorithm that will be triggered when you create entities (for example, adjustments) or approve the uploaded file (for example, adjustment data file). This algorithm checks whether the number of records in the uploaded file exceeds the online record process limit (defined in the Defer algorithm). If the number of records in the uploaded file does not exceed the online record process limit, the system creates the entities (for example, adjustments) in the real time (i.e. immediately). However, if the number of records in the uploaded file exceeds the online record process limit, the system creates the entities (for example, adjustments) in the deferred mode.	Yes
	<p>Note:</p> <p>Deferred mode means in the background when the Upload Request Periodic Monitor (C1-UPLRQ) batch is invoked. You can configure the Upload Request Periodic Monitor (C1-UPLRQ) batch such that it is executed at regular intervals. When the Upload Request Periodic Monitor (C1-UPLRQ) batch is invoked, the system checks whether there are any upload requests in the Deferred status. If there is an upload request in the Deferred status, the system creates the entities (for example, adjustments).</p> <p>This field appears when the business object is Adjustment Upload Request Type.</p>	

Field Name	Field Description	Mandatory (Yes or No)
Entity Business Object	Used to indicate for creating Business Object of the entity using the upload request type.	No
	Note: The Search (🔍) icon appears corresponding to this field. On clicking the Search icon, the Business Object Search window appears.	
Approval Required	Used to indicate whether approval is required for a file which is uploaded using the upload request type.	No
Approval To Do Type	Used to indicate that To Do entry of the specified To Do type must be created when you submit the upload request for approval.	Yes (Conditional)
	Note: The Search (🔍) icon appears corresponding to this field. On clicking the Search icon, the To Do Type Search window appears.	
Approval To Do Role	Used to indicate that users with the specified To Do role can only approve the upload request submitted for approval.	Yes (Conditional)
FK Reference	Used to indicate the FK Reference code to display the entity information.	No
	Note: The Search (🔍) icon appears corresponding to this field. On clicking the Search icon, the Foreign Key Search window appears. This field appears when the business object is Upload Request Type .	

In addition, this section contains the following fields in the grid:

Note: The below section appears when the business object is **Adjustment Upload Request Type**.

Field Name	Field Description	Mandatory (Yes or No)
Match Type	Used to indicate the match type using which you want to create adjustments when you upload a file using the upload request type. The valid values are: <ul style="list-style-type: none"> Contract Contract Type 	Yes (Conditional)
		Note: This field is required when you select the Adjustment Upload Request option from the Upload Request Business Object list.

Field Name	Field Description	Mandatory (Yes or No)
Algorithm	Used to attach an algorithm that will be triggered when you upload an adjustment data file. This algorithm determines the contract against which the adjustment must be created.	Yes (Conditional)
		Note: This field is required when you select the match type from the respective field.

Tip: Alternatively, you can click the **Edit** button in the **Upload Request Type** zone to edit the details of the upload request type.

4. Modify the required details.

Note:

You can search for an algorithm by clicking the **Search** (🔍) icon corresponding to the respective field.

If you want to associate more than one match type with the upload request type, click the **Add** (+) icon and then specify the details. However, if you want to remove a match type from the upload request type, click the **Delete** (🗑️) icon corresponding to the match type.

5. Define, edit, or remove characteristics of the upload request type, if required.

6. Click **Save**.

The changes made to the upload request type are saved.

Related Topics

For more information on...	See...
Upload Request Type screen	Upload Request Type on page 1421
Upload Request Type List zone	Upload Request Type List on page 1422
Upload Request Type zone	Upload Request Type on page 1423
How to define a characteristic for an upload request type	Defining a Characteristic for an Upload Request Type on page 1432

Deleting an Upload Request Type

Procedure

To delete an upload request type:

1. Click the **Admin** link in the **Application** toolbar.
A list appears.
2. From the **Admin** menu, select **U** and then click **Upload Request Type**.
A sub-menu appears.
3. In the **Upload Request Type List** zone, click the **Delete** (🗑️) icon in the **Delete** column corresponding to the upload request type that you want to delete.

A message appears confirming whether you want to delete the upload request type.

Note: You can delete an upload request type when you have not uploaded a file (i.e. created an upload request) using the upload request type.

Tip: Alternatively, you can click the **Delete** button in the **Upload Request Type** zone to delete the upload request type.

4. Click **OK**.

The upload request type is deleted.

Related Topics

For more information on...	See...
Upload Request Type screen	Upload Request Type on page 1421
Upload Request Type List zone	Upload Request Type List on page 1422
Upload Request Type zone	Upload Request Type on page 1423

Copying an Upload Request Type

Instead of creating an upload request type from scratch, you can create a new upload request type using an existing upload request type. This is possible through copying an upload request type. On copying an upload request type, the details including the match types (only for adjustments) and characteristics are copied to the new upload request type. You can then edit the details, if required.

Prerequisites

To copy an upload request type, you should have:

- Upload request type (whose copy you want to create) defined in the application
- Upload request business objects defined in the application
- Defer algorithm defined using the **C1-UPLDEFEVL** algorithm type
- Defer algorithm for upload is defined using the **C1-DEFERUPLD** algorithm type
- Algorithm defined using the **C1-MTCIALG** algorithm type when you want to create adjustment using the Contract match type
- Algorithm defined using the **C1-MTCTALG** algorithm type when you want to create adjustment using the Contract Type match type
- **C1-ADJUP** To Do type assigned to a To Do role whose users must receive To Do entries generated while submitting an upload request for approval
- **C1-UPLAPPENT** To Do type assigned to a To Do role whose users must receive To Do generated while submitting an upload request for approval

Procedure

To copy an upload request type:

1. Click the **Admin** link in the **Application** toolbar.
A list appears.
2. From the **Admin** menu, select **U** and then click **Upload Request Type**.
A sub-menu appears.
3. In the **Upload Request Type List** zone, click the **Duplicate**  icon in the **Duplicate** column corresponding to the upload request type whose copy you want to create.

The **Upload Request Type** screen appears. It contains the following sections:

- **Main** – Used to specify basic details about the upload request type.
- **Characteristics** – Used to define the characteristics for the upload request type.

The **Main** section contains the following fields:

Field Name	Field Description	Mandatory (Yes or No)
Upload Request Type	Used to specify the upload request type.	Yes
Upload Request Type Business Object	Indicates the upload request type business object used while defining the upload request type (whose copy you want to create).	Not applicable
Upload Request Business Object	Used to specify the business object that you want to use while creating the upload request.	Yes
Description	Used to specify the description for the upload request type.	Yes
Detailed Description	Used to specify additional information about the upload request type.	No
Status	Used to indicate the status of the upload request type. The valid values are: <ul style="list-style-type: none"> • Active • Inactive 	Yes
File Size (KB)	Used to specify the maximum size of file (in kilobytes) that you can upload using the upload request type. If you upload a file which exceeds the maximum file size, the system will not allow you to upload the file. <div style="border: 1px solid black; padding: 2px; margin-top: 5px;"> <p>Note: This field appears when the business object is Adjustment Upload Request Type.</p> </div>	Yes

Field Name	Field Description	Mandatory (Yes or No)
Defer Algorithm	<p>Used to attach an algorithm that will be triggered when you create entities (for example, adjustments) or approve the uploaded file (for example, adjustment data file). This algorithm checks whether the number of records in the uploaded file exceeds the online record process limit (defined in the Defer algorithm). If the number of records in the uploaded file does not exceed the online record process limit, the system creates the entities (for example, adjustments) in the real time (i.e. immediately). However, if the number of records in the uploaded file exceeds the online record process limit, the system creates the entities (for example, adjustments) in the deferred mode.</p> <p>Note:</p> <p>Deferred mode means in the background when the Upload Request Periodic Monitor (C1-UPLRQ) batch is invoked. You can configure the Upload Request Periodic Monitor (C1-UPLRQ) batch such that it is executed at regular intervals. When the Upload Request Periodic Monitor (C1-UPLRQ) batch is invoked, the system checks whether there are any upload requests in the Deferred status. If there is an upload request in the Deferred status, the system creates the entities (for example, adjustments).</p> <p>This field appears when the business object is Adjustment Upload Request Type.</p>	Yes
Entity Business Object	<p>Used to indicate to create the copy of Business Object of the entity using the upload request type.</p> <p>Note:</p> <p>The Search (🔍) icon appears corresponding to this field. On clicking the Search icon, the Business Object Search window appears.</p> <p>This field appears when the business object is Upload Request Type.</p>	No
Approval Required	Used to indicate whether approval is required for a file which is uploaded using the upload request type.	No

Field Name	Field Description	Mandatory (Yes or No)
Approval To Do Type	Used to indicate that To Do entry of the specified To Do type must be created when you submit the upload request for approval.	Yes (Conditional)
	Note: The Search (🔍) icon appears corresponding to this field. On clicking the Search icon, the To Do Type Search window appears.	Note: This field is required when the Approval Required check box is selected.
Approval To Do Role	Used to indicate that users with the specified To Do role can only approve the upload request submitted for approval.	Yes (Conditional)
		Note: This field is required when the Approval Required check box is selected.
FK Reference	Used to indicate the FK Reference code to display the entity information.	No
	Note: The Search (🔍) icon appears corresponding to this field. On clicking the Search icon, the Foreign Key Search window appears. This field appears when the business object is Upload Request Type .	

In addition, this section contains the following fields in the grid:

Note: The below section appears when the business object is **Adjustment Upload Request Type**.

Field Name	Field Description	Mandatory (Yes or No)
Match Type	Used to indicate the match type using which you want to create adjustments when you upload a file using the upload request type. The valid values are: <ul style="list-style-type: none"> • Contract • Contract Type 	Yes (Conditional)
		Note: This field is required when you select the Adjustment Upload Request option from the Upload Request Business Object list.
Algorithm	Used to attach an algorithm that will be triggered when you upload an adjustment data file. This algorithm determines the contract against which the adjustment must be created.	Yes (Conditional)
		Note: This field is required when you select the match type from the respective field.

Tip: Alternatively, you can click the **Duplicate** button in the **Upload Request Type** zone to create a copy of the upload request type.

4. Enter the required details.

Note:

You can search for an algorithm by clicking the **Search** (🔍) icon corresponding to the respective field.

If you want to associate more than one match type with the upload request type, click the **Add** (+) icon and then specify the details. However, if you want to remove a match type from the upload request type, click the **Delete** (🗑️) icon corresponding to the match type.

5. Define, edit, or remove characteristics of the upload request type, if required.
6. Click **Save**.

The new upload request type is defined.

Related Topics

For more information on...	See...
Upload Request Type screen	Upload Request Type on page 1421
Upload Request Type List zone	Upload Request Type List on page 1422
Upload Request Type zone	Upload Request Type on page 1423
How to define a characteristic for an upload request type	Defining a Characteristic for an Upload Request Type on page 1432

Mapping an Upload Request Type**Prerequisites**

To map an upload request type, you should have:

- Upload request type (whose columns you want to map with the CSV file) defined in the application
- Upload request business objects defined in the application

Note: Once an upload request type is used for creating an upload request, then mapping for the same cannot be edited. Duplicating the upload request type will not duplicate the mapping data. You have to add the mapping details manually after duplicating an upload request type.

Procedure

To map an upload request type:

1. Click the **Admin** link in the **Application** toolbar.
A list appears.
2. From the **Admin** menu, select **U** and then click **Upload Request Type**.
A sub-menu appears.
3. In the **Upload Request Type List** zone, click the **Mapping** (🔗) icon in the **Mapping** column corresponding to the upload request type whose columns you want to map with the CSV file.

The **Upload Request Type Mapping** screen appears. It contains the following field:

Note: The **Mapping** icon is applicable only for upload request type created using **Upload Request Type (C1-UplRequestType)** business object, and it is not applicable for upload request type created using **Adjustment Upload Request Type (C1-AdjRequestType)** business object.

Field Name	Field Description	Mandatory (Yes or No)
Upload Request Type	Indicates the upload request type.	Not applicable

The **Upload Request Type Mapping** screen also contains the following columns:

Column Name	Column Description	Mandatory (Yes or No)
CSV Column Header	Used to specify the rows correspond to the columns in CSV file.	Yes (Conditional) Note: This column is required when you search the Data Records zone in the Upload Request screen.
Use for Searching	Used to indicate whether the defined CSV Column Header is searchable or not. Note: Upto 10 rows can be selected as searchable rows.	Yes (Conditional) Note: This column is required to be selected to be shown in the Data Records zone in the Upload Request screen
Sequence Number	Used to specify the sequence of the searchable fields. Note: Searchable rows should have sequence less than or equal to 10.	Yes (Conditional) Note: This column is required to be selected to be shown sequentially in the Data Records zone in the Upload Request screen

- Enter the required details.

Note: If you want to add more than one column names mapped to the upload request type, click the **Add (+)** icon and then specify the details. However, if you want to remove a column name mapped to the upload request type, click the **Delete (🗑)** icon corresponding to the column header.

- Click **Save**.

The columns are mapped to the CSV files for upload request type.

Related Topics

For more information on...	See...
Upload Request Type screen	Upload Request Type on page 1421
Upload Request Type List zone	Upload Request Type List on page 1422
Upload Request Type zone	Upload Request Type on page 1423

Viewing the Upload Request Type Details

Procedure

To view the details of an upload request type:

- Click the **Admin** link in the **Application** toolbar.

A list appears.

- From the **Admin** menu, select **U** and then click **Upload Request Type**.

A sub-menu appears.

- Click the **Search** option from the **Upload Request Type** sub-menu.

The **Upload Request Type** screen appears.

- In the **Upload Request Type List** zone, click the

Broadcast () icon corresponding to the upload request type whose details you want to view.

The **Upload Request Type** zone appears.

- View the details of the upload request type in the **Upload Request Type** zone.

Related Topics

For more information on...	See...
Upload Request Type screen	Upload Request Type on page 1421
Upload Request Type List zone	Upload Request Type List on page 1422
Upload Request Type zone	Upload Request Type on page 1423

Upload Request (Used for Searching)

The **Upload Request** screen allows you to upload, validate and process the transaction data. Through this screen, you can navigate to the following screen:

- [Upload Request \(Used for Viewing\)](#) on page 1986

This screen consists of the following zone:

- [Search Upload Request](#) on page 1979

Search Upload Request

The **Search Upload Request** zone allows you to search for a upload request using various search criteria. This zone contains the following two sections:

- Search Criteria** – The **Search Criteria** section contains the following fields:

Field Name	Field Description	Mandatory (Yes or No)
Search By	Used to indicate whether you want to search for an upload request using Request Details .	Yes
Upload Date From	Used to search upload requests which are created from a particular date.	No
To	Used to search upload requests which are created till a particular date.	No

Field Name	Field Description	Mandatory (Yes or No)
Status	Used to search upload requests with a particular status. The valid values are: <ul style="list-style-type: none"> Approval In Progress Canceled Deferred Processing Draft Processed Rejected Validated 	No
Upload Request Type	Used to search upload requests which are created using a particular upload request type.	No
User ID	Used to search upload requests which are created by a particular user.	No
Upload Request ID	Used to search a particular upload request.	No
File Name	Used to search a particular file name.	No

Note: You must specify at least one search criterion while searching for an upload request.

- **Search Results** – On clicking the **Search** button, the search results appear based on the specified search criteria. The **Search Results** section contains the following columns:

Column Name	Column Description
Upload Date	Displays the date and time when the upload request was created in the system.
Payment Request Information	Displays information about the upload request. Note: It has a link. On clicking the link, the Upload Request screen appears where you can view the details of the respective upload request.
Status	Indicates the status of the upload request. The valid values are: <ul style="list-style-type: none"> Approval In Progress Canceled Deferred Processing Draft Processed Rejected Validated
Upload Request Type	Displays the upload request type using which the upload request is created.
Entity Business Object	Displays the business object code of the entity.
File Name	Displays the uploaded file name.
Total Records	Displays the total number of records in the uploaded csv file.

Column Name	Column Description
Created By	Indicates the user who has created the upload request.

Related Topics

For more information on...	See...
How to search for an upload request	Searching for an Upload Request on page 1981
How to view the details of an upload request	Viewing the Upload Request Details on page 1982
How to create an upload request	Creating an Upload Request on page 1982
How to define a characteristic for an upload request	Defining a Characteristic for an Upload Request on page 1985

Searching for an Upload Request

Prerequisites

To search for an upload request, you should have:

- Upload request types defined in the application

Procedure

To search for an upload request:

1. Click the **Menu** link in the **Application** toolbar.
A list appears.
2. From the **Main** menu, select **Tools** and then click **Upload Request**.
A sub-menu appears.
3. Click the **Search** option from the **Upload Request** sub-menu.
The **Upload Request** screen appears.
4. Enter the search criteria in the **Search Upload Request** zone.

Note: ORMB search engine supports wildcard search, where you can substitute the percentage (%) symbol as a stand in for any word or letter in a search criteria. You can use the ‘%’ wildcard character in all input fields except the date and ID fields. The ‘%’ wildcard character is suffixed automatically at the end of the partial search criteria. Therefore, you may or may not specify the wildcard character at the end of the partial search criteria. However, you have to prefix the wildcard character manually wherever required.

5. Click **Search**.

A list of upload requests that meet the search criteria appears in the **Search Results** section.

Related Topics

For more information on...	See...
Upload Request screen	Upload Request (Used for Searching) on page 1979
Search Upload Request zone	Search Upload Request on page 1979

Viewing the Upload Request Details

Procedure

To view the details of an upload request:

1. Search for the upload request in the **Upload Request** screen.
2. In the **Search Results** section, click the link in the **Upload Request Information** column corresponding to the upload request whose details you want to view.

The **Upload Request** screen appears. It consists of the following tabs:

- **Main** – This tab contains the following two zones:
 - **Upload Request** – Displays the details of the upload request.
 - **Data Records** – Lists the details of data records uploaded in the csv file.
 - **Log** – This tab lists the complete trail of actions performed on the upload request.
3. View the details of the upload request in the **Upload Request** zone.
 4. View the data records in the csv file of the upload request in the **Data Records** zone.

Related Topics

For more information on...	See...
How to search for an upload request	Searching for an Upload Request on page 1981
Upload Request screen	Upload Request (Used for Viewing) on page 1986
Upload Request zone	Upload Request on page 1986
Data Records zone	Data Records on page 1988

Creating an Upload Request

Prerequisites

To create an upload request, you should have:

- Upload request types defined in the application

Procedure

To create an upload request:

1. Click the **Menu** link in the **Application** toolbar.
A list appears.
2. From the **Main** menu, select **Tools** and then click **Upload Request**.
A sub-menu appears.
3. Click the **Add** option from the **Upload Request** sub-menu.

The **Select Upload Request Type** screen appears. It contains the following field:

Field Name	Field Description	Mandatory (Yes or No)
Upload Request Type	Used to indicate the upload request type using which you want to create the upload request. Note: The following upload request types are shipped with the product: <ul style="list-style-type: none"> • ADJ_UPL_REQ_TYPE_APVL • ADJ_UPL_REQ_TYPE_WO_APVL • BC_UPL_REQ_TYPE • BILL_CYCLE_UPD_UPL_REQ_TYPE • BILL_LVL_UPL_REQ_TYPE • BILL_SRT_UPL_REQ_TYPE • HOLD_UPL_REQ_TYPE • REFUND_UPL_REQ_TYPE • REIN_UPL_REQ_TYPE • SA_RIDER_UPD_UPL_REQ_TYPE • WO_UPL_REQ_TYPE 	Yes

Tip: Alternatively, you can access the **Select Upload Request Type** screen by clicking the **Upload** button in the **Page Title** area of the **Upload Request** screen.

Note: The **Select Upload Request Type** screen appears when there are multiple upload request types defined in the application. If there is only one upload request type defined in the application, the **{XXX} Upload Request** screen appears.

4. Select the required upload request type from the respective field.
5. Click **OK**.

The **{XXX} Upload Request** screen appears. Here, **{XXX}** changes depending on the upload request type that you have selected. It contains the following sections:

- **Main** – Used to specify basic details about the upload request.
- **Characteristics** – Used to define the characteristics for the upload request.

The **Main** section contains the following fields:

Field Name	Field Description	Mandatory (Yes or No)
Upload Request Type	Indicates the upload request type using which the upload request will be created.	Not applicable

Field Name	Field Description	Mandatory (Yes or No)
Parent Customer	Used to indicate the person for whom you want to create the bill group sorting or bill group derivation and pricing parameters upload request.	Yes
	<p>Note:</p> <p>This field appears when you are creating an upload request using an upload request type where the upload request business object is set to C1-BillGrpSortUploadRequest or C1-BillLevelUploadRequest.</p> <p>The system allows you to create a bill group sorting or bill group derivation and pricing parameters upload request for a person whose person type is set to Parent Customer.</p> <p>The Search (🔍) icon appears corresponding to this field. On clicking the Search icon, the Person Search window appears.</p>	
File Name	Used to specify the name and path of the file that you want to upload.	Yes
	<p>Note: You can also click the Browse button corresponding to this field to browse to the location where the file is available in the system.</p>	
Replace Existing File	Used to indicate whether you want to replace any existing file in the system. You must select this check box when you want to upload the same file once again.	No
Comments	Used to specify additional information about the upload request.	No

- Click the **Browse** button corresponding to the **File Name** field.

The **Choose File to Upload** dialog box appears.

- Browse to the location where the file that you want to upload is available in the system.
- Click **Open**.

The file name along with the path appears in the **File Name** field.

- Select the **Replace Existing File** check box depending on whether you want to upload the same file once again in the system.
- Define characteristics for the upload request, if required.
- Click **Save**.

A message appears indicating the number of records which are successfully uploaded. Then, an upload request is created in the **Draft** status. If the required identifier (such as account ID, person ID, policy ID, or bill group ID) is available in the record, the status of the record is set to **Pending**. However, if the required identifier could not be derived from the system, the status of the record is set to **Invalid**.

Related Topics

For more information on...	See...
Upload Request screen	Upload Request (Used for Searching) on page 1979
How to define a characteristic for an upload request	Defining a Characteristic for an Upload Request on page 1985

Defining a Characteristic for an Upload Request**Prerequisites**

To define a characteristic for an upload request, you should have:

- Characteristic types defined in the application (where the characteristic entity is set to **Upload Request**)

Procedure

To define a characteristic for an upload request:

1. Ensure that the **Characteristics** section is expanded when you are defining or editing an upload request.

The **Characteristics** section contains the following fields in a grid:

Field Name	Field Description	Mandatory (Yes or No)
Effective Date	Used to specify the date from when the characteristic is effective for the upload request.	Yes (Conditional) Note: This field is required when you are defining a characteristic for the upload request.
Characteristic Type	Used to indicate the characteristic type. Note: The list includes only those characteristic types where the characteristic entity is set to Upload Request .	Yes (Conditional) Note: This field is required when you are defining a characteristic for the upload request.
Characteristic Value	Used to specify the value for the characteristic type. Note: On specifying the value for a predefined characteristic type, the description of the characteristic value appears corresponding to the Characteristic Value field.	Yes (Conditional) Note: This field is required when you are defining a characteristic for the upload request.

2. Enter the required details in the **Characteristics** section.

Note: If you select a predefined characteristic type, the **Search** (🔍) icon appears corresponding to the **Characteristic Value** field. On clicking the **Search** icon, you can search for a predefined characteristic value.

3. If you want to define more than one characteristic for the upload request, click the **Add** (+) icon and then repeat step 2.

Note: However, if you want to remove a characteristic from the upload request, click the **Delete** (🗑️) icon corresponding to the characteristic.

Related Topics

For more information on...	See...
How to create an upload request	Creating an Upload Request on page 1982
How to edit an upload request	Editing an Upload Request on page 1991

Upload Request (Used for Viewing)

Once you create an upload request, the **Upload Request** screen allows you to:

- Edit the details of an upload request
- Delete an upload request
- View the details of an upload request
- Validate an upload request
- Cancel an upload request
- Submit an upload request
- Approve or reject an upload request
- View the data uploaded to a request
- View the log of an upload request
- Add a log entry for an upload request

This screen consists of the following tabs:

- **Main** – This tab contains the following two zones:
 - **Upload Request** – Displays the details of the upload request.
 - **Data Records** – Lists the data records of the upload request.
- **Log** – This tab lists the complete trail of actions performed on the upload request.

Upload Request - Main

The **Main** tab contains the following zones:

- [Upload Request](#) on page 1986
- [Data Records](#) on page 1988

Upload Request

The **Upload Request** zone displays the details of the upload request. This zone contains the following sections:

- **Main** – This section provides basic information about the upload request. It contains the following fields:

Field Name	Field Description
Upload Request Information	Displays information about the upload request.

Field Name	Field Description
Upload Request Type	Indicates the upload request type using which the upload request is created.
	Note: It has a link. On clicking the link, the Upload Request Type screen appears where you can view the details of the upload request type.
Status	Indicates the status of the payment request. The valid values are: <ul style="list-style-type: none"> • Approval In Progress • Approved • Cancelled • Deferred Processing • Draft • Processed • Rejected • Submitted • Validated
File Name	Displays name of the uploaded file.

- **Statistics** – This section lists the statistics of records in the upload request. It contains the following fields:

Field Name	Field Description
Total Records	Displays total number of records in CSV file.
Valid Records	Displays the count of valid data records.
Error Records	Displays the count of data records in error status.
Pending Records	Displays the count of data records pending after successful derivation.
Invalid Records	Displays the count of data records after unsuccessful derivation.
Processed Records	Displays the count of data records after processing.

- **Characteristics** – This section lists the characteristics of the upload request. It contains the following columns:

Column Name	Column Description
Effective Date	Indicates the date from when the characteristic is effective for the upload request.
Characteristic Type	Indicates the characteristic type.
Characteristic Value	Displays the value of the characteristic type.

- **Record Actions** – This section contains the following buttons:

Column Name	Column Description
Edit	Used to edit the details of the upload request.
	Note: The Edit button appears when the upload request is in the Draft or Validated status.

Column Name	Column Description
Delete	Used to delete the upload request.
	Note: The Delete button appears when the upload request is in the Draft status.
Validate	Used to validate the upload request.
	Note: The Validate button appears when the upload request is in the Draft status.
Cancel	Used to cancel the upload request.
	Note: The Cancel button appears when the upload request is in the Validated status.
Submit	Used to submit the upload request for approval.
	Note: The Submit button appears when: <ul style="list-style-type: none"> The upload request is in the Validated status. The Approval Required check box is selected in the upload request type using which the upload request is created.
Approve	Used to approve the upload request.
	Note: The Approve button appears when: <ul style="list-style-type: none"> The upload request is in the Approval In Progress status. A user with the approval To Do role is reviewing the upload request.
Reject	Used to reject the upload request.
	Note: The Reject button appears when: <ul style="list-style-type: none"> The upload request is in the Approval In Progress status. A user with the approval To Do role is reviewing the upload request.

- **Record Information** – This section contains the following fields:

Field Name	Field Description
Business Object	Indicates the business object using which the upload request is created. In addition, a context menu appears corresponding to this field which helps in navigating to other screens in the application.
	Note: It has a link. On clicking the link, the Business Object screen appears where you can view the details of the respective business object.
Status Date/Time	Displays the date and time when the upload request status is updated
Create Date/Time	Displays the date and time when the upload request is created.

Data Records

The **Data Records** zone lists the data records of the upload request. This zone contains the following two sections:

- **Search Criteria** – The **Search Criteria** section contains the following fields:

Field Name	Field Description	Mandatory (Yes or No)
Search Criteria 1, Search Criteria 2,,Search Criteria 10	Used to search for data from the CSV file with respect to the field.	No
Note: We have used generic field labels here. However, these labels will change depending on the mapping defined in the respective upload request type.		
Record Status	Used to indicate whether you want to search data records for an upload request. The valid values are: <ul style="list-style-type: none"> • Error • Invalid • Pending • Processed • Valid 	No

- **Search Results** – On clicking the **Search** button, the search results appear based on the specified search criteria. The **Search Results** section contains the following columns:

Column Name	Column Description
View	On clicking the View () icon, the Data Record Details window appears where you can view the details of the data records.
Search Result 1, Search Result 2,, Search Result 10	Displays data from the CSV file.
Note: We have used generic field labels here. However, these labels will change depending on the mapping defined in the respective upload request type.	
Record Status	Indicates the status of the data record. The valid values are: <ul style="list-style-type: none"> • Error • Invalid • Pending • Processed • Valid
Message(s)	Displays message for the data record respective to it's status.

Column Name	Column Description
Entity ID	Displays entity ID of the upload request.
	Note: The entity ID is displayed only for data records with Processed status.
Entity Information	Displays entity information for the FK Reference selected in Upload Request Type screen.
	Note: The entity information is displayed only for data records with Processed status.

Note: By default the **Search Results** section displays data records for all the statuses though data is not added or selected to any of the fields and are searched through the **Search Criteria** section.

Related Topics

For more information on...	See...
How to view details against each data record.	Viewing the Data Record Details on page 2002

Upload Request - Log

The **Log** tab contains the following zone:

- [Upload Request Log](#) on page 1990

Upload Request Log

The **Upload Request Log** zone on the **Upload Request** screen lists the complete trail of actions performed on the upload request. This zone contains the following columns:

Column Name	Column Description
Date/Time	Displays the date and time when the action was performed on the upload request.
Details	Displays the details about the action performed on the upload request.
User	Indicates the user who has performed the action on the upload request.
Log Type	Indicates the type of log.
Related Object	Indicates the object or entity which is generated when the action is performed on the upload request.
Status Reason	Displays the status reason of action performed on the upload request.

Note: You can manually add a log entry for the upload request by clicking the **Add Log Entry** link in the upper right corner of the **Upload Request Log** zone.

The **Add Upload Request Log** window appears. Enter **Log Details** and click **Save**. The upload request log is added.

Related Topics

For more information on...	See...
How to view the log of an upload request	Viewing the Log of an Upload Request on page 2003
How to add the log for an upload request	Adding a Log Entry for an Upload Request on page 2004

Editing an Upload Request

Procedure

To edit an upload request:

1. Search for the upload request in the **Upload Request** screen.
2. In the **Search Results** section, click the link in the **Upload Request Information** column corresponding to the upload request whose details you want to edit.

The **Upload Request** screen appears.

3. Click the **Edit** button in the **Upload Request** zone.

Note: The **Edit** button appears when the upload request is in the **Draft** or **Validated** status.

The entity **Upload Request** screen appears. It contains the following sections:

- **Main** – Used to specify basic details about the upload request. This section contains the following fields:

Field Name	Field Description	Mandatory (Yes or No)
Upload Request Type	Displays the upload request type using which the upload request is created.	Not applicable
File Name	Displays name of the uploaded CSV file.	Not applicable
Comments	Used to indicate the comments for upload request.	No

- **Characteristics** – Used to define the characteristics for the upload request. This section contains the following fields:

Field Name	Field Description	Mandatory (Yes or No)
Effective Date	Used to specify the date from when the characteristic is effective for the upload request.	Yes (Conditional)
		Note: This field is required when you are defining a characteristic for the upload request.
Characteristic Type	Used to indicate the characteristic type.	Yes (Conditional)
	Note: The list includes only those characteristic types where the characteristic entity is set to Upload Request .	Note: This field is required when you are defining a characteristic for the Upload request.
Characteristic Value	Used to specify the value for the characteristic type.	Yes (Conditional)
	Note: On specifying the value for a predefined characteristic type, the description of the characteristic value appears corresponding to the Characteristic Value field.	Note: This field is required when you are defining a characteristic for the Upload request.

4. Modify the details of the upload request, if required.

5. Define, edit, or remove characteristics of the upload request, if required.
6. Click **Save**.

The changes made to the upload request are saved.

Related Topics

For more information on...	See...
How to search for an upload request	Searching for an Upload Request on page 1981
Upload Request screen	Upload Request (Used for Viewing) on page 1986
Upload Request zone	Upload Request on page 1986
How to define a characteristic for an upload request	Defining a Characteristic for an Upload Request on page 1985

Deleting an Upload Request

Procedure

To delete an upload request:

1. Search for the upload request in the **Upload Request** screen.
2. In the **Search Results** section, click the link in the **Upload Request Information** column corresponding to the upload request that you want to delete.

The **Upload Request** screen appears.

3. Click the **Delete** button in the **Upload Request** zone.

A message appears confirming whether you want to delete the upload request.

Note: The **Delete** button appears when the upload request is in the **Draft** status.

4. Click **OK**.

The upload request is deleted.

Related Topics

For more information on...	See...
How to search for an upload request	Searching for an Upload Request on page 1981
Upload Request screen	Upload Request (Used for Viewing) on page 1986
Upload Request zone	Upload Request on page 1986

Validating an Upload Request

Prerequisites

To validate an upload request, you should have:

- Upload Request Types defined in the request.

Procedure

To validate an upload request:

1. Search for the upload request in the **Upload Request** screen.
2. In the **Search Results** section, click the link in the **Upload Request Information** column corresponding to the upload request that you want to validate.

The **Upload Request** screen appears.

3. Click the **Validate** button in the **Upload Request** zone.

Note: The **Validate** button appears when the upload request is in the **Draft** status.

For more information about the **Upload Request Periodic Monitor (C1-UPLRQ)** batch, refer to Oracle Revenue Management and Billing Batch Guide.

The status of the upload request is changed to **Validated**.

Related Topics

For more information on...	See...
How to search for an upload request	Searching for an Upload Request on page 1981
Upload Request screen	Upload Request (Used for Viewing) on page 1986
Upload Request zone	Upload Request on page 1986

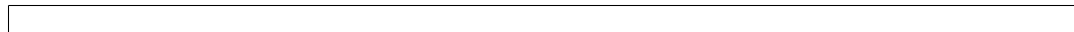

Canceling an Upload Request

Prerequisites

To cancel an upload request, you should have:

- Cancellation reasons defined in the application

Note: While cancelling an upload request, you need to specify the reason why you want to cancel the upload request. You can select the appropriate cancellation reason when you have defined the reasons for the **Canceled** status of the **C1-UplRequestType** business object in the **Status Reason** screen.

Procedure

To cancel an upload request:

1. Search for the upload request in the **Upload Request** screen.
2. In the **Search Results** section, click the link in the **Upload Request Information** column corresponding to the upload request that you want to cancel.

The **Upload Request** screen appears.

3. Click the **Cancel** button in the **Upload Request** zone.

The **Cancel Reason** window appears. It contains following fields:

Field Name	Field Description	Mandatory (Yes or No)
Cancel Reason	Used to indicate the reason why you want to cancel the upload request.	Yes
Comments	Used to specify additional information while cancelling the upload request.	No

Note: The **Cancel** button appears when the upload request is in the **Validated** status.

4. Select the cancellation reason from the **Cancel Reason** list.
5. Click **Save**.

The status of the upload request is changed to **Canceled**.

Related Topics

For more information on...	See...
How to search for an upload request	Searching for an Upload Request on page 1981
Upload Request screen	Upload Request (Used for Viewing) on page 1986
Upload Request zone	Upload Request on page 1986

Submitting an Upload Request

Procedure

To submit an upload request:

1. Search for the upload request in the **Upload Request** screen.
2. In the **Search Results** section, click the link in the **Upload Request Information** column corresponding to the upload request that you want to submit.

The **Upload Request** screen appears.

3. Click the **Submit** button in the **Upload Request** zone.

The system behaves in the following manner:

If...	Then...																				
<p>The Approval Required check box is selected in the upload request type using which the upload request is created</p>	<p>A To Do of the specified To Do type is created and sent to the approver for approval. The following table lists the To Do type using which the To Do is created for the different upload requests:</p> <table border="1" data-bbox="873 359 1463 894"> <thead> <tr> <th data-bbox="878 365 1166 411">Upload Request</th> <th data-bbox="1170 365 1458 411">To Do Type</th> </tr> </thead> <tbody> <tr> <td data-bbox="878 417 1166 464">Bill Cycle Update</td> <td data-bbox="1170 417 1458 464">C1-BCUUR</td> </tr> <tr> <td data-bbox="878 470 1166 516">Billable Charge</td> <td data-bbox="1170 470 1458 516">C1-BCUR</td> </tr> <tr> <td data-bbox="878 522 1166 569">Contract Rider Update</td> <td data-bbox="1170 522 1458 569">C1-CRUUR</td> </tr> <tr> <td data-bbox="878 575 1166 621">Hold Request</td> <td data-bbox="1170 575 1458 621">C1-HLDUR</td> </tr> <tr> <td data-bbox="878 627 1166 674">Refund Request</td> <td data-bbox="1170 627 1458 674">C1-REFUR</td> </tr> <tr> <td data-bbox="878 680 1166 726">Write Off Request</td> <td data-bbox="1170 680 1458 726">C1-WOUR</td> </tr> <tr> <td data-bbox="878 732 1166 779">Policy Reinstatement</td> <td data-bbox="1170 732 1458 779">C1-RPUR</td> </tr> <tr> <td data-bbox="878 785 1166 831">Bill Group Sorting</td> <td data-bbox="1170 785 1458 831">C1-BGSRT</td> </tr> <tr> <td data-bbox="878 837 1166 884">Bill Group Derivation and Pricing Parameters</td> <td data-bbox="1170 837 1458 884">C1-BGDVP</td> </tr> </tbody> </table> <p>In addition, the status of the upload request is changed to Approval In Progress.</p>	Upload Request	To Do Type	Bill Cycle Update	C1-BCUUR	Billable Charge	C1-BCUR	Contract Rider Update	C1-CRUUR	Hold Request	C1-HLDUR	Refund Request	C1-REFUR	Write Off Request	C1-WOUR	Policy Reinstatement	C1-RPUR	Bill Group Sorting	C1-BGSRT	Bill Group Derivation and Pricing Parameters	C1-BGDVP
Upload Request	To Do Type																				
Bill Cycle Update	C1-BCUUR																				
Billable Charge	C1-BCUR																				
Contract Rider Update	C1-CRUUR																				
Hold Request	C1-HLDUR																				
Refund Request	C1-REFUR																				
Write Off Request	C1-WOUR																				
Policy Reinstatement	C1-RPUR																				
Bill Group Sorting	C1-BGSRT																				
Bill Group Derivation and Pricing Parameters	C1-BGDVP																				

If...	Then...																				
<p>The Approval Required check box is not selected in the upload request type using which the upload request is created and the number of valid records in the upload request does not exceed the online record process limit defined in the C1-DEFERUPLD algorithm.</p>	<p>The following table lists the behavior for the different upload requests:</p> <table border="1" data-bbox="873 296 1468 1371"> <thead> <tr> <th data-bbox="881 300 1125 342">Upload Request</th> <th data-bbox="1133 300 1468 342">Behaviour</th> </tr> </thead> <tbody> <tr> <td data-bbox="881 352 1125 426">Bill Cycle Update</td> <td data-bbox="1133 352 1468 426">The bill cycle information is updated for the accounts.</td> </tr> <tr> <td data-bbox="881 436 1125 510">Billable Charge</td> <td data-bbox="1133 436 1468 510">The billable charges are created.</td> </tr> <tr> <td data-bbox="881 520 1125 625">Contract Rider Update</td> <td data-bbox="1133 520 1468 625">The contract rider information is updated for the contracts.</td> </tr> <tr> <td data-bbox="881 636 1125 709">Hold Request</td> <td data-bbox="1133 636 1468 709">The hold requests are created.</td> </tr> <tr> <td data-bbox="881 720 1125 793">Refund Request</td> <td data-bbox="1133 720 1468 793">The refund requests are created.</td> </tr> <tr> <td data-bbox="881 804 1125 877">Write Off Request</td> <td data-bbox="1133 804 1468 877">The write off requests are created.</td> </tr> <tr> <td data-bbox="881 888 1125 1140">Policy Reinstatement</td> <td data-bbox="1133 888 1468 1140">The policies are reinstated and the status of the policies is changed to the one defined in the Policy Status after Processing Reinstatement Upload Request parameter of the C1-REN-VALID algorithm.</td> </tr> <tr> <td data-bbox="881 1150 1125 1224">Bill Group Sorting</td> <td data-bbox="1133 1150 1468 1224">The sort ID is defined for the respective bill group.</td> </tr> <tr> <td data-bbox="881 1234 1125 1367">Bill Group Derivation and Pricing Parameters</td> <td data-bbox="1133 1234 1468 1367">The derivation and pricing parameters are defined for the respective bill group and sort ID combination.</td> </tr> </tbody> </table> <p>In addition, the status of the upload request is changed to Processed.</p>	Upload Request	Behaviour	Bill Cycle Update	The bill cycle information is updated for the accounts.	Billable Charge	The billable charges are created.	Contract Rider Update	The contract rider information is updated for the contracts.	Hold Request	The hold requests are created.	Refund Request	The refund requests are created.	Write Off Request	The write off requests are created.	Policy Reinstatement	The policies are reinstated and the status of the policies is changed to the one defined in the Policy Status after Processing Reinstatement Upload Request parameter of the C1-REN-VALID algorithm.	Bill Group Sorting	The sort ID is defined for the respective bill group.	Bill Group Derivation and Pricing Parameters	The derivation and pricing parameters are defined for the respective bill group and sort ID combination.
Upload Request	Behaviour																				
Bill Cycle Update	The bill cycle information is updated for the accounts.																				
Billable Charge	The billable charges are created.																				
Contract Rider Update	The contract rider information is updated for the contracts.																				
Hold Request	The hold requests are created.																				
Refund Request	The refund requests are created.																				
Write Off Request	The write off requests are created.																				
Policy Reinstatement	The policies are reinstated and the status of the policies is changed to the one defined in the Policy Status after Processing Reinstatement Upload Request parameter of the C1-REN-VALID algorithm.																				
Bill Group Sorting	The sort ID is defined for the respective bill group.																				
Bill Group Derivation and Pricing Parameters	The derivation and pricing parameters are defined for the respective bill group and sort ID combination.																				

If...	Then...																				
<p>The Approval Required check box is not selected in the upload request type using which the upload request is created and the number of valid records in the upload request exceeds the online record process limit defined in the C1-DEFERUPLD algorithm</p>	<p>The system changes the status of the upload request to Deferred Processing. When the Upload Request Periodic Monitor (C1-UPLRQ) batch is invoked, the system checks whether there are any upload requests in the Deferred Processing status. If there is an upload request in the Deferred Processing status, the system behaves in the following manner for the different upload requests:</p> <table border="1" data-bbox="873 485 1463 1528"> <thead> <tr> <th data-bbox="878 491 1122 533">Upload Request</th> <th data-bbox="1127 491 1458 533">Behaviour</th> </tr> </thead> <tbody> <tr> <td data-bbox="878 539 1122 617">Bill Cycle Update</td> <td data-bbox="1127 539 1458 617">The bill cycle information is updated for the accounts.</td> </tr> <tr> <td data-bbox="878 623 1122 701">Billable Charge</td> <td data-bbox="1127 623 1458 701">The billable charges are created.</td> </tr> <tr> <td data-bbox="878 707 1122 814">Contract Rider Update</td> <td data-bbox="1127 707 1458 814">The contract rider information is updated for the contracts.</td> </tr> <tr> <td data-bbox="878 821 1122 863">Hold Request</td> <td data-bbox="1127 821 1458 863">The hold requests are created.</td> </tr> <tr> <td data-bbox="878 869 1122 947">Refund Request</td> <td data-bbox="1127 869 1458 947">The refund requests are created.</td> </tr> <tr> <td data-bbox="878 953 1122 1031">Write Off Request</td> <td data-bbox="1127 953 1458 1031">The write off requests are created.</td> </tr> <tr> <td data-bbox="878 1037 1122 1304">Policy Reinstatement</td> <td data-bbox="1127 1037 1458 1304">The policies are reinstated and the status of the policies is changed to the one defined in the Policy Status after Processing Reinstatement Upload Request parameter of the C1-REN-VALID algorithm.</td> </tr> <tr> <td data-bbox="878 1310 1122 1388">Bill Group Sorting</td> <td data-bbox="1127 1310 1458 1388">The sort ID is defined for the respective bill group.</td> </tr> <tr> <td data-bbox="878 1394 1122 1522">Bill Group Derivation and Pricing Parameters</td> <td data-bbox="1127 1394 1458 1522">The derivation and pricing parameters are defined for the respective bill group and sort ID combination.</td> </tr> </tbody> </table> <p>In addition, the status of the upload request is changed to Processed.</p>	Upload Request	Behaviour	Bill Cycle Update	The bill cycle information is updated for the accounts.	Billable Charge	The billable charges are created.	Contract Rider Update	The contract rider information is updated for the contracts.	Hold Request	The hold requests are created.	Refund Request	The refund requests are created.	Write Off Request	The write off requests are created.	Policy Reinstatement	The policies are reinstated and the status of the policies is changed to the one defined in the Policy Status after Processing Reinstatement Upload Request parameter of the C1-REN-VALID algorithm.	Bill Group Sorting	The sort ID is defined for the respective bill group.	Bill Group Derivation and Pricing Parameters	The derivation and pricing parameters are defined for the respective bill group and sort ID combination.
Upload Request	Behaviour																				
Bill Cycle Update	The bill cycle information is updated for the accounts.																				
Billable Charge	The billable charges are created.																				
Contract Rider Update	The contract rider information is updated for the contracts.																				
Hold Request	The hold requests are created.																				
Refund Request	The refund requests are created.																				
Write Off Request	The write off requests are created.																				
Policy Reinstatement	The policies are reinstated and the status of the policies is changed to the one defined in the Policy Status after Processing Reinstatement Upload Request parameter of the C1-REN-VALID algorithm.																				
Bill Group Sorting	The sort ID is defined for the respective bill group.																				
Bill Group Derivation and Pricing Parameters	The derivation and pricing parameters are defined for the respective bill group and sort ID combination.																				

Note:

The **Submit** button appears when the upload request is in the **Validated** status.

Related Topics

For more information on...	See...
Upload Request screen	Upload Request (Used for Viewing) on page 1986

For more information on...	See...
Upload Request zone	Upload Request on page 1986
How to search for an upload request	Searching for an Upload Request on page 1981

Approving an Upload Request

You can view the number of upload requests which are pending for approval in the **Upload Request** screen. The approver can review, and accordingly approve or reject the upload request based on the observations.

Note: The system will not allow you to approve or reject an upload request submitted by you.

Procedure

To approve an upload request:

1. Do either of the following:

If you want to...	Then...
Approve a upload request through the Upload Request screen	<ol style="list-style-type: none"> 1. Search for the upload request in the Upload Request screen. 2. In the Search Results section, click the link in the Upload Request Information column corresponding to the upload request which you want to review.
Approve a upload request from the To Do List screen	<ol style="list-style-type: none"> 1. Click the Menu link in the Application toolbar. A list appears. 2. From the Main menu, select To Do and then click To Do List. The To Do Type for User Search window appears. 3. Enter the required To Do type in the respective field. 4. Click the Search button corresponding to the To Do Type field. The To Do List screen appears. 5. Select the Open option from the Filter by list to view all unassigned To Dos. 6. Click the link in the Message column corresponding to the To Do of the upload request that you want to review.

The **Upload Request** screen appears.

2. Review the upload request details.
3. Click the **Approve** button in the **Upload Request** zone.

The system behaves in the following manner:

If...	Then...																				
<p>The number of valid records in the upload request does not exceed the online record process limit defined in the C1-DEFERUPLD algorithm</p>	<p>The following table lists the behavior for the different upload requests:</p> <table border="1" data-bbox="889 348 1464 1455"> <thead> <tr> <th data-bbox="898 354 1133 394">Upload Request</th> <th data-bbox="1138 354 1461 394">Behavior</th> </tr> </thead> <tbody> <tr> <td data-bbox="898 401 1133 478">Bill Cycle Update</td> <td data-bbox="1138 401 1461 478">The bill cycle information is updated for the accounts.</td> </tr> <tr> <td data-bbox="898 485 1133 562">Billable Charge</td> <td data-bbox="1138 485 1461 562">The billable charges are created.</td> </tr> <tr> <td data-bbox="898 569 1133 674">Contract Rider Update</td> <td data-bbox="1138 569 1461 674">The contract rider information is updated for the contracts.</td> </tr> <tr> <td data-bbox="898 680 1133 758">Hold Request</td> <td data-bbox="1138 680 1461 758">The hold requests are created.</td> </tr> <tr> <td data-bbox="898 764 1133 842">Refund Request</td> <td data-bbox="1138 764 1461 842">The refund requests are created.</td> </tr> <tr> <td data-bbox="898 848 1133 926">Write Off Request</td> <td data-bbox="1138 848 1461 926">The write off requests are created.</td> </tr> <tr> <td data-bbox="898 932 1133 1220">Policy Reinstatement</td> <td data-bbox="1138 932 1461 1220">The policies are reinstated and the status of the policies is changed to the one defined in the Policy Status after Processing Reinstatement Upload Request parameter of the C1-REN-VALID algorithm.</td> </tr> <tr> <td data-bbox="898 1226 1133 1304">Bill Group Sorting</td> <td data-bbox="1138 1226 1461 1304">The sort ID is defined for the respective bill group.</td> </tr> <tr> <td data-bbox="898 1310 1133 1449">Bill Group Derivation and Pricing Parameters</td> <td data-bbox="1138 1310 1461 1449">The derivation and pricing parameters are defined for the respective bill group and sort ID combination.</td> </tr> </tbody> </table> <p>In addition, the status of the upload request is changed to Processed.</p>	Upload Request	Behavior	Bill Cycle Update	The bill cycle information is updated for the accounts.	Billable Charge	The billable charges are created.	Contract Rider Update	The contract rider information is updated for the contracts.	Hold Request	The hold requests are created.	Refund Request	The refund requests are created.	Write Off Request	The write off requests are created.	Policy Reinstatement	The policies are reinstated and the status of the policies is changed to the one defined in the Policy Status after Processing Reinstatement Upload Request parameter of the C1-REN-VALID algorithm.	Bill Group Sorting	The sort ID is defined for the respective bill group.	Bill Group Derivation and Pricing Parameters	The derivation and pricing parameters are defined for the respective bill group and sort ID combination.
Upload Request	Behavior																				
Bill Cycle Update	The bill cycle information is updated for the accounts.																				
Billable Charge	The billable charges are created.																				
Contract Rider Update	The contract rider information is updated for the contracts.																				
Hold Request	The hold requests are created.																				
Refund Request	The refund requests are created.																				
Write Off Request	The write off requests are created.																				
Policy Reinstatement	The policies are reinstated and the status of the policies is changed to the one defined in the Policy Status after Processing Reinstatement Upload Request parameter of the C1-REN-VALID algorithm.																				
Bill Group Sorting	The sort ID is defined for the respective bill group.																				
Bill Group Derivation and Pricing Parameters	The derivation and pricing parameters are defined for the respective bill group and sort ID combination.																				

If...	Then...																				
<p>The number of valid records in the upload request exceeds the online record process limit defined in the C1-DEFERUPLD algorithm</p>	<p>The system changes the status of the upload request to Deferred Processing. When the Upload Request Periodic Monitor (C1-UPLRQ) batch is invoked, the system checks whether there are any upload requests in the Deferred Processing status. If there is an upload request in the Deferred Processing status, the system behaves in the following manner for the different upload requests:</p> <table border="1" data-bbox="889 485 1468 1591"> <thead> <tr> <th data-bbox="896 493 1133 533">Upload Request</th> <th data-bbox="1138 493 1461 533">Behavior</th> </tr> </thead> <tbody> <tr> <td data-bbox="896 539 1133 617">Bill Cycle Update</td> <td data-bbox="1138 539 1461 617">The bill cycle information is updated for the accounts.</td> </tr> <tr> <td data-bbox="896 623 1133 701">Billable Charge</td> <td data-bbox="1138 623 1461 701">The billable charges are created.</td> </tr> <tr> <td data-bbox="896 707 1133 814">Contract Rider Update</td> <td data-bbox="1138 707 1461 814">The contract rider information is updated for the contracts.</td> </tr> <tr> <td data-bbox="896 821 1133 898">Hold Request</td> <td data-bbox="1138 821 1461 898">The hold requests are created.</td> </tr> <tr> <td data-bbox="896 905 1133 982">Refund Request</td> <td data-bbox="1138 905 1461 982">The refund requests are created.</td> </tr> <tr> <td data-bbox="896 989 1133 1066">Write Off Request</td> <td data-bbox="1138 989 1461 1066">The write off requests are created.</td> </tr> <tr> <td data-bbox="896 1073 1133 1360">Policy Reinstatement</td> <td data-bbox="1138 1073 1461 1360">The policies are reinstated and the status of the policies is changed to the one defined in the Policy Status after Processing Reinstatement Upload Request parameter of the C1-REN-VALID algorithm.</td> </tr> <tr> <td data-bbox="896 1367 1133 1444">Bill Group Sorting</td> <td data-bbox="1138 1367 1461 1444">The sort ID is defined for the respective bill group.</td> </tr> <tr> <td data-bbox="896 1451 1133 1583">Bill Group Derivation and Pricing Parameters</td> <td data-bbox="1138 1451 1461 1583">The derivation and pricing parameters are defined for the respective bill group and sort ID combination.</td> </tr> </tbody> </table> <p>In addition, the status of the upload request is changed to Processed.</p>	Upload Request	Behavior	Bill Cycle Update	The bill cycle information is updated for the accounts.	Billable Charge	The billable charges are created.	Contract Rider Update	The contract rider information is updated for the contracts.	Hold Request	The hold requests are created.	Refund Request	The refund requests are created.	Write Off Request	The write off requests are created.	Policy Reinstatement	The policies are reinstated and the status of the policies is changed to the one defined in the Policy Status after Processing Reinstatement Upload Request parameter of the C1-REN-VALID algorithm.	Bill Group Sorting	The sort ID is defined for the respective bill group.	Bill Group Derivation and Pricing Parameters	The derivation and pricing parameters are defined for the respective bill group and sort ID combination.
Upload Request	Behavior																				
Bill Cycle Update	The bill cycle information is updated for the accounts.																				
Billable Charge	The billable charges are created.																				
Contract Rider Update	The contract rider information is updated for the contracts.																				
Hold Request	The hold requests are created.																				
Refund Request	The refund requests are created.																				
Write Off Request	The write off requests are created.																				
Policy Reinstatement	The policies are reinstated and the status of the policies is changed to the one defined in the Policy Status after Processing Reinstatement Upload Request parameter of the C1-REN-VALID algorithm.																				
Bill Group Sorting	The sort ID is defined for the respective bill group.																				
Bill Group Derivation and Pricing Parameters	The derivation and pricing parameters are defined for the respective bill group and sort ID combination.																				

Note: The **Approve** button appears when:

- The upload request is in the **Approval In Progress** status.
- A user with the approval To Do role is reviewing the upload request.

Related Topics

For more information on...	See...
Upload Request screen	Upload Request (Used for Viewing) on page 1986
Upload Request zone	Upload Request on page 1986
How to search for an upload request	Searching for an Upload Request on page 1981

Rejecting an Upload Request

Prerequisites

To reject an upload request, you should have:

- Rejection reasons defined in the application

Note:

While rejecting an upload request, you need to specify the reason why you want to reject the upload request. You can select the appropriate rejection reason when you have defined the reasons for the **Rejected** status of the **C1-UplRequestType** business object in the **Status Reason** screen.

The system will not allow you to approve or reject an upload request submitted by you.

Procedure

To reject an upload request:

1. Do either of the following:

If you want to	Then
Reject an upload request through the Upload Request screen	<ol style="list-style-type: none"> 1. Search for the upload request in the Upload Request screen. 2. In the Search Results section, click the link in the Upload Request Information column corresponding to the upload request which you want to review.
Reject an upload request from the To Do List screen	<ol style="list-style-type: none"> 1. Click the Menu link in the Application toolbar. A list appears. 2. From the Main menu, select To Do and then click To Do List. The To Do Type for User Search window appears. 3. Enter the required To Do type in the respective field. 4. Click the Search button corresponding to the To Do Type field. The To Do List screen appears. 5. Select the Open option from the Filter by list to view all unassigned To Dos.

If you want to	Then
	6. Click the link in the Message column corresponding to the To Do of the upload request that you want to review.

The **Upload Request** screen appears.

- Review the upload request details.
- Click the **Reject** button in the **Upload Request** zone.

The **Reject Upload Request** window appears. It contains following fields:

Field Name	Field Description	Mandatory (Yes or No)
Status Reason	Used to indicate the reason why you want to reject the upload request.	Yes
Comments	Used to specify additional information while rejecting the upload request.	No

Note: The **Reject** button appears when:

- The upload request is in the **Approval In Progress** status.
- A user with the approval To Do role is reviewing the upload request.

- Select the rejection reason from the **Status Reason** list.
- Click **Save**.

The status of the upload request is changed to **Rejected**.

Related Topics

For more information on...	See...
How to search for an upload request	Searching for an Upload Request on page 1981
Upload Request screen	Upload Request (Used for Viewing) on page 1986
Upload Request zone	Upload Request on page 1986

Viewing the Data Record Details

Procedure

To view the details of a data record:

- Search for the data record in the **Data Records** zone in the **Upload Request** screen.
- In the **Search Results** section, click the **View** () icon in the **View** column corresponding to the data record whose details you want to view.

The **Data Record Details** window appears. It contains the following fields:

Field Name	Field Description
Sr. No.	Displays the sequential number of data.
CSV Column Header	Displays name of the column in uploaded CSV file.
CSV Column Value	Displays value in the column in uploaded CSV file.

- View the details of the data record in the **Data Record Details** window.

Related Topics

For more information on...	See...
Data Record zone	Data Records on page 1988

Viewing the Log of an Upload Request

Procedure

To view the log of an upload request:

- Search for the upload request in the **Upload Request** screen.
- In the **Search Results** section, click the link in the **Upload Request Information** column corresponding to the upload request whose log you want to view.

The **Upload Request** screen appears. It consists of the following tabs:

- Main** – Displays information about the upload request. It contains the following zones:
 - Upload Request** – Displays the details of the upload request.
 - Data Records** – Lists the data records of the upload request.
- Log** – Lists the complete trail of actions performed on the upload request. This tab contains the following zone:
 - Upload Request Log** – Displays the trail of actions performed on the particular upload request.

- Click the **Log** tab.

The **Upload Request Log** zone in the **Log** tab contains the following columns:

Column Name	Column Description
Date/Time	Displays the date and time when the action was performed on the upload request.
Details	Displays the details about the action performed on the upload request.
User	Indicates the user who has performed the action on the upload request.
Log Type	Indicates the type of log.
Related Object	Indicates the object or entity which is generated when the action is performed on the upload request.
Status Reason	Indicates the reason why the upload request was rejected.

Note: You can manually add a log entry for the upload request by clicking the **Add Log Entry** link in the upper right corner of the **Upload Request Log** zone.

Related Topics

For more information on...	See...
How to search for an Upload request	Searching for an Upload Request on page 1981
How to add a log entry for an Upload request	Adding a Log Entry for an Upload Request on page 2004

Adding a Log Entry for an Upload Request**Procedure**

To add a log entry for an upload request:

1. Search for the upload request in the **Upload Request** screen.
2. In the **Search Results** section, click the link in the **Upload Request Information** column corresponding to the upload request whose log you want to edit.

The **Upload Request** screen appears. It consists of the following tabs:

- **Main** – Displays information about the upload request. It contains the following zones:
 - **Upload Request** – Displays the details of the upload request.
 - **Data Records** – Lists the data records of the upload request.
- **Log** – Lists the complete trail of actions performed on the upload request. This tab contains the following zone:
 - **Upload Request Log** – Displays the trail of actions performed on the particular upload request.

3. Click the **Log** tab.

The **Log** tab appears.

4. Click the **Add Log Entry** link in the upper right corner of the **Upload Request Log** zone.

The **Add Upload Request Log** window appears. It contains the following fields:

Field Name	Field Description	Mandatory (Yes or No)
Upload Request Information	Displays information about the upload request.	Not applicable
Log Details	Used to specify additional comments for the upload request.	Yes

5. Enter the comments in the **Log Details** field.

6. Click **Save**.

The log entry is added in the **Upload Request Log** zone.

Related Topics

For more information on...	See...
How to search for an upload request	Searching for an Upload Request on page 1981

Chapter 28

General Ledger (GL) Accounting Template

Topics:

- [GL Accounting Template \(Without Approval\) Status Transition](#)
- [GL Accounting Template \(With Approval\) Status Transition](#)
- [Algorithms Used in C1- GLAT](#)
- [Prerequisites](#)
- [GL Accounting Template \(Used for Searching\)](#)
- [GL Accounting Template \(Used for Viewing\)](#)

Oracle Revenue Management and Billing until now created FT GL entries while generating the financial transactions for adjustments, payments, and bill segments. The FT GL entries were created using the distribution codes from the adjustment type, rate component, billable charge pass through line, or contract type depending on the type of financial transaction. Now, the system enables you to override the distribution code used for creating FT GL entries using the GL Accounting Template feature.

The system allows you to define a GL Accounting template for each process and sub processes combination for a date range. Based on the parameters defined in the **FT Generation** algorithms, the system either uses the standard process or GL Accounting Template for FT GL creation. The GL Accounting template for the specified process and sub processes combination which is effective on the accounting date is used for FT GL creation.

There should be at least one debit and credit lines in the GL Accounting template. You can define maximum 10 lines in the GL Accounting template. Each line should contain the following information:

- Whether the line should be used to create a debit FT GL entry or credit FT GL entry
- Conditional algorithm (created using the **C1-GLATLC** algorithm type) to indicate whether the line should be used to create the FT GL entry or not
- Distribution code to indicate the GL Account against which the FT GL entry should be created
- User defined amount, such as Amount 01, Amount 02, or Amount 03

The line with the Amount 01 user defined amount is used to create balancing FT GL entry against the contract type. The line with the Amount 02, Amount 03, ..., and Amount 10 user defined amount is used to create FT GL entries for bill segment calculation lines, non-calculated adjustments, adjustment calculation lines, or payments. In case of bill segments and calculated adjustments, the lines with the Amount 02, Amount 03, ..., Amount 10 user defined amount are mapped to calculation line amounts based on the rate component sequence.

You can optionally configure the system to use the approval workflow process while activating or deactivating the GL Accounting templates. If you want to enable the approval workflow process, you need to define algorithms using the following algorithm types:

- C1-GLATAPPEN
- C1-GLATSUB

If the **Approval Required (Y or N)** parameter in an algorithm created using the **C1-GLATSUB** algorithm type is set to **Y**, then on submitting or deactivating the GL Accounting template, the approval workflow process creates a To Do

for the approver to review the GL Accounting template. Once the approver approves a GL Accounting template, the status of the GL Accounting template is set to **Active** or **Inactive**.

We are supporting the following process and sub processes combinations while creating the GL Accounting template:

Process	BS	AD	PS
Sub Process 1	Contract Type	Adjustment Type	Bank Account
Sub Process 2	Division	Contract Type	Contract Type
Sub Process 3	Rate Schedule	Division	Division
Sub Process 4	-	-	-
Sub Process 5	-	-	-

For example, you can define the following the GL Accounting templates using the above supported process and sub processes combinations:

GL Accounting Template	Process	Sub Process 1	Sub Process 2	Sub Process 3
GLAT1	BS	CT1	D1	RS1
GLAT2	BS	CT2	D1	RS1
GLAT3	BS	CT3	D2	RS2
GLAT4	PS	BA1	CT1	D1
GLAT5	PS	BA2	CT2	D2
GLAT6	AD	AT1	CT1	D1
GLAT7	AD	AT1	CT2	D2

While creating the GL Accounting template for BS and AD processes, you need to ensure that the line with the Amount 1 user defined amount is a debit line. However, while creating the GL Accounting template for PS process, you need to ensure that the line with the Amount 1 user defined amount is a credit line.

Based on the customer requirements, you can define GL Accounting template for various custom process and sub processes combinations.

The **Create Additional FT GL Entries** parameter is added in the **Assign GL Account to Financial Transaction (C1-GLASN)** and **Assign GL Account to Financial Transaction (GLASSGN2)** batches. If you set this parameter to **Y**, the **C1-GLCE** algorithm is invoked. Based on the parameters defined in the algorithm, the system checks whether there is a GL Accounting template which is effective on the accounting date for the specified process and sub processes combination. If the effective GL Accounting template is available, the system creates additional FT GL entries for the financial transactions. If the financial transaction's currency is different from the division's base currency, the algorithm will create FT GL extension for the respective financial transaction.

Two new parameters are added in the **ADJT-NM**, **ADJT-AC**, **ADJT-TA**, **ADJT-TC**, **ADJT-AD**, **ADJT-GL**, **PSEG-NM**, **PSEG-AC**, **PSEG-CA**, **BSBF-BA**, **BSBF-LO** algorithm types:

- **Use GL Accounting Template (Y or N)** - Indicates whether the FT GL entries should be created using the lines in the GL Accounting template. The valid values are **Y** and **N**.
- **Show the GL Accounting Template Error When Header Record Not Found (Y or N)** - Indicates whether you want to show error message when the effective GL Accounting template is not available for the process and sub processes combination. If you set the value of this parameter to **N**, the algorithm uses the standard process for FT GL creation when the effective GL Accounting template is not available.

The following table explains how the algorithms created using the following algorithm types create FT GL entries:

Algorithm Type	Use GL Accounting Template (Y or N)	Calculated Adjustment Distribution Code Source (AT - Adjustment Type, CL - Calc Lines)	Algorithm Behaviour
ADJT-NM, ADJT-AC, ADJT-TA, ADJT-TC, ADJT-AD, and ADJT-GL	N	CL	Creates FT GL for the adjustment calculation line using the distribution code on the respective rate component and the balancing FT GL using the distribution code on contract type.
ADJT-NM, ADJT-AC, ADJT-TA, ADJT-TC, ADJT-AD, and ADJT-GL	Y	CL	Creates debit and credit FT GL entries using the lines in the GL Accounting template.
ADJT-NM, ADJT-AC, ADJT-TA, ADJT-TC, ADJT-AD, and ADJT-GL	N	AT	Creates FT GL for the adjustment using the distribution code on the respective adjustment type and the balancing FT GL using the distribution code on contract type.
ADJT-NM, ADJT-AC, ADJT-TA, ADJT-TC, ADJT-AD, and ADJT-GL	Y	AT	Creates debit and credit FT GL entries using the lines in the GL Accounting template.

If the **Use GL Accounting Template (Y or N)** parameter is set to **N** in the algorithms created using the **PSEG-NM**, **PSEG-AC**, and **PSEG-CA** algorithm types, the system creates FT GL for the payment segment using the distribution code on the respective payment segment type and the balancing FT GL using the distribution code on contract type. However, if the **Use GL Accounting Template (Y or N)** parameter is set to **Y**, the system creates debit and credit FT GL entries using the lines in the GL Accounting template.

If the **Use GL Accounting Template (Y or N)** parameter is set to **N** in the algorithms created using the **BSBF-BA** and **BSBF-LO** algorithm types, the system behaves in the following manner:

If the bill segment is...	Then, the system...
Created from a billable charge with SQI and/or price item details	Creates FT GL for the bill segment calculation line using the distribution code on the respective rate component and the balancing FT GL using the distribution code on contract type.
Created from a pass through billable charge	Creates FT GL for the pass through line using the distribution code on the respective pass through line and the balancing FT GL using the distribution code on contract type.
Created from a billable charge with pass through charges, SQI, and price item details	Creates... <ul style="list-style-type: none"> • FT GL for the bill segment calculation line using the distribution code on the respective rate component • FT GL for the pass through line using the distribution code on the respective pass through line • Balancing FT GL using the distribution code on contract type
A post processing bill segment	Creates FT GL for the post processing FT using the distribution code on the respective rate component and the balancing FT GL using the distribution code on contract type.

However, if the **Use GL Accounting Template (Y or N)** parameter is set to **Y** in the algorithms created using the **BSBF-BA** and **BSBF-LO** algorithm types, the system behaves in the following manner:

If the bill segment is...	Then, the system...
Created from a billable charge with SQI and/or price item details	Creates debit and credit FT GL entries using the lines in the GL Accounting template.
Created from a pass through billable charge	Does not use the GL Accounting template. It creates FT GL for the pass through line using the distribution code on the respective pass through line and the balancing FT GL using the distribution code on contract type.

If the bill segment is...	Then, the system...
Created from a billable charge with pass through charges, SQI, and price item details	Creates... <ul style="list-style-type: none"> • FT GL for bill segment calculation line using the lines in the GL Accounting template. • FT GL for the pass through line using the distribution code on the respective pass through line. • Balancing FT GL using the line in the GL Accounting template.
A post processing bill segment	Creates debit and credit FT GL entries using the lines in the GL Accounting template.

GL Accounting Template (Without Approval) Status Transition

The following figure graphically indicates how a GL Accounting Template moves from one status to another when approval workflow is off:

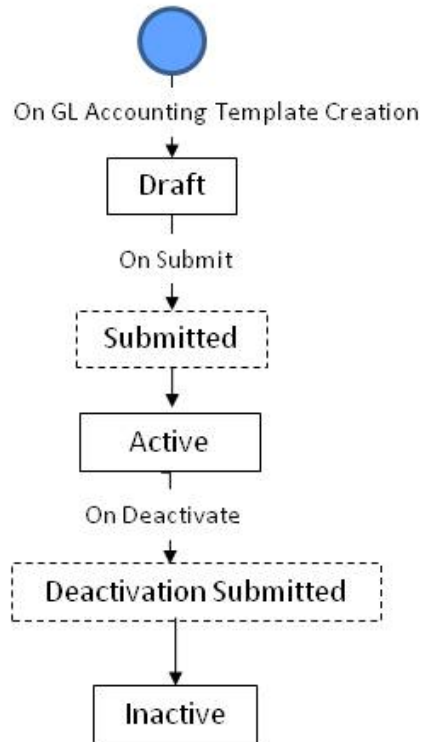

GL Accounting Template (With Approval) Status Transition

The following figure graphically indicates how a GL Accounting Template moves from one status to another when approval workflow is on:

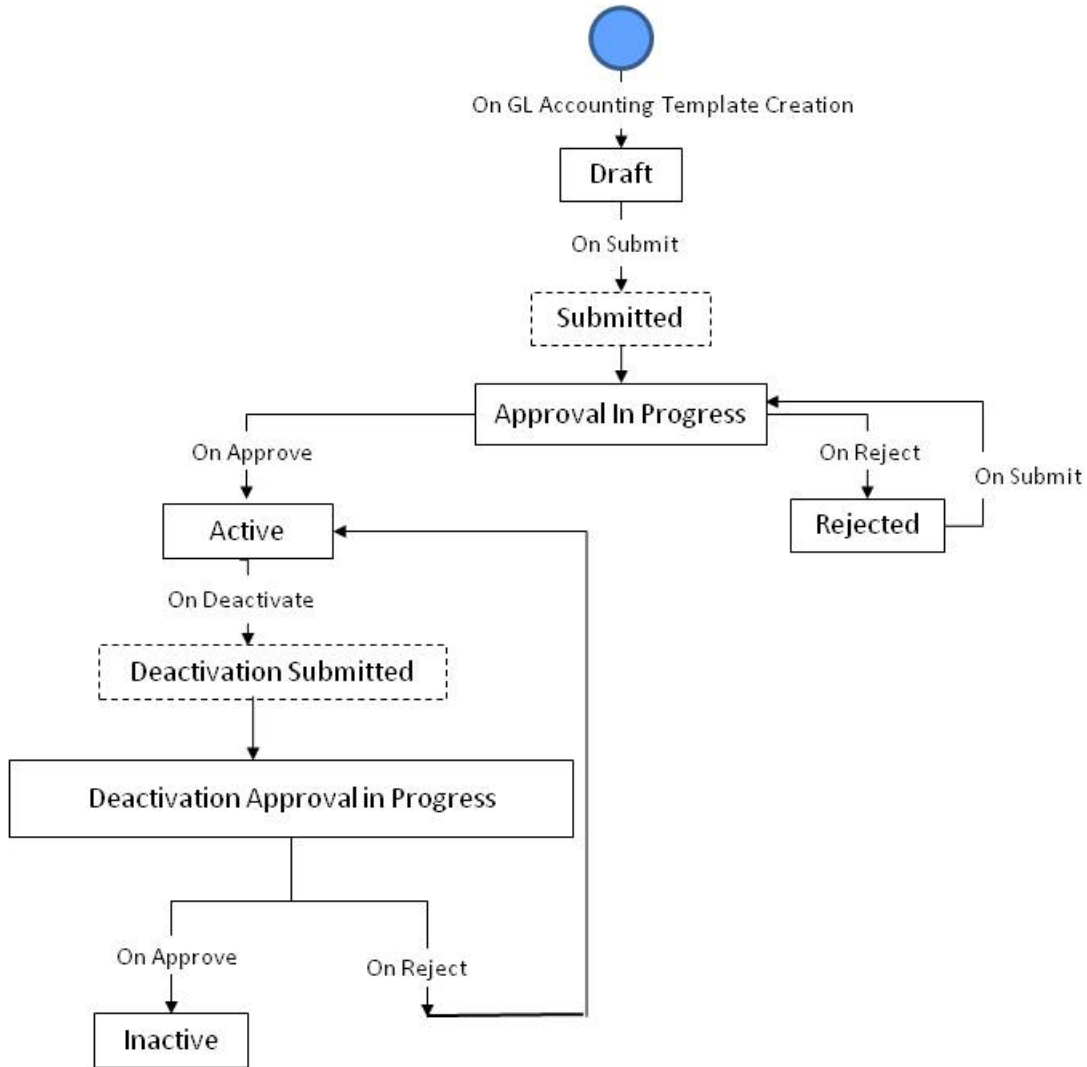

Algorithms Used in C1- GLAT

The following table lists the algorithms which are attached to the **C1-GLAT** business object:

System Event	Algorithm	Algorithm Type	Description
Information	C1-GLAT-INF	C1-GLAT-INF	This algorithm generates the GLAT information string which appears throughout the application. This algorithm concatenates the following fields: <ul style="list-style-type: none"> GLAT Description GLAT Status Description GLAT ID

The following table lists the algorithms which are used in the lifecycle of the **C1-GLAT** business object:

Status	System Event	Algorithm	Algorithm Type	Description
Draft	Exit	F1-TODOCOMPL	F1-TODOCOMPL	This algorithm type completes To Do entries that are linked to an object when the object exits a given state. The system finds all open To Do entries with drill keys for the current business object's primary key, and completes them, unless the To Do entry's type has been configured with an Exclude To Do Type Characteristic Type indicating that it should not be automatically completed.
Submitted	Enter	C1-GLATSUB	C1-GLATSUB	This algorithm checks the following: <ul style="list-style-type: none"> If soft parameter value is set to Y then approval workflow will be triggered.
Approval in Progress	Enter	C1-GLATAPPEN	C1-GLATAPPEN	This algorithm creates the To Do based on the Approval To Do Type configured in algorithm.
Approval in Progress	Exit	C1-GLATAPPEX	C1-GLATAPPEX	This algorithm checks whether an approver is associated with the approval To Do Role specified in the C1-GLATAAPEN Algorithm. It does not allow the submitter to approve or reject the GLAT request.
Approval in Progress	Exit	F1-TODOCOMPL	F1-TODOCOMPL	This algorithm type completes To Do entries that are linked to an object when the object exits a given state. The system finds all open To Do entries with drill keys for the current business object's primary key, and completes them, unless the To Do entry's type has been configured with an Exclude To Do Type Characteristic Type indicating that it should not be automatically completed.
Active	-	-	-	-
Deactivation Submitted	Enter	C1-GLATSUB	C1-GLATSUB	This algorithm checks the following: <ul style="list-style-type: none"> If soft parameter value is set to Y then approval workflow will be triggered.
Deactivation Approval In Progress	Enter	C1-GLATAPPEN	C1-GLATAPPEN	This algorithm creates the To Do based on the Approval To Do Type configured in algorithm.

Status	System Event	Algorithm	Algorithm Type	Description
Deactivation Approval In Progress	Exit	C1-GLATAPPEX	C1-GLATAPPEX	This algorithm checks whether an approver is associated with the approval To Do Role specified in the C1-GLATAAPEN Algorithm. It does not allow the submitter to approve or reject the GLAT request.
Deactivation Approval In Progress	Exit	F1-TODOCOMPL	F1-TODOCOMPL	This algorithm type completes To Do entries that are linked to an object when the object exits a given state. The system finds all open To Do entries with drill keys for the current business object's primary key, and completes them, unless the To Do entry's type has been configured with an Exclude To Do Type Characteristic Type indicating that it should not be automatically completed.
Rejected	Exit	F1-TODOCOMPL	F1-TODOCOMPL	This algorithm type completes To Do entries that are linked to an object when the object exits a given state. The system finds all open To Do entries with drill keys for the current business object's primary key, and completes them, unless the To Do entry's type has been configured with an Exclude To Do Type Characteristic Type indicating that it should not be automatically completed.
Inactive	-	-	-	-

Prerequisites

To setup the GL Accounting Template, you need to do the following:

- Define rejected status reasons for the **C1-GLAT** business object
- Define deactivated status reasons for the **C1-GLAT** business object
- Assign the **C1-GLAT** To Do type to a To Do role whose users must receive To Do generated while submitting a template for approval
- Define the required algorithms, for approval and To Do type role and configurations

GL Accounting Template (Used for Searching)

The **GL Accounting Template** screen allows you to search for a template using various search criteria. It also allows you to create template. Through this screen, you can navigate to the following screen:

- [GL Accounting Template \(Used for Viewing\)](#) on page 2019

This screen consists of the following zones:

- [Search GL Accounting Template](#) on page 2014
- [GL Accounting Template Lines](#) on page 2015

Search GL Accounting Template

The **Search GL Accounting Template** zone allows you to search for GL accounting templates using various search criteria. This zone contains the following two sections:

- **Search Criteria** — The **Search Criteria** section contains the following fields:

Field Name	Field Description	Mandatory (Yes or No)
Template ID	Used to search a particular template.	No
Description	Used to specify the description of a template.	No
Status	Used to indicate the status of the template. The valid values are: <ul style="list-style-type: none"> • Draft • Approval In Progress • Deactivation Approval In Progress • Active • Inactive • Rejected 	No
Process	Used to search a particular process.	No
Sub Process 1	Used to search a particular Sub Process 1.	No
Sub Process 2	Used to search a particular Sub Process 2.	No
Sub Process 3	Used to search a particular Sub Process 3.	No
Sub Process 4	Used to search a particular Sub Process 4.	No
Sub Process 5	Used to search a particular Sub Process 5.	No
Effective Start Date	Used to search templates which are effective from a particular date.	No
Effective End Date	Used to search templates which are effective till a particular date.	No

Note: You must specify at least one search criterion while searching for a template.

- **Search Results** — On clicking the **Search** button, the search results appear based on the specified search criteria. The **Search Results** section contains the following columns:

Column Name	Column Description
Process	Displays the process.
GL Accounting Template Request Information	Displays information about the template. <p>Note: It has a link. On clicking the link, the GL Accounting Template screen appears where you can view the details of the respective template.</p>
Description	Displays the description of process.

Column Name	Column Description
Sub Process 1	Displays the Sub Process 1.
Sub Process 2	Displays the Sub Process 2.
Sub Process 3	Displays the Sub Process 3.
Sub Process 4	Displays the Sub Process 4.
Sub Process 5	Displays the Sub Process 5.
Effective Start Date	Displays the date from when the template is effective.
Effective End Date	Displays the date till when the template is effective.
Status	Displays the status of template.

Related Topics

For more information on...	See...
How to search for a GL Accounting Template	Searching for a GL Accounting Template on page 2016
How to view the details of a GL Accounting Template	Viewing the GL Accounting Template Details on page 2018
How to create a GL Accounting Template	Creating a GL Accounting Template on page 2016
GL Accounting Template Lines zone	GL Accounting Template Lines on page 2015

GL Accounting Template Lines

The **GL Accounting Template Lines** zone displays the details of the template lines. This zone contains the following columns:

Column Name	Column Description
Credit/Debit	Displays whether the template lines are of credit or debit.
Conditional Algorithm	Displays the algorithm that specified that template line is valid or not.
Distribution Code	Displays the distribution code which indicates the template associated with the charge.
User Defined Amount Field	Displays the amount to be used in a template line.

Note: By default, the **GL Accounting Template Lines** zone does not appear in the **GL Accounting Template** screen. It appears when you click the **Broadcast** () icon corresponding to the template in the **Search Results** section.

Related Topics

For more information on...	See...
How to search for a GL Accounting Template	Searching for a GL Accounting Template on page 2016
How to view the details of a GL Accounting Template	Viewing the GL Accounting Template Details on page 2018
How to create a GL Accounting Template	Creating a GL Accounting Template on page 2016
Search GL Accounting Template zone	Search GL Accounting Template on page 2014

Searching for a GL Accounting Template

Procedure

To search for a GL Accounting template:

1. Click the **Admin** link in the **Application** toolbar.
A list appears.
2. From the **Admin** menu, select **G** and then click **GL Accounting Template**.
The **GL Accounting Template** screen appears.
3. Enter the search criteria in the **Search GL Accounting Template** zone.

Note: ORMB search engine supports wildcard search, where you can substitute the percentage (%) symbol as a stand in for any word or letter in a search criteria. You can use the ‘%’ wildcard character in all input fields except the date and ID fields. The ‘%’ wildcard character is suffixed automatically at the end of the partial search criteria. Therefore, you may or may not specify the wildcard character at the end of the partial search criteria. However, you have to prefix the wildcard character manually wherever required.

4. Click **Search**.

A list of templates that meet the search criteria appears in the **Search Results** section.

Related Topics

For more information on...	See...
GL Accounting Template screen	GL Accounting Template (Used for Searching) on page 2013
Search GL Accounting Template zone	Search GL Accounting Template on page 2014

Creating a GL Accounting Template

Prerequisites

To create a GL Accounting template, you should have:

- Conditional Algorithms and Distribution codes defined in the application.

Procedure

To create a GL Accounting template:

1. Click the **Admin** link in the **Application** toolbar.
A list appears.
2. From the **Admin** menu, select **G** and then click **GL Accounting Template**.
The **GL Accounting Template** screen appears.
3. Click the **Add** button in the **Page Title** area of the **GL Accounting Template** screen.

The **GL Accounting Template** screen appears. It contains the following sections:

- **Main** — Used to specify basic details about the template. This section contains the following fields:

Field Name	Field Description	Mandatory (Yes or No)
Process	Used to specify a particular process.	Yes
Description	Used to indicate the description of a process.	Yes
Sub Process 1	Used to specify a Sub Process 1.	Yes (Conditional) Note: This field is required if Process is Bill Segment or Payment Segment or Adjustments
Sub Process 2	Used to specify a Sub Process 2.	Yes (Conditional) Note: This field is required if Process is Bill Segment or Payment Segment or Adjustments
Sub Process 3	Used to specify a Sub Process 3.	Yes (Conditional) Note: This field is required if Process is Bill Segment or Payment Segment or Adjustments.
Sub Process 4	Used to specify a Sub Process 4.	No
Sub Process 5	Used to specify a Sub Process 5.	No
Effective Start Date	Used to specify date for a template which is effective from a particular date.	Yes
Effective End Date	Used to specify date for a template which is effective till a particular date.	No

- **GL Accounting Template Lines** —Used to specify the template lines in a GL accounting template. This section contains the following columns:

Column Name	Column Description	Mandatory (Yes or No)
Sequence No	Used to specify the sequence number.	Yes
Credit/Debit	Used to indicate whether template lines are of credit or debit.	Yes
Conditional Algorithm	Used to specify the algorithm which specifies that template line is valid or not.	No
Distribution Code	Used to indicate the distribution code which indicates the template associated with the charge.	Yes
User Defined Amount Field	Used to indicate the amount to be used in a template line.	Yes

4. Enter the required details

Note:

You can search for a conditional algorithm and distribution code by clicking the **search** (🔍) icon corresponding to the respective field.

At least one credit and one debit line is required while defining a template.

System will not allow to add a template having same set of process, sub processes and effective date. If there is a template already created and its status is Inactive, then only template can be created with same set of process, sub processes and effective date.

Each conditional line must have unique User Defined Amount Field value.

5. Add template lines for a template defined.

6. Click **Save**.

The GL Accounting template is created and the status of the template is set to **Draft**. The **GL Accounting Template** screen appears with the details of template.

Related Topics

For more information on...	See...
GL Accounting Template screen	GL Accounting Template (Used for Searching) on page 2013
How to edit a GL Accounting Template	Editing a GL Accounting Template on page 2022

Viewing the GL Accounting Template Details**Procedure**

To view the details of a GL Accounting Template:

1. Search for the template in the **GL Accounting Template** screen.
2. In the **Search Results** section, click the link in the **GL Accounting Template Information** column corresponding to the template whose details you want to view.

The **GL Accounting Template** screen appears. It consists of the following tabs:

- **Main** – Displays information about the template. It contains the following zone:
 - **GL Accounting Template** – Displays the details of the template.
- **Log** – Lists the complete trail of actions performed on the template. This tab contains the following zone:
 - **GL Accounting Template Log** – Displays the trail of actions performed on the particular template.

3. View the details of the template in the **GL Accounting Template** zone.

Related Topics

For more information on...	See...
GL Accounting Template screen	GL Accounting Template (Used for Searching) on page 2013
GL Accounting Template zone	GL Accounting Template on page 2019
How to search for a GL Accounting Template	Searching for a GL Accounting Template on page 2016
How to view a GL Accounting Template Lines	Viewing the GL Accounting Template Lines Details on page 2019

Viewing the GL Accounting Template Lines Details

Procedure

To view the details of a GL Accounting Template Lines:

1. Search for the template in the **GL Accounting Template** screen.
2. In the **Search Results** section, click the **Broadcast** () icon corresponding to the template in the **Search Results** section.

The **GL Accounting Template Lines** zone appears in the **GL Accounting Template** screen.

3. View the details of the template lines in the **GL Accounting Template Lines** zone.

Related Topics

For more information on...	See...
GL Accounting Template screen	GL Accounting Template (Used for Searching) on page 2013
GL Accounting Template zone	GL Accounting Template on page 2019
GL Accounting Template Lines zone	GL Accounting Template Lines on page 2015

GL Accounting Template (Used for Viewing)

Once you create a template, the **GL Accounting Template** screen allows you to:

- View the details of a template
- Edit the details of a template
- Delete a template
- Submit a template for approval
- Approve or reject a template
- Deactivate a template

This screen consists of the following tabs:

- **Main** – Displays information about the template. It contains the following zone:
 - **GL Accounting Template** – Displays the details of the template.
- **Log** — Lists the complete trail of actions performed on the template. This tab contains the following zone:
 - **GL Accounting Template Log** – Displays the trail of actions performed on the particular template.

GL Accounting Template - Main

The **Main** tab on the **GL Accounting Template** contains the following zone:

[GL Accounting Template](#) on page 2019

GL Accounting Template

The **GL Accounting Template** zone displays the details of the template. This zone contains the following sections:

- **Main** — This section provides basic information about the GL Accounting template. It contains the following fields:

Field Name	Field Description
GL Accounting Template Information	Displays information about the template
Status	Indicates the status of the template.
Process	Displays the process.
Description	Displays the description of the process.
Sub Process 1	Displays the Sub Process 1.
Sub Process 2	Displays the Sub Process 2.
Sub Process 3	Displays the Sub Process 3.
Sub Process 4	Displays the Sub Process 4.
Sub Process 5	Displays the Sub Process 5.
Effective Start Date	Displays the date from when the template is effective.
Effective End Date	Displays the date till when the template is effective.

- **GL Accounting Template Lines** — Lists the GL Accounting template lines. It contains the following columns:

Column Name	Column Description
Sequence No	Displays the sequence number.
Credit/Debit	Displays whether the template lines are of credit or debit.
Conditional Algorithm	Displays the algorithm that specified that template line is valid or not.
Distribution Code	Displays the distribution code which indicates the template associated with the charge.
User Defined Amount Field	Displays the amount to be used in a template line.

- **Record Actions** — This section contains the following buttons:

Button Name	Button Description
Edit	Used to edit the details of the template.
	Note: The Edit button appears when the template is in the Draft or Rejected status.
Delete	Used to delete the template.
	Note: The Delete button appears when the template is in the Draft or Rejected status.
Submit	Used to activate the template.
	Note: The Submit button appears when the template is in the Draft or Rejected status.

Button Name	Button Description
Approve	Used to approve the template.
	Note: the Approve button appears when the template is in the Approval In Progress or Deactivation Approval In Progress status.
Reject	Used to reject the template.
	Note: the Reject button appears when the template is in the Approval In Progress or Deactivation Approval In Progress status.
Deactivate	Used to deactivate the active template.
	Note: The Deactivate button appears when the template is in the Active status.

- **Record Information** — This section contains the following fields:

Field Name	Field Description
Business Object	Indicates the business object using which the template is created. In addition, a context menu appears corresponding to this field which helps in navigating to other screens in the application.
	Note: It has a link. On clicking the link, the Business Object screen appears where you can view the details of the respective business object.

GL Accounting Template - Log

The **Log** tab on the **GL Accounting Template** screen contains the following zone:

[GL Accounting Template Log](#) on page 2021

GL Accounting Template Log

The **GL Accounting Template Log** zone on the **GL Accounting Template** screen lists the complete trail of actions performed on the GL Accounting template. This zone contains the following columns:

Column Name	Column Description
Date/Time	Displays the date and time when the action was performed on the template.
Details	Displays the details about the action performed on the template.
User	Indicates the user who has performed the action on the template.
Log Type	Indicates the type of log.
Related Object	Indicates the object or entity which is generated when the action is performed on the template.
Status Reason	Displays the status reason of action performed on the template.

Note: You can manually add a log entry for the template by clicking the **Add Log Entry** link in the upper right corner of the **GL Accounting Template Log** zone.

The **Add GL Accounting Template Log** window appears. Enter **Log Details** and click **Save**. The GL Accounting Template log is added.

Related Topics

For more information on...	See...
How to view the log of a GL Accounting Template	Viewing the Log of a GL Accounting Template on page 2029

Editing a GL Accounting Template**Procedure**

To edit a GL Accounting Template:

1. Search for the template in the **GL Accounting Template** screen.
2. In the **Search Results** section, click the link in the **GL Accounting Template Information** column corresponding to the template whose details you want to edit.

The **GL Accounting Template** screen for editing appears.

3. Click the **Edit** button in the **GL Accounting Template** zone.

Note: The **Edit** button appears when the template is in the **Draft** or **Rejected** status.

The **GL Accounting Template** screen appears. It contains the following sections:

- **Main** — Used to specify basic details about the template. This section contains the following fields:

Field Name	Field Description	Mandatory (Yes or No)
Process	Used to specify a particular process.	Yes
Description	Used to indicate the description of a process.	Yes
Sub Process 1	Used to specify a Sub Process 1.	Yes (Conditional)
		Note: This field is required if Process is Bill Segment or Payment Segment or Adjustments
Sub Process 2	Used to specify a Sub Process 2.	Yes (Conditional)
		Note: This field is required if Process is Bill Segment or Payment Segment or Adjustments
Sub Process 3	Used to specify a Sub Process 3.	Yes (Conditional)
		Note: This field is required if Process is Bill Segment or Payment Segment or Adjustments.
Sub Process 4	Used to specify a Sub Process 4.	No
Sub Process 5	Used to specify a Sub Process 5.	No
Effective Start Date	Used to specify date for a template which is effective from a particular date.	Yes

Field Name	Field Description	Mandatory (Yes or No)
Effective End Date	Used to specify date for a template which is effective till a particular date.	No

- **GL Accounting Template Lines** — Used to specify the template lines in a GL accounting template. This section contains the following columns:

Column Name	Column Description	Mandatory (Yes or No)
Sequence No	Used to specify the sequence number.	Yes
Credit/Debit	Used to indicate whether template lines are of credit or debit.	Yes
Conditional Algorithm	Used to specify the algorithm which specifies that template line is valid or not.	No
Distribution Code	Used to indicate the distribution code which indicates the template associated with the charge.	Yes
User Defined Amount Field	Used to indicate the amount to be used in a template line.	Yes

Note:

If you want to specify more than one template lines, click the **Add (+)** icon corresponding to the sequence No and then specify the details.

However, if you want to remove a template line from the template, click the **Delete (🗑)** icon corresponding to the sequence No.

You can search for a conditional algorithm and distribution code by clicking the **search (🔍)** icon corresponding to the respective field.

At least one credit and one debit line is required while defining a template.

4. Modify the details of the template, if required.
5. Click **Save**.

The changes made to the GL Accounting template are saved.

Related Topics

For more information on...	See...
How to search for a GL Accounting Template	Searching for a GL Accounting Template on page 2016
GL Accounting Template screen	GL Accounting Template (Used for Searching) on page 2013
GL Accounting Template zone	GL Accounting Template on page 2019

Deleting a GL Accounting Template

Procedure

To delete a GL Accounting Template:

1. Search for the template in the **GL Accounting Template** screen.
2. In the **Search Results** section, click the link in the **GL Accounting Template Information** column corresponding to the template that you want to delete.

The **GL Accounting Template** screen appears.

3. Click the **Delete** button in the **GL Accounting Template** zone.

A message appears confirming whether you want to delete the template.

Note: The **Delete** button appears when the template is in the **Draft** or **Rejected** status.

4. Click **OK**.

The GL Accounting template is deleted.

Note:

You can delete a template when its status is **Draft**.

Related Topics

For more information on...	See...
How to search for a GL Accounting Template	Searching for a GL Accounting Template on page 2016
GL Accounting Template screen	GL Accounting Template (Used for Searching) on page 2013
GL Accounting Template zone	GL Accounting Template on page 2019

Submitting a GL Accounting Template

Prerequisites

To submit a GL Accounting Template, you should have:

- Process and GL Accounting template lines defined in the template.

Procedure

To submit a GL Accounting Template:

1. Search for the template in the **GL Accounting Template** screen.
2. In the **Search Results** section, click the link in the **GL Accounting Template Information** column corresponding to the template that you want to submit.

The **GL Accounting Template** screen appears.

3. Click the **Submit** button in the **GL Accounting Template** zone.

The system behaves in the following manner:

If...	Then...
Approval Required Flag is set to Yes in the C1-GLATSUB algorithm.	A To Do of the C1-GLAT To Do type is created and sent to the approver and the status of the template is changed to Approval In Progress .
Approval Required Flag is set to No in the C1-GLATSUB algorithm.	The template is created using the specified process and the status of the template is changed to Active .

Note:

The **Submit** button appears when the template is in the **Draft** or **Rejected** status.

Related Topics

For more information on...	See...
How to search for a GL Accounting Template	Searching for a GL Accounting Template on page 2016
GL Accounting Template screen	GL Accounting Template (Used for Searching) on page 2013
GL Accounting Template zone	GL Accounting Template on page 2019
How to edit a GL Accounting Template	Editing a GL Accounting Template on page 2022
How to delete a GL Accounting Template	Deleting a GL Accounting Template on page 2023

Approving a GL Accounting Template

You can view the number of GL Accounting templates which are pending for approval in the **GL Accounting Template** screen. The approver can review, and accordingly approve or reject the template based on the observations.

Note: The system will not allow you to approve or reject a template submitted by you.

Procedure

To approve a template:

1. Do either of the following:

If you want to...	Then...
Approve a GL Accounting Template through the GL Accounting template screen	<ol style="list-style-type: none"> 1. Search for the template in the GL Accounting template screen. 2. In the Search Results section, click the link in the GL Accounting Template Information column corresponding to the template which you want to review.
Approve a GL Accounting Template from the To Do List screen	<ol style="list-style-type: none"> 1. Click the Menu link in the Application toolbar. A list appears. 2. From the Main menu, select To Do and then click To Do List. The To Do Type for User Search window appears. 3. Enter C1-GLAT in the To Do Type field. 4. Click the Search button corresponding to the To Do Type field. The To Do List screen appears.

If you want to...	Then...
	<ol style="list-style-type: none"> 5. Select the Open option from the Filter by list to view all unassigned To Dos. 6. Click the link in the Message column corresponding to the To Do of the GL Accounting template that you want to review.

The **GL Accounting Template** screen appears.

2. Review the template details.
3. Click the **Approve** button in the **GL Accounting Template** zone.

The system behaves in the following manner:

If you are...	Then...
Approving a GL Accounting template	The status of the template is changed to Active as specified in the GL Accounting template.

Note: The **Approve** button appears when the template is in the **Approval In Progress** or **Deactivation Approval In Progress** status.

Related Topics

For more information on...	See...
How to search for a GL Accounting Template	Searching for a GL Accounting Template on page 2016
GL Accounting Template screen	GL Accounting Template (Used for Searching) on page 2013
GL Accounting Template zone	GL Accounting Template on page 2019

Rejecting a GL Accounting Template

Prerequisites

To reject a GL Accounting template, you should have:

- Rejection reasons defined in the application

Note:

While rejecting a GL Accounting template, you need to specify the reason why you want to reject the template. You can select the appropriate rejection reason when you have defined the reasons for the **Rejected** status of the **C1-GLAT** business object in the **Status Reason** screen.

The system will not allow you to approve or reject a template submitted by you.

Procedure

To reject a GL Accounting template

1. Do either of the following:

If you want to	Then
Reject a GL Accounting template through the GL Accounting Template screen	<ol style="list-style-type: none"> 1. Search for the template in the GL Accounting Template screen. 2. In the Search Results section, click the link in the GL Accounting Template Information column corresponding to the template which you want to review.
Reject a GL Accounting template from the To Do List screen	<ol style="list-style-type: none"> 1. Click the Menu link in the Application toolbar. A list appears. 2. From the Main menu, select To Do and then click To Do List. The To Do Type for User Search window appears. 3. Enter C1-GLAT in the To Do Type field. 4. Click the Search button corresponding to the To Do Type field. The To Do List screen appears. 5. Select the Open option from the Filter by list to view all unassigned To Dos. 6. Click the link in the Message column corresponding to the To Do of the template that you want to review.

The **GL Accounting Template** screen appears.

2. Review the template details.
3. Click the **Reject** button in the **GL Accounting Template** zone.

The **Reject GLAT Request** window appears. It contains following fields:

Field Name	Field Description	Mandatory (Yes or No)
Status Reason	Used to indicate the reason why you want to reject the template	Yes
Comments	Used to specify additional information while rejecting the template.	No

Note: The **Reject** button appears when:

- The template is in the **Approval In Progress** or **Deactivation Approval In Progress** status.
- A user with the approval To Do role is reviewing the template.

4. Select the rejection reason from the **Status Reason** list.
5. Click **Save**.

The status of the template is changed to **Rejected**.

Related Topics

For more information on...	See...
How to search for a GL Accounting Template	Searching for a GL Accounting Template on page 2016
GL Accounting Template screen	GL Accounting Template (Used for Searching) on page 2013
GL Accounting Template zone	GL Accounting Template on page 2019
How to approve a GL Accounting Template	Approving a GL Accounting Template on page 2025

Deactivating a GL Accounting Template

Prerequisites

To deactivate a GL Accounting template, you should have:

- Deactivation reasons defined in the application.

Note:

While deactivating a GL Accounting template, you need to specify the reason why you want to deactivate the template. You can select the appropriate deactivation reason when you have defined the reasons for the deactivation status of the **C1-GLAT** business object in the **Status Reason** screen.

Procedure

To deactivate a GL Accounting template:

1. Search for the template in the **GL Accounting Template** screen.
2. In the **Search Results** section, click the link in the **GL Accounting Template Information** column corresponding to the template that you want to deactivate.

The **GL Accounting Template** screen appears.

3. Click the **Deactivate** button in the **GL Accounting Template** zone.

Note: The **Deactivate** button appears when the template is in the **Active** status.

The **Deactivate GLAT Request** window appears. It contains the following fields:

Field Name	Field Description	Mandatory (Yes or No)
Status Reason	Used to indicate the reason for deactivating a template	Yes
Comments	Used to specify the additional comments for the deactivation of template.	No

4. Click **OK**.

The GL Accounting template status is changed to **Deactivation Approval In Progress**.

Related Topics

For more information on...	See...
How to search for a GL Accounting Template	Searching for a GL Accounting Template on page 2016
GL Accounting Template screen	GL Accounting Template (Used for Searching) on page 2013
GL Accounting Template zone	GL Accounting Template on page 2019

Viewing the Log of a GL Accounting Template

Procedure

To view the log of a GL Accounting template:

1. Search for the template in the **GL Accounting template** screen.
2. In the **Search Results** section, click the link in the **GL Accounting Template Information** column corresponding to the template whose log you want to view.

The **GL Accounting Template** screen appears. It consists of the following tabs:

- **Main** – Displays information about the template. It contains the following zone:
 - **GL Accounting Template** – Displays the details of the template.
 - **Log** – Lists the complete trail of actions performed on the template. This tab contains the following zone:
 - **GL Accounting Template Log** – Displays the trail of actions performed on the particular template.
- 3. Click the **Log** tab.

The **GL Accounting Template Log** zone in the **Log** tab contains the following columns:

Column Name	Column Description
Date/Time	Displays the date and time when the action was performed on the template.
Details	Displays the details about the action performed on the template.
User	Indicates the user who has performed the action on the template.
Log Type	Indicates the type of log.
Related Object	Indicates the object or entity which is generated when the action is performed on the template.
Status Reason	Indicates the reason why the template was rejected or voided.

Note: You can manually add a log entry for the template by clicking the **Add Log Entry** link in the upper right corner of the **GL Accounting Template Log** zone.

Related Topics

For more information on...	See...
How to search for a GL Accounting Template	Searching for a GL Accounting Template on page 2016
How to add a log entry for a GL Accounting Template	Adding a Log Entry for a GL Accounting Template on page 2030

Adding a Log Entry for a GL Accounting Template

Procedure

To add a log entry for a GL Accounting Template:

1. Search for the template in the **GL Accounting Template** screen.
2. In the **Search Results** section, click the link in the **GL Accounting Template Information** column corresponding to the template whose log you want to edit.

The **GL Accounting Template** screen appears. It consists of the following tabs:

- **Main** – Displays information about the template. It contains the following zone:
 - **GL Accounting Template** – Displays the details of the template.
- **Log** – Lists the complete trail of actions performed on the template. This tab contains the following zone:
 - **GL Accounting Template Log** – Displays the trail of actions performed on the particular template.

3. Click the **Log** tab.

The **Log** tab appears.

4. Click the **Add Log Entry** link in the upper right corner of the **GL Accounting Template Log** zone.

The **Add GL Accounting Template Log** window appears. It contains the following fields:

Field Name	Field Description	Mandatory (Yes or No)
GL Accounting Template Information	Displays information about the template.	Not applicable
Log Details	Used to specify additional comments for the template.	Yes

5. Enter the comments in the **Log Details** field.

6. Click **Save**.

The log entry is added in the **GL Accounting Template Log** zone.

Related Topics

For more information on...	See...
How to search for a GL Accounting Template	Searching for a GL Accounting Template on page 2016

Chapter 29

Payment Agreement Request

Topics:

- [Payment Agreement Request \(Without Approval\) Status Transition](#)
- [Payment Agreement Request \(With Approval\) Status Transition](#)
- [Prerequisites](#)
- [Algorithms Used in C1-PaymentAgreementRequest](#)
- [Payment Agreement Request Type](#)
- [Payment Agreement Request \(Used for Searching\)](#)
- [Payment Agreement Request \(Used for Viewing\)](#)

Oracle Revenue Management and Billing provides the ability to schedule payments in installments for a set of unpaid bills of an account through a payment agreement request. Let us understand this with the help of an example. The following bills of the account A1 are unpaid:

- B1 (Bill Amount – 100\$, Unpaid Amount - 75\$)
- B2 (Bill Amount – 250\$, Unpaid Amount – 125\$)
- B3 (Bill Amount – 150\$, Unpaid Amount – 150\$)

Through a payment agreement request, you can schedule payments for these three bills in various installments. For example, you can schedule the following payments for the account A1:

Schedule Date	Schedule Amount
01-Jan-2017	100
15-Jan-2017	100
01-Feb-2017	100
15-Feb-2017	50

While creating a payment agreement request, you need to specify the payment agreement request type using which you want to create the payment agreement request. It is the payment agreement request type which helps the system to determine:

- The business object using which the payment agreement request should be created
- Whether the approval is required for the payment agreement request

You can only add completed bills of the account which are unpaid in a payment agreement request. Once a payment agreement request is created for an account, the status of the payment agreement request is set to **Draft**. You can then edit or delete the payment agreement request, if required. Once you add the unpaid bills of the account, you can submit the payment agreement request. On submitting a payment agreement request, the status of the payment agreement request is set to **Active**.

You can optionally configure the system to use the approval workflow process for a payment agreement request. If the **Approval Required** flag is set to **Yes** in a payment agreement request type, then on submitting the respective payment agreement request, the approval workflow process creates a To Do for the approver to review the payment agreement request. Once the approver approves the payment agreement request, the status of the payment agreement request is set to **Active**. The approver can approve, reject, or resubmit the payment

agreement request. When the payment agreement request is resubmitted to the submitter, the status of the payment agreement request is set to **Draft**.

Even if the approval workflow is configured for a payment agreement request type, you can skip the approval workflow for a payment agreement request. The system enables you to skip the approval workflow for a payment agreement request until you exceed the maximum limit defined in the **C1-PASUBMIT** algorithm. You can define the following parameters in the **C1-PA-SUBMIT** algorithm:

- Number of days to consider in past to check whether any payment agreement request with a particular status exist in the specified duration (for example, 365)
- Maximum number of payment agreement requests which can be activated without approval (for example, 1)
- Status in which payment agreement request should exist in the specified duration (for example, Broken Promise)

In the above example, on clicking the **Submit** button, the system will check how many payment agreement requests for the account in the last 365 days exist in the **Broken Promise** status. If the system finds one or more than one payment agreement requests in the **Broken Promise** status in the last 365 days, the approval workflow process creates a To Do for the approver to review the payment agreement request. However, if the system does not find any payment agreement request in the **Broken Promise** status in the last 365 days, the payment agreement request is not sent for approval and the status of the payment agreement request is directly changed to **Active**.

When the **Payment Agreement Request Periodic Monitor (C1-PAREQ)** batch is invoked, the system checks whether there are any payment agreement requests in the **Active** status. If there is a payment agreement request in the **Active** status, the system checks whether the total unpaid amount of the bills is equal to zero and whether each bill is fully matched. If so, the status of the payment agreement request is changed to **Kept Promise**. However, if the total unpaid amount of the bills is not equal to zero, the system checks whether the current date is later than the schedule date and does not fall within the grace period. If so, the system checks whether total unpaid amount is greater than the total future schedule amount. If so, the status of the payment agreement request is changed to **Broken Promise**. However, if the current date is earlier than the schedule date or falls within the grace period, or the total unpaid amount is less than the total future schedule amount, the status of payment agreement request remains in **Active**. The system enables you to edit a payment agreement request which is in the **Active** status.

While defining a payment agreement request, you need to specify the payment method through which the payment will be done and whether the payment will be done through the payor or third party payor account. If the **Auto Pay** flag is set to **Yes** for a payment method, you need to also specify the automatic payment option using which the automatic payment should be created on the schedule date. One more batch named **Generate Auto Pay for Payment Agreement (C1-APPAB)** is introduced in this release. When the **Generate Auto Pay for Payment Agreement (C1-APPAB)** batch is invoked, the system checks whether there are any payment agreement requests in the **Active** status. If so, whether the account for which the payment agreement request is created is eligible for automatic payment and the defer auto pay date (if any) defined for the account is earlier than the batch business date. If so, the system checks whether the extract date of the unpaid bill (with the earliest due date) is earlier than the schedule date.

If so, the system creates the automatic payment for the unpaid bill on the schedule date. However, if the account is not eligible for automatic payment, or the defer auto pay date is equal to or later than batch business date, or the extract date is equal to or later than the schedule date, the automatic payment is not generated for the account.

During the payment agreement request process, a payment agreement request creation goes through various statuses in its lifecycle. For more information about the payment agreement request statuses, see [Payment Agreement Request \(Without Approval\) Status Transition](#) on page 2034 and [Payment Agreement Request \(With Approval\) Status Transition](#) on page 2034. If the payment agreement request type is without approval then payment agreement status will automatically move from draft to active. The approval configuration algorithm **C1-PA-APPEXT** decides whether the request will be sent for approval or not. If the payment agreement request type is with approval then payment agreement will be sent for approval depending on:

- The number of days checked for approval workflow
- Payment agreement statuses (active, broken, kept) to be considered
- The maximum number of payment agreements allowed

Note: The lifecycle of a payment agreement request creation is driven by the respective business object using which the request is created. The payment agreement request feature explained in this document is articulated based on the lifecycle and logic defined in the business objects.

For more information on how to setup the payment agreement request process, see [Prerequisites](#) on page 2035.

Payment Agreement Request (Without Approval) Status Transition

The following figure graphically indicates how a payment agreement request moves from one status to another when approval workflow is off:

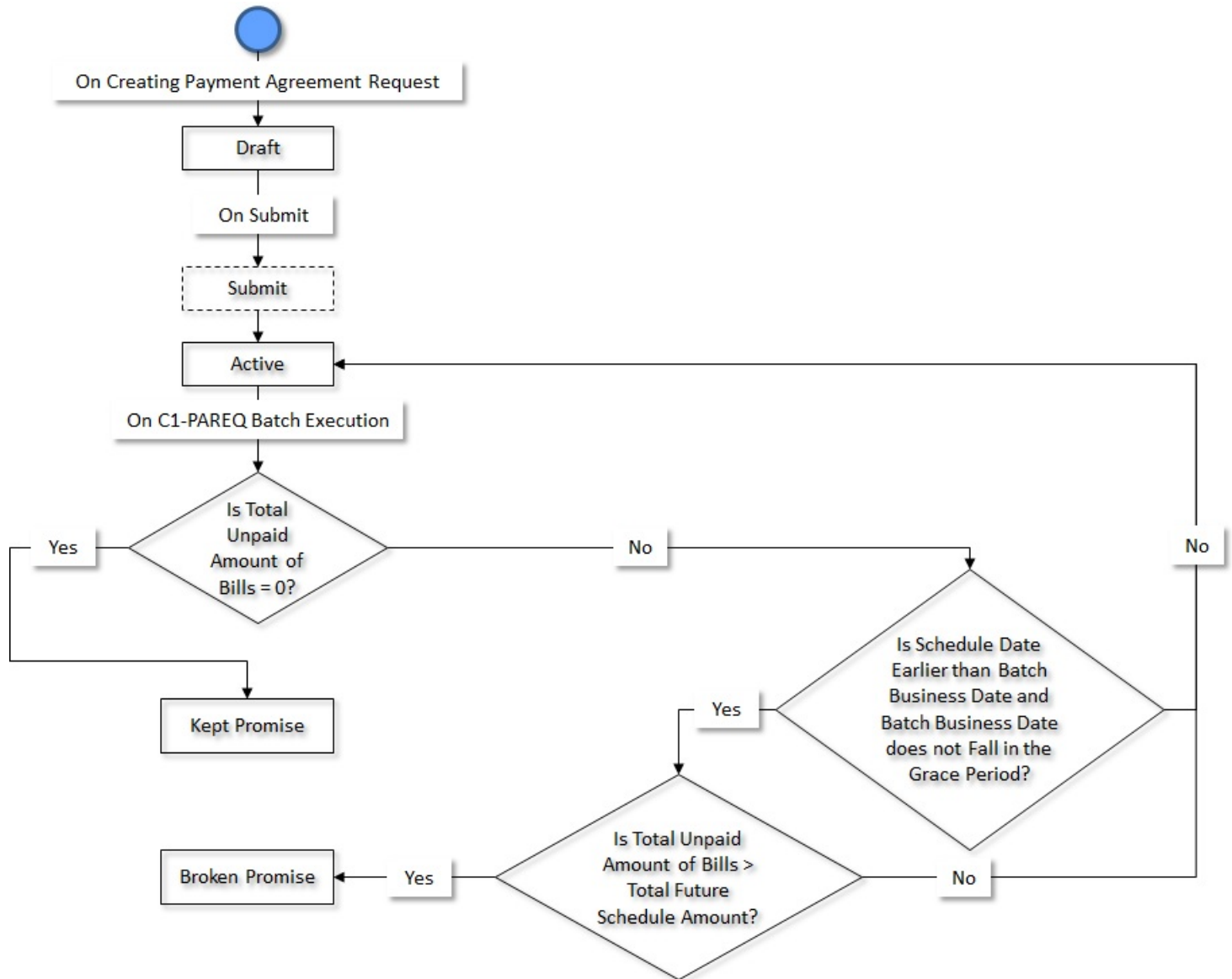

Payment Agreement Request (With Approval) Status Transition

The following figure graphically indicates how a payment agreement request moves from one status to another when approval workflow is on:

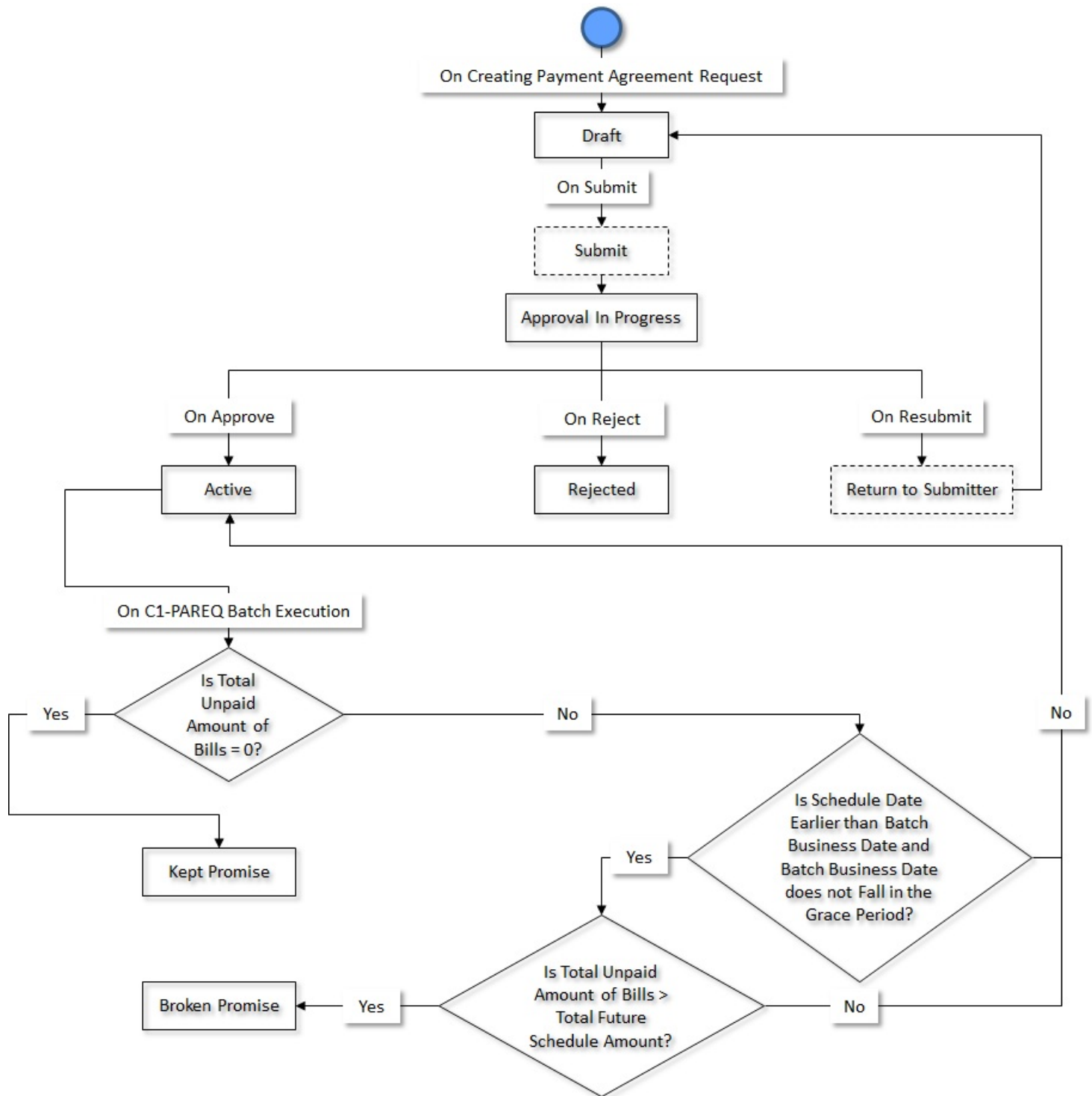

Prerequisites

To setup the payment agreement request process, you need to do the following:

- Define the required payment agreement request types in the system
- Define the required characteristic types where the characteristic entity is set to **Payment Agreement Request**

- Define the required characteristic types where the characteristic entity is set to **Payment Agreement Request Type**
- Define the required pay methods for **Payment Agreement Request**
- Define the required third party payors for **Payment Agreement Request**
- Create an algorithm using the **C1-PA-INFO** algorithm type if you want to create Payment Agreement Requests using the payment agreement request information.
- Define the kept promise status reason for the **C1-PaymentAgreementRequest** business object
- Define the broken promise status reason for the **C1-PaymentAgreementRequest** business object
- Defined rejected status reason for the **C1-PaymentAgreementRequest** business object
- Assign the **C1-PAREQ** To Do type to a To Do role whose users must receive To Do generated while submitting or resubmitting a payment agreement request for approval
- The **Payment Agreement Request Periodic Monitor (C1-PAREQ)** batch process to monitor the payment agreement request and move the request to next stage

Algorithms Used in C1-PaymentAgreementRequest

The following table lists the algorithms which are attached to the **C1-PaymentAgreementRequest** business object:

System Event	Algorithm	Algorithm Type	Description
Information	C1-PA-INFO	C1-PA-INFO	Refer to C1-PA-INFO
Pre-Processing	C1-PA-PRE	C1-PA-PRE	C1-PA-PRE
Validation	C1-PA-VAL	C1-PA-VAL	C1-PA-VAL

The following table lists the algorithms which are used in the lifecycle of the **C1-PaymentAgreementRequest** business object:

Status	System Event	Algorithm	Algorithm Type	Description
Submit	Enter	C1-PA-SUBMIT	C1-PA-SUBMIT	C1-PA-SUBMIT
Approval In Progress	Enter	C1-PA-APPENT	C1-PA-APPENT	C1-PA-APPENT
Approval In Progress	Exit	C1-PA-APPEXT	C1-PA-APPEXT	C1-PA-APPEXT
Return to Submitter	Enter	C1-PA-RESUB	C1-PA-RESUB	C1-PA-RESUB
Active	Monitor	C1-PA-MONTR	C1-PA-MONTR	C1-MONTR
Active	Enter	C1-PA-ACTENT	C1-PA-ACTENT	C1-ACTENT

Payment Agreement Request Type

Oracle Revenue Management and Billing allows you to define, edit, copy and delete a payment agreement request type using which you can pay current unpaid debt bills in multiple installments whose payment amount is greater than zero. A payment agreement provide flexibility in payment of installment amount and schedule of payment.

The **C1-PaymentAgreementRequest** business object is created for payment agreement maintenance.

The **Payment Agreement Request Type** screen consists of the following zones:

- [Payment Agreement Request Type List](#) on page 2037
- [Payment Agreement Request Type](#) on page 2037

Payment Agreement Request Type List

The **Payment Agreement Request Type List** zone lists payment agreement request types that are already defined in the system. It contains the following columns:

Column Name	Column Description
Payment Agreement Request Type	Displays the payment agreement request type.
Description	Displays the description of the payment agreement request type.
Edit	On clicking the Edit (✎) icon, the Payment Agreement Request Type screen appears where you can edit the details of the payment agreement request type.
Duplicate	On clicking the Duplicate (📄) icon, the Payment Agreement Request Type screen appears where you can define a payment agreement request type using an existing payment agreement request type.
Delete	On clicking the Delete (🗑) icon, you can delete the payment agreement request type. Note: You can delete a payment agreement request type when you have not created a payment agreement request using the payment agreement request type.

On clicking the **Broadcast** (📡) icon corresponding to a payment agreement request type, the **Payment Agreement Request Type** zone appears with the details of the respective payment agreement request type.

Related Topics

For more information on...	See...
How to define a payment agreement request type	Defining a Payment Agreement Request Type on page 2040
How to define a characteristic for a payment agreement request type	Defining a Characteristic for a Payment Agreement Request Type on page 2043
How to edit a payment agreement request type	Editing a Payment Agreement Request Type on page 2044
How to copy a payment agreement request type	Copying a Payment Agreement Request Type on page 2046
How to delete a payment agreement request type	Deleting a Payment Agreement Request Type on page 2048
How to view the details of a payment agreement request type	Viewing the Payment Agreement Request Type Details on page 2049

Payment Agreement Request Type

The **Payment Agreement Request Type** zone displays the details of the payment agreement request type. This zone contains the following sections:

- **Main** – This section provides basic information about the payment agreement request type. It contains the following fields:

Field Name	Field Description
Payment Agreement Request Type	Displays the payment agreement request type.
Description	Displays the description of the payment agreement request type.
Payment Agreement Request Business Object	Indicates the business object that will be used to create the payment agreement request. In addition, a context menu appears corresponding to this field which helps in navigating to other screens in the application.
	Note: It has a link. On clicking the link, the Business Object screen appears where you can view the details of the respective business object.
Detailed Description	Displays additional information about the payment agreement request type.
Status	Indicates the status of the payment agreement request type. The valid values are: <ul style="list-style-type: none"> • Active • Inactive
Status Change Notification Type	Indicates the notification type on the status change of payment agreement request type. The valid values are: <ul style="list-style-type: none"> • Alert • To Do • Both
Approval Required	Indicates whether approval is required while creating payment agreement request using the payment agreement request type.
Approval To Do Type	Indicates that the To Do entry of the specified To Do type must be created when you submit the payment agreement request for approval.
	Note: This field appears when the Approval Required check box is selected. It has a link. On clicking the link, the To Do Type screen appears with the details of the respective To Do type. The Search (🔍) icon appears corresponding to this field. On clicking the Search icon, the To Do Type Search window appears.
Approval To Do Role	Indicates that users with the specified To Do role can only approve or reject the payment agreement request submitted for approval.
	Note: This field appears when the Approval Required check box is selected. It has a link. On clicking the link, the To Do Role screen appears with the details of the respective To Do role.

Field Name	Field Description
Submitter To Do Type	<p>Indicates the To Do type for the submitter when the payment agreement request type is resubmitted by the approver.</p> <p>Note: This field appears when the Approval Required check box is selected. It has a link. On clicking the link, the To Do Type screen appears with the details of the respective To Do type. The Search (🔍) icon appears corresponding to this field. On clicking the Search icon, the To Do Type Search window appears.</p>
Submitter To Do Role	<p>Indicates the To Do role of the submitter when the payment agreement request type is resubmitted by the approver.</p> <p>Note: This field appears when the Approval Required check box is selected. It has a link. On clicking the link, the To Do Role screen appears with the details of the respective To Do role.</p>

- **Characteristics** – This section lists the characteristics of the payment agreement request type. It contains the following columns:

Column Name	Column Description	Mandatory (Yes Or No)
Characteristic Type	Indicates the characteristic type.	No
Characteristic Value	Displays the value of the characteristic type.	No

- **Record Actions** – This section contains the following buttons:

Button Name	Button Description
Edit	Used to edit the details of the payment agreement request type.
Delete	<p>Used to delete the payment agreement request type.</p> <p>Note: You can delete a payment agreement request type when you have not created a payment agreement request using the payment agreement request type.</p>
Duplicate	Used to create a new payment agreement request type using an existing payment agreement request type.

- **Record Information** – This section contains the following fields:

Field Name	Field Description
Business Object	Indicates the business object using which the payment agreement request type is created. In addition, a context menu appears corresponding to this field which helps in navigating to other screens in the application.
	Note: It has a link. On clicking the link, the Business Object screen appears where you can view the details of the respective business object.

By default, the **Payment Agreement Request Type** zone does not appear in the **Payment Agreement Request Type** screen. It appears when you click the **Broadcast** () icon corresponding to a payment agreement request type in the **Payment Agreement Request Type List** zone.

Related Topics

For more information on...	See...
How to define a payment agreement request type	Defining a Payment Agreement Request Type on page 2040
How to define a characteristic for a payment agreement request type	Defining a Characteristic for a Payment Agreement Request Type on page 2043
How to edit a payment agreement request type	Editing a Payment Agreement Request Type on page 2044
How to copy a payment agreement request type	Copying a Payment Agreement Request Type on page 2046
How to delete a payment agreement request type	Deleting a Payment Agreement Request Type on page 2048
How to view the details of a payment agreement request type	Viewing the Payment Agreement Request Type Details on page 2049

Defining a Payment Agreement Request Type

Prerequisites

To define a payment agreement request type, you should have:

- Payment agreement request business objects defined in the application
- The Payment Agreement Request Information algorithm is defined using the **C1-PA-INFO** algorithm type
- **C1-PAREQ** To Do Type assigned to a To Do role whose users must receive To Do generated while submitting a payment agreement request for approval.

Procedure

To define a payment agreement request type:

1. Click the **Admin** link in the **Application** toolbar.
A list appears.
2. From the **Admin** menu, select **P** and then click **Payment Agreement Request Type**.
A sub-menu appears.
3. Click the **Add** option from the **Payment Agreement Request Type** sub-menu.
The **Select Business Object** screen appears. It contains the following field:

Field Name	Field Description	Mandatory (Yes or No)
Payment Agreement Request Type Business Object	Used to indicate the business object that you want to use to create the payment agreement request type.	Yes

Tip: Alternatively, you can access the **Select Business Object** screen by clicking the **Add** button in the **Page Title** area of the **Payment Agreement Request Type** screen.

Note: The **Select Business Object** screen appears when there are multiple payment agreement request type business objects defined in the application. If there is only one payment agreement request type business object defined in the application, the **Payment Agreement Request Type** screen appears.

4. Select the required payment agreement request type business object from the respective field.
5. Click **OK**.

The **Payment Agreement Request Type** screen appears. It contains the following sections:

- **Main** – Used to specify basic details about the payment agreement request type.
- **Characteristics** – Used to define the characteristics for the payment agreement request type.

The **Main** section contains the following fields:

Field Name	Field Description	Mandatory (Yes or No)
Payment Agreement Request Type	Used to specify the payment agreement request type.	Yes
Business Object	Indicates the payment agreement request type business object used while defining the payment agreement request type.	Not applicable
Description	Used to specify the description for the payment agreement request type.	Yes
Payment Agreement Request Business Object	Used to indicate the business object that you want to use while creating the payment agreement request.	Yes
Detailed Description	Used to specify additional information about the payment agreement request type.	No
Status	Used to indicate the status of the payment agreement request type. The valid values are: <ul style="list-style-type: none"> • Active • Inactive 	Yes
Status Change Notification Type	Used to indicate the notification type on the status change of payment agreement request type. The valid values are: <ul style="list-style-type: none"> • Alert • To Do • Both 	No

Field Name	Field Description	Mandatory (Yes or No)
Approval Required	Used to indicate whether approval is required for creating payment agreement request using the payment agreement request type.	No
Approval To Do Type	Used to indicate that To Do of the specified To Do type must be created when you submit the payment agreement request for approval.	Yes (Conditional)
	Note: This field appears when the Approval Required check box is selected.	Note: This field is required when the Approval Required option is selected.
Approval To Do Role	Used to indicate that users with the specified To Do role can only approve the payment agreement request submitted for approval.	Yes (Conditional)
	Note: This field appears when the Approval Required check box is selected.	Note: This field is required when the Approval Required option is selected. The list will include only those To Do roles which are associated with the To Do type specified in the Approval To Do Type field.
Submitter To Do Type	Used to indicate the To Do type for the submitter when the payment agreement request is resubmitted by the approver.	Yes (Conditional)
	Note: This field appears when the Approval Required check box is selected.	Note: This field is required when the Approval Required option is selected.
Submitter To Do Role	Used to indicate the To Do role for the submitter when the payment agreement request is resubmitted by the approver.	Yes (Conditional)
	Note: This field appears when the Approval Required check box is selected.	Note: This field is required when the Approval Required option is selected. The list will include only those To Do roles which are associated with the To Do type specified in the Submitter To Do Type field.

6. Enter the required details.
7. Define characteristics for the payment agreement request type, if required.
8. Click **Save**.

The payment agreement request type is defined.

Related Topics

For more information on...	See...
Payment Agreement Request Type screen	Payment Agreement Request Type on page 2036

For more information on...	See...
Payment Agreement Request Type List zone	Payment Agreement Request Type List on page 2037
How to define a characteristic for a payment agreement request type	Defining a Characteristic for a Payment Agreement Request Type on page 2043

Defining a Characteristic for a Payment Agreement Request Type

Prerequisites

To define a characteristic for a payment agreement request type, you should have:

- Characteristic types defined in the application (where the characteristic entity is set to Payment Agreement Request Type)

Procedure

To define a characteristic for a payment agreement request type:

1. Ensure that the **Characteristics** section is expanded when you are defining, editing, or copying a payment agreement request type.

The **Characteristics** section contains the following fields:

Field Name	Field Description	Mandatory (Yes or No)
Characteristic Type	Used to indicate the characteristic type.	Yes (Conditional)
	Note: The list includes only those characteristic types where the characteristic entity is set to Payment Agreement Request Type.	Note: This field is required when you are defining a characteristic for the payment agreement request type.
Characteristic Value	Used to specify the value for the characteristic type.	Yes (Conditional)
	Note: On specifying the value for a predefined characteristic type, the description of the characteristic value appears corresponding to the Characteristic Value field.	Note: This field is required when you are defining a characteristic for the payment agreement request type.

2. Enter the required details.

Note: If you select a predefined characteristic type, the **Search** (🔍) icon appears corresponding to the **Characteristic Value** field. On clicking the **Search** icon, you can search for a predefined characteristic value.

3. If you want to define more than one characteristic for the payment agreement request type, click the **Add** (+) icon and then repeat step 2.

Note: However, if you want to remove a characteristic from the payment agreement request type, click the **Delete** (🗑️) icon corresponding to the characteristic.

Related Topics

For more information on...	See...
How to define a payment agreement request type	Defining a Payment Agreement Request Type on page 2040
How to edit a payment agreement request type	Editing a Payment Agreement Request Type on page 2044
How to copy a payment agreement request type	Copying a Payment Agreement Request Type on page 2046

Editing a Payment Agreement Request Type

Prerequisites

To edit a payment agreement request type, you should have:

- Payment agreement request business objects defined in the application
- The Payment Agreement Request Information algorithm is defined using the **C1-PA-INFO** algorithm type
- **C1-PAREQ** To Do Type assigned to a To Do role whose users must receive To Do generated while submitting a payment agreement request for approval.

Procedure

To edit a payment agreement request type:

1. Click the **Admin** link in the **Application** toolbar.
A list appears.
2. From the **Admin** menu, select **P** and then click **Payment Agreement Request Type**.
A sub-menu appears.
3. Click the **Search** option from the **Payment Agreement Request Type** sub-menu.
The **Payment Agreement Request Type** screen appears.
4. In the **Payment Agreement Request Type List** zone, click the **Edit** (✎) icon in the **Edit** column corresponding to the payment agreement request type whose details you want to edit.

The **Payment Agreement Request Type** screen appears. It contains the following sections:

- **Main** – Used to specify basic details about the payment agreement request type.
- **Characteristics** – Used to define the characteristics for the payment agreement request type.

The **Main** section contains the following fields:

Field Name	Field Description	Mandatory (Yes or No)
Payment Agreement Request Type	Displays the payment agreement request type.	Not applicable
Business Object	Indicates the payment agreement request type business object used while defining the payment agreement request type.	Not applicable
Description	Used to specify the description for the payment agreement request type.	Yes
Upload Request Business Object	Used to specify the business object that you want to use while creating the payment agreement request.	Yes
Detailed Description	Used to specify additional information about the payment agreement request type.	No

Field Name	Field Description	Mandatory (Yes or No)
Status	Used to indicate the status of the payment request type. The valid values are: <ul style="list-style-type: none"> Active Inactive 	Yes
Status Change Notification Type	Used to indicate the notification type on the status change of payment agreement request type. The valid values are: <ul style="list-style-type: none"> Alert To Do Both 	No
Approval Required	Used to indicate whether approval is required for editing payment agreement request using the payment agreement request type.	Yes
Approval To Do Type	Used to indicate that To Do of the specified To Do type must be created when you submit the payment agreement request for approval.	Yes (Conditional) Note: This field is required when the Approval Required check box is selected.
	Note: The Search (🔍) icon appears corresponding to this field. On clicking the Search icon, the To Do Type Search window appears.	
Approval To Do Role	Used to indicate that users with the specified To Do role can only approve the upload request submitted for approval.	Yes (Conditional) Note: This field is required when the Approval Required check box is selected.
	Note: This field appears when the Approval Required check box is selected.	
Submitter To Do Type	Used to indicate the To Do type for the submitter when the payment agreement request is resubmitted by the approver.	Yes (Conditional) Note: This field is required when the Approval Required check box is selected.
	Note: This field appears when the Approval Required check box is selected.	
	The Search (🔍) icon appears corresponding to this field. On clicking the Search icon, the To Do Type Search window appears	
Submitter To Do Role	Used to indicate the To Do role for the submitter when the payment agreement request is resubmitted by the approver.	Yes (Conditional) Note: This field is required when the Approval Required check box is selected.
	Note: This field appears when the Approval Required check box is selected.	

Tip: Alternatively, you can click the **Edit** button in the **Payment Agreement Request Type** zone to edit the details of the payment agreement request type.

5. Modify the required details.

Note: You can search for a **Approval To Do Type** and **Submitter To Do Type** by clicking the **Search** (🔍) icon corresponding to the respective field.

6. Define, edit, or remove characteristics of the payment agreement request type, if required.
7. Click **Save**.

The changes made to the payment agreement request type are saved.

Related Topics

For more information on...	See...
Payment Agreement Request Type screen	Payment Agreement Request Type on page 2036
Payment Agreement Request Type List zone	Payment Agreement Request Type List on page 2037
Payment Agreement Request Type zone	Payment Agreement Request Type on page 2037
How to define a characteristic for a payment agreement request type	Defining a Characteristic for a Payment Agreement Request Type on page 2043

Copying a Payment Agreement Request Type

Instead of creating a payment agreement request type from scratch, you can create a new payment agreement request type using an existing payment agreement request type. This is possible through copying a payment agreement request type. On copying a payment agreement request type, the details including the characteristics are copied to the new payment agreement request type. You can then edit the details, if required.

Prerequisites

To copy a payment agreement request type, you should have:

- Payment agreement request type (whose copy you want to create) defined in the application
- Payment agreement request business objects defined in the application
- The Payment Agreement Request Information algorithm is defined using the **C1-PA-INFO** algorithm type
- **C1-PAREQ** To Do Type assigned to a To Do role whose users must receive To Do generated while submitting a payment agreement request for approval

Procedure

To copy a payment agreement request type:

1. Click the **Admin** link in the **Application** toolbar.
A list appears.
2. From the **Admin** menu, select **P** and then click **Payment Agreement Request Type**.
A sub-menu appears.
3. Click the **Search** option from the **Payment Agreement Request Type** sub-menu.
The **Payment Agreement Request Type** screen appears.
4. In the **Payment Agreement Request Type List** zone, click the **Duplicate** (📄) icon in the **Duplicate** column corresponding to the payment agreement request type whose copy you want to create.

The **Payment Agreement Request Type** screen appears. It contains the following sections:

- **Main** – Used to specify basic details about the payment agreement request type.
- **Characteristics** – Used to define the characteristics for the payment agreement request type.

The **Main** section contains the following fields:

Field Name	Field Description	Mandatory (Yes or No)
Payment Agreement Request Type	Used to specify the payment agreement request type.	Yes
Business Object	Indicates the payment agreement request type business object used while defining the payment agreement request type (whose copy you want to create).	Not applicable
Description	Used to specify the description for the payment agreement request type.	Yes
Payment Agreement Request Business Object	Used to specify the business object that you want to use while creating the payment agreement request.	Yes
Detailed Description	Used to specify additional information about the payment agreement request type.	No
Status	Used to indicate the status of the payment agreement request type. The valid values are: <ul style="list-style-type: none"> • Active • Inactive 	Yes
Status Change Notification Type	Used to indicate the notification type on the status change of payment agreement request type. The valid values are: <ul style="list-style-type: none"> • Alert • To Do • Both 	No
Approval Required	Used to indicate whether approval is required while creating payment agreement request using the payment agreement request type.	Yes
Approval To Do Type	Used to indicate that To Do of the specified To Do type must be created when you submit the payment agreement request for approval. <p>Note: This field appears when the Approval Required check box is selected.</p> <p>The Search (🔍) icon appears corresponding to this field. On clicking the Search icon, the To Do Type Search window appears.</p>	Yes (Conditional)
		Note: This field is required when the Approval Required check box is selected.

Field Name	Field Description	Mandatory (Yes or No)
Approval To Do Role	Used to indicate that users with the specified To Do role can only approve the payment agreement request submitted for approval.	Yes (Conditional)
	Note: This field appears when the Approval Required check box is selected.	Note: This field is required when the Approval Required check box is selected.
Submitter To Do Type	Used to indicate the To Do type for the submitter when the payment agreement request is resubmitted by the approver.	Yes (Conditional)
	Note: This field appears when the Approval Required check box is selected.	Note: This field is required when the Approval Required check box is selected.
	The Search (🔍) icon appears corresponding to this field. On clicking the Search icon, the To Do Type Search window appears.	
Submitter To Do Role	Used to indicate the To Do role for the submitter when the payment agreement request is resubmitted by the approver.	Yes (Conditional)
	Note: This field appears when the Approval Required check box is selected.	Note: This field is required when the Approval Required check box is selected.

Tip: Alternatively, you can click the **Duplicate** button in the **Payment Agreement Request Type** zone to create a copy of the payment agreement request type.

5. Enter the required details.
6. Define, edit, or remove characteristics of the payment agreement request type, if required.
7. Click **Save**.

The new payment agreement request type is defined.

Related Topics

For more information on...	See...
Payment Agreement Request Type screen	Payment Agreement Request Type on page 2036
Payment Agreement Request Type List zone	Payment Agreement Request Type List on page 2037
Payment Agreement Request Type zone	Payment Agreement Request Type on page 2037
How to define a characteristic for a payment agreement request type	Defining a Characteristic for a Payment Agreement Request Type on page 2043

Deleting a Payment Agreement Request Type

Procedure

To delete a payment agreement request type:

1. Click the **Admin** link in the **Application** toolbar.

A list appears.

- From the **Admin** menu, select **P** and then click **Payment Agreement Request Type**.

A sub-menu appears.

- Click the **Search** option from the **Payment Agreement Request Type** sub-menu.

The **Payment Agreement Request Type** screen appears.

- In the **Payment Agreement Request Type List** zone, click the **Delete** (🗑️) icon in the **Delete** column corresponding to the payment agreement request type that you want to delete.

A message appears confirming whether you want to delete the payment agreement request type.

Note: You can delete a payment agreement request type when you have not created a payment agreement request using the payment agreement request type.

Tip: Alternatively, you can click the **Delete** button in the **Payment Agreement Request Type** zone to delete the payment agreement request type.

- Click **OK**.

The payment agreement request type is deleted.

Related Topics

For more information on...	See...
Payment Agreement Request Type screen	Payment Agreement Request Type on page 2036
Payment Agreement Request Type List zone	Payment Agreement Request Type List on page 2037
Payment Agreement Request Type zone	Payment Agreement Request Type on page 2037

Viewing the Payment Agreement Request Type Details

Procedure

To view the details of a payment agreement request type:

- Click the **Admin** link in the **Application** toolbar.

A list appears.

- From the **Admin** menu, select **P** and then click **Payment Agreement Request Type**.

A sub-menu appears.

- Click the **Search** option from the **Payment Agreement Request Type** sub-menu.

The **Payment Agreement Request Type** screen appears.

- In the **Payment Agreement Request Type List** zone, click the **Broadcast** (📡) icon corresponding to the payment agreement request type whose details you want to view.

The **Payment Agreement Request Type** zone appears.

- View the details of the payment agreement request type in the **Payment Agreement Request Type** zone.

Related Topics

For more information on...	See...
Payment Agreement Request Type screen	Payment Agreement Request Type on page 2036

For more information on...	See...
Payment Agreement Request Type List zone	Payment Agreement Request Type List on page 2037
Payment Agreement Request Type zone	Payment Agreement Request Type on page 2037

Payment Agreement Request (Used for Searching)

The **Payment Agreement Request** screen allows you to search for a payment agreements for unpaid bills by searching through Bill ID or through Payment Agreement Request ID. Through this screen, you can navigate to the following screens:

- [Payment Agreement Request \(Used for Viewing\)](#) on page 2058

This screen consists of the following zones:

- [Search Payment Agreement Request](#) on page 2050
- [Bill Details](#) on page 2053

Search Payment Agreement Request

The **Search Payment Agreement Request** zone allows you to search for a payment agreement request using various search criteria. This zone contains the following two sections:

- **Search Criteria** – The **Search Criteria** section contains the following fields:

Field Name	Field Description	Mandatory (Yes or No)
Search By	Used to indicate whether you want to search for a payment agreement request using request or bill details. The valid values are: <ul style="list-style-type: none"> • Request Details • Bill Details <p>Note: By default, the Request Details option is selected.</p>	Yes
Payment Agreement Request ID	Used to search a particular payment agreement request. <p>Note: This field appears when you select the Request Details option from the Search By list.</p>	No
Created From	Used to search payment agreement requests which are created from a particular date onwards. <p>Note: This field appears when you select the Request Details option from the Search By list.</p>	No
To	Used to search payment agreement requests which are created till a particular date. <p>Note: This field appears when you select the Request Details option from the Search By list.</p>	No

Field Name	Field Description	Mandatory (Yes or No)
Payment Agreement Request Type	Used to search payment agreement requests which are created using a particular payment agreement request type.	No
	Note: This field appears when you select the Request Details option from the Search By list.	
Status	Used to search payment agreement requests with a particular status. The valid values are: <ul style="list-style-type: none"> • Active • Approval In Progress • Broken Promise • Draft • Kept Promise • Rejected • Return to Submitter 	No
	Note: This field appears when you select the Request Details option from the Search By list.	
Account ID	Used to search for unpaid bills of a particular account.	No
	Note: This field appears when you select the Request Details option from the Search By list. You can search for a account ID by clicking the Search (🔍) icon corresponding to the field.	
Person ID	Used to search the person ID based on which you want to search for bills of a person.	No
	Note: This field appears when you select the Request Details option from the Search By list. You can search for a person ID by clicking the Search (🔍) icon corresponding to the field.	
Bill ID	Used to search a particular bill.	No
	Note: This field appears when you select the Bill Details option from the Search By list. You can search for a bill by clicking the Search (🔍) icon corresponding to the field.	

Field Name	Field Description	Mandatory (Yes or No)
Bill Date From	Used to search bills which are created from a particular date onwards.	No
	Note: This field appears when you select the Bill Details option from the Search By list.	
To	Used to search bills which are created till a particular date.	No
	Note: This field appears when you select the Bill Details option from the Search By list.	
Alternate Bill ID	Used to search a particular bill using the alternate bill ID.	No
	Note: This field appears when you select the Bill Details option from the Search By list.	

Note: You must specify at least one search criterion while searching for a payment agreement request.

- **Search Results** – On clicking the **Search** button, the search results appear based on the specified search criteria. The **Search Results** section contains the following columns:

Column Name	Column Description
Create Date/Time	Displays the date and time when the payment agreement request was created in the system.
Payment Agreement Request Information	Displays information about the payment agreement request.
	Note: It has a link. On clicking the link, the Payment Agreement Request screen appears where you can view the details of the respective payment agreement request.
Schedule Amount	Displays the amount that the customer has agreed to pay on the scheduled date.
Status	Indicates the status of the payment agreement request. The valid values are: <ul style="list-style-type: none"> • Active • Approval In Progress • Broken Promise • Draft • Kept Promise • Rejected • Return to Submitter
Last Updated Date/Time	Displays the most recent updated date and time of the payment agreement request.
Total Unpaid Amount	Displays the total unpaid amount for debit bills.
	Note: Total Unpaid Amount should be equal to total Schedule Amount .

Column Name	Column Description
Person Information	Displays information about the person. In addition, this column has a context menu which helps in navigating to other screens in the application.
	Note: It has a link. On clicking the link, the Person screen appears where you can view the details of the respective person.
Account Information	Displays information about the account. In addition, this column has a context menu which helps in navigating to other screens in the application.
	Note: It has a link. On clicking the link, the Account screen appears where you can view the details of the respective account.

Note: Pagination is used to display limited number of records in the **Search Results** section. You can use the navigation links, such as **Previous** and **Next** to navigate between pages.

Related Topics

For more information on...	See...
How to search for a payment agreement request	Searching for a Payment Agreement Request on page 2054
How to create a payment agreement request	Creating a Payment Agreement Request on page 2054
How to view the details of a payment agreement request	Viewing the Payment Agreement Request Details on page 2058

Bill Details

The **Bill Details** zone lists unpaid debt bill details. You will not find any records in this zone if the payment agreement request list does not have any unpaid bills assigned to it. This zone contains the following columns:

Column Name	Column Description
Bill Information	Indicates the bill against which the payment agreement request is created. In addition, this column has a context menu which helps in navigating to other screens in the application.
	Note: It has a link. On clicking the link, the Bill screen appears with the details of the respective bill.
Original Bill Amount	Displays the bill amount when the bill was generated.
Current Bill Balance	Displays the outstanding amount.
Due Date	Displays the due date of the bill.

By default, the **Bill Details** zone does not appear in the **Payment Agreement Request** screen. It appears when you click the **Broadcast** (📢) icon corresponding to the payment agreement request in the **Search Payment Agreement Request** zone.

You can change the layout of this zone. For more information on how to change the layout, see [Changing the Layout](#) on page 3414.

Related Topics

For more information on...	See...
How to view bills added in the payment agreement request	Viewing the Bills Added in the Payment Agreement Request on page 2057

Searching for a Payment Agreement Request

Prerequisites

To search for a payment agreement request, you should have:

- Payment agreement request types defined in the application

Procedure

To search for a payment agreement request:

1. Click the **Menu** link in the **Application** toolbar.
A list appears.
2. From the **Main** menu, select **Delinquency Management** and then click **Payment Agreement Request**.
A sub-menu appears.
3. Click the **Search** option from the **Payment Agreement Request** sub-menu.
The **Payment Agreement Request** screen appears.
4. Enter the search criteria in the **Search Payment Agreement Request** zone.

Note: ORMB search engine supports wildcard search, where you can substitute the percentage (%) symbol as a stand in for any word or letter in a search criteria. You can use the ‘%’ wildcard character in all input fields except the date and ID fields. The ‘%’ wildcard character is suffixed automatically at the end of the partial search criteria. Therefore, you may or may not specify the wildcard character at the end of the partial search criteria. However, you have to prefix the wildcard character manually wherever required.

5. Click **Search**.

A list of payment agreement requests that meet the search criteria appears in the **Search Results** section.

Related Topics

For more information on...	See...
Payment Agreement Request screen	Payment Agreement Request (Used for Searching) on page 2050
Search Payment Agreement Request zone	Search Payment Agreement Request on page 2050

Creating a Payment Agreement Request

Prerequisites

To create a payment agreement request, you should have:

- Payment agreement request types defined in the application

Procedure

To create a payment agreement request:

1. Click the **Menu** link in the **Application** toolbar.
A list appears.
2. From the **Main** menu, select **Delinquency Management** and then click **Payment Agreement Request**.

A sub-menu appears.

- Click the **Add** option from the **Payment Agreement Request** sub-menu.

The **Add Payment Agreement Request** screen appears. It contains the following fields:

Field Name	Field Description	Mandatory (Yes or No)
Payment Agreement Request Type	Used to indicate the payment agreement request type using which you want to create the payment agreement request.	Yes
Account ID	Used to search for unpaid bills of a particular account. The Search (🔍) icon appears corresponding to this field. On clicking the Search icon, the Account Search window appears.	Yes

Tip: Alternatively, you can access the **Add Payment Agreement Request** screen by clicking the **Add** button in the **Page Title** area of the **Payment Agreement Request** screen.

- Select the required payment agreement request type and account ID from the respective fields.
- Click **OK**.

The **Payment Request** screen appears.

Related Topics

For more information on...	See...
Search Payment Agreement Request zone	Search Payment Agreement Request on page 2050
Payment Agreement Request screen	Payment Agreement Request (Used for Searching) on page 2050

Defining a Characteristic for a Payment Agreement Request

Prerequisites

To define a characteristic for a payment agreement request:

- Characteristic types defined in the application (where the characteristic entity is set to **Payment Agreement Request**)

Procedure

To define a characteristic for a Payment Agreement Request:

- Ensure that the **Characteristics** section is expanded when you are editing, submitting, approving, rejecting or resubmitting a payment agreement.

The **Characteristics** section contains the following fields:

Field Name	Field Description	Mandatory (Yes or No)
Effective Date	Used to indicate the date from when the characteristic is effective for the payment agreement request.	Yes (Conditional)
		Note: This field is required when you are defining a characteristic for the payment agreement request.

Field Name	Field Description	Mandatory (Yes or No)
Characteristic Type	Used to indicate the characteristic type.	Yes (Conditional)
	Note: The list includes only those characteristic types where the characteristic entity is set to Payment Agreement Request.	Note: This field is required when you are defining a characteristic for the payment agreement request.
Characteristic Value	Used to specify the value for the characteristic type.	Yes (Conditional)
	Note: On specifying the value for a predefined characteristic type, the description of the characteristic value appears corresponding to the Characteristic Value field.	Note: This field is required when you are defining a characteristic for the payment agreement request.

2. Enter the required details.

Note: If you select a predefined characteristic type, the **Search** (🔍) icon appears corresponding to the **Characteristic Value** field. On clicking the **Search** icon, you can search for a predefined characteristic value.

3. If you want to define more than one characteristic for the payment agreement request, click the **Add** (+) icon and then repeat step 2.

Note: However, if you want to remove a characteristic from the payment agreement request, click the **Delete** (🗑️) icon corresponding to the characteristic.

Related Topics

For more information on...	See...
How to create a payment agreement request	Creating a Payment Agreement Request on page 2054
How to edit a payment agreement request	Editing a Payment Agreement Request on page 2064

Defining Payment Schedule for a Payment Agreement Request

Prerequisites

To define payment schedule for a payment agreement request:

- Scheduled date, sum of installments for overdue or unpaid bills defined in the application for which the payment is scheduled is set to **Payment Agreement Request**

Procedure

To define payment schedule for a Payment Agreement Request:

1. Ensure that the **Payment Schedule** section is expanded when you are editing, submitting, approving, rejecting or resubmitting a payment agreement.

The **Payment Schedule** section contains the following fields:

Field Name	Field Description	Mandatory (Yes or No)
Schedule Date	Used to indicate the date schedule for the payment.	Yes (Conditional)
		Note: This field is required when you are defining a payment schedule for the payment agreement request.
Schedule Amount	Used to indicate the amount scheduled for overdue or unpaid bills to be paid in installments.	Yes (Conditional)
		Note: This field is required when you select a Schedule Date for the payment schedule.
Auto Pay ID	Used to indicate the auto pay id of the payor.	No

- Enter the required details.

Note: If you select a auto pay method option for **Pay Method**, the **Search** (🔍) icon appears corresponding to the **Auto Pay ID** field. On clicking the **Search** icon, you can search for a **Payor Account ID**.

- If you want to define more than one payment schedule for the payment agreement request, click the **Add** (+) icon and then repeat step 2.

Note: However, if you want to remove a payment schedule from the payment agreement request, click the **Delete** (🗑️) icon corresponding to the payment schedule.

Related Topics

For more information on...	See...
How to create a payment agreement request	Creating a Payment Agreement Request on page 2054
How to edit a payment agreement request	Editing a Payment Agreement Request on page 2064

Viewing the Bills Added in the Payment Agreement Request

Procedure

To view the bills added in the payment agreement request:

- Search for the payment agreement request in the **Payment Agreement Request** screen.

- In the **Search Results** section, click the **Broadcast** (📡) icon corresponding to the payment agreement request whose bill details you want to view.

The **Bill Details** zone appears.

Note: Bill are added in **Search Bills** zone on the **Bills** tab.

Related Topics

For more information on...	See...
How to create a payment agreement request	Creating a Payment Agreement Request on page 2054

Viewing the Payment Agreement Request Details

Procedure

To view the details of a payment agreement request:

- Search for the payment agreement request in the **Payment Agreement Request** screen.
- In the **Search Results** section, click the link in the **Payment Agreement Request Information** column corresponding to the payment agreement request whose details you want to view.

The **Payment Agreement Request** screen appears. It consists of the following tabs:

- **Main** – This tab contains the following three zones:
 - **Payment Agreement Request** – Displays the details of the payment agreement request.
 - **Bill Details** – Lists the unpaid bill details of the payment agreement request.
 - **Payment Schedule** – Lists the payment scheduled for unpaid bill amount of the payment agreement request.
 - **Log** – This tab lists the complete trail of actions performed on the payment request.
- View the details of the payment agreement request in the **Payment Agreement Request** zone.
 - View the bill details of the unpaid amount bills of payment agreement request in the **Bill Details** zone.
 - View the payment schedule details of payment agreement request in the **Payment Schedule** zone.

Related Topics

For more information on...	See...
How to search for a payment agreement request	Searching for a Payment Agreement Request on page 2054
Payment Agreement Request screen	Payment Agreement Request (Used for Viewing) on page 2058
Payment Agreement Request zone	Payment Agreement Request on page 2059
Bill Details zone	Bill Details on page 2061
Payment Schedule zone	Payment Schedule on page 2062

Payment Agreement Request (Used for Viewing)

Once you create a payment agreement request type, the **Payment Agreement Request** screen allows you to:

- Edit the details of a payment agreement request along with bill details and payment schedule

- Delete a payment agreement request
- View the details of a payment agreement request
- View the bills added in a payment agreement request
- Define a payment schedule in a payment agreement request
- Submit a payment agreement request for approval
- Approve or reject a payment agreement request
- Resubmit a payment agreement request
- Filter an overdue bills of an account
- Add an overdue bill in a payment agreement request
- View the log of a payment agreement request
- Add a log entry for a payment agreement request

This screen consists of the following tabs:

- **Main** – This tab contains the following three zones:
 - **Payment Agreement Request** – Displays the details of the payment agreement request.
 - **Bill Details** – Lists the bill details of the payment agreement request.
 - **Payment Schedule** – Lists the payment schedule details of the bills for the payment agreement request.
- **Bills** – This tab lists the unpaid bill amount details for the same account.

Note: This tab will be displayed when the payment agreement is in **Draft** status.

- **Log** – This tab lists the complete trail of actions performed on the payment agreement request.

Payment Agreement Request - Main

The **Main** tab on the **Payment Agreement Request** contains the following zones:

- [Payment Agreement Request](#) on page 2059
- [Bill Details](#) on page 2061
- [Payment Schedule](#) on page 2062

Payment Agreement Request

The **Payment Agreement Request** zone displays the details of the payment agreement request. This zone contains the following sections:

- **Main** – This section provides basic information about the payment agreement request. It contains the following fields:

Field Name	Field Description
Payment Agreement Request Information	Displays information about the payment agreement request.
Payment Agreement Request Type	Indicates the payment agreement request type using which the payment agreement request is created.
	Note: It has a link. On clicking the link, the Payment Agreement Request Type screen appears where you can view the details of the payment agreement request type.

Field Name	Field Description
Account Information	Displays information about the account for which the payment agreement request is created. In addition, a context menu appears corresponding to this field which helps in navigating to other screens in the application.
	Note: It has a link. On clicking the link, the Account screen appears where you can view the details of the respective account.
Status	Indicates the status of the payment agreement request. The valid values are: <ul style="list-style-type: none"> • Active • Draft • Approval In Progress • Broken Promise • Kept Promise • Rejected
Payor Account ID	Displays the payment agreement requests which are created for a particular payor account. In addition, a context menu appears corresponding to this field which helps in navigating to other screens in the application.
	Note: It has a link. On clicking the link, the Account screen appears where you can view the details of the respective account.
Pay Method	Displays the method of payment of amount.
Total Unpaid Amount	Displays the unpaid amount for selected bills.
Total Future Schedule Amount	Displays the total schedule amount.

- **Characteristics** – This section lists the characteristics of the payment of selected bills. It contains the following columns:

Column Name	Column Description
Effective Date	Displays the date from when the characteristic is effective for the payment agreement request.
Characteristic Type	Indicates the characteristic type.
Characteristic Value	Displays the value of the characteristic type.

- **Record Actions** – This section contains the following buttons:

Column Name	Column Description
Edit	Used to edit the details of the payment agreement request.
	Note: The Edit button appears when the payment agreement request is in the Active or Draft status.
Delete	Used to delete the payment agreement request.
	Note: The Delete button appears when the payment agreement request is in the Draft status.

Column Name	Column Description
Submit	Used to submit the payment agreement request for approval.
	Note: The Submit button appears when the payment agreement request is in the Draft status.
Approve	Used to approve the payment agreement request.
	Note: The Approve button appears when: <ul style="list-style-type: none"> • The payment agreement request is in the Approval In Progress status. • A user with the approval To Do role is reviewing the payment agreement request.
Reject	Used to reject the payment agreement request.
	Note: The Reject button appears when: <ul style="list-style-type: none"> • The payment agreement request is in the Approval In Progress status. • A user with the approval To Do role is reviewing the payment agreement request.
Resubmit	Used to change the status of the payment agreement request to Draft .
	Note: The Resubmit button appears when: <ul style="list-style-type: none"> • The payment agreement request is in the Approval In Progress status. • A user with the approval To Do role is reviewing the payment agreement request.

- **Record Information** – This section contains the following fields:

Field Name	Field Description
Business Object	Indicates the business object using which the payment agreement request is created. In addition, a context menu appears corresponding to this field which helps in navigating to other screens in the application.
	Note: It has a link. On clicking the link, the Business Object screen appears where you can view the details of the respective business object.
Status Date/Time	Displays the date and time when the payment agreement request status is updated.
Create Date/Time	Displays the date and time when the payment agreement request is created.

Bill Details

The **Bill Details** zone displays the bill details of the payment agreement request. This zone contains the following columns:

Column Name	Column Description
Bill Information	Displays additional information about the bill. In addition, this column has a context menu which helps in navigating to other screens in the application.
	Note: It has a link. On clicking the link, the Bill screen appears with the details of the respective bill.
Bill Amount	Displays the bill amount when the bill was generated.
Due Date	Displays the due date of the bill.
Unpaid Amount	Displays the amount which is eligible for payment against the bill.
Overdue Process Information	Displays the overdue process information about the bill.
	Note: It has a link. On clicking the link, the Overdue Process screen appears with details of the overdue process of the bill.

This zone contains the **Delete** button. This button appears when the payment agreement request is in the **Draft** status. It is used to delete bills of payment agreement request.

Note: One payment agreement request will have complete status debit bills of only one account. All bills under one payment agreement will be of same currency. Once payment agreement request is active, bills added under the request cannot be deleted.

Note: Pagination is used to display limited number of records in the **Search Results** section. You can use the navigation links, such as **Previous** and **Next** to navigate between pages.

Payment Schedule

The **Payment Schedule** zone displays the payments scheduled for the bills of the payment agreement request. This zone contains the following columns:

Column Name	Column Description
Schedule Date	Displays the schedule date for payment of bills amount in installments.
Schedule Amount	Displays the scheduled amount for bills payment in installments.
Auto Pay ID	Displays the automatic payment ID.

Note: Pagination is used to display limited number of records in the **Search Results** section. You can use the navigation links, such as **Previous** and **Next** to navigate between pages.

Payment Agreement Request - Bills

The **Bills** tab on the **Payment Agreement Request** contains the following zone:

- [Search Bills](#) on page 2062

Note: This tab is appears when the payment agreement request is in the **Draft** status.

Search Bills

The **Search Bills** zone allows you to search for all overdue bills for the account of a payment agreement request using various search criteria. This zone contains the following two sections:

- **Search Criteria** – The **Search Criteria** section contains the following fields:

Field Name	Field Description	Mandatory (Yes or No)
Search By	Used to indicate whether you want to search for a payment agreement request using bill details.	Yes
	Note: By default, the Bill Details option is selected.	
Bill ID	Used to search for a particular bill.	No
	Note: The Search (🔍) icon appears corresponding to this field. On clicking the Search icon, the Bill Search window appears.	
Bill Date From	Used to search bills which are created from a particular date onwards.	No
To	Used to search bills which are created till a particular date.	No

Note: You must specify at least one search criterion while searching for the bill details.

- **Search Results** – On clicking the **Search** button, the search results appear based on the specified search criteria. The **Search Results** section contains the following columns:

Column Name	Column Description
Bill ID	Displays the bill ID.
Bill Information	Displays additional information about the bill. In addition, this column has a context menu which helps in navigating to other screens in the application.
	Note: It has a link. On clicking the link, the Bill screen appears with the details of the respective bill.
Unpaid Amount	Displays the amount which is eligible for payment agreement request against the bill.
Overdue Process Information	Displays the overdue process information for the bill.

This zone contains the **Add** button. It is used to add bill details of payment agreement request.

Note: Pagination is used to display limited number of records in the **Search Results** section. You can use the navigation links, such as **Previous** and **Next** to navigate between pages.

Note: One payment agreement request will have complete status debit bills of only one account. All bills under one payment agreement will be of same currency. Bills which are part of another payment agreement request and which is not in completed status will not be available for selection.

Related Topics

For more information on...	See...
How to search for a payment agreement request	Searching for a Payment Agreement Request on page 2054
How to create a payment agreement request	Creating a Payment Agreement Request on page 2054

For more information on...	See...
How to view the details of a payment agreement request	Viewing the Payment Agreement Request Details on page 2058

Payment Agreement Request - Log

The **Log** tab on the **Payment Agreement Request** screen contains the following zone:

- [Payment Agreement Request Log](#) on page 2064

Payment Agreement Request Log

The **Payment Agreement Request Log** zone on the **Payment Agreement Request** screen lists the complete trail of actions performed on the payment agreement request. This zone contains the following columns:

Column Name	Column Description
Date/Time	Displays the date and time when the action was performed on the payment agreement request.
Details	Displays the details about the action performed on the payment agreement request.
User	Indicates the user who has performed the action on the payment agreement request.
Log Type	Indicates the type of log.
Related Object	Indicates the object or entity which is generated when the action is performed on the payment agreement request.
Status Reason	Displays the status reason of action performed on the payment agreement request.
Old Payment Schedule	Displays the details of old payment schedule.

Note: You can manually add a log entry for the payment agreement request by clicking the **Add Log Entry** link in the upper right corner of the **Payment Agreement Request Log** zone.

The **Add Payment Agreement Request Log** window appears. Enter **Log Details** and click **Save**. The payment agreement request log is added.

Related Topics

For more information on...	See...
How to view the log of a payment agreement request	Viewing the Log of a Payment Agreement Request on page 2075
How to add the log for a payment agreement request	Adding a Log Entry for a Payment Agreement Request on page 2076

Editing a Payment Agreement Request

Procedure

To edit a payment agreement request:

1. Search for the payment agreement request in the **Payment Agreement Request** screen.
2. In the **Search Results** section, click the link in the **Payment Agreement Request Information** column corresponding to the payment agreement request whose details you want to edit.

The **Payment Agreement Request** screen appears.

- Click the **Edit** button in the **Payment Agreement Request** zone.

Note: The **Edit** button appears only when the payment agreement request is in the **Active** or **Draft** status.

The **Payment Agreement Request** screen appears. It contains the following sections:

- Main** – Used to specify basic details about the payment agreement request. This section contains the following fields:

Field Name	Field Description	Mandatory (Yes or No)
Payment Agreement Request Information	Displays information about the payment agreement request.	Not applicable
Payment Agreement Request Type	Indicates the payment agreement request type using which the payment agreement request is created.	Not applicable
Account Information	Used to indicate the account for which you want to create the payment agreement request.	Yes
Third Party Payor	Used to specify the third party payor.	No
	Note: The values appears for selection only if the third party payor check box is selected.	
Payor Account ID	Displays the account ID of selected Third Party Payor .	Not applicable
Pay Method	Used to indicate the payment method.	Yes
	Note: The valid values differ with respect to the description added for respective pay method in the Pay Method screen.	
Comments	Used to specify additional details about the payment agreement request.	No
Total Unpaid Amount	Displays the sum of unpaid amount of the bills.	Not applicable
Total Future Schedule Amount	Displays the sum of future schedule amount.	Not applicable

- Bill Details** – Used to specify the bill details in the payment agreement request. This section contains the following column:

Column Name	Column Description	Mandatory (Yes or No)
Bill ID	Used to search a particular bill.	Yes
	Note: The Search (🔍) icon appears corresponding to the field. On clicking the Search icon, the Bill Search window appears. Bill details are displayed corresponding to the searched bill id.	

If you want to define more than one bill details for the payment agreement request, click the **Add (+)** icon.

Note: However, if you want to remove a bill detail from the payment agreement request, click the **Delete** (🗑️) icon corresponding to the bill ID.

- **Payment Schedule** – Used to specify the payment schedule details in the payment agreement request. This screen contains the following columns:

Column Name	Column Description	Mandatory (Yes or No)
Schedule Date	Used to specify the schedule date for payment of schedule amount in the form of installments.	Yes
Schedule Amount	Used to specify the schedule amount to be paid in terms of installments.	Yes
Auto Pay ID	Used to search for auto pay ID.	Yes (Conditional)
	Note: This field can be edited when the Pay Method is selected for electronic payment of schedule amount. The Search (🔍) icon appears corresponding to the field. Auto pay details are displayed corresponding to the searched auto pay id.	Note: This field is required when you are defining an electronic payment for Pay Method .

If you want to define more than one payment schedules for the payment agreement request, click the **Add** (+) icon.

Note: However, if you want to remove a payment schedule from the payment agreement request, click the **Delete** (🗑️) icon corresponding to the schedule date.

- **Characteristics** – Used to define the characteristics for the payment tender. This section contains the following fields:

Field Name	Field Description	Mandatory (Yes or No)
Effective Date	Used to specify the date from when the characteristic is effective for the payment agreement request.	Yes (Conditional)
		Note: This field is required when you are defining a characteristic for the payment agreement request.
Characteristic Type	Used to indicate the characteristic type.	Yes (Conditional)
	Note: The list includes only those characteristic types where the characteristic entity is set to Payment Agreement Request .	Note: This field is required when you are defining a characteristic for the payment agreement request.

Field Name	Field Description	Mandatory (Yes or No)
Characteristic Value	Used to specify the value for the characteristic type.	Yes (Conditional)
	Note: On specifying the value for a predefined characteristic type, the description of the characteristic value appears corresponding to the Characteristic Value field.	Note: This field is required when you are defining a characteristic for the payment agreement request.

4. Add or modify the details of the payment agreement request, if required.
5. Define, edit, or remove characteristics of the payment agreement request, if required.
6. Click **Save**.

The changes made to the payment agreement request are saved.

Note: Approval is not required for modifications done on an active payment agreement request.

Related Topics

For more information on...	See...
How to search for a payment agreement request	Searching for a Payment Agreement Request on page 2054
Payment Agreement Request screen	Payment Agreement Request (Used for Viewing) on page 2058
Payment Agreement Request zone	Payment Agreement Request on page 2059
How to define a characteristic for a payment agreement request	Defining a Characteristic for a Payment Agreement Request on page 2055

Deleting a Payment Agreement Request

Procedure

To delete a payment agreement request:

1. Search for the payment agreement request in the **Payment Agreement Request** screen.
2. In the **Search Results** section, click the link in the **Payment Agreement Request Information** column corresponding to the payment request that you want to delete.

The **Payment Agreement Request** screen appears.

3. Click the **Delete** button in the **Payment Agreement Request** zone.

A message appears confirming whether you want to delete the payment agreement request.

Note: The **Delete** button appears when the payment agreement request is in the **Draft** status.

4. Click **OK**.

The payment agreement request is deleted.

Related Topics

For more information on...	See...
How to search for a payment agreement request	Searching for a Payment Agreement Request on page 2054
Payment Agreement Request screen	Payment Agreement Request (Used for Viewing) on page 2058
Payment Agreement Request zone	Payment Agreement Request on page 2059
Bill Details zone	Bill Details on page 2061
Payment Schedule zone	Payment Schedule on page 2062

Submitting a Payment Agreement Request

Prerequisites

To submit a payment agreement request, you should have:

- Payment Agreement Request Types defined in the request.

Procedure

To submit a payment agreement request:

1. Search for the payment agreement request in the **Payment Agreement Request** screen.
2. In the **Search Results** section, click the link in the **Payment Agreement Request Information** column corresponding to the payment agreement request that you want to submit.

The **Payment Agreement Request** screen appears.

3. Click the **Submit** button in the **Payment Agreement Request** zone.

The system behaves in the following manner:

If...	Then
The Approval Required check box is selected in the payment agreement request type using which the payment agreement request is created.	A To Do of the To Do Type is created for the payment agreement request entity and sent to the approver. Status of the payment agreement request is changed to Approval In Progress . C1-PAREQ is the to do type for Payment Agreement Request.
The Approval Required check box is not selected in the payment agreement request type using which the payment agreement request is created.	The payment agreement request is created using the specified payment agreement request types and the status of the payment agreement request is changed to as specified in the payment agreement request type.

Note:

The **Submit** button appears when the payment agreement request is in the **Draft** status.

For more information about the **Payment Agreement Request Periodic Monitor (C1-PAREQ)** batch, refer to Oracle Revenue Management and Billing Batch Guide.

Related Topics

For more information on...	See...
How to search for a payment agreement request	Searching for a Payment Agreement Request on page 2054
Payment Agreement Request screen	Payment Agreement Request (Used for Viewing) on page 2058

For more information on...	See...
Payment Agreement Request zone	Payment Agreement Request on page 2059

Removing an Overdue Bill from a Payment Agreement Request

Prerequisites

To remove an overdue bill from a payment agreement request, you should have:

- Bill details should be available to be removed from payment agreement request

Procedure

To delete a bill detail from payment agreement request:

1. Search for the payment agreement request in the **Payment Agreement Request** screen which is in **Draft** status.
2. In the **Search Results** section, click the link in the **Payment Agreement Request Information** column corresponding to the payment agreement request whose details you want to view.

By default, the **Main** tab of the **Payment Agreement Request** screen appears.

3. List of bill details are displayed in the **Bill Details** zone.
4. Select the check box corresponding to the bill which you want to delete from the payment agreement request.

You can delete more than one bill from the payment agreement request at the same time.

5. Click **Delete**.

A message appears indicating that selected bills have been successfully deleted from the payment agreement request.

6. Click **OK**.

Note that the bill is added in the **Search Bills** zone in the **Bills** tab.

Note: Bills in **Active** status cannot be deleted.

Related Topics

For more information on...	See...
How to search for a payment agreement request	Searching for a Payment Agreement Request on page 2054
How to create a payment agreement request	Creating a Payment Agreement Request on page 2054
Bill Details zone	Bill Details on page 2061
Search Bills zone	Search Bills on page 2062

Approving a Payment Agreement Request

You can view the number of payment agreement requests which are pending for approval in the **Payment Agreement Request** screen. The approver can review, and accordingly approve or reject the payment agreement request based on the observations.

Note: The system will not allow you to approve or reject a payment agreement request submitted by you.

Procedure

To approve a payment agreement request:

1. Do either of the following:

If you want to	Then
Approve a payment agreement request through the Payment Agreement Request screen	<ol style="list-style-type: none"> 1. Search for the payment agreement request in the Payment Agreement Request screen. 2. In the Search Results section, click the link in the Payment Agreement Request Information column corresponding to the payment agreement request which you want to review.
Approve a payment agreement request from the To Do List screen	<ol style="list-style-type: none"> 1. Click the Menu link in the Application toolbar. A list appears. 2. From the Main menu, select To Do and then click To Do List. The To Do Type for User Search window appears. 3. Enter the to do type C1-PAREQ in the To Do Type field for the entity payment agreement request. 4. Click the Search button corresponding to the To Do Type field. The To Do List screen appears. 5. Select the Open option from the Filter by list to view all unassigned To Dos. 6. Click the link in the Message column corresponding to the To Do of the payment agreement request that you want to review.

The **Payment Agreement Request** screen appears.

2. Review the payment agreement request details.
3. Click the **Approve** button in the **Payment Agreement Request** zone.

The system behaves in the following manner:

If you are...	Then
Approving a payment agreement request	The status of the payment agreement request is changed to Approval In Progress as specified in the payment agreement request type.

Note: The **Approve** button appears when:

- The payment agreement request is in the **Approval In Progress** status.
- A user with the approval To Do role is reviewing the payment agreement request.

Related Topics

For more information on...	See...
Payment Agreement Request screen	Payment Agreement Request (Used for Viewing) on page 2058
Payment Agreement Request zone	Payment Agreement Request on page 2059
How to search for a payment agreement request	Searching for a Payment Agreement Request on page 2054

Rejecting a Payment Agreement Request

Prerequisites

To reject a payment agreement request, you should have:

- Rejection reasons defined in the application

Note:

While rejecting a payment agreement request, you need to specify the reason why you want to reject the payment agreement request. You can select the appropriate rejection reason when you have defined the reasons for the **Rejected** status of the **C1-PaymentAgreementRequest** business object in the **Status Reason** screen.

The system will not allow you to approve or reject a payment agreement request submitted by you.

Procedure

To reject a payment agreement request:

1. Do either of the following:

If you want to	Then
Reject a payment agreement request through the Payment Agreement Request screen	<ol style="list-style-type: none"> 1. Search for the payment agreement request in the Payment Agreement Request screen. 2. In the Search Results section, click the link in the Payment Agreement Request Information column corresponding to the payment request which you want to review.
Reject a payment agreement request from the To Do List screen	<ol style="list-style-type: none"> 1. Click the Menu link in the Application toolbar. A list appears. 2. From the Main menu, select To Do and then click To Do List. The To Do Type for User Search window appears. 3. Enter the to do type C1-PAREQ in the To Do Type field for the entity payment agreement request. 4. Click the Search button corresponding to the To Do Type field. The To Do List screen appears. 5. Select the Open option from the Filter by list to view all unassigned To Dos.

If you want to	Then
	6. Click the link in the Message column corresponding to the To Do of the payment agreement request that you want to review.

The **Payment Agreement Request** screen appears.

- Review the payment agreement request details.
- Click the **Reject** button in the **Payment Agreement Request** zone.

The **Reject Payment Request** window appears. It contains following fields:

Field Name	Field Description	Mandatory (Yes or No)
Status Reason	Used to indicate the reason why you want to reject the payment agreement request.	Yes
Comments	Used to specify additional information while rejecting the payment agreement request.	No

Note: The **Reject** button appears when:

- The payment agreement request is in the **Approval In Progress** status.
- A user with the approval To Do role is reviewing the payment agreement request.

- Select the rejection reason from the **Status Reason** list.
- Click **Save**.

The status of the payment agreement request is changed to **Rejected**.

Related Topics

For more information on...	See...
How to search for a payment agreement request	Searching for a Payment Agreement Request on page 2054
Payment Agreement Request screen	Payment Agreement Request (Used for Viewing) on page 2058
Payment Agreement Request zone	Payment Agreement Request on page 2059

Resubmitting a Payment Agreement Request

Prerequisites

To resubmit a payment agreement request, you should have:

- Entities added in the payment agreement request which is submitted for approval.

Procedure

To resubmit a payment agreement request:

- Search for the payment agreement request in the **Payment Agreement Request** screen.
- In the **Search Results** section, click the link in the **Payment Agreement Request Information** column corresponding to the payment agreement request that you want to resubmit.

The **Payment Agreement Request** screen appears.

- Click the **Resubmit** button in the **Payment Agreement Request** zone.

The **Resubmit Payment Agreement Request** screen appears.

Note: The **Resubmit** button appears when the payment agreement request is in the **Approval In Progress** status.

A To Do of the **C1-PAREQ** To Do type is created and sent to the request submitter using the submitter TO DO Role and the status of the payment agreement request is changed to **Draft**.

4. Enter the comments in the respective field and click **Save**.

Note: While resubmitting, To Do will be sent to the submitter of the request using the submitter To Do Role mapped on the payment agreement request type and the request will be moved to Draft status. The submitter can do necessary changes and re submit the request. Log will be maintained when the approver sends the request back to submitter.

Related Topics

For more information on...	See...
How to search for a payment agreement request	Searching for a Payment Agreement Request on page 2054
Payment Agreement Request screen	Payment Agreement Request (Used for Viewing) on page 2058
Payment Agreement Request zone	Payment Agreement Request on page 2059
How to submit a payment agreement request	Submitting a Payment Agreement Request on page 2068

Filtering Overdue Bills of an Account

The **Search Bills** zone lists bills that are overdue for an account. You will not find any records in this zone if the payment agreement request does not have overdue bills in the account. This zone contains the following fields as search criteria:

Field Name	Field Description	Mandatory (Yes or No)
Search By	Used to indicate whether you want to search for a payment agreement request using bill details.	Yes
	Note: By default, the Bill Details option is selected.	
Bill ID	Used to search for a particular bill.	No
	Note: The Search (🔍) icon appears corresponding to the field. On clicking the Search icon, the Bill Search window appears.	
Bill Date From	Used to search bills which are created from a particular date onwards.	No
To	Used to search bills which are created till a particular date.	No

By default, the **Search Bills** zone appears in the **Bills** tab of **Payment Agreement Request** screen. By default, the **Filter** area is visible. You can hide the **Filter** area by clicking the **Filters** (🔼) icon in the upper right corner of this zone.

By default, the search results section displays the following columns:

Column Name	Column Description
Bill ID	Displays the bill ID.

Column Name	Column Description
Bill Information	Displays additional information about the bill. In addition, this column has a context menu which helps in navigating to other screens in the application.
	Note: It has a link. On clicking the link, the Bill screen appears with the details of the respective bill.
Unpaid Amount	Displays the amount which is eligible for payment agreement request against the bill.
Overdue Process Information	Displays the overdue process information for the bill.

Related Topics

For more information on...	See...
Bills tab	Payment Agreement Request - Bills on page 2062
Bill Details zone	Bill Details on page 2061
How to add an overdue bill in a payment agreement request	Adding an Overdue Bill in a Payment Agreement Request on page 2074

Adding an Overdue Bill in a Payment Agreement Request

Prerequisites

To add an overdue bill in a payment agreement request, you should have:

- Overdue bills should be available for accounts to add in payment agreement request

Procedure

To add an overdue bill in a payment agreement request:

Note: A bill with outstanding amount greater than zero which is not part of an overdue process will be allowed to be added in a payment agreement request. While a bill with negative outstanding amount will not be allowed to be added in a payment agreement request.

1. Search for the payment agreement request in the **Payment Agreement Request** screen which is in **Draft** or **Active** status.
2. In the **Search Results** section, click the link in the **Payment Agreement Request Information** column corresponding to the payment agreement request whose details you want to view.
The **Payment Agreement Request** screen appears.
3. Click the **Bills** tab.
The **Bills** tab appears.
4. Enter the search criteria in the **Search Bills** zone.
In the **Search Results** section, list of bills meeting the search criteria are displayed.
5. Select the check box corresponding to the bill which you want to add to the payment agreement request from the **Search Results** section.
You can add more than one bill to the payment agreement request at the same time.
6. Click **Add**.
A message appears indicating that selected bills have been successfully added to the payment agreement request.
7. Click **OK**.

Note that the bill is added in the **Bill Details** zone in the **Main** tab.

Related Topics

For more information on...	See...
How to search for a payment agreement request	Searching for a Payment Agreement Request on page 2054
How to create a payment agreement request	Creating a Payment Agreement Request on page 2054
Search Bills zone	Search Bills on page 2062
Bill Details zone	Bill Details on page 2061

Viewing the Log of a Payment Agreement Request

Procedure

To view the log of a payment agreement request:

1. Search for the payment agreement request in the **Payment Agreement Request** screen.
2. In the **Search Results** section, click the link in the **Payment Agreement Request Information** column corresponding to the payment agreement request whose log you want to view.

The **Payment Agreement Request** screen appears. It consists of the following tabs:

- **Main** – This tab contains the following three zones:
 - **Payment Agreement Request** – Displays the details of the payment agreement request.
 - **Bill Details** – Lists the bill details of the payment agreement request.
 - **Payment Schedule** – Lists the payment schedule details of the bills for the payment agreement request.
- **Bills** – This tab lists the unpaid bill amount details for the same account.

Note: This tab will be displayed when the payment agreement is in **Draft** status.

- **Log** – This tab lists the complete trail of actions performed on the payment agreement request.
3. Click the **Log** tab.

The **Payment Agreement Request Log** zone in the **Log** tab contains the following columns:

Column Name	Column Description
Date/Time	Displays the date and time when the action was performed on the payment agreement request.
Details	Displays the details about the action performed on the payment agreement request.
User	Indicates the user who has performed the action on the payment agreement request.
Log Type	Indicates the type of log.
Related Object	Indicates the object or entity which is generated when the action is performed on the payment agreement request.
Status Reason	Indicates the reason why the payment agreement request was rejected.
Old Payment Schedule	Displays the details of old payment schedule.

Note: You can manually add a log entry for the payment agreement request by clicking the **Add Log Entry** link in the upper right corner of the **Payment Agreement Request Log** zone.

Related Topics

For more information on...	See...
How to search for a payment agreement request	Searching for a Payment Agreement Request on page 2054
How to add a log entry for a payment agreement request	Adding a Log Entry for a Payment Agreement Request on page 2076

Adding a Log Entry for a Payment Agreement Request

Procedure

To add a log entry for a payment agreement request:

1. Search for the payment agreement request in the **Payment Agreement Request** screen.
2. In the **Search Results** section, click the link in the **Payment Agreement Request Information** column corresponding to the payment agreement request whose log you want to edit.

The **Payment Agreement Request** screen appears. It consists of the following tabs:

- **Main** – This tab contains the following three zones:
 - **Payment Agreement Request** – Displays the details of the payment agreement request.
 - **Bill Details** – Lists the bill details of the payment agreement request.
 - **Payment Schedule** – Lists the payment schedule details of the bills for the payment agreement request.
- **Bills** – This tab lists the unpaid bill amount details for the same account.

Note: This tab will be displayed when the payment agreement is in **Draft** status.

- **Log** – This tab lists the complete trail of actions performed on the payment agreement request.
3. Click the **Log** tab.

The **Log** tab appears.

4. Click the **Add Log Entry** link in the upper right corner of the **Payment Agreement Request Log** zone.

The **Add Payment Agreement Request Log** window appears. It contains the following fields:

Field Name	Field Description	Mandatory (Yes or No)
Payment Agreement Request Information	Displays information about the payment agreement request.	Not applicable
Log Details	Used to specify additional comments for the payment agreement request.	Yes

5. Enter the comments in the **Log Details** field.
6. Click **Save**.

The log entry is added in the **Payment Agreement Request Log** zone.

Related Topics

For more information on...	See...
How to search for a payment agreement request	Searching for a Payment Agreement Request on page 2054

Chapter 30

Inbound Message

Topics:

- [Health Care Inbound Message](#)
- [Health Product and Plan Inbound Message](#)
- [Inbound Message Type](#)
- [Inbound Message \(Used for Searching\)](#)
- [Inbound Message \(Used for Viewing\)](#)
- [Statement Construct Preference](#)

Oracle Revenue Management and Billing enables you to create the following inbound messages through the respective inbound web services:

Inbound Message	Inbound Web Service
Health Care Inbound Message on page 2080	C1-HCInboundMessage on page 2285

Once an inbound message is created, you can submit the inbound message for validation and processing from the user interface or through a batch process. The following table lists the batches which validate and process the respective inbound message at regular intervals:

Inbound Message	Batch Control Name
Health Care Inbound Message	Health Care Inbound Message Periodic Monitor (C1-HCINB)

For more information about the batches, refer to *Oracle Revenue Management and Billing Batch Guide*.

Health Care Inbound Message

On calling the **C1-HCInboundMessage** web service, you can create a health care inbound message using a health care inbound message type. You can create a health care inbound message type using the **Health Care Inbound Message Type (C1-HCInboundMsgType)** business object. The health care inbound message type helps the system to determine:

- **Inbound Message Business Object** - The business object using which the health care inbound message should be created in the system. You must specify the **Health Care Inbound Message (C1-HCInboundMessage)** business object in the health care inbound message type.
- **Customer Registration Type** - The health care inbound message creates the person, account, policy, and policy plan through a customer registration object. The system creates the customer registration object using the customer registration type specified in the health care inbound message type. The customer registration type helps the system to determine:
 - **Customer Registration Business Object** - The business object using which the customer registration object should be created in the system. You must specify the **Customer Registration - Health Care (C1-CustomerRegistrationHC)** business object in the customer registration type.
 - **Person Business Object** - The business object using which the person should be created in the system. You must specify the **Person BO (C1_PERSON_BO)** business object in the customer registration type.
 - **Account Business Object** - The business object using which the account should be created in the system. You must specify the **Account BO (C1-AccountBO)** business object in the customer registration type.
 - **Policy Plan Business Object** - The business object using which the policy plan should be created in the system. You must specify the **Policy Plan (C1-PolicyPlan)** business object in the customer registration type.
 - **Membership Business Object** - The business object using which the membership should be created in the system. You must specify the **Membership (C1-Membership)** business object in the customer registration type.
 - **Address Business Object** - The business object using which the effective dated address should be created in the system. You must specify the **Address (C1-Address)** business object in the customer registration type.

While creating a health care inbound message type for the fully-insured group health insurance business, you must use a customer registration type where the **Approval Required**, **Final Approval Required**, and **Manual Billing Hierarchy and Pricing** options are not selected. However, while creating a health care inbound message type for the self-funded health insurance business, you must use a customer registration type where the **Final Approval Required** and **Manual Billing Hierarchy and Pricing** options are selected, but the **Approval Required** option is not selected.

The **C1-HCInboundMessage** web service enables you to do the following depending on the person type and the category to which the policy type belongs:

Person Type	Policy Category	Enables you to:
Parent Customer	Self-Funded	<ul style="list-style-type: none"> • Create or edit a parent customer • Create or edit a bill group of the parent customer • Create the derivation and pricing parameters for the bill group • Create or edit the accounts of a bill group • Create or edit the policies of a bill group

Person Type	Policy Category	Enables you to:
	Fully-Insured Group	<ul style="list-style-type: none"> • Create or edit a parent customer • Create or edit a bill group of the parent customer • Create the derivation and pricing parameters for the bill group • Create or edit the accounts of the parent customer and bill group • Create or edit the policies of the parent customer and bill group • Create or edit the plans of the policies • Associate one or more pricing rule types with a policy plan • Create or edit the pricing rules of the policy plans • Terminate, reinstate, or renew policies of the parent customer and bill group
Bill Group	Self-Funded	<ul style="list-style-type: none"> • Create or edit a bill group • Create the derivation and pricing parameters for the bill group • Create or edit the accounts of the bill group • Create or edit the policies of the bill group
	Fully-Insured Group	<ul style="list-style-type: none"> • Create or edit a bill group • Create the derivation and pricing parameters for the bill group • Create or edit the accounts of the bill group • Create or edit the policies of the bill group • Create or edit the plans of the policies • Associate one or more pricing rule types with a policy plan • Create or edit the pricing rules of the policy plans • Terminate, reinstate, or renew policies of the bill group

Person Type	Policy Category	Enables you to:
Any Other Person Type	-	<ul style="list-style-type: none"> • Create or edit a person • Credit or edit the accounts of the person • Create or edit the memberships of the policy plans • Add or remove members from a membership • Create or edit the one-time or recurring pass-through billable charges for a membership

The following table describes how the system behaves when the respective entity information is given in a health care inbound message:

Entity	System Behavior
Person	<p>The system uses the C1-PERSTYPE feature configuration to decide whether the person type specified in the health care inbound message represents Parent Customer or Bill Group. If the person type specified in the health care inbound message matches the person type specified in the Bill Group Person Type or Parent Person Type option type of the C1-PERSTYPE feature configuration, the system creates or updates the person, account, policy, policy plan, and address through a customer registration object. Note that the memberships, pass-through billable charges, and pricing rules are created directly and not via customer registration object. However, if the person type specified in the health care inbound message does not match the person type specified in the Bill Group Person Type or Parent Person Type option type, the system creates or updates the person and its other entities directly and not through a customer registration object. In this case, the system only refers the customer registration type for the business objects using which the person, account, policy plan, membership, and address should be created or updated in the system.</p> <p>If the related person information is given for a bill group and the person type of the related person is Parent Customer, then the bill group is related to the parent customer using the person relationship type which is specified in the Person Relationship Type option type of the C1-ASOBLNG feature configuration.</p> <p>If the derivation and pricing parameters are specified for a bill group, the system automatically creates one sort record for the bill group. Here, the sort ID is set to the bill group ID. The start and end dates of the sort record are set to the bill group and parent customer's relationship start and end dates. Once the sort record is created, the system creates the derivation and pricing parameters for the bill group and sort ID combination.</p> <p>Note: The system supports the Add and Update operations for all entities except the derivation and pricing parameters for the bill group. Through the health care inbound message, each time, the system creates a new derivation and pricing parameters record for the bill group and does not update the existing derivation and pricing parameters record of the bill group.</p>
Account	<p>While creating an account, the system defines the Invoice Type characteristic for the account. It stores the account type given in the account information in the characteristic type which is specified in the Invoice Type Characteristic Type option type of the C1-ASOBLNG feature configuration.</p>

Entity	System Behavior
Policy	<p>If the fully-insured group policy information is given for a bill group, the system does the following:</p> <ul style="list-style-type: none"> • Associates the bill group with the policy using the policy person role which is specified in the Bill Group Policy Person Role option type of the C1-ASOBLNG feature configuration • Associates the parent customer with the policy using the policy person role which is specified in the Parent Customer Policy Person Role option type of the C1-ASOBLNG feature configuration <p>However, if the fully-insured group policy information is given for a parent customer, the system does the following:</p> <ul style="list-style-type: none"> • Associates the parent customer with the policy using the policy person role which is specified in the Parent Customer Policy Person Role option type of the C1-ASOBLNG feature configuration <p>If the self-funded policy information is given for a bill group, the system does the following:</p> <ul style="list-style-type: none"> • Associates the bill group with the policy using the policy person role which is specified in the Bill Group Policy Person Role option type of the C1-ASOBLNG feature configuration • Associates the parent customer with the policy using the policy person role which is specified in the Parent Customer Policy Person Role option type of the C1-ASOBLNG feature configuration <p>On renewing a fully-insured group policy, the system removes the end date from the policy and stamps the renewal date against the policy.</p>
	<p>Note: You can renew a policy where the policy category is set to Self-Funded from the user interface and not through a health care inbound message. However, you can renew a policy where the policy category is set to Fully-Insured Group through a health care inbound message and not from the user interface.</p>
	<p>On terminating a fully-insured group policy, the system updates the end date of the following entities with the termination date:</p> <ul style="list-style-type: none"> • Policy • Policy Person • Policy Plan • Membership • Membership Person • Pricing Rule <p>However, before updating the end dates, the system stores the original end date in the ORG_END_DT column of the respective table for all the above entities. The status of the policy is changed to the status which is specified in the Policy Termination Status option type of the C1-ASOBLNG feature configuration.</p> <p>On reinstating a fully-insured group policy, the system updates the end date of the above entities with the original end date. In addition, the status of the policy is changed to the status which is specified in the Policy Reinstatement Status option type of the C1-ASOBLNG feature configuration.</p>

Entity	System Behavior
Policy Plan	While creating a policy plan, the system requires either the price item or at least one pricing rule type. The system allows you to associate only those pricing rule types where the category is set to Age Based , Tier Based , or Pass-Through Billable Charge .
Pricing Rule Type	The system does not allow you to create or update a pricing rule type through a health care inbound message.
Pricing Rule	<p>The system allows you to define and edit the age-based and tier-based pricing rules of the policy plan. Note that the system supports the Replace operation and not the Update operation when you are editing these pricing rules through a health care inbound message.</p> <p>Note:</p> <p>You can define and edit the age-based and tier-based pricing rules through a health care inbound message and not from the user interface.</p> <p>You can create the following pricing rules from the user interface and not through a health care inbound message:</p> <ul style="list-style-type: none"> • Claim • Specific Stop-Loss • Aggregate Stop-Loss • Retention Type Claim Based • Retention Type Enrollment Based • One-Time Flat Fees • Recurring Flat Fees • Ancillary • Discount Arrangement • Level Funded
Pass-Through Billable Charge	If the price item, account identifier type, and account identifier are given in the billable charge information, the system directly creates an SQI based billable charge when you process the health care inbound message. But, if only the price item is given in the billable charge information, the system checks whether the price item is included in any pricing rule type where the pricing rule type category is set to Pass-Through Billable Charge . If so, the system checks whether the pass-through billable charge pricing rule type is associated with the policy plan to which the membership belongs (for which the billable charge information is received). If so, the system creates an SQI based billable charge using the respective pass-through billable charge pricing rule type.

Note:

We recommend you to create or update the following through separate health care inbound messages:

- Entities, such as parent customer, bill group, accounts, policies, and policy plans
- Pricing rules
- Membership, member persons, and pass-through billable charges

On calling the **C1-HCInboundMessage** web service, a health care inbound message is created in the **Pending** status. When the **Health Care Inbound Message Periodic Monitor (C1-HCINB)** batch is executed, the system checks whether there are any health care inbound messages in the **Pending** status. If there is a health care inbound message in the **Pending** status, the system validates the inbound message. If the health care inbound message is successfully validated, it is processed further and the entities are either created or updated in the system based on the available information.

Alternatively, the system enables you to submit the health care inbound messages for validation and processing from the user interface. On submitting a health care inbound message, the system validates the health care inbound message. If a health care inbound message is successfully validated, it is processed further and the required entities are created or updated in the system based on the available information.

If the person type is **Parent Customer**, the customer registration object is created in the **Complete** status. However, if the person type is **Bill Group**, the customer registration object is created in the **Bill Group Approved** status. The policies are created in the **In Force/Active** status and the pricing rules are created in the **Active** status. Finally, the status of the health care inbound message is changed to **Processed**.

Note: The above status transition is mentioned for a customer registration object based on the assumption that the data sent through the health care inbound message will be pre-approved and does not require any approval in the system.

If any error occurs while validating or processing a health care inbound message, the status of the health care inbound message is changed to **Rejected**. The system enables you to either reprocess or void a rejected health care inbound message. The system can reprocess a health care inbound message when its status is changed to **Pending**. Using the **Retry** option, you can change the status of the health care inbound message from **Rejected** to **Pending**. The **Health Care Inbound Message Periodic Monitor (C1-HCINB)** batch will then reconsider and reprocess the health care inbound message.

You can also configure the system such that the batch can automatically retry to process the rejected health care inbound messages. However, it will attempt to retry when the **Maximum Retry** parameter in the **Retry for To Dos (C1-TODORETRY)** algorithm is set to a value greater than zero. Also, the maximum number of times the batch can attempt to retry and reprocess a health care inbound message depends on the value defined in the **Maximum Retry** parameter.

At present, if a customer registration object is created through a health care inbound message, you cannot edit the customer registration object from the user interface. You can only edit such customer registration objects through a health care inbound message.

Related Topics

For more information on...	See...
How to setup the C1-ASOBLNG feature configuration	Setting the C1-ASOBLNG Feature Configuration on page 3421
How to setup the C1-PERSTYPE feature configuration	Setting the C1_PERSTYPE Feature Configuration on page 3463

Prerequisites

To use the health care inbound message feature, you need to do the following:

- Define the required customer registration types in the system.

Note: The health care inbound message creates the person, account, policy, and policy plan through a customer registration object. The system creates the customer registration object using the customer registration type specified in the health care inbound message type. While creating a health care inbound message type for the fully-insured group health insurance business, you must use a customer registration type where the **Approval Required**, **Final Approval Required**, and **Manual Billing Hierarchy and Pricing** options are not selected. However, while creating a health care inbound message type for the self-funded health insurance business, you must use a customer registration type where the **Final Approval Required** and **Manual Billing Hierarchy and Pricing** options are selected, but the **Approval Required** option is not selected.

- Define the required health care inbound message types in the system.
- Define the required characteristic types where the characteristic entity is set to **Inbound Message Type**.
- Define the required characteristic types where the characteristic entity is set to **Inbound Message**.
- Define the values for the required parameters in the **C1-HCINVAL**, **C1-HCINPROC**, **C1-TODORETRY**, and **C1-TDCRINMSG** algorithms.
- Define the values for the **C1-SourceSystemLookup** and **C1-ExtLookRetTypeRateOpt** extendable lookups.
- Define the values for the **HOUSE_TYPE**, **PER_OR_BUS_FLG**, **NAME_TYPE_FLG**, **ADDRESS_TYPE_FLG**, **BILL_ADDR_SRCE_FLG**, **BILL_FORMAT_FLG**, and **RUNOUT_ADM_OPT_FLG** lookup fields.
- Set the values for the following option types in the **C1-ASOBLNG** feature configuration:
 - Person Relationship Type
 - Bill Group Policy Person Role
 - Parent Customer Policy Person Role
 - Invoice Type Characteristic Type
 - Policy Termination Status
 - Policy Reinstatement Status
 - Default Rate Option – Flat
 - Default Rate Option – Percentage
 - Age Based Parameter
 - Membership Inactive Status
 - Member Person Inactive Status
- Set the values for the following option types in the **C1-PERSTYPE** feature configuration:
 - Bill Group Person Type
 - Parent Person Type
- Define the required person identifier types, account identifier types, person relationship types, characteristic types, phone types, customer classes, bill cycles, collection classes, divisions, bill route types, charge types, currencies, bill periods, invoice frequencies, distribution codes, auto pay route types, auto pay sources, account relationship types, policy types, policy person roles and contract relationship types in the application.
- Define the values for the **C1_INVOICE_DAY_BILL_PERIOD_FLG** lookup field.

Note: Each lookup field value should be mapped to a valid bill period which exists in the system. You must then define this lookup field value as a predefined value for the **C1OFFRST** characteristic type. The system will then use the bill period configured for the respective invoice day when the **C1OFFRST** characteristic is defined for the account.

- Define the required predefined values for the **C1OFFRST** characteristic type.
- Set the batch control type of the **Health Care Inbound Message Periodic Monitor (C1-HCINB)** batch to **Timed** and define the following attributes:
 - Time Interval
 - Timer Active
 - User ID
 - Batch Language

- Email Address
- Define the required status reasons for the status to which a policy must be transitioned on policy termination.
- Define the required status reasons for the status to which a policy must be transitioned on policy reinstatement.
- Define the bill cancel reasons which you want to use when the premium bill segment is canceled during the policy or membership termination.
- Define the required exchange rates in the system.
- Attach a currency conversion algorithm to the **Currency Conversion For Bill Segments** algorithm spot of the required divisions.

Related Topics

For more information on...	See...
How to setup the C1-ASOBLLNG feature configuration	Setting the CI-ASOBLLNG Feature Configuration on page 3421
How to setup the C1-PERSTYPE feature configuration	Setting the CI_PERSTYPE Feature Configuration on page 3463

Health Care Inbound Message Status Transition through User Interface

The following figure graphically indicates how a health care inbound message moves from one status to another when it is validated and processed through the user interface:

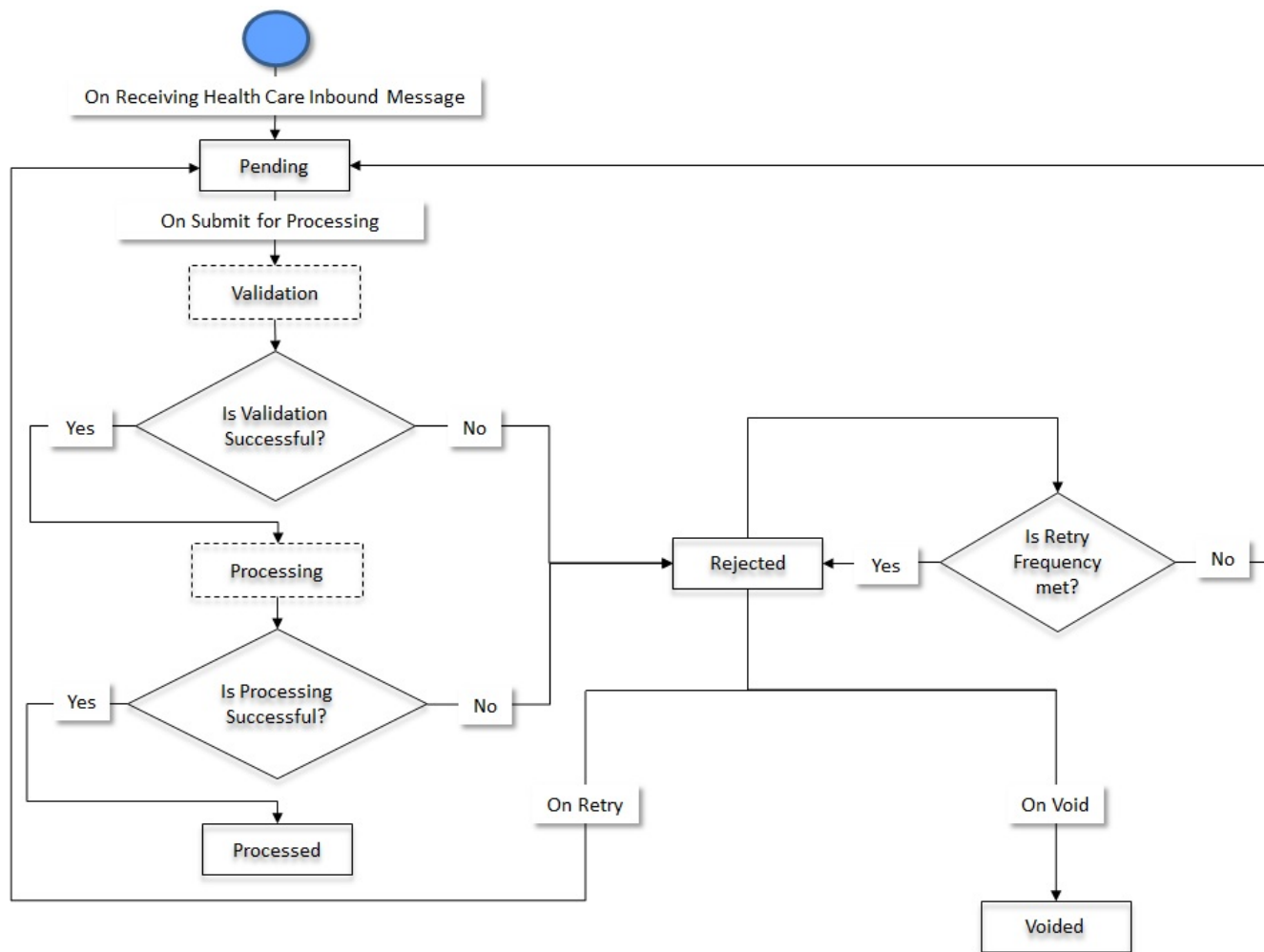

Health Care Inbound Message Status Transition through a Batch Process

The following figure graphically indicates how a health care inbound message moves from one status to another when it is validated and processed through the **Health Care Inbound Message Periodic Monitor (C1-HCINB)** batch:

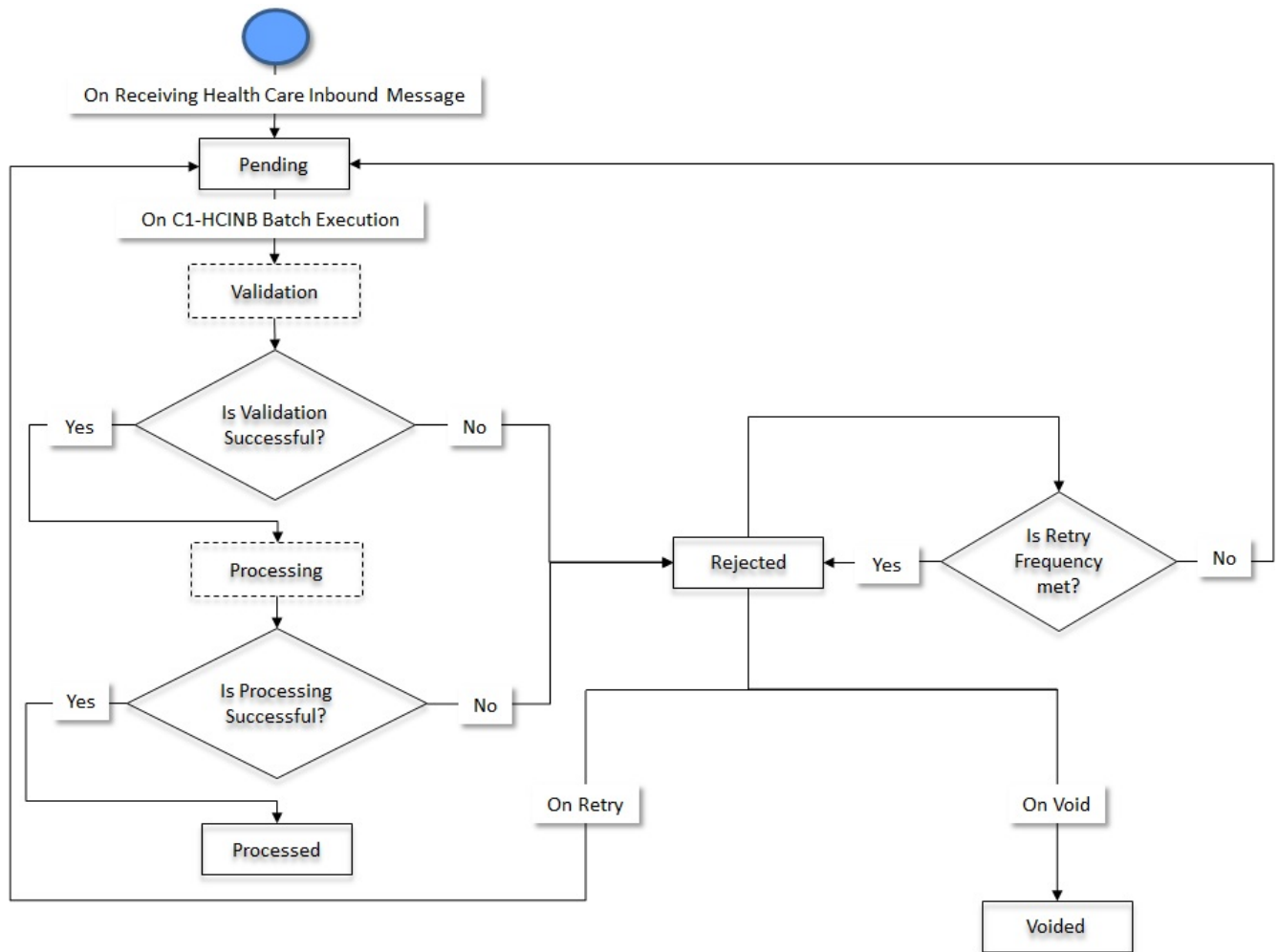

Algorithms Used in C1-HCInboundMessage

The following table lists the algorithms which are used in the lifecycle of the **C1-HCInboundMessage** business object:

Status	System Event	Algorithm	Algorithm Type	Description
Pending	Monitor	C1-AT-RQJ	C1-GEN-BOMNJ	Refer to C1-AT-RQJ on page 2090.
Validation	Monitor	F1-AT-RQJ	F1-GEN-BOMNJ	Refer to F1-AT-RQJ on page 1567.
	Enter	C1-HCINVAL	C1-HCINVAL	Refer to C1-HCINVAL on page 2090.
Processing	Monitor	F1-AT-RQJ	F1-GEN-BOMNJ	Refer to F1-AT-RQJ on page 1567.
	Enter	C1-HCINPROC	C1-HCINPROC	Refer to C1-HCINPROC on page 2091.

Status	System Event	Algorithm	Algorithm Type	Description
Rejected	Monitor	C1-TODORETRY	C1-TODORETRY	Refer to C1-TODORETRY on page 2091.
	Enter	C1-TDCRINMSG	F1-TDCREATE	Refer to C1-TDCRINMSG on page 2092.
Processed	-	-	-	-
Voided	-	-	-	-

C1-AT-RQJ

This algorithm is invoked when the status of the customer or membership inbound message is changed to **Pending**. If the **isRetried** flag in the inbound message is set to **true**, it resets the flag to **false**.

It contains the following parameters:

- **Next Status** – Used when you want to override the default next status specified in the lifecycle.
- **Next Transition Condition** – Used when you want to override the default next transition condition specified in the lifecycle.

Note: At a time, you can specify value for either the **Next Status** or **Next Transition Condition** parameter. If you don't specify any value for these parameters, the system will transition the business object to the default next status specified in its lifecycle.

F1-AT-RQJ

This algorithm transitions the current status of the business object to the specified status. It contains the following parameters:

- **Next Status** – Used when you want to override the default next status specified in the lifecycle.
- **Next Transition Condition** – Used when you want to override the default next transition condition specified in the lifecycle.

At a time, you can specify value for either the **Next Status** or **Next Transition Condition** parameter. If you don't specify any value for these parameters, the system will transition the business object to the default next status specified in its lifecycle.

C1-HCINVAL

Health Care Inbound Message - Validation

This algorithm is invoked when you execute the **Health Care Inbound Message Periodic Monitor (C1-HCINB)** batch or click the **Submit for Processing** button in the **Inbound Message** screen. It validates the health care inbound message which is in the **Pending** status. It checks the following:

- Whether the details of the parent customer are given in the bill group information.
- Whether the primary identifier is specified for the parent customer and bill group.
- Whether multiple primary identifiers are not specified for the parent customer and bill group.
- Whether the expiration year and month are specified in the account's auto pay details when the **Expiration Date Required** option is selected for the tender type which is specified in the auto pay source.
- Whether the expiration year is not earlier than 1755.
- Whether the expiration month lies between 1 and 12.

If the validation fails due to any reason, the status of the health care inbound message is changed to **Rejected**. In addition, the appropriate log entry is added which you can view in the **Inbound Message Log** zone.

It contains the following parameters:

- **Next Status** - Used when you want to override the default next status specified in the lifecycle.
- **Next Transition Condition** - Used when you want to override the default next transition condition specified in the lifecycle.

Note: At a time, you can specify value for either the **Next Status** or **Next Transition Condition** parameter. If you don't specify any value for these parameters, the system will transition the business object to the default next status specified in its lifecycle.

C1-HCINPROC

This algorithm is invoked once a health care inbound message is successfully validated. It processes the health care inbound message and creates or updates the parent customers, bill groups (including derivation and pricing parameters for the bill group), accounts, self-funded or fully-insured group policies, policy plans, memberships, member persons, pass-through billable charges, and pricing rules. In addition, it allows you to terminate, reinstate, and renew a fully-insured group policy.

If the person type specified in the health care inbound message matches the person type specified in the **Bill Group Person Type** or **Parent Person Type** option type of the **C1-PERSTYPE** feature configuration, the system creates or updates the person, account, policy, policy plan, and address through a customer registration object. The memberships, pass-through billable charges, and pricing rules are created directly and not via customer registration object. However, if the person type specified in the health care inbound message does not match the person type specified in the **Bill Group Person Type** or **Parent Person Type** option type of the **C1-PERSTYPE** feature configuration, the system creates or updates the person and its other entities directly and not through a customer registration object. In this case, the system only refers the customer registration type for the business objects using which the person, account, policy plan, membership, and address should be created or updated in the system.

If the processing fails due to any reason, the status of the health care inbound message is changed to **Rejected**. In addition, the appropriate log entry is added which you can view in the **Inbound Message Log** zone.

It contains the following parameters:

- **Next Status** - Used when you want to override the default next status specified in the lifecycle.
- **Next Transition Condition** - Used when you want to override the default next transition condition specified in the lifecycle.

Note: At a time, you can specify value for either the **Next Status** or **Next Transition Condition** parameter. If you don't specify any value for these parameters, the system will transition the business object to the default next status specified in its lifecycle.

C1-TODORETRY

This algorithm is invoked when the status of the customer or membership inbound message is changed to **Rejected**. It checks whether the maximum retry attempts are met. If the retry attempt is less than or equal to the value defined in the **Maximum Retry** parameter, the status of the inbound message is changed to **Pending**. However, if the retry attempt is greater than the value defined in the **Maximum Retry** parameter, the status of the inbound message remains as **Rejected**.

Note: This algorithm is invoked when the customer or membership inbound message is validated and processed through the batch process.

It contains the following parameters:

- **Maximum Retry** – Used to specify the maximum number of times the inbound message can be revalidated and reprocessed on failure.
- **Maximum Retry Element Name** – This parameter is not used at the moment.

If you do not specify any value for the **Maximum Retry** parameter, the system uses the value defined in the **To Do Maximum Retries** status option (which is defined in the lifecycle of the **C1-CustomerInboundMessage** and **C1-MemberInboundMessage** business object) to check whether the maximum retry attempts are met. If the value is not specified for the **To Do Maximum Retries** status option, the system does not allow revalidating and reprocessing an inbound message, and the status of the inbound message remains as **Rejected**.

C1-TDCRINMSG

This algorithm is invoked when the status of the customer or membership inbound message is changed to **Rejected**. It creates a To Do using the specified To Do type and assigns it to users with the specified To Do role.

It contains the following parameters:

- **To Do Type** - Used to specify the type of notification that you want to generate when the inbound message validation or processing fails.
- **To Do Role** - Used to specify the To Do role to indicate the users to whom you want to send the notification when the inbound message validation or processing fails.

The rest of the parameters, such as **To Do Type Element Name**, **To Do Role Element Name**, **Message Category**, **Message Number**, **Characteristic Type For Log Entry**, **To Do Sort Keys Retriever Script**, **Discard Cancel Terminate Reason Element**, **Discard Cancel Terminate Reason**, **Retry Frequency**, and **Retry Frequency Element Name**, are not used at the moment.

Health Care Inbound Message XML Format

Note: We recommend you to refer the Health Care Inbound Message schema in parallel while understanding the below mentioned tags. This will help you to understand how the tags are nested in the schema.

Before calling the **C1-HCInboundMessage** inbound web service, you need to ensure that the health care inbound message contains the following tags:

Tag Name	Tag Description	Mandatory (Yes or No)
schema	Used to specify the tags of a health care inbound message.	Yes
bo	Used to indicate the business object using which the health care inbound message should be created in the system. The valid value is: <ul style="list-style-type: none"> • C1-HCInboundMessage 	Yes

Tag Name	Tag Description	Mandatory (Yes or No)												
messageType	<p>You can use this tag within the following tags:</p> <table border="1" data-bbox="493 268 1175 751"> <thead> <tr> <th data-bbox="493 268 716 352">If this tag is used within...</th> <th data-bbox="716 268 1175 352">Then the purpose of the messageType tag is...</th> </tr> </thead> <tbody> <tr> <td data-bbox="493 352 716 604">schema</td> <td data-bbox="716 352 1175 604"> Indicates the health care inbound message type using which the health care inbound message is created in the system. Note: The system refers the value from within the headerData tag. </td> </tr> <tr> <td data-bbox="493 604 716 751">headerData</td> <td data-bbox="716 604 1175 751">Used to specify the health care inbound message type using which the health care inbound message should be created in the system.</td> </tr> </tbody> </table> <p>Note: You must specify a valid health care inbound message type which is in the Active status.</p>	If this tag is used within...	Then the purpose of the messageType tag is...	schema	Indicates the health care inbound message type using which the health care inbound message is created in the system. Note: The system refers the value from within the headerData tag.	headerData	Used to specify the health care inbound message type using which the health care inbound message should be created in the system.	Yes						
If this tag is used within...	Then the purpose of the messageType tag is...													
schema	Indicates the health care inbound message type using which the health care inbound message is created in the system. Note: The system refers the value from within the headerData tag.													
headerData	Used to specify the health care inbound message type using which the health care inbound message should be created in the system.													
sourceSystem	<p>You can use this tag within the following tags:</p> <table border="1" data-bbox="493 945 1175 1675"> <thead> <tr> <th data-bbox="493 945 716 1029">If this tag is used within...</th> <th data-bbox="716 945 1175 1029">Then the purpose of the sourceSystem tag is...</th> </tr> </thead> <tbody> <tr> <td data-bbox="493 1029 716 1255">schema</td> <td data-bbox="716 1029 1175 1255"> Indicates the external system from where the health care inbound message is received. Note: The system refers the value from within the headerData tag. </td> </tr> <tr> <td data-bbox="493 1255 716 1365">headerData</td> <td data-bbox="716 1255 1175 1365">Used to indicate the external system from where the health care inbound message is received.</td> </tr> <tr> <td data-bbox="493 1365 716 1474">billLevelParameters</td> <td data-bbox="716 1365 1175 1474">Used to indicate the source system using which you want to define the derivation and pricing parameters for the bill group.</td> </tr> <tr> <td data-bbox="493 1474 716 1583">memberData</td> <td data-bbox="716 1474 1175 1583">Used to indicate the source system using which you want to derive the policy where the policy plan is defined.</td> </tr> <tr> <td data-bbox="493 1583 716 1675">policyData</td> <td data-bbox="716 1583 1175 1675">Used to indicate the source system from where the policy is originated.</td> </tr> </tbody> </table> <p>Note: You must specify a source system which is already defined in the C1-SourceSystemLookup extendable lookup. It must be in the Active status.</p>	If this tag is used within...	Then the purpose of the sourceSystem tag is...	schema	Indicates the external system from where the health care inbound message is received. Note: The system refers the value from within the headerData tag.	headerData	Used to indicate the external system from where the health care inbound message is received.	billLevelParameters	Used to indicate the source system using which you want to define the derivation and pricing parameters for the bill group.	memberData	Used to indicate the source system using which you want to derive the policy where the policy plan is defined.	policyData	Used to indicate the source system from where the policy is originated.	Yes
If this tag is used within...	Then the purpose of the sourceSystem tag is...													
schema	Indicates the external system from where the health care inbound message is received. Note: The system refers the value from within the headerData tag.													
headerData	Used to indicate the external system from where the health care inbound message is received.													
billLevelParameters	Used to indicate the source system using which you want to define the derivation and pricing parameters for the bill group.													
memberData	Used to indicate the source system using which you want to derive the policy where the policy plan is defined.													
policyData	Used to indicate the source system from where the policy is originated.													

Tag Name	Tag Description	Mandatory (Yes or No)						
externalTransactionId	<p>You can use this tag within the following tags:</p> <table border="1" data-bbox="493 268 1175 688"> <thead> <tr> <th data-bbox="493 268 716 352">If this tag is used within...</th> <th data-bbox="716 268 1175 352">Then the purpose of the externalTransactionId tag is...</th> </tr> </thead> <tbody> <tr> <td data-bbox="493 352 716 573">schema</td> <td data-bbox="716 352 1175 573"> <p>Indicates the transaction in the external source system which resulted in the health care inbound message.</p> <p>Note: The system refers the value from within the headerData tag.</p> </td> </tr> <tr> <td data-bbox="493 573 716 688">headerData</td> <td data-bbox="716 573 1175 688"> <p>Used to indicate the transaction in the external source system which resulted in the health care inbound message.</p> </td> </tr> </tbody> </table>	If this tag is used within...	Then the purpose of the externalTransactionId tag is...	schema	<p>Indicates the transaction in the external source system which resulted in the health care inbound message.</p> <p>Note: The system refers the value from within the headerData tag.</p>	headerData	<p>Used to indicate the transaction in the external source system which resulted in the health care inbound message.</p>	No
If this tag is used within...	Then the purpose of the externalTransactionId tag is...							
schema	<p>Indicates the transaction in the external source system which resulted in the health care inbound message.</p> <p>Note: The system refers the value from within the headerData tag.</p>							
headerData	<p>Used to indicate the transaction in the external source system which resulted in the health care inbound message.</p>							
externalBatchId	<p>You can use this tag within the following tags:</p> <table border="1" data-bbox="493 781 1175 1201"> <thead> <tr> <th data-bbox="493 781 716 865">If this tag is used within...</th> <th data-bbox="716 781 1175 865">Then the purpose of the externalBatchId tag is...</th> </tr> </thead> <tbody> <tr> <td data-bbox="493 865 716 1085">schema</td> <td data-bbox="716 865 1175 1085"> <p>Indicates the external batch job or batch run number through which the health care inbound message is created.</p> <p>Note: The system refers the value from within the headerData tag.</p> </td> </tr> <tr> <td data-bbox="493 1085 716 1201">headerData</td> <td data-bbox="716 1085 1175 1201"> <p>Used to indicate the external batch job or batch run number through which the health care inbound message is created.</p> </td> </tr> </tbody> </table>	If this tag is used within...	Then the purpose of the externalBatchId tag is...	schema	<p>Indicates the external batch job or batch run number through which the health care inbound message is created.</p> <p>Note: The system refers the value from within the headerData tag.</p>	headerData	<p>Used to indicate the external batch job or batch run number through which the health care inbound message is created.</p>	Yes
If this tag is used within...	Then the purpose of the externalBatchId tag is...							
schema	<p>Indicates the external batch job or batch run number through which the health care inbound message is created.</p> <p>Note: The system refers the value from within the headerData tag.</p>							
headerData	<p>Used to indicate the external batch job or batch run number through which the health care inbound message is created.</p>							
externalSourceId	<p>You can use this tag within the following tags:</p> <table border="1" data-bbox="493 1293 1175 1608"> <thead> <tr> <th data-bbox="493 1293 716 1377">If this tag is used within...</th> <th data-bbox="716 1293 1175 1377">Then the purpose of the externalSourceId tag is...</th> </tr> </thead> <tbody> <tr> <td data-bbox="493 1377 716 1535">schema</td> <td data-bbox="716 1377 1175 1535"> <p>Displays the external source system ID.</p> <p>Note: The system refers the value from within the headerData tag.</p> </td> </tr> <tr> <td data-bbox="493 1535 716 1608">headerData</td> <td data-bbox="716 1535 1175 1608"> <p>Used to specify the external source system ID.</p> </td> </tr> </tbody> </table>	If this tag is used within...	Then the purpose of the externalSourceId tag is...	schema	<p>Displays the external source system ID.</p> <p>Note: The system refers the value from within the headerData tag.</p>	headerData	<p>Used to specify the external source system ID.</p>	Yes
If this tag is used within...	Then the purpose of the externalSourceId tag is...							
schema	<p>Displays the external source system ID.</p> <p>Note: The system refers the value from within the headerData tag.</p>							
headerData	<p>Used to specify the external source system ID.</p>							

Tag Name	Tag Description	Mandatory (Yes or No)																				
characteristics	<p>You can use this tag within the following tags:</p> <table border="1" data-bbox="492 268 1174 1094"> <thead> <tr> <th data-bbox="492 268 716 352">If this tag is used within...</th> <th data-bbox="716 268 1174 352">Then the purpose of the characteristics tag is...</th> </tr> </thead> <tbody> <tr> <td data-bbox="492 352 716 436">schema</td> <td data-bbox="716 352 1174 436">Used to specify a list of characteristics for the health care inbound message.</td> </tr> <tr> <td data-bbox="492 436 716 520">personData</td> <td data-bbox="716 436 1174 520">Used to specify a list of characteristics for the person.</td> </tr> <tr> <td data-bbox="492 520 716 604">relatedPersons</td> <td data-bbox="716 520 1174 604">Used to specify a list of characteristics for the person to person relationship.</td> </tr> <tr> <td data-bbox="492 604 716 688">memberData</td> <td data-bbox="716 604 1174 688">Used to specify a list of characteristics for the membership.</td> </tr> <tr> <td data-bbox="492 688 716 772">billableChargeData</td> <td data-bbox="716 688 1174 772">Used to specify a list of characteristics for the billable charge.</td> </tr> <tr> <td data-bbox="492 772 716 856">accountData</td> <td data-bbox="716 772 1174 856">Used to specify a list of characteristics for the account.</td> </tr> <tr> <td data-bbox="492 856 716 940">policyData</td> <td data-bbox="716 856 1174 940">Used to specify a list of characteristics for the policy.</td> </tr> <tr> <td data-bbox="492 940 716 1024">planData</td> <td data-bbox="716 940 1174 1024">Used to specify a list of characteristics for the policy plan.</td> </tr> <tr> <td data-bbox="492 1024 716 1094">pricingRuleData</td> <td data-bbox="716 1024 1174 1094">Used to specify a list of characteristics for the pricing rule.</td> </tr> </tbody> </table>	If this tag is used within...	Then the purpose of the characteristics tag is...	schema	Used to specify a list of characteristics for the health care inbound message.	personData	Used to specify a list of characteristics for the person.	relatedPersons	Used to specify a list of characteristics for the person to person relationship.	memberData	Used to specify a list of characteristics for the membership.	billableChargeData	Used to specify a list of characteristics for the billable charge.	accountData	Used to specify a list of characteristics for the account.	policyData	Used to specify a list of characteristics for the policy.	planData	Used to specify a list of characteristics for the policy plan.	pricingRuleData	Used to specify a list of characteristics for the pricing rule.	No
If this tag is used within...	Then the purpose of the characteristics tag is...																					
schema	Used to specify a list of characteristics for the health care inbound message.																					
personData	Used to specify a list of characteristics for the person.																					
relatedPersons	Used to specify a list of characteristics for the person to person relationship.																					
memberData	Used to specify a list of characteristics for the membership.																					
billableChargeData	Used to specify a list of characteristics for the billable charge.																					
accountData	Used to specify a list of characteristics for the account.																					
policyData	Used to specify a list of characteristics for the policy.																					
planData	Used to specify a list of characteristics for the policy plan.																					
pricingRuleData	Used to specify a list of characteristics for the pricing rule.																					
inboundMessageCharacteristic	Used to specify a characteristic for the health care inbound message.	No																				
adhocCharacteristicValue	Used to specify the value for the adhoc characteristic type.	Yes (Conditional) <table border="1" data-bbox="1190 1255 1471 1465"> <tr> <td data-bbox="1190 1255 1471 1465"> Note: This data is required while defining or editing an adhoc characteristic of the health care inbound message. </td> </tr> </table>	Note: This data is required while defining or editing an adhoc characteristic of the health care inbound message.																			
Note: This data is required while defining or editing an adhoc characteristic of the health care inbound message.																						

Tag Name	Tag Description	Mandatory (Yes or No)						
characteristicType	You can use this tag within the following tags:	Yes (Conditional)						
	<table border="1"> <thead> <tr> <th data-bbox="492 275 712 346">If this tag is used within...</th> <th data-bbox="712 275 1177 346">Then the purpose of the characteristicType tag is...</th> </tr> </thead> <tbody> <tr> <td data-bbox="492 352 712 499">inboundMessageCharacteristics</td> <td data-bbox="712 352 1177 499">Used to specify the characteristic type. Here, you must specify a characteristic type where the characteristic entity is set to Inbound Message.</td> </tr> <tr> <td data-bbox="492 499 712 1312">characteristicsList</td> <td data-bbox="712 499 1177 1312">Used to specify the characteristic type. If you are defining a characteristic for a: <ul style="list-style-type: none"> • Person - You must specify a characteristic type where the characteristic entity is set to Person. • Related Person - You must specify a characteristic type where the characteristic entity is set to Person to Person. • Membership - You must specify a characteristic type where the characteristic entity is set to Membership. • Membership Person - You must specify a characteristic type where the characteristic entity is set to Membership Person. • Benefit - You must specify a characteristic type where the characteristic entity is set to Benefit. </td> </tr> </tbody> </table>	If this tag is used within...	Then the purpose of the characteristicType tag is...	inboundMessageCharacteristics	Used to specify the characteristic type. Here, you must specify a characteristic type where the characteristic entity is set to Inbound Message .	characteristicsList	Used to specify the characteristic type. If you are defining a characteristic for a: <ul style="list-style-type: none"> • Person - You must specify a characteristic type where the characteristic entity is set to Person. • Related Person - You must specify a characteristic type where the characteristic entity is set to Person to Person. • Membership - You must specify a characteristic type where the characteristic entity is set to Membership. • Membership Person - You must specify a characteristic type where the characteristic entity is set to Membership Person. • Benefit - You must specify a characteristic type where the characteristic entity is set to Benefit. 	<p>Note: This data is required while defining or editing a characteristic of the respective entity.</p>
	If this tag is used within...	Then the purpose of the characteristicType tag is...						
inboundMessageCharacteristics	Used to specify the characteristic type. Here, you must specify a characteristic type where the characteristic entity is set to Inbound Message .							
characteristicsList	Used to specify the characteristic type. If you are defining a characteristic for a: <ul style="list-style-type: none"> • Person - You must specify a characteristic type where the characteristic entity is set to Person. • Related Person - You must specify a characteristic type where the characteristic entity is set to Person to Person. • Membership - You must specify a characteristic type where the characteristic entity is set to Membership. • Membership Person - You must specify a characteristic type where the characteristic entity is set to Membership Person. • Benefit - You must specify a characteristic type where the characteristic entity is set to Benefit. 							

Tag Name	Tag Description	Mandatory (Yes or No)										
	<table border="1"> <thead> <tr> <th data-bbox="492 226 716 302">If this tag is used within...</th> <th data-bbox="716 226 1174 302">Then the purpose of the characteristicType tag is...</th> </tr> </thead> <tbody> <tr> <td data-bbox="492 302 716 1039"></td> <td data-bbox="716 302 1174 1039"> <ul style="list-style-type: none"> • Billable Charge - You must specify a characteristic type where the characteristic entity is set to Billable Charge. • Account - You must specify a characteristic type where the characteristic entity is set to Account. • Policy - You must specify a characteristic type where the characteristic entity is set to Policy. • Policy Plan - You must specify a characteristic type where the characteristic entity is set to Policy Plan. • Pricing Rule - You must specify a characteristic type where the characteristic entity is set to Pricing Rule. </td> </tr> </tbody> </table>	If this tag is used within...	Then the purpose of the characteristicType tag is...		<ul style="list-style-type: none"> • Billable Charge - You must specify a characteristic type where the characteristic entity is set to Billable Charge. • Account - You must specify a characteristic type where the characteristic entity is set to Account. • Policy - You must specify a characteristic type where the characteristic entity is set to Policy. • Policy Plan - You must specify a characteristic type where the characteristic entity is set to Policy Plan. • Pricing Rule - You must specify a characteristic type where the characteristic entity is set to Pricing Rule. 							
If this tag is used within...	Then the purpose of the characteristicType tag is...											
	<ul style="list-style-type: none"> • Billable Charge - You must specify a characteristic type where the characteristic entity is set to Billable Charge. • Account - You must specify a characteristic type where the characteristic entity is set to Account. • Policy - You must specify a characteristic type where the characteristic entity is set to Policy. • Policy Plan - You must specify a characteristic type where the characteristic entity is set to Policy Plan. • Pricing Rule - You must specify a characteristic type where the characteristic entity is set to Pricing Rule. 											
effectiveDate	<p>You can use this tag within the following tags:</p> <table border="1"> <thead> <tr> <th data-bbox="492 1136 716 1211">If this tag is used within...</th> <th data-bbox="716 1136 1174 1211">Then the purpose of the effectiveDate tag is...</th> </tr> </thead> <tbody> <tr> <td data-bbox="492 1211 716 1329">inboundMessageCharacteristics</td> <td data-bbox="716 1211 1174 1329">Used to specify the date from when the characteristic is effective for the health care inbound message.</td> </tr> <tr> <td data-bbox="492 1329 716 1572">characteristicsList</td> <td data-bbox="716 1329 1174 1572">Used to specify the date from when the characteristic is effective for the respective entity (i.e. person, person to person relationship, membership, member person, billable charge, account, policy, policy plan, pricing rule, or benefit).</td> </tr> <tr> <td data-bbox="492 1572 716 1690">billLevelParameters</td> <td data-bbox="716 1572 1174 1690">Used to specify the date from when the derivation and pricing parameters are effective for the bill group.</td> </tr> <tr> <td data-bbox="492 1690 716 1766">policyPlanProrationRulesList</td> <td data-bbox="716 1690 1174 1766">Used to specify the proration rules defined for the policy plan.</td> </tr> </tbody> </table> <p>Note: You must specify the date in the YYYY-MM-DD format.</p>	If this tag is used within...	Then the purpose of the effectiveDate tag is...	inboundMessageCharacteristics	Used to specify the date from when the characteristic is effective for the health care inbound message.	characteristicsList	Used to specify the date from when the characteristic is effective for the respective entity (i.e. person, person to person relationship, membership, member person, billable charge, account, policy, policy plan, pricing rule, or benefit).	billLevelParameters	Used to specify the date from when the derivation and pricing parameters are effective for the bill group.	policyPlanProrationRulesList	Used to specify the proration rules defined for the policy plan.	<p>Yes (Conditional)</p> <p>Note: This data is required while defining or editing a characteristic of the respective entity or while defining the derivation and pricing parameters for the bill group.</p>
If this tag is used within...	Then the purpose of the effectiveDate tag is...											
inboundMessageCharacteristics	Used to specify the date from when the characteristic is effective for the health care inbound message.											
characteristicsList	Used to specify the date from when the characteristic is effective for the respective entity (i.e. person, person to person relationship, membership, member person, billable charge, account, policy, policy plan, pricing rule, or benefit).											
billLevelParameters	Used to specify the date from when the derivation and pricing parameters are effective for the bill group.											
policyPlanProrationRulesList	Used to specify the proration rules defined for the policy plan.											

Tag Name	Tag Description	Mandatory (Yes or No)						
characteristicValue	You can use this tag within the following tags:	Yes (Conditional)						
	<table border="1"> <thead> <tr> <th>If this tag is used within...</th> <th>Then the purpose of the characteristicValue tag is...</th> </tr> </thead> <tbody> <tr> <td>inboundMessageCharacteristic</td> <td>Used to specify the value for the predefined characteristic type.</td> </tr> <tr> <td>characteristicsList</td> <td>Used to specify the value for the characteristic type.</td> </tr> </tbody> </table>	If this tag is used within...	Then the purpose of the characteristicValue tag is...	inboundMessageCharacteristic	Used to specify the value for the predefined characteristic type.	characteristicsList	Used to specify the value for the characteristic type.	Note: This data is required while defining or editing a characteristic of the respective entity.
	If this tag is used within...	Then the purpose of the characteristicValue tag is...						
inboundMessageCharacteristic	Used to specify the value for the predefined characteristic type.							
characteristicsList	Used to specify the value for the characteristic type.							
customerStructureMessage	Used to specify the details of the customer including the header information for the health care inbound message.	Yes						
characteristicValueForeignKey	Used to specify the first value for the foreign key characteristic type.	Yes (Conditional)						
		Note: This data is required while defining or editing a foreign key characteristic of the health care inbound message.						
characteristicValueFK2	Used to specify the second value for the foreign key characteristic type.	No						
characteristicValueFK3	Used to specify the third value for the foreign key characteristic type.	No						
characteristicValueFK4	Used to specify the fourth value for the foreign key characteristic type.	No						
characteristicValueFK5	Used to specify the fifth value for the foreign key characteristic type.	No						
headerData	Used to specify the header information for the health care inbound message.	Yes						
personData	Used to specify the details of the parent customer, bill group, or member person.	Yes (Conditional)						
		Note: This data is required while defining or editing a person.						

Tag Name	Tag Description	Mandatory (Yes or No)																		
sequence	<p>You can use this tag within the following tags:</p> <table border="1" data-bbox="492 268 1175 1234"> <thead> <tr> <th data-bbox="492 268 716 352">If this tag is used within...</th> <th data-bbox="716 268 1175 352">Then the purpose of the sequence tag is...</th> </tr> </thead> <tbody> <tr> <td data-bbox="492 352 716 436">personData</td> <td data-bbox="716 352 1175 436">Used to indicate the order in which the person should be created in the system.</td> </tr> <tr> <td data-bbox="492 436 716 552">personName</td> <td data-bbox="716 436 1175 552">Used to indicate the order in which the person name should be displayed in the user interface.</td> </tr> <tr> <td data-bbox="492 552 716 667">billLevelParameters</td> <td data-bbox="716 552 1175 667">Used to indicate the order in which the derivation and pricing parameters should be created for the bill group.</td> </tr> <tr> <td data-bbox="492 667 716 783">billableChargeData</td> <td data-bbox="716 667 1175 783">Used to indicate the order in which the billable charge should be created for the membership.</td> </tr> <tr> <td data-bbox="492 783 716 898">baseRate</td> <td data-bbox="716 783 1175 898">Used to indicate the order in which the price component should be created using the given base rate information.</td> </tr> <tr> <td data-bbox="492 898 716 1014">pricingParameter</td> <td data-bbox="716 898 1175 1014">Used to indicate the order in which the pricing eligibility criteria should be created using the parameter information.</td> </tr> <tr> <td data-bbox="492 1014 716 1129">modifierInformation</td> <td data-bbox="716 1014 1175 1129">Used to indicate the order in which the pricing eligibility criteria should be created using the modifier information.</td> </tr> <tr> <td data-bbox="492 1129 716 1234">benefitDataList</td> <td data-bbox="716 1129 1175 1234">Used to indicate the order in which the benefit charge should be created for the membership.</td> </tr> </tbody> </table>	If this tag is used within...	Then the purpose of the sequence tag is...	personData	Used to indicate the order in which the person should be created in the system.	personName	Used to indicate the order in which the person name should be displayed in the user interface.	billLevelParameters	Used to indicate the order in which the derivation and pricing parameters should be created for the bill group.	billableChargeData	Used to indicate the order in which the billable charge should be created for the membership.	baseRate	Used to indicate the order in which the price component should be created using the given base rate information.	pricingParameter	Used to indicate the order in which the pricing eligibility criteria should be created using the parameter information.	modifierInformation	Used to indicate the order in which the pricing eligibility criteria should be created using the modifier information.	benefitDataList	Used to indicate the order in which the benefit charge should be created for the membership.	<p>Yes (Conditional)</p> <p>Note: This data is required while defining or editing the respective information.</p>
If this tag is used within...	Then the purpose of the sequence tag is...																			
personData	Used to indicate the order in which the person should be created in the system.																			
personName	Used to indicate the order in which the person name should be displayed in the user interface.																			
billLevelParameters	Used to indicate the order in which the derivation and pricing parameters should be created for the bill group.																			
billableChargeData	Used to indicate the order in which the billable charge should be created for the membership.																			
baseRate	Used to indicate the order in which the price component should be created using the given base rate information.																			
pricingParameter	Used to indicate the order in which the pricing eligibility criteria should be created using the parameter information.																			
modifierInformation	Used to indicate the order in which the pricing eligibility criteria should be created using the modifier information.																			
benefitDataList	Used to indicate the order in which the benefit charge should be created for the membership.																			
personType	<p>Used to indicate the type of person. The valid values are:</p> <ul style="list-style-type: none"> • B - Indicates that the person is a business owner. • BG - Indicates that the person is a bill group. • G - Indicates that the person is a group owner. • K - Indicates that the person is a broker. • P - Indicates that the person is an individual. • PG - Indicates that the person is a parent customer. <p>Note: You must specify a value which is already defined in the PER_OR_BUS_FLG lookup field. It must be in the Active status.</p>	<p>Yes (Conditional)</p> <p>Note: This data is required while defining or editing a person.</p>																		
personName	Used to specify a list of names for the person.	<p>Yes (Conditional)</p> <p>Note: This data is required while defining a person.</p>																		

Tag Name	Tag Description	Mandatory (Yes or No)												
entityName	Used to specify the name of the person.	Yes (Conditional) Note: This data is required while defining a person.												
nameType	Used to indicate the type of name. Note: You must specify a value which is already defined in the NAME_TYPE_FLG lookup field. It must be in the Active status.	Yes (Conditional) Note: This data is required while defining a person.												
identifiers	You can use this tag within the following tags: <table border="1"> <thead> <tr> <th>If this tag is used within...</th> <th>Then the purpose of the identifiers tag is...</th> </tr> </thead> <tbody> <tr> <td>personData</td> <td>Used to specify the identification details for the person.</td> </tr> <tr> <td>accountData</td> <td>Used to specify the identification details for the account.</td> </tr> </tbody> </table> Note: You must specify one primary identifier for a person and account.	If this tag is used within...	Then the purpose of the identifiers tag is...	personData	Used to specify the identification details for the person.	accountData	Used to specify the identification details for the account.	Yes (Conditional) Note: This data is required while defining or editing the respective information.						
If this tag is used within...	Then the purpose of the identifiers tag is...													
personData	Used to specify the identification details for the person.													
accountData	Used to specify the identification details for the account.													
idType	You can use this tag within the following tags: <table border="1"> <thead> <tr> <th>If this tag is used within...</th> <th>Then the purpose of the idType tag is...</th> </tr> </thead> <tbody> <tr> <td>identifiers</td> <td>Used to specify the person or account identifier type.</td> </tr> <tr> <td>relatedPersons</td> <td>Used to specify the person identifier type.</td> </tr> <tr> <td>mainSubscriber</td> <td>Used to specify the person identifier type.</td> </tr> <tr> <td>accountPerson</td> <td>Used to specify the person identifier type.</td> </tr> <tr> <td>policyPersons</td> <td>Used to specify the person identifier type.</td> </tr> </tbody> </table> Note: You must specify a person or account identifier type which is already defined in the system.	If this tag is used within...	Then the purpose of the idType tag is...	identifiers	Used to specify the person or account identifier type.	relatedPersons	Used to specify the person identifier type.	mainSubscriber	Used to specify the person identifier type.	accountPerson	Used to specify the person identifier type.	policyPersons	Used to specify the person identifier type.	Yes (Conditional) Note: This data is required in the following scenarios: <ul style="list-style-type: none"> • While defining or editing the identification details of a person and account. • While defining or editing a person to person relationship. • While defining or editing the membership information of a person. • While linking an account to another person. • While associating a person with a policy.
If this tag is used within...	Then the purpose of the idType tag is...													
identifiers	Used to specify the person or account identifier type.													
relatedPersons	Used to specify the person identifier type.													
mainSubscriber	Used to specify the person identifier type.													
accountPerson	Used to specify the person identifier type.													
policyPersons	Used to specify the person identifier type.													

Tag Name	Tag Description	Mandatory (Yes or No)												
idValue	You can use this tag within the following tags:	Yes (Conditional)												
	<table border="1"> <thead> <tr> <th>If this tag is used within...</th> <th>Then the purpose of the idValue tag is...</th> </tr> </thead> <tbody> <tr> <td>identifiers</td> <td>Used to specify the person or account identifier.</td> </tr> <tr> <td>relatedPersons</td> <td>Used to indicate the person with whom you want to establish the person to person relationship.</td> </tr> <tr> <td>mainSubscriber</td> <td>Used to indicate the person who is the main subscriber of the membership.</td> </tr> <tr> <td>accountPerson</td> <td>Used to indicate the person to whom you want to link the account.</td> </tr> <tr> <td>policyPersons</td> <td>Used to indicate the person to whom you want to associate the policy.</td> </tr> </tbody> </table>	If this tag is used within...	Then the purpose of the idValue tag is...	identifiers	Used to specify the person or account identifier.	relatedPersons	Used to indicate the person with whom you want to establish the person to person relationship.	mainSubscriber	Used to indicate the person who is the main subscriber of the membership.	accountPerson	Used to indicate the person to whom you want to link the account.	policyPersons	Used to indicate the person to whom you want to associate the policy.	Note: This data is required while defining or editing the respective information.
	If this tag is used within...	Then the purpose of the idValue tag is...												
	identifiers	Used to specify the person or account identifier.												
	relatedPersons	Used to indicate the person with whom you want to establish the person to person relationship.												
	mainSubscriber	Used to indicate the person who is the main subscriber of the membership.												
	accountPerson	Used to indicate the person to whom you want to link the account.												
policyPersons	Used to indicate the person to whom you want to associate the policy.													
isPrimary	<p>Used to indicate whether the person or account identifier is a primary identifier. The valid values are:</p> <ul style="list-style-type: none"> • Y • N <p>Note: If you do not specify the value, by default, it is set to N.</p>	No												
division	You can use this tag within the following tags:	No												
	<table border="1"> <thead> <tr> <th>If this tag is used within...</th> <th>Then the purpose of the division tag is...</th> </tr> </thead> <tbody> <tr> <td>personData</td> <td>Used to indicate the division to which the person belongs.</td> </tr> <tr> <td>accountData</td> <td>Used to indicate the division to which the account belongs.</td> </tr> <tr> <td>statementConstructDetails</td> <td>Used to indicate the division to which the statement construct belongs.</td> </tr> </tbody> </table>		If this tag is used within...	Then the purpose of the division tag is...	personData	Used to indicate the division to which the person belongs.	accountData	Used to indicate the division to which the account belongs.	statementConstructDetails	Used to indicate the division to which the statement construct belongs.				
	If this tag is used within...		Then the purpose of the division tag is...											
	personData		Used to indicate the division to which the person belongs.											
accountData	Used to indicate the division to which the account belongs.													
statementConstructDetails	Used to indicate the division to which the statement construct belongs.													
Note: You must specify a division which is already defined in the system.														
birthDate	<p>Used to specify the date when the person was born.</p> <p>Note: You must specify the date in the YYYY-MM-DD format.</p>	No												
sinceDate	<p>Used to specify the date when the person's record is created in the system. This is purely informational.</p> <p>Note: You must specify the date in the YYYY-MM-DD format.</p>	No												

Tag Name	Tag Description	Mandatory (Yes or No)						
address	You can use this tag within the following tags:	Yes (Conditional)						
	<table border="1"> <thead> <tr> <th>If this tag is used within...</th> <th>Then the purpose of the address tag is...</th> </tr> </thead> <tbody> <tr> <td>personData</td> <td>Used to specify the address of the person.</td> </tr> <tr> <td>accountData</td> <td>Used to specify the address of the account.</td> </tr> </tbody> </table>	If this tag is used within...	Then the purpose of the address tag is...	personData	Used to specify the address of the person.	accountData	Used to specify the address of the account.	Note: This data is required while defining or editing the address of the respective entity.
	If this tag is used within...	Then the purpose of the address tag is...						
personData	Used to specify the address of the person.							
accountData	Used to specify the address of the account.							
addressEffDate	Used to specify the date from when the address is effective.	Yes (Conditional)						
	<p>Note:</p> <p>You must specify the date in the YYYY-MM-DD format.</p> <p>If you do not specify the date, by default, the system sets the effective date to the date when the address is created in the system through the health care inbound message.</p>	Note: This data is required while editing the address of a person or account.						
addressType	Used to indicate the type of address. The valid values are:	Yes (Conditional)						
	<ul style="list-style-type: none"> • MAIN - Indicates that the address is the person's mailing address. You can use this address type while specifying the address for the person and account. • SEAS - Indicates that the address is the person's seasonal address. You can use this address type while specifying the address for the person. • OVRD - Indicates that the address is the account's override address. You can use this address type while specifying the address for the account. <p>Note:</p> <p>If you do not specify the address type, by default, it is set to MAIN.</p> <p>You must specify an address type which is already defined in the ADDRESS_TYPE_FLG lookup field. It must be in the Active status.</p>	Note: This data is required while editing the address of a person or account.						
mailingName	Used to specify the name using which the person should be addressed in the mail communication. The system also uses the mailing name in the bills, letters, quotes, and statements.	No						

Tag Name	Tag Description	Mandatory (Yes or No)						
address1	<p>You can use this tag within the following tags:</p> <table border="1" data-bbox="492 268 1175 581"> <thead> <tr> <th data-bbox="492 268 711 352">If this tag is used within...</th> <th data-bbox="711 268 1175 352">Then the purpose of the address1 tag is...</th> </tr> </thead> <tbody> <tr> <td data-bbox="492 352 711 468">address</td> <td data-bbox="711 352 1175 468">Used to specify the first line of the address. It may contain details, such as the house number.</td> </tr> <tr> <td data-bbox="492 468 711 581">personAddressOverride</td> <td data-bbox="711 468 1175 581">Used to specify the first line of the address. It may contain details, such as the house number.</td> </tr> </tbody> </table>	If this tag is used within...	Then the purpose of the address1 tag is...	address	Used to specify the first line of the address. It may contain details, such as the house number.	personAddressOverride	Used to specify the first line of the address. It may contain details, such as the house number.	<p>Yes (Conditional)</p> <p>Note: This data is required while defining and editing the address of a person and account.</p>
If this tag is used within...	Then the purpose of the address1 tag is...							
address	Used to specify the first line of the address. It may contain details, such as the house number.							
personAddressOverride	Used to specify the first line of the address. It may contain details, such as the house number.							
address2	<p>You can use this tag within the following tags:</p> <table border="1" data-bbox="492 672 1175 984"> <thead> <tr> <th data-bbox="492 672 711 756">If this tag is used within...</th> <th data-bbox="711 672 1175 756">Then the purpose of the address2 tag is...</th> </tr> </thead> <tbody> <tr> <td data-bbox="492 756 711 871">address</td> <td data-bbox="711 756 1175 871">Used to specify the second line of the address. It may contain details, such as the apartment name.</td> </tr> <tr> <td data-bbox="492 871 711 984">personAddressOverride</td> <td data-bbox="711 871 1175 984">Used to specify the second line of the address. It may contain details, such as the apartment name.</td> </tr> </tbody> </table>	If this tag is used within...	Then the purpose of the address2 tag is...	address	Used to specify the second line of the address. It may contain details, such as the apartment name.	personAddressOverride	Used to specify the second line of the address. It may contain details, such as the apartment name.	No
If this tag is used within...	Then the purpose of the address2 tag is...							
address	Used to specify the second line of the address. It may contain details, such as the apartment name.							
personAddressOverride	Used to specify the second line of the address. It may contain details, such as the apartment name.							
address3	<p>You can use this tag within the following tags:</p> <table border="1" data-bbox="492 1075 1175 1388"> <thead> <tr> <th data-bbox="492 1075 711 1159">If this tag is used within...</th> <th data-bbox="711 1075 1175 1159">Then the purpose of the address3 tag is...</th> </tr> </thead> <tbody> <tr> <td data-bbox="492 1159 711 1274">address</td> <td data-bbox="711 1159 1175 1274">Used to specify the third line of the address. It may contain details, such as the street name.</td> </tr> <tr> <td data-bbox="492 1274 711 1388">personAddressOverride</td> <td data-bbox="711 1274 1175 1388">Used to specify the third line of the address. It may contain details, such as the street name.</td> </tr> </tbody> </table>	If this tag is used within...	Then the purpose of the address3 tag is...	address	Used to specify the third line of the address. It may contain details, such as the street name.	personAddressOverride	Used to specify the third line of the address. It may contain details, such as the street name.	No
If this tag is used within...	Then the purpose of the address3 tag is...							
address	Used to specify the third line of the address. It may contain details, such as the street name.							
personAddressOverride	Used to specify the third line of the address. It may contain details, such as the street name.							
address4	<p>You can use this tag within the following tags:</p> <table border="1" data-bbox="492 1478 1175 1791"> <thead> <tr> <th data-bbox="492 1478 711 1562">If this tag is used within...</th> <th data-bbox="711 1478 1175 1562">Then the purpose of the address4 tag is...</th> </tr> </thead> <tbody> <tr> <td data-bbox="492 1562 711 1677">address</td> <td data-bbox="711 1562 1175 1677">Used to specify the fourth line of the address. It may contain the landmark details.</td> </tr> <tr> <td data-bbox="492 1677 711 1791">personAddressOverride</td> <td data-bbox="711 1677 1175 1791">Used to specify the fourth line of the address. It may contain the landmark details.</td> </tr> </tbody> </table>	If this tag is used within...	Then the purpose of the address4 tag is...	address	Used to specify the fourth line of the address. It may contain the landmark details.	personAddressOverride	Used to specify the fourth line of the address. It may contain the landmark details.	No
If this tag is used within...	Then the purpose of the address4 tag is...							
address	Used to specify the fourth line of the address. It may contain the landmark details.							
personAddressOverride	Used to specify the fourth line of the address. It may contain the landmark details.							

Tag Name	Tag Description	Mandatory (Yes or No)						
city	<p>You can use this tag within the following tags:</p> <table border="1"> <thead> <tr> <th>If this tag is used within...</th> <th>Then the purpose of the city tag is...</th> </tr> </thead> <tbody> <tr> <td>address</td> <td>Used to specify the city name.</td> </tr> <tr> <td>personAddressOverride</td> <td>Used to specify the city name.</td> </tr> </tbody> </table>	If this tag is used within...	Then the purpose of the city tag is...	address	Used to specify the city name.	personAddressOverride	Used to specify the city name.	No
If this tag is used within...	Then the purpose of the city tag is...							
address	Used to specify the city name.							
personAddressOverride	Used to specify the city name.							
state	<p>You can use this tag within the following tags:</p> <table border="1"> <thead> <tr> <th>If this tag is used within...</th> <th>Then the purpose of the state tag is...</th> </tr> </thead> <tbody> <tr> <td>address</td> <td>Used to indicate the state where the city is located.</td> </tr> <tr> <td>personAddressOverride</td> <td>Used to indicate the state where the city is located.</td> </tr> </tbody> </table>	If this tag is used within...	Then the purpose of the state tag is...	address	Used to indicate the state where the city is located.	personAddressOverride	Used to indicate the state where the city is located.	No
If this tag is used within...	Then the purpose of the state tag is...							
address	Used to indicate the state where the city is located.							
personAddressOverride	Used to indicate the state where the city is located.							
zip	Used to specify the zip code of the address.	No						
country	<p>You can use this tag within the following tags:</p> <table border="1"> <thead> <tr> <th>If this tag is used within...</th> <th>Then the purpose of the country tag is...</th> </tr> </thead> <tbody> <tr> <td>address</td> <td>Used to indicate the country where the person or account is located.</td> </tr> <tr> <td>personAddressOverride</td> <td>Used to indicate the country where the person is located.</td> </tr> </tbody> </table>	If this tag is used within...	Then the purpose of the country tag is...	address	Used to indicate the country where the person or account is located.	personAddressOverride	Used to indicate the country where the person is located.	Yes (Conditional) Note: This data is required while defining or editing the address of a person or account.
If this tag is used within...	Then the purpose of the country tag is...							
address	Used to indicate the country where the person or account is located.							
personAddressOverride	Used to indicate the country where the person is located.							
houseType	<p>You can use this tag within the following tags:</p> <table border="1"> <thead> <tr> <th>If this tag is used within...</th> <th>Then the purpose of the houseType tag is...</th> </tr> </thead> <tbody> <tr> <td>address</td> <td>Used to indicate the type of the house.</td> </tr> <tr> <td>personAddressOverride</td> <td>Used to indicate the type of the house.</td> </tr> </tbody> </table> <p>You must specify a house type which is already defined in the HOUSE_TYPE lookup field. It must be in the Active status.</p>	If this tag is used within...	Then the purpose of the houseType tag is...	address	Used to indicate the type of the house.	personAddressOverride	Used to indicate the type of the house.	No
If this tag is used within...	Then the purpose of the houseType tag is...							
address	Used to indicate the type of the house.							
personAddressOverride	Used to indicate the type of the house.							
streetNumber1	<p>You can use this tag within the following tags:</p> <table border="1"> <thead> <tr> <th>If this tag is used within...</th> <th>Then the purpose of the streetNumber1 tag is...</th> </tr> </thead> <tbody> <tr> <td>address</td> <td>Used to specify the numeric information, if any, related to the address.</td> </tr> <tr> <td>personAddressOverride</td> <td>Used to specify the numeric information, if any, related to the address.</td> </tr> </tbody> </table>	If this tag is used within...	Then the purpose of the streetNumber1 tag is...	address	Used to specify the numeric information, if any, related to the address.	personAddressOverride	Used to specify the numeric information, if any, related to the address.	No
If this tag is used within...	Then the purpose of the streetNumber1 tag is...							
address	Used to specify the numeric information, if any, related to the address.							
personAddressOverride	Used to specify the numeric information, if any, related to the address.							

Tag Name	Tag Description	Mandatory (Yes or No)						
streetNumber2	<p>You can use this tag within the following tags:</p> <table border="1"> <thead> <tr> <th>If this tag is used within...</th> <th>Then the purpose of the streetNumber2 tag is...</th> </tr> </thead> <tbody> <tr> <td>address</td> <td>Used to specify the numeric information, if any, related to the address.</td> </tr> <tr> <td>personAddressOverride</td> <td>Used to specify the numeric information, if any, related to the address.</td> </tr> </tbody> </table>	If this tag is used within...	Then the purpose of the streetNumber2 tag is...	address	Used to specify the numeric information, if any, related to the address.	personAddressOverride	Used to specify the numeric information, if any, related to the address.	No
If this tag is used within...	Then the purpose of the streetNumber2 tag is...							
address	Used to specify the numeric information, if any, related to the address.							
personAddressOverride	Used to specify the numeric information, if any, related to the address.							
inCityLimit	<p>You can use this tag within the following tags:</p> <table border="1"> <thead> <tr> <th>If this tag is used within...</th> <th>Then the purpose of the inCityLimit tag is...</th> </tr> </thead> <tbody> <tr> <td>address</td> <td>Used to indicate whether the address is within the city limit. The valid values are: <ul style="list-style-type: none"> • Y • N </td> </tr> <tr> <td>personAddressOverride</td> <td>Used to indicate whether the address is within the city limit. The valid values are: <ul style="list-style-type: none"> • Y • N </td> </tr> </tbody> </table>	If this tag is used within...	Then the purpose of the inCityLimit tag is...	address	Used to indicate whether the address is within the city limit. The valid values are: <ul style="list-style-type: none"> • Y • N 	personAddressOverride	Used to indicate whether the address is within the city limit. The valid values are: <ul style="list-style-type: none"> • Y • N 	No
If this tag is used within...	Then the purpose of the inCityLimit tag is...							
address	Used to indicate whether the address is within the city limit. The valid values are: <ul style="list-style-type: none"> • Y • N 							
personAddressOverride	Used to indicate whether the address is within the city limit. The valid values are: <ul style="list-style-type: none"> • Y • N 							
taxVendorGeographicalCode	<p>You can use this tag within the following tags:</p> <table border="1"> <thead> <tr> <th>If this tag is used within...</th> <th>Then the purpose of the taxVendorGeographicalCode tag is...</th> </tr> </thead> <tbody> <tr> <td>address</td> <td>Used to specify the geographic code of the address.</td> </tr> <tr> <td>personAddressOverride</td> <td>Used to specify the geographic code of the address.</td> </tr> </tbody> </table>	If this tag is used within...	Then the purpose of the taxVendorGeographicalCode tag is...	address	Used to specify the geographic code of the address.	personAddressOverride	Used to specify the geographic code of the address.	No
If this tag is used within...	Then the purpose of the taxVendorGeographicalCode tag is...							
address	Used to specify the geographic code of the address.							
personAddressOverride	Used to specify the geographic code of the address.							
county	<p>You can use this tag within the following tags:</p> <table border="1"> <thead> <tr> <th>If this tag is used within...</th> <th>Then the purpose of the county tag is...</th> </tr> </thead> <tbody> <tr> <td>address</td> <td>Used to specify the county name.</td> </tr> <tr> <td>personAddressOverride</td> <td>Used to specify the county name.</td> </tr> </tbody> </table>	If this tag is used within...	Then the purpose of the county tag is...	address	Used to specify the county name.	personAddressOverride	Used to specify the county name.	No
If this tag is used within...	Then the purpose of the county tag is...							
address	Used to specify the county name.							
personAddressOverride	Used to specify the county name.							
email	Used to specify the e-mail ID of the person.	No						
overrideMailingName1	Used to specify the name using which you want to override the person's mailing name.	No						
overrideMailingName2	Used to specify the name using which you want to override the person's override mailing name 1.	No						

Tag Name	Tag Description	Mandatory (Yes or No)
overrideMailingName3	Used to specify the name using which you want to override the person's override mailing name 2.	No
phones	Used to specify the phone details of the person.	Yes (Conditional) Note: This data is required while defining or editing the phone details of a person.
phoneType	Used to indicate the type of phone. Note: You must specify a phone type which is already defined in the system.	Yes (Conditional) Note: This data is required while defining or editing the phone details of a person.
phoneValue	Used to specify the phone number of the person.	Yes (Conditional) Note: This data is required while defining or editing the phone details of a person.
extension	Used to specify the extension value of the phone number.	Yes (Conditional) Note: This field is required when you are adding the phone details of a person.
relatedPersons	Used to list other persons with whom you want to establish the person's relationship.	Yes (Conditional) Note: This data is required while defining or editing a person to person relationship.
personRelationshipType	Used to indicate how the other person is related to the person. Note: You must specify a person relationship type which is already defined in the system. If you have specified a parent customer as the related person for a bill group, the system, by default, uses the person relationship type which is specified in the Person Relationship Type option type of the C1-ASOBLNG feature configuration. It does not consider the value specified in this tag.	Yes (Conditional) Note: This data is required while creating relationship between a bill group and person whose the person type is not Parent Customer .

Tag Name	Tag Description	Mandatory (Yes or No)																						
startDate	<p>You can use this tag within the following tags:</p> <table border="1" data-bbox="493 268 1175 1178"> <thead> <tr> <th data-bbox="493 268 711 352">If this tag is used within...</th> <th data-bbox="711 268 1175 352">Then the purpose of the startDate tag is...</th> </tr> </thead> <tbody> <tr> <td data-bbox="493 352 711 436">relatedPersons</td> <td data-bbox="711 352 1175 436">Used to specify the date from when the other person is related to the person.</td> </tr> <tr> <td data-bbox="493 436 711 520">memberData</td> <td data-bbox="711 436 1175 520">Used to specify the date from when the membership is effective.</td> </tr> <tr> <td data-bbox="493 520 711 604">billableChargeData</td> <td data-bbox="711 520 1175 604">Used to specify the start date of the billable charge.</td> </tr> <tr> <td data-bbox="493 604 711 688">autoPayDetails</td> <td data-bbox="711 604 1175 688">Used to specify the date from when the auto pay instruction is effective.</td> </tr> <tr> <td data-bbox="493 688 711 772">policyData</td> <td data-bbox="711 688 1175 772">Used to specify the date from when the policy is effective.</td> </tr> <tr> <td data-bbox="493 772 711 856">policyPersons</td> <td data-bbox="711 772 1175 856">Used to specify the date from when the person is associated with the policy.</td> </tr> <tr> <td data-bbox="493 856 711 940">planData</td> <td data-bbox="711 856 1175 940">Used to specify the date from when the policy plan is effective.</td> </tr> <tr> <td data-bbox="493 940 711 1024">pricingRuleData</td> <td data-bbox="711 940 1175 1024">Used to specify the date from when the pricing rule is effective.</td> </tr> <tr> <td data-bbox="493 1024 711 1108">benefitDataList</td> <td data-bbox="711 1024 1175 1108">Used to specify the date from when the benefit charge is effective.</td> </tr> <tr> <td data-bbox="493 1108 711 1178">statementConstructDetails</td> <td data-bbox="711 1108 1175 1178">Used to specify the date from when the statement construct is effective.</td> </tr> </tbody> </table> <p>Note: You must specify the date in the YYYY-MM-DD format.</p>	If this tag is used within...	Then the purpose of the startDate tag is...	relatedPersons	Used to specify the date from when the other person is related to the person.	memberData	Used to specify the date from when the membership is effective.	billableChargeData	Used to specify the start date of the billable charge.	autoPayDetails	Used to specify the date from when the auto pay instruction is effective.	policyData	Used to specify the date from when the policy is effective.	policyPersons	Used to specify the date from when the person is associated with the policy.	planData	Used to specify the date from when the policy plan is effective.	pricingRuleData	Used to specify the date from when the pricing rule is effective.	benefitDataList	Used to specify the date from when the benefit charge is effective.	statementConstructDetails	Used to specify the date from when the statement construct is effective.	<p>Yes (Conditional)</p> <p>Note: This data is required in the following scenarios:</p> <ul style="list-style-type: none"> • While defining the respective information. • While editing the membership information of a person. • While editing an auto pay instruction of an account. • While editing a pricing rule.
If this tag is used within...	Then the purpose of the startDate tag is...																							
relatedPersons	Used to specify the date from when the other person is related to the person.																							
memberData	Used to specify the date from when the membership is effective.																							
billableChargeData	Used to specify the start date of the billable charge.																							
autoPayDetails	Used to specify the date from when the auto pay instruction is effective.																							
policyData	Used to specify the date from when the policy is effective.																							
policyPersons	Used to specify the date from when the person is associated with the policy.																							
planData	Used to specify the date from when the policy plan is effective.																							
pricingRuleData	Used to specify the date from when the pricing rule is effective.																							
benefitDataList	Used to specify the date from when the benefit charge is effective.																							
statementConstructDetails	Used to specify the date from when the statement construct is effective.																							

Tag Name	Tag Description	Mandatory (Yes or No)																						
endDate	<p>You can use this tag within the following tags:</p> <table border="1"> <thead> <tr> <th>If this tag is used within...</th> <th>Then the purpose of the endDate tag is...</th> </tr> </thead> <tbody> <tr> <td>relatedPersons</td> <td>Used to specify the date till when the other person is related to the person.</td> </tr> <tr> <td>memberData</td> <td>Used to specify the date till when the membership is effective.</td> </tr> <tr> <td>billableChargeData</td> <td>Used to specify the end date of the billable charge.</td> </tr> <tr> <td>autoPayDetails</td> <td>Used to specify the date till when the auto pay instruction is effective.</td> </tr> <tr> <td>policyData</td> <td>Used to specify the date till when the policy is effective.</td> </tr> <tr> <td>policyPersons</td> <td>Used to specify the date till when the person is associated with the policy.</td> </tr> <tr> <td>planData</td> <td>Used to specify the date till when the policy plan is effective.</td> </tr> <tr> <td>pricingRuleData</td> <td>Used to specify the date till when the pricing rule is effective.</td> </tr> <tr> <td>benefitDataList</td> <td>Used to specify the date till when the benefit charge is effective.</td> </tr> <tr> <td>statementConstructDetails</td> <td>Used to specify the date till when the statement construct is effective.</td> </tr> </tbody> </table> <p>Note: You must specify the date in the YYYY-MM-DD format.</p>	If this tag is used within...	Then the purpose of the endDate tag is...	relatedPersons	Used to specify the date till when the other person is related to the person.	memberData	Used to specify the date till when the membership is effective.	billableChargeData	Used to specify the end date of the billable charge.	autoPayDetails	Used to specify the date till when the auto pay instruction is effective.	policyData	Used to specify the date till when the policy is effective.	policyPersons	Used to specify the date till when the person is associated with the policy.	planData	Used to specify the date till when the policy plan is effective.	pricingRuleData	Used to specify the date till when the pricing rule is effective.	benefitDataList	Used to specify the date till when the benefit charge is effective.	statementConstructDetails	Used to specify the date till when the statement construct is effective.	<p>Yes (Conditional)</p> <p>Note: This data is required while editing the membership information of a person.</p>
If this tag is used within...	Then the purpose of the endDate tag is...																							
relatedPersons	Used to specify the date till when the other person is related to the person.																							
memberData	Used to specify the date till when the membership is effective.																							
billableChargeData	Used to specify the end date of the billable charge.																							
autoPayDetails	Used to specify the date till when the auto pay instruction is effective.																							
policyData	Used to specify the date till when the policy is effective.																							
policyPersons	Used to specify the date till when the person is associated with the policy.																							
planData	Used to specify the date till when the policy plan is effective.																							
pricingRuleData	Used to specify the date till when the pricing rule is effective.																							
benefitDataList	Used to specify the date till when the benefit charge is effective.																							
statementConstructDetails	Used to specify the date till when the statement construct is effective.																							
financialRelationshipSw	<p>Used to indicate whether the other person is financially responsible for the person. The valid values are:</p> <ul style="list-style-type: none"> • True • False <p>Note: If you do not specify the value, by default, it is set to False.</p>	No																						
parentOrChild	<p>Used to indicate whether the other person is parent or child. The valid values are:</p> <ul style="list-style-type: none"> • P • C 	<p>Yes (Conditional)</p> <p>Note: This data is required while creating a person to person relationship.</p>																						

Tag Name	Tag Description	Mandatory (Yes or No)						
characteristicsList	You can use this tag within the following tags:	Yes (Conditional)						
	<table border="1"> <thead> <tr> <th>If this tag is used within...</th> <th>Then the purpose of the characteristicsList tag is...</th> </tr> </thead> <tbody> <tr> <td>characteristics</td> <td>Used to specify a characteristic for the respective entity (i.e. person, person to person relationship, membership, billable charge, account, policy, policy plan, pricing rule, or benefit).</td> </tr> <tr> <td>membershipPersonCharacteristic</td> <td>Used to specify a characteristic for the member person.</td> </tr> </tbody> </table>	If this tag is used within...	Then the purpose of the characteristicsList tag is...	characteristics	Used to specify a characteristic for the respective entity (i.e. person, person to person relationship, membership, billable charge, account, policy, policy plan, pricing rule, or benefit).	membershipPersonCharacteristic	Used to specify a characteristic for the member person.	Note: This data is required while defining or editing a characteristic of the respective entity.
	If this tag is used within...	Then the purpose of the characteristicsList tag is...						
characteristics	Used to specify a characteristic for the respective entity (i.e. person, person to person relationship, membership, billable charge, account, policy, policy plan, pricing rule, or benefit).							
membershipPersonCharacteristic	Used to specify a characteristic for the member person.							
billLevelParameters	Used to specify the derivation and pricing parameters for the bill group.	No						
billLevelInfo1	Used to specify the employee attribute based on which you want to derive the bill group.	Yes (Conditional)						
	Note: You must not specify the ampersand (&) character in the value.	Note: This data is required while defining the derivation and pricing parameters for a bill group.						
billLevelInfo2	Used to specify the employee attribute based on which you want to derive the bill group.	No						
	Note: You must not specify the ampersand (&) character in the value.							
billLevelInfo3	Used to specify the employee attribute based on which you want to derive the bill group.	No						
	Note: You must not specify the ampersand (&) character in the value.							
billLevelInfo4	Used to specify the employee attribute based on which you want to derive the bill group.	No						
	Note: You must not specify the ampersand (&) character in the value.							
memberData	Used to specify basic information about the membership.	Yes (Conditional)						
		Note: This data is required while defining or editing the membership details of a person.						

Tag Name	Tag Description	Mandatory (Yes or No)
memberId	Used to specify the external membership ID.	No
	Note: Here, you need to specify a membership ID which is maintained in the external source system.	
memberRelationship	Used to indicate how the main subscriber is related to the membership.	Yes (Conditional)
		Note: This data is required while defining or editing the membership details of a person.
membershipPersonStatus	Used to indicate the status of the person in the membership. The valid values are: <ul style="list-style-type: none"> Active Inactive 	Yes
membershipPersonstatusReason	Used to indicate the reason why you want to change the status of the member person.	Yes
autoRenew	Used to indicate whether the individual membership should be automatically renewed.	No
associatedMemberIdentifierType	Used to indicate the associated membership identifier type.	Yes (Conditional)
		Note: This field is required when the associated membership identifier is specified.
associatedMemberIdentifierValue	Used to specify the value for associated membership identifier type.	Yes (Conditional)
		Note: This field is required when the associated membership identifier type is specified.
exchangeFlag	Used to indicate whether the individual membership is purchased from the exchange. <ul style="list-style-type: none"> Off On 	Yes (Conditional)
		Note: This field is required when you have purchased the individual membership from an exchange.
	Note: This field appears only when you are defining an individual membership.	

Tag Name	Tag Description	Mandatory (Yes or No)
exchangeId	Used to specify the exchange from where the individual membership is purchased.	Yes (Conditional)
	Note: This field appears only when you are defining an individual membership.	Note: This field is required when you have purchased the individual membership from an exchange.
binderLiabilityAmount	Used to specify the binder liability amount.	Yes (Conditional)
		Note: This field is required when the Consider Binder Liability Amount attribute is set to Y in the binder payment preference.
binderPayApplicability	Used to indicate that the system should monitor whether the binder payment is received before activating the individual membership. The valid values are: <ul style="list-style-type: none"> • Y • N 	Yes
binderPayGraceDays	Used to specify the days which are used to calculate the grace date for the individual membership.	No
binderPayThreshold	Used to specify the threshold percentage using which the threshold amount should be calculated.	No
holdBilling	Used to indicate whether you want to hold the bill generation process for the individual membership until the binder payment is received. The valid values are: <ul style="list-style-type: none"> • Y • N 	Yes
membershipRenewalDate	Used to indicate the date when the individual membership should be renewed.	Yes (Conditional)
	Note: Renewal date is required for manual renewal of the individual membership. In case of automatic renewal, the membership renewal date is calculated by the system. This field appears only when you are defining an individual membership.	Note: This field is required when you manually want to renew the individual membership.

Tag Name	Tag Description	Mandatory (Yes or No)
contractPeriod	Used to indicate the period (in months) for which the individual membership should be automatically renewed.	Yes (Conditional)
	Note: This field appears only when you are defining an individual membership.	Note: This field is required if you have entered the membership renewal date.
membershipIdentifier	Used to specify one or more identifiers for the individual membership	Yes (Conditional)
		Note: This data is required while defining or editing the individual membership details of a person.
membershipIdentifierType	Used to indicate the membership identifier type.	Yes (Conditional)
		Note: This field is required when the membership identifier is specified.
membershipIdentifierValue	Used to specify the value for the membership identifier type.	Yes (Conditional)
		Note: This field is required when the membership identifier type is specified.
isMemberSw	Used to indicate whether the person is a member or a non-member in the membership. The valid values are: <ul style="list-style-type: none"> • Yes • No 	No
isFinanciallyResponsibleSw	Used to indicate whether the person is financially responsible for the membership. The valid values are: <ul style="list-style-type: none"> • Yes • No 	No

Tag Name	Tag Description	Mandatory (Yes or No)								
membershipType	<p>You can use this tag within the following tags:</p> <table border="1"> <thead> <tr> <th>If this tag is used within...</th> <th>Then the purpose of the membershipType tag is...</th> </tr> </thead> <tbody> <tr> <td>memberData</td> <td> <p>Used to indicate the type of membership. The valid values are:</p> <ul style="list-style-type: none"> • COBRA • Medicare <p>Note: If you want to define an active employee coverage membership, you must leave this field blank.</p> </td> </tr> <tr> <td>mainSubscriber</td> <td>Used to specify the policy number.</td> </tr> <tr> <td>policyPlanProrationRules</td> <td>Used to specify the proration rules defined for the policy plan.</td> </tr> </tbody> </table>	If this tag is used within...	Then the purpose of the membershipType tag is...	memberData	<p>Used to indicate the type of membership. The valid values are:</p> <ul style="list-style-type: none"> • COBRA • Medicare <p>Note: If you want to define an active employee coverage membership, you must leave this field blank.</p>	mainSubscriber	Used to specify the policy number.	policyPlanProrationRules	Used to specify the proration rules defined for the policy plan.	No
If this tag is used within...	Then the purpose of the membershipType tag is...									
memberData	<p>Used to indicate the type of membership. The valid values are:</p> <ul style="list-style-type: none"> • COBRA • Medicare <p>Note: If you want to define an active employee coverage membership, you must leave this field blank.</p>									
mainSubscriber	Used to specify the policy number.									
policyPlanProrationRules	Used to specify the proration rules defined for the policy plan.									
externalMedicareBeneficiaryId	Used to specify the Medicare beneficiary identifier of the person who has availed the Medicare benefit.	No								
mainSubscriber	<p>Used to indicate whether the person is the main subscriber of the membership. The valid values are:</p> <ul style="list-style-type: none"> • Yes • No 	Yes								
policyNumber	<p>You can use this tag within the following tags:</p> <table border="1"> <thead> <tr> <th>If this tag is used within...</th> <th>Then the purpose of the policyNumber tag is...</th> </tr> </thead> <tbody> <tr> <td>memberData</td> <td>Used to specify the policy number.</td> </tr> <tr> <td>policyData</td> <td>Used to specify the policy number.</td> </tr> </tbody> </table>	If this tag is used within...	Then the purpose of the policyNumber tag is...	memberData	Used to specify the policy number.	policyData	Used to specify the policy number.	<p>Yes (Conditional)</p> <p>Note: This data is required while defining or editing the respective information.</p>		
If this tag is used within...	Then the purpose of the policyNumber tag is...									
memberData	Used to specify the policy number.									
policyData	Used to specify the policy number.									
planNumber	<p>You can use this tag within the following tags:</p> <table border="1"> <thead> <tr> <th>If this tag is used within...</th> <th>Then the purpose of the planNumber tag is...</th> </tr> </thead> <tbody> <tr> <td>memberData</td> <td>Used to indicate the fully-insured group policy plan for which the membership is created.</td> </tr> <tr> <td>planData</td> <td>Used to specify the plan number.</td> </tr> </tbody> </table>	If this tag is used within...	Then the purpose of the planNumber tag is...	memberData	Used to indicate the fully-insured group policy plan for which the membership is created.	planData	Used to specify the plan number.	<p>Yes (Conditional)</p> <p>Note: This data is required while defining or editing the respective information.</p>		
If this tag is used within...	Then the purpose of the planNumber tag is...									
memberData	Used to indicate the fully-insured group policy plan for which the membership is created.									
planData	Used to specify the plan number.									
healthPlanCode	Used to indicate the health plan for which the main subscriber has enrolled.	Yes								
membershipRateGuarantee	Used to specify information about the rate guarantee.	No								
membershipRateGuaranteeList	Used to specify rate guarantee details for each individual membership.	No								

Tag Name	Tag Description	Mandatory (Yes or No)
rateGuaranteeStartDate	Used to specify the date from when the rate guarantee is available for the individual membership.	Yes (Conditional) Note: This data is required while defining or editing the respective information.
rateGuaranteeEndDate	Used to specify the date till when the rate guarantee is available for the individual membership.	Yes (Conditional) Note: This data is required while defining or editing the respective information.
rateGuaranteeStatus	Used to indicate the status of the rate guarantee period. The valid values are: <ul style="list-style-type: none"> Active Inactive 	Yes (Conditional) Note: This data is required while defining or editing the respective information.
membershipPersonCharacteristics	Used to specify a list of characteristics for the member person.	No
benefitData	Used to specify information about the Medicare benefit.	Yes (Conditional) Note: This data is required while defining or editing a benefit.
benefitDataList	Used to indicate the order in which the benefit charge should be created for the membership.	Yes (Conditional) Note: This data is required while defining or editing a benefit.
benefitStatus	Used to indicate the status of the Medicare benefit. The valid values are: <ul style="list-style-type: none"> Active Discarded Inactive 	Yes (Conditional) Note: This data is required while defining or editing a benefit.
benefitSourceFlag	Used to indicate the source from where the Medicare benefit is received. The valid values are: <ul style="list-style-type: none"> Centers for Medicare and Medicaid Services State 	No

Tag Name	Tag Description	Mandatory (Yes or No)
benefitSubTypeFlag	Used to indicate the type of Medicare benefit. The valid values are: <ul style="list-style-type: none"> • Late Enrollment Penalty • Low Income Subsidy • Part A-Inpatient Hospital Coverage • Part B-Outpatient Hospital Coverage • Part D-Medicare Prescription Drug Coverage 	No
	Note: The list includes only those benefit sub types which are defined in the BENEFIT_SUB_TYPE_FLG lookup field.	
planBenefitPackageId	Used to indicate the medicare plan benefit package (i.e. 800 series plan) which is applicable for Medicare Part A, Part B, or Part D benefit.	Yes (Conditional)
	Note: You must specify a plan benefit package Id when the benefit sub type is set to Part A-Inpatient Hospital Coverage , Part B-Outpatient Medical Coverage , or Part D-Medicare Prescription Drug Coverage .	
benefitAmount	Used to specify the low income subsidy or late enrollment penalty amount for Medicare Part D.	No
	Note: You must specify a benefit amount when the benefit sub type is set to Late Enrollment Penalty or Low Income Subsidy .	
billableChargeData	Used to specify the details for a billable charge. Ideally, this piece of information should be specified in the main subscriber details and not in the member person details.	Yes (Conditional)
	Note: This data is required while defining or editing a billable charge of a membership.	
accountIdType	Used to specify the account identifier type.	Yes (Conditional)
	Note: You must specify an account identifier type which is already defined in the system.	
		Note: This data is required when the accountIdValue tag contains the account identifier.

Tag Name	Tag Description	Mandatory (Yes or No)						
accountIdValue	Used to indicate the account for which you want to create the billable charge.	Yes (Conditional) Note: This data is required when the accountIdType tag contains the account identifier type.						
chargeType	Used to indicate the type of billable charge that you want to create. Note: You must specify a charge type which is already defined in the system.	No						
priceItemCode	You can use this tag within the following tags: <table border="1"> <thead> <tr> <th>If this tag is used within...</th> <th>Then the purpose of the priceItemCode tag is...</th> </tr> </thead> <tbody> <tr> <td>billableChargeData</td> <td>Used to indicate the price item for which you want to create the billable charge.</td> </tr> <tr> <td>planData</td> <td>Used to indicate the price item which you want to associate with the policy plan.</td> </tr> </tbody> </table>	If this tag is used within...	Then the purpose of the priceItemCode tag is...	billableChargeData	Used to indicate the price item for which you want to create the billable charge.	planData	Used to indicate the price item which you want to associate with the policy plan.	Yes (Conditional) Note: This data is required while defining or editing a billable charge of a membership.
If this tag is used within...	Then the purpose of the priceItemCode tag is...							
billableChargeData	Used to indicate the price item for which you want to create the billable charge.							
planData	Used to indicate the price item which you want to associate with the policy plan.							
description	You can use this tag within the following tags: <table border="1"> <thead> <tr> <th>If this tag is used within...</th> <th>Then the purpose of the description tag is...</th> </tr> </thead> <tbody> <tr> <td>billableChargeData</td> <td>Used to specify the description for the billable charge.</td> </tr> <tr> <td>policyData</td> <td>Used to specify the description for the policy.</td> </tr> </tbody> </table>	If this tag is used within...	Then the purpose of the description tag is...	billableChargeData	Used to specify the description for the billable charge.	policyData	Used to specify the description for the policy.	Yes (Conditional) Note: This data is required while defining the respective information.
If this tag is used within...	Then the purpose of the description tag is...							
billableChargeData	Used to specify the description for the billable charge.							
policyData	Used to specify the description for the policy.							
recurringMethod	Used to indicate whether recurring bill segments must be created for the billable charge at the specified intervals. The valid values are: <ul style="list-style-type: none"> BP - Used when you want to create recurring bill segments at the intervals defined in the bill period. FR - Used when you want to create recurring bill segments at the set invoice frequency. 	No						
billPeriod	Used to indicate the bill period using which you want to determine the intervals at which the recurring bill segments must be created. Note: You must specify a bill period which is already defined in the system.	Yes (Conditional) Note: This data is required when the recurringMethod tag contains BP .						

Tag Name	Tag Description	Mandatory (Yes or No)
frequency	Used to indicate the invoice frequency at which the recurring bill segments must be created.	Yes (Conditional)
	Note: You must specify an invoice frequency which is already defined in the system.	Note: This data is required when the recurringMethod tag contains FR .
billAfterDt	Used to specify the date after which the bill must be generated for the billable charge.	No
	Note: You must specify the date in the YYYY-MM-DD format.	
billableChargeLines	Used to specify the details for a pass through line in the billable charge.	Yes
descriptionOnBill	Used to specify the information about the pass through line that should appear on the bill.	Yes
currencyCode	Used to indicate the currency in which you want to charge the amount.	Yes
	Note: You must specify a currency which is already defined in the system. If you specify a currency other than the account's invoice currency, the system will do the currency conversion if the appropriate exchange rate is available in the system.	
chargeAmount	Used to specify the charge amount.	Yes
showOnBillSw	Used to indicate whether the charge should appear on the person's printed bill. The valid values are: <ul style="list-style-type: none"> • true • false 	No
	Note: If you do not specify the value, by default, it is set to true .	
appearInSummarySw	Used to indicate whether the charge should be included in the summary line. The valid values are: <ul style="list-style-type: none"> • true • false 	No
	Note: If you do not specify the value, by default, it is set to false .	
distributionCode	Used to specify the distribution code which indicates the GL account associated with the charge.	No
	Note: You must specify a distribution code which is already defined in the system.	

Tag Name	Tag Description	Mandatory (Yes or No)
accountData	Used to specify the account details of a person.	Yes (Conditional) Note: This data is required while defining or editing an account.
accountType	Used to indicate the type of account. This information is stored as a characteristic for the account. Note: The value is stored in the characteristic type which is specified in the Invoice Type Characteristic Type option type of the C1-ASOBLNG feature configuration. You must specify a value which is already defined in the predefined characteristic type.	Yes (Conditional) Note: This data is required while defining or editing an account.
customerClass	Used to indicate the customer class to which the account belongs. Note: You must specify a customer class which is already defined in the system.	Yes (Conditional) Note: This data is required while defining an account.
billCycle	Used to indicate the bill cycle for the account. Note: You must specify a bill cycle which is already defined in the system.	No
billLeadDays	Used to indicate whether you want to bill the account in advance. Here, you need to specify the number of days which is used to derive the cut-off date for advance billing. If you do not want to bill the account in advance, you must specify the value as zero(0). Note: If you do not specify the value, by default, it is set to zero(0).	No
currency	Used to indicate the currency in which you want to bill the account. Note: You must specify a currency which is already defined in the system.	Yes (Conditional) Note: This data is required while defining an account.
setUpDate	Used to specify the date when the account was first created. This is purely informational. Note: You must specify the date in the YYYY-MM-DD format. If you do not specify the value, by default, it is set to the current date.	No

Tag Name	Tag Description	Mandatory (Yes or No)						
acctUsageFlg	<p>Used to indicate the category to which the account belongs. The valid values are:</p> <ul style="list-style-type: none"> • INVC - Indicates that the account will be used to bill charges of the usage accounts. • SETL - Indicates that the account will be used only for settlement purposes. • USAG - Indicates that the account will have its own charges. If the usage account is linked to any construct, the usage account's charges are billed through an invoice account. Otherwise, the usage account is billed individually. <p>Note: If you do not specify the value, by default, it is set to USAG.</p>	No						
comments	<p>You can use this tag within the following tags:</p> <table border="1"> <thead> <tr> <th>If this tag is used within...</th> <th>Then the purpose of the comments tag is...</th> </tr> </thead> <tbody> <tr> <td>accountData</td> <td>Used to specify additional information about the account.</td> </tr> <tr> <td>autoPayDetails</td> <td>Used to specify additional information about the auto pay instruction.</td> </tr> </tbody> </table>	If this tag is used within...	Then the purpose of the comments tag is...	accountData	Used to specify additional information about the account.	autoPayDetails	Used to specify additional information about the auto pay instruction.	No
If this tag is used within...	Then the purpose of the comments tag is...							
accountData	Used to specify additional information about the account.							
autoPayDetails	Used to specify additional information about the auto pay instruction.							
deferAutoPayDt	Used to specify the date till when you want to hold the automatic payment process for the account.	No						
collectionClass	<p>Used to specify the collection class using which you want to control the account's debt.</p> <p>Note: If you do not specify the value, by default, it is set to the collection class which is specified in the customer class of the account. You must specify a collection class which is already defined in the system.</p>	No						
billRouteType	<p>You can use this tag within the following tags:</p> <table border="1"> <thead> <tr> <th>If this tag is used within...</th> <th>Then the purpose of the billRouteType tag is...</th> </tr> </thead> <tbody> <tr> <td>accountData</td> <td>Used to indicate how the account's bill must be sent to the main customer.</td> </tr> <tr> <td>accountPersonRouting</td> <td>Used to indicate how the account's bill must be sent to the linked person.</td> </tr> </tbody> </table> <p>Note: You must specify a bill route type which is already defined in the system.</p>	If this tag is used within...	Then the purpose of the billRouteType tag is...	accountData	Used to indicate how the account's bill must be sent to the main customer.	accountPersonRouting	Used to indicate how the account's bill must be sent to the linked person.	<p>Yes (Conditional)</p> <p>Note: This data is required while defining or editing the respective information.</p>
If this tag is used within...	Then the purpose of the billRouteType tag is...							
accountData	Used to indicate how the account's bill must be sent to the main customer.							
accountPersonRouting	Used to indicate how the account's bill must be sent to the linked person.							

Tag Name	Tag Description	Mandatory (Yes or No)						
billAddressSource	<p>You can use this tag within the following tags:</p> <table border="1" data-bbox="492 268 1175 915"> <thead> <tr> <th data-bbox="492 268 712 352">If this tag is used within...</th> <th data-bbox="712 268 1175 352">Then the purpose of the billAddressSource tag is...</th> </tr> </thead> <tbody> <tr> <td data-bbox="492 352 712 636">accountData</td> <td data-bbox="712 352 1175 636"> Used to indicate whether the account's bill must be sent to the main customer's mailing address or to the main customer's account override address. The valid values are: <ul style="list-style-type: none"> • PER • ACOV </td> </tr> <tr> <td data-bbox="492 636 712 915">accountPersonRouting</td> <td data-bbox="712 636 1175 915"> Used to indicate whether the account's bill must be sent to the linked person's mailing address or to the linked person's account override address. The valid values are: <ul style="list-style-type: none"> • PER • ACOV </td> </tr> </tbody> </table> <p>Note: You must specify a value which is already defined in the BILL_ADDR_SRCE_FLG lookup field. It must be in the Active status.</p>	If this tag is used within...	Then the purpose of the billAddressSource tag is...	accountData	Used to indicate whether the account's bill must be sent to the main customer's mailing address or to the main customer's account override address. The valid values are: <ul style="list-style-type: none"> • PER • ACOV 	accountPersonRouting	Used to indicate whether the account's bill must be sent to the linked person's mailing address or to the linked person's account override address. The valid values are: <ul style="list-style-type: none"> • PER • ACOV 	<p>Yes (Conditional)</p> <p>Note: This data is required while defining the respective information.</p>
If this tag is used within...	Then the purpose of the billAddressSource tag is...							
accountData	Used to indicate whether the account's bill must be sent to the main customer's mailing address or to the main customer's account override address. The valid values are: <ul style="list-style-type: none"> • PER • ACOV 							
accountPersonRouting	Used to indicate whether the account's bill must be sent to the linked person's mailing address or to the linked person's account override address. The valid values are: <ul style="list-style-type: none"> • PER • ACOV 							
autoPayDetails	Used to specify the auto pay instruction for the account.	<p>Yes (Conditional)</p> <p>Note: This data is required while defining or editing an auto pay instruction of an account.</p>						
priority	<p>Used to indicate the priority in which the auto pay instruction should be considered when multiple auto pay instructions are effective on the bill's due date.</p> <p>Note: The priority cannot be less than or equal to zero.</p>	<p>Yes (Conditional)</p> <p>Note: This data is required while defining or editing an auto pay instruction of an account.</p>						
percentage	Used to indicate the percentage in which the payment must be split between two or more auto pay sources having the same priority.	<p>Yes (Conditional)</p> <p>Note: This data is required while defining or editing the split auto pay instruction for an account.</p>						

Tag Name	Tag Description	Mandatory (Yes or No)
autoPayMethod	Used to indicate how you want to process the automatic payment request. The valid values are: <ul style="list-style-type: none"> • C1DD - Indicates that you want to directly debit the main customer's bank account. • C1PA - Indicates that you want to send a payment advice to the main customer. 	No
autoPayRouteType	Used to indicate when and how automatic payment request of the account is routed to a financial institution. Note: You must specify an auto pay route type which is already defined in the system.	Yes (Conditional) Note: This data is required while defining or editing an auto pay instruction of an account.
autoPaySourceCode	Used to indicate the financial institution that receives the automatic payment request. Note: You must specify an auto pay source which is already defined in the system.	Yes (Conditional) Note: This data is required while defining or editing an auto pay instruction of an account.
accountNumber	Used to indicate the bank account number through which the automatic payment must be done.	Yes (Conditional) Note: This data is required while defining or editing an auto pay instruction of an account.
expiryMonth	Used to specify the month when the tender type of the auto pay source will expire. Note: You must specify the month in the MM format.	Yes (Conditional) Note: This data is required when the Expiration Date Required option is selected for the tender type which is specified in the auto pay source.
expiryYear	Used to specify the year when the tender type of the auto pay source will expire. Note: You must specify the year in the YYYY format.	Yes (Conditional) Note: This data is required when the Expiration Date Required option is selected for the tender type which is specified in the auto pay source.
name	Used to specify the name of the person as it appears in the financial institution's system.	No

Tag Name	Tag Description	Mandatory (Yes or No)														
maxWithdrawalAmount	Used to specify the maximum amount that can be automatically debited from the bank account. It is used to set the limit on the withdrawal amount. Note: The maximum withdrawal amount cannot be less than zero.	No														
accountPerson	Used to specify information about the person (other than main customer) to whom you want to link the account. Note: The system, by default, adds the person (for whom the account information is given in the health care inbound message) as the main customer of the account. While linking the person as main customer of the account, the system sets the following attributes: <table border="1"> <thead> <tr> <th>Attribute Name</th> <th>Attribute Value</th> </tr> </thead> <tbody> <tr> <td>Financially Responsible</td> <td>Y</td> </tr> <tr> <td>Account Relationship Type</td> <td>Main Customer</td> </tr> <tr> <td>Receive Copy of Bill</td> <td>Y</td> </tr> <tr> <td>Bill Format</td> <td>Detailed</td> </tr> <tr> <td>Receives Notification</td> <td>Y</td> </tr> <tr> <td>Number of Bill Copies</td> <td>1</td> </tr> </tbody> </table>	Attribute Name	Attribute Value	Financially Responsible	Y	Account Relationship Type	Main Customer	Receive Copy of Bill	Y	Bill Format	Detailed	Receives Notification	Y	Number of Bill Copies	1	Yes (Conditional) Note: This data is required while linking a person to an account.
Attribute Name	Attribute Value															
Financially Responsible	Y															
Account Relationship Type	Main Customer															
Receive Copy of Bill	Y															
Bill Format	Detailed															
Receives Notification	Y															
Number of Bill Copies	1															
accountRelationshipType	Used to indicate how the person is related to the account. Note: You must specify an account relationship type which is already defined in the system.	Yes (Conditional) Note: This data is required while linking a person to an account.														
isFinanciallyResponsible	Used to indicate whether the person is financially responsible for the account. The valid values are: <ul style="list-style-type: none">• True• False Note: If you do not specify the value, by default, it is set to False .	No														
personAddressOverride	Used to specify the account override address for the linked person.	No														
postal	Used to specify the postal code of the address.	No														

Tag Name	Tag Description	Mandatory (Yes or No)
accountPersonRouting	Used to specify the bill routing information for the linked person.	Yes (Conditional) Note: This data is required while defining or editing the bill routing information of a linked person.
shouldReceiveCopyOfBill	Used to indicate whether the linked person should receive a copy of the account's bill. The valid values are: <ul style="list-style-type: none"> • Y • N Note: If you do not specify the value, by default, it is set to N.	No
billFormat	Used to indicate whether the linked person should receive the detailed or summary bill. The valid values are: <ul style="list-style-type: none"> • D • S Note: You must specify a value which is already defined in the BILL_FORMAT_FLG lookup field. It must be in the Active status. If you do not specify the value, by default, it is set to D when the linked person should receive a copy of the account's bill. This information is ignored when the shouldReceiveCopyOfBill tag contains N .	No
numberOfBillCopies	Used to indicate the number of copies of the bill which the linked person must receive. Note: If you do not specify the value, by default, it is set to 1 when the linked person should receive a copy of the account's bill. This information is ignored when the shouldReceiveCopyOfBill tag contains N .	No

Tag Name	Tag Description	Mandatory (Yes or No)
receivesNotification	<p>Used to indicate whether the linked person should receive letters (i.e. notifications) initiated by collection, write-off, and overdue events. The valid values are:</p> <ul style="list-style-type: none"> • Y • N <p>Note: If you do not specify the value, by default, it is set to N. This information is ignored when the shouldReceiveCopyOfBill tag contains N.</p>	No
policyData	Used to specify the details of the policy.	Yes (Conditional)
		Note: This data is required while defining or editing a policy.
policyType	Used to indicate the policy type using which you are defining the policy.	Yes (Conditional)
	Note: You must specify a policy type which is already defined in the system. If you want to create a fully-insured group policy, you must specify a policy type where the policy category is set to Fully-Insured Group . However, if you want to create a self-funded policy, you must specify a policy type where the policy category is set to Self-Funded .	Note: This data is required while defining or editing a policy.
advancedLevelFundingEligibility	Used to indicate whether the self-funded policy provides advanced level funding eligibility. The valid values are:	Yes (Conditional)
	<ul style="list-style-type: none"> • Yes • No <p>Note: At present, if you are defining a self-funded policy the advanced level funded eligibility is set to No.</p>	Note: This data is required while defining or editing a policy.
runOutEndDate	Used to specify the date when the runout period of the self-funded policy ends.	No
	<p>Note: The runout end date cannot be earlier than or equal to the policy end date. This data is required when you are defining a policy using a policy type where the policy category is set to Self-Funded.</p>	

Tag Name	Tag Description	Mandatory (Yes or No)
runOutAdminOption	<p>Used to indicate whether the administration fees must be charged when the claim transaction for the self-funded policy is processed in the runout period. The valid values are:</p> <ul style="list-style-type: none"> • None • Percentage of Claim <p>Note: At present, this data is used only for the informational purposes and is not considered during the billable charge creation for the claim transactions which are received in the runout period of the policy. This data is required when you are defining a policy using a policy type where the policy category is set to Self-Funded.</p>	No
renewalDate	<p>Used to specify the date when you want to renew the fully-insured group policy.</p> <p>Note: You can renew a self-funded policy only from the user interface. You must specify the date in the YYYY-MM-DD format.</p>	<p>Yes (Conditional)</p> <p>Note: This data is required while renewing a fully-insured group policy.</p>
policyPersons	Used to indicate the person that you want to associate with the policy.	Yes
policyPerRole	<p>Used to indicate the role of the person in the policy.</p> <p>Note: You must specify a policy person role which is already defined in the system.</p>	<p>Yes (Conditional)</p> <p>Note: This data is required while associating a person with the policy.</p>
terminationInformation	<p>Used to specify the termination details of the fully-insured group policy.</p> <p>Note: At present, you cannot terminate a self-funded policy either from the user interface or through a health care inbound message.</p>	No
terminateDate	<p>Used to specify the date when you want to terminate the fully-insured group policy.</p> <p>Note: You must specify the date in the YYYY-MM-DD format. The termination date cannot be earlier than the policy start date. On terminating a policy, the status of the policy is changed to the status which is specified in the Policy Termination Status option type of the C1-ASOBLNG feature configuration.</p>	<p>Yes (Conditional)</p> <p>Note: This data is required while terminating a fully-insured group policy.</p>

Tag Name	Tag Description	Mandatory (Yes or No)
terminationReason	Used to indicate the reason why you want to terminate the fully-insured group policy.	Yes (Conditional)
	Note: You must specify the status reason which is already defined for the status specified in the Policy Termination Status option type of the C1-ASOBLLNG feature configuration.	Note: This data is required while terminating a fully-insured group policy.
reinstateInformation	Used to specify the reinstatement details of the fully-insured group policy.	No
	Note: At present, you cannot reinstate a self-funded policy either from the user interface or through a health care inbound message.	
reinstatementDate	Used to specify the date when you want to reinstate the fully-insured group policy.	Yes (Conditional)
	Note: You must specify the date in the YYYY-MM-DD format. The reinstatement date cannot be earlier than the policy start date. On reinstating a policy, the status of the policy is changed to the status which is specified in the Policy Reinstatement Status option type of the C1-ASOBLLNG feature configuration.	Note: This data is required while reinstating a fully-insured group policy.
reinstateReason	Used to indicate the reason why you want to reinstate the fully-insured group policy.	Yes (Conditional)
	Note: You must specify the status reason which is already defined for the status specified in the Policy Reinstatement Status option type of the C1-ASOBLLNG feature configuration.	Note: This data is required while reinstating a fully-insured group policy.
planData	Used to specify the details of the policy plan.	Yes (Conditional)
	Note: At present, you can only define a policy plan in a fully-insured group policy. Therefore, the system will ignore this information when given for a self-funded policy.	Note: This data is required while defining or editing a policy plan.
planName	Used to specify the description of the policy plan.	No
pricingRuleTypeList	Used to associate a pricing rule type with the policy plan.	Yes (Conditional)
		Note: This data is required while associating a pricing rule type with the policy plan.

Tag Name	Tag Description	Mandatory (Yes or No)
pricingRuleType	Used to specify the pricing rule type.	Yes (Conditional)
	Note: At present, you can only associate those pricing rule types where the category is set to Age Based, Tier Based, or Pass-Through Billable Charge . Therefore, the system will ignore the pricing rule types where the category is set to Claim, Specific Stop-Loss, Aggregate Stop-Loss, Retention Type Claim Based, Retention Type Enrollment Based, Flat Fees, Ancillary, Discount Arrangement, or Level Funded .	Note: This data is required when a price item is not associated with the policy plan.
primaryPlanSw	Used to indicate whether the plan is a primary plan in the policy. The valid values are: <ul style="list-style-type: none"> • Y • N 	No
	Note: If you do not specify the value, by default, it is set to N.	
benefitTypeFlag	Used to indicate the type of benefit. The valid value is: <ul style="list-style-type: none"> • Medicare Affiliated 	Yes
	Note: The list includes only those benefit types which are defined in the BENEFIT_TYPE_FLG lookup field.	
policyPlanProrationRuleList	Used to specify the proration rules defined for the policy plan.	Yes (Conditional)
		Note: This data is required while defining or editing the proration rules for the policy plan.
prorationEventType	Used to indicate the event when you want to prorate the membership premium. The valid values are: <ul style="list-style-type: none"> • Enrollment – Used when you want to prorate the membership premium on enrolling a member person. • Termination - Used when you want to prorate the membership premium on terminating a member person. • New Born - Used when you want to prorate the membership premium on enrolling a new born. • Same Month Enrollment and Termination - Used when you want to prorate the membership premium on enrolling and terminating a member person in the same month. 	Yes (Conditional)
		Note: This data is required while defining or editing the proration rules for the policy plan.

Tag Name	Tag Description	Mandatory (Yes or No)
prorationType	<p>Used to indicate how you want to prorate the membership premium. The valid values are:</p> <ul style="list-style-type: none"> • Daily – Used when you want to prorate the membership premium from the day the proration event has occurred. • Mid-Month – Used when you want to prorate the membership premium based on the proration date. The system calculates the proration date using the following formula: $\text{Bill Period Start Date} + \text{Specified Number of Days}$ <p>For example, if the bill period start date is 1st of every month and number of days is 15, then the proration date would be 15th of every month. If a member person is enrolled to the membership on or before the proration date, the system will charge the premium for the member person. However, if a member person is enrolled to the membership after the proration date, the system will not charge the premium for the member person. And, if a member person is terminated from the membership on or after the proration date, the system will charge the premium for the member person. However, if a member person is terminated from the membership before the proration date, the system will not charge the premium for the member person.</p> • Full Month – Used when the premium for a member person should be charged when the member person is enrolled or terminated on the coverage start date or coverage end date, respectively. If a member person is enrolled or terminated within the coverage period, the system will not charge the premium for the member person. • Waiver – Used when the premium for a member person should be waived off completely for the month when the member person is enrolled or terminated from the membership. • Coverage Days – Used when you want to prorate the premium for a member person based on the coverage days. If a member person is covered in the membership for a period less than the specified number of days, the system will not charge the premium for the member person. However, if a member person is covered in the membership for a period equal to or more than the specified number of days, the system will charge the premium for the member person. <div style="border: 1px solid black; padding: 5px; margin: 10px 0;"> <p>Note: You can use this proration type when the proration event is set to Same Month Enrollment and Termination.</p> </div> <ul style="list-style-type: none"> • Enrollment – Used when you want to prorate the premium for a member person using the proration type of the enrollment event. <div style="border: 1px solid black; padding: 5px; margin: 10px 0;"> <p>Note: You can use this proration type when the proration event is set to Same Month Enrollment and Termination.</p> </div> <ul style="list-style-type: none"> • Termination – Used when you want to prorate the premium for a member person using the proration type of the 	<p>Yes (Conditional)</p> <div style="border: 1px solid black; padding: 5px; margin: 10px 0;"> <p>Note: This data is required while defining or editing the proration rules for the policy plan.</p> </div>

Tag Name	Tag Description	Mandatory (Yes or No)
numberOfDays	Used to specify the number of days to determine the cutoff date.	Yes (Conditional) Note: This data is required when the proration type is set to Mid-Month or Coverage Days .
pricingRuleData	Used to specify the details of the pricing rule.	Yes (Conditional) Note: This data is required while defining or editing a pricing rule.
entityIdentifiers	Used to specify a list of entities (i.e. policy, source system, and plan) using which you can derive the plan to which you want to associate the pricing rule.	Yes
entityIdentifiersList	Used to specify the details of the entity.	Yes
entityIdentifierType	Used to specify the entity type. The valid values are: <ul style="list-style-type: none"> • PLAN - Used when you want to specify the plan number. • PLCY - Used when you want to specify the policy number. • SSYS - Used when you want to specify the source system 	Yes (Conditional) Note: This data is required while defining or editing a pricing rule.
entityIdentifierValue	Used to specify the entity identifier (i.e. plan number, policy number, or source system).	Yes (Conditional) Note: This data is required while defining or editing a pricing rule.
status	Used to indicate the status of the pricing rule. The valid values are: <ul style="list-style-type: none"> • ACTV • INAC Note: If you do not specify the value, by default, it is set to Active .	No
pricingRuleType	Used to indicate the pricing rule type using which you want to define the pricing rule. Note: You must specify a pricing rule type where the category is set to Age Based or Tier Based .	Yes (Conditional) Note: This data is required while defining or editing a pricing rule.
priceItemCd	Used to indicate the price item for which you want to define the pricing rule. Note: You must specify a price item which is already associated with the respective pricing rule type.	Yes (Conditional) Note: This data is required while defining or editing a pricing rule.

Tag Name	Tag Description	Mandatory (Yes or No)
rateOption	<p>Used to indicate the rate option using which you want to create price assignment for the pricing rule.</p> <p>Note:</p> <p>You must specify a rate option which is already defined in the C1-ExtLookRetTypeRateOpt extendable lookup. It must be in the Active status.</p> <p>If the rate option is not given for an age-based pricing rule, by default, it is set to:</p> <ul style="list-style-type: none"> • The value specified in the Default Rate Option – Flat option type of the C1-ASOBLNG feature configuration when the modifier method is set to FLAT • The value specified in the Default Rate Option – Percentage option type of the C1-ASOBLNG feature configuration when the modifier method is set to EXPT or INPT <p>However, if the rate option is not given for a tier-based pricing rule, by default, it is set to a value specified in the Default Rate Option – Flat option type of the C1-ASOBLNG feature configuration when the modifier method is set to FLAT or NULL.</p>	No
modifierApplicability	<p>Used to indicate whether you want to increase or decrease the premium of an eligible member based on certain modifiers (i.e. parameters, such as tobacco usage, alcohol usage, and so on). The valid values are:</p> <ul style="list-style-type: none"> • Y • N <p>Note: If you do not specify the value, by default, it is set to N.</p>	No
modifierMethod	<p>Used to indicate whether the system should consider the modifier rate as a flat amount or percentage. The valid values are:</p> <ul style="list-style-type: none"> • FLAT - Indicates that the system should consider the modifier rate as a flat amount. • INPT - Indicates that the system should consider the modifier rate as inclusive percentage. • EXPT - Indicates that the system should consider the modifier rate as exclusive percentage. 	<p>Yes (Conditional)</p> <p>Note: This data is required when the modifierApplicability tag contains Y.</p>
baseRate	<p>Used to specify the base fees for employees with a particular set of attributes. You can define different base fees for employees with different set of attributes.</p> <p>Note: While creating a price assignment for the pricing rule, the system creates one price component for each given set of base rate information.</p>	<p>Yes (Conditional)</p> <p>Note: This data is required while defining a pricing rule.</p>

Tag Name	Tag Description	Mandatory (Yes or No)
baseFee	Used to specify the base fees for the eligible members.	Yes (Conditional) Note: This data is required while defining a pricing rule.
lowerAgeLimit	Used to specify the lower age limit. It is used to define lower age limit pricing eligibility criteria in the price component. Note: The system defines the lower age limit pricing eligibility criteria using the parameter which is specified in the Age Based Parameter option type of the C1-ASOBLLNG feature configuration. This data is ignored when given in a tier-based pricing rule information.	Yes (Conditional) Note: This data is required while defining an age-based pricing rule.
upperAgeLimit	Used to specify the upper age limit. It is used to define upper age limit pricing eligibility criteria in the price component. Note: The system defines the upper age limit pricing eligibility criteria using the parameter which is specified in the Age Based Parameter option type of the C1-ASOBLLNG feature configuration. This data is ignored when given in a tier-based pricing rule information.	Yes (Conditional) Note: This data is required while defining an age-based pricing rule.
pricingParameter	Used to specify a set of employee attributes based on which the base fees may vary.	Yes (Conditional) Note: This data is required while defining a tier-based pricing rule.

Tag Name	Tag Description	Mandatory (Yes or No)						
parameterCode	<p>You can use this tag within the following tags:</p> <table border="1" data-bbox="493 268 1175 709"> <thead> <tr> <th data-bbox="493 268 711 352">If this tag is used within...</th> <th data-bbox="711 268 1175 352">Then the purpose of the parameterCode tag is...</th> </tr> </thead> <tbody> <tr> <td data-bbox="493 352 711 531">pricingParameter</td> <td data-bbox="711 352 1175 531">Used to specify the employee attribute (i.e. parameter, such as employee status, employee location, and so on) using which you want to define the pricing eligibility criteria.</td> </tr> <tr> <td data-bbox="493 531 711 709">modifierInformation</td> <td data-bbox="711 531 1175 709">Used to specify the modifier (i.e. parameter, such as tobacco usage, alcohol usage, and so on) using which you want to define the pricing eligibility criteria.</td> </tr> </tbody> </table> <p>Note: You must define the employee attributes and modifiers as parameters in the system. Note that you must set the parameter usage for these parameters to Pricing Eligibility Criteria. The system creates an pricing eligibility criteria for each parameter and/or modifier specified in the pricing rule information. You cannot specify any special character except underscore (_) in the parameter name.</p>	If this tag is used within...	Then the purpose of the parameterCode tag is...	pricingParameter	Used to specify the employee attribute (i.e. parameter, such as employee status, employee location, and so on) using which you want to define the pricing eligibility criteria.	modifierInformation	Used to specify the modifier (i.e. parameter, such as tobacco usage, alcohol usage, and so on) using which you want to define the pricing eligibility criteria.	<p>Yes (Conditional)</p> <p>Note: This data is required while specifying the respective information.</p>
If this tag is used within...	Then the purpose of the parameterCode tag is...							
pricingParameter	Used to specify the employee attribute (i.e. parameter, such as employee status, employee location, and so on) using which you want to define the pricing eligibility criteria.							
modifierInformation	Used to specify the modifier (i.e. parameter, such as tobacco usage, alcohol usage, and so on) using which you want to define the pricing eligibility criteria.							
parameterValue	<p>You can use this tag within the following tags:</p> <table border="1" data-bbox="493 1138 1175 1388"> <thead> <tr> <th data-bbox="493 1138 711 1222">If this tag is used within...</th> <th data-bbox="711 1138 1175 1222">Then the purpose of the parameterValue tag is...</th> </tr> </thead> <tbody> <tr> <td data-bbox="493 1222 711 1306">pricingParameter</td> <td data-bbox="711 1222 1175 1306">Used to specify the value for the parameter (i.e. employee attribute).</td> </tr> <tr> <td data-bbox="493 1306 711 1388">modifierInformation</td> <td data-bbox="711 1306 1175 1388">Used to specify the value for the parameter (i.e. modifier).</td> </tr> </tbody> </table> <p>Note: You can specify any special characters except ampersand (&), comma (,), underscore (_), equal to (=), tilde (~), and semi-colon(;). in the parameter value.</p>	If this tag is used within...	Then the purpose of the parameterValue tag is...	pricingParameter	Used to specify the value for the parameter (i.e. employee attribute).	modifierInformation	Used to specify the value for the parameter (i.e. modifier).	<p>Yes (Conditional)</p> <p>Note: This data is required while specifying the respective information.</p>
If this tag is used within...	Then the purpose of the parameterValue tag is...							
pricingParameter	Used to specify the value for the parameter (i.e. employee attribute).							
modifierInformation	Used to specify the value for the parameter (i.e. modifier).							
modifierInformation	<p>Used to specify the modifier based on which you want to increase or decrease the base fees.</p> <p>Note: While creating a price assignment for the pricing rule, the system creates one price component for each given set of modifier information and then links these modifier price components with the respective base rate price component.</p>	<p>Yes (Conditional)</p> <p>Note: This data is required while specifying the modifier information.</p>						

Tag Name	Tag Description	Mandatory (Yes or No)
rate	Used to specify the flat amount or percentage by which you want to increase or decrease the premium of an eligible member.	Yes (Conditional) Note: This data is required while specifying the modifier information.
statementConstructDetail	Used to specify the statement construct details.	Yes (Conditional) Note: This data is required while specifying the statement construct information.
serviceAgreement	Used to specify the statement construct contract.	Yes
accountNumber	Used to specify the value for the account identifier type of the payee. Note: You must specify the account number which is already defined in the system.	Yes (Conditional) Note: This data is required while specifying the statement construct information.
accountNumberTypeCode	Used to specify the account identifier type of the payee.	Yes (Conditional) Note: This data is required while specifying the statement construct information.
statementPrintDescription	Used to specify the description of the construct detail associated with the contract.	Yes (Conditional) Note: This data is required while specifying the statement construct information.
printOrder	Used to specify the financial transactions associated with the account / contract to appear on the printed statement.	Yes (Conditional) Note: This data is required while specifying the statement construct information.

The following table lists and describes the tags which are available in the health care inbound message schema, but should not be included in the XML file:

Tag Name	Tag Description
c1InboundMessage	Displays the inbound message ID.
boStatus	Displays the status of the health care inbound message.
statusReason	Indicates the reason why the status of the health care inbound message is changed.
person	At present, this tag is not supported in a health care inbound message.

Tag Name	Tag Description						
statusDateTime	Displays the date and time when the status of the health care inbound message is changed in the system.						
creationDateTime	Displays the date and time when the health care inbound message is created in the system.						
searchCharacteristicValue	At present, this tag is not supported in a health care inbound message.						
version	This tag appears within the following parent tags: <table border="1" data-bbox="511 451 1461 667"> <thead> <tr> <th>Parent Tag</th> <th>Then the purpose of the version tag is...</th> </tr> </thead> <tbody> <tr> <td>schema</td> <td>Displays the version of the health care inbound message.</td> </tr> <tr> <td>inboundMessageCharacteristic</td> <td>Displays the version of the characteristic defined for the health care inbound message.</td> </tr> </tbody> </table>	Parent Tag	Then the purpose of the version tag is...	schema	Displays the version of the health care inbound message.	inboundMessageCharacteristic	Displays the version of the characteristic defined for the health care inbound message.
Parent Tag	Then the purpose of the version tag is...						
schema	Displays the version of the health care inbound message.						
inboundMessageCharacteristic	Displays the version of the characteristic defined for the health care inbound message.						
paidThroughDate	Indicates the term end date of the last fully or partially paid term. For more information about the paid through date, refer to Policy on page 315.						
toDoRetry	Displays the information about the retry option used for the health care inbound message. Note: This information appears at the bottom of the inbound message in the Inbound Message Content zone once the health care inbound message is validated and processed either through the user interface or batch process.						
retryDateTime	Displays the date and time when the retry option is used to change the status of the health care inbound message from Rejected to Pending .						
numberOfRetries	Indicates the number of times the retry option is used for the health care inbound message.						
currentErrorState	Indicates the status to which the health care inbound message is transitioned when its validation or processing fails. The valid value is: <ul style="list-style-type: none"> REJECTED 						
isRetried	Indicates whether the retry option is used to change the status of the health care inbound message. The valid values are: <ul style="list-style-type: none"> true false 						

Related Topics

For more information on...	See...
Health Care Inbound Message Schema	Health Care Inbound Message Schema on page 2135
Sample Health Care Inbound Message for Fully-Insured Group Customer Setup	Sample Health Care Inbound Message for Fully-Insured Group Customer Setup on page 2142
Sample Health Care Inbound Message for Membership	Sample Health Care Inbound Message for Membership on page 2223
Sample Health Care Inbound Message for Pricing Rules	Sample Health Care Inbound Message for Pricing Rules on page 2205

For more information on...	See...
Sample Health Care Inbound Message for Self-Funded Customer Setup	Sample Health Care Inbound Message for Self-Funded Customer Setup on page 2180
How to setup the C1-ASOBLNG feature configuration	Setting the C1-ASOBLNG Feature Configuration on page 3421

Health Care Inbound Message Schema

The following code snippet illustrates how the tags are nested in the health care inbound message schema:

```
<schema>
  <clInboundMessage></clInboundMessage>
  <bo></bo>
  <boStatus></boStatus>
  <statusReason></statusReason>
  <messageType></messageType>
  <sourceSystem></sourceSystem>
  <externalTransactionId></externalTransactionId>
  <externalBatchId></externalBatchId>
  <externalSourceId></externalSourceId>
  <person></person>
  <statusDateTime></statusDateTime>
  <creationDateTime></creationDateTime>
  <version></version>
  <characteristics>
    <inboundMessageCharacteristic>
      <adhocCharacteristicValue></adhocCharacteristicValue>
      <characteristicType></characteristicType>
      <effectiveDate></effectiveDate>
      <characteristicValue></characteristicValue>
      <characteristicValueForeignKey1></characteristicValueForeignKey1>
      <characteristicValueFK2></characteristicValueFK2>
      <characteristicValueFK3></characteristicValueFK3>
      <characteristicValueFK4></characteristicValueFK4>
      <characteristicValueFK5></characteristicValueFK5>
      <searchCharacteristicValue></searchCharacteristicValue>
      <version></version>
    </inboundMessageCharacteristic>
  </characteristics>
  <customerStructureMessage>
    <headerData>
      <messageType></messageType>
      <sourceSystem></sourceSystem>
      <externalTransactionId></externalTransactionId>
      <externalBatchId></externalBatchId>
      <externalSourceId></externalSourceId>
    </headerData>
    <customerStructureData>
      <personData>
        <sequence></sequence>
        <personType></personType>
        <personName>
          <sequence></sequence>
          <entityName></entityName>
          <nameType></nameType>
        </personName>
        <identifiers>
          <idType></idType>
          <idValue></idValue>
        </identifiers>
      </personData>
    </customerStructureData>
  </customerStructureMessage>
</schema>
```

```

    <isPrimary></isPrimary>
  </identifiers>
  <division></division>
  <birthDate></birthDate>
  <sinceDate></sinceDate>
  <address>
    <addressEffDate></addressEffDate>
    <addressType></addressType>
    <mailingName></mailingName>
    <address1></address1>
    <address2></address2>
    <address3></address3>
    <address4></address4>
    <city></city>
    <state></state>
    <zip></zip>
    <country></country>
    <houseType></houseType>
    <streetNumber1></streetNumber1>
    <streetNumber2></streetNumber2>
    <inCityLimit></inCityLimit>
    <taxVendorGeographicalCode></taxVendorGeographicalCode>
    <county></county>
  </address>
  <email></email>
  <overrideMailingName1></overrideMailingName1>
  <overrideMailingName2></overrideMailingName2>
  <overrideMailingName3></overrideMailingName3>
  <phones>
    <phoneType></phoneType>
    <phoneValue></phoneValue>
    <extension></extension>
  </phones>
  <relatedPersons>
    <idType></idType>
    <idValue></idValue>
    <personRelationshipType></personRelationshipType>
    <startDate></startDate>
    <endDate></endDate>
    <financialRelationshipSw></financialRelationshipSw>
    <parentOrChild></parentOrChild>
    <characteristics>
      <characteristicsList>
        <characteristicType></characteristicType>
        <characteristicValue></characteristicValue>
        <effectiveDate></effectiveDate>
      </characteristicsList>
    </characteristics>
  </relatedPersons>
  <characteristics>
    <characteristicsList>
      <characteristicType></characteristicType>
      <characteristicValue></characteristicValue>
      <effectiveDate></effectiveDate>
    </characteristicsList>
  </characteristics>
  <billLevelParameters>
    <sequence></sequence>
    <sourceSystem></sourceSystem>
    <billLevelInfo1></billLevelInfo1>
    <billLevelInfo2></billLevelInfo2>
    <billLevelInfo3></billLevelInfo3>
    <billLevelInfo4></billLevelInfo4>
    <effectiveDate></effectiveDate>
  </billLevelParameters>

```

```

</billLevelParameters>
<memberData>
  <startDate></startDate>
  <endDate></endDate>
  <paidThroughDate></paidThroughDate>
  <memberId></memberId>
  <memberRelationship></memberRelationship>
  <membershipPersonStatus></membershipPersonStatus>
  <membershipPersonstatusReason></membershipPersonstatusReason>
  <autoRenew></autoRenew>
<associatedMemberIdentifierType></associatedMemberIdentifierType>
<associatedMemberIdentifier></associatedMemberIdentifier>
<exchangeFlag></exchangeFlag>
<exchangeId></exchangeId>
<binderLiabilityAmount></binderLiabilityAmount>
<binderPayApplicability></binderPayApplicability>
<binderPayGraceDays></binderPayGraceDays>
<binderPayThreshold></binderPayThreshold>
<holdBilling></holdBilling>
<membershipRenewalDate></membershipRenewalDate>
<contractPeriod></contractPeriod>
<membershipIdentifier>
  <membershipIdentifierType></membershipIdentifierType>
  <membershipIdentifierValue></membershipIdentifierValue>
</membershipIdentifier>
<isMemberSw></isMemberSw>
<isFinanciallyResponsibleSw></isFinanciallyResponsibleSw>
<membershipType></membershipType>
<externalMedicareBeneficiaryId></externalMedicareBeneficiaryId>
<mainSubscriber>
  <idType></idType>
  <idValue></idValue>
  <membershipType></membershipType>
</mainSubscriber>
<policyNumber></policyNumber>
<sourceSystem></sourceSystem>
<planNumber></planNumber>
<healthPlanCode></healthPlanCode>
<characteristics>
  <characteristicsList>
    <characteristicType></characteristicType>
    <characteristicValue></characteristicValue>
    <effectiveDate></effectiveDate>
  </characteristicsList>
</characteristics>
<membershipRateGuarantee>
  <membershipRateGuaranteeList>
    <rateGuaranteeStartDate></rateGuaranteeStartDate>
    <rateGuaranteeEndDate></rateGuaranteeEndDate>
    <rateGuaranteeStatus></rateGuaranteeStatus>
  </membershipRateGuaranteeList>
</membershipRateGuarantee>
<membershipPersonCharacteristic>
  <characteristicsList>
    <characteristicType></characteristicType>
    <characteristicValue></characteristicValue>
    <effectiveDate></effectiveDate>
  </characteristicsList>
</membershipPersonCharacteristic>
<benefitData>
  <benefitDataList>
    <sequence></sequence>
    <startDate></startDate>
    <endDate></endDate>

```

```

        <benefitStatus></benefitStatus>
        <benefitSourceFlag></benefitSourceFlag>
        <benefitTypeFlag></benefitTypeFlag>
        <benefitSubTypeFlag></benefitSubTypeFlag>
        <planBenefitPackageId></planBenefitPackageId>
        <benefitAmount></benefitAmount>
        <characteristics>
            <characteristicsList>
                <characteristicType></characteristicType>
                <characteristicValue></characteristicValue>
                <effectiveDate></effectiveDate>
            </characteristicsList>
        </characteristics>
    </benefitDataList>
</benefitData>
<billableChargeData>
    <sequence></sequence>
    <accountIdType></accountIdType>
    <accountIdValue></accountIdValue>
    <chargeType></chargeType>
    <startDate></startDate>
    <endDate></endDate>
    <priceItemCode></priceItemCode>
    <description></description>
    <recurringMethod></recurringMethod>
    <billPeriod></billPeriod>
    <frequency></frequency>
    <billAfterDt></billAfterDt>
    <billableChargeLines>
        <descriptionOnBill></descriptionOnBill>
        <currencyCode></currencyCode>
        <chargeAmount></chargeAmount>
        <showOnBillSw></showOnBillSw>
        <appearInSummarySw></appearInSummarySw>
        <distributionCode></distributionCode>
    </billableChargeLines>
    <characteristics>
        <characteristicsList>
            <characteristicType></characteristicType>
            <characteristicValue></characteristicValue>
            <effectiveDate></effectiveDate>
        </characteristicsList>
    </characteristics>
</billableChargeData>
</memberData>
<accountData>
    <accountType></accountType>
    <customerClass></customerClass>
    <billCycle></billCycle>
    <billLeadDays></billLeadDays>
    <division></division>
    <currency></currency>
    <setUpDate></setUpDate>
    <acctUsageFlg></acctUsageFlg>
    <comments></comments>
    <deferAutoPayDt></deferAutoPayDt>
    <collectionClass></collectionClass>
    <billRouteType></billRouteType>
    <billAddressSource></billAddressSource>
    <identifiers>
        <idType></idType>
        <idValue></idValue>
        <isPrimary></isPrimary>
    </identifiers>

```

```

<address>
  <addressEffDate></addressEffDate>
  <addressType></addressType>
  <address1></address1>
  <address2></address2>
  <address3></address3>
  <address4></address4>
  <city></city>
  <state></state>
  <zip></zip>
  <country></country>
  <houseType></houseType>
  <streetNumber1></streetNumber1>
  <streetNumber2></streetNumber2>
  <inCityLimit></inCityLimit>
  <taxVendorGeographicalCode></taxVendorGeographicalCode>
  <county></county>
</address>
<autoPayDetails>
  <priority></priority>
  <startDate></startDate>
  <endDate></endDate>
  <percentage></percentage>
  <autoPayMethod></autoPayMethod>
  <autoPayRouteType></autoPayRouteType>
  <autoPaySourceCode></autoPaySourceCode>
  <accountNumber></accountNumber>
  <expiryMonth></expiryMonth>
  <expiryYear></expiryYear>
  <name></name>
  <maxWithdrawalAmount></maxWithdrawalAmount>
  <comments></comments>
</autoPayDetails>
<accountPerson>
  <idType></idType>
  <idValue></idValue>
  <accountRelationshipType></accountRelationshipType>
  <isFinanciallyResponsible></isFinanciallyResponsible>
  <personAddressOverride>
    <address1></address1>
    <address2></address2>
    <address3></address3>
    <address4></address4>
    <city></city>
    <postal></postal>
    <state></state>
    <country></country>
    <houseType></houseType>
    <streetNumber1></streetNumber1>
    <streetNumber2></streetNumber2>
    <inCityLimit></inCityLimit>
  <taxVendorGeographicalCode></taxVendorGeographicalCode>
  <county></county>
</personAddressOverride>
  <accountPersonRouting>
    <billRouteType></billRouteType>
    <shouldReceiveCopyOfBill></shouldReceiveCopyOfBill>
    <billFormat></billFormat>
    <numberOfBillCopies></numberOfBillCopies>
    <receivesNotification></receivesNotification>
    <billAddressSource></billAddressSource>
  </accountPersonRouting>
</accountPerson>
<characteristics>

```

```

        <characteristicsList>
            <characteristicType></characteristicType>
            <characteristicValue></characteristicValue>
            <effectiveDate></effectiveDate>
        </characteristicsList>
    </characteristics>
</accountData>
<policyData>
    <policyType></policyType>
    <sourceSystem></sourceSystem>
    <policyNumber></policyNumber>
    <description></description>
    <advancedLevelFundingEligibility></
advancedLevelFundingEligibility>
    <startDate></startDate>
    <endDate></endDate>
    <runOutEndDate></runOutEndDate>
    <runOutAdminOption></runOutAdminOption>
    <renewalDate></renewalDate>
    <policyPersons>
        <idType></idType>
        <idValue></idValue>
        <policyPerRole></policyPerRole>
        <startDate></startDate>
        <endDate></endDate>
    </policyPersons>
    <terminationInformation>
        <terminateDate></terminateDate>
        <terminationReason></terminationReason>
    </terminationInformation>
    <reinstateInformation>
        <reinstatementDate></reinstatementDate>
        <reinstateReason></reinstateReason>
    </reinstateInformation>
    <characteristics>
        <characteristicsList>
            <characteristicType></characteristicType>
            <characteristicValue></characteristicValue>
            <effectiveDate></effectiveDate>
        </characteristicsList>
    </characteristics>
<planData>
    <planNumber></planNumber>
    <priceItemCode></priceItemCode>
    <planName></planName>
    <pricingRuleTypeList>
        <pricingRuleType></pricingRuleType>
    </pricingRuleTypeList>
    <startDate></startDate>
    <endDate></endDate>
    <primaryPlanSw></primaryPlanSw>
    <benefitTypeFlag></benefitTypeFlag>
    <characteristics>
        <characteristicsList>
            <characteristicType></characteristicType>
            <characteristicValue></characteristicValue>
            <effectiveDate></effectiveDate>
        </characteristicsList>
    </characteristics>
    <policyPlanProrationRuleList>
        <effectiveDate></effectiveDate>
        <prorationEventType></prorationEventType>
        <prorationType></prorationType>
        <numberOfDays></numberOfDays>

```



```

        <membershipType></membershipType>
      </policyPlanProrationRuleList>
    </planData>
  </policyData>
</personData>
<pricingRuleData>
  <sequence></sequence>
  <entityIdentifiers>
    <entityIdentifiersList>
      <entityIdentifierType></entityIdentifierType>
      <entityIdentifierValue></entityIdentifierValue>
    </entityIdentifiersList>
  </entityIdentifiers>
  <status></status>
  <startDate></startDate>
  <endDate></endDate>
  <pricingRuleType></pricingRuleType>
  <priceItemCd></priceItemCd>
  <rateOption></rateOption>
  <pricingType></pricingType>
  <modifierApplicability></modifierApplicability>
  <modifierMethod></modifierMethod>
  <baseRate>
    <sequence></sequence>
    <baseFee></baseFee>
    <lowerAgeLimit></lowerAgeLimit>
    <upperAgeLimit></upperAgeLimit>
    <pricingParameter>
      <sequence></sequence>
      <parameterCode></parameterCode>
      <parameterValue></parameterValue>
    </pricingParameter>
    <modifierInformation>
      <sequence></sequence>
      <parameterCode></parameterCode>
      <parameterValue></parameterValue>
      <rate></rate>
    </modifierInformation>
  </baseRate>
  <characteristics>
    <characteristicsList>
      <characteristicType></characteristicType>
      <characteristicValue></characteristicValue>
      <effectiveDate></effectiveDate>
    </characteristicsList>
  </characteristics>
</pricingRuleData>
<statementConstructsData>
  <personStatementConstructs>
    <personIdentifier></personIdentifier>
    <personIdentifierType></personIdentifierType>
    <statementConstructIdentifier></statementConstructIdentifier>
    <statementAddressSource></statementAddressSource>
    <statementCycle></statementCycle>
    <statementRouteType></statementRouteType>
    <effectiveStatus></effectiveStatus>
    <addressId></addressId>
    <numberOfCopies></numberOfCopies>
    <statementFormat></statementFormat>
    <description></description>
    <statementConstructDetails>
      <serviceAgreement></serviceAgreement>
      <accountNumber></accountNumber>
      <accountNumberTypeCd></accountNumberTypeCd>
    </statementConstructDetails>
  </personStatementConstructs>

```

```

        <division></division>
        <statementPrintDescription></statementPrintDescription>
        <printOrder></printOrder>
        <startDate></startDate>
        <endDate></endDate>
    </statementConstructDetails>
    <characteristicsList>
        <characteristicType></characteristicType>
        <characteristicValue></characteristicValue>
        <effectiveDate></effectiveDate>
    </characteristicsList>
    </personStatementConstructs>
</statementConstructsData>
</customerStructureData>
</customerStructureMessage>
<toDoRetry>
    <retryDateTime></retryDateTime>
    <numberOfRetries></numberOfRetries>
    <currentErrorState></currentErrorState>
    <isRetried></isRetried>
</toDoRetry>
</schema>

```

Sample Health Care Inbound Message for Fully-Insured Group Customer Setup

Using the below example, you can do the following:

- Create the parent customer and bill groups for a fully-insured group health insurance business
- Create policies where the policy category is set to **Fully-Insured Group**
- Create various medical and dental plans for active and retired employees in the fully-insured group policies
- Associate a pricing rule type with the policy plans

Person Name	Person Type	Account	Policy	Policy Plan	Pricing Rule Type
Antartica Petroleum Corp	Parent Customer	-	Active Employee Medical Health Insurance Policy	HMO Medical Bronze 60 AE	AGE_BASED
				HMO Medical Silver 70 AE	AGE_BASED
				HMO Medical Gold 80 AE	AGE_BASED
				HMO Medical Platinum 90 AE	AGE_BASED
				PPO Medical Bronze 60 AE	AGE_BASED
				PPO Medical Silver 70 AE	AGE_BASED

Person Name	Person Type	Account	Policy	Policy Plan	Pricing Rule Type
				PPO Medical Gold 80 AE	AGE_BASED
				PPO Medical Platinum 90 AE	AGE_BASED
			Active Employee Dental Health Insurance Policy	DD BASIC PLAN AE	TIER_BASED
				DD STANDARD PLAN AE	TIER_BASED
			Retiree Employee Health Insurance Policy	HMO Medical Bronze 60 RE	AGE_BASED
				HMO Medical Silver 70 RE	AGE_BASED
				PPO Medical Bronze 60 RE	AGE_BASED
				PPO Medical Silver 70 RE	AGE_BASED
				DD BASIC RE	TIER_BASED
Antartica Petroleum ACTIVE	Bill Group	CMS	-	-	-
		CMR			
Antartica Petroleum COBRA	Bill Group	CMS	-	-	-
		CMR			
Antartica Petroleum RETIREE	Bill Group	CMS	Employee Medicare Policy	APE Medicare Bronze RE MALE	AGE_BASED
		CMR		APE Medicare Silver RE MALE	AGE_BASED
				APE Medicare Gold RE MALE	AGE_BASED

Person Name	Person Type	Account	Policy	Policy Plan	Pricing Rule Type
				APE Medicare Bronze RE FEMALE	AGE_BASED
				APE Medicare Silver RE FEMALE	AGE_BASED
				APE Medicare Gold RE FEMALE	AGE_BASED

In addition, using the below example, you can create the following derivation and pricing parameters for the above three bill groups:

Bill Group	Source System	Parameter 1	Parameter 2	Parameter 3	Parameter 4
Antartica Petroleum ACTIVE	SMALLPRIME	ACTIVE	SEATTLE	MEDICAL	HMO
	SMALLPRIME	ACTIVE	SEATTLE	MEDICAL	PPO
	SMALLPRIME	ACTIVE	SEATTLE	DENTAL	HMO
	SMALLPRIME	ACTIVE	SEATTLE	DENTAL	PPO
	SMALLPRIME	ACTIVE	SAN FRANCISCO	MEDICAL	HMO
	SMALLPRIME	ACTIVE	SAN FRANCISCO	MEDICAL	PPO
	SMALLPRIME	ACTIVE	SAN FRANCISCO	DENTAL	HMO
	SMALLPRIME	ACTIVE	SAN FRANCISCO	DENTAL	PPO
	SMALLPRIME	ACTIVE	LOS ANGELES	MEDICAL	HMO
	SMALLPRIME	ACTIVE	LOS ANGELES	MEDICAL	PPO
	SMALLPRIME	ACTIVE	LOS ANGELES	DENTAL	HMO
	SMALLPRIME	ACTIVE	LOS ANGELES	DENTAL	PPO

Bill Group	Source System	Parameter 1	Parameter 2	Parameter 3	Parameter 4
Antartica Petroleum COBRA	SMALLPRIME	COBRA	SEATTLE	MEDICAL	HMO
	SMALLPRIME	COBRA	SEATTLE	MEDICAL	PPO
	SMALLPRIME	COBRA	SEATTLE	DENTAL	HMO
	SMALLPRIME	COBRA	SEATTLE	DENTAL	PPO
	SMALLPRIME	COBRA	SAN FRANCISCO	MEDICAL	HMO
	SMALLPRIME	COBRA	SAN FRANCISCO	MEDICAL	PPO
	SMALLPRIME	COBRA	SAN FRANCISCO	DENTAL	HMO
	SMALLPRIME	COBRA	SAN FRANCISCO	DENTAL	PPO
	SMALLPRIME	COBRA	LOS ANGELES	MEDICAL	HMO
	SMALLPRIME	COBRA	LOS ANGELES	MEDICAL	PPO
	SMALLPRIME	COBRA	LOS ANGELES	DENTAL	HMO
	SMALLPRIME	COBRA	LOS ANGELES	DENTAL	PPO
Antartica Petroleum RETIREE	SMALLPRIME	RETIRED	SEATTLE	MEDICAL	HMO
	SMALLPRIME	RETIRED	SEATTLE	MEDICAL	PPO
	SMALLPRIME	RETIRED	SEATTLE	DENTAL	HMO
	SMALLPRIME	RETIRED	SEATTLE	DENTAL	PPO
	SMALLPRIME	RETIRED	SAN FRANCISCO	MEDICAL	HMO
	SMALLPRIME	RETIRED	SAN FRANCISCO	MEDICAL	PPO
	SMALLPRIME	RETIRED	SAN FRANCISCO	DENTAL	HMO
	SMALLPRIME	RETIRED	SAN FRANCISCO	DENTAL	PPO
	SMALLPRIME	RETIRED	LOS ANGELES	MEDICAL	HMO

Bill Group	Source System	Parameter 1	Parameter 2	Parameter 3	Parameter 4
	SMALLPRIME	RETIRED	LOS ANGELES	MEDICAL	PPO
	SMALLPRIME	RETIRED	LOS ANGELES	DENTAL	HMO
	SMALLPRIME	RETIRED	LOS ANGELES	DENTAL	PPO

```

<schema>
  <bo>C1-HCInboundMessage</bo>
  <characteristics>
    <inboundMessageCharacteristic>
      <adhocCharacteristicValue></adhocCharacteristicValue>
      <characteristicType>C1-EXTBTCT</characteristicType>
      <effectiveDate>2019-01-01</effectiveDate>
      <characteristicValue>DATAEXT1</characteristicValue>
      <characteristicValueForeignKey1></characteristicValueForeignKey1>
      <characteristicValueFK2></characteristicValueFK2>
      <characteristicValueFK3></characteristicValueFK3>
      <characteristicValueFK4></characteristicValueFK4>
      <characteristicValueFK5></characteristicValueFK5>
    </inboundMessageCharacteristic>
  </characteristics>
  <customerStructureMessage>
    <headerData>
      <messageType>C1-HEALTHCARE-INB-MSG-TYPE</messageType>
      <sourceSystem>SMALLPRIME</sourceSystem>
      <externalTransactionId>889977</externalTransactionId>
      <externalBatchId>565656</externalBatchId>
      <externalSourceId>656565</externalSourceId>
    </headerData>
    <customerStructureData>
      <personData>
        <sequence>1</sequence>
        <personType>PG</personType>
        <personName>
          <sequence>1</sequence>
          <entityName>Antartica Petroleum Corp</entityName>
          <nameType>PRIM</nameType>
        </personName>
        <identifiers>
          <idType>EIN</idType>
          <idValue>98-7654329</idValue>
          <isPrimary>Y</isPrimary>
        </identifiers>
        <division>HC</division>
        <birthDate>1980-03-24</birthDate>
        <sinceDate>2019-01-01</sinceDate>
        <address>
          <addressEffDate>2019-01-01</addressEffDate>
          <addressType>MAIN</addressType>
          <mailingName>Antartica Petroleum Corp</mailingName>
          <address1>Saturn Park</address1>
          <address2>Saturn Street</address2>
          <address3>River Side</address3>
          <address4></address4>
          <city>San Francisco</city>
          <state>CA</state>
        </address>
      </personData>
    </customerStructureData>
  </customerStructureMessage>
</schema>

```

```

        <zip>94122</zip>
        <country>USA</country>
        <houseType></houseType>
        <streetNumber1></streetNumber1>
        <streetNumber2></streetNumber2>
        <inCityLimit></inCityLimit>
        <taxVendorGeographicalCode></taxVendorGeographicalCode>
        <county></county>
    </address>
    <email>apc@example.com</email>
    <overrideMailingName1>Antartica Petroleum Corporation</
overrideMailingName1>
    <overrideMailingName2></overrideMailingName2>
    <overrideMailingName3></overrideMailingName3>
    <phones>
        <phoneType>BUSN</phoneType>
        <phoneValue>415-555-0100</phoneValue>
    </phones>
    <relatedPersons>
        <idType></idType>
        <idValue></idValue>
        <personRelationshipType></personRelationshipType>
        <startDate></startDate>
        <endDate></endDate>
        <financialRelationshipSw></financialRelationshipSw>
        <parentOrChild></parentOrChild>
        <characteristics>
            <characteristicsList>
                <characteristicType></characteristicType>
                <characteristicValue></characteristicValue>
                <effectiveDate></effectiveDate>
            </characteristicsList>
        </characteristics>
    </relatedPersons>
    <characteristics>
        <characteristicsList>
            <characteristicType>PER_CAT</characteristicType>
            <characteristicValue>EMPOLYER</characteristicValue>
            <effectiveDate>2019-01-01</effectiveDate>
        </characteristicsList>
    </characteristics>
    <billLevelParameters>
        <sequence></sequence>
        <sourceSystem></sourceSystem>
        <billLevelInfo1></billLevelInfo1>
        <billLevelInfo2></billLevelInfo2>
        <billLevelInfo3></billLevelInfo3>
        <billLevelInfo4></billLevelInfo4>
        <effectiveDate></effectiveDate>
    </billLevelParameters>
    <memberData>
        <startDate></startDate>
        <endDate></endDate>
        <paidThroughDate></paidThroughDate>
        <memberId></memberId>
        <memberRelationship></memberRelationship>
        <membershipPersonStatus></membershipPersonStatus>
        <membershipPersonstatusReason></
membershipPersonstatusReason>
        <autoRenew></autoRenew>
        <associatedMemberIdentifierType></
associatedMemberIdentifierType>
        <associatedMemberIdentifier></associatedMemberIdentifier>
        <exchangeFlag></exchangeFlag>

```

```

    <exchangeId></exchangeId>
    <binderLiabilityAmount></binderLiabilityAmount>
    <binderPayApplicability></binderPayApplicability>
    <binderPayGraceDays></binderPayGraceDays>
    <binderPayThreshold></binderPayThreshold>
    <holdBilling></holdBilling>
    <membershipRenewalDate></membershipRenewalDate>
    <contractPeriod></contractPeriod>
    <membershipIdentifier>
      <membershipIdentifierType></membershipIdentifierType>
      <membershipIdentifierValue></
membershipIdentifierValue>
    </membershipIdentifier>
    <isMemberSw></isMemberSw>
    <isFinanciallyResponsibleSw></isFinanciallyResponsibleSw>
    <membershipType></membershipType>
    <externalMedicareBeneficiaryId></
externalMedicareBeneficiaryId>
    <mainSubscriber>
      <idType></idType>
      <idValue></idValue>
      <membershipType></membershipType>
    </mainSubscriber>
    <policyNumber></policyNumber>
    <sourceSystem></sourceSystem>
    <planNumber></planNumber>
    <healthPlanCode></healthPlanCode>
    <characteristics>
      <characteristicsList>
        <characteristicType></characteristicType>
        <characteristicValue></characteristicValue>
        <effectiveDate></effectiveDate>
      </characteristicsList>
    </characteristics>
    <membershipRateGuarantee>
      <membershipRateGuaranteeList>
        <rateGuaranteeStartDate></rateGuaranteeStartDate>
        <rateGuaranteeEndDate></rateGuaranteeEndDate>
        <rateGuaranteeStatus></rateGuaranteeStatus>
      </membershipRateGuaranteeList>
    </membershipRateGuarantee>
    <membershipPersonCharacteristic>
      <characteristicsList>
        <characteristicType></characteristicType>
        <characteristicValue></characteristicValue>
        <effectiveDate></effectiveDate>
      </characteristicsList>
      <characteristicsList>
        <characteristicType></characteristicType>
        <characteristicValue></characteristicValue>
        <effectiveDate></effectiveDate>
      </characteristicsList>
    </membershipPersonCharacteristic>
    <benefitData>
      <benefitDataList>
        <sequence></sequence>
        <startDate></startDate>
        <endDate></endDate>
        <benefitStatus></benefitStatus>
        <benefitSourceFlag></benefitSourceFlag>
        <benefitTypeFlag></benefitTypeFlag>
        <benefitSubTypeFlag></benefitSubTypeFlag>
        <planBenefitPackageId></planBenefitPackageId>
        <benefitAmount></benefitAmount>

```



```

        <characteristics>
            <characteristicsList>
                <characteristicType></characteristicType>
                <characteristicValue></
characteristicValue>
                    <effectiveDate></effectiveDate>
                </characteristicsList>
            </characteristics>
        </benefitDataList>
    </benefitData>
    <billableChargeData>
        <sequence></sequence>
        <accountIdType></accountIdType>
        <accountIdValue></accountIdValue>
        <chargeType></chargeType>
        <startDate></startDate>
        <endDate></endDate>
        <priceItemCode></priceItemCode>
        <description></description>
        <recurringMethod></recurringMethod>
        <billPeriod></billPeriod>
        <frequency></frequency>
        <billAfterDt></billAfterDt>
        <billableChargeLines>
            <descriptionOnBill></descriptionOnBill>
            <currencyCode></currencyCode>
            <chargeAmount></chargeAmount>
            <showOnBillSw></showOnBillSw>
            <appearInSummarySw></appearInSummarySw>
            <distributionCode></distributionCode>
        </billableChargeLines>
        <characteristics>
            <characteristicsList>
                <characteristicType></characteristicType>
                <characteristicValue></characteristicValue>
                <effectiveDate></effectiveDate>
            </characteristicsList>
        </characteristics>
    </billableChargeData>
</memberData>
<accountData>
    <accountType></accountType>
    <customerClass></customerClass>
    <billCycle></billCycle>
    <billLeadDays></billLeadDays>
    <division></division>
    <currency></currency>
    <setUpDate></setUpDate>
    <acctUsageFlg></acctUsageFlg>
    <comments></comments>
    <deferAutoPayDt></deferAutoPayDt>
    <collectionClass></collectionClass>
    <billRouteType></billRouteType>
    <billAddressSource></billAddressSource>
    <identifiers>
        <idType></idType>
        <idValue></idValue>
        <isPrimary></isPrimary>
    </identifiers>
    <address>
        <addressEffDate></addressEffDate>
        <addressType></addressType>
        <address1></address1>
        <address2></address2>

```

```

        <address3></address3>
        <address4></address4>
        <city></city>
        <state></state>
        <zip></zip>
        <country></country>
        <houseType></houseType>
        <streetNumber1></streetNumber1>
        <streetNumber2></streetNumber2>
        <inCityLimit></inCityLimit>
        <taxVendorGeographicalCode></
taxVendorGeographicalCode>
        <county></county>
    </address>
    <autoPayDetails>
        <priority></priority>
        <startDate></startDate>
        <endDate></endDate>
        <percentage></percentage>
        <autoPayMethod></autoPayMethod>
        <autoPayRouteType></autoPayRouteType>
        <autoPaySourceCode></autoPaySourceCode>
        <accountNumber></accountNumber>
        <expiryMonth></expiryMonth>
        <expiryYear></expiryYear>
        <name></name>
        <maxWithdrawalAmount></maxWithdrawalAmount>
        <comments></comments>
    </autoPayDetails>
    <accountPerson>
        <idType></idType>
        <idValue></idValue>
        <accountRelationshipType></accountRelationshipType>
        <isFinanciallyResponsible></isFinanciallyResponsible>
        <personAddressOverride>
            <address1></address1>
            <address2></address2>
            <address3></address3>
            <address4></address4>
            <city></city>
            <postal></postal>
            <state></state>
            <country></country>
            <houseType></houseType>
            <streetNumber1></streetNumber1>
            <streetNumber2></streetNumber2>
            <inCityLimit></inCityLimit>
            <taxVendorGeographicalCode></
taxVendorGeographicalCode>
            <county></county>
        </personAddressOverride>
        <accountPersonRouting>
            <billRouteType></billRouteType>
            <shouldReceiveCopyOfBill></
shouldReceiveCopyOfBill>
            <billFormat></billFormat>
            <numberOfBillCopies></numberOfBillCopies>
            <receivesNotification></receivesNotification>
            <billAddressSource></billAddressSource>
        </accountPersonRouting>
    </accountPerson>
    <characteristics>
        <characteristicsList>
            <characteristicType></characteristicType>

```

```

                <characteristicValue></characteristicValue>
                <effectiveDate></effectiveDate>
            </characteristicsList>
        </characteristics>
    </accountData>
    <policyData>
        <policyType>GROUP CUSTOMER</policyType>
        <sourceSystem>SMALLPRIME</sourceSystem>
        <policyNumber>AP234356</policyNumber>
        <description>Active Employee Medical Health Insurance
Policy</description>
        <advancedLevelFundingEligibility></
advancedLevelFundingEligibility>
        <startDate>2019-01-01</startDate>
        <endDate>2019-12-31</endDate>
        <policyPersons>
            <idType></idType>
            <idValue></idValue>
            <policyPerRole></policyPerRole>
            <startDate></startDate>
            <endDate></endDate>
        </policyPersons>
        <terminationInformation>
            <terminateDate></terminateDate>
            <terminationReason></terminationReason>
        </terminationInformation>
        <reinstateInformation>
            <reinstatementDate></reinstatementDate>
            <reinstateReason></reinstateReason>
        </reinstateInformation>
        <characteristics>
            <characteristicsList>
                <characteristicType>C1PRBASE</characteristicType>
                <characteristicValue>Y</characteristicValue>
                <effectiveDate>2019-01-01</effectiveDate>
            </characteristicsList>
            <characteristicsList>
                <characteristicType>C1STISSE</characteristicType>
                <characteristicValue>VG</characteristicValue>
                <effectiveDate>2019-01-01</effectiveDate>
            </characteristicsList>
        </characteristics>
        <planData>
            <planNumber>HMO_MED_BRONZE</planNumber>
            <priceItemCode></priceItemCode>
            <planName>HMO Medical Bronze 60 AE</planName>
            <pricingRuleTypeList>
                <pricingRuleType>AGE_BASED</pricingRuleType>
            </pricingRuleTypeList>
            <startDate>2019-01-01</startDate>
            <endDate>2019-12-31</endDate>
            <primaryPlanSw>N</primaryPlanSw>
            <benefitTypeFlag></benefitTypeFlag>
            <characteristics>
                <characteristicsList>
                    <characteristicType>C1HPLNID</
characteristicType>
                    <characteristicValue>010</characteristicValue>
                    <effectiveDate>2019-01-01</effectiveDate>
                </characteristicsList>
            </characteristics>
            <policyPlanProrationRuleList>
                <effectiveDate></effectiveDate>
                <prorationEventType></prorationEventType>

```

```

        <prorationType></prorationType>
        <numberOfDays></numberOfDays>
        <membershipType></membershipType>
    </policyPlanProrationRuleList>
</planData>
<planData>
    <planNumber>HMO_MED_SILVER</planNumber>
    <priceItemCode></priceItemCode>
    <planName>HMO Medical Silver 70 AE</planName>
    <pricingRuleTypeList>
        <pricingRuleType>AGE_BASED</pricingRuleType>
    </pricingRuleTypeList>
    <startDate>2019-01-01</startDate>
    <endDate>2019-12-31</endDate>
    <primaryPlanSw>N</primaryPlanSw>
    <characteristics>
        <characteristicsList>
            <characteristicType>C1HPLNID</
characteristicType>
                <characteristicValue>020</characteristicValue>
                <effectiveDate>2019-01-01</effectiveDate>
            </characteristicsList>
        </characteristics>
        <policyPlanProrationRuleList>
            <effectiveDate></effectiveDate>
            <prorationEventType></prorationEventType>
            <prorationType></prorationType>
            <numberOfDays></numberOfDays>
            <membershipType></membershipType>
        </policyPlanProrationRuleList>
    </planData>
<planData>
    <planNumber>HMO_MED_GOLD</planNumber>
    <priceItemCode></priceItemCode>
    <planName>HMO Medical Gold 80 AE</planName>
    <pricingRuleTypeList>
        <pricingRuleType>AGE_BASED</pricingRuleType>
    </pricingRuleTypeList>
    <startDate>2019-01-01</startDate>
    <endDate>2019-12-31</endDate>
    <primaryPlanSw>N</primaryPlanSw>
    <characteristics>
        <characteristicsList>
            <characteristicType>C1HPLNID</
characteristicType>
                <characteristicValue>030</characteristicValue>
                <effectiveDate>2019-01-01</effectiveDate>
            </characteristicsList>
        </characteristics>
        <policyPlanProrationRuleList>
            <effectiveDate></effectiveDate>
            <prorationEventType></prorationEventType>
            <prorationType></prorationType>
            <numberOfDays></numberOfDays>
            <membershipType></membershipType>
        </policyPlanProrationRuleList>
    </planData>
<planData>
    <planNumber>HMO_MED_PLATINUM</planNumber>
    <priceItemCode></priceItemCode>
    <planName>HMO Medical Platinum 90 AE</planName>
    <pricingRuleTypeList>
        <pricingRuleType>AGE_BASED</pricingRuleType>
    </pricingRuleTypeList>

```

```

        <startDate>2019-01-01</startDate>
        <endDate>2019-12-31</endDate>
        <primaryPlanSw>N</primaryPlanSw>
        <characteristics>
            <characteristicsList>
                <characteristicType>C1HPLNID</
characteristicType>
                    <characteristicValue>040</characteristicValue>
                    <effectiveDate>2019-01-01</effectiveDate>
                </characteristicsList>
            </characteristics>
            <policyPlanProrationRuleList>
                <effectiveDate></effectiveDate>
                <prorationEventType></prorationEventType>
                <prorationType></prorationType>
                <numberOfDays></numberOfDays>
                <membershipType></membershipType>
            </policyPlanProrationRuleList>
        </planData>
        <planData>
            <planNumber>PPO_MED_BRONZE</planNumber>
            <priceItemCode></priceItemCode>
            <planName>PPO Medical Bronze 60 AE</planName>
            <pricingRuleTypeList>
                <pricingRuleType>AGE_BASED</pricingRuleType>
            </pricingRuleTypeList>
            <startDate>2019-01-01</startDate>
            <endDate>2019-12-31</endDate>
            <primaryPlanSw>N</primaryPlanSw>
            <characteristics>
                <characteristicsList>
                    <characteristicType>C1HPLNID</
characteristicType>
                        <characteristicValue>050</characteristicValue>
                        <effectiveDate>2019-01-01</effectiveDate>
                    </characteristicsList>
                </characteristics>
                <policyPlanProrationRuleList>
                    <effectiveDate></effectiveDate>
                    <prorationEventType></prorationEventType>
                    <prorationType></prorationType>
                    <numberOfDays></numberOfDays>
                    <membershipType></membershipType>
                </policyPlanProrationRuleList>
            </planData>
            <planData>
                <planNumber>PPO_MED_SILVER</planNumber>
                <priceItemCode></priceItemCode>
                <planName>PPO Medical Silver 70 AE</planName>
                <pricingRuleTypeList>
                    <pricingRuleType>AGE_BASED</pricingRuleType>
                </pricingRuleTypeList>
                <startDate>2019-01-01</startDate>
                <endDate>2019-12-31</endDate>
                <primaryPlanSw>N</primaryPlanSw>
                <characteristics>
                    <characteristicsList>
                        <characteristicType>C1HPLNID</
characteristicType>
                            <characteristicValue>060</characteristicValue>
                            <effectiveDate>2019-01-01</effectiveDate>
                        </characteristicsList>
                    </characteristics>
                <policyPlanProrationRuleList>

```

```

        <effectiveDate></effectiveDate>
        <prorationEventType></prorationEventType>
        <prorationType></prorationType>
        <numberOfDays></numberOfDays>
        <membershipType></membershipType>
    </policyPlanProrationRuleList>
</planData>
<planData>
    <planNumber>PPO_MED_GOLD</planNumber>
    <priceItemCode></priceItemCode>
    <planName>PPO Medical Gold 80 AE</planName>
    <pricingRuleTypeList>
        <pricingRuleType>AGE_BASED</pricingRuleType>
    </pricingRuleTypeList>
    <startDate>2019-01-01</startDate>
    <endDate>2019-12-31</endDate>
    <primaryPlanSw>N</primaryPlanSw>
    <characteristics>
        <characteristicsList>
            <characteristicType>ClHPLNID</
characteristicType>
                <characteristicValue>070</characteristicValue>
                <effectiveDate>2019-01-01</effectiveDate>
            </characteristicsList>
        </characteristics>
    <policyPlanProrationRuleList>
        <effectiveDate></effectiveDate>
        <prorationEventType></prorationEventType>
        <prorationType></prorationType>
        <numberOfDays></numberOfDays>
        <membershipType></membershipType>
    </policyPlanProrationRuleList>
</planData>
<planData>
    <planNumber>PPO_MED_PLATINUM</planNumber>
    <priceItemCode></priceItemCode>
    <planName>PPO Medical Platinum 90 AE</planName>
    <pricingRuleTypeList>
        <pricingRuleType>AGE_BASED</pricingRuleType>
    </pricingRuleTypeList>
    <startDate>2019-01-01</startDate>
    <endDate>2019-12-31</endDate>
    <primaryPlanSw>N</primaryPlanSw>
    <characteristics>
        <characteristicsList>
            <characteristicType>ClHPLNID</
characteristicType>
                <characteristicValue>080</characteristicValue>
                <effectiveDate>2019-01-01</effectiveDate>
            </characteristicsList>
        </characteristics>
    <policyPlanProrationRuleList>
        <effectiveDate></effectiveDate>
        <prorationEventType></prorationEventType>
        <prorationType></prorationType>
        <numberOfDays></numberOfDays>
        <membershipType></membershipType>
    </policyPlanProrationRuleList>
</planData>
</policyData>
<policyData>
    <policyType>GROUP CUSTOMER</policyType>
    <sourceSystem>SMALLPRIME</sourceSystem>
    <policyNumber>AP234345</policyNumber>

```

```

<description>Active Employee Dental Health Insurance
Policy</description>
<startDate>2019-01-01</startDate>
<endDate>2019-12-31</endDate>
<policyPersons>
  <idType></idType>
  <idValue></idValue>
  <policyPerRole></policyPerRole>
  <startDate></startDate>
  <endDate></endDate>
</policyPersons>
<terminationInformation>
  <terminatedDate></terminatedDate>
  <terminationReason></terminationReason>
</terminationInformation>
<reinstateInformation>
  <reinstatementDate></reinstatementDate>
  <reinstateReason></reinstateReason>
</reinstateInformation>
<characteristics>
  <characteristicsList>
    <characteristicType>C1PRBASE</characteristicType>
    <characteristicValue>Y</characteristicValue>
    <effectiveDate>2019-01-01</effectiveDate>
  </characteristicsList>
  <characteristicsList>
    <characteristicType>C1STISSE</characteristicType>
    <characteristicValue>VG</characteristicValue>
    <effectiveDate>2019-01-01</effectiveDate>
  </characteristicsList>
  <characteristicsList>
    <characteristicType>C1PRTNRL</characteristicType>
    <characteristicValue>M</characteristicValue>
    <effectiveDate>2019-01-01</effectiveDate>
  </characteristicsList>
</characteristics>
<planData>
  <planNumber>DD_BASIC</planNumber>
  <priceItemCode></priceItemCode>
  <planName>DD BASIC PLAN AE</planName>
  <pricingRuleTypeList>
    <pricingRuleType>TIER_BASED</pricingRuleType>
  </pricingRuleTypeList>
  <startDate>2019-01-01</startDate>
  <endDate>2019-12-31</endDate>
  <primaryPlanSw>N</primaryPlanSw>
  <characteristics>
    <characteristicsList>
      <characteristicType>C1HPLNID</
characteristicType>
      <characteristicValue>090</characteristicValue>
      <effectiveDate>2019-01-01</effectiveDate>
    </characteristicsList>
  </characteristics>
  <policyPlanProrationRuleList>
    <effectiveDate></effectiveDate>
    <prorationEventType></prorationEventType>
    <prorationType></prorationType>
    <numberOfDays></numberOfDays>
    <membershipType></membershipType>
  </policyPlanProrationRuleList>
</planData>
<planData>
  <planNumber>DD_STD</planNumber>

```

```

        <priceItemCode></priceItemCode>
        <planName>DD STANDARD PLAN AE</planName>
        <pricingRuleTypeList>
            <pricingRuleType>TIER_BASED</pricingRuleType>
        </pricingRuleTypeList>
        <startDate>2019-01-01</startDate>
        <endDate>2019-12-31</endDate>
        <primaryPlanSw>N</primaryPlanSw>
        <characteristics>
            <characteristicsList>
                <characteristicType>C1HPLNID</
characteristicType>
                    <characteristicValue>100</characteristicValue>
                    <effectiveDate>2019-01-01</effectiveDate>
                </characteristicsList>
            </characteristics>
            <policyPlanProrationRuleList>
                <effectiveDate></effectiveDate>
                <prorationEventType></prorationEventType>
                <prorationType></prorationType>
                <numberOfDays></numberOfDays>
                <membershipType></membershipType>
            </policyPlanProrationRuleList>
        </planData>
    </policyData>
    <policyData>
        <policyType>GROUP CUSTOMER</policyType>
        <sourceSystem>SMALLPRIME</sourceSystem>
        <policyNumber>AP234389</policyNumber>
        <description>Retiree Employee Health Insurance Policy</
description>
        <advancedLevelFundingEligibility></
advancedLevelFundingEligibility>
        <startDate>2019-01-01</startDate><endDate>2019-12-31</
endDate>
        <policyPersons>
            <idType></idType>
            <idValue></idValue>
            <policyPerRole></policyPerRole>
            <startDate></startDate>
            <endDate></endDate>
        </policyPersons>
        <terminationInformation>
            <terminateDate></terminateDate>
            <terminationReason></terminationReason>
        </terminationInformation>
        <reinstateInformation>
            <reinstatementDate></reinstatementDate>
            <reinstateReason></reinstateReason>
        </reinstateInformation>
        <characteristics>
            <characteristicsList>
                <characteristicType>C1PRBASE</characteristicType>
                <characteristicValue>Y</characteristicValue>
                <effectiveDate>2019-01-01</effectiveDate>
            </characteristicsList>
            <characteristicsList>
                <characteristicType>C1STISSE</characteristicType>
                <characteristicValue>VG</characteristicValue>
                <effectiveDate>2019-01-01</effectiveDate>
            </characteristicsList>
        </characteristics>
    </planData>
    <planNumber>HMO_MED_BRONZE_RETIRED</planNumber>

```



```

        <priceItemCode></priceItemCode>
        <planName>HMO Medical Bronze 60 RE</planName>
        <pricingRuleTypeList>
            <pricingRuleType>AGE_BASED</pricingRuleType>
        </pricingRuleTypeList>
        <startDate>2019-01-01</startDate>
        <endDate>2019-12-31</endDate>
        <primaryPlanSw>N</primaryPlanSw>
        <characteristics>
            <characteristicsList>
                <characteristicType>C1HPLNID</
characteristicType>
                    <characteristicValue>120</characteristicValue>
                    <effectiveDate>2019-01-01</effectiveDate>
                </characteristicsList>
            </characteristics>
        <policyPlanProrationRuleList>
            <effectiveDate></effectiveDate>
            <prorationEventType></prorationEventType>
            <prorationType></prorationType>
            <numberOfDays></numberOfDays>
            <membershipType></membershipType>
        </policyPlanProrationRuleList>
    </planData>
    <planData>
        <planNumber>HMO_MED_SILVER_RETIRED</planNumber>
        <priceItemCode></priceItemCode>
        <planName>HMO Medical Silver 70 RE</planName>
        <pricingRuleTypeList>
            <pricingRuleType>AGE_BASED</pricingRuleType>
        </pricingRuleTypeList>
        <startDate>2019-01-01</startDate>
        <endDate>2019-12-31</endDate>
        <primaryPlanSw>N</primaryPlanSw>
        <characteristics>
            <characteristicsList>
                <characteristicType>C1HPLNID</
characteristicType>
                    <characteristicValue>140</characteristicValue>
                    <effectiveDate>2019-01-01</effectiveDate>
                </characteristicsList>
            </characteristics>
        <policyPlanProrationRuleList>
            <effectiveDate></effectiveDate>
            <prorationEventType></prorationEventType>
            <prorationType></prorationType>
            <numberOfDays></numberOfDays>
            <membershipType></membershipType>
        </policyPlanProrationRuleList>
    </planData>
    <planData>
        <planNumber>PPO_MED_BRONZE_RETIRED</planNumber>
        <priceItemCode></priceItemCode>
        <planName>PPO Medical Bronze 60 RE</planName>
        <pricingRuleTypeList>
            <pricingRuleType>AGE_BASED</pricingRuleType>
        </pricingRuleTypeList>
        <startDate>2019-01-01</startDate>
        <endDate>2019-12-31</endDate>
        <primaryPlanSw>N</primaryPlanSw>
        <characteristics>
            <characteristicsList>
                <characteristicType>C1HPLNID</
characteristicType>

```

```

                <characteristicValue>160</characteristicValue>
                <effectiveDate>2019-01-01</effectiveDate>
            </characteristicsList>
        </characteristics>
    </policyPlanProrationRuleList>
    <effectiveDate></effectiveDate>
    <prorationEventType></prorationEventType>
    <prorationType></prorationType>
    <numberOfDays></numberOfDays>
    <membershipType></membershipType>
</policyPlanProrationRuleList>
</planData>
<planData>
    <planNumber>PPO_MED_SILVER_RETIRED</planNumber>
    <priceItemCode></priceItemCode>
    <planName>PPO Medical Silver 70 RE</planName>
    <pricingRuleTypeList>
        <pricingRuleType>AGE_BASED</pricingRuleType>
    </pricingRuleTypeList>
    <startDate>2019-01-01</startDate>
    <endDate>2019-12-31</endDate>
    <primaryPlanSw>N</primaryPlanSw>
    <characteristics>
        <characteristicsList>
            <characteristicType>C1HPLNID</
characteristicType>
                <characteristicValue>180</characteristicValue>
                <effectiveDate>2019-01-01</effectiveDate>
            </characteristicsList>
        </characteristics>
    </policyPlanProrationRuleList>
    <effectiveDate></effectiveDate>
    <prorationEventType></prorationEventType>
    <prorationType></prorationType>
    <numberOfDays></numberOfDays>
    <membershipType></membershipType>
</policyPlanProrationRuleList>
</planData>
<planData>
    <planNumber>DD_BASIC_RETIRED</planNumber>
    <priceItemCode></priceItemCode>
    <planName>DD BASIC RE</planName>
    <pricingRuleTypeList>
        <pricingRuleType>TIER_BASED</pricingRuleType>
    </pricingRuleTypeList>
    <startDate>2019-01-01</startDate>
    <endDate>2019-12-31</endDate>
    <primaryPlanSw>N</primaryPlanSw>
    <characteristics>
        <characteristicsList>
            <characteristicType>C1HPLNID</
characteristicType>
                <characteristicValue>200</characteristicValue>
                <effectiveDate>2019-01-01</effectiveDate>
            </characteristicsList>
        </characteristics>
    </policyPlanProrationRuleList>
    <effectiveDate></effectiveDate>
    <prorationEventType></prorationEventType>
    <prorationType></prorationType>
    <numberOfDays></numberOfDays>
    <membershipType></membershipType>
</policyPlanProrationRuleList>
</planData>

```

```

    </policyData>
  </personData>
  <personData>
    <sequence>2</sequence>
    <personType>BG</personType>
    <personName>
      <sequence>1</sequence>
      <entityName>Antartica Petroleum ACTIVE</entityName>
      <nameType>PRIM</nameType>
    </personName>
    <identifiers>
      <idType>EIN</idType>
      <idValue>98-7654320</idValue>
      <isPrimary>Y</isPrimary>
    </identifiers>
    <division>HC</division>
    <birthDate>1991-05-09</birthDate>
    <sinceDate>2019-01-01</sinceDate>
    <address>
      <addressEffDate>2019-01-01</addressEffDate>
      <addressType>MAIN</addressType>
      <mailingName>Antartica Petroleum ACTIVE</mailingName>
      <address1>Mars Park</address1>
      <address2>Mars Street</address2>
      <address3>Lake Side</address3>
      <address4></address4>
      <city>Los Angeles</city>
      <state>CA</state>
      <zip>90020</zip>
      <country>USA</country>
      <houseType></houseType>
      <streetNumber1></streetNumber1>
      <streetNumber2></streetNumber2>
      <inCityLimit></inCityLimit>
      <taxVendorGeographicalCode></taxVendorGeographicalCode>
      <county></county>
    </address>
    <email>apcac@example.com</email>
    <overrideMailingName1></overrideMailingName1>
    <overrideMailingName2></overrideMailingName2>
    <overrideMailingName3></overrideMailingName3>
    <phones>
      <phoneType>BUSN</phoneType>
      <phoneValue>661-555-0111</phoneValue>
    </phones>
    <relatedPersons>
      <idType>EIN</idType>
      <idValue>98-7654329</idValue>
      <personRelationshipType></personRelationshipType>
      <startDate>2019-01-01</startDate>
      <endDate>2019-12-31</endDate>
      <financialRelationshipSw>>false</financialRelationshipSw>
      <parentOrChild>P</parentOrChild>
      <characteristics>
        <characteristicsList>
          <characteristicType></characteristicType>
          <characteristicValue></characteristicValue>
          <effectiveDate></effectiveDate>
        </characteristicsList>
      </characteristics>
    </relatedPersons>
    <characteristics>
      <characteristicsList>
        <characteristicValue>OTHER</characteristicValue>
      </characteristicsList>
    </characteristics>
  </personData>

```

```

        <characteristicType>PER_CAT</characteristicType>
        <effectiveDate>2019-01-01</effectiveDate>
    </characteristicsList>
</characteristics>
<billLevelParameters>
    <sequence>1</sequence>
    <sourceSystem>SMALLPRIME</sourceSystem>
    <billLevelInfo1>ACTIVE</billLevelInfo1>
    <billLevelInfo2>SEATTLE</billLevelInfo2>
    <billLevelInfo3>MEDICAL</billLevelInfo3>
    <billLevelInfo4>HMO</billLevelInfo4>
    <effectiveDate>2019-01-01</effectiveDate>
</billLevelParameters>
<billLevelParameters>
    <sequence>2</sequence>
    <sourceSystem>SMALLPRIME</sourceSystem>
    <billLevelInfo1>ACTIVE</billLevelInfo1>
    <billLevelInfo2>SEATTLE</billLevelInfo2>
    <billLevelInfo3>MEDICAL</billLevelInfo3>
    <billLevelInfo4>PPO</billLevelInfo4>
    <effectiveDate>2019-01-01</effectiveDate>
</billLevelParameters>
<billLevelParameters>
    <sequence>3</sequence>
    <sourceSystem>SMALLPRIME</sourceSystem>
    <billLevelInfo1>ACTIVE</billLevelInfo1>
    <billLevelInfo2>SEATTLE</billLevelInfo2>
    <billLevelInfo3>DENTAL</billLevelInfo3>
    <billLevelInfo4>HMO</billLevelInfo4>
    <effectiveDate>2019-01-01</effectiveDate>
</billLevelParameters>
<billLevelParameters>
    <sequence>4</sequence>
    <sourceSystem>SMALLPRIME</sourceSystem>
    <billLevelInfo1>ACTIVE</billLevelInfo1>
    <billLevelInfo2>SEATTLE</billLevelInfo2>
    <billLevelInfo3>DENTAL</billLevelInfo3>
    <billLevelInfo4>PPO</billLevelInfo4>
    <effectiveDate>2019-01-01</effectiveDate>
</billLevelParameters>
<billLevelParameters>
    <sequence>5</sequence>
    <sourceSystem>SMALLPRIME</sourceSystem>
    <billLevelInfo1>ACTIVE</billLevelInfo1>
    <billLevelInfo2>SAN FRANCISCO</billLevelInfo2>
    <billLevelInfo3>MEDICAL</billLevelInfo3>
    <billLevelInfo4>HMO</billLevelInfo4>
    <effectiveDate>2019-01-01</effectiveDate>
</billLevelParameters>
<billLevelParameters>
    <sequence>6</sequence>
    <sourceSystem>SMALLPRIME</sourceSystem>
    <billLevelInfo1>ACTIVE</billLevelInfo1>
    <billLevelInfo2>SAN FRANCISCO</billLevelInfo2>
    <billLevelInfo3>MEDICAL</billLevelInfo3>
    <billLevelInfo4>PPO</billLevelInfo4>
    <effectiveDate>2019-01-01</effectiveDate>
</billLevelParameters>
<billLevelParameters>
    <sequence>7</sequence>
    <sourceSystem>SMALLPRIME</sourceSystem>
    <billLevelInfo1>ACTIVE</billLevelInfo1>
    <billLevelInfo2>SAN FRANCISCO</billLevelInfo2>
    <billLevelInfo3>DENTAL</billLevelInfo3>

```

```

        <billLevelInfo4>HMO</billLevelInfo4>
        <effectiveDate>2019-01-01</effectiveDate>
    </billLevelParameters>
    <billLevelParameters>
        <sequence>8</sequence>
        <sourceSystem>SMALLPRIME</sourceSystem>
        <billLevelInfo1>ACTIVE</billLevelInfo1>
        <billLevelInfo2>SAN FRANCISCO</billLevelInfo2>
        <billLevelInfo3>DENTAL</billLevelInfo3>
        <billLevelInfo4>PPO</billLevelInfo4>
        <effectiveDate>2019-01-01</effectiveDate>
    </billLevelParameters>
    <billLevelParameters>
        <sequence>9</sequence>
        <sourceSystem>SMALLPRIME</sourceSystem>
        <billLevelInfo1>ACTIVE</billLevelInfo1>
        <billLevelInfo2>LOS ANGELES</billLevelInfo2>
        <billLevelInfo3>MEDICAL</billLevelInfo3>
        <billLevelInfo4>HMO</billLevelInfo4>
        <effectiveDate>2019-01-01</effectiveDate>
    </billLevelParameters>
    <billLevelParameters>
        <sequence>10</sequence>
        <sourceSystem>SMALLPRIME</sourceSystem>
        <billLevelInfo1>ACTIVE</billLevelInfo1>
        <billLevelInfo2>LOS ANGELES</billLevelInfo2>
        <billLevelInfo3>MEDICAL</billLevelInfo3>
        <billLevelInfo4>PPO</billLevelInfo4>
        <effectiveDate>2019-01-01</effectiveDate>
    </billLevelParameters>
    <billLevelParameters>
        <sequence>11</sequence>
        <sourceSystem>SMALLPRIME</sourceSystem>
        <billLevelInfo1>ACTIVE</billLevelInfo1>
        <billLevelInfo2>LOS ANGELES</billLevelInfo2>
        <billLevelInfo3>DENTAL</billLevelInfo3>
        <billLevelInfo4>HMO</billLevelInfo4>
        <effectiveDate>2019-01-01</effectiveDate>
    </billLevelParameters>
    <billLevelParameters>
        <sequence>12</sequence>
        <sourceSystem>SMALLPRIME</sourceSystem>
        <billLevelInfo1>ACTIVE</billLevelInfo1>
        <billLevelInfo2>LOS ANGELES</billLevelInfo2>
        <billLevelInfo3>DENTAL</billLevelInfo3>
        <billLevelInfo4>PPO</billLevelInfo4>
        <effectiveDate>2019-01-01</effectiveDate>
    </billLevelParameters>
    <memberData>
        <startDate></startDate>
        <endDate></endDate>
        <paidThroughDate></paidThroughDate>
        <memberId></memberId>
        <memberRelationship></memberRelationship>
        <membershipPersonStatus></membershipPersonStatus>
        <membershipPersonstatusReason></
membershipPersonstatusReason>
        <autoRenew></autoRenew>
        <associatedMemberIdentifierType></
associatedMemberIdentifierType>
        <associatedMemberIdentifier></associatedMemberIdentifier>
        <exchangeFlag></exchangeFlag>
        <exchangeId></exchangeId>
        <binderLiabilityAmount></binderLiabilityAmount>

```

```

    <binderPayApplicability></binderPayApplicability>
    <binderPayGraceDays></binderPayGraceDays>
    <binderPayThreshold></binderPayThreshold>
    <holdBilling></holdBilling>
    <membershipRenewalDate></membershipRenewalDate>
    <contractPeriod></contractPeriod>
    <membershipIdentifier>
      <membershipIdentifierType></membershipIdentifierType>
      <membershipIdentifierValue></
membershipIdentifierValue>
    </membershipIdentifier>
    <isMemberSw></isMemberSw>
    <isFinanciallyResponsibleSw></isFinanciallyResponsibleSw>
    <membershipType></membershipType>
    <externalMedicareBeneficiaryId></
externalMedicareBeneficiaryId>
    <mainSubscriber>
      <idType></idType>
      <idValue></idValue>
      <membershipType></membershipType>
    </mainSubscriber>
    <policyNumber></policyNumber>
    <sourceSystem></sourceSystem>
    <planNumber></planNumber>
    <healthPlanCode></healthPlanCode>
    <characteristics>
      <characteristicsList>
        <characteristicType></characteristicType>
        <characteristicValue></characteristicValue>
        <effectiveDate></effectiveDate>
      </characteristicsList>
    </characteristics>
    <membershipRateGuarantee>
      <membershipRateGuaranteeList>
        <rateGuaranteeStartDate></rateGuaranteeStartDate>
        <rateGuaranteeEndDate></rateGuaranteeEndDate>
        <rateGuaranteeStatus></rateGuaranteeStatus>
      </membershipRateGuaranteeList>
    </membershipRateGuarantee>
    <membershipPersonCharacteristic>
      <characteristicsList>
        <characteristicType></characteristicType>
        <characteristicValue></characteristicValue>
        <effectiveDate></effectiveDate>
      </characteristicsList>
      <characteristicsList>
        <characteristicType></characteristicType>
        <characteristicValue></characteristicValue>
        <effectiveDate></effectiveDate>
      </characteristicsList>
    </membershipPersonCharacteristic>
    <benefitData>
      <benefitDataList>
        <sequence></sequence>
        <startDate></startDate>
        <endDate></endDate>
        <benefitStatus></benefitStatus>
        <benefitSourceFlag></benefitSourceFlag>
        <benefitTypeFlag></benefitTypeFlag>
        <benefitSubTypeFlag></benefitSubTypeFlag>
        <planBenefitPackageId></planBenefitPackageId>
        <benefitAmount></benefitAmount>
        <characteristics>
          <characteristicsList>

```

```

                                <characteristicType></characteristicType>
                                <characteristicValue></
characteristicValue>
                                <effectiveDate></effectiveDate>
                                </characteristicsList>
                                </characteristics>
                                </benefitDataList>
</benefitData>
<billableChargeData>
  <sequence></sequence>
  <accountIdType></accountIdType>
  <accountIdValue></accountIdValue>
  <chargeType></chargeType>
  <startDate></startDate>
  <endDate></endDate>
  <priceItemCode></priceItemCode>
  <description></description>
  <recurringMethod></recurringMethod>
  <billPeriod></billPeriod>
  <frequency></frequency>
  <billAfterDt></billAfterDt>
  <billableChargeLines>
    <descriptionOnBill></descriptionOnBill>
    <currencyCode></currencyCode>
    <chargeAmount></chargeAmount>
    <showOnBillSw></showOnBillSw>
    <appearInSummarySw></appearInSummarySw>
    <distributionCode></distributionCode>
  </billableChargeLines>
  <characteristics>
    <characteristicsList>
      <characteristicType></characteristicType>
      <characteristicValue></characteristicValue>
      <effectiveDate></effectiveDate>
    </characteristicsList>
  </characteristics>
</billableChargeData>
</memberData>
<accountData>
  <accountType>CMS</accountType>
  <customerClass>HC</customerClass>
  <billCycle>BK01</billCycle>
  <billLeadDays>10</billLeadDays>
  <division>HC</division>
  <currency>USD</currency>
  <setUpDate>2019-01-01</setUpDate>
  <acctUsageFlg>USAG</acctUsageFlg>
  <comments></comments>
  <deferAutoPayDt></deferAutoPayDt>
  <collectionClass></collectionClass>
  <billRouteType>POSTAL</billRouteType>
  <billAddressSource>PER</billAddressSource>
  <identifiers>
    <idType>ACCT_NM</idType>
    <idValue>Medical Account</idValue>
    <isPrimary>true</isPrimary>
  </identifiers>
  <address>
    <addressEffDate>2019-01-01</addressEffDate>
    <addressType></addressType>
    <address1></address1>
    <address2>Fresno</address2>
    <address3></address3>
    <address4></address4>

```

```

        <city></city>
        <state></state>
        <zip></zip>
        <country></country>
        <houseType></houseType>
        <streetNumber1></streetNumber1>
        <streetNumber2></streetNumber2>
        <inCityLimit></inCityLimit>
        <taxVendorGeographicalCode></
taxVendorGeographicalCode>
        <county></county>
    </address>
</accountData>
<accountData>
    <accountType>CMR</accountType>
    <customerClass>HC</customerClass>
    <billCycle>BK02</billCycle>
    <billLeadDays>10</billLeadDays>
    <division>HC</division>
    <currency>USD</currency>
    <setUpDate>2019-01-01</setUpDate>
    <acctUsageFlg>USAG</acctUsageFlg>
    <comments></comments>
    <deferAutoPayDt></deferAutoPayDt>
    <collectionClass></collectionClass>
    <billRouteType>POSTAL</billRouteType>
    <billAddressSource>ACOV</billAddressSource>
    <identifiers>
        <idType>ACCT_NM</idType>
        <idValue>Dental Account</idValue>
        <isPrimary>true</isPrimary>
    </identifiers>
    <address>
        <addressEffDate>2019-01-01</addressEffDate>
        <addressType>OVRD</addressType>
        <address1>Jupiter Park<</address1>
        <address2>Jupiter Street</address2>
        <address3>Near Corporation Bank</address3>
        <address4></address4>
        <city>Los Angeles</city>
        <state>CA</state>
        <zip>90020</zip>
        <country>USA</country>
        <houseType></houseType>
        <streetNumber1></streetNumber1>
        <streetNumber2></streetNumber2>
        <inCityLimit></inCityLimit>
        <taxVendorGeographicalCode></
taxVendorGeographicalCode>
        <county></county>
    </address>
</accountData>
<policyData>
    <policyType></policyType>
    <sourceSystem></sourceSystem>
    <policyNumber></policyNumber>
    <description></description>
    <advancedLevelFundingEligibility></
advancedLevelFundingEligibility>
        <startDate></startDate>
        <endDate></endDate>
        <runOutEndDate></runOutEndDate>
        <runOutAdminOption></runOutAdminOption>
        <renewalDate></renewalDate>

```



```

    <policyPersons>
      <idType></idType>
      <idValue></idValue>
      <policyPerRole></policyPerRole>
      <startDate></startDate>
      <endDate></endDate>
    </policyPersons>
    <terminationInformation>
      <terminateDate></terminateDate>
      <terminationReason></terminationReason>
    </terminationInformation>
    <reinstateInformation>
      <reinstatementDate></reinstatementDate>
      <reinstateReason></reinstateReason>
    </reinstateInformation>
    <characteristics>
      <characteristicsList>
        <characteristicType></characteristicType>
        <characteristicValue></characteristicValue>
        <effectiveDate></effectiveDate>
      </characteristicsList>
    </characteristics>
    <planData>
      <planNumber></planNumber>
      <priceItemCode></priceItemCode>
      <planName></planName>
      <pricingRuleTypeList>
        <pricingRuleType></pricingRuleType>
      </pricingRuleTypeList>
      <startDate></startDate>
      <endDate></endDate>
      <primaryPlanSw></primaryPlanSw>
      <benefitTypeFlag></benefitTypeFlag>
      <characteristics>
        <characteristicsList>
          <characteristicType></characteristicType>
          <characteristicValue></characteristicValue>
          <effectiveDate></effectiveDate>
        </characteristicsList>
      </characteristics>
      <policyPlanProrationRuleList>
        <effectiveDate></effectiveDate>
        <prorationEventType></prorationEventType>
        <prorationType></prorationType>
        <numberOfDays></numberOfDays>
        <membershipType></membershipType>
      </policyPlanProrationRuleList>
    </planData>
  </policyData>
</personData>
<personData>
  <sequence>3</sequence>
  <personType>BG</personType>
  <personName>
    <sequence>1</sequence>
    <entityName>Antartica Petroleum COBRA</entityName>
    <nameType>PRIM</nameType>
  </personName>
  <identifiers>
    <idType>EIN</idType>
    <idValue>98-7654321</idValue>
    <isPrimary>Y</isPrimary>
  </identifiers>
  <division>HC</division>

```

```

<birthDate>1976-01-12</birthDate>
<sinceDate>2019-01-01</sinceDate>
<address>
  <addressEffDate>2019-01-01</addressEffDate>
  <addressType>MAIN</addressType>
  <mailingName>Antartica Petroleum COBRA</mailingName>
  <address1>Venus Park</address1>
  <address2>Venus Street</address2>
  <address3>Lake Side</address3>
  <address4></address4>
  <city>Los Angeles</city>
  <state>CA</state>
  <zip>90020</zip>
  <country>USA</country>
  <houseType></houseType>
  <streetNumber1></streetNumber1>
  <streetNumber2></streetNumber2>
  <inCityLimit></inCityLimit>
  <taxVendorGeographicalCode></taxVendorGeographicalCode>
  <county></county>
</address>
<email>apcco@example.com</email>
<overrideMailingName1></overrideMailingName1>
<overrideMailingName2></overrideMailingName2>
<overrideMailingName3></overrideMailingName3>
<phones>
  <phoneType>BUSN</phoneType>
  <phoneValue>213-555-0175</phoneValue>
</phones>
<relatedPersons>
  <idType>EIN</idType>
  <idValue>98-7654329</idValue>
  <personRelationshipType></personRelationshipType>
  <startDate>2019-01-01</startDate>
  <endDate>2019-12-31</endDate>
  <financialRelationshipSw>>false</financialRelationshipSw>
  <parentOrChild>P</parentOrChild>
  <characteristics>
    <characteristicsList>
      <characteristicType></characteristicType>
      <characteristicValue></characteristicValue>
      <effectiveDate></effectiveDate>
    </characteristicsList>
  </characteristics>
</relatedPersons>
<characteristics>
  <characteristicsList>
    <characteristicType>PER_CAT</characteristicType>
    <characteristicValue>OTHER</characteristicValue>
    <effectiveDate>2019-01-01</effectiveDate>
  </characteristicsList>
</characteristics>
<billLevelParameters>
  <sequence>13</sequence>
  <sourceSystem>SMALLPRIME</sourceSystem>
  <billLevelInfo1>COBRA</billLevelInfo1>
  <billLevelInfo2>SEATTLE</billLevelInfo2>
  <billLevelInfo3>MEDICAL</billLevelInfo3>
  <billLevelInfo4>HMO</billLevelInfo4>
  <effectiveDate>2019-01-01</effectiveDate>
</billLevelParameters>
<billLevelParameters>
  <sequence>14</sequence>
  <sourceSystem>SMALLPRIME</sourceSystem>

```

```

    <billLevelInfo1>COBRA</billLevelInfo1>
    <billLevelInfo2>SEATTLE</billLevelInfo2>
    <billLevelInfo3>MEDICAL</billLevelInfo3>
    <billLevelInfo4>PPO</billLevelInfo4>
    <effectiveDate>2019-01-01</effectiveDate>
  </billLevelParameters>
</billLevelParameters>
  <sequence>15</sequence>
  <sourceSystem>SMALLPRIME</sourceSystem>
  <billLevelInfo1>COBRA</billLevelInfo1>
  <billLevelInfo2>SEATTLE</billLevelInfo2>
  <billLevelInfo3>DENTAL</billLevelInfo3>
  <billLevelInfo4>HMO</billLevelInfo4>
  <effectiveDate>2019-01-01</effectiveDate>
</billLevelParameters>
</billLevelParameters>
  <sequence>16</sequence>
  <sourceSystem>SMALLPRIME</sourceSystem>
  <billLevelInfo1>COBRA</billLevelInfo1>
  <billLevelInfo2>SEATTLE</billLevelInfo2>
  <billLevelInfo3>DENTAL</billLevelInfo3>
  <billLevelInfo4>PPO</billLevelInfo4>
  <effectiveDate>2019-01-01</effectiveDate>
</billLevelParameters>
</billLevelParameters>
  <sequence>17</sequence>
  <sourceSystem>SMALLPRIME</sourceSystem>
  <billLevelInfo1>COBRA</billLevelInfo1>
  <billLevelInfo2>SAN FRANCISCO</billLevelInfo2>
  <billLevelInfo3>MEDICAL</billLevelInfo3>
  <billLevelInfo4>HMO</billLevelInfo4>
  <effectiveDate>2019-01-01</effectiveDate>
</billLevelParameters>
</billLevelParameters>
  <sequence>18</sequence>
  <sourceSystem>SMALLPRIME</sourceSystem>
  <billLevelInfo1>COBRA</billLevelInfo1>
  <billLevelInfo2>SAN FRANCISCO</billLevelInfo2>
  <billLevelInfo3>MEDICAL</billLevelInfo3>
  <billLevelInfo4>PPO</billLevelInfo4>
  <effectiveDate>2019-01-01</effectiveDate>
</billLevelParameters>
</billLevelParameters>
  <sequence>19</sequence>
  <sourceSystem>SMALLPRIME</sourceSystem>
  <billLevelInfo1>COBRA</billLevelInfo1>
  <billLevelInfo2>SAN FRANCISCO</billLevelInfo2>
  <billLevelInfo3>DENTAL</billLevelInfo3>
  <billLevelInfo4>HMO</billLevelInfo4>
  <effectiveDate>2019-01-01</effectiveDate>
</billLevelParameters>
</billLevelParameters>
  <sequence>20</sequence>
  <sourceSystem>SMALLPRIME</sourceSystem>
  <billLevelInfo1>COBRA</billLevelInfo1>
  <billLevelInfo2>SAN FRANCISCO</billLevelInfo2>
  <billLevelInfo3>DENTAL</billLevelInfo3>
  <billLevelInfo4>PPO</billLevelInfo4>
  <effectiveDate>2019-01-01</effectiveDate>
</billLevelParameters>
</billLevelParameters>
  <sequence>21</sequence>
  <sourceSystem>SMALLPRIME</sourceSystem>
  <billLevelInfo1>COBRA</billLevelInfo1>

```

```

        <billLevelInfo2>LOS ANGELES</billLevelInfo2>
        <billLevelInfo3>MEDICAL</billLevelInfo3>
        <billLevelInfo4>HMO</billLevelInfo4>
        <effectiveDate>2019-01-01</effectiveDate>
    </billLevelParameters>
    <billLevelParameters>
        <sequence>22</sequence>
        <sourceSystem>SMALLPRIME</sourceSystem>
        <billLevelInfo1>COBRA</billLevelInfo1>
        <billLevelInfo2>LOS ANGELES</billLevelInfo2>
        <billLevelInfo3>MEDICAL</billLevelInfo3>
        <billLevelInfo4>PPO</billLevelInfo4>
        <effectiveDate>2019-01-01</effectiveDate>
    </billLevelParameters>
    <billLevelParameters>
        <sequence>23</sequence>
        <sourceSystem>SMALLPRIME</sourceSystem>
        <billLevelInfo1>COBRA</billLevelInfo1>
        <billLevelInfo2>LOS ANGELES</billLevelInfo2>
        <billLevelInfo3>DENTAL</billLevelInfo3>
        <billLevelInfo4>HMO</billLevelInfo4>
        <effectiveDate>2019-01-01</effectiveDate>
    </billLevelParameters>
    <billLevelParameters>
        <sequence>24</sequence>
        <sourceSystem>SMALLPRIME</sourceSystem>
        <billLevelInfo1>COBRA</billLevelInfo1>
        <billLevelInfo2>LOS ANGELES</billLevelInfo2>
        <billLevelInfo3>DENTAL</billLevelInfo3>
        <billLevelInfo4>PPO</billLevelInfo4>
        <effectiveDate>2019-01-01</effectiveDate>
    </billLevelParameters>
    <memberData>
        <startDate></startDate>
        <endDate></endDate>
        <paidThroughDate></paidThroughDate>
        <memberId></memberId>
        <memberRelationship></memberRelationship>
        <membershipPersonStatus></membershipPersonStatus>
        <membershipPersonstatusReason></
membershipPersonstatusReason>
        <autoRenew></autoRenew>
        <associatedMemberIdentifierType></
associatedMemberIdentifierType>
        <associatedMemberIdentifier></associatedMemberIdentifier>
        <exchangeFlag></exchangeFlag>
        <exchangeId></exchangeId>
        <binderLiabilityAmount></binderLiabilityAmount>
        <binderPayApplicability></binderPayApplicability>
        <binderPayGraceDays></binderPayGraceDays>
        <binderPayThreshold></binderPayThreshold>
        <holdBilling></holdBilling>
        <membershipRenewalDate></membershipRenewalDate>
        <contractPeriod></contractPeriod>
        <membershipIdentifier>
            <membershipIdentifierType></membershipIdentifierType>
            <membershipIdentifierValue></
membershipIdentifierValue>
        </membershipIdentifier>
        <isMemberSw></isMemberSw>
        <isFinanciallyResponsibleSw></isFinanciallyResponsibleSw>
        <membershipType></membershipType>
        <externalMedicareBeneficiaryId></
externalMedicareBeneficiaryId>

```

```

<mainSubscriber>
  <idType></idType>
  <idValue></idValue>
  <membershipType></membershipType>
</mainSubscriber>
<policyNumber></policyNumber>
<sourceSystem></sourceSystem>
<planNumber></planNumber>
<healthPlanCode></healthPlanCode>
<characteristics>
  <characteristicsList>
    <characteristicType></characteristicType>
    <characteristicValue></characteristicValue>
    <effectiveDate></effectiveDate>
  </characteristicsList>
</characteristics>
<membershipRateGuarantee>
  <membershipRateGuaranteeList>
    <rateGuaranteeStartDate></rateGuaranteeStartDate>
    <rateGuaranteeEndDate></rateGuaranteeEndDate>
    <rateGuaranteeStatus></rateGuaranteeStatus>
  </membershipRateGuaranteeList>
</membershipRateGuarantee>
<membershipPersonCharacteristic>
  <characteristicsList>
    <characteristicType></characteristicType>
    <characteristicValue></characteristicValue>
    <effectiveDate></effectiveDate>
  </characteristicsList>
  <characteristicsList>
    <characteristicType></characteristicType>
    <characteristicValue></characteristicValue>
    <effectiveDate></effectiveDate>
  </characteristicsList>
</membershipPersonCharacteristic>
<benefitData>
  <benefitDataList>
    <sequence></sequence>
    <startDate></startDate>
    <endDate></endDate>
    <benefitStatus></benefitStatus>
    <benefitSourceFlag></benefitSourceFlag>
    <benefitTypeFlag></benefitTypeFlag>
    <benefitSubTypeFlag></benefitSubTypeFlag>
    <planBenefitPackageId></planBenefitPackageId>
    <benefitAmount></benefitAmount>
    <characteristics>
      <characteristicsList>
        <characteristicType></characteristicType>
        <characteristicValue></
characteristicValue>
          <effectiveDate></effectiveDate>
        </characteristicsList>
      </characteristics>
    </benefitDataList>
  </benefitData>
<billableChargeData>
  <sequence></sequence>
  <accountIdType></accountIdType>
  <accountIdValue></accountIdValue>
  <chargeType></chargeType>
  <startDate></startDate>
  <endDate></endDate>
  <priceItemCode></priceItemCode>

```

```

        <description></description>
        <recurringMethod></recurringMethod>
        <billPeriod></billPeriod>
        <frequency></frequency>
        <billAfterDt></billAfterDt>
        <billableChargeLines>
            <descriptionOnBill></descriptionOnBill>
            <currencyCode></currencyCode>
            <chargeAmount></chargeAmount>
            <showOnBillSw></showOnBillSw>
            <appearInSummarySw></appearInSummarySw>
            <distributionCode></distributionCode>
        </billableChargeLines>
        <characteristics>
            <characteristicsList>
                <characteristicType></characteristicType>
                <characteristicValue></characteristicValue>
                <effectiveDate></effectiveDate>
            </characteristicsList>
        </characteristics>
    </billableChargeData>
</memberData>
<accountData>
    <accountType>CMS</accountType>
    <customerClass>HC</customerClass>
    <billCycle>BK01</billCycle>
    <billLeadDays>10</billLeadDays>
    <division>HC</division>
    <currency>USD</currency>
    <setUpDate>2019-01-01</setUpDate>
    <acctUsageFlg>USAG</acctUsageFlg>
    <comments></comments>
    <deferAutoPayDt></deferAutoPayDt>
    <collectionClass></collectionClass>
    <billRouteType>POSTAL</billRouteType>
    <billAddressSource>PER</billAddressSource>
    <identifiers>
        <idType>ACCT_NM</idType>
        <idValue>Medical Account</idValue>
        <isPrimary>true</isPrimary>
    </identifiers>
    <address>
        <addressEffDate>2019-01-01</addressEffDate>
        <addressType></addressType>
        <address1><</address1>
        <address2></address2>
        <address3></address3>
        <address4></address4>
        <city></city>
        <state></state>
        <zip></zip>
        <country></country>
        <houseType></houseType>
        <streetNumber1></streetNumber1>
        <streetNumber2></streetNumber2>
        <inCityLimit></inCityLimit>
        <taxVendorGeographicalCode></
taxVendorGeographicalCode>
        <county></county>
    </address>
</accountData>
<accountData>
    <accountType>CMR</accountType>
    <customerClass>HC</customerClass>

```

```

<billCycle>BK02</billCycle>
<billLeadDays>10</billLeadDays>
<division>HC</division>
<currency>USD</currency>
<setUpDate>2019-01-01</setUpDate>
<acctUsageFlg>USAG</acctUsageFlg>
<comments></comments>
<deferAutoPayDt></deferAutoPayDt>
<collectionClass></collectionClass>
<billRouteType>POSTAL</billRouteType>
<billAddressSource>ACOV</billAddressSource>
<identifiers>
  <idType>ACCT_NM</idType>
  <idValue>Dental Account</idValue>
  <isPrimary>true</isPrimary>
</identifiers>
<address>
  <addressEffDate>2019-01-01</addressEffDate>
  <addressType>OVRD</addressType>
  <address1>Venus Park</address1>
  <address2>Venus Street</address2>
  <address3>Lake Side</address3>
  <address4></address4>
  <city>Los Angeles</city>
  <state>CA</state>
  <zip>90020</zip>
  <country>USA</country>
  <houseType></houseType>
  <streetNumber1></streetNumber1>
  <streetNumber2></streetNumber2>
  <inCityLimit></inCityLimit>
  <taxVendorGeographicalCode></
taxVendorGeographicalCode>
  <county></county>
</address>
</accountData>
<policyData>
  <policyType></policyType>
  <sourceSystem></sourceSystem>
  <policyNumber></policyNumber>
  <description></description>
  <advancedLevelFundingEligibility></
advancedLevelFundingEligibility>
  <startDate></startDate>
  <endDate></endDate>
  <runOutEndDate></runOutEndDate>
  <runOutAdminOption></runOutAdminOption>
  <renewalDate></renewalDate>
  <policyPersons>
    <idType></idType>
    <idValue></idValue>
    <policyPerRole></policyPerRole>
    <startDate></startDate>
    <endDate></endDate>
  </policyPersons>
  <terminationInformation>
    <terminateDate></terminateDate>
    <terminationReason></terminationReason>
  </terminationInformation>
  <reinstateInformation>
    <reinstatementDate></reinstatementDate>
    <reinstateReason></reinstateReason>
  </reinstateInformation>
  <characteristics>

```

```

        <characteristicsList>
            <characteristicType></characteristicType>
            <characteristicValue></characteristicValue>
            <effectiveDate></effectiveDate>
        </characteristicsList>
    </characteristics>
</planData>
    <planNumber></planNumber>
    <priceItemCode></priceItemCode>
    <planName></planName>
    <pricingRuleTypeList>
        <pricingRuleType></pricingRuleType>
    </pricingRuleTypeList>
    <startDate></startDate>
    <endDate></endDate>
    <primaryPlanSw></primaryPlanSw>
    <benefitTypeFlag></benefitTypeFlag>
    <characteristics>
        <characteristicsList>
            <characteristicType></characteristicType>
            <characteristicValue></characteristicValue>
            <effectiveDate></effectiveDate>
        </characteristicsList>
    </characteristics>
    <policyPlanProrationRuleList>
        <effectiveDate></effectiveDate>
        <prorationEventType></prorationEventType>
        <prorationType></prorationType>
        <numberOfDays></numberOfDays>
        <membershipType></membershipType>
    </policyPlanProrationRuleList>
</planData>
</policyData>
</personData>
<personData>
    <sequence>4</sequence>
    <personType>BG</personType>
    <personName>
        <sequence>1</sequence>
        <entityName>Antartica Petroleum RETIREE</entityName>
        <nameType>PRIM</nameType>
    </personName>
    <identifiers>
        <idType>EIN</idType>
        <idValue>98-7654322</idValue>
        <isPrimary>Y</isPrimary>
    </identifiers>
    <division>HC</division>
    <birthDate>1985-01-01</birthDate>
    <sinceDate>2019-01-01</sinceDate>
    <address>
        <addressEffDate>2019-01-01</addressEffDate>
        <addressType>MAIN</addressType>
        <mailingName>Antartica Petroleum RETIREE</mailingName>
        <address1>Neptune Park</address1>
        <address2>Neptune Street</address2>
        <address3>River Side</address3>
        <address4></address4>
        <city>San Jose</city>
        <state>CA</state>
        <zip>94088</zip>
        <country>USA</country>
        <houseType></houseType>
        <streetNumber1></streetNumber1>

```



```

        <streetNumber2></streetNumber2>
        <inCityLimit></inCityLimit>
        <taxVendorGeographicalCode></taxVendorGeographicalCode>
        <county></county>
    </address>
    <email>apcre@example.com</email>
    <overrideMailingName1></overrideMailingName1>
    <overrideMailingName2></overrideMailingName2>
    <overrideMailingName3></overrideMailingName3>
    <phones>
        <phoneType>BUSN</phoneType>
        <phoneValue>408-555-0165</phoneValue>
    </phones>
    <relatedPersons>
        <idType>EIN</idType>
        <idValue>98-7654329</idValue>
        <personRelationshipType></personRelationshipType>
        <startDate>2019-01-01</startDate>
        <endDate>2019-12-31</endDate>
        <financialRelationshipSw>>false</financialRelationshipSw>
        <parentOrChild>P</parentOrChild>
        <characteristics>
            <characteristicsList>
                <characteristicType></characteristicType>
                <characteristicValue></characteristicValue>
                <effectiveDate></effectiveDate>
            </characteristicsList>
        </characteristics>
    </relatedPersons>
    <characteristics>
        <characteristicsList>
            <characteristicType>PER_CAT</characteristicType>
            <characteristicValue>OTHER</characteristicValue>
            <effectiveDate>2019-01-01</effectiveDate>
        </characteristicsList>
    </characteristics>
    <billLevelParameters>
        <sequence>25</sequence>
        <sourceSystem>SMALLPRIME</sourceSystem>
        <billLevelInfo1>RETIRED</billLevelInfo1>
        <billLevelInfo2>SEATTLE</billLevelInfo2>
        <billLevelInfo3>MEDICAL</billLevelInfo3>
        <billLevelInfo4>HMO</billLevelInfo4>
        <effectiveDate>2019-01-01</effectiveDate>
    </billLevelParameters>
    <billLevelParameters>
        <sequence>26</sequence>
        <sourceSystem>SMALLPRIME</sourceSystem>
        <billLevelInfo1>RETIRED</billLevelInfo1>
        <billLevelInfo2>SEATTLE</billLevelInfo2>
        <billLevelInfo3>MEDICAL</billLevelInfo3>
        <billLevelInfo4>PPO</billLevelInfo4>
        <effectiveDate>2019-01-01</effectiveDate>
    </billLevelParameters>
    <billLevelParameters>
        <sequence>27</sequence>
        <sourceSystem>SMALLPRIME</sourceSystem>
        <billLevelInfo1>RETIRED</billLevelInfo1>
        <billLevelInfo2>SEATTLE</billLevelInfo2>
        <billLevelInfo3>DENTAL</billLevelInfo3>
        <billLevelInfo4>HMO</billLevelInfo4>
        <effectiveDate>2019-01-01</effectiveDate>
    </billLevelParameters>
    <billLevelParameters>

```

```

    <sequence>28</sequence>
    <sourceSystem>SMALLPRIME</sourceSystem>
    <billLevelInfo1>RETIRED</billLevelInfo1>
    <billLevelInfo2>SEATTLE</billLevelInfo2>
    <billLevelInfo3>DENTAL</billLevelInfo3>
    <billLevelInfo4>PPO</billLevelInfo4>
    <effectiveDate>2019-01-01</effectiveDate>
  </billLevelParameters>
</billLevelParameters>
  <sequence>29</sequence>
  <sourceSystem>SMALLPRIME</sourceSystem>
  <billLevelInfo1>RETIRED</billLevelInfo1>
  <billLevelInfo2>SAN FRANCISCO</billLevelInfo2>
  <billLevelInfo3>MEDICAL</billLevelInfo3>
  <billLevelInfo4>HMO</billLevelInfo4>
  <effectiveDate>2019-01-01</effectiveDate>
</billLevelParameters>
</billLevelParameters>
  <sequence>30</sequence>
  <sourceSystem>SMALLPRIME</sourceSystem>
  <billLevelInfo1>RETIRED</billLevelInfo1>
  <billLevelInfo2>SAN FRANCISCO</billLevelInfo2>
  <billLevelInfo3>MEDICAL</billLevelInfo3>
  <billLevelInfo4>PPO</billLevelInfo4>
  <effectiveDate>2019-01-01</effectiveDate>
</billLevelParameters>
</billLevelParameters>
  <sequence>31</sequence>
  <sourceSystem>SMALLPRIME</sourceSystem>
  <billLevelInfo1>RETIRED</billLevelInfo1>
  <billLevelInfo2>SAN FRANCISCO</billLevelInfo2>
  <billLevelInfo3>DENTAL</billLevelInfo3>
  <billLevelInfo4>HMO</billLevelInfo4>
  <effectiveDate>2019-01-01</effectiveDate>
</billLevelParameters>
</billLevelParameters>
  <sequence>32</sequence>
  <sourceSystem>SMALLPRIME</sourceSystem>
  <billLevelInfo1>RETIRED</billLevelInfo1>
  <billLevelInfo2>SAN FRANCISCO</billLevelInfo2>
  <billLevelInfo3>DENTAL</billLevelInfo3>
  <billLevelInfo4>PPO</billLevelInfo4>
  <effectiveDate>2019-01-01</effectiveDate>
</billLevelParameters>
</billLevelParameters>
  <sequence>33</sequence>
  <sourceSystem>SMALLPRIME</sourceSystem>
  <billLevelInfo1>RETIRED</billLevelInfo1>
  <billLevelInfo2>LOS ANGELES</billLevelInfo2>
  <billLevelInfo3>MEDICAL</billLevelInfo3>
  <billLevelInfo4>HMO</billLevelInfo4>
  <effectiveDate>2019-01-01</effectiveDate>
</billLevelParameters>
</billLevelParameters>
  <sequence>34</sequence>
  <sourceSystem>SMALLPRIME</sourceSystem>
  <billLevelInfo1>RETIRED</billLevelInfo1>
  <billLevelInfo2>LOS ANGELES</billLevelInfo2>
  <billLevelInfo3>MEDICAL</billLevelInfo3>
  <billLevelInfo4>PPO</billLevelInfo4>
  <effectiveDate>2019-01-01</effectiveDate>
</billLevelParameters>
</billLevelParameters>
  <sequence>35</sequence>

```

```

        <sourceSystem>SMALLPRIME</sourceSystem>
        <billLevelInfo1>RETIRED</billLevelInfo1>
        <billLevelInfo2>LOS ANGELES</billLevelInfo2>
        <billLevelInfo3>DENTAL</billLevelInfo3>
        <billLevelInfo4>HMO</billLevelInfo4>
        <effectiveDate>2019-01-01</effectiveDate>
    </billLevelParameters>
    <billLevelParameters>
        <sequence>36</sequence>
        <sourceSystem>SMALLPRIME</sourceSystem>
        <billLevelInfo1>RETIRED</billLevelInfo1>
        <billLevelInfo2>LOS ANGELES</billLevelInfo2>
        <billLevelInfo3>DENTAL</billLevelInfo3>
        <billLevelInfo4>PPO</billLevelInfo4>
        <effectiveDate>2019-01-01</effectiveDate>
    </billLevelParameters>
    <memberData>
        <startDate></startDate>
        <endDate></endDate>
        <paidThroughDate></paidThroughDate>
        <memberId></memberId>
        <memberRelationship></memberRelationship>
        <membershipPersonStatus></membershipPersonStatus>
        <membershipPersonStatusReason></
membershipPersonStatusReason>
        <autoRenew></autoRenew>
        <associatedMemberIdentifierType></
associatedMemberIdentifierType>
        <associatedMemberIdentifier></associatedMemberIdentifier>
        <exchangeFlag></exchangeFlag>
        <exchangeId></exchangeId>
        <binderLiabilityAmount></binderLiabilityAmount>
        <binderPayApplicability></binderPayApplicability>
        <binderPayGraceDays></binderPayGraceDays>
        <binderPayThreshold></binderPayThreshold>
        <holdBilling></holdBilling>
        <membershipRenewalDate></membershipRenewalDate>
        <contractPeriod></contractPeriod>
        <membershipIdentifier>
            <membershipIdentifierType></membershipIdentifierType>
            <membershipIdentifierValue></
membershipIdentifierValue>
        </membershipIdentifier>
        <isMemberSw></isMemberSw>
        <isFinanciallyResponsibleSw></isFinanciallyResponsibleSw>
        <membershipType></membershipType>
        <externalMedicareBeneficiaryId></
externalMedicareBeneficiaryId>
        <mainSubscriber>
            <idType></idType>
            <idValue></idValue>
            <membershipType></membershipType>
        </mainSubscriber>
        <policyNumber></policyNumber>
        <sourceSystem></sourceSystem>
        <planNumber></planNumber>
        <healthPlanCode></healthPlanCode>
        <characteristics>
            <characteristicsList>
                <characteristicType></characteristicType>
                <characteristicValue></characteristicValue>
                <effectiveDate></effectiveDate>
            </characteristicsList>
        </characteristics>
    </memberData>

```

```

<membershipRateGuarantee>
  <membershipRateGuaranteeList>
    <rateGuaranteeStartDate></rateGuaranteeStartDate>
    <rateGuaranteeEndDate></rateGuaranteeEndDate>
    <rateGuaranteeStatus></rateGuaranteeStatus>
  </membershipRateGuaranteeList>
</membershipRateGuarantee>
<membershipPersonCharacteristic>
  <characteristicsList>
    <characteristicType></characteristicType>
    <characteristicValue></characteristicValue>
    <effectiveDate></effectiveDate>
  </characteristicsList>
  <characteristicsList>
    <characteristicType></characteristicType>
    <characteristicValue></characteristicValue>
    <effectiveDate></effectiveDate>
  </characteristicsList>
</membershipPersonCharacteristic>
<benefitData>
  <benefitDataList>
    <sequence></sequence>
    <startDate></startDate>
    <endDate></endDate>
    <benefitStatus></benefitStatus>
    <benefitSourceFlag></benefitSourceFlag>
    <benefitTypeFlag></benefitTypeFlag>
    <benefitSubTypeFlag></benefitSubTypeFlag>
    <planBenefitPackageId></planBenefitPackageId>
    <benefitAmount></benefitAmount>
    <characteristics>
      <characteristicsList>
        <characteristicType></characteristicType>
        <characteristicValue></
characteristicValue>
          <effectiveDate></effectiveDate>
        </characteristicsList>
      </characteristics>
    </benefitDataList>
  </benefitData>
<billableChargeData>
  <sequence></sequence>
  <accountIdType></accountIdType>
  <accountIdValue></accountIdValue>
  <chargeType></chargeType>
  <startDate></startDate>
  <endDate></endDate>
  <priceItemCode></priceItemCode>
  <description></description>
  <recurringMethod></recurringMethod>
  <billPeriod></billPeriod>
  <frequency></frequency>
  <billAfterDt></billAfterDt>
  <billableChargeLines>
    <descriptionOnBill></descriptionOnBill>
    <currencyCode></currencyCode>
    <chargeAmount></chargeAmount>
    <showOnBillSw></showOnBillSw>
    <appearInSummarySw></appearInSummarySw>
    <distributionCode></distributionCode>
  </billableChargeLines>
  <characteristics>
    <characteristicsList>
      <characteristicType></characteristicType>

```

```

                <characteristicValue></characteristicValue>
                <effectiveDate></effectiveDate>
            </characteristicsList>
        </characteristics>
    </billableChargeData>
</memberData>
<accountData>
    <accountType>CMS</accountType>
    <customerClass>HC</customerClass>
    <billCycle>BK01</billCycle>
    <billLeadDays>10</billLeadDays>
    <division>HC</division>
    <currency>USD</currency>
    <setUpDate>2019-01-01</setUpDate>
    <acctUsageFlg>USAG</acctUsageFlg>
    <comments></comments>
    <deferAutoPayDt></deferAutoPayDt>
    <collectionClass></collectionClass>
    <billRouteType>POSTAL</billRouteType>
    <billAddressSource>PER</billAddressSource>
    <identifiers>
        <idType>ACCT_NM</idType>
        <idValue>Medical Account</idValue>
        <isPrimary>true</isPrimary>
    </identifiers>
    <address>
        <addressEffDate>2019-01-01</addressEffDate>
        <addressType></addressType>
        <address1></address1>
        <address2></address2>
        <address3></address3>
        <address4></address4>
        <city></city>
        <state></state>
        <zip></zip>
        <country></country>
        <houseType></houseType>
        <streetNumber1></streetNumber1>
        <streetNumber2></streetNumber2>
        <inCityLimit></inCityLimit>
        <taxVendorGeographicalCode></
taxVendorGeographicalCode>
        <county></county>
    </address>
</accountData>
<accountData>
    <accountType>CMR</accountType>
    <customerClass>HC</customerClass>
    <billCycle>BK02</billCycle>
    <billLeadDays>10</billLeadDays>
    <division>HC</division>
    <currency>USD</currency>
    <setUpDate>2019-01-01</setUpDate>
    <acctUsageFlg>USAG</acctUsageFlg>
    <comments></comments>
    <deferAutoPayDt></deferAutoPayDt>
    <collectionClass></collectionClass>
    <billRouteType>POSTAL</billRouteType>
    <billAddressSource>ACOV</billAddressSource>
    <identifiers>
        <idType>ACCT_NM</idType>
        <idValue>Dental Account</idValue>
        <isPrimary>true</isPrimary>
    </identifiers>

```

```

    <address>
      <addressEffDate>2019-01-01</addressEffDate>
      <addressType>OVRD</addressType>
      <address1>Saturn Park</address1>
      <address2>Saturn Street</address2>
      <address3>River Side</address3>
      <address4></address4>
      <city>San Francisco</city>
      <state>CA</state>
      <zip>94122</zip>
      <country>USA</country>
      <houseType></houseType>
      <streetNumber1></streetNumber1>
      <streetNumber2></streetNumber2>
      <inCityLimit></inCityLimit>
      <taxVendorGeographicalCode></
taxVendorGeographicalCode>
      <county></county>
    </address>
  </accountData>
  <policyData>
    <policyType>GROUP CUSTOMER</policyType>
    <sourceSystem>SMALLPRIME</sourceSystem>
    <policyNumber>AP234367</policyNumber>
    <description>Employee Medicare Policy</description>
    <advancedLevelFundingEligibility></
advancedLevelFundingEligibility>
    <startDate>2019-01-01</startDate>
    <endDate>2019-12-31</endDate>
    <policyPersons>
      <idType></idType>
      <idValue></idValue>
      <policyPerRole></policyPerRole>
      <startDate></startDate>
      <endDate></endDate>
    </policyPersons>
    <terminationInformation>
      <terminateDate></terminateDate>
      <terminationReason></terminationReason>
    </terminationInformation>
    <reinstateInformation>
      <reinstatementDate></reinstatementDate>
      <reinstateReason></reinstateReason>
    </reinstateInformation>
    <characteristics>
      <characteristicsList>
        <characteristicType>C1PRBASE</characteristicType>
        <characteristicValue>Y</characteristicValue>
        <effectiveDate>2019-01-01</effectiveDate>
      </characteristicsList>
      <characteristicsList>
        <characteristicType>C1STISSE</characteristicType>
        <characteristicValue>VG</characteristicValue>
        <effectiveDate>2019-01-01</effectiveDate>
      </characteristicsList>
    </characteristics>
  <planData>
    <planNumber>APE_MEDI_BRONZE_M</planNumber>
    <priceItemCode></priceItemCode>
    <planName>APE Medicare Bronze RE MALE</planName>
    <pricingRuleTypeList>
      <pricingRuleType>AGE_BASED</pricingRuleType>
    </pricingRuleTypeList>
    <startDate>2019-01-01</startDate>

```

```

        <endDate>2019-12-31</endDate>
        <primaryPlanSw>N</primaryPlanSw>
        <characteristics>
            <characteristicsList>
                <characteristicType>C1HPLNID</
characteristicType>
                    <characteristicValue>300</characteristicValue>
                    <effectiveDate>2019-01-01</effectiveDate>
                </characteristicsList>
            </characteristics>
        </planData>
    <planData>
        <planNumber>APE_MEDI_SILVER_M</planNumber>
        <priceItemCode></priceItemCode>
        <planName>APE Medicare Silver RE MALE</planName>
        <pricingRuleTypeList>
            <pricingRuleType>AGE_BASED</pricingRuleType>
        </pricingRuleTypeList>
        <startDate>2019-01-01</startDate>
        <endDate>2019-12-31</endDate>
        <primaryPlanSw>N</primaryPlanSw>
        <characteristics>
            <characteristicsList>
                <characteristicType>C1HPLNID</
characteristicType>
                    <characteristicValue>310</characteristicValue>
                    <effectiveDate>2019-01-01</effectiveDate>
                </characteristicsList>
            </characteristics>
        </planData>
    <planData>
        <planNumber>APE_MEDI_GOLD_M</planNumber>
        <priceItemCode></priceItemCode>
        <planName>APE Medicare Gold RE MALE</planName>
        <pricingRuleTypeList>
            <pricingRuleType>AGE_BASED</pricingRuleType>
        </pricingRuleTypeList>
        <startDate>2019-01-01</startDate>
        <endDate>2019-12-31</endDate>
        <primaryPlanSw>N</primaryPlanSw>
        <characteristics>
            <characteristicsList>
                <characteristicType>C1HPLNID</
characteristicType>
                    <characteristicValue>320</characteristicValue>
                    <effectiveDate>2019-01-01</effectiveDate>
                </characteristicsList>
            </characteristics>
        </planData>
    <planData>
        <planNumber>APE_MEDI_BRONZE_F</planNumber>
        <priceItemCode></priceItemCode>
        <planName>APE Medicare Bronze RE FEMALE</planName>
        <pricingRuleTypeList>
            <pricingRuleType>AGE_BASED</pricingRuleType>
        </pricingRuleTypeList>
        <startDate>2019-01-01</startDate>
        <endDate>2019-12-31</endDate>
        <primaryPlanSw>N</primaryPlanSw>
        <characteristics>
            <characteristicsList>
                <characteristicType>C1HPLNID</
characteristicType>
                    <characteristicValue>330</characteristicValue>

```

```

                <effectiveDate>2019-01-01</effectiveDate>
            </characteristicsList>
        </characteristics>
    </planData>
    <planData>
        <planNumber>APE_MEDI_SILVER_F</planNumber>
        <priceItemCode></priceItemCode>
        <planName>APE Medicare Silver RE FEMALE</planName>
        <pricingRuleTypeList>
            <pricingRuleType>AGE_BASED</pricingRuleType>
        </pricingRuleTypeList>
        <startDate>2019-01-01</startDate>
        <endDate>2019-12-31</endDate>
        <primaryPlanSw>N</primaryPlanSw>
        <characteristics>
            <characteristicsList>
                <characteristicType>C1HPLNID</
characteristicType>
                    <characteristicValue>340</characteristicValue>
                    <effectiveDate>2019-01-01</effectiveDate>
                </characteristicsList>
            </characteristics>
        </planData>
        <planData>
            <planNumber>APE_MEDI_GOLD_F</planNumber>
            <priceItemCode></priceItemCode>
            <planName>APE Medicare Gold RE FEMALE</planName>
            <pricingRuleTypeList>
                <pricingRuleType>AGE_BASED</pricingRuleType>
            </pricingRuleTypeList>
            <startDate>2019-01-01</startDate>
            <endDate>2019-12-31</endDate>
            <primaryPlanSw>N</primaryPlanSw>
            <characteristics>
                <characteristicsList>
                    <characteristicType>C1HPLNID</
characteristicType>
                        <characteristicValue>350</characteristicValue>
                        <effectiveDate>2019-01-01</effectiveDate>
                    </characteristicsList>
                </characteristics>
            </planData>
        </policyData>
    </personData>
</customerStructureData>
</customerStructureMessage>
</schema>

```

Sample Health Care Inbound Message for Self-Funded Customer Setup

Using the below example, you can do the following:

- Create the parent customer and bill groups for a self-funded health insurance business
- Create the accounts for the bill groups
- Create the policies for the bill groups where the policy category is set to **Self-Funded**

Person Name	Person Type	Policy	Account
US Energy Corp	Parent Customer	-	-

Person Name	Person Type	Policy	Account
US Energy ACTIVE	Bill Group	Active Employee Health Insurance Policy	Standard
			Retention
US Energy COBRA	Bill Group	Active COBRA Employee Health Insurance Policy	Standard
		Retiree COBRA Employee Health Insurance Policy	Retention
US Energy RETIREE	Bill Group	Retiree Employee Health Insurance Policy	Standard
			Retention

In addition, using the below example, you can create the following derivation and pricing parameters for the above three bill groups:

Bill Group	Source System	Parameter 1	Parameter 2	Parameter 3	Parameter 4
US Energy ACTIVE	SMALLPRIME	ACTIVE	SEATTLE	-	-
	SMALLPRIME	ACTIVE	LOS ANGELES	-	-
US Energy COBRA	SMALLPRIME	COBRA	DALLAS	-	-
	SMALLPRIME	COBRA	SAN JOSE	-	-
US Energy RETIREE	SMALLPRIME	RETIRED	CHARLOTTE	-	-
	SMALLPRIME	RETIRED	DETROIT	-	-

```

<schema>
  <bo>C1-HCInboundMessage</bo>
  <characteristics>
    <inboundMessageCharacteristic>
      <ad hocCharacteristicValue></ad hocCharacteristicValue>
      <characteristicType>C1-EXTBTCT</characteristicType>
      <effectiveDate>2019-01-01</effectiveDate>
      <characteristicValue>DATAEXT4</characteristicValue>
      <characteristicValueForeignKey1></characteristicValueForeignKey1>
      <characteristicValueFK2></characteristicValueFK2>
      <characteristicValueFK3></characteristicValueFK3>
      <characteristicValueFK4></characteristicValueFK4>
      <characteristicValueFK5></characteristicValueFK5>
    </inboundMessageCharacteristic>
  </characteristics>
  <customerStructureMessage>
    <headerData>
      <messageType>C1-HEALTHCARE-INB-MSG-TYPE</messageType>
      <sourceSystem>SMALLPRIME</sourceSystem>
      <externalTransactionId>675376</externalTransactionId>
      <externalBatchId>898657</externalBatchId>
      <externalSourceId>656565</externalSourceId>
    </headerData>
    <customerStructureData>
      <personData>

```

```

<sequence>1</sequence>
<personType>PG</personType>
<personName>
  <sequence>1</sequence>
  <entityName>US Energy Corp</entityName>
  <nameType>PRIM</nameType>
</personName>
<identifiers>
  <idType>EIN</idType>
  <idValue>98-7654329</idValue>
  <isPrimary>Y</isPrimary>
</identifiers>
<division>HC</division>
<birthDate>1980-03-24</birthDate>
<sinceDate>2019-01-01</sinceDate>
<address>
  <addressEffDate>2019-01-01</addressEffDate>
  <addressType>MAIN</addressType>
  <mailingName>US Energy Corp</mailingName>
  <address1>Saturn Park</address1>
  <address2>Saturn Street</address2>
  <address3>River Side</address3>
  <address4></address4>
  <city>San Francisco</city>
  <state>CA</state>
  <zip>94122</zip>
  <country>USA</country>
  <houseType></houseType>
  <streetNumber1></streetNumber1>
  <streetNumber2></streetNumber2>
  <inCityLimit></inCityLimit>
  <taxVendorGeographicalCode></taxVendorGeographicalCode>
  <county></county>
</address>
<email>usencp@example.com</email>
<overrideMailingName1>US Energy Corporation</
overrideMailingName1>
<overrideMailingName2></overrideMailingName2>
<overrideMailingName3></overrideMailingName3>
<phones>
  <phoneType>BUSN</phoneType>
  <phoneValue>415-555-0100</phoneValue>
</phones>
<relatedPersons>
  <idType></idType>
  <idValue></idValue>
  <personRelationshipType></personRelationshipType>
  <startDate></startDate>
  <endDate></endDate>
  <financialRelationshipSw></financialRelationshipSw>
  <parentOrChild></parentOrChild>
  <characteristics>
    <characteristicsList>
      <characteristicType></characteristicType>
      <characteristicValue></characteristicValue>
      <effectiveDate></effectiveDate>
    </characteristicsList>
  </characteristics>
</relatedPersons>
<characteristics>
  <characteristicsList>
    <characteristicType>PER_CAT</characteristicType>
    <characteristicValue>EMPOLYER</characteristicValue>
    <effectiveDate>2019-01-01</effectiveDate>
  </characteristicsList>
</characteristics>

```

```

        </characteristicsList>
      </characteristics>
    </personData>
  <personData>
    <sequence>2</sequence>
    <personType>BG</personType>
    <personName>
      <sequence>1</sequence>
      <entityName>US Energy ACTIVE</entityName>
      <nameType>PRIM</nameType>
    </personName>
    <identifiers>
      <idType>EIN</idType>
      <idValue>98-7654320</idValue>
      <isPrimary>Y</isPrimary>
    </identifiers>
    <division>HC</division>
    <birthDate>1991-05-09</birthDate>
    <sinceDate>2019-01-01</sinceDate>
    <address>
      <addressEffDate>2019-01-01</addressEffDate>
      <addressType>MAIN</addressType>
      <mailingName>US Energy ACTIVE</mailingName>
      <address1>Mars Park</address1>
      <address2>Mars Street</address2>
      <address3>Lake Side</address3>
      <address4></address4>
      <city>Los Angeles</city>
      <state>CA</state>
      <zip>90020</zip>
      <country>USA</country>
      <houseType></houseType>
      <streetNumber1></streetNumber1>
      <streetNumber2></streetNumber2>
      <inCityLimit></inCityLimit>
      <taxVendorGeographicalCode></taxVendorGeographicalCode>
      <county></county>
    </address>
    <email>usencpa@example.com</email>
    <overrideMailingName1></overrideMailingName1>
    <overrideMailingName2></overrideMailingName2>
    <overrideMailingName3></overrideMailingName3>
    <phones>
      <phoneType>BUSN</phoneType>
      <phoneValue>661-555-0111</phoneValue>
    </phones>
    <relatedPersons>
      <idType>EIN</idType>
      <idValue>98-7654329</idValue>
      <personRelationshipType></personRelationshipType>
      <startDate>2019-01-01</startDate>
      <endDate>2019-12-31</endDate>
      <financialRelationshipSw>>false</financialRelationshipSw>
      <parentOrChild>P</parentOrChild>
      <characteristics>
        <characteristicsList>
          <characteristicType></characteristicType>
          <characteristicValue></characteristicValue>
          <effectiveDate></effectiveDate>
        </characteristicsList>
      </characteristics>
    </relatedPersons>
  </characteristics>
</characteristicsList>

```

```

        <characteristicType>PER_CAT</characteristicType>
        <characteristicValue>OTHER</characteristicValue>
        <effectiveDate>2019-01-01</effectiveDate>
    </characteristicsList>
</characteristics>
<billLevelParameters>
    <sequence>1</sequence>
    <sourceSystem>SMALLPRIME</sourceSystem>
    <billLevelInfo1>ACTIVE</billLevelInfo1>
    <billLevelInfo2>SEATTLE</billLevelInfo2>
    <effectiveDate>2019-01-01</effectiveDate>
</billLevelParameters>
<billLevelParameters>
    <sequence>2</sequence>
    <sourceSystem>SMALLPRIME</sourceSystem>
    <billLevelInfo1>ACTIVE</billLevelInfo1>
    <billLevelInfo2>LOS ANGELES</billLevelInfo2>
    <effectiveDate>2019-01-01</effectiveDate>
</billLevelParameters>
<memberData>
    <startDate></startDate>
    <endDate></endDate>
    <paidThroughDate></paidThroughDate>
    <memberId></memberId>
    <memberRelationship></memberRelationship>
    <membershipPersonStatus></membershipPersonStatus>
    <membershipPersonStatusReason></
membershipPersonStatusReason>
    <autoRenew></autoRenew>
    <associatedMemberIdentifierType></
associatedMemberIdentifierType>
    <associatedMemberIdentifier></associatedMemberIdentifier>
    <exchangeFlag></exchangeFlag>
    <exchangeId></exchangeId>
    <binderLiabilityAmount></binderLiabilityAmount>
    <binderPayApplicability></binderPayApplicability>
    <binderPayGraceDays></binderPayGraceDays>
    <binderPayThreshold></binderPayThreshold>
    <holdBilling></holdBilling>
    <membershipRenewalDate></membershipRenewalDate>
    <contractPeriod></contractPeriod>
    <membershipIdentifier>
        <membershipIdentifierType></membershipIdentifierType>
        <membershipIdentifierValue></
membershipIdentifierValue>
    </membershipIdentifier>
    <isMemberSw></isMemberSw>
    <isFinanciallyResponsibleSw></isFinanciallyResponsibleSw>
    <membershipType></membershipType>
    <externalMedicareBeneficiaryId></
externalMedicareBeneficiaryId>
    <mainSubscriber>
        <idType></idType>
        <idValue></idValue>
        <membershipType></membershipType>
    </mainSubscriber>
    <policyNumber></policyNumber>
    <sourceSystem></sourceSystem>
    <planNumber></planNumber>
    <healthPlanCode></healthPlanCode>
    <characteristics>
        <characteristicsList>
            <characteristicType></characteristicType>
            <characteristicValue></characteristicValue>

```

```

        <effectiveDate></effectiveDate>
      </characteristicsList>
    </characteristics>
  <membershipRateGuarantee>
    <membershipRateGuaranteeList>
      <rateGuaranteeStartDate></rateGuaranteeStartDate>
      <rateGuaranteeEndDate></rateGuaranteeEndDate>
      <rateGuaranteeStatus></rateGuaranteeStatus>
    </membershipRateGuaranteeList>
  </membershipRateGuarantee>
  <membershipPersonCharacteristic>
    <characteristicsList>
      <characteristicType></characteristicType>
      <characteristicValue></characteristicValue>
      <effectiveDate></effectiveDate>
    </characteristicsList>
    <characteristicsList>
      <characteristicType></characteristicType>
      <characteristicValue></characteristicValue>
      <effectiveDate></effectiveDate>
    </characteristicsList>
  </membershipPersonCharacteristic>
  <benefitData>
    <benefitDataList>
      <sequence></sequence>
      <startDate></startDate>
      <endDate></endDate>
      <benefitStatus></benefitStatus>
      <benefitSourceFlag></benefitSourceFlag>
      <benefitTypeFlag></benefitTypeFlag>
      <benefitSubTypeFlag></benefitSubTypeFlag>
      <planBenefitPackageId></planBenefitPackageId>
      <benefitAmount></benefitAmount>
      <characteristics>
        <characteristicsList>
          <characteristicType></characteristicType>
          <characteristicValue></
characteristicValue>
          <effectiveDate></effectiveDate>
        </characteristicsList>
      </characteristics>
    </benefitDataList>
  </benefitData>
  <billableChargeData>
    <sequence></sequence>
    <accountIdType></accountIdType>
    <accountIdValue></accountIdValue>
    <chargeType></chargeType>
    <startDate></startDate>
    <endDate></endDate>
    <priceItemCode></priceItemCode>
    <description></description>
    <recurringMethod></recurringMethod>
    <billPeriod></billPeriod>
    <frequency></frequency>
    <billAfterDt></billAfterDt>
    <billableChargeLines>
      <descriptionOnBill></descriptionOnBill>
      <currencyCode></currencyCode>
      <chargeAmount></chargeAmount>
      <showOnBillSw></showOnBillSw>
      <appearInSummarySw></appearInSummarySw>
      <distributionCode></distributionCode>
    </billableChargeLines>
  </billableChargeData>

```

```

        <characteristics>
            <characteristicsList>
                <characteristicType></characteristicType>
                <characteristicValue></characteristicValue>
                <effectiveDate></effectiveDate>
            </characteristicsList>
        </characteristics>
    </billableChargeData>
</memberData>
<accountData>
    <accountType>Standard</accountType>
    <customerClass>HC</customerClass>
    <billCycle>BK01</billCycle>
    <billLeadDays>10</billLeadDays>
    <division>HC</division>
    <currency>USD</currency>
    <setUpDate>2019-01-01</setUpDate>
    <acctUsageFlg>USAG</acctUsageFlg>
    <comments></comments>
    <deferAutoPayDt></deferAutoPayDt>
    <collectionClass></collectionClass>
    <billRouteType>POSTAL</billRouteType>
    <billAddressSource>PER</billAddressSource>
    <identifiers>
        <idType>ACCT_NM</idType>
        <idValue>Standard Account</idValue>
        <isPrimary>true</isPrimary>
    </identifiers>
    <address>
        <addressEffDate>2019-01-01</addressEffDate>
        <addressType></addressType>
        <address1></address1>
        <address2>Fresno</address2>
        <address3></address3>
        <address4></address4>
        <city></city>
        <state></state>
        <zip></zip>
        <country></country>
        <houseType></houseType>
        <streetNumber1></streetNumber1>
        <streetNumber2></streetNumber2>
        <inCityLimit></inCityLimit>
        <taxVendorGeographicalCode></
taxVendorGeographicalCode>
        <county></county>
    </address>
    <autoPayDetails>
        <priority></priority>
        <startDate></startDate>
        <endDate></endDate>
        <percentage></percentage>
        <autoPayMethod></autoPayMethod>
        <autoPayRouteType></autoPayRouteType>
        <autoPaySourceCode></autoPaySourceCode>
        <accountNumber></accountNumber>
        <expiryMonth></expiryMonth>
        <expiryYear></expiryYear>
        <name></name>
        <maxWithdrawalAmount></maxWithdrawalAmount>
        <comments></comments>
    </autoPayDetails>
    <accountPerson>
        <idType></idType>

```

```

<idValue></idValue>
<accountRelationshipType></accountRelationshipType>
<isFinanciallyResponsible></isFinanciallyResponsible>
<personAddressOverride>
  <address1></address1>
  <address2></address2>
  <address3></address3>
  <address4></address4>
  <city></city>
  <postal></postal>
  <state></state>
  <country></country>
  <houseType></houseType>
  <streetNumber1></streetNumber1>
  <streetNumber2></streetNumber2>
  <inCityLimit></inCityLimit>
  <taxVendorGeographicalCode></
taxVendorGeographicalCode>
  <county></county>
</personAddressOverride>
<accountPersonRouting>
  <billRouteType></billRouteType>
  <shouldReceiveCopyOfBill></
shouldReceiveCopyOfBill>
  <billFormat></billFormat>
  <numberOfBillCopies></numberOfBillCopies>
  <receivesNotification></receivesNotification>
  <billAddressSource></billAddressSource>
</accountPersonRouting>
</accountPerson>
<characteristics>
  <characteristicsList>
    <characteristicType></characteristicType>
    <characteristicValue></characteristicValue>
    <effectiveDate></effectiveDate>
  </characteristicsList>
</characteristics>
</accountData>
<accountData>
  <accountType>Retention</accountType>
  <customerClass>HC</customerClass>
  <billCycle>BK02</billCycle>
  <billLeadDays>10</billLeadDays>
  <division>HC</division>
  <currency>USD</currency>
  <setUpDate>2019-01-01</setUpDate>
  <acctUsageFlg>USAG</acctUsageFlg>
  <comments></comments>
  <deferAutoPayDt></deferAutoPayDt>
  <collectionClass></collectionClass>
  <billRouteType>POSTAL</billRouteType>
  <billAddressSource>ACOV</billAddressSource>
  <identifiers>
    <idType>ACCT_NM</idType>
    <idValue>Retention Account</idValue>
    <isPrimary>true</isPrimary>
  </identifiers>
  <address>
    <addressEffDate>2019-01-01</addressEffDate>
    <addressType>OVRD</addressType>
    <address1>Jupiter Park<</address1>
    <address2>Jupiter Street</address2>
    <address3>Near Corporation Bank</address3>
    <address4></address4>

```

```

        <city>Los Angeles</city>
        <state>CA</state>
        <zip>90020</zip>
        <country>USA</country>
        <houseType></houseType>
        <streetNumber1></streetNumber1>
        <streetNumber2></streetNumber2>
        <inCityLimit></inCityLimit>
        <taxVendorGeographicalCode></
taxVendorGeographicalCode>
        <county></county>
    </address>
    <autoPayDetails>
        <priority></priority>
        <startDate></startDate>
        <endDate></endDate>
        <percentage></percentage>
        <autoPayMethod></autoPayMethod>
        <autoPayRouteType></autoPayRouteType>
        <autoPaySourceCode></autoPaySourceCode>
        <accountNumber></accountNumber>
        <expiryMonth></expiryMonth>
        <expiryYear></expiryYear>
        <name></name>
        <maxWithdrawalAmount></maxWithdrawalAmount>
        <comments></comments>
    </autoPayDetails>
    <accountPerson>
        <idType></idType>
        <idValue></idValue>
        <accountRelationshipType></accountRelationshipType>
        <isFinanciallyResponsible></isFinanciallyResponsible>
        <personAddressOverride>
            <address1></address1>
            <address2></address2>
            <address3></address3>
            <address4></address4>
            <city></city>
            <postal></postal>
            <state></state>
            <country></country>
            <houseType></houseType>
            <streetNumber1></streetNumber1>
            <streetNumber2></streetNumber2>
            <inCityLimit></inCityLimit>
            <taxVendorGeographicalCode></
taxVendorGeographicalCode>
            <county></county>
        </personAddressOverride>
        <accountPersonRouting>
            <billRouteType></billRouteType>
            <shouldReceiveCopyOfBill></
shouldReceiveCopyOfBill>
            <billFormat></billFormat>
            <numberOfBillCopies></numberOfBillCopies>
            <receivesNotification></receivesNotification>
            <billAddressSource></billAddressSource>
        </accountPersonRouting>
    </accountPerson>
    <characteristics>
        <characteristicsList>
            <characteristicType></characteristicType>
            <characteristicValue></characteristicValue>
            <effectiveDate></effectiveDate>

```



```

        </characteristicsList>
      </characteristics>
    </accountData>
    <policyData>
      <policyType>SELF-FUNDED</policyType>
      <sourceSystem>SMALLPRIME</sourceSystem>
      <policyNumber>AP234900</policyNumber>
      <description>Active Employee Health Insurance Policy</
description>
      <advancedLevelFundingEligibility></
advancedLevelFundingEligibility>
      <startDate>2019-01-01</startDate>
      <endDate>2019-12-31</endDate>
      <runOutEndDate>2020-03-31</runOutEndDate>
      <runOutAdminOption>NROA</runOutAdminOption>
      <renewalDate></renewalDate>
      <policyPersons>
        <idType></idType>
        <idValue></idValue>
        <policyPerRole></policyPerRole>
        <startDate></startDate>
        <endDate></endDate>
      </policyPersons>
      <terminationInformation>
        <terminateDate></terminateDate>
        <terminationReason></terminationReason>
      </terminationInformation>
      <reinstateInformation>
        <reinstatementDate></reinstatementDate>
        <reinstateReason></reinstateReason>
      </reinstateInformation>
      <characteristics>
        <characteristicsList>
          <characteristicType></characteristicType>
          <characteristicValue></characteristicValue>
          <effectiveDate></effectiveDate>
        </characteristicsList>
      </characteristics>
    <planData>
      <planNumber></planNumber>
      <priceItemCode></priceItemCode>
      <planName></planName>
      <priceItemCode></priceItemCode>
      <planName></planName>
      <pricingRuleTypeList>
        <pricingRuleType></pricingRuleType>
      </pricingRuleTypeList>
      <startDate></startDate>
      <endDate></endDate>
      <primaryPlanSw></primaryPlanSw>
      <benefitTypeFlag></benefitTypeFlag>
      <characteristics>
        <characteristicsList>
          <characteristicType></characteristicType>
          <characteristicValue></characteristicValue>
          <effectiveDate></effectiveDate>
        </characteristicsList>
      </characteristics>
      <policyPlanProrationRuleList>
        <effectiveDate></effectiveDate>
        <prorationEventType></prorationEventType>
        <prorationType></prorationType>
        <numberOfDays></numberOfDays>
        <membershipType></membershipType>

```

```

        </policyPlanProrationRuleList>
    </planData>
</policyData>
</personData>
<personData>
    <sequence>3</sequence>
    <personType>BG</personType>
    <personName>
        <sequence>1</sequence>
        <entityName>US Energy COBRA</entityName>
        <nameType>PRIM</nameType>
    </personName>
    <identifiers>
        <idType>EIN</idType>
        <idValue>98-7654321</idValue>
        <isPrimary>Y</isPrimary>
    </identifiers>
    <division>HC</division>
    <birthDate>1976-01-12</birthDate>
    <sinceDate>2019-01-01</sinceDate>
    <address>
        <addressEffDate>2019-01-01</addressEffDate>
        <addressType>MAIN</addressType>
        <mailingName>US Energy COBRA</mailingName>
        <address1>Venus Park</address1>
        <address2>Venus Street</address2>
        <address3>Lake Side</address3>
        <address4></address4>
        <city>Los Angeles</city>
        <state>CA</state>
        <zip>90020</zip>
        <country>USA</country>
        <houseType></houseType>
        <streetNumber1></streetNumber1>
        <streetNumber2></streetNumber2>
        <inCityLimit></inCityLimit>
        <taxVendorGeographicalCode></taxVendorGeographicalCode>
        <county></county>
    </address>
    <email>usencpco@example.com</email>
    <overrideMailingName1></overrideMailingName1>
    <overrideMailingName2></overrideMailingName2>
    <overrideMailingName3></overrideMailingName3>
    <phones>
        <phoneType>BUSN</phoneType>
        <phoneValue>213-555-0175</phoneValue>
    </phones>
    <relatedPersons>
        <idType>EIN</idType>
        <idValue>98-7654329</idValue>
        <personRelationshipType></personRelationshipType>
        <startDate>2019-01-01</startDate>
        <endDate>2019-12-31</endDate>
        <financialRelationshipSw>>false</financialRelationshipSw>
        <parentOrChild>P</parentOrChild>
        <characteristics>
            <characteristicsList>
                <characteristicType></characteristicType>
                <characteristicValue></characteristicValue>
                <effectiveDate></effectiveDate>
            </characteristicsList>
        </characteristics>
    </relatedPersons>
</characteristics>

```

```

        <characteristicsList>
            <characteristicType>PER_CAT</characteristicType>
            <characteristicValue>OTHER</characteristicValue>
            <effectiveDate>2019-01-01</effectiveDate>
        </characteristicsList>
    </characteristics>
    <billLevelParameters>
        <sequence>15</sequence>
        <sourceSystem>SMALLPRIME</sourceSystem>
        <billLevelInfo1>COBRA</billLevelInfo1>
        <billLevelInfo2>DALLAS</billLevelInfo2>
        <effectiveDate>2019-01-01</effectiveDate>
    </billLevelParameters>
    <billLevelParameters>
        <sequence>16</sequence>
        <sourceSystem>SMALLPRIME</sourceSystem>
        <billLevelInfo1>COBRA</billLevelInfo1>
        <billLevelInfo2>SAN JOSE</billLevelInfo2>
        <effectiveDate>2019-01-01</effectiveDate>
    </billLevelParameters>
    <memberData>
        <startDate></startDate>
        <endDate></endDate>
        <paidThroughDate></paidThroughDate>
        <memberId></memberId>
        <memberRelationship></memberRelationship>
        <membershipPersonStatus></membershipPersonStatus>
        <membershipPersonStatusReason></
membershipPersonStatusReason>
        <autoRenew></autoRenew>
        <associatedMemberIdentifierType></
associatedMemberIdentifierType>
        <associatedMemberIdentifier></associatedMemberIdentifier>
        <exchangeFlag></exchangeFlag>
        <exchangeId></exchangeId>
        <binderLiabilityAmount></binderLiabilityAmount>
        <binderPayApplicability></binderPayApplicability>
        <binderPayGraceDays></binderPayGraceDays>
        <binderPayThreshold></binderPayThreshold>
        <holdBilling></holdBilling>
        <membershipRenewalDate></membershipRenewalDate>
        <contractPeriod></contractPeriod>
        <membershipIdentifier>
            <membershipIdentifierType></membershipIdentifierType>
            <membershipIdentifierValue></
membershipIdentifierValue>
        </membershipIdentifier>
        <isMemberSw></isMemberSw>
        <isFinanciallyResponsibleSw></isFinanciallyResponsibleSw>
        <membershipType></membershipType>
        <externalMedicareBeneficiaryId></
externalMedicareBeneficiaryId>
        <mainSubscriber>
            <idType></idType>
            <idValue></idValue>
            <membershipType></membershipType>
        </mainSubscriber>
        <policyNumber></policyNumber>
        <sourceSystem></sourceSystem>
        <planNumber></planNumber>
        <healthPlanCode></healthPlanCode>
        <characteristics>
            <characteristicsList>
                <characteristicType></characteristicType>

```

```

        <characteristicValue></characteristicValue>
        <effectiveDate></effectiveDate>
    </characteristicsList>
</characteristics>
<membershipRateGuarantee>
    <membershipRateGuaranteeList>
        <rateGuaranteeStartDate></rateGuaranteeStartDate>
        <rateGuaranteeEndDate></rateGuaranteeEndDate>
        <rateGuaranteeStatus></rateGuaranteeStatus>
    </membershipRateGuaranteeList>
</membershipRateGuarantee>
<membershipPersonCharacteristic>
    <characteristicsList>
        <characteristicType></characteristicType>
        <characteristicValue></characteristicValue>
        <effectiveDate></effectiveDate>
    </characteristicsList>
    <characteristicsList>
        <characteristicType></characteristicType>
        <characteristicValue></characteristicValue>
        <effectiveDate></effectiveDate>
    </characteristicsList>
</membershipPersonCharacteristic>
<benefitData>
    <benefitDataList>
        <sequence></sequence>
        <startDate></startDate>
        <endDate></endDate>
        <benefitStatus></benefitStatus>
        <benefitSourceFlag></benefitSourceFlag>
        <benefitTypeFlag></benefitTypeFlag>
        <benefitSubTypeFlag></benefitSubTypeFlag>
        <planBenefitPackageId></planBenefitPackageId>
        <benefitAmount></benefitAmount>
        <characteristics>
            <characteristicsList>
                <characteristicType></characteristicType>
                <characteristicValue></
characteristicValue>
                    <effectiveDate></effectiveDate>
            </characteristicsList>
        </characteristics>
    </benefitDataList>
</benefitData>
<billableChargeData>
    <sequence></sequence>
    <accountIdType></accountIdType>
    <accountIdValue></accountIdValue>
    <chargeType></chargeType>
    <startDate></startDate>
    <endDate></endDate>
    <priceItemCode></priceItemCode>
    <description></description>
    <recurringMethod></recurringMethod>
    <billPeriod></billPeriod>
    <frequency></frequency>
    <billAfterDt></billAfterDt>
    <billableChargeLines>
        <descriptionOnBill></descriptionOnBill>
        <currencyCode></currencyCode>
        <chargeAmount></chargeAmount>
        <showOnBillSw></showOnBillSw>
        <appearInSummarySw></appearInSummarySw>
        <distributionCode></distributionCode>

```

```

        </billableChargeLines>
        <characteristics>
            <characteristicsList>
                <characteristicType></characteristicType>
                <characteristicValue></characteristicValue>
                <effectiveDate></effectiveDate>
            </characteristicsList>
        </characteristics>
    </billableChargeData>
</memberData>
<accountData>
    <accountType>Standard</accountType>
    <customerClass>HC</customerClass>
    <billCycle>BK01</billCycle>
    <billLeadDays>10</billLeadDays>
    <division>HC</division>
    <currency>USD</currency>
    <setUpDate>2019-01-01</setUpDate>
    <acctUsageFlg>USAG</acctUsageFlg>
    <comments></comments>
    <deferAutoPayDt></deferAutoPayDt>
    <collectionClass></collectionClass>
    <billRouteType>POSTAL</billRouteType>
    <billAddressSource>PER</billAddressSource>
    <identifiers>
        <idType>ACCT_NM</idType>
        <idValue>Standard Account</idValue>
        <isPrimary>true</isPrimary>
    </identifiers>
    <address>
        <addressEffDate>2019-01-01</addressEffDate>
        <addressType></addressType>
        <address1><</address1>
        <address2></address2>
        <address3></address3>
        <address4></address4>
        <city></city>
        <state></state>
        <zip></zip>
        <country></country>
        <houseType></houseType>
        <streetNumber1></streetNumber1>
        <streetNumber2></streetNumber2>
        <inCityLimit></inCityLimit>
        <taxVendorGeographicalCode></
taxVendorGeographicalCode>
        <county></county>
    </address>
    <autoPayDetails>
        <priority></priority>
        <startDate></startDate>
        <endDate></endDate>
        <percentage></percentage>
        <autoPayMethod></autoPayMethod>
        <autoPayRouteType></autoPayRouteType>
        <autoPaySourceCode></autoPaySourceCode>
        <accountNumber></accountNumber>
        <expiryMonth></expiryMonth>
        <expiryYear></expiryYear>
        <name></name>
        <maxWithdrawalAmount></maxWithdrawalAmount>
        <comments></comments>
    </autoPayDetails>
</accountPerson>

```

```

<idType></idType>
<idValue></idValue>
<accountRelationshipType></accountRelationshipType>
<isFinanciallyResponsible></isFinanciallyResponsible>
<personAddressOverride>
  <address1></address1>
  <address2></address2>
  <address3></address3>
  <address4></address4>
  <city></city>
  <postal></postal>
  <state></state>
  <country></country>
  <houseType></houseType>
  <streetNumber1></streetNumber1>
  <streetNumber2></streetNumber2>
  <inCityLimit></inCityLimit>
  <taxVendorGeographicalCode></
taxVendorGeographicalCode>
  <county></county>
</personAddressOverride>
<accountPersonRouting>
  <billRouteType></billRouteType>
  <shouldReceiveCopyOfBill></
shouldReceiveCopyOfBill>
  <billFormat></billFormat>
  <numberOfBillCopies></numberOfBillCopies>
  <receivesNotification></receivesNotification>
  <billAddressSource></billAddressSource>
</accountPersonRouting>
</accountPerson>
<characteristics>
  <characteristicsList>
    <characteristicType></characteristicType>
    <characteristicValue></characteristicValue>
    <effectiveDate></effectiveDate>
  </characteristicsList>
</characteristics>
</accountData>
<accountData>
  <accountType>Retention</accountType>
  <customerClass>HC</customerClass>
  <billCycle>BK02</billCycle>
  <billLeadDays>10</billLeadDays>
  <division>HC</division>
  <currency>USD</currency>
  <setUpDate>2019-01-01</setUpDate>
  <acctUsageFlg>USAG</acctUsageFlg>
  <comments></comments>
  <deferAutoPayDt></deferAutoPayDt>
  <collectionClass></collectionClass>
  <billRouteType>POSTAL</billRouteType>
  <billAddressSource>ACOV</billAddressSource>
  <identifiers>
    <idType>ACCT_NM</idType>
    <idValue>Retention Account</idValue>
    <isPrimary>true</isPrimary>
  </identifiers>
  <address>
    <addressEffDate>2019-01-01</addressEffDate>
    <addressType>OVRD</addressType>
    <address1>Venus Park</address1>
    <address2>Venus Street</address2>
    <address3>Lake Side</address3>

```

```

        <address4></address4>
        <city>Los Angeles</city>
        <state>CA</state>
        <zip>90020</zip>
        <country>USA</country>
        <houseType></houseType>
        <streetNumber1></streetNumber1>
        <streetNumber2></streetNumber2>
        <inCityLimit></inCityLimit>
        <taxVendorGeographicalCode></
taxVendorGeographicalCode>
        <county></county>
    </address>
    <autoPayDetails>
        <priority></priority>
        <startDate></startDate>
        <endDate></endDate>
        <percentage></percentage>
        <autoPayMethod></autoPayMethod>
        <autoPayRouteType></autoPayRouteType>
        <autoPaySourceCode></autoPaySourceCode>
        <accountNumber></accountNumber>
        <expiryMonth></expiryMonth>
        <expiryYear></expiryYear>
        <name></name>
        <maxWithdrawalAmount></maxWithdrawalAmount>
        <comments></comments>
    </autoPayDetails>
    <accountPerson>
        <idType></idType>
        <idValue></idValue>
        <accountRelationshipType></accountRelationshipType>
        <isFinanciallyResponsible></isFinanciallyResponsible>
        <personAddressOverride>
            <address1></address1>
            <address2></address2>
            <address3></address3>
            <address4></address4>
            <city></city>
            <postal></postal>
            <state></state>
            <country></country>
            <houseType></houseType>
            <streetNumber1></streetNumber1>
            <streetNumber2></streetNumber2>
            <inCityLimit></inCityLimit>
            <taxVendorGeographicalCode></
taxVendorGeographicalCode>
            <county></county>
        </personAddressOverride>
        <accountPersonRouting>
            <billRouteType></billRouteType>
            <shouldReceiveCopyOfBill></
shouldReceiveCopyOfBill>
            <billFormat></billFormat>
            <numberOfBillCopies></numberOfBillCopies>
            <receivesNotification></receivesNotification>
            <billAddressSource></billAddressSource>
        </accountPersonRouting>
    </accountPerson>
    <characteristics>
        <characteristicsList>
            <characteristicType></characteristicType>
            <characteristicValue></characteristicValue>

```

```

        <effectiveDate></effectiveDate>
      </characteristicsList>
    </characteristics>
  </accountData>
  <policyData>
    <policyType>SELF-FUNDED</policyType>
    <sourceSystem>SMALLPRIME</sourceSystem>
    <policyNumber>AP234902</policyNumber>
    <description>Active COBRA Employee Health Insurance
Policy</description>
    <startDate>2019-01-01</startDate>
    <endDate>2019-12-31</endDate>
    <runOutEndDate>2020-03-31</runOutEndDate>
    <runOutAdminOption>NROA</runOutAdminOption>
    <renewalDate></renewalDate>
    <policyPersons>
      <idType></idType>
      <idValue></idValue>
      <policyPerRole></policyPerRole>
      <startDate></startDate>
      <endDate></endDate>
    </policyPersons>
    <characteristics>
      <characteristicsList>
        <characteristicType></characteristicType>
        <characteristicValue></characteristicValue>
        <effectiveDate></effectiveDate>
      </characteristicsList>
    </characteristics>
  </policyData>
  <policyData>
    <policyType>SELF-FUNDED</policyType>
    <sourceSystem>SMALLPRIME</sourceSystem>
    <policyNumber>AP234903</policyNumber>
    <description>Retiree COBRA Employee Health Insurance
Policy</description>
    <startDate>2019-01-01</startDate>
    <endDate>2019-12-31</endDate>
    <runOutEndDate>2020-03-31</runOutEndDate>
    <runOutAdminOption>PERC</runOutAdminOption>
    <renewalDate></renewalDate>
    <policyPersons>
      <idType></idType>
      <idValue></idValue>
      <policyPerRole></policyPerRole>
      <startDate></startDate>
      <endDate></endDate>
    </policyPersons>
    <terminationInformation>
      <terminateDate></terminateDate>
      <terminationReason></terminationReason>
    </terminationInformation>
    <reinstateInformation>
      <reinstatementDate></reinstatementDate>
      <reinstateReason></reinstateReason>
    </reinstateInformation>
    <characteristics>
      <characteristicsList>
        <characteristicType></characteristicType>
        <characteristicValue></characteristicValue>
        <effectiveDate></effectiveDate>
      </characteristicsList>
    </characteristics>
  <planData>

```



```

        <planNumber></planNumber>
        <priceItemCode></priceItemCode>
        <planName></planName>
        <priceItemCode></priceItemCode>
        <planName></planName>
        <pricingRuleTypeList>
            <pricingRuleType></pricingRuleType>
        </pricingRuleTypeList>
        <startDate></startDate>
        <endDate></endDate>
        <primaryPlanSw></primaryPlanSw>
        <benefitTypeFlag></benefitTypeFlag>
        <characteristics>
            <characteristicsList>
                <characteristicType></characteristicType>
                <characteristicValue></characteristicValue>
                <effectiveDate></effectiveDate>
            </characteristicsList>
        </characteristics>
        <policyPlanProrationRuleList>
            <effectiveDate></effectiveDate>
            <prorationEventType></prorationEventType>
            <prorationType></prorationType>
            <numberOfDays></numberOfDays>
            <membershipType></membershipType>
        </policyPlanProrationRuleList>
    </planData>
</policyData>
</personData>
<personData>
    <sequence>4</sequence>
    <personType>BG</personType>
    <personName>
        <sequence>1</sequence>
        <entityName>US Energy RETIREE</entityName>
        <nameType>PRIM</nameType>
    </personName>
    <identifiers>
        <idType>EIN</idType>
        <idValue>98-7654322</idValue>
        <isPrimary>Y</isPrimary>
    </identifiers>
    <division>HC</division>
    <birthDate>1985-01-01</birthDate>
    <sinceDate>2019-01-01</sinceDate>
    <address>
        <addressEffDate>2019-01-01</addressEffDate>
        <addressType>MAIN</addressType>
        <mailingName>US Energy RETIREE</mailingName>
        <address1>Neptune Park</address1>
        <address2>Neptune Street</address2>
        <address3>River Side</address3>
        <address4></address4>
        <city>San Jose</city>
        <state>CA</state>
        <zip>94088</zip>
        <country>USA</country>
        <houseType></houseType>
        <streetNumber1></streetNumber1>
        <streetNumber2></streetNumber2>
        <inCityLimit></inCityLimit>
        <taxVendorGeographicalCode></taxVendorGeographicalCode>
        <county></county>
    </address>

```

```

<email>usencpre@example.com</email>
<overrideMailingName1></overrideMailingName1>
<overrideMailingName2></overrideMailingName2>
<overrideMailingName3></overrideMailingName3>
<phones>
  <phoneType>BUSN</phoneType>
  <phoneValue>408-555-0165</phoneValue>
</phones>
<relatedPersons>
  <idType>EIN</idType>
  <idValue>98-7654329</idValue>
  <personRelationshipType></personRelationshipType>
  <startDate>2019-01-01</startDate>
  <endDate>2019-12-31</endDate>
  <financialRelationshipSw>>false</financialRelationshipSw>
  <parentOrChild>P</parentOrChild>
  <characteristics>
    <characteristicsList>
      <characteristicType></characteristicType>
      <characteristicValue></characteristicValue>
      <effectiveDate></effectiveDate>
    </characteristicsList>
  </characteristics>
</relatedPersons>
<characteristics>
  <characteristicsList>
    <characteristicType>PER_CAT</characteristicType>
    <characteristicValue>OTHER</characteristicValue>
    <effectiveDate>2019-01-01</effectiveDate>
  </characteristicsList>
</characteristics>
<billLevelParameters>
  <sequence>30</sequence>
  <sourceSystem>SMALLPRIME</sourceSystem>
  <billLevelInfo1>RETIRED</billLevelInfo1>
  <billLevelInfo2>CHARLOTTE</billLevelInfo2>
  <effectiveDate>2019-01-01</effectiveDate>
</billLevelParameters>
<billLevelParameters>
  <sequence>31</sequence>
  <sourceSystem>SMALLPRIME</sourceSystem>
  <billLevelInfo1>RETIRED</billLevelInfo1>
  <billLevelInfo2>DETROIT</billLevelInfo2>
  <effectiveDate>2019-01-01</effectiveDate>
</billLevelParameters>
<memberData>
  <startDate></startDate>
  <endDate></endDate>
  <paidThroughDate></paidThroughDate>
  <memberId></memberId>
  <memberRelationship></memberRelationship>
  <membershipPersonStatus></membershipPersonStatus>
  <membershipPersonStatusReason></
membershipPersonStatusReason>
  <autoRenew></autoRenew>
  <associatedMemberIdentifierType></
associatedMemberIdentifierType>
  <associatedMemberIdentifier></associatedMemberIdentifier>
  <exchangeFlag></exchangeFlag>
  <exchangeId></exchangeId>
  <binderLiabilityAmount></binderLiabilityAmount>
  <binderPayApplicability></binderPayApplicability>
  <binderPayGraceDays></binderPayGraceDays>
  <binderPayThreshold></binderPayThreshold>

```

```

        <holdBilling></holdBilling>
        <membershipRenewalDate></membershipRenewalDate>
        <contractPeriod></contractPeriod>
        <membershipIdentifier>
            <membershipIdentifierType></membershipIdentifierType>
            <membershipIdentifierValue></
membershipIdentifierValue>
        </membershipIdentifier>
        <isMemberSw></isMemberSw>
        <isFinanciallyResponsibleSw></isFinanciallyResponsibleSw>
        <membershipType></membershipType>
        <externalMedicareBeneficiaryId></
externalMedicareBeneficiaryId>
        <mainSubscriber>
            <idType></idType>
            <idValue></idValue>
            <membershipType></membershipType>
        </mainSubscriber>
        <policyNumber></policyNumber>
        <sourceSystem></sourceSystem>
        <planNumber></planNumber>
        <healthPlanCode></healthPlanCode>
        <characteristics>
            <characteristicsList>
                <characteristicType></characteristicType>
                <characteristicValue></characteristicValue>
                <effectiveDate></effectiveDate>
            </characteristicsList>
        </characteristics>
        <membershipRateGuarantee>
            <membershipRateGuaranteeList>
                <rateGuaranteeStartDate></rateGuaranteeStartDate>
                <rateGuaranteeEndDate></rateGuaranteeEndDate>
                <rateGuaranteeStatus></rateGuaranteeStatus>
            </membershipRateGuaranteeList>
        </membershipRateGuarantee>
        <membershipPersonCharacteristic>
            <characteristicsList>
                <characteristicType></characteristicType>
                <characteristicValue></characteristicValue>
                <effectiveDate></effectiveDate>
            </characteristicsList>
            <characteristicsList>
                <characteristicType></characteristicType>
                <characteristicValue></characteristicValue>
                <effectiveDate></effectiveDate>
            </characteristicsList>
        </membershipPersonCharacteristic>
        <benefitData>
            <benefitDataList>
                <sequence></sequence>
                <startDate></startDate>
                <endDate></endDate>
                <benefitStatus></benefitStatus>
                <benefitSourceFlag></benefitSourceFlag>
                <benefitTypeFlag></benefitTypeFlag>
                <benefitSubTypeFlag></benefitSubTypeFlag>
                <planBenefitPackageId></planBenefitPackageId>
                <benefitAmount></benefitAmount>
                <characteristics>
                    <characteristicsList>
                        <characteristicType></characteristicType>
                        <characteristicValue></
characteristicValue>

```

```

        <effectiveDate></effectiveDate>
      </characteristicsList>
    </characteristics>
  </benefitDataList>
</benefitData>
<billableChargeData>
  <sequence></sequence>
  <accountIdType></accountIdType>
  <accountIdValue></accountIdValue>
  <chargeType></chargeType>
  <startDate></startDate>
  <endDate></endDate>
  <priceItemCode></priceItemCode>
  <description></description>
  <recurringMethod></recurringMethod>
  <billPeriod></billPeriod>
  <frequency></frequency>
  <billAfterDt></billAfterDt>
  <billableChargeLines>
    <descriptionOnBill></descriptionOnBill>
    <currencyCode></currencyCode>
    <chargeAmount></chargeAmount>
    <showOnBillSw></showOnBillSw>
    <appearInSummarySw></appearInSummarySw>
    <distributionCode></distributionCode>
  </billableChargeLines>
  <characteristics>
    <characteristicsList>
      <characteristicType></characteristicType>
      <characteristicValue></characteristicValue>
      <effectiveDate></effectiveDate>
    </characteristicsList>
  </characteristics>
</billableChargeData>
</memberData>
<accountData>
  <accountType>Standard</accountType>
  <customerClass>HC</customerClass>
  <billCycle>BK01</billCycle>
  <billLeadDays>10</billLeadDays>
  <division>HC</division>
  <currency>USD</currency>
  <setUpDate>2019-01-01</setUpDate>
  <acctUsageFlg>USAG</acctUsageFlg>
  <comments></comments>
  <deferAutoPayDt></deferAutoPayDt>
  <collectionClass></collectionClass>
  <billRouteType>POSTAL</billRouteType>
  <billAddressSource>PER</billAddressSource>
  <identifiers>
    <idType>ACCT_NM</idType>
    <idValue>Standard Account</idValue>
    <isPrimary>true</isPrimary>
  </identifiers>
  <address>
    <addressEffDate>2019-01-01</addressEffDate>
    <addressType></addressType>
    <address1></address1>
    <address2></address2>
    <address3></address3>
    <address4></address4>
    <city></city>
    <state></state>
    <zip></zip>
  </address>
</accountData>
</memberData>
</memberData>

```

```

        <country></country>
        <houseType></houseType>
        <streetNumber1></streetNumber1>
        <streetNumber2></streetNumber2>
        <inCityLimit></inCityLimit>
        <taxVendorGeographicalCode></
taxVendorGeographicalCode>
        <county></county>
    </address>
    <autoPayDetails>
        <priority></priority>
        <startDate></startDate>
        <endDate></endDate>
        <percentage></percentage>
        <autoPayMethod></autoPayMethod>
        <autoPayRouteType></autoPayRouteType>
        <autoPaySourceCode></autoPaySourceCode>
        <accountNumber></accountNumber>
        <expiryMonth></expiryMonth>
        <expiryYear></expiryYear>
        <name></name>
        <maxWithdrawalAmount></maxWithdrawalAmount>
        <comments></comments>
    </autoPayDetails>
    <accountPerson>
        <idType></idType>
        <idValue></idValue>
        <accountRelationshipType></accountRelationshipType>
        <isFinanciallyResponsible></isFinanciallyResponsible>
        <personAddressOverride>
            <address1></address1>
            <address2></address2>
            <address3></address3>
            <address4></address4>
            <city></city>
            <postal></postal>
            <state></state>
            <country></country>
            <houseType></houseType>
            <streetNumber1></streetNumber1>
            <streetNumber2></streetNumber2>
            <inCityLimit></inCityLimit>
            <taxVendorGeographicalCode></
taxVendorGeographicalCode>
            <county></county>
        </personAddressOverride>
        <accountPersonRouting>
            <billRouteType></billRouteType>
            <shouldReceiveCopyOfBill></
shouldReceiveCopyOfBill>
            <billFormat></billFormat>
            <numberOfBillCopies></numberOfBillCopies>
            <receivesNotification></receivesNotification>
            <billAddressSource></billAddressSource>
        </accountPersonRouting>
    </accountPerson>
    <characteristics>
        <characteristicsList>
            <characteristicType></characteristicType>
            <characteristicValue></characteristicValue>
            <effectiveDate></effectiveDate>
        </characteristicsList>
    </characteristics>
</accountData>

```

```

    <accountData>
      <accountType>Retention</accountType>
      <customerClass>HC</customerClass>
      <billCycle>BK02</billCycle>
      <billLeadDays>10</billLeadDays>
      <division>HC</division>
      <currency>USD</currency>
      <setUpDate>2019-01-01</setUpDate>
      <acctUsageFlg>USAG</acctUsageFlg>
      <comments></comments>
      <deferAutoPayDt></deferAutoPayDt>
      <collectionClass></collectionClass>
      <billRouteType>POSTAL</billRouteType>
      <billAddressSource>ACOV</billAddressSource>
      <identifiers>
        <idType>ACCT_NM</idType>
        <idValue>Retention Account</idValue>
        <isPrimary>true</isPrimary>
      </identifiers>
      <address>
        <addressEffDate>2019-01-01</addressEffDate>
        <addressType>OVRD</addressType>
        <address1>Saturn Park</address1>
        <address2>Saturn Street</address2>
        <address3>River Side</address3>
        <address4></address4>
        <city>San Francisco</city>
        <state>CA</state>
        <zip>94122</zip>
        <country>USA</country>
        <houseType></houseType>
        <streetNumber1></streetNumber1>
        <streetNumber2></streetNumber2>
        <inCityLimit></inCityLimit>
        <taxVendorGeographicalCode></
taxVendorGeographicalCode>
        <county></county>
      </address>
      <autoPayDetails>
        <priority></priority>
        <startDate></startDate>
        <endDate></endDate>
        <percentage></percentage>
        <autoPayMethod></autoPayMethod>
        <autoPayRouteType></autoPayRouteType>
        <autoPaySourceCode></autoPaySourceCode>
        <accountNumber></accountNumber>
        <expiryMonth></expiryMonth>
        <expiryYear></expiryYear>
        <name></name>
        <maxWithdrawalAmount></maxWithdrawalAmount>
        <comments></comments>
      </autoPayDetails>
      <accountPerson>
        <idType></idType>
        <idValue></idValue>
        <accountRelationshipType></accountRelationshipType>
        <isFinanciallyResponsible></isFinanciallyResponsible>
        <personAddressOverride>
          <address1></address1>
          <address2></address2>
          <address3></address3>
          <address4></address4>
          <city></city>

```

```

        <postal></postal>
        <state></state>
        <country></country>
        <houseType></houseType>
        <streetNumber1></streetNumber1>
        <streetNumber2></streetNumber2>
        <inCityLimit></inCityLimit>
        <taxVendorGeographicalCode></
taxVendorGeographicalCode>
        <county></county>
    </personAddressOverride>
    <accountPersonRouting>
        <billRouteType></billRouteType>
        <shouldReceiveCopyOfBill></
shouldReceiveCopyOfBill>
        <billFormat></billFormat>
        <numberOfBillCopies></numberOfBillCopies>
        <receivesNotification></receivesNotification>
        <billAddressSource></billAddressSource>
    </accountPersonRouting>
</accountPerson>
<characteristics>
    <characteristicsList>
        <characteristicType></characteristicType>
        <characteristicValue></characteristicValue>
        <effectiveDate></effectiveDate>
    </characteristicsList>
</characteristics>
</accountData>
<policyData>
    <policyType>SELF-FUNDED</policyType>
    <sourceSystem>SMALLPRIME</sourceSystem>
    <policyNumber>AP234905</policyNumber>
    <description>Retiree Employee Health Insurance Policy</
description>
    <startDate>2019-01-01</startDate>
    <endDate>2019-12-31</endDate>
    <runOutEndDate>2020-03-31</runOutEndDate>
    <runOutAdminOption>PERC</runOutAdminOption>
    <policyPersons>
        <idType></idType>
        <idValue></idValue>
        <policyPerRole></policyPerRole>
        <startDate></startDate>
        <endDate></endDate>
    </policyPersons>
    <terminationInformation>
        <terminateDate></terminateDate>
        <terminationReason></terminationReason>
    </terminationInformation>
    <reinstateInformation>
        <reinstatementDate></reinstatementDate>
        <reinstateReason></reinstateReason>
    </reinstateInformation>
    <characteristics>
        <characteristicsList>
            <characteristicType></characteristicType>
            <characteristicValue></characteristicValue>
            <effectiveDate></effectiveDate>
        </characteristicsList>
    </characteristics>
    <planData>
        <planNumber></planNumber>
        <priceItemCode></priceItemCode>

```

```

        <planName></planName>
        <priceItemCode></priceItemCode>
        <planName></planName>
        <pricingRuleTypeList>
            <pricingRuleType></pricingRuleType>
        </pricingRuleTypeList>
        <startDate></startDate>
        <endDate></endDate>
        <primaryPlanSw></primaryPlanSw>
        <benefitTypeFlag></benefitTypeFlag>
        <characteristics>
            <characteristicsList>
                <characteristicType></characteristicType>
                <characteristicValue></characteristicValue>
                <effectiveDate></effectiveDate>
            </characteristicsList>
        </characteristics>
        <policyPlanProrationRuleList>
            <effectiveDate></effectiveDate>
            <prorationEventType></prorationEventType>
            <prorationType></prorationType>
            <numberOfDays></numberOfDays>
            <membershipType></membershipType>
        </policyPlanProrationRuleList>
    </planData>
</policyData>
</personData>
<pricingRuleData>
    <sequence></sequence>
    <entityIdentifiers>
        <entityIdentifiersList>
            <entityIdentifierType></entityIdentifierType>
            <entityIdentifierValue></entityIdentifierValue>
        </entityIdentifiersList>
    </entityIdentifiers>
    <status></status>
    <startDate></startDate>
    <endDate></endDate>
    <pricingRuleType></pricingRuleType>
    <rateOption></rateOption>
    <pricingType></pricingType>
    <modifierApplicability></modifierApplicability>
    <modifierMethod></modifierMethod>
    <baseRate>
        <sequence></sequence>
        <baseFee></baseFee>
        <lowerAgeLimit></lowerAgeLimit>
        <upperAgeLimit></upperAgeLimit>
        <pricingParameter>
            <sequence></sequence>
            <parameterCode></parameterCode>
            <parameterValue></parameterValue>
        </pricingParameter>
        <modifierInformation>
            <sequence></sequence>
            <parameterCode></parameterCode>
            <parameterValue></parameterValue>
            <rate></rate>
        </modifierInformation>
    </baseRate>
    <characteristics>
        <characteristicsList>
            <characteristicType></characteristicType>
            <characteristicValue></characteristicValue>

```



```

        <effectiveDate></effectiveDate>
      </characteristicsList>
    </characteristics>
  </pricingRuleData>
  <statementConstructsData>
    <personStatementConstructs>
      <personIdentifier></personIdentifier>
      <personIdentifierType></personIdentifierType>
      <statementConstructIdentifier></
statementConstructIdentifier>
      <statementAddressSource></statementAddressSource>
      <statementCycle></statementCycle>
      <statementRouteType></statementRouteType>
      <effectiveStatus></effectiveStatus>
      <addressId></addressId>
      <numberOfCopies></numberOfCopies>
      <statementFormat></statementFormat>
      <description></description>
      <statementConstructDetails>
        <serviceAgreement></serviceAgreement>
        <accountNumber></accountNumber>
        <accountNumberTypeCd></accountNumberTypeCd>
        <division></division>
        <statementPrintDescription></
statementPrintDescription>
        <printOrder></printOrder>
        <startDate></startDate>
        <endDate></endDate>
      </statementConstructDetails>
    </personStatementConstructs>
  </statementConstructsData>
  <characteristics>
    <characteristicsList>
      <characteristicType></characteristicType>
      <characteristicValue></characteristicValue>
      <effectiveDate></effectiveDate>
    </characteristicsList>
  </characteristics>
</customerStructureData>
</customerStructureMessage>
</schema>

```

Sample Health Care Inbound Message for Pricing Rules

Using the below example, you can create the following:

- Tier-based pricing rule for the **DD_BASIC** policy plan

Policy Plan	Pricing Rule Type	Base Rate	Parameter	Parameter Value
DD_BASIC	TIER_BASED	20	EMPBAND	IC1
			SUBSCRIPTIONTIER	E
			GENDER	MALE
		40	EMPBAND	IC2
			SUBSCRIPTIONTIER	ES
			GENDER	FEMALE

Policy Plan	Pricing Rule Type	Base Rate	Parameter	Parameter Value
		60	EMPBAND	IC3
			SUBSCRIPTIONTIER	ES
			GENDER	FEMALE
		80	EMPBAND	IC4
			SUBSCRIPTIONTIER	E
			GENDER	MALE

- Age-based pricing rule for the **PPO_MED_BRONZE_RETIRED** policy plan

Policy Plan	Pricing Rule Type	Base Rate	Lower Age Limit	Upper Age Limit	Parameter	Parameter Value	Modifier	Modifier Value	Modifier Rate
PPO_MED_BRONZE_RETIRED	AGE_BASED	200	0	19	GENDER	FEMALE	TOBUSAGE	AGE	20
		200	0	19	GENDER	MALE	TOBUSAGE	AGE	20
		300	20	39	GENDER	FEMALE	TOBUSAGE	AGE	30
		300	20	39	GENDER	MALE	TOBUSAGE	AGE	30
		450	40	59	GENDER	FEMALE	TOBUSAGE	AGE	40
		450	40	59	GENDER	MALE	TOBUSAGE	AGE	40
		550	60	130	GENDER	FEMALE	TOBUSAGE	AGE	50
		550	60	130	GENDER	MALE	TOBUSAGE	AGE	50

- Additional charge pricing rule for the **COBRA_DENTAL** policy plan

Policy Plan	Pricing Rule Type	Base Rate	Modifier	Modifier Value	Modifier Rate
COBRA_DENTAL	CAPITATION_FEES	100	IC_BAND	IC1	10
		200	M1_BAND	M1	20
		300	M2_BAND	M2	30
		400	M3_BAND	M3	40

- Rate Guarantee pricing rule for the **RATE_LOCK_MED** policy plan.

Policy Plan	Pricing Rule Type	Base Rate	Lower Age Limit	Upper Age Limit	Start Date	End Date	Rate Guarantee
RATE_LOCK_MED	AGE_BASED	200	20	39	01-01-2021	31-03-2021	Y
	TIER_BASED	400	40	59	01-02-2021	31-07-2021	Y
	TIER_BASED	600	60	79	01-02-2021	31-10-2021	Y

Policy Plan	Pricing Rule Type	Base Rate	Lower Age Limit	Upper Age Limit	Start Date	End Date	Rate Guarantee
	AGE_BASED	800	80	99	01-01-2021	30-11-2021	Y

- Discount charge pricing rule for the **DISC_CHG_MED** policy plan.

Bill Group	Policy Plan	Pricing Rule Type	Base Fee	Modifier	Modifier Value	Modifier Rate
United Antarctica Group	DISC_	DISCOUNT_	50	VP_BAND	VP1	10
	CHG_	CHARGE	70	M_BAND	M1	20
	MED		90	IC_BAND	IC1	30

```

<schema>
  <clInboundMessage></clInboundMessage>
  <bo>C1-HCInboundMessage</bo>
  <characteristics>
    <inboundMessageCharacteristic>
      <adhocCharacteristicValue></adhocCharacteristicValue>
      <characteristicType>C1-EXTBTCT</characteristicType>
      <effectiveDate>2019-01-01</effectiveDate>
      <characteristicValue>DATAEXT3</characteristicValue>
      <characteristicValueForeignKey1></characteristicValueForeignKey1>
      <characteristicValueFK2></characteristicValueFK2>
      <characteristicValueFK3></characteristicValueFK3>
      <characteristicValueFk4></characteristicValueFk4>
      <characteristicValueFK5></characteristicValueFK5>
      <searchCharacteristicValue></searchCharacteristicValue>
      <version></version>
    </inboundMessageCharacteristic>
  </characteristics>
  <customerStructureMessage>
    <headerData>
      <messageType>C1-HEALTHCARE-INB-MSG-TYPE</messageType>
      <sourceSystem>SMALLPRIME</sourceSystem>
      <externalTransactionId>12344</externalTransactionId>
      <externalBatchId>433443</externalBatchId>
      <externalSourceId>656565</externalSourceId>
    </headerData>
    <customerStructureData>
      <personData>
        <personType></personType>
        <personName>
          <sequence></sequence>
          <entityName></entityName>
          <nameType></nameType>
        </personName>
        <identifiers>
          <idType></idType>
          <idValue></idValue>
          <isPrimary></isPrimary>
        </identifiers>
        <division></division>
        <birthDate></birthDate>
        <sinceDate></sinceDate>
        <address>
          <addressEffDate></addressEffDate>
          <addressType></addressType>
        </address>
      </personData>
    </customerStructureData>
  </customerStructureMessage>
</schema>

```

```

    <mailingName></mailingName>
    <address1></address1>
    <address2></address2>
    <address3></address3>
    <address4></address4>
    <city></city>
    <state></state>
    <zip></zip>
    <country></country>
    <houseType></houseType>
    <streetNumber1></streetNumber1>
    <streetNumber2></streetNumber2>
    <inCityLimit></inCityLimit>
    <taxVendorGeographicalCode></taxVendorGeographicalCode>
    <county></county>
</address>
<email></email>
<overrideMailingName1></overrideMailingName1>
<overrideMailingName2></overrideMailingName2>
<overrideMailingName3></overrideMailingName3>
<phones>
    <phoneType></phoneType>
    <phoneValue></phoneValue>
    <extension></extension>
</phones>
<relatedPersons>
    <idType></idType>
    <idValue></idValue>
    <personRelationshipType></personRelationshipType>
    <startDate></startDate>
    <endDate></endDate>
    <financialRelationshipSw></financialRelationshipSw>
    <parentOrChild></parentOrChild>
    <characteristics>
        <characteristicsList>
            <characteristicType></characteristicType>
            <characteristicValue></characteristicValue>
            <effectiveDate></effectiveDate>
        </characteristicsList>
    </characteristics>
</relatedPersons>
<characteristics>
    <characteristicsList>
        <characteristicType></characteristicType>
        <characteristicValue></characteristicValue>
        <effectiveDate></effectiveDate>
    </characteristicsList>
</characteristics>
<billLevelParameters>
    <sequence></sequence>
    <sourceSystem></sourceSystem>
    <billLevelInfo1></billLevelInfo1>
    <billLevelInfo2></billLevelInfo2>
    <billLevelInfo3></billLevelInfo3>
    <billLevelInfo4></billLevelInfo4>
    <effectiveDate></effectiveDate>
</billLevelParameters>
<memberData>
    <startDate></startDate>
    <endDate></endDate>
    <paidThroughDate></paidThroughDate>
    <memberId></memberId>
    <memberRelationship></memberRelationship>
    <membershipPersonStatus></membershipPersonStatus>

```

```

    <membershipPersonstatusReason></membershipPersonstatusReason>
    <autoRenew></autoRenew>
    <associatedMemberIdentifierType></
associatedMemberIdentifierType>
    <associatedMemberIdentifier></associatedMemberIdentifier>
    <exchangeFlag></exchangeFlag>
    <exchangeId></exchangeId>
    <binderLiabilityAmount></binderLiabilityAmount>
    <binderPayApplicability></binderPayApplicability>
    <binderPayGraceDays></binderPayGraceDays>
    <binderPayThreshold><binderPayThreshold>
    <holdBilling></holdBilling>
    <membershipRenewalDate></membershipRenewalDate>
    <contractPeriod></contractPeriod>
    <membershipIdentifier>
      <membershipIdentifierType></membershipIdentifierType>
      <membershipIdentifierValue></membershipIdentifierValue>
    </membershipIdentifier>
    <isMemberSw></isMemberSw>
    <isFinanciallyResponsibleSw></isFinanciallyResponsibleSw>
    <membershipType></membershipType>
    <externalMedicareBeneficiaryId></
externalMedicareBeneficiaryId>
    <mainSubscriber>
      <idType></idType>
      <idValue></idValue>
      <membershipType></membershipType>
    </mainSubscriber>
    <policyNumber></policyNumber>
    <sourceSystem></sourceSystem>
    <planNumber></planNumber>
    <healthPlanCode></healthPlanCode>
    <characteristics>
      <characteristicsList>
        <characteristicType></characteristicType>
        <characteristicValue></characteristicValue>
        <effectiveDate></effectiveDate>
      </characteristicsList>
    </characteristics>
    <membershipRateGuarantee>
      <membershipRateGuaranteeList>
        <rateGuaranteeStartDate></rateGuaranteeStartDate>
        <rateGuaranteeEndDate></rateGuaranteeEndDate>
        <rateGuaranteeStatus></rateGuaranteeStatus>
      </membershipRateGuaranteeList>
    </membershipRateGuarantee>
    <membershipPersonCharacteristic>
      <characteristicsList>
        <characteristicType></characteristicType>
        <characteristicValue></characteristicValue>
        <effectiveDate></effectiveDate>
      </characteristicsList>
    </membershipPersonCharacteristic>
    <benefitData>
      <benefitDataList>
        <sequence></sequence>
        <startDate></startDate>
        <endDate></endDate>
        <benefitStatus></benefitStatus>
        <benefitSourceFlag></benefitSourceFlag>
        <benefitTypeFlag></benefitTypeFlag>
        <benefitSubTypeFlag></benefitSubTypeFlag>
        <planBenefitPackageId></planBenefitPackageId>
        <benefitAmount></benefitAmount>

```

```

        <characteristics>
            <characteristicsList>
                <characteristicType></characteristicType>
                <characteristicValue></characteristicValue>
                <effectiveDate></effectiveDate>
            </characteristicsList>
        </characteristics>
    </benefitDataList>
</benefitData>
<billableChargeData>
    <sequence></sequence>
    <accountIdType></accountIdType>
    <accountIdValue></accountIdValue>
    <chargeType></chargeType>
    <startDate></startDate>
    <endDate></endDate>
    <priceItemCode></priceItemCode>
    <description></description>
    <recurringMethod></recurringMethod>
    <billPeriod></billPeriod>
    <frequency></frequency>
    <billAfterDt></billAfterDt>
    <billableChargeLines>
        <descriptionOnBill></descriptionOnBill>
        <currencyCode></currencyCode>
        <chargeAmount></chargeAmount>
        <showOnBillSw></showOnBillSw>
        <appearInSummarySw></appearInSummarySw>
        <distributionCode></distributionCode>
    </billableChargeLines>
    <characteristics>
        <characteristicsList>
            <characteristicType></characteristicType>
            <characteristicValue></characteristicValue>
            <effectiveDate></effectiveDate>
        </characteristicsList>
    </characteristics>
</billableChargeData>
</memberData>
<accountData>
    <accountType></accountType>
    <customerClass></customerClass>
    <billCycle></billCycle>
    <billLeadDays></billLeadDays>
    <division></division>
    <currency></currency>
    <setUpDate></setUpDate>
    <acctUsageFlg></acctUsageFlg>
    <comments></comments>
    <deferAutoPayDt></deferAutoPayDt>
    <collectionClass></collectionClass>
    <billRouteType></billRouteType>
    <billAddressSource></billAddressSource>
    <identifiers>
        <idType></idType>
        <idValue></idValue>
        <isPrimary></isPrimary>
    </identifiers>
    <address>
        <addressEffDate></addressEffDate>
        <addressType></addressType>
        <address1></address1>
        <address2></address2>
        <address3></address3>
    </address>
</accountData>

```

```

<address4></address4>
<city></city>
<state></state>
<zip></zip>
<country></country>
<houseType></houseType>
<streetNumber1></streetNumber1>
<streetNumber2></streetNumber2>
<inCityLimit></inCityLimit>
<taxVendorGeographicalCode></taxVendorGeographicalCode>
<county></county>
</address>
<autoPayDetails>
  <priority></priority>
  <startDate></startDate>
  <endDate></endDate>
  <percentage></percentage>
  <autoPayMethod></autoPayMethod>
  <autoPayRouteType></autoPayRouteType>
  <autoPaySourceCode></autoPaySourceCode>
  <accountNumber></accountNumber>
  <expiryMonth></expiryMonth>
  <expiryYear></expiryYear>
  <name></name>
  <maxWithdrawalAmount></maxWithdrawalAmount>
  <comments></comments>
</autoPayDetails>
<accountPerson>
  <idType></idType>
  <idValue></idValue>
  <accountRelationshipType></accountRelationshipType>
  <isFinanciallyResponsible></isFinanciallyResponsible>
  <personAddressOverride>
    <address1></address1>
    <address2></address2>
    <address3></address3>
    <address4></address4>
    <city></city>
    <postal></postal>
    <state></state>
    <country></country>
    <houseType></houseType>
    <streetNumber1></streetNumber1>
    <streetNumber2></streetNumber2>
    <inCityLimit></inCityLimit>
    <taxVendorGeographicalCode></taxVendorGeographicalCode>
    <county></county>
  </personAddressOverride>
  <accountPersonRouting>
    <billRouteType></billRouteType>
    <shouldReceiveCopyOfBill></shouldReceiveCopyOfBill>
    <billFormat></billFormat>
    <numberOfBillCopies></numberOfBillCopies>
    <receivesNotification></receivesNotification>
    <billAddressSource></billAddressSource>
  </accountPersonRouting>
</accountPerson>
<characteristics>
  <characteristicsList>
    <characteristicType></characteristicType>
    <characteristicValue></characteristicValue>
    <effectiveDate></effectiveDate>
  </characteristicsList>
</characteristics>

```

```

    </accountData>
    <policyData>
      <policyType></policyType>
      <sourceSystem></sourceSystem>
      <policyNumber></policyNumber>
      <description></description>
      <advancedLevelFundingEligibility></
advancedLevelFundingEligibility>
      <startDate></startDate>
      <endDate></endDate>
      <runOutEndDate></runOutEndDate>
      <runOutAdminOption></runOutAdminOption>
      <renewalDate></renewalDate>
      <policyPersons>
        <idType></idType>
        <idValue></idValue>
        <policyPerRole></policyPerRole>
        <startDate></startDate>
        <endDate></endDate>
      </policyPersons>
      <terminationInformation>
        <terminateDate></terminateDate>
        <terminationReason></terminationReason>
      </terminationInformation>
      <reinstateInformation>
        <reinstatementDate></reinstatementDate>
        <reinstateReason></reinstateReason>
      </reinstateInformation>
      <characteristics>
        <characteristicsList>
          <characteristicType></characteristicType>
          <characteristicValue></characteristicValue>
          <effectiveDate></effectiveDate>
        </characteristicsList>
      </characteristics>
      <planData>
        <planNumber></planNumber>
        <priceItemCode></priceItemCode>
        <planName></planName>
        <pricingRuleTypeList>
          <pricingRuleType></pricingRuleType>
        </pricingRuleTypeList>
        <startDate></startDate>
        <endDate></endDate>
        <primaryPlanSw></primaryPlanSw>
        <benefitTypeFlag></benefitTypeFlag>
        <characteristics>
          <characteristicsList>
            <characteristicType></characteristicType>
            <characteristicValue></characteristicValue>
            <effectiveDate></effectiveDate>
          </characteristicsList>
        </characteristics>
        <policyPlanProrationRuleList>
          <effectiveDate></effectiveDate>
          <prorationEventType></prorationEventType>
          <prorationType></prorationType>
          <numberOfDays></numberOfDays>
          <membershipType></membershipType>
        </policyPlanProrationRuleList>
      </planData>
    </policyData>
  </personData>
  <pricingRuleData>

```



```

<sequence>1</sequence>
<entityIdentifiers>
  <entityIdentifiersList>
    <entityIdentifierType>PLCY</entityIdentifierType>
    <entityIdentifierValue>AP234389</entityIdentifierValue>
  </entityIdentifiersList>
  <entityIdentifiersList>
    <entityIdentifierType>SSYS</entityIdentifierType>
    <entityIdentifierValue>SMALLPRIME</entityIdentifierValue>
  </entityIdentifiersList>
  <entityIdentifiersList>
    <entityIdentifierType>PLAN</entityIdentifierType>
    <entityIdentifierValue>DD_BASIC</entityIdentifierValue>
  </entityIdentifiersList>
</entityIdentifiers>
<status></status>
<startDate>2019-01-01</startDate>
<endDate>2019-12-31</endDate>
<pricingRuleType>TIER_BASED</pricingRuleType>
<priceItemCd>DEN_PREM_FEE</priceItemCd>
<rateOption>TIERBASED</rateOption>
<pricingType></pricingType>
<modifierApplicability></modifierApplicability>
<modifierMethod></modifierMethod>
<baseRate>
  <sequence>1</sequence>
  <baseFee>20</baseFee>
  <lowerAgeLimit></lowerAgeLimit>
  <upperAgeLimit></upperAgeLimit>
  <pricingParameter>
    <sequence>1</sequence>
    <parameterCode>EMPBAND</parameterCode>
    <parameterValue>IC1</parameterValue>
  </pricingParameter>
  <pricingParameter>
    <sequence>2</sequence>
    <parameterCode>SUBSCRIPTIONTIER</parameterCode>
    <parameterValue>E</parameterValue>
  </pricingParameter>
  <pricingParameter>
    <sequence>3</sequence>
    <parameterCode>GENDER</parameterCode>
    <parameterValue>MALE</parameterValue>
  </pricingParameter>
  <modifierInformation>
    <sequence></sequence>
    <parameterCode></parameterCode>
    <parameterValue></parameterValue>
    <rate></rate>
  </modifierInformation>
</baseRate>
  <baseRate>
    <sequence>2</sequence>
    <baseFee>40</baseFee>
    <lowerAgeLimit></lowerAgeLimit>
    <upperAgeLimit></upperAgeLimit>
    <pricingParameter>
      <sequence>1</sequence>
      <parameterCode>EMPBAND</parameterCode>
      <parameterValue>IC2</parameterValue>
    </pricingParameter>
    <pricingParameter>
      <sequence>2</sequence>
      <parameterCode>SUBSCRIPTIONTIER</parameterCode>

```

```

        <parameterValue>ES</parameterValue>
    </pricingParameter>
    <pricingParameter>
        <sequence>3</sequence>
        <parameterCode>GENDER</parameterCode>
        <parameterValue>FEMALE</parameterValue>
    </pricingParameter>
    <modifierInformation>
        <sequence></sequence>
        <parameterCode></parameterCode>
        <parameterValue></parameterValue>
        <rate></rate>
    </modifierInformation>
</baseRate>
<baseRate>
    <sequence>3</sequence>
    <baseFee>60</baseFee>
    <lowerAgeLimit></lowerAgeLimit>
    <upperAgeLimit></upperAgeLimit>
    <pricingParameter>
        <sequence>1</sequence>
        <parameterCode>EMPBAND</parameterCode>
        <parameterValue>IC3</parameterValue>
    </pricingParameter>
    <pricingParameter>
        <sequence>2</sequence>
        <parameterCode>SUBSCRIPTIONTIER</parameterCode>
        <parameterValue>ES</parameterValue>
    </pricingParameter>
    <pricingParameter>
        <sequence>3</sequence>
        <parameterCode>GENDER</parameterCode>
        <parameterValue>FEMALE</parameterValue>
    </pricingParameter>
    <modifierInformation>
        <sequence></sequence>
        <parameterCode></parameterCode>
        <parameterValue></parameterValue>
        <rate></rate>
    </modifierInformation>
</baseRate>
<baseRate>
    <sequence>4</sequence>
    <baseFee>80</baseFee>
    <lowerAgeLimit></lowerAgeLimit>
    <upperAgeLimit></upperAgeLimit>
    <pricingParameter>
        <sequence>1</sequence>
        <parameterCode>EMPBAND</parameterCode>
        <parameterValue>IC4</parameterValue>
    </pricingParameter>
    <pricingParameter>
        <sequence>2</sequence>
        <parameterCode>SUBSCRIPTIONTIER</parameterCode>
        <parameterValue>E</parameterValue>
    </pricingParameter>
    <pricingParameter>
        <sequence>3</sequence>
        <parameterCode>GENDER</parameterCode>
        <parameterValue>MALE</parameterValue>
    </pricingParameter>
    <modifierInformation>
        <sequence></sequence>
        <parameterCode></parameterCode>

```

```

        <parameterValue></parameterValue>
        <rate></rate>
    </modifierInformation>
</baseRate>
<characteristics>
    <characteristicsList>
        <characteristicType></characteristicType>
        <characteristicValue></characteristicValue>
        <effectiveDate></effectiveDate>
    </characteristicsList>
</characteristics>
</pricingRuleData>
<pricingRuleData>
    <sequence>2</sequence>
    <entityIdentifiers>
        <entityIdentifiersList>
            <entityIdentifierType>PLCY</entityIdentifierType>
            <entityIdentifierValue>AP234389</entityIdentifierValue>
        </entityIdentifiersList>
        <entityIdentifiersList>
            <entityIdentifierType>SSYS</entityIdentifierType>
            <entityIdentifierValue>SMALLPRIME</entityIdentifierValue>
        </entityIdentifiersList>
        <entityIdentifiersList>
            <entityIdentifierType>PLAN</entityIdentifierType>
            <entityIdentifierValue>PPO_MED_BRONZE_RETIRED</
entityIdentifierValue>
        </entityIdentifiersList>
    </entityIdentifiers>
    <status></status>
    <startDate>2019-01-01</startDate>
    <endDate>2019-12-31</endDate>
    <pricingRuleType>AGE_BASED</pricingRuleType>
    <priceItemCd>MED_PREM_FEE</priceItemCd>
    <rateOption>AGEBASED</rateOption>
    <pricingType></pricingType>
    <modifierApplicability>Y</modifierApplicability>
    <modifierMethod>FLAT</modifierMethod>
    <baseRate>
        <sequence>1</sequence>
        <baseFee>200</baseFee>
        <lowerAgeLimit>0</lowerAgeLimit>
        <upperAgeLimit>19</upperAgeLimit>
        <pricingParameter>
            <sequence>1</sequence>
            <parameterCode>GENDER</parameterCode>
            <parameterValue>FEMALE</parameterValue>
        </pricingParameter>
        <modifierInformation>
            <sequence>1</sequence>
            <parameterCode>TOBUSAGE</parameterCode>
            <parameterValue>Y</parameterValue>
            <rate>20</rate>
        </modifierInformation>
    </baseRate>
    <baseRate>
        <sequence>2</sequence>
        <baseFee>200</baseFee>
        <lowerAgeLimit>0</lowerAgeLimit>
        <upperAgeLimit>19</upperAgeLimit>
        <pricingParameter>
            <sequence>1</sequence>
            <parameterCode>GENDER</parameterCode>
            <parameterValue>MALE</parameterValue>

```

```

        </pricingParameter>
      <modifierInformation>
        <sequence>1</sequence>
        <parameterCode>TOBUSAGE</parameterCode>
        <parameterValue>Y</parameterValue>
        <rate>20</rate>
      </modifierInformation>
    </baseRate>
  <baseRate>
    <sequence>3</sequence>
    <baseFee>300</baseFee>
    <lowerAgeLimit>20</lowerAgeLimit>
    <upperAgeLimit>39</upperAgeLimit>
    <pricingParameter>
      <sequence>1</sequence>
      <parameterCode>GENDER</parameterCode>
      <parameterValue>FEMALE</parameterValue>
    </pricingParameter>
    <modifierInformation>
      <sequence>1</sequence>
      <parameterCode>TOBUSAGE</parameterCode>
      <parameterValue>Y</parameterValue>
      <rate>30</rate>
    </modifierInformation>
  </baseRate>
  <baseRate>
    <sequence>4</sequence>
    <baseFee>300</baseFee>
    <lowerAgeLimit>20</lowerAgeLimit>
    <upperAgeLimit>39</upperAgeLimit>
    <pricingParameter>
      <sequence>1</sequence>
      <parameterCode>GENDER</parameterCode>
      <parameterValue>MALE</parameterValue>
    </pricingParameter>
    <modifierInformation>
      <sequence>1</sequence>
      <parameterCode>TOBUSAGE</parameterCode>
      <parameterValue>Y</parameterValue>
      <rate>30</rate>
    </modifierInformation>
  </baseRate>
  <baseRate>
    <sequence>5</sequence>
    <baseFee>450</baseFee>
    <lowerAgeLimit>40</lowerAgeLimit>
    <upperAgeLimit>59</upperAgeLimit>
    <pricingParameter>
      <sequence>1</sequence>
      <parameterCode>GENDER</parameterCode>
      <parameterValue>FEMALE</parameterValue>
    </pricingParameter>
    <modifierInformation>
      <sequence>1</sequence>
      <parameterCode>TOBUSAGE</parameterCode>
      <parameterValue>Y</parameterValue>
      <rate>40</rate>
    </modifierInformation>
  </baseRate>
  <baseRate>
    <sequence>6</sequence>
    <baseFee>450</baseFee>
    <lowerAgeLimit>40</lowerAgeLimit>
    <upperAgeLimit>59</upperAgeLimit>

```

```

    <pricingParameter>
      <sequence>1</sequence>
      <parameterCode>GENDER</parameterCode>
      <parameterValue>MALE</parameterValue>
    </pricingParameter>
    <modifierInformation>
      <sequence>1</sequence>
      <parameterCode>TOBUSAGE</parameterCode>
      <parameterValue>Y</parameterValue>
      <rate>40</rate>
    </modifierInformation>
  </baseRate>
<baseRate>
  <sequence>7</sequence>
  <baseFee>550</baseFee>
  <lowerAgeLimit>60</lowerAgeLimit>
  <upperAgeLimit>130</upperAgeLimit>
  <pricingParameter>
    <sequence>1</sequence>
    <parameterCode>GENDER</parameterCode>
    <parameterValue>FEMALE</parameterValue>
  </pricingParameter>
  <modifierInformation>
    <sequence>1</sequence>
    <parameterCode>TOBUSAGE</parameterCode>
    <parameterValue>Y</parameterValue>
    <rate>50</rate>
  </modifierInformation>
</baseRate>
<baseRate>
  <sequence>8</sequence>
  <baseFee>550</baseFee>
  <lowerAgeLimit>60</lowerAgeLimit>
  <upperAgeLimit>130</upperAgeLimit>
  <pricingParameter>
    <sequence>1</sequence>
    <parameterCode>GENDER</parameterCode>
    <parameterValue>MALE</parameterValue>
  </pricingParameter>
  <modifierInformation>
    <sequence>1</sequence>
    <parameterCode>TOBUSAGE</parameterCode>
    <parameterValue>Y</parameterValue>
    <rate>50</rate>
  </modifierInformation>
</baseRate>
<characteristics>
  <characteristicsList>
    <characteristicType></characteristicType>
    <characteristicValue></characteristicValue>
    <effectiveDate></effectiveDate>
  </characteristicsList>
</characteristics>
</pricingRuleData>
<pricingRuleData>
  <sequence>3</sequence>
  <entityIdentifiers>
    <entityIdentifiersList>
      <entityIdentifierType>PLCY</entityIdentifierType>
      <entityIdentifierValue>AP234389</entityIdentifierValue>
    </entityIdentifiersList>
    <entityIdentifiersList>
      <entityIdentifierType>SSYS</entityIdentifierType>
      <entityIdentifierValue>SMALLPRIME</entityIdentifierValue>
    </entityIdentifiersList>
  </entityIdentifiers>

```

```

    </entityIdentifiersList>
      <entityIdentifiersList>
        <entityIdentifierType>PLAN</entityIdentifierType>
        <entityIdentifierValue>COBRA_DENTAL</entityIdentifierValue>
      </entityIdentifiersList>
    </entityIdentifiers>
  </status></status>
  <startDate>2021-01-01</startDate>
  <endDate>2021-12-31</endDate>
  <pricingRuleType>CAPITATION_FEES</pricingRuleType>
  <priceItemCd>CAPITATIONFEES</priceItemCd>
  <rateOption>AGEBASED</rateOption>
  <pricingType>FLAT</pricingType>
  <modifierApplicability>Y</modifierApplicability>
  <modifierMethod>EXPT</modifierMethod>
  <baseRate>
    <sequence>1</sequence>
    <baseFee>100</baseFee>
    <lowerAgeLimit></lowerAgeLimit>
    <upperAgeLimit></upperAgeLimit>
    <pricingParameter>
      <sequence></sequence>
      <parameterCode></parameterCode>
      <parameterValue></parameterValue>
    </pricingParameter>
    <modifierInformation>
      <sequence>1</sequence>
      <parameterCode>IC_BAND</parameterCode>
      <parameterValue>IC1</parameterValue>
      <rate>10</rate>
    </modifierInformation>
  </baseRate>
  <baseRate>
    <sequence>2</sequence>
    <baseFee>200</baseFee>
    <lowerAgeLimit></lowerAgeLimit>
    <upperAgeLimit></upperAgeLimit>
    <pricingParameter>
      <sequence></sequence>
      <parameterCode></parameterCode>
      <parameterValue></parameterValue>
    </pricingParameter>
    <modifierInformation>
      <sequence>1</sequence>
      <parameterCode>M1_BAND</parameterCode>
      <parameterValue>M1</parameterValue>
      <rate>30</rate>
    </modifierInformation>
  </baseRate>
  <baseRate>
    <sequence>3</sequence>
    <baseFee>300</baseFee>
    <lowerAgeLimit></lowerAgeLimit>
    <upperAgeLimit></upperAgeLimit>
    <pricingParameter>
      <sequence></sequence>
      <parameterCode></parameterCode>
      <parameterValue></parameterValue>
    </pricingParameter>
    <modifierInformation>
      <sequence>1</sequence>
      <parameterCode>M2_BAND</parameterCode>
      <parameterValue>M2</parameterValue>
      <rate>30</rate>
    </modifierInformation>
  </baseRate>

```

```

        </modifierInformation>
    </baseRate>
    <baseRate>
        <sequence>4</sequence>
        <baseFee>400</baseFee>
        <lowerAgeLimit></lowerAgeLimit>
        <upperAgeLimit></upperAgeLimit>
        <pricingParameter>
            <sequence></sequence>
            <parameterCode></parameterCode>
            <parameterValue></parameterValue>
        </pricingParameter>
        <modifierInformation>
            <sequence>1</sequence>
            <parameterCode>M3_BAND</parameterCode>
            <parameterValue>M3</parameterValue>
            <rate>40</rate>
        </modifierInformation>
    </baseRate>
    <characteristics>
    <characteristicsList>
        <characteristicType></characteristicType>
        <characteristicValue></characteristicValue>
        <effectiveDate></effectiveDate>
    </characteristicsList>
    </characteristics>
</pricingRuleData>
<pricingRuleData>
    <sequence>4</sequence>
    <entityIdentifiers>
        <entityIdentifiersList>
            <entityIdentifierType>PLAN</entityIdentifierType>
            <entityIdentifierValue>RATE_LOCK_MED</entityIdentifierValue>
        </entityIdentifiersList>
    </entityIdentifiers>
    <status></status>
    <startDate>2021-01-01</startDate>
    <endDate>2021-03-31</endDate>
    <pricingRuleType>AGE_BASED</pricingRuleType>
    <priceItemCd>ZZ_AGE_PI</priceItemCd>
    <rateOption>AGEBASED</rateOption>
    <pricingType>FLAT</pricingType>
    <modifierApplicability>Y</modifierApplicability>
    <modifierMethod>EXPT</modifierMethod>
    <baseRate>
        <sequence>1</sequence>
        <baseFee>200</baseFee>
        <lowerAgeLimit>20</lowerAgeLimit>
        <upperAgeLimit>39</upperAgeLimit>
        <pricingParameter>
            <sequence></sequence>
            <parameterCode></parameterCode>
            <parameterValue></parameterValue>
        </pricingParameter>
        <modifierInformation>
            <sequence></sequence>
            <parameterCode></parameterCode>
            <parameterValue></parameterValue>
            <rate></rate>
        </modifierInformation>
    </baseRate>
    <characteristics>
    <characteristicsList>
        <characteristicType></characteristicType>

```

```

        <characteristicValue></characteristicValue>
        <effectiveDate></effectiveDate>
    </characteristicsList>
</characteristics>
</pricingRuleData>
<pricingRuleData>
    <sequence>5</sequence>
    <entityIdentifiers>
        <entityIdentifiersList>
            <entityIdentifierType>PLAN</entityIdentifierType>
            <entityIdentifierValue>RATE_LOCK_MED</
entityIdentifierValue>
        </entityIdentifiersList>
    </entityIdentifiers>
    <status></status>
    <startDate>2021-02-01</startDate>
    <endDate>2021-07-31</endDate>
    <pricingRuleType>TIER_BASED</pricingRuleType>
    <priceItemCd>ZZ_TIER_PI</priceItemCd>
    <rateOption>TIERBASED</rateOption>
    <pricingType></pricingType>
    <modifierApplicability>Y</modifierApplicability>
    <modifierMethod>EXPT</modifierMethod>
    <baseRate>
        <sequence>1</sequence>
        <baseFee>400</baseFee>
        <lowerAgeLimit>40</lowerAgeLimit>
        <upperAgeLimit>59</upperAgeLimit>
        <pricingParameter>
            <sequence></sequence>
            <parameterCode></parameterCode>
            <parameterValue></parameterValue>
        </pricingParameter>
        <modifierInformation>
            <sequence></sequence>
            <parameterCode></parameterCode>
            <parameterValue></parameterValue>
            <rate></rate>
        </modifierInformation>
    </baseRate>
    <characteristics>
        <characteristicsList>
            <characteristicType></characteristicType>
            <characteristicValue></characteristicValue>
            <effectiveDate></effectiveDate>
        </characteristicsList>
    </characteristics>
</pricingRuleData>
<pricingRuleData>
    <sequence>6</sequence>
    <entityIdentifiers>
        <entityIdentifiersList>
            <entityIdentifierType>PLAN</entityIdentifierType>
            <entityIdentifierValue>RATE_LOCK_MED</
entityIdentifierValue>
        </entityIdentifiersList>
    </entityIdentifiers>
    <status></status>
    <startDate>2021-02-01</startDate>
    <endDate>2021-10-31</endDate>
    <pricingRuleType>TIER_BASED</pricingRuleType>
    <priceItemCd>ZZ_TIER_PI</priceItemCd>
    <rateOption>TIERBASED</rateOption>
    <pricingType></pricingType>

```



```

<modifierApplicability>Y</modifierApplicability>
<modifierMethod>EXPT</modifierMethod>
<baseRate>
  <sequence>1</sequence>
  <baseFee>600</baseFee>
  <lowerAgeLimit>60</lowerAgeLimit>
  <upperAgeLimit>79</upperAgeLimit>
  <pricingParameter>
    <sequence></sequence>
    <parameterCode></parameterCode>
    <parameterValue></parameterValue>
  </pricingParameter>
  <modifierInformation>
    <sequence></sequence>
    <parameterCode></parameterCode>
    <parameterValue></parameterValue>
    <rate></rate>
  </modifierInformation>
</baseRate>
<characteristics>
<characteristicsList>
  <characteristicType></characteristicType>
  <characteristicValue></characteristicValue>
  <effectiveDate></effectiveDate>
</characteristicsList>
</characteristics>
</pricingRuleData>
<pricingRuleData>
  <sequence>7</sequence>
  <entityIdentifiers>
    <entityIdentifiersList>
      <entityIdentifierType>PLAN</entityIdentifierType>
      <entityIdentifierValue>RATE_LOCK_MED</
entityIdentifierValue>
    </entityIdentifiersList>
  </entityIdentifiers>
  <status></status>
  <startDate>2021-02-01</startDate>
  <endDate>2021-11-30</endDate>
  <pricingRuleType>AGE_BASED</pricingRuleType>
  <priceItemCd>ZZ_AGE_PI</priceItemCd>
  <rateOption>AGEBASED</rateOption>
  <pricingType>FLAT</pricingType>
  <modifierApplicability>Y</modifierApplicability>
  <modifierMethod>EXPT</modifierMethod>
  <baseRate>
    <sequence>1</sequence>
    <baseFee>800</baseFee>
    <lowerAgeLimit>80</lowerAgeLimit>
    <upperAgeLimit>99</upperAgeLimit>
    <pricingParameter>
      <sequence></sequence>
      <parameterCode></parameterCode>
      <parameterValue></parameterValue>
    </pricingParameter>
    <modifierInformation>
      <sequence></sequence>
      <parameterCode></parameterCode>
      <parameterValue></parameterValue>
      <rate></rate>
    </modifierInformation>
  </baseRate>
  <characteristics>
  <characteristicsList>

```

```

        <characteristicType></characteristicType>
        <characteristicValue></characteristicValue>
        <effectiveDate></effectiveDate>
    </characteristicsList>
</characteristics>
</pricingRuleData>
<pricingRuleData>
    <sequence>8</sequence>
    <entityIdentifiers>
        <entityIdentifiersList>
            <entityIdentifierType>PLAN</entityIdentifierType>
            <entityIdentifierValue>DISC_CHG_MED</entityIdentifierValue>
        </entityIdentifiersList>
    </entityIdentifiers>
    <status></status>
    <startDate>2021-01-01</startDate>
    <endDate>2021-12-31</endDate>
    <pricingRuleType>DISCOUNT_CHARGE</pricingRuleType>
    <priceItemCd>ZZ_DC_PI</priceItemCd>
    <rateOption>ZZ_CAPPCT_PK</rateOption>
    <pricingType>PCNT</pricingType>
    <modifierApplicability>Y</modifierApplicability>
    <modifierMethod>EXPT</modifierMethod>
    <baseRate>
        <sequence>1</sequence>
        <baseFee>50</baseFee>
        <lowerAgeLimit></lowerAgeLimit>
        <upperAgeLimit></upperAgeLimit>
        <pricingParameter>
            <sequence></sequence>
            <parameterCode></parameterCode>
            <parameterValue></parameterValue>
        </pricingParameter>
        <modifierInformation>
            <sequence>1</sequence>
            <parameterCode>VP_BAND</parameterCode>
            <parameterValue>VP1</parameterValue>
            <rate>10</rate>
        </modifierInformation>
    </baseRate>
    <baseRate>
        <sequence>2</sequence>
        <baseFee>70</baseFee>
        <lowerAgeLimit></lowerAgeLimit>
        <upperAgeLimit></upperAgeLimit>
        <pricingParameter>
            <sequence></sequence>
            <parameterCode></parameterCode>
            <parameterValue></parameterValue>
        </pricingParameter>
        <modifierInformation>
            <sequence>1</sequence>
            <parameterCode>M_BAND</parameterCode>
            <parameterValue>M1</parameterValue>
            <rate>20</rate>
        </modifierInformation>
    </baseRate>
    <baseRate>
        <sequence>3</sequence>
        <baseFee>90</baseFee>
        <lowerAgeLimit></lowerAgeLimit>
        <upperAgeLimit></upperAgeLimit>
        <pricingParameter>
            <sequence></sequence>

```

```

        <parameterCode></parameterCode>
        <parameterValue></parameterValue>
    </pricingParameter>
    <modifierInformation>
        <sequence>1</sequence>
        <parameterCode>IC_BAND</parameterCode>
        <parameterValue>IC1</parameterValue>
        <rate>30</rate>
    </modifierInformation>
</baseRate>
<characteristics>
    <characteristicsList>
        <characteristicType></characteristicType>
        <characteristicValue></characteristicValue>
        <effectiveDate></effectiveDate>
    </characteristicsList>
</characteristics>
</pricingRuleData>
<statementConstructsData>
    <personStatementConstructs>
        <personIdentifier></personIdentifier>
        <personIdentifierType></personIdentifierType>
        <statementConstructIdentifier></statementConstructIdentifier>
        <statementAddressSource></statementAddressSource>
        <statementCycle></statementCycle>
        <statementRouteType></statementRouteType>
        <effectiveStatus></effectiveStatus>
        <addressId></addressId>
        <numberOfCopies></numberOfCopies>
        <statementFormat></statementFormat>
        <description></description>
        <statementConstructDetails>
            <serviceAgreement></serviceAgreement>
            <accountNumber></accountNumber>
            <accountNumberTypeCd></accountNumberTypeCd>
            <division></division>
            <statementPrintDescription></statementPrintDescription>
            <printOrder></printOrder>
            <startDate></startDate>
            <endDate></endDate>
        </statementConstructDetails>
        <characteristicsList>
            <characteristicType></characteristicType>
            <characteristicValue></characteristicValue>
            <effectiveDate></effectiveDate>
        </characteristicsList>
    </personStatementConstructs>
</statementConstructsData>
</customerStructureData>
</customerStructureMessage>
</schema>

```

Sample Health Care Inbound Message for Membership

Using the below example, you can do the following:

- Create the persons who are neither parent customer nor bill group
- Create a membership where the person is the main subscriber
- Add persons in a membership

Person Name	Person Type	Policy	Policy Plan	Main Subscriber	Member Relationship Type
G, ALLEN	Person	AP234389	HMO_MED_SILVER_RETIRED	Yes	SELF
G, JOHNSON	Person	AP234389	HMO_MED_SILVER_RETIRED	No	SPOUSE
G, CLARK	Person	AP234389	HMO_MED_SILVER_RETIRED	No	SON
G, NELSON	Person	AP234389	HMO_MED_SILVER_RETIRED	No	SON
G, PARKER	Person	AP234389	HMO_MED_SILVER_RETIRED	No	SON
G, RUSSEL	Person	AP234389	HMO_MED_SILVER_RETIRED	No	SON
G, LINDA	Person	AP234389	HMO_MED_SILVER_RETIRED	No	DAUGHTER

```

<schema>
  <bo>C1-HCInboundMessage</bo>
  <characteristics>
    <inboundMessageCharacteristic>
      <ad hocCharacteristicValue></ad hocCharacteristicValue>
      <characteristicType>C1-EXTBTCT</characteristicType>
      <effectiveDate>2019-01-01</effectiveDate>
      <characteristicValue>DATAEXT2</characteristicValue>
      <characteristicValueForeignKey1></characteristicValueForeignKey1>
      <characteristicValueFK2></characteristicValueFK2>
      <characteristicValueFK3></characteristicValueFK3>
      <characteristicValueFK4></characteristicValueFK4>
      <characteristicValueFK5></characteristicValueFK5>
    </inboundMessageCharacteristic>
  </characteristics>
  <customerStructureMessage>
    <headerData>
      <messageType>C1-HEALTHCARE-INB-MSG-TYPE</messageType>
      <sourceSystem>SMALLPRIME</sourceSystem>
      <externalTransactionId>123445</externalTransactionId>
      <externalBatchId>433443</externalBatchId>
      <externalSourceId>656565</externalSourceId>
    </headerData>
    <customerStructureData>
      <personData>
        <sequence>1</sequence>
        <personType>P</personType>
        <personName>
          <sequence>1</sequence>
          <entityName>G, ALLEN</entityName>
          <nameType>PRIM</nameType>
        </personName>
        <identifiers>
          <idType>SSN</idType>
          <idValue>987-65-4323</idValue>
          <isPrimary>Y</isPrimary>
        </identifiers>
        <division>HC</division>
        <birthDate>1965-02-02</birthDate>
        <sinceDate>2019-01-01</sinceDate>
        <address>
          <addressEffDate>2019-01-01</addressEffDate>
          <addressType>MAIN</addressType>
          <mailingName>ALLEN</mailingName>
          <address1>Saturn Apartment</address1>
          <address2>Saturn Street</address2>
        </address>
      </personData>
    </customerStructureData>
  </customerStructureMessage>
</schema>

```

```

    <address3>River Side</address3>
    <address4></address4>
    <city>Buffalo</city>
    <state>NY</state>
    <zip>14201</zip>
    <country>USA</country>
    <houseType></houseType>
    <streetNumber1></streetNumber1>
    <streetNumber2></streetNumber2>
    <inCityLimit></inCityLimit>
    <taxVendorGeographicalCode></taxVendorGeographicalCode>
    <county></county>
  </address>
  <email>allen.g@example.com</email>
  <overrideMailingName1></overrideMailingName1>
  <overrideMailingName2></overrideMailingName2>
  <overrideMailingName3></overrideMailingName3>
  <phones>
    <phoneType>BUSN</phoneType>
    <phoneValue>716-555-0135</phoneValue>
  </phones>
  <relatedPersons>
    <idType></idType>
    <idValue></idValue>
    <personRelationshipType></personRelationshipType>
    <startDate></startDate>
    <endDate></endDate>
    <financialRelationshipSw></financialRelationshipSw>
    <parentOrChild></parentOrChild>
    <characteristics>
      <characteristicsList>
        <characteristicType></characteristicType>
        <characteristicValue></characteristicValue>
        <effectiveDate></effectiveDate>
      </characteristicsList>
    </characteristics>
  </relatedPersons>
  <characteristics>
    <characteristicsList>
      <characteristicType>PER_CAT</characteristicType>
      <characteristicValue>EMPLOYEE</characteristicValue>
      <effectiveDate>2019-01-01</effectiveDate>
    </characteristicsList>
  </characteristics>
  <memberData>
    <sequence>10</sequence>
    <startDate>2019-01-01</startDate>
    <endDate>2019-12-31</endDate>
    <memberId>1000410004</memberId>
    <memberRelationship>SELF</memberRelationship>
    <membershipPersonStatus></membershipPersonStatus>
    <mainSubscriber>
      <idType>SSN</idType>
      <idValue>987-65-4323</idValue>
    </mainSubscriber>
    <policyNumber>AP234389</policyNumber>
    <sourceSystem>SMALLPRIME</sourceSystem>
    <planNumber>HMO_MED_SILVER_RETIRED</planNumber>
    <characteristics>
      <characteristicsList>
        <characteristicType>BILLLEV1</characteristicType>
        <characteristicValue>RETIRED</characteristicValue>
        <effectiveDate>2019-01-01</effectiveDate>
      </characteristicsList>
    </characteristics>
  </memberData>

```

```

    <characteristicsList>
      <characteristicType>BILLLEV2</characteristicType>
      <characteristicValue>SEATTLE</characteristicValue>
      <effectiveDate>2019-01-01</effectiveDate>
    </characteristicsList>
  </characteristicsList>
  <characteristicsList>
    <characteristicType>BILLLEV3</characteristicType>
    <characteristicValue>MEDICAL</characteristicValue>
    <effectiveDate>2019-01-01</effectiveDate>
  </characteristicsList>
  <characteristicsList>
    <characteristicType>BILLLEV4</characteristicType>
    <characteristicValue>HMO</characteristicValue>
    <effectiveDate>2019-01-01</effectiveDate>
  </characteristicsList>
</characteristics>
<membershipPersonCharacteristic>
  <characteristicsList>
    <characteristicType>TOBUSAGE</characteristicType>
    <characteristicValue>N</characteristicValue>
    <effectiveDate>2019-01-01</effectiveDate>
  </characteristicsList>
  <characteristicsList>
    <characteristicType>C1-GENDR</characteristicType>
    <characteristicValue>FEMALE</characteristicValue>
    <effectiveDate>2019-01-01</effectiveDate>
  </characteristicsList>
</membershipPersonCharacteristic>
<billableChargeData>
  <sequence>1</sequence>
  <accountIdType>ACCT_NM</accountIdType>
  <accountIdValue>Medical Account</accountIdValue>
  <chargeType></chargeType>
  <startDate>2019-01-01</startDate>
  <endDate>2019-03-31</endDate>
  <priceItemCode>MED_PREM_FEE</priceItemCode>
  <description>Recurring Premium Fees</description>
  <recurringMethod>BP</recurringMethod>
  <billPeriod>HC</billPeriod>
  <frequency></frequency>
  <billAfterDt></billAfterDt>
  <billableChargeLines>
    <descriptionOnBill>Premium Fees</
descriptionOnBill>
    <currencyCode>USD</currencyCode>
    <chargeAmount>100</chargeAmount>
    <showOnBillSw>true</showOnBillSw>
    <appearInSummarySw>false</appearInSummarySw>
    <distributionCode>HC</distributionCode>
  </billableChargeLines>
  <characteristics>
    <characteristicsList>
      <characteristicType></characteristicType>
      <characteristicValue></characteristicValue>
      <effectiveDate></effectiveDate>
    </characteristicsList>
  </characteristics>
</billableChargeData>
<billableChargeData>
  <sequence>2</sequence>
  <accountIdType>ACCT_NM</accountIdType>
  <accountIdValue>Dental Account</accountIdValue>
  <chargeType></chargeType>
  <startDate>2019-01-01</startDate>

```

```

        <endDate>2019-12-31</endDate>
        <priceItemCode>DEN_PREM_FEE</priceItemCode>
        <description>Recurring Premium Fees</description>
        <recurringMethod>BP</recurringMethod>
        <billPeriod>HC</billPeriod>
        <frequency></frequency>
        <billAfterDt></billAfterDt>
        <billableChargeLines>
            <descriptionOnBill>Premium Fees</
descriptionOnBill>
            <currencyCode>USD</currencyCode>
            <chargeAmount>50</chargeAmount>
            <showOnBillSw>true</showOnBillSw>
            <appearInSummarySw>true</appearInSummarySw>
            <distributionCode>HC</distributionCode>
        </billableChargeLines>
        <characteristics>
            <characteristicsList>
                <characteristicType></characteristicType>
                <characteristicValue></characteristicValue>
                <effectiveDate></effectiveDate>
            </characteristicsList>
        </characteristics>
    </billableChargeData>
    <billableChargeData>
        <sequence>3</sequence>
        <accountIdType></accountIdType>
        <accountIdValue></accountIdValue>
        <chargeType></chargeType>
        <startDate>2019-01-01</startDate>
        <endDate>2019-12-31</endDate>
        <priceItemCode>MED_PREM_FEE</priceItemCode>
        <description>Recurring Premium Fees</description>
        <recurringMethod>BP</recurringMethod>
        <billPeriod>HC</billPeriod>
        <frequency></frequency>
        <billAfterDt></billAfterDt>
        <billableChargeLines>
            <descriptionOnBill>Premium Fees</
descriptionOnBill>
            <currencyCode>USD</currencyCode>
            <chargeAmount>100</chargeAmount>
            <showOnBillSw>true</showOnBillSw>
            <appearInSummarySw>true</appearInSummarySw>
            <distributionCode>HC</distributionCode>
        </billableChargeLines>
        <characteristics>
            <characteristicsList>
                <characteristicType></characteristicType>
                <characteristicValue></characteristicValue>
                <effectiveDate></effectiveDate>
            </characteristicsList>
        </characteristics>
    </billableChargeData>
    </memberData>
</personData>
<personData>
    <sequence>2</sequence>
    <personType>P</personType>
    <personName>
        <sequence>1</sequence>
        <entityName>G, JOHNSON</entityName>
        <nameType>PRIM</nameType>
    </personName>

```

```

<identifiers>
  <idType>SSN</idType>
  <idValue>987-65-4324</idValue>
  <isPrimary>Y</isPrimary>
</identifiers>
<division>HC</division>
<birthDate>1964-03-03</birthDate>
<sinceDate>2019-01-01</sinceDate>
<address>
  <addressEffDate>2019-01-01</addressEffDate>
  <addressType>MAIN</addressType>
  <mailingName>JOHNSON</mailingName>
  <address1>Saturn Apartment</address1>
  <address2>Saturn Street</address2>
  <address3>River Side</address3>
  <address4></address4>
  <city>Buffalo</city>
  <state>NY</state>
  <zip>14201</zip>
  <country>USA</country>
  <houseType></houseType>
  <streetNumber1></streetNumber1>
  <streetNumber2></streetNumber2>
  <inCityLimit></inCityLimit>
  <taxVendorGeographicalCode></taxVendorGeographicalCode>
  <county></county>
</address>
<email>johnson.g@example.com</email>
<overrideMailingName1></overrideMailingName1>
<overrideMailingName2></overrideMailingName2>
<overrideMailingName3></overrideMailingName3>
<phones>
  <phoneType>BUSN</phoneType>
  <phoneValue>716-555-0122</phoneValue>
</phones>
<relatedPersons>
  <idType></idType>
  <idValue></idValue>
  <personRelationshipType></personRelationshipType>
  <startDate></startDate>
  <endDate></endDate>
  <financialRelationshipSw></financialRelationshipSw>
  <parentOrChild></parentOrChild>
  <characteristics>
    <characteristicsList>
      <characteristicType></characteristicType>
      <characteristicValue></characteristicValue>
      <effectiveDate></effectiveDate>
    </characteristicsList>
  </characteristics>
</relatedPersons>
<characteristics>
  <characteristicsList>
    <characteristicType></characteristicType>
    <characteristicValue></characteristicValue>
    <effectiveDate></effectiveDate>
  </characteristicsList>
</characteristics>
<memberData>
  <sequence>10</sequence>
  <startDate>2019-01-01</startDate>
  <endDate>2019-12-31</endDate>
  <memberId>1000410004</memberId>
  <memberRelationship>SPOUSE</memberRelationship>

```



```

    <membershipPersonStatus></membershipPersonStatus>
  <mainSubscriber>
    <idType>SSN</idType>
    <idValue>987-65-4323</idValue>
  </mainSubscriber>
  <policyNumber>AP234389</policyNumber>
  <sourceSystem>SMALLPRIME</sourceSystem>
  <planNumber>HMO_MED_SILVER_RETIRED</planNumber>
  <characteristics>
    <characteristicsList>
      <characteristicType></characteristicType>
      <characteristicValue></characteristicValue>
      <effectiveDate></effectiveDate>
    </characteristicsList>
  </characteristics>
  <membershipPersonCharacteristic>
    <characteristicsList>
      <characteristicType>TOBUSUSAGE</characteristicType>
      <characteristicValue>Y</characteristicValue>
      <effectiveDate>2019-01-01</effectiveDate>
    </characteristicsList>
    <characteristicsList>
      <characteristicType>C1-GENDR</characteristicType>
      <characteristicValue>MALE</characteristicValue>
      <effectiveDate>2019-01-01</effectiveDate>
    </characteristicsList>
  </membershipPersonCharacteristic>
</memberData>
</personData>
<personData>
  <sequence>3</sequence>
  <personType>P</personType>
  <personName>
    <sequence>1</sequence>
    <entityName>G, CLARK</entityName>
    <nameType>PRIM</nameType>
  </personName>
  <identifiers>
    <idType>SSN</idType>
    <idValue>987-65-4325</idValue>
    <isPrimary>Y</isPrimary>
  </identifiers>
  <division>HC</division>
  <birthDate>2004-08-08</birthDate>
  <sinceDate>2019-01-01</sinceDate>
  <address>
    <addressEffDate>2019-01-01</addressEffDate>
    <addressType>MAIN</addressType>
    <mailingName>CLARK</mailingName>
    <address1>Saturn Apartment</address1>
    <address2>Saturn Street</address2>
    <address3>River Side</address3>
    <address4></address4>
    <city>Buffalo</city>
    <state>NY</state>
    <zip>14201</zip>
    <country>USA</country>
    <houseType></houseType>
    <streetNumber1></streetNumber1>
    <streetNumber2></streetNumber2>
    <inCityLimit></inCityLimit>
    <taxVendorGeographicalCode></taxVendorGeographicalCode>
    <county></county>
  </address>

```

```

<email>clark.g@example.com</email>
<overrideMailingName1></overrideMailingName1>
<overrideMailingName2></overrideMailingName2>
<overrideMailingName3></overrideMailingName3>
<phones>
  <phoneType>BUSN</phoneType>
  <phoneValue>716-555-0109</phoneValue>
</phones>
<relatedPersons>
  <idType></idType>
  <idValue></idValue>
  <personRelationshipType></personRelationshipType>
  <startDate></startDate>
  <endDate></endDate>
  <financialRelationshipSw></financialRelationshipSw>
  <parentOrChild></parentOrChild>
  <characteristics>
    <characteristicsList>
      <characteristicType></characteristicType>
      <characteristicValue></characteristicValue>
      <effectiveDate></effectiveDate>
    </characteristicsList>
  </characteristics>
</relatedPersons>
<characteristics>
  <characteristicsList>
    <characteristicType></characteristicType>
    <characteristicValue></characteristicValue>
    <effectiveDate></effectiveDate>
  </characteristicsList>
</characteristics>
<memberData>
  <sequence>10</sequence>
  <startDate>2019-01-01</startDate>
  <endDate>2019-12-31</endDate>
  <memberId>1000410004</memberId>
  <memberRelationship>SON</memberRelationship>
  <membershipPersonStatus></membershipPersonStatus>
  <mainSubscriber>
    <idType>SSN</idType>
    <idValue>987-65-4323</idValue>
  </mainSubscriber>
  <policyNumber>AP234389</policyNumber>
  <sourceSystem>SMALLPRIME</sourceSystem>
  <planNumber>HMO_MED_SILVER_RETIRED</planNumber>
  <characteristics>
    <characteristicsList>
      <characteristicType></characteristicType>
      <characteristicValue></characteristicValue>
      <effectiveDate></effectiveDate>
    </characteristicsList>
  </characteristics>
  <membershipPersonCharacteristic>
    <characteristicsList>
      <characteristicType>TOBUSAGE</characteristicType>
      <characteristicValue>N</characteristicValue>
      <effectiveDate>2019-01-01</effectiveDate>
    </characteristicsList>
    <characteristicsList>
      <characteristicType>C1-GENDR</characteristicType>
      <characteristicValue>MALE</characteristicValue>
      <effectiveDate>2019-01-01</effectiveDate>
    </characteristicsList>
  </membershipPersonCharacteristic>

```

```

    </memberData>
  </personData>
  <personData>
    <sequence>4</sequence>
    <personType>P</personType>
    <personName>
      <sequence>1</sequence>
      <entityName>G, NELSON</entityName>
      <nameType>PRIM</nameType>
    </personName>
    <identifiers>
      <idType>SSN</idType>
      <idValue>987-65-4326</idValue>
      <isPrimary>Y</isPrimary>
    </identifiers>
    <division>HC</division>
    <birthDate>2002-07-07</birthDate>
    <sinceDate>2019-01-01</sinceDate>
    <address>
      <addressEffDate>2019-01-01</addressEffDate>
      <addressType>MAIN</addressType>
      <mailingName>NELSON</mailingName>
      <address1>Saturn Apartment</address1>
      <address2>Saturn Street</address2>
      <address3>River Side</address3>
      <address4></address4>
      <city>Buffalo</city>
      <state>NY</state>
      <zip>14201</zip>
      <country>USA</country>
      <houseType></houseType>
      <streetNumber1></streetNumber1>
      <streetNumber2></streetNumber2>
      <inCityLimit></inCityLimit>
      <taxVendorGeographicalCode></taxVendorGeographicalCode>
      <county></county>
    </address>
    <email>neilson.g@example.com</email>
    <overrideMailingName1></overrideMailingName1>
    <overrideMailingName2></overrideMailingName2>
    <overrideMailingName3></overrideMailingName3>
    <phones>
      <phoneType>BUSN</phoneType>
      <phoneValue>716-555-0108</phoneValue>
    </phones>
    <relatedPersons>
      <idType></idType>
      <idValue></idValue>
      <personRelationshipType></personRelationshipType>
      <startDate></startDate>
      <endDate></endDate>
      <financialRelationshipSw></financialRelationshipSw>
      <parentOrChild></parentOrChild>
      <characteristics>
        <characteristicsList>
          <characteristicType></characteristicType>
          <characteristicValue></characteristicValue>
          <effectiveDate></effectiveDate>
        </characteristicsList>
      </characteristics>
    </relatedPersons>
    <characteristics>
      <characteristicsList>
        <characteristicType></characteristicType>

```

```

        <characteristicValue></characteristicValue>
        <effectiveDate></effectiveDate>
    </characteristicsList>
</characteristics>
<memberData>
    <sequence>10</sequence>
    <startDate>2019-01-01</startDate>
    <endDate>2019-12-31</endDate>
    <memberId>1000410004</memberId>
    <memberRelationship>SON</memberRelationship>
    <membershipPersonStatus></membershipPersonStatus>
    <mainSubscriber>
        <idType>SSN</idType>
        <idValue>987-65-4323</idValue>
    </mainSubscriber>
    <policyNumber>AP234389</policyNumber>
    <sourceSystem>SMALLPRIME</sourceSystem>
    <planNumber>HMO_MED_SILVER_RETIRED</planNumber>
    <characteristics>
        <characteristicsList>
            <characteristicType></characteristicType>
            <characteristicValue></characteristicValue>
            <effectiveDate></effectiveDate>
        </characteristicsList>
    </characteristics>
    <membershipPersonCharacteristic>
        <characteristicsList>
            <characteristicType>TOBUSAGE</characteristicType>
            <characteristicValue>N</characteristicValue>
            <effectiveDate>2019-01-01</effectiveDate>
        </characteristicsList>
        <characteristicsList>
            <characteristicType>C1-GENDR</characteristicType>
            <characteristicValue>MALE</characteristicValue>
            <effectiveDate>2019-01-01</effectiveDate>
        </characteristicsList>
    </membershipPersonCharacteristic>
</memberData>
</personData>
<personData>
    <sequence>5</sequence>
    <personType>P</personType>
    <personName>
        <sequence>1</sequence>
        <entityName>G, PARKER</entityName>
        <nameType>PRIM</nameType>
    </personName>
    <identifiers>
        <idType>SSN</idType>
        <idValue>987-65-4327</idValue>
        <isPrimary>Y</isPrimary>
    </identifiers>
    <division>HC</division>
    <birthDate>1995-06-06</birthDate>
    <sinceDate>2019-01-01</sinceDate>
    <address>
        <addressEffDate>2019-01-01</addressEffDate>
        <addressType>MAIN</addressType>
        <mailingName>PARKER</mailingName>
        <address1>Saturn Apartment</address1>
        <address2>Saturn Street</address2>
        <address3>River Side</address3>
        <address4></address4>
        <city>Buffalo</city>
    </address>

```

```

    <state>NY</state>
    <zip>14201</zip>
    <country>USA</country>
    <houseType></houseType>
    <streetNumber1></streetNumber1>
    <streetNumber2></streetNumber2>
    <inCityLimit></inCityLimit>
    <taxVendorGeographicalCode></taxVendorGeographicalCode>
    <county></county>
  </address>
  <email>parker.g@example.com</email>
  <overrideMailingName1></overrideMailingName1>
  <overrideMailingName2></overrideMailingName2>
  <overrideMailingName3></overrideMailingName3>
  <phones>
    <phoneType>BUSN</phoneType>
    <phoneValue>716-555-0107</phoneValue>
  </phones>
  <relatedPersons>
    <idType></idType>
    <idValue></idValue>
    <personRelationshipType></personRelationshipType>
    <startDate></startDate>
    <endDate></endDate>
    <financialRelationshipSw></financialRelationshipSw>
    <parentOrChild></parentOrChild>
    <characteristics>
      <characteristicsList>
        <characteristicType></characteristicType>
        <characteristicValue></characteristicValue>
        <effectiveDate></effectiveDate>
      </characteristicsList>
    </characteristics>
  </relatedPersons>
  <characteristics>
    <characteristicsList>
      <characteristicType></characteristicType>
      <characteristicValue></characteristicValue>
      <effectiveDate></effectiveDate>
    </characteristicsList>
  </characteristics>
  <memberData>
    <sequence>10</sequence>
    <startDate>2019-01-01</startDate>
    <endDate>2019-12-31</endDate>
    <memberId>1000410004</memberId>
    <memberRelationship>SON</memberRelationship>
    <membershipPersonStatus></membershipPersonStatus>
    <mainSubscriber>
      <idType>SSN</idType>
      <idValue>987-65-4323</idValue>
    </mainSubscriber>
    <policyNumber>AP234389</policyNumber>
    <sourceSystem>SMALLPRIME</sourceSystem>
    <planNumber>HMO_MED_SILVER_RETIRED</planNumber>
    <characteristics>
      <characteristicsList>
        <characteristicType></characteristicType>
        <characteristicValue></characteristicValue>
        <effectiveDate></effectiveDate>
      </characteristicsList>
    </characteristics>
    <membershipPersonCharacteristic>
      <characteristicsList>

```

```

        <characteristicType>TOBUSUSAGE</characteristicType>
        <characteristicValue>N</characteristicValue>
        <effectiveDate>2019-01-01</effectiveDate>
    </characteristicsList>
    <characteristicsList>
        <characteristicType>C1-GENDR</characteristicType>
        <characteristicValue>MALE</characteristicValue>
        <effectiveDate>2019-01-01</effectiveDate>
    </characteristicsList>
    </membershipPersonCharacteristic>
</memberData>
</personData>
<personData>
    <sequence>6</sequence>
    <personType>P</personType>
    <personName>
        <sequence>1</sequence>
        <entityName>G, RUSSEL</entityName>
        <nameType>PRIM</nameType>
    </personName>
    <identifiers>
        <idType>SSN</idType>
        <idValue>987-65-4328</idValue>
        <isPrimary>Y</isPrimary>
    </identifiers>
    <division>HC</division>
    <birthDate>2000-04-04</birthDate>
    <sinceDate>2019-01-01</sinceDate>
    <address>
        <addressEffDate>2019-01-01</addressEffDate>
        <addressType>MAIN</addressType>
        <mailingName>RUSSEL</mailingName>
        <address1>Saturn Apartment</address1>
        <address2>Saturn Street</address2>
        <address3>River Side</address3>
        <address4></address4>
        <city>Buffalo</city>
        <state>NY</state>
        <zip>14201</zip>
        <country>USA</country>
        <houseType></houseType>
        <streetNumber1></streetNumber1>
        <streetNumber2></streetNumber2>
        <inCityLimit></inCityLimit>
        <taxVendorGeographicalCode></taxVendorGeographicalCode>
        <county></county>
    </address>
    <email>russel.g@example.com</email>
    <overrideMailingName1></overrideMailingName1>
    <overrideMailingName2></overrideMailingName2>
    <overrideMailingName3></overrideMailingName3>
    <phones>
        <phoneType>BUSN</phoneType>
        <phoneValue>716-555-0106</phoneValue>
    </phones>
    <relatedPersons>
        <idType></idType>
        <idValue></idValue>
        <personRelationshipType></personRelationshipType>
        <startDate></startDate>
        <endDate></endDate>
        <financialRelationshipSw></financialRelationshipSw>
        <parentOrChild></parentOrChild>
        <characteristics>

```

```

        <characteristicsList>
            <characteristicType></characteristicType>
            <characteristicValue></characteristicValue>
            <effectiveDate></effectiveDate>
        </characteristicsList>
    </characteristics>
</relatedPersons>
<characteristics>
    <characteristicsList>
        <characteristicType></characteristicType>
        <characteristicValue></characteristicValue>
        <effectiveDate></effectiveDate>
    </characteristicsList>
</characteristics>
<memberData>
    <sequence>10</sequence>
    <startDate>2019-01-01</startDate>
    <endDate>2019-12-31</endDate>
    <memberId>1000410004</memberId>
    <memberRelationship>SON</memberRelationship>
    <membershipPersonStatus></membershipPersonStatus>
    <mainSubscriber>
        <idType>SSN</idType>
        <idValue>987-65-4323</idValue>
    </mainSubscriber>
    <policyNumber>AP234389</policyNumber>
    <sourceSystem>SMALLPRIME</sourceSystem>
    <planNumber>HMO_MED_SILVER_RETIRED</planNumber>
    <characteristics>
        <characteristicsList>
            <characteristicType></characteristicType>
            <characteristicValue></characteristicValue>
            <effectiveDate></effectiveDate>
        </characteristicsList>
    </characteristics>
    <membershipPersonCharacteristic>
        <characteristicsList>
            <characteristicType>TOBUSAGE</characteristicType>
            <characteristicValue>N</characteristicValue>
            <effectiveDate>2019-01-01</effectiveDate>
        </characteristicsList>
        <characteristicsList>
            <characteristicType>C1-GENDR</characteristicType>
            <characteristicValue>MALE</characteristicValue>
            <effectiveDate>2019-01-01</effectiveDate>
        </characteristicsList>
    </membershipPersonCharacteristic>
</memberData>
</personData>
<personData>
    <sequence>7</sequence>
    <personType>P</personType>
    <personName>
        <sequence>1</sequence>
        <entityName>G, LINDA</entityName>
        <nameType>PRIM</nameType>
    </personName>
    <identifiers>
        <idType>SSN</idType>
        <idValue>987-65-4329</idValue>
        <isPrimary>Y</isPrimary>
    </identifiers>
    <division>HC</division>
    <birthDate>1998-05-05</birthDate>

```

```

<sinceDate>2019-01-01</sinceDate>
<address>
  <addressEffDate>2019-01-01</addressEffDate>
  <addressType>MAIN</addressType>
  <mailingName>LINDA</mailingName>
  <address1>Saturn Apartment</address1>
  <address2>Saturn Street</address2>
  <address3>River Side</address3>
  <address4></address4>
  <city>Buffalo</city>
  <state>NY</state>
  <zip>14201</zip>
  <country>USA</country>
  <houseType></houseType>
  <streetNumber1></streetNumber1>
  <streetNumber2></streetNumber2>
  <inCityLimit></inCityLimit>
  <taxVendorGeographicalCode></taxVendorGeographicalCode>
  <county></county>
</address>
<email>linda.g@example.com</email>
<overrideMailingName1></overrideMailingName1>
<overrideMailingName2></overrideMailingName2>
<overrideMailingName3></overrideMailingName3>
<phones>
  <phoneType>BUSN</phoneType>
  <phoneValue>716-555-0103</phoneValue>
</phones>
<relatedPersons>
  <idType></idType>
  <idValue></idValue>
  <personRelationshipType></personRelationshipType>
  <startDate></startDate>
  <endDate></endDate>
  <financialRelationshipSw></financialRelationshipSw>
  <parentOrChild></parentOrChild>
  <characteristics>
    <characteristicsList>
      <characteristicType></characteristicType>
      <characteristicValue></characteristicValue>
      <effectiveDate></effectiveDate>
    </characteristicsList>
  </characteristics>
</relatedPersons>
<characteristics>
  <characteristicsList>
    <characteristicType></characteristicType>
    <characteristicValue></characteristicValue>
    <effectiveDate></effectiveDate>
  </characteristicsList>
</characteristics>
<memberData>
  <sequence>10</sequence>
  <startDate>2019-01-01</startDate>
  <endDate>2019-12-31</endDate>
  <memberId>1000410004</memberId>
  <memberRelationship>DAUGHTER</memberRelationship>
  <membershipPersonStatus></membershipPersonStatus>
  <mainSubscriber>
    <idType>SSN</idType>
    <idValue>987-65-4323</idValue>
  </mainSubscriber>
  <policyNumber>AP234389</policyNumber>
  <sourceSystem>SMALLPRIME</sourceSystem>

```



```

    <planNumber>HMO_MED_SILVER_RETIRED</planNumber>
    <characteristics>
      <characteristicsList>
        <characteristicType></characteristicType>
        <characteristicValue></characteristicValue>
        <effectiveDate></effectiveDate>
      </characteristicsList>
    </characteristics>
    <membershipPersonCharacteristic>
      <characteristicsList>
        <characteristicType>TOBUSAGE</characteristicType>
        <characteristicValue>N</characteristicValue>
        <effectiveDate>2019-02-05</effectiveDate>
      </characteristicsList>
      <characteristicsList>
        <characteristicType>C1-GENDR</characteristicType>
        <characteristicValue>FEMALE</characteristicValue>
        <effectiveDate>2019-02-05</effectiveDate>
      </characteristicsList>
    </membershipPersonCharacteristic>
  </memberData>
</personData>
</customerStructureData>
</customerStructureMessage>
</schema>

```

Health Product and Plan Inbound Message

On calling the **C1-HCProdHlthPlnInboundMessage** or **C1-HCProdHlthPlnInboundMes** web service, you can define a health product and plan inbound message using a health product and plan inbound message type. The **C1-HCProdHlthPlnInboundMessage** is a **SOAP** service which helps to create a health product, health plan, and pricing rule for a health plan through an inbound message, whereas the **C1-HCProdHlthPlnInboundMes** is a **RESTful** service which helps to create and edit a health product, health plan, and pricing rule for a health plan through an inbound message.

You can define a health product and plan inbound message type using the **Health Product and Plan Inbound Message Type (C1-HCProdHlthPlnInboundTyp)** business object through the **Inbound Message Type** screen. The health product and plan inbound message type business object encapsulates the following information:

- A business object using which you want to create the health product when the health product and plan inbound message is processed.
- A business object using which you want to create the health plan when the health product and plan inbound message is processed.

The health product and plan inbound message type helps the system to determine:

- **Inbound Message Business Object** - The business object using which the health product and plan inbound message should be created in the system. You must specify the **Health Product and Plan Inbound Message (C1-HCProdHlthPlnInbound)** business object in the health product and plan inbound message type. The health product and plan inbound message business object enables you to create and edit the following entities for a fully-insured individual customer through an inbound web service:
 - Health Product
 - Health Plan
 - Health Plan Pricing Rules

Note: You can create or update the above entities either through a single or separate health product and plan inbound messages.

- **Health Care Product Business Object** - The business object using which health product should be created in the system. You must specify the **Health Care Product (C1-HealthcareProduct)** business object in the health product and plan inbound message type.
- **Health Plan Business Object** - The business object using which health plan should be created in the system. You must specify the **Health Plan (C1-HealthPlan)** business object in the health product and plan inbound message type.

On calling the **C1-HCProdHlthPlnInboundMessage** or **C1-HCProdHlthPlnInboundMes** web service, a batch named **C1-HCPHP** checks whether there are any health product and plan inbound messages in the **Pending** status. If there is a health product and plan inbound message in the **Pending** status, the batch changes the status of the health product and plan inbound message to the default next status (i.e. **Validation**). Then, the algorithm attached to the **Validation** status is triggered. If the validation is successful, the system changes the status of the health product and plan inbound message to **Processing**. Then, the algorithm attached to the **Processing** status is triggered. If the processing is successful, the system creates or updates the entities, such as health product, health plan, pricing rules for the health plan, and then changes the status of the health product and plan inbound message to **Processed**.

Related Topics

For more information on...	See...
How to setup the C1-ASOBLLNG feature configuration	Setting the C1-ASOBLLNG Feature Configuration on page 3421

Prerequisites

To use the health product and plan inbound message feature, you need to do the following:

- Define the required health product and plan inbound message types in the system.
- Assign the **Product (C1_PRODUCT)** maintenance object to the **Healthcare Product (C1-HealthcareProduct)** business object, while defining the health product and plan inbound message type.
- Define the required characteristic types where the characteristic entity is set to **Inbound Message Type**
- Define the required characteristic types where the characteristic entity is set to **Inbound Message**.
- Define the required characteristic types where the characteristic entity is set to **Health Plan**.
- Define the required characteristic types where the characteristic entity is set to **Product**.
- Define the **Health Product and Plan Inbound Message (C1-HCProdHlthPlnInbound)** business object in the system.
- Define the **Health Product and Plan Inbound Message Type (C1-HCProdHlthPlnInboundTyp)** business object in the system.
- Define the **Healthcare Product (C1-HealthcareProduct)** business object in the system.
- Define the **Health Plan (C1-HealthPlan)** business object in the system.
- Define the required pricing rule type business object in the system.
- Define the required values for the health plan in the **PRC_RULE_ENTITY_TYPE** lookup field.

Health Product and Plan Inbound Message Status Transition through User Interface

The following figure graphically indicates how a health care inbound message moves from one status to another when it is validated and processed through the user interface:

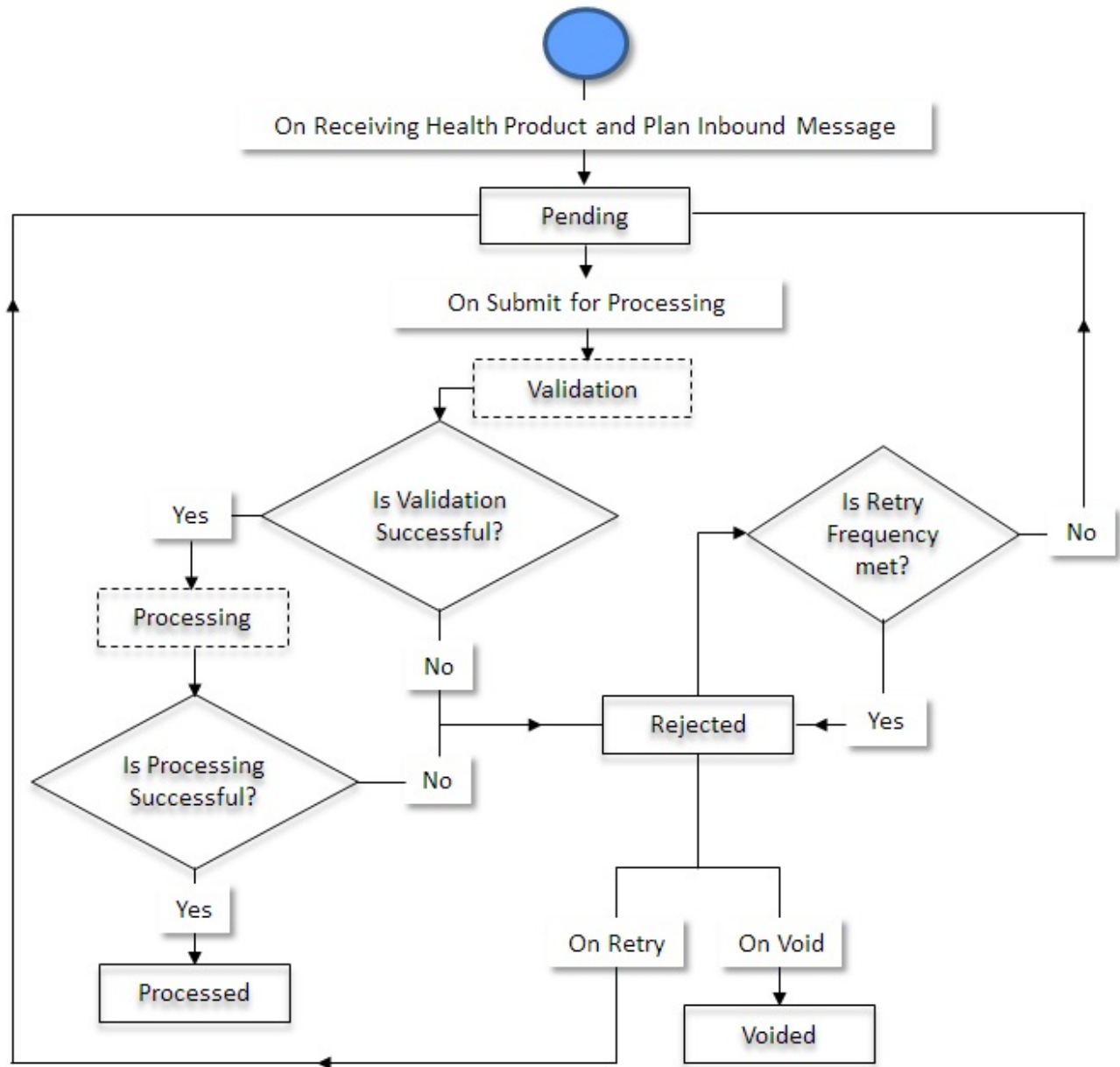

Health Product and Plan Inbound Message Status Transition through a Batch Process

The following figure graphically indicates how a health care inbound message moves from one status to another when it is validated and processed through the **Health Product and Plan Inbound Message Periodic Monitor (C1-HCPHP)** batch:

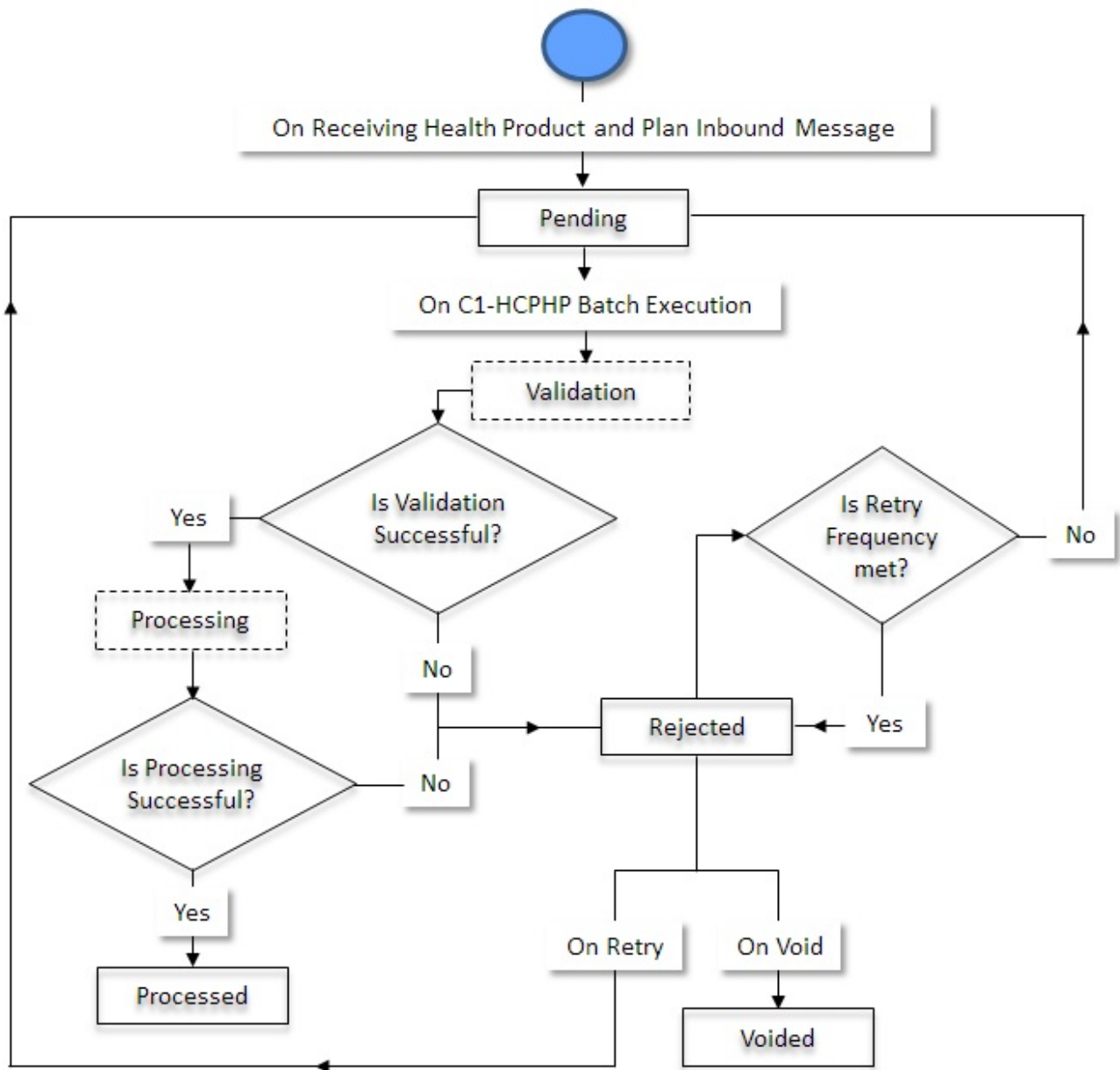

Algorithms Used in C1-HCProdHlthPlnInbound

The following table lists the algorithms which are used in the lifecycle of the **C1-HCProdHlthPlnInbound** business object:

Status	System Event	Algorithm	Algorithm Type	Description
Pending	Monitor	C1-AT-RQJ	C1-GEN-BOMNJ	Refer to C1-AT-RQJ on page 2090.
Validation	Monitor	F1-AT-RQJ	F1-GEN-BOMNJ	Refer to F1-AT-RQJ on page 1567.

Status	System Event	Algorithm	Algorithm Type	Description
	Enter	C1-HLTPRDVAL	C1-HLTPRDVAL	Refer to C1-HLTPRDVAL on page 2241
Processing	Monitor	F1-AT-RQJ	F1-GEN-BOMNJ	Refer to F1-AT-RQJ on page 1567.
	Enter	C1-HCPRPROC	C1-HCPRPROC	Refer to C1-HCPRPROC on page 2242
Rejected	Monitor	C1-TODORETRY	C1-TODORETRY	Refer to C1-TODORETRY on page 2091.
	Enter	C1-TDCRINMSG	F1-TDCREATE	Refer to C1-TDCRINMSG on page 2092.
Processed	-	-	-	-
Voided	-	-	-	-

C1-AT-RQJ

This algorithm is invoked when the status of the customer or membership inbound message is changed to **Pending**. If the **isRetried** flag in the inbound message is set to **true**, it resets the flag to **false**.

It contains the following parameters:

- **Next Status** – Used when you want to override the default next status specified in the lifecycle.
- **Next Transition Condition** – Used when you want to override the default next transition condition specified in the lifecycle.

Note: At a time, you can specify value for either the **Next Status** or **Next Transition Condition** parameter. If you don't specify any value for these parameters, the system will transition the business object to the default next status specified in its lifecycle.

F1-AT-RQJ

This algorithm transitions the current status of the business object to the specified status. It contains the following parameters:

- **Next Status** – Used when you want to override the default next status specified in the lifecycle.
- **Next Transition Condition** – Used when you want to override the default next transition condition specified in the lifecycle.

At a time, you can specify value for either the **Next Status** or **Next Transition Condition** parameter. If you don't specify any value for these parameters, the system will transition the business object to the default next status specified in its lifecycle.

C1-HLTPRDVAL

This algorithm is invoked when you execute the **Health Product Health Plan (C1-HCPHP)** periodic monitor batch or click the **Submit for Processing** button in the **Inbound Message** screen. This algorithm validates the Health Product and Plan Inbound Message, which is in the Pending status, to check the following conditions:

- Whether the specified **Inbound Message Type** and **Inbound Message Business Object** are valid.
- Whether the specified source system is valid and does exist in the **Source System Extendable Lookup (C1-SourceSystemLookup)**.

- Whether the mandatory data (such as health product code, description, product type, bundled product, start date, status) is specified in the health product.
- Whether the mandatory data (such as health plan code, description, health product, start date, status) is specified in the health plan.
- Whether the mandatory data (such as health plan code, charge, start date, pricing rule) is specified in the health plan pricing rules.
- Whether the specified data for the lookup columns matches with those mentioned in the system.
- Whether all of the switch columns either contain **Y** or **N** as values.
- Whether the specified end date for health product, health plan, and health pricing rule is greater than the start date.
- Whether the product is mapped to the division which exists in the system, and the product - division mapping is a one time process.
- Whether the product code is mapped with the health plan exists in the system.
- Whether the characteristic type mapped with the respective entity exists in the system.
- Whether the specified pricing rule type for creating the pricing rule exists in the system in the **Active** status, and the pricing rule type - health plan mapping is a one time process.
- Whether the specified price item and price item parameters for pricing rule eligibility are valid, and the price item parameters exist in the **CI_PRICE_PARM** table.
- Whether the price item parameters that have parameter usage specified as **Pricing Rule Eligibility Criteria** are available while defining the pricing rule eligibility for the pricing rule.
- Whether the entity type is specified as **Health Plan** and entity value as **Health Plan Code** while creating a pricing rule for a health plan.

Note:

This algorithm does not consider the following validations or checks:

- No validation is performed between the date range of the product and health plan.
- No check is performed whether the product is in the **Active** status while creating a health plan.
- No check is performed whether the health plan is in the **Active** status while creating the health plan pricing rules.
- No check is performed on the set of the pricing rule eligibility, which is defined on multiple pricing rules, for a price item.
- No validation is performed if duplicate parameters are defined for a pricing rule.

C1-HCPRPROC

This algorithm is invoked when the health product and plan inbound message is successfully validated. This algorithm creates or updates the health product, health plan, and health plan pricing rule information for individual memberships.

This algorithm fetches the business object from the health product and plan inbound message type to create or update the records for health product, health plan, and health plan pricing rule. The algorithm performs the following operations:

- Creates or updates the health product based on the health product code.
- Creates or updates the health plan based on the health plan code.
- Creates or updates the health plan pricing rules based on the price item, health plan, start date, and eligibility criteria.

Note:

The pricing rule eligibility is optional while creating or updating the pricing rules for the health plan.

The health product and plan inbound message log maintains complete trail of actions performed on health product, health plan, and health plan pricing rules.

C1-TODORETRY

This algorithm is invoked when the status of the customer or membership inbound message is changed to **Rejected**. It checks whether the maximum retry attempts are met. If the retry attempt is less than or equal to the value defined in the **Maximum Retry** parameter, the status of the inbound message is changed to **Pending**. However, if the retry attempt is greater than the value defined in the **Maximum Retry** parameter, the status of the inbound message remains as **Rejected**.

Note: This algorithm is invoked when the customer or membership inbound message is validated and processed through the batch process.

It contains the following parameters:

- **Maximum Retry** – Used to specify the maximum number of times the inbound message can be revalidated and reprocessed on failure.
- **Maximum Retry Element Name** – This parameter is not used at the moment.

If you do not specify any value for the **Maximum Retry** parameter, the system uses the value defined in the **To Do Maximum Retries** status option (which is defined in the lifecycle of the **C1-CustomerInboundMessage** and **C1-MemberInboundMessage** business object) to check whether the maximum retry attempts are met. If the value is not specified for the **To Do Maximum Retries** status option, the system does not allow revalidating and reprocessing an inbound message, and the status of the inbound message remains as **Rejected**.

C1-TDCRINMSG

This algorithm is invoked when the status of the customer or membership inbound message is changed to **Rejected**. It creates a To Do using the specified To Do type and assigns it to users with the specified To Do role.

It contains the following parameters:

- **To Do Type** - Used to specify the type of notification that you want to generate when the inbound message validation or processing fails.
- **To Do Role** - Used to specify the To Do role to indicate the users to whom you want to send the notification when the inbound message validation or processing fails.

The rest of the parameters, such as **To Do Type Element Name**, **To Do Role Element Name**, **Message Category**, **Message Number**, **Characteristic Type For Log Entry**, **To Do Sort Keys Retriever Script**, **Discard Cancel Terminate Reason Element**, **Discard Cancel Terminate Reason**, **Retry Frequency**, and **Retry Frequency Element Name**, are not used at the moment.

Health Product and Plan Inbound Message XML Format

Note: We recommend you to refer the Health Product and Plan Inbound Message schema in parallel while understanding the below mentioned tags. This will help you to understand how the tags are nested in the schema.

Before calling the **C1-HCProdHlthPlnInboundMessage** inbound web service, you need to ensure that the health product and plan inbound message contains the following tags:

Tag Name	Tag Description	Mandatory (Yes or No)						
schema	Used to specify the tags of a health product and plan inbound message.	Yes						
messageType	Used to indicate the health product and plan inbound message type using which the health product and plan inbound message should be created in the system. Note: You must specify a valid health product and plan inbound message type which is created using the C1-HCProdHlthPlnInboundTyp business object and which is in the Active status. The system then derives the business objects using which the health product and plan inbound message, health products, and health plans should be created from the health product and plan inbound message type.	Yes						
sourceSystem	Used to indicate the external system from where the health product and plan inbound message is received. Note: You must specify a source system which is already defined in the C1-SourceSystemLookup extendable lookup. It must be in the Active status.	Yes						
externalTransactionId	Used to indicate the transaction in the external source system which resulted in the health product and plan inbound message.	No						
externalBatchId	Used to indicate the external batch job or batch run number through which the health product and plan inbound message is created.	Yes						
externalSourceId	Used to specify the external source system ID.	Yes						
characteristics	You can use this tag within the following tags: <table border="1" data-bbox="462 1203 1182 1482"> <thead> <tr> <th>If this tag is used within...</th> <th>Then the purpose of the characteristics tag is...</th> </tr> </thead> <tbody> <tr> <td>schema</td> <td>Used to specify a list of characteristics for the health product and plan inbound message.</td> </tr> <tr> <td>healthPlanPricingRuleId</td> <td>Used to specify a list of characteristics for the pricing rule of a health plan.</td> </tr> </tbody> </table>	If this tag is used within...	Then the purpose of the characteristics tag is...	schema	Used to specify a list of characteristics for the health product and plan inbound message.	healthPlanPricingRuleId	Used to specify a list of characteristics for the pricing rule of a health plan.	No
If this tag is used within...	Then the purpose of the characteristics tag is...							
schema	Used to specify a list of characteristics for the health product and plan inbound message.							
healthPlanPricingRuleId	Used to specify a list of characteristics for the pricing rule of a health plan.							
inboundMessageCharacteristic	Used to specify a characteristic for the health product and plan inbound message.	No						
adhocCharacteristicValue	Used to specify the value for the adhoc characteristic type. Note: This data is required while defining or editing an adhoc characteristic of the health product and plan inbound message.	Yes (Conditional)						

Tag Name	Tag Description	Mandatory (Yes or No)										
characteristicType	<p>You can use this tag within the following tags:</p> <table border="1" data-bbox="461 302 1182 968"> <thead> <tr> <th data-bbox="461 302 732 386">If this tag is used within...</th> <th data-bbox="732 302 1182 386">Then the purpose of the characteristicType tag is...</th> </tr> </thead> <tbody> <tr> <td data-bbox="461 386 732 533">inboundMessageCharacteristics</td> <td data-bbox="732 386 1182 533">Used to specify the characteristic type. Here, you must specify a characteristic type where the characteristic entity is set to Inbound Message.</td> </tr> <tr> <td data-bbox="461 533 732 680">productCharacteristics</td> <td data-bbox="732 533 1182 680">Used to specify the characteristic type. Here, you must specify a characteristic type where the characteristic entity is set to Product.</td> </tr> <tr> <td data-bbox="461 680 732 827">healthPlanCharacteristics</td> <td data-bbox="732 680 1182 827">Used to specify the characteristic type. Here, you must specify a characteristic type where the characteristic entity is set to Health Plan.</td> </tr> <tr> <td data-bbox="461 827 732 968">characteristicsList</td> <td data-bbox="732 827 1182 968">Used to specify the characteristic type. Here, you must specify a characteristic type where the characteristic entity is set to Pricing Rule.</td> </tr> </tbody> </table>	If this tag is used within...	Then the purpose of the characteristicType tag is...	inboundMessageCharacteristics	Used to specify the characteristic type. Here, you must specify a characteristic type where the characteristic entity is set to Inbound Message .	productCharacteristics	Used to specify the characteristic type. Here, you must specify a characteristic type where the characteristic entity is set to Product .	healthPlanCharacteristics	Used to specify the characteristic type. Here, you must specify a characteristic type where the characteristic entity is set to Health Plan .	characteristicsList	Used to specify the characteristic type. Here, you must specify a characteristic type where the characteristic entity is set to Pricing Rule .	<p>Yes (Conditional)</p> <p>Note: This data is required while defining or editing a characteristic of the respective entity.</p>
If this tag is used within...	Then the purpose of the characteristicType tag is...											
inboundMessageCharacteristics	Used to specify the characteristic type. Here, you must specify a characteristic type where the characteristic entity is set to Inbound Message .											
productCharacteristics	Used to specify the characteristic type. Here, you must specify a characteristic type where the characteristic entity is set to Product .											
healthPlanCharacteristics	Used to specify the characteristic type. Here, you must specify a characteristic type where the characteristic entity is set to Health Plan .											
characteristicsList	Used to specify the characteristic type. Here, you must specify a characteristic type where the characteristic entity is set to Pricing Rule .											
effectiveDate	<p>You can use this tag within the following tags:</p> <table border="1" data-bbox="461 1058 1182 1598"> <thead> <tr> <th data-bbox="461 1058 732 1142">If this tag is used within...</th> <th data-bbox="732 1058 1182 1142">Then the purpose of the effectiveDate tag is...</th> </tr> </thead> <tbody> <tr> <td data-bbox="461 1142 732 1247">inboundMessageCharacteristics</td> <td data-bbox="732 1142 1182 1247">Used to specify the date from when the characteristic is effective for the health product and plan inbound message.</td> </tr> <tr> <td data-bbox="461 1247 732 1373">productCharacteristics</td> <td data-bbox="732 1247 1182 1373">Used to specify the date from when the characteristic is effective for the health product.</td> </tr> <tr> <td data-bbox="461 1373 732 1499">healthPlanCharacteristics</td> <td data-bbox="732 1373 1182 1499">Used to specify the date from when the characteristic is effective for the health plan.</td> </tr> <tr> <td data-bbox="461 1499 732 1598">characteristicsList</td> <td data-bbox="732 1499 1182 1598">Used to specify the date from when the characteristic is effective for the pricing rule of a health plan.</td> </tr> </tbody> </table> <p>Note: You must specify the date in the YYYY-MM-DD format.</p>	If this tag is used within...	Then the purpose of the effectiveDate tag is...	inboundMessageCharacteristics	Used to specify the date from when the characteristic is effective for the health product and plan inbound message.	productCharacteristics	Used to specify the date from when the characteristic is effective for the health product.	healthPlanCharacteristics	Used to specify the date from when the characteristic is effective for the health plan.	characteristicsList	Used to specify the date from when the characteristic is effective for the pricing rule of a health plan.	<p>Yes (Conditional)</p> <p>Note: This data is required while defining or editing a characteristic of the respective entity.</p>
If this tag is used within...	Then the purpose of the effectiveDate tag is...											
inboundMessageCharacteristics	Used to specify the date from when the characteristic is effective for the health product and plan inbound message.											
productCharacteristics	Used to specify the date from when the characteristic is effective for the health product.											
healthPlanCharacteristics	Used to specify the date from when the characteristic is effective for the health plan.											
characteristicsList	Used to specify the date from when the characteristic is effective for the pricing rule of a health plan.											

Tag Name	Tag Description	Mandatory (Yes or No)										
characteristicValue	You can use this tag within the following tags:	Yes (Conditional)										
	<table border="1"> <thead> <tr> <th>If this tag is used within...</th> <th>Then the purpose of the characteristicValue tag is...</th> </tr> </thead> <tbody> <tr> <td>inboundMessageCharacteristics</td> <td>Used to specify the value for the predefined characteristic type.</td> </tr> <tr> <td>productCharacteristics</td> <td>Used to specify the value for the characteristic type.</td> </tr> <tr> <td>healthPlanCharacteristics</td> <td>Used to specify the value for the characteristic type.</td> </tr> <tr> <td>characteristicsList</td> <td>Used to specify the value for the characteristic type.</td> </tr> </tbody> </table>	If this tag is used within...	Then the purpose of the characteristicValue tag is...	inboundMessageCharacteristics	Used to specify the value for the predefined characteristic type.	productCharacteristics	Used to specify the value for the characteristic type.	healthPlanCharacteristics	Used to specify the value for the characteristic type.	characteristicsList	Used to specify the value for the characteristic type.	Note: This data is required while defining or editing a characteristic of the respective entity.
	If this tag is used within...	Then the purpose of the characteristicValue tag is...										
	inboundMessageCharacteristics	Used to specify the value for the predefined characteristic type.										
	productCharacteristics	Used to specify the value for the characteristic type.										
healthPlanCharacteristics	Used to specify the value for the characteristic type.											
characteristicsList	Used to specify the value for the characteristic type.											
characteristicValueForeignKey1	Used to specify the first value for the foreign key characteristic type.	Yes (Conditional)										
		Note: This data is required while defining or editing a foreign key characteristic of the health product and plan inbound message.										
characteristicValueForeignKey2	Used to specify the second value for the foreign key characteristic type.	No										
characteristicValueForeignKey3	Used to specify the third value for the foreign key characteristic type.	No										
characteristicValueForeignKey4	Used to specify the fourth value for the foreign key characteristic type.	No										
characteristicValueForeignKey5	Used to specify the fifth value for the foreign key characteristic type.	No										
productHealthPlanMessage	Used to specify the details of a health product, health plan, or pricing rule for a health plan.	Yes										
HealthProductData	Used to specify the details of a health product.	Yes (Conditional)										
		Note: This data is required while defining or editing a health product.										

Tag Name	Tag Description	Mandatory (Yes or No)						
healthProductCode	<p>You can use this tag within the following tags:</p> <table border="1"> <thead> <tr> <th>If this tag is used within...</th> <th>Then the purpose of the healthProductCode tag is...</th> </tr> </thead> <tbody> <tr> <td>HealthProductData</td> <td>Used to specify the unique identifier for the health product.</td> </tr> <tr> <td>healthPlanData</td> <td>Used to indicate the health product for which you want to define the health plan.</td> </tr> </tbody> </table>	If this tag is used within...	Then the purpose of the healthProductCode tag is...	HealthProductData	Used to specify the unique identifier for the health product.	healthPlanData	Used to indicate the health product for which you want to define the health plan.	Yes
If this tag is used within...	Then the purpose of the healthProductCode tag is...							
HealthProductData	Used to specify the unique identifier for the health product.							
healthPlanData	Used to indicate the health product for which you want to define the health plan.							
description	<p>You can use this tag within the following tags:</p> <table border="1"> <thead> <tr> <th>If this tag is used within...</th> <th>Then the purpose of the description tag is...</th> </tr> </thead> <tbody> <tr> <td>HealthProductData</td> <td>Used to specify the description for the health product.</td> </tr> <tr> <td>healthPlanData</td> <td>Used to specify the description for the health plan.</td> </tr> </tbody> </table>	If this tag is used within...	Then the purpose of the description tag is...	HealthProductData	Used to specify the description for the health product.	healthPlanData	Used to specify the description for the health plan.	Yes
If this tag is used within...	Then the purpose of the description tag is...							
HealthProductData	Used to specify the description for the health product.							
healthPlanData	Used to specify the description for the health plan.							
productType	<p>Used to indicate how the health product can be classified based on the provider network.</p> <p>Note: You must specify a value which is already defined in the PRODUCT_TYPE_FLG lookup field. It must be in the Active status.</p>	Yes						
productSubType	<p>Used to indicate the type of medical accounts that are linked to the health product.</p> <p>Note: You must specify a value which is already defined in the PRODUCT_SUB_TYPE_FLG lookup field. It must be in the Active status.</p>	No						
productHCCategory	<p>Used to indicate the health care category to which the health product belongs.</p> <p>Note: You must specify a value which is already defined in the PRODUCT_CATEGORY_FLG lookup field. It must be in the Active status.</p>	No						
productAdministration	Used to specify the name of the agency which administers the health product.	No						
productLOB	<p>Used to indicate the line of business to which the health product belongs.</p> <p>Note: You must specify a value which is already defined in the PRODUCT_LOB_FLG lookup field. It must be in the Active status.</p>	No						

Tag Name	Tag Description	Mandatory (Yes or No)
productLOBCategory	<p>Used to indicate the line of business category to which the health product belongs.</p> <p>Note: You must specify a value which is already defined in the PRODUCT_LOB_CAT_FLG lookup field. It must be in the Active status.</p>	No
bundledProduct	<p>Used to indicate whether the health product is a bundled product. The valid values are:</p> <ul style="list-style-type: none"> • Y • N 	Yes
bundledProducts	Used to specify the health products which are included in the bundled product.	<p>Yes (Conditional)</p> <p>Note: This data is required when the health product is a bundled product (i.e. when the bundledProduct tag contains Y).</p>

Tag Name	Tag Description	Mandatory (Yes or No)								
startDate	<p>You can use this tag within the following tags:</p> <table border="1" data-bbox="464 302 1182 1310"> <thead> <tr> <th data-bbox="464 302 678 386">If this tag is used within...</th> <th data-bbox="678 302 1182 386">Then the purpose of the startDate tag is...</th> </tr> </thead> <tbody> <tr> <td data-bbox="464 386 678 575">HealthProductData</td> <td data-bbox="678 386 1182 575"> <p>Used to specify the date from when the health product is effective.</p> <p>Note: The health product start date cannot be later than the health product end date.</p> </td> </tr> <tr> <td data-bbox="464 575 678 940">healthPlanData</td> <td data-bbox="678 575 1182 940"> <p>Used to specify the date from when the health plan is effective.</p> <p>Note:</p> <p>The health plan start date cannot be later than the health plan end date.</p> <p>The health plan start date cannot be earlier than the health product start date and later than the health product end date.</p> </td> </tr> <tr> <td data-bbox="464 940 678 1310">healthPlanPricingRuleData</td> <td data-bbox="678 940 1182 1310"> <p>Used to specify the date from when the pricing rule of a health plan is effective.</p> <p>Note:</p> <p>The pricing rule start date cannot be later than the pricing rule end date.</p> <p>The pricing rule start date cannot be earlier than the health plan start date and later than the health plan end date.</p> </td> </tr> </tbody> </table> <p>Note: You must specify the date in the YYYY-MM-DD format.</p>	If this tag is used within...	Then the purpose of the startDate tag is...	HealthProductData	<p>Used to specify the date from when the health product is effective.</p> <p>Note: The health product start date cannot be later than the health product end date.</p>	healthPlanData	<p>Used to specify the date from when the health plan is effective.</p> <p>Note:</p> <p>The health plan start date cannot be later than the health plan end date.</p> <p>The health plan start date cannot be earlier than the health product start date and later than the health product end date.</p>	healthPlanPricingRuleData	<p>Used to specify the date from when the pricing rule of a health plan is effective.</p> <p>Note:</p> <p>The pricing rule start date cannot be later than the pricing rule end date.</p> <p>The pricing rule start date cannot be earlier than the health plan start date and later than the health plan end date.</p>	Yes
If this tag is used within...	Then the purpose of the startDate tag is...									
HealthProductData	<p>Used to specify the date from when the health product is effective.</p> <p>Note: The health product start date cannot be later than the health product end date.</p>									
healthPlanData	<p>Used to specify the date from when the health plan is effective.</p> <p>Note:</p> <p>The health plan start date cannot be later than the health plan end date.</p> <p>The health plan start date cannot be earlier than the health product start date and later than the health product end date.</p>									
healthPlanPricingRuleData	<p>Used to specify the date from when the pricing rule of a health plan is effective.</p> <p>Note:</p> <p>The pricing rule start date cannot be later than the pricing rule end date.</p> <p>The pricing rule start date cannot be earlier than the health plan start date and later than the health plan end date.</p>									

Tag Name	Tag Description	Mandatory (Yes or No)								
endDate	<p>You can use this tag within the following tags:</p> <table border="1" data-bbox="462 302 1182 1310"> <thead> <tr> <th data-bbox="462 302 678 386">If this tag is used within...</th> <th data-bbox="678 302 1182 386">Then the purpose of the endDate tag is...</th> </tr> </thead> <tbody> <tr> <td data-bbox="462 386 678 575">HealthProductData</td> <td data-bbox="678 386 1182 575"> <p>Used to specify the date till when the health product is effective.</p> <p>Note: The health product end date cannot be earlier than the health product start date.</p> </td> </tr> <tr> <td data-bbox="462 575 678 940">healthPlanData</td> <td data-bbox="678 575 1182 940"> <p>Used to specify the date till when the health plan is effective.</p> <p>Note:</p> <p>The health plan end date cannot be earlier than the health plan start date.</p> <p>The health plan end date cannot be earlier than the health product start date and later than the health product end date.</p> </td> </tr> <tr> <td data-bbox="462 940 678 1310">healthPlanPricingRuleData</td> <td data-bbox="678 940 1182 1310"> <p>Used to specify the date till when the pricing rule of a health plan is effective.</p> <p>Note:</p> <p>The pricing rule end date cannot be earlier than the pricing rule start date.</p> <p>The pricing rule end date cannot be earlier than the health plan start date and later than the health plan end date.</p> </td> </tr> </tbody> </table> <p>Note: You must specify the date in the YYYY-MM-DD format.</p>	If this tag is used within...	Then the purpose of the endDate tag is...	HealthProductData	<p>Used to specify the date till when the health product is effective.</p> <p>Note: The health product end date cannot be earlier than the health product start date.</p>	healthPlanData	<p>Used to specify the date till when the health plan is effective.</p> <p>Note:</p> <p>The health plan end date cannot be earlier than the health plan start date.</p> <p>The health plan end date cannot be earlier than the health product start date and later than the health product end date.</p>	healthPlanPricingRuleData	<p>Used to specify the date till when the pricing rule of a health plan is effective.</p> <p>Note:</p> <p>The pricing rule end date cannot be earlier than the pricing rule start date.</p> <p>The pricing rule end date cannot be earlier than the health plan start date and later than the health plan end date.</p>	No
If this tag is used within...	Then the purpose of the endDate tag is...									
HealthProductData	<p>Used to specify the date till when the health product is effective.</p> <p>Note: The health product end date cannot be earlier than the health product start date.</p>									
healthPlanData	<p>Used to specify the date till when the health plan is effective.</p> <p>Note:</p> <p>The health plan end date cannot be earlier than the health plan start date.</p> <p>The health plan end date cannot be earlier than the health product start date and later than the health product end date.</p>									
healthPlanPricingRuleData	<p>Used to specify the date till when the pricing rule of a health plan is effective.</p> <p>Note:</p> <p>The pricing rule end date cannot be earlier than the pricing rule start date.</p> <p>The pricing rule end date cannot be earlier than the health plan start date and later than the health plan end date.</p>									

Tag Name	Tag Description	Mandatory (Yes or No)								
status	<p>You can use this tag within the following tags:</p> <table border="1" data-bbox="461 302 1182 989"> <thead> <tr> <th data-bbox="461 302 680 386">If this tag is used within...</th> <th data-bbox="680 302 1182 386">Then the purpose of the status tag is...</th> </tr> </thead> <tbody> <tr> <td data-bbox="461 386 680 569">HealthProductData</td> <td data-bbox="680 386 1182 569"> Used to indicate the status of the health product. The valid values are: <ul style="list-style-type: none"> • ACTIVE • INACTIVE </td> </tr> <tr> <td data-bbox="461 569 680 751">healthPlanData</td> <td data-bbox="680 569 1182 751"> Used to indicate the status of the health plan. The valid values are: <ul style="list-style-type: none"> • ACTIVE • INACTIVE </td> </tr> <tr> <td data-bbox="461 751 680 989">healthPlanPricingRuleData</td> <td data-bbox="680 751 1182 989"> Used to indicate the status of the pricing rule. The valid values are: <ul style="list-style-type: none"> • PENDING • ACTIVE • INACTIVE </td> </tr> </tbody> </table>	If this tag is used within...	Then the purpose of the status tag is...	HealthProductData	Used to indicate the status of the health product. The valid values are: <ul style="list-style-type: none"> • ACTIVE • INACTIVE 	healthPlanData	Used to indicate the status of the health plan. The valid values are: <ul style="list-style-type: none"> • ACTIVE • INACTIVE 	healthPlanPricingRuleData	Used to indicate the status of the pricing rule. The valid values are: <ul style="list-style-type: none"> • PENDING • ACTIVE • INACTIVE 	Yes
If this tag is used within...	Then the purpose of the status tag is...									
HealthProductData	Used to indicate the status of the health product. The valid values are: <ul style="list-style-type: none"> • ACTIVE • INACTIVE 									
healthPlanData	Used to indicate the status of the health plan. The valid values are: <ul style="list-style-type: none"> • ACTIVE • INACTIVE 									
healthPlanPricingRuleData	Used to indicate the status of the pricing rule. The valid values are: <ul style="list-style-type: none"> • PENDING • ACTIVE • INACTIVE 									
productCharacteristics	Used to specify a list of characteristics for the health product.	No								
healthProductDivision	Used to specify a list of divisions where the health product is available.	Yes (Conditional) <table border="1" data-bbox="1198 1121 1469 1272"> <tr> <td data-bbox="1198 1121 1469 1272"> Note: This data is required while associating a health product with a division. </td> </tr> </table>	Note: This data is required while associating a health product with a division.							
Note: This data is required while associating a health product with a division.										
division	Used to indicate the division where the health product is available. <table border="1" data-bbox="456 1346 1190 1556"> <tr> <td data-bbox="456 1346 1190 1556"> Note: If you associate the health product with a division, the system only allows the persons belonging to the division to enroll for different health plans of the health product. However, if you do not associate the health product to any division, the system allows the persons belonging to different divisions to enroll for different health plans of the health product. </td> </tr> </table>	Note: If you associate the health product with a division, the system only allows the persons belonging to the division to enroll for different health plans of the health product. However, if you do not associate the health product to any division, the system allows the persons belonging to different divisions to enroll for different health plans of the health product.	Yes							
Note: If you associate the health product with a division, the system only allows the persons belonging to the division to enroll for different health plans of the health product. However, if you do not associate the health product to any division, the system allows the persons belonging to different divisions to enroll for different health plans of the health product.										
healthPlanData	Used to specify the details of the health plan.	Yes (Conditional) <table border="1" data-bbox="1198 1629 1469 1745"> <tr> <td data-bbox="1198 1629 1469 1745"> Note: This data is required while defining or editing a health plan. </td> </tr> </table>	Note: This data is required while defining or editing a health plan.							
Note: This data is required while defining or editing a health plan.										
healthPlanCode	Used to specify the unique identifier for the health plan.	Yes								

Tag Name	Tag Description	Mandatory (Yes or No)
charitablePlan	<p>Used to indicate whether the health plan provides subsidized health insurance coverage. The valid values are:</p> <ul style="list-style-type: none"> • Y • N <p>Note: If you do not specify the value, by default, it is set to N.</p>	No
standardPlan	<p>Used to indicate whether the health plan provides standard health insurance coverage. The valid values are:</p> <ul style="list-style-type: none"> • Y • N <p>Note: If you do not specify the value, by default, it is set to N.</p>	No
acaQhp	<p>Used to indicate whether the health plan provides Affordable Care Act (ACA) qualified health insurance coverage. The valid values are:</p> <ul style="list-style-type: none"> • Y • N <p>Note: If you do not specify the value, by default, it is set to N.</p>	No
grandFatherPlan	<p>Used to indicate whether the health plan is a grandfathered health plan. The valid values are:</p> <ul style="list-style-type: none"> • Y • N <p>Note: A grandfathered health plans are those individual health insurance plans which are purchased on or before March 23, 2010. If you do not specify the value, by default, it is set to N.</p>	No
ancillaryBenefits	<p>Used to indicate whether the health plan provides ancillary benefits. The valid values are:</p> <ul style="list-style-type: none"> • Y • N <p>Note: Ancillary benefits are a secondary type of health insurance coverage that covers miscellaneous medical expenses that are incurred during a stay at the hospital. For example, it can cover expenses such as ambulance transportation, blood, drugs, and medical supplies like bandages. If you do not specify the value, by default, it is set to N.</p>	No

Tag Name	Tag Description	Mandatory (Yes or No)						
riderBenefits	<p>Used to indicate whether the health plan provides rider benefits. The valid values are:</p> <ul style="list-style-type: none"> • Y • N <p>Note:</p> <p>A rider is an additional benefit that can be included to the basic health insurance plan. By adding riders, the insurance coverage can be expanded as per the requirement and at a lower cost.</p> <p>If you do not specify the value, by default, it is set to N.</p>	No						
addOnPlan	<p>Used to indicate whether the health plan is an add-on health plan. The valid values are:</p> <ul style="list-style-type: none"> • Y • N <p>Note:</p> <p>If you do not specify the value, by default, it is set to N.</p> <p>An add-on health plan may provide ancillary or rider benefits. It is also known as a supplemental health plan. As these add-on plans provide additional benefits over the base plan, they are not considered as the standalone plan.</p>	No						
healthPlanCharacteristics	Used to specify a list of characteristics for the health plan.	No						
healthPlanPricingRuleTypes	Used to associate a list of pricing rule types with the health plan.	Yes (Conditional) <p>Note: This data is required while associating a pricing rule type with the health plan.</p>						
pricingRuleType	<p>You can use this tag within the following tags:</p> <table border="1"> <thead> <tr> <th>If this tag is used within...</th> <th>Then the purpose of the pricingRuleType tag is...</th> </tr> </thead> <tbody> <tr> <td>healthPlanPricingRuleTypes</td> <td>Used to specify the pricing rule type.</td> </tr> <tr> <td>healthPlanPricingRuleDetails</td> <td>Used to indicate the pricing rule type using which you want to define the pricing rule.</td> </tr> </tbody> </table> <p>Note: At present, you can only specify those pricing rule types where the category is set to Age Based, Tier Based, Discount Charge, Additional Charge, and Benefit.</p>	If this tag is used within...	Then the purpose of the pricingRuleType tag is...	healthPlanPricingRuleTypes	Used to specify the pricing rule type.	healthPlanPricingRuleDetails	Used to indicate the pricing rule type using which you want to define the pricing rule.	Yes (Conditional) <p>Note: This data is required while associating a pricing rule type with the health plan and while defining or editing a pricing rule of a health plan.</p>
If this tag is used within...	Then the purpose of the pricingRuleType tag is...							
healthPlanPricingRuleTypes	Used to specify the pricing rule type.							
healthPlanPricingRuleDetails	Used to indicate the pricing rule type using which you want to define the pricing rule.							

Tag Name	Tag Description	Mandatory (Yes or No)												
healthPlanPricingRuleData	Used to specify the details of the pricing rule.	Yes (Conditional) Note: This data is required while defining or editing a pricing rule of the health plan.												
sequence	<p>You can use this tag within the following tags:</p> <table border="1"> <thead> <tr> <th>If this tag is used within...</th> <th>Then the purpose of the sequence tag is...</th> </tr> </thead> <tbody> <tr> <td>healthPlanPricingRuleData</td> <td>Used to indicate the order in which the pricing rules should be created in the system.</td> </tr> <tr> <td>baseRate</td> <td>Used to indicate the order in which the base fee should be displayed for a set of pricing parameters in the user interface.</td> </tr> <tr> <td>pricingParameter</td> <td>Used to indicate the order in which the pricing parameter should be displayed in the user interface.</td> </tr> <tr> <td>modifierInformation</td> <td>Used to indicate the order in which the modifier should be displayed in the user interface.</td> </tr> <tr> <td>pricingRuleEligibility</td> <td>Used to indicate the order in which the pricing rule eligibility parameter should be displayed in the user interface.</td> </tr> </tbody> </table>	If this tag is used within...	Then the purpose of the sequence tag is...	healthPlanPricingRuleData	Used to indicate the order in which the pricing rules should be created in the system.	baseRate	Used to indicate the order in which the base fee should be displayed for a set of pricing parameters in the user interface.	pricingParameter	Used to indicate the order in which the pricing parameter should be displayed in the user interface.	modifierInformation	Used to indicate the order in which the modifier should be displayed in the user interface.	pricingRuleEligibility	Used to indicate the order in which the pricing rule eligibility parameter should be displayed in the user interface.	Yes (Conditional) Note: This data is required while defining or editing the respective information.
If this tag is used within...	Then the purpose of the sequence tag is...													
healthPlanPricingRuleData	Used to indicate the order in which the pricing rules should be created in the system.													
baseRate	Used to indicate the order in which the base fee should be displayed for a set of pricing parameters in the user interface.													
pricingParameter	Used to indicate the order in which the pricing parameter should be displayed in the user interface.													
modifierInformation	Used to indicate the order in which the modifier should be displayed in the user interface.													
pricingRuleEligibility	Used to indicate the order in which the pricing rule eligibility parameter should be displayed in the user interface.													
entityIdentifiers	Used to specify a list of entities (i.e. health plans) for which you want to define the pricing rule.	Yes												
entityIdentifiersList	Used to indicate the entity for which you want to define the pricing rule.	Yes												
entityIdentifierType	<p>Used to indicate the type of entity. The valid values are:</p> <ul style="list-style-type: none"> HLPN - Indicates that you want to define the pricing rule for a health plan. <p>Note: At present, you can only define the pricing rules for the health plans of the fully-insured individual business.</p>	Yes (Conditional) Note: This data is required while defining or editing a pricing rule defined for the health plan.												
entityIdentifierValue	Used to specify the entity identifier (i.e. plan number, policy number, or source system).	Yes (Conditional) Note: This data is required while defining or editing a pricing rule defined for the health plan.												

Tag Name	Tag Description	Mandatory (Yes or No)
priceItemCd	Used to indicate the price item for which you want to define the pricing rule.	Yes (Conditional)
	<p>Note: You must specify a price item which is already associated with the respective pricing rule type.</p>	<p>Note: This data is required while defining or editing a pricing rule defined for the health plan.</p>
rateOption	<p>Used to indicate the rate option using which you want to create price assignment for the pricing rule of a health plan.</p> <p>Note:</p> <p>You must specify a rate option which is already defined in the C1-ExtLookRetTypeRateOpt extendable lookup. It must be in the Active status.</p> <p>If the rate option is not given for an age-based pricing rule, by default, it is set to:</p> <ul style="list-style-type: none"> • The value specified in the Default Rate Option – Flat option type of the C1-ASOBLNG feature configuration when the modifier method is set to FLAT • The value specified in the Default Rate Option – Percentage option type of the C1-ASOBLNG feature configuration when the modifier method is set to EXPT or INPT <p>However, if the rate option is not given for a tier-based pricing rule, by default, it is set to a value specified in the Default Rate Option – Flat option type of the C1-ASOBLNG feature configuration when the modifier method is set to FLAT or NULL.</p>	No
pricingType	<p>Used to indicate the type of pricing defined for the pricing rule. The valid values are:</p> <ul style="list-style-type: none"> • Flat • Percentage 	Yes
modifierApplicability	<p>Used to indicate whether you want to increase or decrease the premium of an eligible member based on certain modifiers (i.e. parameters, such as tobacco usage, alcohol usage, and so on). The valid values are:</p> <ul style="list-style-type: none"> • Y • N 	No
	<p>Note: If you do not specify the value, by default, it is set to N.</p>	

Tag Name	Tag Description	Mandatory (Yes or No)
modifierMethod	<p>Used to indicate whether the system should consider the modifier rate as a flat amount or percentage. The valid values are:</p> <ul style="list-style-type: none"> • FLAT - Indicates that the system should consider the modifier rate as a flat amount. • INPT - Indicates that the system should consider the modifier rate as inclusive percentage. • EXPT - Indicates that the system should consider the modifier rate as exclusive percentage. 	<p>Yes (Conditional)</p> <p>Note: This data is required when the modifierApplicability tag contains Y.</p>
baseRate	<p>Used to specify the base fees for employees with a particular set of attributes. You can define different base fees for employees with different set of attributes.</p> <p>Note: While creating a price assignment for the pricing rule, the system creates one price component for each given set of base rate information.</p>	<p>Yes (Conditional)</p> <p>Note: This data is required while defining a pricing rule for the health plan.</p>
baseFee	<p>Used to specify the base fees for the health plan.</p>	<p>Yes (Conditional)</p> <p>Note: This data is required while defining a pricing rule for the health plan.</p>
lowerAgeLimit	<p>Used to specify the lower age limit. It is used to define lower age limit pricing eligibility criteria in the price component.</p> <p>Note:</p> <p>The system defines the lower age limit pricing eligibility criteria using the parameter which is specified in the Age Based Parameter option type of the C1-ASOBLNG feature configuration.</p> <p>This data is ignored when given in a tier-based pricing rule information.</p>	<p>Yes (Conditional)</p> <p>Note: This data is required while defining or editing an age-based pricing rule for the health plan.</p>
upperAgeLimit	<p>Used to specify the upper age limit. It is used to define upper age limit pricing eligibility criteria in the price component.</p> <p>Note:</p> <p>The system defines the upper age limit pricing eligibility criteria using the parameter which is specified in the Age Based Parameter option type of the C1-ASOBLNG feature configuration.</p> <p>This data is ignored when given in a tier-based pricing rule information.</p>	<p>Yes (Conditional)</p> <p>Note: This data is required while defining an age-based pricing rule for the health plan.</p>

Tag Name	Tag Description	Mandatory (Yes or No)						
pricingParameter	Used to specify a set of employee attributes based on which the base fees may vary.	Yes (Conditional) Note: This data is required while defining a tier-based pricing rule for the health plan.						
parameterCode	You can use this tag within the following tags: <table border="1" data-bbox="461 527 1182 932"> <thead> <tr> <th data-bbox="461 527 699 611">If this tag is used within...</th> <th data-bbox="699 527 1182 611">Then the purpose of the parameterCode tag is...</th> </tr> </thead> <tbody> <tr> <td data-bbox="461 611 699 785">pricingParameter</td> <td data-bbox="699 611 1182 785">Used to specify the employee attribute (i.e. parameter, such as employee status, employee location, and so on) using which you want to define the pricing eligibility criteria.</td> </tr> <tr> <td data-bbox="461 785 699 932">modifier/information</td> <td data-bbox="699 785 1182 932">Used to specify the modifier (i.e. parameter, such as tobacco usage, alcohol usage, and so on) using which you want to define the pricing eligibility criteria.</td> </tr> </tbody> </table> <p data-bbox="461 957 1182 1276">Note: You must define the employee attributes and modifiers as parameters in the system. Note that you must set the parameter usage for these parameters to Pricing Eligibility Criteria. The system creates an pricing eligibility criteria for each parameter and/or modifier specified in the pricing rule information. You cannot specify any special character except underscore (_) in the parameter name.</p>	If this tag is used within...	Then the purpose of the parameterCode tag is...	pricingParameter	Used to specify the employee attribute (i.e. parameter, such as employee status, employee location, and so on) using which you want to define the pricing eligibility criteria.	modifier/information	Used to specify the modifier (i.e. parameter, such as tobacco usage, alcohol usage, and so on) using which you want to define the pricing eligibility criteria.	Yes (Conditional) Note: This data is required while specifying the respective information.
If this tag is used within...	Then the purpose of the parameterCode tag is...							
pricingParameter	Used to specify the employee attribute (i.e. parameter, such as employee status, employee location, and so on) using which you want to define the pricing eligibility criteria.							
modifier/information	Used to specify the modifier (i.e. parameter, such as tobacco usage, alcohol usage, and so on) using which you want to define the pricing eligibility criteria.							
parameterValue	You can use this tag within the following tags: <table border="1" data-bbox="461 1360 1182 1612"> <thead> <tr> <th data-bbox="461 1360 727 1444">If this tag is used within...</th> <th data-bbox="727 1360 1182 1444">Then the purpose of the parameterValue tag is...</th> </tr> </thead> <tbody> <tr> <td data-bbox="461 1444 727 1528">pricingParameter</td> <td data-bbox="727 1444 1182 1528">Used to specify the value for the parameter (i.e. employee attribute).</td> </tr> <tr> <td data-bbox="461 1528 727 1612">modifierInformation</td> <td data-bbox="727 1528 1182 1612">Used to specify the value for the parameter (i.e. modifier).</td> </tr> </tbody> </table> <p data-bbox="461 1638 1182 1738">Note: You can specify any special characters except ampersand (&), comma (,), underscore (_), equal to (=), tilde (~), and semi-colon(;) in the parameter value.</p>	If this tag is used within...	Then the purpose of the parameterValue tag is...	pricingParameter	Used to specify the value for the parameter (i.e. employee attribute).	modifierInformation	Used to specify the value for the parameter (i.e. modifier).	Yes (Conditional) Note: This data is required while specifying the respective information.
If this tag is used within...	Then the purpose of the parameterValue tag is...							
pricingParameter	Used to specify the value for the parameter (i.e. employee attribute).							
modifierInformation	Used to specify the value for the parameter (i.e. modifier).							

Tag Name	Tag Description	Mandatory (Yes or No)
modifierInformation	Used to specify the modifier based on which you want to increase or decrease the base fees.	Yes (Conditional)
	Note: While creating a price assignment for the pricing rule, the system creates one price component for each given set of modifier information and then links these modifier price components with the respective base rate price component.	Note: This data is required while specifying the modifier information.
rate	Used to specify the flat amount or percentage by which you want to increase or decrease the premium of an eligible member.	Yes (Conditional)
		Note: This data is required while specifying the modifier information.
characteristicsList		
pricingRuleEligibility	Used to specify a set of attributes based on which the pricing rule eligibility is decided.	Yes (Conditional)
		Note: This data is required while defining or editing an age or tier-based pricing rule for the health plan.
priceParmCode	Used to specify the pricing attribute using which you want to define the pricing eligibility criteria.	Yes (Conditional)
		Note: This data is required while specifying the respective information.
priceParmVal	Used to specify the value for the parameter (i.e. pricing attribute).	Yes (Conditional)
		Note: This data is required while specifying the respective information.

The following table lists and describes the tags which are available in the health care inbound message schema, but should not be included in the XML file:

Tag Name	Tag Description
c1InboundMessage	Displays the inbound message ID.
bo	Indicates the business object using which the health product and plan inbound message is created in the system.
boStatus	Displays the status of the health product and plan inbound message.
statusReason	Indicates the reason why the status of the health product and plan inbound message is changed.

Tag Name	Tag Description						
statusDateTime	Displays the date and time when the status of the health product and plan inbound message is changed in the system.						
creationDateTime	Displays the date and time when the health product and plan inbound message is created in the system.						
version	<p>This tag appears within the following parent tags:</p> <table border="1"> <thead> <tr> <th>Parent Tag</th> <th>Then the purpose of the version tag is...</th> </tr> </thead> <tbody> <tr> <td>schema</td> <td>Displays the version of the health product and plan inbound message.</td> </tr> <tr> <td>inboundMessageCharacteristic</td> <td>Displays the version of the characteristic defined for the health product and plan inbound message.</td> </tr> </tbody> </table>	Parent Tag	Then the purpose of the version tag is...	schema	Displays the version of the health product and plan inbound message.	inboundMessageCharacteristic	Displays the version of the characteristic defined for the health product and plan inbound message.
Parent Tag	Then the purpose of the version tag is...						
schema	Displays the version of the health product and plan inbound message.						
inboundMessageCharacteristic	Displays the version of the characteristic defined for the health product and plan inbound message.						
searchCharacteristicValue	At present, this tag is not supported in a health product and plan inbound message.						
toDoRetry	<p>Displays the information about the retry option used for the health product and plan inbound message.</p> <p>Note: This information appears at the bottom of the inbound message in the Inbound Message Content zone once the health product and plan inbound message is validated and processed either through the user interface or batch process.</p>						
retryDateTime	Displays the date and time when the retry option is used to change the status of the health product and plan inbound message from Rejected to Pending .						
numberOfRetries	Indicates the number of times the retry option is used for the health product and plan inbound message.						
currentErrorState	<p>Indicates the status to which the health care inbound message is transitioned when its validation or processing fails. The valid value is:</p> <ul style="list-style-type: none"> REJECTED 						
isRetried	<p>Indicates whether the retry option is used to change the status of the health product and plan inbound message. The valid values are:</p> <ul style="list-style-type: none"> true false 						

Related Topics

For more information on...	See...
Health Product and Plan Inbound Message Schema	Health Product and Plan Inbound Message Schema on page 2260
Sample Health Product and Plan Inbound Message for Health Product Setup	Sample Health Product and Plan Inbound Message for Health Product Setup on page 2262
Sample Health Care Inbound Message for Health Plan Setup	Sample Health Product and Plan Inbound Message for Health Plan Setup on page 2262
Sample Health Care Inbound Message for Health Plan Pricing Rules Setup	Sample Health Product and Plan Inbound Message for Health Plan Pricing Rules Setup on page 2264

For more information on...	See...
How to setup the C1-ASOBLLNG feature configuration	Setting the C1-ASOBLLNG Feature Configuration on page 3421

Health Product and Plan Inbound Message Schema

The following code snippet illustrates how the tags are nested in the Health Product and Plan Inbound Message schema:

```
<schema>
  <clInboundMessage></clInboundMessage>
  <bo></bo>
  <boStatus></boStatus>
  <statusReason></statusReason>
  <messageType></messageType>
  <sourceSystem></sourceSystem>
  <externalTransactionId></externalTransactionId>
  <externalBatchId></externalBatchId>
  <externalSourceId></externalSourceId>
  <statusDateTime></statusDateTime>
  <creationDateTime></creationDateTime>
  <version></version>
  <characteristics>
    <inboundMessageCharacteristic>
      <adhocCharacteristicValue></adhocCharacteristicValue>
      <characteristicType></characteristicType>
      <effectiveDate></effectiveDate>
      <characteristicValue></characteristicValue>
      <characteristicValueForeignKey1></characteristicValueForeignKey1>
      <characteristicValueFK2></characteristicValueFK2>
      <characteristicValueFK3></characteristicValueFK3>
      <characteristicValueFk4></characteristicValueFk4>
      <characteristicValueFK5></characteristicValueFK5>
      <searchCharacteristicValue></searchCharacteristicValue>
      <version></version>
    </inboundMessageCharacteristic>
  </characteristics>
  <productHealthPlanMessage>
    <HealthProductData>
      <healthProductCode></healthProductCode>
      <description></description>
      <productType></productType>
      <productSubType></productSubType>
      <productHCCategory></productHCCategory>
      <productAdministration></productAdministration>
      <productLOB></productLOB>
      <productLOBCategory></productLOBCategory>
      <bundledProduct></bundledProduct>
      <bundledProducts></bundledProducts>
      <startDate></startDate>
      <endDate></endDate>
      <status></status>
      <productCharacteristics>
        <characteristicType></characteristicType>
        <characteristicValue></characteristicValue>
        <effectiveDate></effectiveDate>
      </productCharacteristics>
      <healthProductDivision>
        <division></division>
      </healthProductDivision>
    </HealthProductData>
    <healthPlanData>
      <healthProductCode></healthProductCode>
```



```

<healthPlanCode></healthPlanCode>
<description></description>
<charitablePlan></charitablePlan>
<standardPlan></standardPlan>
<acaQhp></acaQhp>
<grandFatherPlan></grandFatherPlan>
<ancillaryBenefits></ancillaryBenefits>
<riderBenefits></riderBenefits>
<addOnPlan></addOnPlan>
<startDate></startDate>
<endDate></endDate>
<status></status>
<healthPlanCharacteristics>
  <characteristicType></characteristicType>
  <characteristicValue></characteristicValue>
  <effectiveDate></effectiveDate>
</healthPlanCharacteristics>
<healthPlanPricingRuleTypes>
  <pricingRuleType></pricingRuleType>
</healthPlanPricingRuleTypes>
</healthPlanData>
<healthPlanPricingRuleData>
  <sequence></sequence>
  <entityIdentifiers>
    <entityIdentifiersList>
      <entityIdentifierType></entityIdentifierType>
      <entityIdentifierValue></entityIdentifierValue>
    </entityIdentifiersList>
  </entityIdentifiers>
  <pricingRuleType></pricingRuleType>
  <priceItemCd></priceItemCd>
  <status></status>
  <startDate></startDate>
  <endDate></endDate>
  <rateOption></rateOption>
  <pricingType></pricingType>
  <modifierApplicability></modifierApplicability>
  <modifierMethod></modifierMethod>
  <baseRate>
    <sequence></sequence>
    <baseFee></baseFee>
    <lowerAgeLimit></lowerAgeLimit>
    <upperAgeLimit></upperAgeLimit>
    <pricingParameter>
      <sequence></sequence>
      <parameterCode></parameterCode>
      <parameterValue></parameterValue>
    </pricingParameter>
    <modifierInformation>
      <sequence></sequence>
      <parameterCode></parameterCode>
      <parameterValue></parameterValue>
      <rate></rate>
    </modifierInformation>
  </baseRate>
  <characteristics>
    <characteristicsList>
      <characteristicType></characteristicType>
      <characteristicValue></characteristicValue>
      <effectiveDate></effectiveDate>
    </characteristicsList>
  </characteristics>
  <pricingRuleEligibility>
    <sequence></sequence>

```

```

        <priceParmCode></priceParmCode>
        <priceParmVal></priceParmVal>
    </pricingRuleEligibility>
</healthPlanPricingRuleData>
</productHealthPlanMessage>
<toDoRetry>
    <retryDateTime></retryDateTime>
    <numberOfRetries></numberOfRetries>
    <currentErrorState></currentErrorState>
    <isRetried></isRetried>
</toDoRetry>
</schema>

```

Sample Health Product and Plan Inbound Message for Health Product Setup

Using the below example, you can do the following:

- Create the health product in the ORMB system through the health product and plan inbound message.

Health Product Code	Description	Product Type	Bundled Product	Start Date	Status	Division
HPMP444	HP Medicare Plus	EPO	N	2021-01-01	ACTIVE	TX

```

<schema>
  <bo>C1-HCProdHlthPlnInbound</bo>
  <messageType>C1-HCPRODHLTHPLN-INB-MSG-TYPE</messageType>
  <sourceSystem>NSC</sourceSystem>
  <externalTransactionId>889977</externalTransactionId>
  <externalBatchId>737373</externalBatchId>
  <externalSourceId>373737</externalSourceId>
  <productHealthPlanMessage>
    <HealthProductData>
      <healthProductCode>HPMP444</healthProductCode>
      <description>HP MEDICARE PLUS</description>
      <productType>EPO</productType>
      <productSubType>FSA</productSubType>
      <productHCCategory>MED</productHCCategory>
      <productAdministration>PBM Agency</productAdministration>
      <productLOB>INDIVIDUAL</productLOB>
      <productLOBCategory>GOVERNMENT</productLOBCategory>
      <bundledProduct>N</bundledProduct>
      <startDate>2021-01-01</startDate>
      <endDate>2021-12-01</endDate>
      <status>ACTIVE</status>
      <productCharacteristics>
        <characteristicType>MP-CLAIM</characteristicType>
        <characteristicValue>Y</characteristicValue>
        <effectiveDate>2021-01-01</effectiveDate>
      </productCharacteristics>
      <healthProductDivision>
        <division>TX</division>
      </healthProductDivision>
    </HealthProductData>
  </productHealthPlanMessage>
</schema>

```

Sample Health Product and Plan Inbound Message for Health Plan Setup

Using the below example, you can do the following:

- Create the health plan for the product in the ORMB system through the health product and health plan inbound message.

Health Product Code	Health Plan Code	Description	Start Date	Status
HPMP444	HMCSP01	Health Plan Medicare Surplus	2021-02-01	ACTIVE
HPMP444	HMCDP01	Health Plan Medicare Dental	2021-03-01	ACTIVE

```

<schema>
  <bo>C1-HCProdHlthPlnInbound</bo>
  <messageType>C1-HCPRODHLTHPLN-INB-MSG-TYPE</messageType>
  <sourceSystem>NSC</sourceSystem>
  <externalTransactionId>889977</externalTransactionId>
  <externalBatchId>737373</externalBatchId>
  <externalSourceId>373737</externalSourceId>
  <healthPlanData>
    <healthProductCode>HPMP444</healthProductCode>
    <healthPlanCode>HMCSP01</healthPlanCode>
    <description>HEALTH PLAN MEDICARE SURPLUS</description>
    <charitablePlan>N</charitablePlan>
    <standardPlan>Y</standardPlan>
    <acaQhp>Y</acaQhp>
    <grandFatherPlan>Y</grandFatherPlan>
    <ancillaryBenefits>Y</ancillaryBenefits>
    <riderBenefits>N</riderBenefits>
    <addOnPlan>N</addOnPlan>
    <startDate>2021-02-01</startDate>
    <endDate>2021-11-30</endDate>
    <status>ACTIVE</status>
    <healthPlanCharacteristics>
      <characteristicType>ZZ-BNBLA</characteristicType>
      <characteristicValue>DRCT</characteristicValue>
      <effectiveDate>2021-02-01</effectiveDate>
    </healthPlanCharacteristics>
    <healthPlanCharacteristics>
      <characteristicType>ZZ-DISPA</characteristicType>
      <characteristicValue>CRCB</characteristicValue>
      <effectiveDate>2021-02-10</effectiveDate>
    </healthPlanCharacteristics>
    <healthPlanPricingRuleTypes>
      <pricingRuleType>AGE_BASED</pricingRuleType>
    </healthPlanPricingRuleTypes>
    <healthPlanPricingRuleTypes>
      <pricingRuleType>ANCILLARY</pricingRuleType>
    </healthPlanPricingRuleTypes>
  </healthPlanData>
  <healthPlanData>
    <healthProductCode>HPMP444</healthProductCode>
    <healthPlanCode>HMCDP01</healthPlanCode>
    <description>HEALTH PLAN MEDICARE DENTAL</description>
    <charitablePlan>N</charitablePlan>
    <standardPlan>N</standardPlan>
    <acaQhp>Y</acaQhp>
    <grandFatherPlan>N</grandFatherPlan>
    <ancillaryBenefits>Y</ancillaryBenefits>
    <riderBenefits>N</riderBenefits>
    <addOnPlan>Y</addOnPlan>
    <startDate>2021-02-01</startDate>
    <endDate>2021-10-31</endDate>
  </healthPlanData>

```

```

<status>ACTIVE</status>
<healthPlanCharacteristics>
  <characteristicType>ZZ-BNBLA</characteristicType>
  <characteristicValue>DRCT</characteristicValue>
  <effectiveDate>2021-02-01</effectiveDate>
</healthPlanCharacteristics>
<healthPlanCharacteristics>
  <characteristicType>ZZ-DISPA</characteristicType>
  <characteristicValue>CRCB</characteristicValue>
  <effectiveDate>2021-02-10</effectiveDate>
</healthPlanCharacteristics>
<healthPlanPricingRuleTypes>
  <pricingRuleType>AGE_BASED</pricingRuleType>
</healthPlanPricingRuleTypes>
<healthPlanPricingRuleTypes>
  <pricingRuleType>DISCOUNT</pricingRuleType>
</healthPlanPricingRuleTypes>
</healthPlanData>
</schema>

```

Sample Health Product and Plan Inbound Message for Health Plan Pricing Rules Setup

Using the below example, you can do the following:

- Create the age-based pricing rule for the **RET_DENT** health plan.

		Base Rate			Pricing Parameter		Modifier Information		
Health Plan	Pricing Rule Type	Base Fee	Lower Age Limit	Upper Age Limit	Parameter	Parameter Value	Modifier	Modifier Value	Modifier Rate
RET_DENT	AGE_BASED	100	1	20	TOBAC	Y	SMOKER	N	10
		300	1	40	TOBAC	Y	SMOKER	N	20
		500	1	60	TOBAC	Y	SMOKER	N	30

- Create the discount charge pricing rule for the **RET_DENT** health plan.

Health Plan	Pricing Rule Type	Base Fee	Modifier	Modifier Value	Modifier Rate
RET_DENT	DISCOUNT_CHARGE	50	VP_BAND	VP1	10
		70	M_BAND	M1	20
		90	IC_BAND	IC1	30

```

<schema>
<bo>C1-HCProdHlthPlnInbound</bo>
<messageType>C1-HCPRODHLTHPLN-INB-MSG-TYPE</messageType>
<sourceSystem>NSC</sourceSystem>
<externalTransactionId>889977</externalTransactionId>
<externalBatchId>737373</externalBatchId>
<externalSourceId>373737</externalSourceId>
<healthPlanData>
  <healthProductCode>HPROD_505</healthProductCode>
  <healthPlanCode>RET_DENT</healthPlanCode>
  <description>RETIREE DENTAL HEALTH PLAN</description>
  <charitablePlan>N</charitablePlan>
  <standardPlan>Y</standardPlan>
  <acaQhp>Y</acaQhp>
  <grandFatherPlan>Y</grandFatherPlan>

```

```

<ancillaryBenefits>Y</ancillaryBenefits>
<riderBenefits>N</riderBenefits>
<addOnPlan>N</addOnPlan>
<startDate>2021-01-01</startDate>
<endDate>2021-12-31</endDate>
<status>ACTIVE</status>
<healthPlanCharacteristics>
  <characteristicType>ZZ-BNBLA</characteristicType>
  <characteristicValue>DRCT</characteristicValue>
  <effectiveDate>2021-01-01</effectiveDate>
</healthPlanCharacteristics>
<healthPlanPricingRuleTypes>
  <pricingRuleType>AGE_BASED</pricingRuleType>
</healthPlanPricingRuleTypes>
<healthPlanPricingRuleTypes>
  <pricingRuleType>DISCOUNT_CHARGE</pricingRuleType>
</healthPlanPricingRuleTypes>
</healthPlanData>
<healthPlanPricingRuleData>
  <sequence>1</sequence>
  <entityIdentifiers>
    <entityIdentifiersList>
      <entityIdentifierType>HLPN</entityIdentifierType>
      <entityIdentifierValue>RET_DENT</entityIdentifierValue>
    </entityIdentifiersList>
  </entityIdentifiers>
  <pricingRuleType>AGE_BASED</pricingRuleType>
  <priceItemCd>AGE</priceItemCd>
  <status>ACTIVE</status>
  <startDate>2021-01-01</startDate>
  <endDate>2021-31-01</endDate>
  <rateOption>ZZAGE</rateOption>
  <pricingType>FLAT</pricingType>
  <modifierApplicability>Y</modifierApplicability>
  <modifierMethod>EXPT</modifierMethod>
  <baseRate>
    <sequence>1</sequence>
    <baseFee>100</baseFee>
    <lowerAgeLimit>1</lowerAgeLimit>
    <upperAgeLimit>20</upperAgeLimit>
    <pricingParameter>
      <sequence>1</sequence>
      <parameterCode>TOBAC</parameterCode>
      <parameterValue>Y</parameterValue>
    </pricingParameter>
    <modifierInformation>
      <sequence>1</sequence>
      <parameterCode>SMOKER</parameterCode>
      <parameterValue>N</parameterValue>
      <rate>10</rate>
    </modifierInformation>
  </baseRate>
  <characteristics>
    <characteristicsList>
      <characteristicType>ZZ-DISP</characteristicType>
      <characteristicValue>DRCT</characteristicValue>
      <effectiveDate>2021-04-01</effectiveDate>
    </characteristicsList>
  </characteristics>
  <pricingRuleEligibility>
    <sequence>1</sequence>
    <priceParmCode>ORA_EMP</priceParmCode>
    <priceParmVal>Y</priceParmVal>
  </pricingRuleEligibility>

```

```

    <pricingRuleEligibility>
      <sequence>2</sequence>
      <priceParmCode>MEMSTATE</priceParmCode>
      <priceParmVal>NY</priceParmVal>
    </pricingRuleEligibility>
  </healthPlanPricingRuleData>
<healthPlanPricingRuleData>
  <sequence>2</sequence>
  <entityIdentifiers>
    <entityIdentifiersList>
      <entityIdentifierType>HLPN</entityIdentifierType>
      <entityIdentifierValue>RET_DENT</entityIdentifierValue>
    </entityIdentifiersList>
  </entityIdentifiers>
  <pricingRuleType>AGE_BASED</pricingRuleType>
  <priceItemCd>AGE</priceItemCd>
  <status>ACTIVE</status>
  <startDate>2021-01-01</startDate>
  <endDate>2021-12-31</endDate>
  <rateOption>ZZAGE</rateOption>
  <pricingType>FLAT</pricingType>
  <modifierApplicability>Y</modifierApplicability>
  <modifierMethod>EXPT</modifierMethod>
  <baseRate>
    <sequence>1</sequence>
    <baseFee>300</baseFee>
    <lowerAgeLimit>1</lowerAgeLimit>
    <upperAgeLimit>40</upperAgeLimit>
    <pricingParameter>
      <sequence>1</sequence>
      <parameterCode>TOBAC</parameterCode>
      <parameterValue>Y</parameterValue>
    </pricingParameter>
    <modifierInformation>
      <sequence>1</sequence>
      <parameterCode>SMOKER</parameterCode>
      <parameterValue>N</parameterValue>
      <rate>20</rate>
    </modifierInformation>
  </baseRate>
  <characteristics>
    <characteristicsList>
      <characteristicType>ZZ-BLAGM</characteristicType>
      <characteristicValue>BRCT</characteristicValue>
      <effectiveDate>2021-01-01</effectiveDate>
    </characteristicsList>
  </characteristics>
  <pricingRuleEligibility>
    <sequence>1</sequence>
    <priceParmCode>ORA_EMP</priceParmCode>
    <priceParmVal>Y</priceParmVal>
  </pricingRuleEligibility>
  <pricingRuleEligibility>
    <sequence>2</sequence>
    <priceParmCode>MEMSTATE</priceParmCode>
    <priceParmVal>TX</priceParmVal>
  </pricingRuleEligibility>
</healthPlanPricingRuleData>
<healthPlanPricingRuleData>
  <sequence>3</sequence>
  <entityIdentifiers>
    <entityIdentifiersList>
      <entityIdentifierType>HLPN</entityIdentifierType>
      <entityIdentifierValue>RET_DENT</entityIdentifierValue>

```

```

    </entityIdentifiersList>
  </entityIdentifiers>
  <pricingRuleType>AGE_BASED</pricingRuleType>
  <priceItemCd>AGE</priceItemCd>
  <status>ACTIVE</status>
  <startDate>2021-01-01</startDate>
  <endDate>2021-12-31</endDate>
  <rateOption>ZZAGE</rateOption>
  <pricingType>FLAT</pricingType>
  <modifierApplicability>Y</modifierApplicability>
  <modifierMethod>EXPT</modifierMethod>
  <baseRate>
    <sequence>1</sequence>
    <baseFee>500</baseFee>
    <lowerAgeLimit>1</lowerAgeLimit>
    <upperAgeLimit>60</upperAgeLimit>
    <pricingParameter>
      <sequence>1</sequence>
      <parameterCode>TOBAC</parameterCode>
      <parameterValue>Y</parameterValue>
    </pricingParameter>
    <modifierInformation>
      <sequence>1</sequence>
      <parameterCode>SMOKER</parameterCode>
      <parameterValue>N</parameterValue>
      <rate>30</rate>
    </modifierInformation>
  </baseRate>
  <characteristics>
    <characteristicsList>
      <characteristicType>ZZ-TESGM</characteristicType>
      <characteristicValue>TRCT</characteristicValue>
      <effectiveDate>2021-01-01</effectiveDate>
    </characteristicsList>
  </characteristics>
  <pricingRuleEligibility>
    <sequence>1</sequence>
    <priceParmCode>ORA_EMP</priceParmCode>
    <priceParmVal>Y</priceParmVal>
  </pricingRuleEligibility>
  <pricingRuleEligibility>
    <sequence>2</sequence>
    <priceParmCode>MEMSTATE</priceParmCode>
    <priceParmVal>OH</priceParmVal>
  </pricingRuleEligibility>
</healthPlanPricingRuleData>
<healthPlanPricingRuleData>
  <sequence>4</sequence>
  <entityIdentifiers>
    <entityIdentifiersList>
      <entityIdentifierType>HLPN</entityIdentifierType>
      <entityIdentifierValue>RET_DENT</entityIdentifierValue>
    </entityIdentifiersList>
  </entityIdentifiers>
  <pricingRuleType>DISCOUNT_CHARGE</pricingRuleType>
  <priceItemCd>DISCOUNT_1</priceItemCd>
  <status>ACTIVE</status>
  <startDate>2021-01-01</startDate>
  <endDate>2021-12-31</endDate>
  <rateOption>ZZ_CAPPCT_PK</rateOption>
  <pricingType>PCNT</pricingType>
  <modifierApplicability>Y</modifierApplicability>
  <modifierMethod>EXPT</modifierMethod>
  <baseRate>

```

```

    <sequence>1</sequence>
    <baseFee>50</baseFee>
    <lowerAgeLimit></lowerAgeLimit>
    <upperAgeLimit></upperAgeLimit>
    <pricingParameter>
      <sequence></sequence>
      <parameterCode></parameterCode>
      <parameterValue></parameterValue>
    </pricingParameter>
    <modifierInformation>
      <sequence>1</sequence>
      <parameterCode>VP_BAND</parameterCode>
      <parameterValue>VP1</parameterValue>
      <rate>10</rate>
    </modifierInformation>
  </baseRate>
  <baseRate>
    <sequence>2</sequence>
    <baseFee>70</baseFee>
    <lowerAgeLimit></lowerAgeLimit>
    <upperAgeLimit></upperAgeLimit>
    <pricingParameter>
      <sequence></sequence>
      <parameterCode></parameterCode>
      <parameterValue></parameterValue>
    </pricingParameter>
    <modifierInformation>
      <sequence>1</sequence>
      <parameterCode>M_BAND</parameterCode>
      <parameterValue>M1</parameterValue>
      <rate>20</rate>
    </modifierInformation>
  </baseRate>
  <baseRate>
    <sequence>3</sequence>
    <baseFee>90</baseFee>
    <lowerAgeLimit></lowerAgeLimit>
    <upperAgeLimit></upperAgeLimit>
    <pricingParameter>
      <sequence></sequence>
      <parameterCode></parameterCode>
      <parameterValue></parameterValue>
    </pricingParameter>
    <modifierInformation>
      <sequence>1</sequence>
      <parameterCode>IC_BAND</parameterCode>
      <parameterValue>IC1</parameterValue>
      <rate>30</rate>
    </modifierInformation>
  </baseRate>
  <characteristics>
    <characteristicsList>
      <characteristicType>ZZ-TESGM</characteristicType>
      <characteristicValue>TRCT</characteristicValue>
      <effectiveDate>2021-01-01</effectiveDate>
    </characteristicsList>
  </characteristics>
  <pricingRuleEligibility>
    <sequence>1</sequence>
    <priceParmCode>ORA_EMP</priceParmCode>
    <priceParmVal>Y</priceParmVal>
  </pricingRuleEligibility>
  <pricingRuleEligibility>
    <sequence>2</sequence>

```



```

        <priceParmCode>MEMSTATE</priceParmCode>
        <priceParmVal>OH</priceParmVal>
    </pricingRuleEligibility>
</healthPlanPricingRuleData>
</schema>

```

Inbound Message Type

Oracle Revenue Management and Billing allows you to define an inbound message type using which you can create an inbound message through an inbound web service. The following table describes the significance of the respective inbound message type:



Inbound Message Type	Helps the system to determine...
Health Care Inbound Message Type	<ul style="list-style-type: none"> • Inbound Message Business Object - The business object using which the inbound message should be created in the system. • Customer Registration Type - The customer registration type using which the customer registration object should be created through a health care inbound message.
Health Product and Plan Inbound Message Type	<ul style="list-style-type: none"> • Health Product and Plan Inbound Message Business Object - The business object using which the health product and plan inbound message should be created in the system.

The **Inbound Message Type** screen allows you to define, edit, copy, and delete an inbound message type. It contains the following zones:

- [Inbound Message Type List](#) on page 2269
- [Inbound Message Type](#) on page 2270

Inbound Message Type List

The **Inbound Message Type List** zone lists the inbound message types that are already defined in the system. It contains the following columns:

Column Name	Column Description
Inbound Message Type	Displays the inbound message type.
Description	Displays the description of the inbound message type.
Edit	On clicking the Edit () icon, the Inbound Message Type screen appears where you can edit the details of the inbound message type.
Duplicate	On clicking the Duplicate () icon, the Inbound Message Type screen appears where you can define a new inbound message type using an existing inbound message type.
Delete	On clicking the Delete () icon, you can delete the inbound message type.
	Note: You can delete an inbound message type when an inbound message is not created using the inbound message type.

On clicking the **Broadcast** () icon corresponding to an inbound message type, the **Inbound Message Type** zone appears with the details of the respective inbound message type.

Related Topics

For more information on...	See...
How to edit an inbound message type	Editing an Inbound Message Type on page 2276
How to copy an inbound message type	Copying an Inbound Message Type on page 2278
How to delete an inbound message type	Deleting an Inbound Message Type on page 2280
How to view the details of an inbound message type	Viewing the Inbound Message Type Details on page 2272

Inbound Message Type

The **Inbound Message Type** zone displays the details of the inbound message type. It contains the following sections:

- **Main** – Displays basic information about the inbound message type. It contains the following fields:

Field Name	Field Description
Inbound Message Type	Displays the inbound message type.
Customer Registration Type	<p>Indicates the customer registration type using which the customer registration object is created through a health care inbound message.</p> <p>Note: It has a link. On clicking the link, the Customer Registration Type screen appears where you can view the details of the respective customer registration type. This field appears when you are viewing the details of an inbound message type which is created using the C1-HCInboundMsgType business object.</p>
Inbound Message Business Object	<p>Indicates the business object using which the inbound message is created. In addition, a context menu appears corresponding to this field which helps in navigating to other screens in the application.</p> <p>Note: It has a link. On clicking the link, the Business Object screen appears where you can view the details of the respective business object.</p>
Healthcare Product Business Object	<p>Indicates the business object using which the healthcare product is created when the health product and plan inbound message is processed. In addition, a context menu appears corresponding to this field which helps in navigating to other screens in the application.</p> <p>Note: It has a link. On clicking the link, the Business Object screen appears where you can view the details of the respective business object. This field appears when you are viewing the details of an inbound message type which is created using the C1-HealthcareProduct business object.</p>

Field Name	Field Description
Health Plan Business Object	<p>Indicates the business object using which the health plan is created when the health product and plan inbound message is processed. In addition, a context menu appears corresponding to this field which helps in navigating to other screens in the application.</p> <p>Note:</p> <p>It has a link. On clicking the link, the Business Object screen appears where you can view the details of the respective business object.</p> <p>This field appears when you are viewing the details of an inbound message type which is created using the C1-HealthPlan business object.</p>
Description	Displays the description of the inbound message type.
Status	<p>Indicates the status of the inbound message type. The valid values are:</p> <ul style="list-style-type: none"> • Active • Inactive
Detailed Description	Displays additional information about the inbound message type.

- **Characteristics** – Lists the characteristics defined for the inbound message type. It contains the following columns:

Column Name	Column Description
Characteristic Type	Indicates the characteristic type.
Characteristic Value	Displays the value of the characteristic type.

- **Record Actions** – This section contains the following buttons:

Button Name	Button Description
Edit	Used to edit the details of the inbound message type.
Delete	<p>Used to delete the inbound message type.</p> <p>Note: You can delete an inbound message type when an inbound message is not created using the inbound message type.</p>
Duplicate	Used to create a new inbound message type using an existing inbound message type.

- **Record Information** – This section contains the following field:

Field Name	Field Description
Business Object	<p>Indicates the business object using which the inbound message type is created. In addition, a context menu appears corresponding to this field which helps in navigating to other screens in the application.</p> <p>Note: It has a link. On clicking the link, the Business Object screen appears where you can view the details of the respective business object.</p>

By default, the **Inbound Message Type** zone does not appear in the **Inbound Message Type** screen. It appears when you click the **Broadcast** () icon corresponding to an inbound message type in the **Inbound Message Type List** zone.

Related Topics

For more information on...	See...
How to edit an inbound message type	Editing an Inbound Message Type on page 2276
How to copy an inbound message type	Copying an Inbound Message Type on page 2278
How to delete an inbound message type	Deleting an Inbound Message Type on page 2280
How to view the details of an inbound message type	Viewing the Inbound Message Type Details on page 2272

Viewing the Inbound Message Type Details**Procedure**

To view the details of an inbound message type:

1. Click the **Admin** link in the **Application** toolbar.
A list appears.
2. From the **Admin** menu, select **I** and then click **Inbound Message Type**.
A sub-menu appears.
3. Click the **Search** option from the **Inbound Message Type** sub-menu.
The **Inbound Message Type** screen appears.
4. In the **Inbound Message Type List** zone, click the **Broadcast** (📶) icon corresponding to the inbound message type whose details you want to view.
The **Inbound Message Type** zone appears.
5. View the details of the inbound message type in the **Inbound Message Type** zone.

Related Topics

For more information on...	See...
Inbound Message Type screen	Inbound Message Type on page 2269
Inbound Message Type List zone	Inbound Message Type List on page 2269
Inbound Message Type zone	Inbound Message Type on page 2270

Defining an Inbound Message Type**Prerequisites**

The following table lists the prerequisites for defining various inbound message types:

If you want to define a..	Then, you should have...
Health Care Inbound Message Type	<ul style="list-style-type: none"> • Health care inbound message type business objects defined in the application • Health care inbound message business objects defined in the application • Customer registration types defined in the application

If you want to define a..	Then, you should have...
Health Product and Plan Inbound Message Type	<ul style="list-style-type: none"> Health product and plan inbound message type business objects defined in the application Health product and plan inbound message business objects defined in the application Health product business object defined in the application Health plan business object defined in the application

Procedure

To define an inbound message type:

1. Click the **Admin** link in the **Application** toolbar.
A list appears.
2. From the **Admin** menu, select **I** and then click **Inbound Message Type**.
A sub-menu appears.
3. Click the **Add** option from the **Inbound Message Type** sub-menu.

The **Select Business Object** screen appears. It contains the following field:

Field Name	Field Description	Mandatory (Yes or No)						
Inbound Message Type Business Object	Used to indicate the business object using which you want to create the inbound message type. The following table lists the business objects using which you can create the respective inbound message type: <table border="1" data-bbox="565 1121 1203 1335"> <thead> <tr> <th>Inbound Message Type</th> <th>Business Object</th> </tr> </thead> <tbody> <tr> <td>Health Care Inbound Message Type</td> <td>C1-HCInboundMsgType</td> </tr> <tr> <td>Health Product and Plan Inbound Message Type</td> <td>C1-HCProdHlthPlnInbound</td> </tr> </tbody> </table>	Inbound Message Type	Business Object	Health Care Inbound Message Type	C1-HCInboundMsgType	Health Product and Plan Inbound Message Type	C1-HCProdHlthPlnInbound	Yes
Inbound Message Type	Business Object							
Health Care Inbound Message Type	C1-HCInboundMsgType							
Health Product and Plan Inbound Message Type	C1-HCProdHlthPlnInbound							

Tip: Alternatively, you can access this screen by clicking the **Add** button in the **Page Title** area of the **Inbound Message Type** screen.

4. Select the **Health Care Inbound Message Type** business object to create the respective inbound message type.
5. Click **OK**.

The **Inbound Message Type** screen appears. It contains the following sections:

- **Main** – Used to specify basic details about the inbound message type.
- **Characteristics** – Used to define the characteristics for the inbound message type.

The **Main** section contains the following fields:

Field Name	Field Description	Mandatory (Yes or No)
Inbound Message Type	Used to specify the inbound message type.	Yes

Field Name	Field Description	Mandatory (Yes or No)
Business Object	Indicates the business object using which you are defining the inbound message type.	Not applicable
Customer Registration Type	Used to indicate the customer registration type using which you want to create the customer registration object through a health care inbound message. Note: This field appears when you are defining an inbound message type using the C1-HCInboundMsgType business object. While creating a health care inbound message type for the fully-insured group health insurance business, you must use a customer registration type where the Approval Required , Final Approval Required , and Manual Billing Hierarchy and Pricing options are not selected. However, while creating a health care inbound message type for the self-funded health insurance business, you must use a customer registration type where the Final Approval Required and Manual Billing Hierarchy and Pricing options are selected, but the Approval Required option is not selected.	Yes
Inbound Message Business Object	Used to indicate the business object using which you want to create the respective inbound message.	Yes
Health Product Business Object	Used to indicate the business object using which you want to create a health product when the health product and plan inbound message is processed. Note: This field appears when you are defining a health product and plan inbound message type using the C1-HealthcareProduct business object.	Yes
Health Plan Business Object	Used to indicate the business object using which you want to create a health plan when the health product and plan inbound message is processed. Note: This field appears when you are defining a health product and plan inbound message type using the C1-HealthPlan business object.	Yes
Description	Used to specify the description for the inbound message type.	Yes
Status	Used to indicate the status of the inbound message type. The valid values are: <ul style="list-style-type: none"> • Active • Inactive 	Yes
Detailed Description	Used to specify additional information about the inbound message type.	No

6. Enter the required details in the **Main** section.
7. Define characteristics for the inbound message type, if required.

8. Click **Save**.

The inbound message type is defined.

Related Topics

For more information on...	See...
Inbound Message Type screen	Inbound Message Type on page 2269
How to define a characteristic for an inbound message type	Defining a Characteristic for an Inbound Message Type on page 2275

Defining a Characteristic for an Inbound Message Type

Prerequisites

To define a characteristic for an inbound message type, you should have:

- Characteristic types defined in the application (where the characteristic entity is set to **Inbound Message Type**)

Procedure

To define a characteristic for an inbound message type:

1. Ensure that the **Characteristics** section is expanded when you are defining, editing, or copying an inbound message type.

The **Characteristics** section contains the following fields in a grid:

Field Name	Field Description	Mandatory (Yes or No)
Characteristic Type	Used to indicate the characteristic type.	Yes (Conditional)
	Note: The list includes only those characteristic types where the characteristic entity is set to Inbound Message Type .	Note: This field is required while defining a characteristic for the inbound message type.
Characteristic Value	Used to specify the value for the characteristic type.	Yes (Conditional)
	Note: If you select a predefined characteristic type, the Search (🔍) icon appears corresponding to the Characteristic Value field. On clicking the Search icon, the Predefined Characteristic Search window appears. On specifying the value for a predefined characteristic type, the description of the characteristic value appears corresponding to the Characteristic Value field.	Note: This field is required while defining a characteristic for the inbound message type.

2. Enter the required details in the **Characteristics** section.
3. If you want to define more than one characteristic for the inbound message type, click the **Add (+)** icon and then repeat step 2.

Note: However, if you want to remove a characteristic from the inbound message type, click the **Delete** (🗑️) icon corresponding to the characteristic.

Related Topics

For more information on...	See...
How to define an inbound message type	Defining an Inbound Message Type on page 2272
How to edit an inbound message type	Editing an Inbound Message Type on page 2276
How to copy an inbound message type	Copying an Inbound Message Type on page 2278

Editing an Inbound Message Type

Prerequisites

The following table lists the prerequisites for editing various inbound message types:

If you want to define a..	Then, you should have...
Health Care Inbound Message Type	<ul style="list-style-type: none"> Health care inbound message business objects defined in the application Customer registration types defined in the application
Health Product and Plan Inbound Message Type	<ul style="list-style-type: none"> Health product and plan inbound message type business objects defined in the application Health product and plan inbound message business objects defined in the application Health product business object defined in the application Health plan business object defined in the application

Procedure

To edit an inbound message type:

- Click the **Admin** link in the **Application** toolbar.
A list appears.
- From the **Admin** menu, select **I** and then click **Inbound Message Type**.
A sub-menu appears.
- Click the **Search** option from the **Inbound Message Type** sub-menu.
The **Inbound Message Type** screen appears.
- In the **Inbound Message Type List** zone, click the **Edit** (✎) icon in the **Edit** column corresponding to the Inbound message type whose details you want to edit.

The **Inbound Message Type** screen appears. It contains the following sections:

- Main** – Used to specify basic details about the inbound message type.
- Characteristics** – Used to define the characteristics for the inbound message type.

The **Main** section contains the following fields:

Field Name	Field Description	Mandatory (Yes or No)
Inbound Message Type	Displays the inbound message type.	Not applicable
Business Object	Indicates the business object which is used while defining the inbound message type.	Not applicable

Field Name	Field Description	Mandatory (Yes or No)
Customer Registration Type	Used to indicate the customer registration type using which you want to create the customer registration object through a health care inbound message.	Yes
	<p>Note:</p> <p>This field appears when you are defining an inbound message type using the C1-HCInboundMsgType business object.</p> <p>While creating a health care inbound message type for the fully-insured group health insurance business, you must use a customer registration type where the Approval Required, Final Approval Required, and Manual Billing Hierarchy and Pricing options are not selected. However, while creating a health care inbound message type for the self-funded health insurance business, you must use a customer registration type where the Final Approval Required and Manual Billing Hierarchy and Pricing options are selected, but the Approval Required option is not selected.</p>	
Inbound Message Business Object	Used to indicate the business object using which you want to create the respective inbound message.	Yes
Health Product Business Object	Used to indicate the business object using which you want to create a health product when the health product and plan inbound message is processed.	Yes
	<p>Note: This field appears when you are defining a health product and plan inbound message type using the C1-HealthcareProduct business object.</p>	
Health Plan Business Object	Used to indicate the business object using which you want to create a health plan when the health product and plan inbound message is processed.	Yes
	<p>Note: This field appears when you are defining a health product and plan inbound message type using the C1-HealthPlan business object.</p>	
Description	Used to specify the description for the inbound message type.	Yes
Status	Used to indicate the status of the inbound message type. The valid values are: <ul style="list-style-type: none"> • Active • Inactive 	Yes
Detailed Description	Used to specify additional information about the inbound message type.	No

Tip: Alternatively, you can edit the details of an inbound message type by clicking the **Edit** button in the **Inbound Message Type** zone.

5. Modify the required details in the **Main** section.
6. Define, edit, or remove characteristics of the inbound message type, if required.
7. Click **Save**.

The changes made to the inbound message type are saved.

Related Topics

For more information on...	See...
Inbound Message Type screen	Inbound Message Type on page 2269
Inbound Message Type List zone	Inbound Message Type List on page 2269
Inbound Message Type zone	Inbound Message Type on page 2270
How to define a characteristic for an inbound message type	Defining a Characteristic for an Inbound Message Type on page 2275

Copying an Inbound Message Type

Instead of creating an inbound message type from scratch, you can create a new inbound message type using an existing inbound message type. This is possible through copying an inbound message type. On copying an inbound message type, the details including the characteristics are copied to the new inbound message type. You can then edit the details, if required.

Prerequisites

The following table lists the prerequisites for copying various inbound message types:

If you want to define a..	Then, you should have...
Health Care Inbound Message Type	<ul style="list-style-type: none"> • Health care inbound message type (whose copy you want to create) defined in the application • Health care inbound message business objects defined in the application • Customer registration types defined in the application
Health Product and Plan Inbound Message Type	<ul style="list-style-type: none"> • Health product and plan inbound message type business objects defined in the application • Health product and plan inbound message business objects defined in the application • Health product business object defined in the application • Health plan business object defined in the application

Procedure

To copy an inbound message type:

1. Click the **Admin** link in the **Application** toolbar.
A list appears.
2. From the **Admin** menu, select **I** and then click **Inbound Message Type**.
A sub-menu appears.
3. Click the **Search** option from the **Inbound Message Type** sub-menu.
The **Inbound Message Type** screen appears.

4. In the **Inbound Message Type List** zone, click the **Duplicate** (📄) icon in the **Duplicate** column corresponding to the inbound message type whose copy you want to create.

The **Inbound Message Type** screen appears. It contains the following sections:

- **Main** – Used to specify basic details about the inbound message type.
- **Characteristics** – Used to define the characteristics for the inbound message type.

The **Main** section contains the following fields:

Field Name	Field Description	Mandatory (Yes or No)
Inbound Message Type	Used to specify the inbound message type.	Yes
Business Object	Indicates the business object which is used while defining the inbound message type.	Not applicable
Customer Registration Type	Used to indicate the customer registration type using which you want to create the customer registration object through a health care inbound message. Note: This field appears when you are defining an inbound message type using the C1-HCInboundMsgType business object. While creating a health care inbound message type for the fully-insured group health insurance business, you must use a customer registration type where the Approval Required , Final Approval Required , and Manual Billing Hierarchy and Pricing options are not selected. However, while creating a health care inbound message type for the self-funded health insurance business, you must use a customer registration type where the Final Approval Required and Manual Billing Hierarchy and Pricing options are selected, but the Approval Required option is not selected.	Yes
Inbound Message Business Object	Used to indicate the business object using which you want to create the respective inbound message.	Yes
Health Product Business Object	Used to indicate the business object using which you want to create a health product when the health product and plan inbound message is processed. Note: This field appears when you are defining a health product and plan inbound message type using the C1-HealthcareProduct business object.	Yes
Health Plan Business Object	Used to indicate the business object using which you want to create a health plan when the health product and plan inbound message is processed. Note: This field appears when you are defining a health product and plan inbound message type using the C1-HealthPlan business object.	Yes

Field Name	Field Description	Mandatory (Yes or No)
Description	Used to specify the description for the inbound message type.	Yes
Status	Used to indicate the status of the inbound message type. The valid values are: <ul style="list-style-type: none"> Active Inactive 	Yes
Detailed Description	Used to specify additional information about the inbound message type.	No

Tip: Alternatively, you can copy an inbound message type by clicking the **Duplicate** button in the **Inbound Message Type** zone.

- Enter the required details in the **Main** section.
- Define, edit, or remove characteristics of the inbound message type, if required.
- Click **Save**.

The new inbound message type is defined.

Related Topics

For more information on...	See...
Inbound Message Type screen	Inbound Message Type on page 2269
Inbound Message Type List zone	Inbound Message Type List on page 2269
Inbound Message Type zone	Inbound Message Type on page 2270
How to define a characteristic for an inbound message type	Defining a Characteristic for an Inbound Message Type on page 2275

Deleting an Inbound Message Type

Procedure

To delete an inbound message type:

- Click the **Admin** link in the **Application** toolbar.
A list appears.
- From the **Admin** menu, select **I** and then click **Inbound Message Type**.
A sub-menu appears.
- Click the **Search** option from the **Inbound Message Type** sub-menu.
The **Inbound Message Type** screen appears.
- In the **Inbound Message Type List** zone, click the **Delete** (🗑️) icon in the **Delete** column corresponding to the inbound message type that you want to delete.
A message appears confirming whether you want to delete the inbound message type.

Note: You can delete an inbound message type when an inbound message is not created using the inbound message type.

Tip: Alternatively, you can delete an inbound message type by clicking the **Delete** button in the **Inbound Message Type** zone.

5. Click **OK**.

The inbound message type is deleted.

Related Topics

For more information on...	See...
Inbound Message Type screen	Inbound Message Type on page 2269
Inbound Message Type List zone	Inbound Message Type List on page 2269
Inbound Message Type zone	Inbound Message Type on page 2270

Inbound Message (Used for Searching)

The **Inbound Message** screen allows you to search for an inbound message using various search criteria. It contains the following zone:

- [Search Inbound Message](#) on page 2281

Through this screen, you can navigate to the following screen:

- [Inbound Message \(Used for Viewing\)](#) on page 2287

Search Inbound Message

The **Search Inbound Message** zone allows you to search for an inbound message using various search criteria. It contains the following two sections:

- **Search Criteria** - The **Search Criteria** section contains the following fields:

Field Name	Field Description	Mandatory (Yes or No)
Search By	Used to indicate whether you want to search for an inbound message using the inbound message or person details. The valid values are: <ul style="list-style-type: none"> • Message Details • Person Details <p>Note: By default, the Message Details option is selected.</p>	Yes
Inbound Message ID	Used to search a particular inbound message. <p>Note: This field appears when the Message Details option is selected from the Search By list.</p>	No

Field Name	Field Description	Mandatory (Yes or No)
Person ID	<p>Used to search inbound messages through which a particular parent customer or bill group and their related entities are created in the system.</p> <p>Note:</p> <p>The Search (🔍) icon appears corresponding to the Person ID field. On clicking the Search icon, the Person Search window appears.</p> <p>This field appears when the Person Details option is selected from the Search By list.</p> <p>This field is only applicable for the fully-insured group and self-funded businesses.</p> <p>This field can only be used to search inbound messages through which a person of the following person types is created in the system:</p> <ul style="list-style-type: none"> • Parent Customer • Bill Group 	Yes
Status	<p>Used to search inbound messages with a particular status. The valid values are:</p> <ul style="list-style-type: none"> • Pending • Processed • Rejected • Voided <p>Note: This field appears when the Message Details option is selected from the Search By list.</p>	No
Source System	<p>Used to search inbound messages which are received from a particular external system.</p> <p>Note: This field appears when the Message Details option is selected from the Search By list.</p>	No
Created From	<p>Used to search inbound messages which are created from a particular date onwards.</p> <p>Note: This field appears when the Message Details option is selected from the Search By list.</p>	No
External Source ID	<p>Used to search inbound messages which are received from a particular external source system.</p> <p>Note: This field appears when the Message Details option is selected from the Search By list.</p>	No

Field Name	Field Description	Mandatory (Yes or No)
Created To	Used to search inbound messages which are created till a particular date.	No
	Note: This field appears when the Message Details option is selected from the Search By list.	
External Transaction ID	Used to search the inbound message which was a result of a particular transaction in the external source system.	No
	Note: This field appears when the Message Details option is selected from the Search By list.	
User ID	Used to search inbound messages which are created by a particular user.	No
	Note: This field appears when the Message Details option is selected from the Search By list.	
External Batch ID	Used to search inbound messages which are created through a particular batch job.	No
	Note: This field appears when the Message Details option is selected from the Search By list.	
Inbound Message Type	Used to search inbound messages which are created using a particular inbound message type.	No
	Note: This field appears when the Message Details option is selected from the Search By list.	

Note: You must specify at least one search criterion while searching for an inbound message.

- **Search Results** - On clicking the **Search** button, the search results appear based on the specified search criteria. The **Search Results** section contains the following columns:

Column Name	Column Description
Inbound Message Information	Displays information about the inbound message.
	Note: It has a link. On clicking the link, the Inbound Message screen appears where you can view the details of the respective inbound message.
Status	Indicates the status of the inbound message. The valid values are: <ul style="list-style-type: none"> • Pending • Processed • Rejected • Voided
Inbound Message Type	Indicates the inbound message type using which the inbound message is created.

Column Name	Column Description
Source System	Indicates the source system from where the inbound message is received.
External Transaction ID	Indicates the transaction in the external source system which resulted in the inbound message.
External Source ID	Displays the external source system ID.
External Batch ID	Indicates the batch job in the external source system through which the inbound message is created.
Person Information	Indicates the person whose record is created or updated in the system through the inbound message. In addition, this column has a context menu which helps in navigating to other screens in the application. Note: It has a link. On clicking the link, the Person screen appears where you can view the details of the respective person. This column appears when the Person Details option is selected from the Search By list.
Created By	Indicates the user who has created the inbound message. Note: This column appears when the Message Details option is selected from the Search By list.
Creation Date	Displays the date when the inbound message is created in the system.

Note: Pagination is used to display limited number of records in the **Search Results** section. You can use the navigation links, such as **Previous** and **Next** to navigate between pages.

Related Topics

For more information on...	See...
How to search for an inbound message	Searching for an Inbound Message on page 2284
How to view the details of an inbound message	Viewing the Inbound Message Details on page 2286

Searching for an Inbound Message

Prerequisites

To search for an inbound message, you should have:

- Inbound message types defined in the application
- Values defined for the **C1-SourceSystemLookup** extendable lookup
- Person identifier types defined in the application

Procedure

To search for an inbound message:

1. Click the **Menu** link in the **Application** toolbar.
A list appears.
2. From the **Main** menu, select **Integration** and then click **Inbound Message**.

The **Inbound Message** screen appears.

- Enter the search criteria in the **Search Inbound Message** zone.

Note: ORMB search engine supports wildcard search, where you can substitute the percentage (%) symbol as a stand in for any word or letter in a search criteria. You can use the ‘%’ wildcard character in all input fields except the date and ID fields. The ‘%’ wildcard character is suffixed automatically at the end of the partial search criteria. Therefore, you may or may not specify the wildcard character at the end of the partial search criteria. However, you have to prefix the wildcard character manually wherever required.

- Click **Search**.

A list of inbound messages that meet the search criteria appears in the **Search Results** section.

Related Topics

For more information on...	See...
Inbound Message screen	Inbound Message (Used for Searching) on page 2281
Search Inbound Message zone	Search Inbound Message on page 2281

Creating an Inbound Message

Oracle Revenue Management and Billing allows you to create the following inbound messages by calling the respective inbound web service:

Inbound Message	Inbound Web Service
Health Care Inbound Message on page 2080	C1-HCInboundMessage on page 2285
Health Product and Plan Inbound Message on page 2237	C1-HCProdHlthPlnInboundMessage (SOAP Based Service) on page 2286
	C1-HCProdHlthPlnInboundMes (REST Based Service) on page 2286

You cannot create the above inbound messages from the user interface. However, you can define, edit, and remove a characteristic from the above inbound messages from the user interface. You can delete and submit the above inbound messages for validation and processing from the user interface and through a batch process.

C1-HCInboundMessage

The **C1-HCInboundMessage** inbound web service enables you to create or update a person, account and self-funded or fully-insured group policy. It also allows you to create or update a policy plan, membership, and pass-through billable charge for a fully-insured group policy. In addition, it allows you to terminate, reinstate, or renew a fully-insured group policy.

On calling the **C1-HCInboundMessage** inbound web service, a health care inbound message is created in the **Pending** status. A health care inbound message goes through various statuses in its lifecycle. You can search for a health care inbound message through the **Inbound Message** screen.

Before calling the **C1-HCInboundMessage** inbound web service, you need to ensure that the prerequisites are setup as mentioned in [Prerequisites](#) on page 2085.

Related Topics

For more information on...	See...
Inbound Message screen	Inbound Message (Used for Searching) on page 2281

For more information on...	See...
Health Care Inbound Message Status Transition through User Interface	Health Care Inbound Message Status Transition through User Interface on page 2087
Health Care Inbound Message Status Transition through a Batch Process	Health Care Inbound Message Status Transition through a Batch Process on page 2088

C1-HCProdHlthPlnInboundMessage (SOAP Based Service)

The **C1-HCProdHlthPlnInboundMessage** soap based inbound web service enables you to create or update a health product, health plan and the pricing rules which are associated with the health plan.

On calling the **C1-HCProdHlthPlnInboundMessage** soap based inbound web service, a health product and plan inbound message is created in the **Pending** status. A health product and plan inbound message goes through various statuses in its lifecycle. You can search for a health product and plan inbound message through the **Inbound Message** screen.

Before calling the **C1-HCProdHlthPlnInboundMessage** soap based inbound web service, you need to ensure that the prerequisites are setup as mentioned in [Prerequisites](#) on page 2238.

Related Topics

For more information on...	See...
Inbound Message screen	Inbound Message (Used for Searching) on page 2281
Health Product and Plan Inbound Message Status Transition through User Interface	
Health Product and Plan Inbound Message Status Transition through a Batch Process	

C1-HCProdHlthPlnInboundMes (REST Based Service)

The **C1-HCProdHlthPlnInboundMes** rest based inbound web service enables you to create or update a health product, health plan and the pricing rules which are associated with the health plan.

On calling the **C1-HCProdHlthPlnInboundMes** rest based inbound web service, a health product and plan inbound message is created in the **Pending** status. A health product and plan inbound message goes through various statuses in its lifecycle. You can search for a health product and plan inbound message through the **Inbound Message** screen.

Before calling the **C1-HCProdHlthPlnInboundMes** rest based inbound web service, you need to ensure that the prerequisites are setup as mentioned in [Prerequisites](#) on page 2238.

Related Topics

For more information on...	See...
Inbound Message screen	Inbound Message (Used for Searching) on page 2281
Health Product and Plan Inbound Message Status Transition through User Interface	
Health Product and Plan Inbound Message Status Transition through a Batch Process	

Viewing the Inbound Message Details

Procedure

To view the details of an inbound message:

1. Search for the inbound message in the **Inbound Message** screen.

2. In the **Search Results** section, click the link in the **Inbound Message Information** column corresponding to the inbound message whose details you want to view.

The **Inbound Message** screen appears.

3. Ensure that the **Main** tab is selected.
4. View the details of the inbound message in the **Inbound Message** zone.

Related Topics

For more information on...	See...
How to search for an inbound message	Searching for an Inbound Message on page 2284
Inbound Message screen	Inbound Message (Used for Viewing) on page 2287
Inbound Message zone	Inbound Message on page 2287

Inbound Message (Used for Viewing)

Once an inbound message is created, the **Inbound Message** screen allows you to:

- View the details of the inbound message
- Edit the details of the inbound message
- Delete the inbound message
- Submit the inbound message for validation and processing
- Resubmit the inbound message for validation and processing on failure
- Void the inbound message
- View the content of the inbound message
- View the log of the inbound message
- Add a log entry for the inbound message

The **Inbound Message** screen contains the following tabs:

- [Inbound Message - Main](#) on page 2287
- [Inbound Message - Message](#) on page 2289
- [Inbound Message - Log](#) on page 2290

Inbound Message - Main

The **Main** tab displays information about the inbound message. It contains the following zone:

- [Inbound Message](#) on page 2287

Inbound Message

The **Inbound Message** zone displays the details of the inbound message. It contains the following sections:

- **Main** – Displays basic information about the inbound message. It contains the following fields:

Field Name	Field Description
Inbound Message Information	Displays information about the inbound message.

Field Name	Field Description
Status	Indicates the status of the inbound message. The valid values are: <ul style="list-style-type: none"> • Pending • Processed • Rejected • Voided
Inbound Message Type	Indicates the inbound message type using which the inbound message is created. Note: It has a link. On clicking the link, the Inbound Message Type screen appears where you can view the details of the respective inbound message type.
Source System	Indicates the external source system from where the inbound message is received.
External Transaction ID	Indicates the transaction in the external source system which resulted in the inbound message.
External Batch ID	Indicates the external batch job through which the inbound message is created.
External Source ID	Displays the external source system ID.

- **Characteristics** – Lists the characteristics defined for the inbound message. It contains the following columns:

Column Name	Column Description
Effective Date	Displays the date from when the characteristic is effective for the inbound message.
Characteristic Type	Indicates the characteristic type.
Characteristic Value	Displays the value of the characteristic type.

- **Record Actions** – This section contains the following buttons:

Button Name	Button Description
Edit	Used to define, edit, or remove characteristics of the inbound message. Note: The Edit button appears when the inbound message is in the Pending or Rejected status.
Delete	Used to delete the inbound message. Note: The Delete button appears when the inbound message is in the Pending status.
Submit for Processing	Used to submit the inbound message for validation and processing. Note: The Submit for Processing button appears only when the inbound message is in the Pending status.

Button Name	Button Description
Retry	Used when you want to change the status of the inbound message from Rejected to Pending so that the inbound message can be considered once again for validation and processing.
	Note: The Retry button appears when the inbound message is in the Rejected status.
Void	Used to cancel the inbound message.
	Note: The Void button appears when the inbound message is in the Rejected status.

- **Record Information** – This section contains the following fields:

Field Name	Field Description
Business Object	Indicates the business object using which the inbound message is created. In addition, a context menu appears corresponding to this field which helps in navigating to other screens in the application.
	Note: It has a link. On clicking the link, the Business Object screen appears where you can view the details of the respective business object.
Status Date/Time	Displays the date and time when the status of the inbound message is updated.
Create Date/Time	Displays the date and time when the inbound message is created.

Related Topics

For more information on...	See...
How to view the inbound message details	Viewing the Inbound Message Details on page 2286

Inbound Message - Message

The **Message** tab displays the content of the inbound message in the XML format. It contains the following zone:

- [Inbound Message Content](#) on page 2289

Inbound Message Content

The **Inbound Message Content** zone displays the content of the inbound message in the XML format. By default, each tag in the inbound message is expanded. You can collapse the tag whenever required.

For more information about the tags, refer to the respective XML format section:

Inbound Message	XML Format
Health Care Inbound Message	Health Care Inbound Message XML Format on page 2092
Health Product and Plan Inbound Message	Health Product and Plan Inbound Message XML Format on page 2243

Once the inbound message is validated and processed either from the user interface or through a batch process, the following tags appear at the bottom of the inbound message in the **Inbound Message Content** zone:

Tag Name	Tag Description
toDoRetry	Displays the information about the retry option used for the inbound message.

Tag Name	Tag Description
retryDateTime	Displays the date and time when the retry option is used to change the status of the inbound message from Rejected to Pending .
numberOfRetries	Indicates the number of times the retry option is used for the inbound message.
currentErrorState	Indicates the status to which the inbound message is transitioned when its validation or processing fails. The valid value is: <ul style="list-style-type: none"> REJECTED
isRetried	Indicates whether the retry option is used to change the status of the inbound message. The valid values are: <ul style="list-style-type: none"> true false

Related Topics

For more information on...	See...
How to view the content of an inbound message	Viewing the Content of an Inbound Message on page 2296

Inbound Message - Log

The **Log** tab contains the following zone:

- [Inbound Message Log](#) on page 2290

Inbound Message Log

The **Inbound Message Log** zone lists the complete trail of actions performed on the inbound message. It contains the following columns:

Column Name	Column Description
Date/Time	Displays the date and time when the action was performed on the inbound message.
Details	Displays the details about the action performed on the inbound message.
User	Indicates the user who has performed the action on the inbound message.
Log Type	Indicates the type of log.
Related Object	Indicates the object or entity which is created when the action is performed on the inbound message.
Status Reason	Indicates the reason why the status of the inbound message is changed. <div style="border: 1px solid black; padding: 5px; margin-top: 5px;"> <p>Note: At present, no data appears in this column. The implementation team can build the custom logic to meet the business requirements.</p> </div>

Note: You can manually add a log entry for the inbound message by clicking the **Add Log Entry** link in the upper right corner of the **Inbound Message Log** zone.

Related Topics

For more information on...	See...
How to view the log of an inbound message	Viewing the Log of an Inbound Message on page 2297
How to add a log entry for an inbound message	Adding a Log Entry for an Inbound Message on page 2297

Editing an Inbound Message

Procedure

To edit an inbound message:

1. Search for the inbound message in the **Inbound Message** screen.
2. In the **Search Results** section, click the link in the **Inbound Message Information** column corresponding to the inbound message whose details you want to edit.

The **Inbound Message** screen appears.

3. Ensure that the **Main** tab is selected.
4. Click the **Edit** button in the **Inbound Message** zone.

The **Inbound Message** screen appears. It contains the following sections:

- **Main** - Displays the basic information about the inbound message. It contains the following fields:

Field Name	Field Description
Inbound Message Information	Displays information about the inbound message.
Inbound Message Type	Indicates the inbound message type using which the inbound message is created.
Source System	Indicates the source system from where the inbound message is received.
External Transaction ID	Indicates the transaction in the external source system which resulted in the inbound message.
External Batch ID	Indicates the batch job in the external source system through which the inbound message is created.
External Source ID	Displays the external source system ID.

- **Characteristics** - Used to define, edit, or remove characteristics of the inbound message.

Note: The **Edit** button appears when the inbound message is in the **Pending** or **Rejected** status.

5. Define, edit, or remove characteristics of the inbound message, if required.
6. Click **Save**.

The changes made to the inbound message are saved.

Related Topics

For more information on...	See...
How to search for an inbound message	Searching for an Inbound Message on page 2284
Inbound Message screen	Inbound Message (Used for Viewing) on page 2287
Inbound Message zone	Inbound Message on page 2287

For more information on...	See...
How to define a characteristic for an inbound message	Defining a Characteristic for an Inbound Message on page 2292

Defining a Characteristic for an Inbound Message

Prerequisites

To define a characteristic for an inbound message, you should have:

- Characteristic types defined in the application (where the characteristic entity is set to **Inbound Message**)

Procedure

To define a characteristic for an inbound message:

1. Ensure that the **Characteristics** section is expanded when you are editing an inbound message.

The **Characteristics** section contains the following fields in a grid:

Field Name	Field Description	Mandatory (Yes or No)
Effective Date	Used to specify the date from when the characteristic is effective for the inbound message.	Yes (Conditional) Note: This field is required when you are defining a characteristic for the inbound message.
Characteristic Type	Used to indicate the characteristic type. Note: The list includes only those characteristic types where the characteristic entity is set to Inbound Message .	Yes (Conditional) Note: This field is required when you are defining a characteristic for the inbound message.
Characteristic Value	Used to specify the value for the characteristic type. Note: If you select a predefined characteristic type, the Search (🔍) icon appears corresponding to the Characteristic Value field. On clicking the Search icon, the Predefined Characteristic Search window appears. On specifying the value for a predefined characteristic type, the description of the characteristic value appears corresponding to the Characteristic Value field.	Yes (Conditional) Note: This field is required when you are defining a characteristic for the inbound message.

2. Enter the required details in the **Characteristics** section.
3. If you want to define more than one characteristic for the inbound message, click the **Add** (+) icon and then repeat step 2.

Note: However, if you want to remove a characteristic from the inbound message, click the **Delete** (🗑️) icon corresponding to the characteristic.

4. Click **Save**.

The characteristics are defined for the inbound message.

Related Topics

For more information on...	See...
How to edit an inbound message	Editing an Inbound Message on page 2291

Deleting an Inbound Message

There might be situations when incorrect inbound messages are received in the system. In such case, the system provides you with an ability to delete the inbound message when it is not yet validated or processed. Note that you can delete an inbound message when the inbound message is in the **Pending** status.

Procedure

To delete an inbound message:

1. Search for the inbound message in the **Inbound Message** screen.
2. In the **Search Results** section, click the link in the **Inbound Message Information** column corresponding to the inbound message that you want to delete.

The **Inbound Message** screen appears.

3. Ensure that the **Main** tab is selected.
4. Click the **Delete** button in the **Inbound Message** zone.

A message appears confirming whether you want to delete the inbound message.

Note: The **Delete** button appears when the inbound message is in the **Pending** status.

5. Click **OK**.

The inbound message is deleted.

Related Topics

For more information on...	See...
How to search for an inbound message	Searching for an Inbound Message on page 2284
Inbound Message screen	Inbound Message (Used for Viewing) on page 2287
Inbound Message zone	Inbound Message on page 2287

Processing an Inbound Message

Prerequisites

The following table lists the prerequisites which you should setup before processing the respective inbound message:

Inbound Message	Refer to...
Health Care Inbound Message	Prerequisites on page 2085
Health Product and Plan Inbound Message	Prerequisites on page 2238

Procedure

To process an inbound message:

1. Search for the inbound message in the **Inbound Message** screen.
2. In the **Search Results** section, click the link in the **Inbound Message Information** column corresponding to the inbound message that you want to submit for validation and processing.

The **Inbound Message** screen appears.

3. Ensure that the **Main** tab is selected.
4. Click the **Submit for Processing** button in the **Inbound Message** zone.

The status of the inbound message is changed to **Validation** and the algorithms attached to the **Validation** status are invoked in the specified sequence. If the validation is successful, the status of the inbound message is changed to **Processing** and the algorithms attached to the **Processing** status are invoked in the specified sequence. The following table lists how the system behaves when the respective inbound message is processed:

If the inbound message is a...	Then...
Health Care Inbound Message	<p>Creates or updates a person, account and fully-insured group or self-funded policy. It creates or updates a policy plan, membership, and pass-through billable charge for a fully-insured group policy. In addition, if requested, it terminates, reinstates, or renews a fully-insured group policy. Finally, the status of the inbound message is changed to Processed.</p> <p>The system uses the C1-PERSTYPE feature configuration to decide whether the person type specified in the health care inbound message represents Parent Customer or Bill Group. If the person type specified in the health care inbound message matches the person type specified in the Bill Group Person Type or Parent Person Type option type of the C1-PERSTYPE feature configuration, the system creates or updates the person, account, policy, policy plan, and address through a customer registration object. Note that the memberships, pass-through billable charges, and pricing rules are created directly and not via customer registration object. However, if the person type specified in the health care inbound message does not match the person type specified in the Bill Group Person Type or Parent Person Type option type, the system creates or updates the person and its other entities directly and not through a customer registration object. In this case, the system only refers the customer registration type for the business objects using which the person, account, policy plan, membership, and address should be created or updated in the system.</p> <p>If the derivation and pricing parameters are specified for a bill group, the system automatically creates one sort record for the bill group. Here, the sort ID is set to the bill group ID. The start and end dates of the sort record are set to the bill group and parent customer's relationship start and end dates. Once the sort record is created, the system creates the derivation and pricing parameters for the bill group and sort ID combination.</p>

If the inbound message is a...	Then...
Health Product and Plan Inbound Message	<p>Creates or updates a health product, health plan, and pricing rules for individual memberships. In addition, it also maintains a log of the entities that are either added or updated through the health product and plan inbound message. Note that the system allows to upload the health product, health plan, and pricing rules together in a single inbound message or by creating three separate inbound messages. Finally, the status of the inbound message is changed to Processed.</p> <p>The system uses the C1-HLTPRDVAL algorithm to validate the uploaded data through the health product and plan inbound message. Once the data is successfully validated, entities like health product, health plan, and pricing rules are created in the system.</p>

However, if the validation or processing fails due to any reason, the status of the inbound message is changed to **Rejected** and the algorithms attached to the **Rejected** status are invoked in the specified sequence. A To Do is created using the To Do type specified in the **C1-TDCRINMSG** algorithm and assigned to the users with the To Do role specified in the **C1-TDCRINMSG** algorithm.

Note: The **Submit for Processing** button appears when the inbound message is in the **Pending** status.

Related Topics

For more information on...	See...
How to search for an inbound message	Searching for an Inbound Message on page 2284
Inbound Message screen	Inbound Message (Used for Viewing) on page 2287
Inbound Message zone	Inbound Message on page 2287

Using the Retry Option for an Inbound Message

If the validation or processing fails due to any reason, the status of the inbound message is changed to **Rejected**. The system enables you to resubmit the inbound messages for validation and processing on failure. However, to resubmit the inbound message for validation and processing, you need to change the status of the inbound message from **Rejected** to **Pending**. This is possible through using the **Retry** option.

Procedure

To use the retry option for an inbound message:

1. Search for the inbound message in the **Inbound Message** screen.
2. In the **Search Results** section, click the link in the **Inbound Message Information** column corresponding to the inbound message for which you want to use the retry option.

The **Inbound Message** screen appears.

3. Ensure that the **Main** tab is selected.
4. Ensure that the To Dos created for the inbound message are in the **Complete** status.
5. Click the **Retry** button in the **Inbound Message** zone.

The status of the inbound message is changed to **Pending**.

Note: The **Retry** button appears when the inbound message is in the **Rejected** status.

Related Topics

For more information on...	See...
How to search for an inbound message	Searching for an Inbound Message on page 2284
Inbound Message screen	Inbound Message (Used for Viewing) on page 2287
Inbound Message zone	Inbound Message on page 2287

Voiding an Inbound Message

There might be situations when incorrect inbound messages are received in the system. In such case, the system provides you with an ability to void or cancel the inbound message after the validation or processing fails. Note that you can void or cancel an inbound message when the inbound message is in the **Rejected** status.

Procedure

To void an inbound message:

1. Search for the inbound message in the **Inbound Message** screen.
2. In the **Search Results** section, click the link in the **Inbound Message Information** column corresponding to the inbound message that you want to void.

The **Inbound Message** screen appears.

3. Ensure that the **Main** tab is selected.
4. Click the **Void** button in the **Inbound Message** zone.

The status of the inbound message is changed to **Voided**.

Note: The **Void** button appears when the inbound message is in the **Rejected** status.

Related Topics

For more information on...	See...
How to search for an inbound message	Searching for an Inbound Message on page 2284
Inbound Message screen	Inbound Message (Used for Viewing) on page 2287
Inbound Message zone	Inbound Message on page 2287

Viewing the Content of an Inbound Message

Procedure

To view the content of an inbound message:

1. Search for the inbound message in the **Inbound Message** screen.
2. In the **Search Results** section, click the link in the **Inbound Message Information** column corresponding to the inbound message whose details you want to view.

The **Inbound Message** screen appears.

3. Click the **Message** tab.

The **Message** tab appears.

4. View the content of the inbound message in the XML format in the **Inbound Message Content** zone.

Related Topics

For more information on...	See...
How to search for an inbound message	Searching for an Inbound Message on page 2284
Inbound Message screen	Inbound Message (Used for Viewing) on page 2287
Inbound Message Content zone	Inbound Message Content on page 2289

Viewing the Log of an Inbound Message

Procedure

To view the log of an inbound message:

1. Search for the inbound message in the **Inbound Message** screen.
2. In the **Search Results** section, click the link in the **Inbound Message Information** column corresponding to the inbound message whose log you want to view.

The **Inbound Message** screen appears.

3. Click the **Log** tab.

The **Log** tab appears.

4. View the complete trail of actions performed on the inbound message in the **Inbound Message Log** zone.

Related Topics

For more information on...	See...
How to search for an inbound message	Searching for an Inbound Message on page 2284
Inbound Message screen	Inbound Message (Used for Viewing) on page 2287
Inbound Message Log zone	Inbound Message Log on page 2290
How to add a log entry for an inbound message	Adding a Log Entry for an Inbound Message on page 2297

Adding a Log Entry for an Inbound Message

Procedure

To add a log entry for an inbound message:

1. Search for the inbound message in the **Inbound Message** screen.
2. In the **Search Results** section, click the link in the **Inbound Message Information** column corresponding to the inbound message for which you want to add a log entry.

The **Inbound Message** screen appears.

3. Click the **Log** tab.

The **Log** tab appears.

4. Click the **Add Log Entry** link in the upper right corner of the **Inbound Message Log** zone.

The **Add Inbound Message Log** window appears. It contains the following fields:

Field Name	Field Description	Mandatory (Yes or No)
Inbound Message Information	Displays information about the inbound message.	Not applicable

Field Name	Field Description	Mandatory (Yes or No)
Log Details	Used to specify additional comments for the inbound message.	Yes

- Enter the comments in the **Log Details** field.
- Click **Save**.

The log entry is added in the **Inbound Message Log** zone.

Related Topics

For more information on...	See...
How to search for an inbound message	Searching for an Inbound Message on page 2284
Inbound Message screen	Inbound Message (Used for Viewing) on page 2287
Inbound Message Log zone	Inbound Message Log on page 2290

Statement Construct Preference

Oracle Revenue Management and Billing enables you to create and edit the statement construct of a person through a health care inbound message. However, note that you can create and edit the statement construct of only those persons through a health care inbound message whose record is created via a customer registration object. While creating or editing a statement construct, the system uses the statement construct business object of the customer registration type which is specified in the respective inbound message type.

If the data is not available in the following tags of a health care inbound message while creating a statement construct for a person, the system uses the default value from the respective attribute of the statement construct preference:

Tag Name	Considers Default Value from the Following Attribute...
statementAddressSource	Default Statement Address Source
effectiveStatus	Default Statement Status
statementCycle	Default Statement Cycle
statementFormat	Default Statement Format
statementRouteType	Default Statement Route Type
numberOfCopies	Default Statement Number of Copies

In addition, if the data is not available in the following tag of a health care inbound message while adding an account or contract in a statement construct, the system uses the default value from the respective attribute of the statement construct preference:

Tag Name	Considers Default Value from the Following Attribute...
printOrder	Default Statement Print Order

The system considers the statement construct preference which is specified in the **Field Mapping** parameter of the **C1-HCINPROC** algorithm. You can define, edit, delete, and copy a statement construct preference through the **Field Mapping** screen.

Related Topics

For more information on...	See...
C1-HCINPROC algorithm	C1-HCINPROC on page 2091

Searching for a Statement Construct Preference

Prerequisites

To search for a statement construct preference, you should have:

- Values defined in the **FIELD_CAT_FLG** lookup field

Procedure

To search for a statement construct preference:

1. Click the **Admin** link in the **Application** toolbar.
A list appears.
2. From the **Admin** menu, select **F** and then click **Field Mapping**.
A sub-menu appears.
3. Click the **Search** option from the **Field Mapping** sub-menu.
The **Field Mapping** screen appears.
4. Select the **Statement Construct** option from the **Preference Category** list.
5. Enter the additional search criteria in the **Search Field Mapping** zone.

Note: ORMB search engine supports wildcard search, where you can substitute the percentage (%) symbol as a stand in for any word or letter in a search criteria. You can use the ‘%’ wildcard character in all input fields except the date and ID fields. The ‘%’ wildcard character is suffixed automatically at the end of the partial search criteria. Therefore, you may or may not specify the wildcard character at the end of the partial search criteria. However, you have to prefix the wildcard character manually wherever required.

6. Click **Search**.
A list of statement construct preferences that meet the search criteria appears in the **Search Results** section.

Viewing the Statement Construct Preference Details

Procedure

To view the details of a statement construct preference:

1. Search for the statement construct preference in the **Field Mapping** screen.
2. In the **Search Results** section, click the **Broadcast** (📡) icon corresponding to the statement construct preference whose details you want to view.
The **Field Mapping** zone appears.
3. View the details of the statement construct preference in the **Field Mapping** zone.

Related Topics

For more information on...	See...
How to search for a statement construct preference	Searching for a Statement Construct Preference on page 2299

Defining a Statement Construct Preference

Prerequisites

To define a statement construct preference, you should have:

- Values defined in the **STM_ADDR_SRC_FLG**, **STM_FORMAT_FLG**, and **MAP_ENTITY_FLG** lookup fields
- Statement cycles and statement route types defined in the application

Procedure

To define a statement construct preference:

1. Click the **Admin** link in the **Application** toolbar.
A list appears.
2. From the **Admin** menu, select **F** and then click **Field Mapping**.
A sub-menu appears.
3. Click the **Add** option from the **Field Mapping** sub-menu.

The **Select Business Object** screen appears. It contains the following field:

Field Name	Field Description	Mandatory (Yes or No)
Field Mapping Business Object	Used to indicate the business object using which you want to create the statement construct preference. The valid values are: <ul style="list-style-type: none"> • Field Mapping • Medicare Plan Benefit Package • Membership Status Reason Mapping 	Yes

Note: Alternatively, you can access the **Select Business Object** screen by clicking the **Add** button in the **Page Title** area of the **Field Mapping** screen.

4. Select the **Field Mapping** option from the **Field Mapping Business Object** list.
5. Click **OK**.

The **Field Mapping** screen appears. It contains the following sections:

- **Main** - Used to specify basic details of the statement construct preference. It contains the following fields:

Field Name	Field Description	Mandatory (Yes or No)
Preference	Used to specify the statement construct preference.	Yes
Description	Used to specify the description for the statement construct preference.	Yes
Detailed Description	Used to specify additional information about the statement construct preference.	No
Status	Used to indicate the status of the statement construct preference. The valid values are: <ul style="list-style-type: none"> • Active • Inactive 	Yes

- **Preference Category** - This section contains the following field:

Field Name	Field Description	Mandatory (Yes or No)
Preference Category	Used to indicate the category to which the preference belongs. The valid values are: <ul style="list-style-type: none"> • Billing • Binder Payment • Geographic Rating Area • Individual Membership • Medicare • Medicare Plan Benefit • Member Reconciliation • Member Relationship and Subscription Tier • Membership Status Reason • Statement Construct 	Yes

- **Preference Settings** - Used to set the attributes in the statement construct preference. It contains the following fields in a grid:

Field Name	Field Description	Mandatory (Yes or No)
Attribute	<p>Used to indicate the attribute which you want to set in the statement construct preference. The valid values are:</p> <ul style="list-style-type: none"> • Default Statement Address Source - Used when the address source is not specified while creating a statement construct through a health care inbound message. • Default Statement Status - Used when the status is not specified while creating a statement construct through a health care inbound message. • Default Statement Cycle - Used when the statement cycle is not specified while creating a statement construct through a health care inbound message. • Default Statement Format - Used when the statement format is not specified while creating a statement construct through a health care inbound message. • Default Statement Route Type - Used when the statement route type is not specified while creating a statement construct through a health care inbound message. • Default Statement Number of Copies - Used when the number of statement copies is not specified while creating a statement construct through a health care inbound message. • Default Statement Print Order - Used when the print order is not specified for an account or contract while creating or updating a statement construct through a health care inbound message. 	<p>Yes (Conditional)</p> <p>Note: This field is required while setting an attribute in the statement construct preference.</p>

Field Name	Field Description	Mandatory (Yes or No)		
Value	Used to specify the attribute value. The attribute value that you can specify varies depending on the attribute you want to set in the statement construct preference:	Yes (Conditional)		
		<p>Note: This field is required while setting an attribute in the statement construct preference.</p>		
			<p>If the attribute is set to...</p>	<p>Then, this field is...</p>
			<p>Default Statement Address Source</p>	<p>Used to indicate the source whose address should be used for sending the statements to the person. The valid value is:</p> <ul style="list-style-type: none"> • Person <p>Note: The list includes only those values which are defined in the STM_ADDR_SRC_FLG lookup field.</p>
			<p>Default Statement Status</p>	<p>Used to indicate the status of the statement construct. The valid values are:</p> <ul style="list-style-type: none"> • Active • Inactive
			<p>Default Statement Cycle</p>	<p>Used to indicate when statements should be generated for the statement construct.</p> <p>Note: The list includes only those statement cycles which are already defined in the system.</p>
<p>Default Statement Format</p>	<p>Used to indicate the format in which the statements should be printed. The valid values are:</p> <ul style="list-style-type: none"> • Detail • Summary <p>Note: The list includes only those values which are defined in the STM_FORMAT_FLG lookup field.</p>			

Field Name	Field Description	Mandatory (Yes or No)						
	<table border="1"> <tr> <td data-bbox="638 254 865 537">Default Statement Route Type</td> <td data-bbox="865 254 1175 537"> Used to indicate how to route the statements to the person. Note: The list includes only those statement route types which are already defined in the system. </td> </tr> <tr> <td data-bbox="638 537 865 821">Default Statement Number of Copies</td> <td data-bbox="865 537 1175 821"> Used to indicate how many copies of the statement should be sent to the person. Note: You must specify a positive integer for this attribute. </td> </tr> <tr> <td data-bbox="638 821 865 1178">Default Statement Print Order</td> <td data-bbox="865 821 1175 1178"> Used to indicate the order in which the financial transactions associated with the account or contract should appear on the printed statement. Note: You must specify a positive integer for this attribute. </td> </tr> </table>	Default Statement Route Type	Used to indicate how to route the statements to the person. Note: The list includes only those statement route types which are already defined in the system.	Default Statement Number of Copies	Used to indicate how many copies of the statement should be sent to the person. Note: You must specify a positive integer for this attribute.	Default Statement Print Order	Used to indicate the order in which the financial transactions associated with the account or contract should appear on the printed statement. Note: You must specify a positive integer for this attribute.	
Default Statement Route Type	Used to indicate how to route the statements to the person. Note: The list includes only those statement route types which are already defined in the system.							
Default Statement Number of Copies	Used to indicate how many copies of the statement should be sent to the person. Note: You must specify a positive integer for this attribute.							
Default Statement Print Order	Used to indicate the order in which the financial transactions associated with the account or contract should appear on the printed statement. Note: You must specify a positive integer for this attribute.							
Entity Type	<p>Used to indicate the type of entity for which the attribute is applicable. The valid values are:</p> <ul style="list-style-type: none"> • Account • Billable Charge <p>Note: At present, this data is stored for informational purposes only and is not considered in the business logic. If required, you can add more entity types to the MAP_ENTITY_FLG lookup field.</p>	No						

Note: While defining a statement construct preference, you must set at least one attribute in the statement construct preference.

6. Select the **Statement Construct** option from the **Preference Category** list.
7. Enter the required details in the **Main** section.
8. Select the required attribute and value from the respective fields.
9. If you want to set more than one attribute in the statement construct preference, click the **Add (+)** icon and then repeat step 8.

Note: However, if you want to remove an attribute from the statement construct preference, click the **Delete** (🗑️) icon corresponding to the attribute.

10. Click Save.

The statement construct preference is defined.

Editing a Statement Construct Preference

Prerequisites

To edit a statement construct preference, you should have:

- Values defined in the **STM_ADDR_SRC_FLG**, **STM_FORMAT_FLG**, and **MAP_ENTITY_FLG** lookup fields
- Statement cycles and statement route types defined in the application

Procedure

To edit a statement construct preference:

1. Search for the statement construct preference in the **Field Mapping** screen.
2. In the **Search Results** section, click the **Edit** (✎) icon in the **Edit** column corresponding to the statement construct preference whose details you want to edit.

The **Field Mapping** screen appears. It contains the following sections:

- **Main** - Used to specify basic details of the statement construct preference. It contains the following fields:

Field Name	Field Description	Mandatory (Yes or No)
Preference	Displays the statement construct preference.	Not applicable
Description	Used to specify the description for the statement construct preference.	Yes
Detailed Description	Used to specify additional information about the statement construct preference.	No
Status	Used to indicate the status of the statement construct preference. The valid values are: <ul style="list-style-type: none"> • Active • Inactive 	Yes
Preference Category	Indicates the category to which the preference belongs. The valid value is: <ul style="list-style-type: none"> • Statement Construct 	Not applicable

- **Preference Settings** - Used to set the attributes in the statement construct preference. It contains the following fields in a grid:

Field Name	Field Description	Mandatory (Yes or No)
Attribute	<p>Used to indicate the attribute which you want to set in the statement construct preference. The valid values are:</p> <ul style="list-style-type: none"> • Default Statement Address Source - Used when the address source is not specified while creating a statement construct through a health care inbound message. • Default Statement Status - Used when the status is not specified while creating a statement construct through a health care inbound message. • Default Statement Cycle - Used when the statement cycle is not specified while creating a statement construct through a health care inbound message. • Default Statement Format - Used when the statement format is not specified while creating a statement construct through a health care inbound message. • Default Statement Route Type - Used when the statement route type is not specified while creating a statement construct through a health care inbound message. • Default Statement Number of Copies - Used when the number of statement copies is not specified while creating a statement construct through a health care inbound message. • Default Statement Print Order - Used when the print order is not specified for an account or contract while creating or updating a statement construct through a health care inbound message. 	<p>Yes (Conditional)</p> <p>Note: This field is required while setting an attribute in the statement construct preference.</p>

Field Name	Field Description	Mandatory (Yes or No)		
Value	Used to specify the attribute value. The attribute value that you can specify varies depending on the attribute you want to set in the statement construct preference:	Yes (Conditional)		
	<table border="1"> <thead> <tr> <th data-bbox="639 396 867 474">If the attribute is set to...</th> <th data-bbox="867 396 1179 474">Then, this field is...</th> </tr> </thead> </table>	If the attribute is set to...	Then, this field is...	Note: This field is required while setting an attribute in the statement construct preference.
	If the attribute is set to...	Then, this field is...		
	Default Statement Address Source	Used to indicate the source whose address should be used for sending the statements to the person. The valid value is: <ul style="list-style-type: none"> • Person Note: The list includes only those values which are defined in the STM_ADDR_SRC_FLG lookup field.		
	Default Statement Status	Used to indicate the status of the statement construct. The valid values are: <ul style="list-style-type: none"> • Active • Inactive 		
	Default Statement Cycle	Used to indicate when statements should be generated for the statement construct. Note: The list includes only those statement cycles which are already defined in the system.		
Default Statement Format	Used to indicate the format in which the statements should be printed. The valid values are: <ul style="list-style-type: none"> • Detail • Summary Note: The list includes only those values which are defined in the STM_FORMAT_FLG lookup field.			

Field Name	Field Description	Mandatory (Yes or No)						
	<table border="1"> <tr> <td>Default Statement Route Type</td> <td>Used to indicate how to route the statements to the person. Note: The list includes only those statement route types which are already defined in the system.</td> </tr> <tr> <td>Default Statement Number of Copies</td> <td>Used to indicate how many copies of the statement should be sent to the person. Note: You must specify a positive integer for this attribute.</td> </tr> <tr> <td>Default Statement Print Order</td> <td>Used to indicate the order in which the financial transactions associated with the account or contract should appear on the printed statement. Note: You must specify a positive integer for this attribute.</td> </tr> </table>	Default Statement Route Type	Used to indicate how to route the statements to the person. Note: The list includes only those statement route types which are already defined in the system.	Default Statement Number of Copies	Used to indicate how many copies of the statement should be sent to the person. Note: You must specify a positive integer for this attribute.	Default Statement Print Order	Used to indicate the order in which the financial transactions associated with the account or contract should appear on the printed statement. Note: You must specify a positive integer for this attribute.	
Default Statement Route Type	Used to indicate how to route the statements to the person. Note: The list includes only those statement route types which are already defined in the system.							
Default Statement Number of Copies	Used to indicate how many copies of the statement should be sent to the person. Note: You must specify a positive integer for this attribute.							
Default Statement Print Order	Used to indicate the order in which the financial transactions associated with the account or contract should appear on the printed statement. Note: You must specify a positive integer for this attribute.							
Entity Type	<p>Used to indicate the type of entity for which the attribute is applicable. The valid values are:</p> <ul style="list-style-type: none"> Account Billable Charge <p>Note: At present, this data is stored for informational purposes only and is not considered in the business logic. If required, you can add more entity types to the MAP_ENTITY_FLG lookup field.</p>	No						

Tip: Alternatively, you can edit the details of a statement construct preference by clicking the **Edit** button in the **Field Mapping** zone.

3. Modify the required details in the **Main** section.
4. Define, edit, or remove the attribute from the statement construct preference, if required.

Note: You must set at least one attribute in a statement construct preference.

5. Click **Save**.

The changes made to the statement construct preference are saved.

Related Topics

For more information on...	See...
How to search for a statement construct preference	Searching for a Statement Construct Preference on page 2299

Copying a Statement Construct Preference

Instead of creating a statement construct preference from scratch, you can create a new statement construct preference using an existing statement construct preference. This is possible through copying a statement construct preference. On copying a statement construct preference, the details including the attributes are copied to the new statement construct preference. You can then edit the details, if required.

Prerequisites

To copy a statement construct preference, you should have:

- Statement construct preference (whose copy you want to create) defined in the application
- Values defined in the **STM_ADDR_SRC_FLG**, **STM_FORMAT_FLG**, and **MAP_ENTITY_FLG** lookup fields
- Statement cycles and statement route types defined in the application

Procedure

To copy a statement construct preference:

1. Search for the statement construct preference in the **Field Mapping** screen.
2. In the **Search Results** section, click the **Duplicate** (📄) icon in the **Duplicate** column corresponding to the statement construct preference whose copy you want to create.

The **Field Mapping** screen appears. It contains the following sections:

- **Main** - Used to specify basic details of the statement construct preference. It contains the following fields:

Field Name	Field Description	Mandatory (Yes or No)
Preference	Used to specify the statement construct preference.	Yes
Description	Used to specify the description for the statement construct preference.	Yes
Detailed Description	Used to specify additional information about the statement construct preference.	No
Status	Used to indicate the status of the statement construct preference. The valid values are: <ul style="list-style-type: none"> • Active • Inactive 	Yes
Preference Category	Indicates the category to which the preference belongs. The valid value is: <ul style="list-style-type: none"> • Statement Construct 	Not applicable

- **Preference Settings** - Used to set the attributes in the statement construct preference. It contains the following fields in a grid:

Field Name	Field Description	Mandatory (Yes or No)
Attribute	<p>Used to indicate the attribute which you want to set in the statement construct preference. The valid values are:</p> <ul style="list-style-type: none"> • Default Statement Address Source - Used when the address source is not specified while creating a statement construct through a health care inbound message. • Default Statement Status - Used when the status is not specified while creating a statement construct through a health care inbound message. • Default Statement Cycle - Used when the statement cycle is not specified while creating a statement construct through a health care inbound message. • Default Statement Format - Used when the statement format is not specified while creating a statement construct through a health care inbound message. • Default Statement Route Type - Used when the statement route type is not specified while creating a statement construct through a health care inbound message. • Default Statement Number of Copies - Used when the number of statement copies is not specified while creating a statement construct through a health care inbound message. • Default Statement Print Order - Used when the print order is not specified for an account or contract while creating or updating a statement construct through a health care inbound message. 	<p>Yes (Conditional)</p> <p>Note: This field is required while setting an attribute in the statement construct preference.</p>

Field Name	Field Description	Mandatory (Yes or No)											
Value	Used to specify the attribute value. The attribute value that you can specify varies depending on the attribute you want to set in the statement construct preference:	Yes (Conditional)											
		<p>Note: This field is required while setting an attribute in the statement construct preference.</p>	<table border="1"> <thead> <tr> <th data-bbox="634 396 867 474">If the attribute is set to...</th> <th data-bbox="867 396 1175 474">Then, this field is...</th> </tr> </thead> <tbody> <tr> <td data-bbox="634 474 867 898">Default Statement Address Source</td> <td data-bbox="867 474 1175 898"> Used to indicate the source whose address should be used for sending the statements to the person. The valid value is: <ul style="list-style-type: none"> • Person <p>Note: The list includes only those values which are defined in the STM_ADDR_SRC_FLG lookup field.</p> </td> </tr> <tr> <td data-bbox="634 898 867 1119">Default Statement Status</td> <td data-bbox="867 898 1175 1119"> Used to indicate the status of the statement construct. The valid values are: <ul style="list-style-type: none"> • Active • Inactive </td> </tr> <tr> <td data-bbox="634 1119 867 1438">Default Statement Cycle</td> <td data-bbox="867 1119 1175 1438"> Used to indicate when statements should be generated for the statement construct. <p>Note: The list includes only those statement cycles which are already defined in the system.</p> </td> </tr> <tr> <td data-bbox="634 1438 867 1892">Default Statement Format</td> <td data-bbox="867 1438 1175 1892"> Used to indicate the format in which the statements should be printed. The valid values are: <ul style="list-style-type: none"> • Detail • Summary <p>Note: The list includes only those values which are defined in the STM_FORMAT_FLG lookup field.</p> </td> </tr> </tbody> </table>	If the attribute is set to...	Then, this field is...	Default Statement Address Source	Used to indicate the source whose address should be used for sending the statements to the person. The valid value is: <ul style="list-style-type: none"> • Person <p>Note: The list includes only those values which are defined in the STM_ADDR_SRC_FLG lookup field.</p>	Default Statement Status	Used to indicate the status of the statement construct. The valid values are: <ul style="list-style-type: none"> • Active • Inactive 	Default Statement Cycle	Used to indicate when statements should be generated for the statement construct. <p>Note: The list includes only those statement cycles which are already defined in the system.</p>	Default Statement Format	Used to indicate the format in which the statements should be printed. The valid values are: <ul style="list-style-type: none"> • Detail • Summary <p>Note: The list includes only those values which are defined in the STM_FORMAT_FLG lookup field.</p>
			If the attribute is set to...	Then, this field is...									
			Default Statement Address Source	Used to indicate the source whose address should be used for sending the statements to the person. The valid value is: <ul style="list-style-type: none"> • Person <p>Note: The list includes only those values which are defined in the STM_ADDR_SRC_FLG lookup field.</p>									
			Default Statement Status	Used to indicate the status of the statement construct. The valid values are: <ul style="list-style-type: none"> • Active • Inactive 									
			Default Statement Cycle	Used to indicate when statements should be generated for the statement construct. <p>Note: The list includes only those statement cycles which are already defined in the system.</p>									
Default Statement Format	Used to indicate the format in which the statements should be printed. The valid values are: <ul style="list-style-type: none"> • Detail • Summary <p>Note: The list includes only those values which are defined in the STM_FORMAT_FLG lookup field.</p>												
Default Statement Address Source	Used to indicate the source whose address should be used for sending the statements to the person. The valid value is: <ul style="list-style-type: none"> • Person <p>Note: The list includes only those values which are defined in the STM_ADDR_SRC_FLG lookup field.</p>												
Default Statement Status	Used to indicate the status of the statement construct. The valid values are: <ul style="list-style-type: none"> • Active • Inactive 												
Default Statement Cycle	Used to indicate when statements should be generated for the statement construct. <p>Note: The list includes only those statement cycles which are already defined in the system.</p>												
Default Statement Format	Used to indicate the format in which the statements should be printed. The valid values are: <ul style="list-style-type: none"> • Detail • Summary <p>Note: The list includes only those values which are defined in the STM_FORMAT_FLG lookup field.</p>												

Field Name	Field Description	Mandatory (Yes or No)						
	<table border="1"> <tr> <td data-bbox="638 254 865 537">Default Statement Route Type</td> <td data-bbox="865 254 1177 537"> <p>Used to indicate how to route the statements to the person.</p> <p>Note: The list includes only those statement route types which are already defined in the system.</p> </td> </tr> <tr> <td data-bbox="638 537 865 821">Default Statement Number of Copies</td> <td data-bbox="865 537 1177 821"> <p>Used to indicate how many copies of the statement should be sent to the person.</p> <p>Note: You must specify a positive integer for this attribute.</p> </td> </tr> <tr> <td data-bbox="638 821 865 1178">Default Statement Print Order</td> <td data-bbox="865 821 1177 1178"> <p>Used to indicate the order in which the financial transactions associated with the account or contract should appear on the printed statement.</p> <p>Note: You must specify a positive integer for this attribute.</p> </td> </tr> </table>	Default Statement Route Type	<p>Used to indicate how to route the statements to the person.</p> <p>Note: The list includes only those statement route types which are already defined in the system.</p>	Default Statement Number of Copies	<p>Used to indicate how many copies of the statement should be sent to the person.</p> <p>Note: You must specify a positive integer for this attribute.</p>	Default Statement Print Order	<p>Used to indicate the order in which the financial transactions associated with the account or contract should appear on the printed statement.</p> <p>Note: You must specify a positive integer for this attribute.</p>	
Default Statement Route Type	<p>Used to indicate how to route the statements to the person.</p> <p>Note: The list includes only those statement route types which are already defined in the system.</p>							
Default Statement Number of Copies	<p>Used to indicate how many copies of the statement should be sent to the person.</p> <p>Note: You must specify a positive integer for this attribute.</p>							
Default Statement Print Order	<p>Used to indicate the order in which the financial transactions associated with the account or contract should appear on the printed statement.</p> <p>Note: You must specify a positive integer for this attribute.</p>							
Entity Type	<p>Used to indicate the type of entity for which the attribute is applicable. The valid values are:</p> <ul style="list-style-type: none"> • Account • Billable Charge <p>Note: At present, this data is stored for informational purposes only and is not considered in the business logic. If required, you can add more entity types to the MAP_ENTITY_FLG lookup field.</p>	No						

Note: While defining a statement construct preference, you must set at least one attribute in the statement construct preference.

Tip: Alternatively, you can copy a statement construct preference by clicking the **Duplicate** button in the **Field Mapping** zone.

3. Enter the required details in the **Main** section.
4. Define, edit, or remove the attribute from the statement construct preference, if required.
5. Click **Save**.

The new statement construct preference is defined.

Related Topics

For more information on...	See...
How to search for a statement construct preference	Searching for a Statement Construct Preference on page 2299

Deleting a Statement Construct Preference

Procedure

To delete a statement construct preference:

1. Search for the statement construct preference in the **Field Mapping** screen.
2. In the **Search Results** section, click the **Delete** (🗑️) icon in the **Delete** column corresponding to the statement construct preference that you want to delete.

A message appears confirming whether you want to delete the statement construct preference.

Tip: Alternatively, you can delete a statement construct preference by clicking the **Delete** button in the **Field Mapping** zone.

3. Click **OK**.

The statement construct preference is deleted.

Related Topics

For more information on...	See...
How to search for a statement construct preference	Searching for a Statement Construct Preference on page 2299

Chapter 31

Upload Lockbox Payment and Remittance Advices Overview

Topics:

- [Prerequisites](#)
- [EDI 820 Flat File Description](#)
- [Sample EDI 820 Flat File](#)
- [Upload EDI 820 Files in ORMB](#)

Oracle Revenue Management and Billing enables you to upload lockbox payment and remittance advices received in the **Electronic Data Exchange (EDI) 820** format. Under this feature, the payments made by customers are directed to a special post office box instead of going to the company directly. The bank goes to this post office box, retrieves the payments, processes them and deposits the funds directly into the company's bank account.

An EDI 820 payment order or remittance advice is an electronic document that can be used to initiate payments and send remittance information. EDI 820 sends information to vendor furnishing details of payment for his supplies. A remittance advice is a note sent from a customer to their supplier, informing the supplier that they have paid their invoice. The advice may contain elements such as a text note, the invoice number and the invoice amount, among others. Remittance advice is not required, but they are seen as a courtesy since they make it easier for the supplier to match invoices with payments.

To enable this feature, lockbox payment files are required to be uploaded on ORMB and these files have to be allocated to the appropriate accounts. To support multiple lines of business, the lockbox upload needs to:

- Consider the primary identifier when looking for a source customer number match. For customers having multiple source system identifiers, the lockbox process only matches against the one identified as primary customer.
- Incorporate the payment allocation logic in the system on the basis of which the lockbox uploads the payments for the identified customer.

To support remittances which can split a tender across multiple customers:

- Allow source customer number or tax id to be provided as remittance (RMR) values. In case of multiple source customer number or tax id, remittance values are provided for a single tender, the account associated with the first remittance value is set as the payor account. If there is at least one remittance value where a single customer account cannot be determined, the entire tender is placed into general suspense.
- A new payment upload batch **C1-PUPSG** is developed to read lockbox payment files from the bank and load the payment details into the ORMB payment upload staging tables for processing.
- Once the text file is uploaded, the deposit control staging, tender control staging, and payment upload staging records are created in the respective tables. You can then execute the **Payment Upload (PUPL)** batch to create the deposit control, tender controls, payment events, tenders,

payments, and payment segments using payment records in the staging area.

Note: For more information about the batches, refer to the *Oracle Revenue Management and Billing Batch Guide*.

Related Topics

For more information on...	See...
Prerequisites	Prerequisites on page 2317
EDI 820 Flat File Description	EDI 820 Flat File Description on page 2317
Sample EDI 820 Flat File	Sample EDI 820 Flat File on page 2319
Upload EDI 820 Files in ORMB	Upload EDI 820 Files in ORMB on page 2320

Prerequisites

To setup the upload lockbox payment process, you need to do the following:

- Define the values in the parameters of the **C1-CCPYTSADS** and **C1-MATSATYP** algorithms.
- Lockbox tender types defined in the **C1_LBX_TENDER_TYPE** lookup field.
- Lockbox record type, lockbox reference identification qualifier, and lockbox remittance identification types defined in the **C1_LBX_820_RECORD_TYPE**, **C1_LBX_REF_IDQ_LKP**, and **C1_LBX_RMR_ID_TYPE** lookup fields respectively.

EDI 820 Flat File Description

Following is the description of the key field segments in the EDI 820 flat file format:

Field Name	Description
External Source ID	Uniquely identifies the lockbox.
External Transmission ID	Uniquely identifies the transmission. To ensure this transmission, the date component (such as, 20150813) should match the deposit date and there should only be one file per deposit date.
External Batch ID	Uniquely identifies the batch of payments in a transmission. To ensure these payments, if there are multiple ST records in a file, the transaction set control number (such as, 0101, 0202, ..) should be unique.

Field Name	Description																										
Payment Transaction	<p data-bbox="516 212 1414 239">The following table describes the fields that are included in the payment transaction:</p> <table border="1" data-bbox="516 262 1463 1818"> <thead> <tr> <th data-bbox="516 262 808 312">Field</th> <th data-bbox="816 262 1463 312">Description</th> </tr> </thead> <tbody> <tr> <td data-bbox="516 319 808 562">Attributes</td> <td data-bbox="816 319 1463 562"> <p data-bbox="824 325 1373 352">Following are the attributes of payment transaction:</p> <ul data-bbox="849 373 1073 541" style="list-style-type: none"> • Payment Amount • Payment Method • Payment Date • Payor Name </td> </tr> <tr> <td data-bbox="516 569 808 1457">Reference Records</td> <td data-bbox="816 569 1463 1457"> <p data-bbox="824 575 1446 695">Uniquely identifies the transaction. This is retrieved from different reference records based on the payment method. The following table indicates the external reference ID based on the payment methods used in the transaction:</p> <table border="1" data-bbox="824 720 1446 1436"> <thead> <tr> <th data-bbox="824 720 1094 800">External Reference ID Value</th> <th data-bbox="1102 720 1446 800">Description</th> </tr> </thead> <tbody> <tr> <td data-bbox="824 806 1094 947">ACH</td> <td data-bbox="1102 806 1446 947">Use the automated clearinghouse trace number. (Reference Identifier Code is 8G).</td> </tr> <tr> <td data-bbox="824 953 1094 1062">CHK</td> <td data-bbox="1102 953 1446 1062">Use the transaction reference number. (Reference Identifier Code TN).</td> </tr> <tr> <td data-bbox="824 1068 1094 1209">FWT</td> <td data-bbox="1102 1068 1446 1209">Use the FEDWIRE confirmation number. (Reference Identifier Code 8I).</td> </tr> <tr> <td data-bbox="824 1215 1094 1325">CAS</td> <td data-bbox="1102 1215 1446 1325">Use the transaction reference number. (Reference Identifier Code TN).</td> </tr> <tr> <td data-bbox="824 1331 1094 1440">OBP</td> <td data-bbox="1102 1331 1446 1440">Use the online payment trace number. (Reference Identifier Code 8G).</td> </tr> </tbody> </table> </td> </tr> <tr> <td data-bbox="516 1463 808 1572">Source Customer Number</td> <td data-bbox="816 1463 1463 1572">Uniquely identifies the customer. This is retrieved from the internal customer number reference record. (Reference Identifier Code is IT).</td> </tr> <tr> <td data-bbox="516 1579 808 1654">MICR</td> <td data-bbox="816 1579 1463 1654">Uniquely identifies the MICR. (Reference Identifier Code is MICR)</td> </tr> <tr> <td data-bbox="516 1661 808 1736">Check Number</td> <td data-bbox="816 1661 1463 1736">Uniquely identifies the check number. (Reference Identifier Code is CK)</td> </tr> <tr> <td data-bbox="516 1743 808 1818">Taxpayer Identification Number</td> <td data-bbox="816 1743 1463 1818">Uniquely Identifies the taxpayer. (Reference Identifier Code is EI)</td> </tr> </tbody> </table>	Field	Description	Attributes	<p data-bbox="824 325 1373 352">Following are the attributes of payment transaction:</p> <ul data-bbox="849 373 1073 541" style="list-style-type: none"> • Payment Amount • Payment Method • Payment Date • Payor Name 	Reference Records	<p data-bbox="824 575 1446 695">Uniquely identifies the transaction. This is retrieved from different reference records based on the payment method. The following table indicates the external reference ID based on the payment methods used in the transaction:</p> <table border="1" data-bbox="824 720 1446 1436"> <thead> <tr> <th data-bbox="824 720 1094 800">External Reference ID Value</th> <th data-bbox="1102 720 1446 800">Description</th> </tr> </thead> <tbody> <tr> <td data-bbox="824 806 1094 947">ACH</td> <td data-bbox="1102 806 1446 947">Use the automated clearinghouse trace number. (Reference Identifier Code is 8G).</td> </tr> <tr> <td data-bbox="824 953 1094 1062">CHK</td> <td data-bbox="1102 953 1446 1062">Use the transaction reference number. (Reference Identifier Code TN).</td> </tr> <tr> <td data-bbox="824 1068 1094 1209">FWT</td> <td data-bbox="1102 1068 1446 1209">Use the FEDWIRE confirmation number. (Reference Identifier Code 8I).</td> </tr> <tr> <td data-bbox="824 1215 1094 1325">CAS</td> <td data-bbox="1102 1215 1446 1325">Use the transaction reference number. (Reference Identifier Code TN).</td> </tr> <tr> <td data-bbox="824 1331 1094 1440">OBP</td> <td data-bbox="1102 1331 1446 1440">Use the online payment trace number. (Reference Identifier Code 8G).</td> </tr> </tbody> </table>	External Reference ID Value	Description	ACH	Use the automated clearinghouse trace number. (Reference Identifier Code is 8G).	CHK	Use the transaction reference number. (Reference Identifier Code TN).	FWT	Use the FEDWIRE confirmation number. (Reference Identifier Code 8I).	CAS	Use the transaction reference number. (Reference Identifier Code TN).	OBP	Use the online payment trace number. (Reference Identifier Code 8G).	Source Customer Number	Uniquely identifies the customer. This is retrieved from the internal customer number reference record. (Reference Identifier Code is IT).	MICR	Uniquely identifies the MICR. (Reference Identifier Code is MICR)	Check Number	Uniquely identifies the check number. (Reference Identifier Code is CK)	Taxpayer Identification Number	Uniquely Identifies the taxpayer. (Reference Identifier Code is EI)
Field	Description																										
Attributes	<p data-bbox="824 325 1373 352">Following are the attributes of payment transaction:</p> <ul data-bbox="849 373 1073 541" style="list-style-type: none"> • Payment Amount • Payment Method • Payment Date • Payor Name 																										
Reference Records	<p data-bbox="824 575 1446 695">Uniquely identifies the transaction. This is retrieved from different reference records based on the payment method. The following table indicates the external reference ID based on the payment methods used in the transaction:</p> <table border="1" data-bbox="824 720 1446 1436"> <thead> <tr> <th data-bbox="824 720 1094 800">External Reference ID Value</th> <th data-bbox="1102 720 1446 800">Description</th> </tr> </thead> <tbody> <tr> <td data-bbox="824 806 1094 947">ACH</td> <td data-bbox="1102 806 1446 947">Use the automated clearinghouse trace number. (Reference Identifier Code is 8G).</td> </tr> <tr> <td data-bbox="824 953 1094 1062">CHK</td> <td data-bbox="1102 953 1446 1062">Use the transaction reference number. (Reference Identifier Code TN).</td> </tr> <tr> <td data-bbox="824 1068 1094 1209">FWT</td> <td data-bbox="1102 1068 1446 1209">Use the FEDWIRE confirmation number. (Reference Identifier Code 8I).</td> </tr> <tr> <td data-bbox="824 1215 1094 1325">CAS</td> <td data-bbox="1102 1215 1446 1325">Use the transaction reference number. (Reference Identifier Code TN).</td> </tr> <tr> <td data-bbox="824 1331 1094 1440">OBP</td> <td data-bbox="1102 1331 1446 1440">Use the online payment trace number. (Reference Identifier Code 8G).</td> </tr> </tbody> </table>	External Reference ID Value	Description	ACH	Use the automated clearinghouse trace number. (Reference Identifier Code is 8G).	CHK	Use the transaction reference number. (Reference Identifier Code TN).	FWT	Use the FEDWIRE confirmation number. (Reference Identifier Code 8I).	CAS	Use the transaction reference number. (Reference Identifier Code TN).	OBP	Use the online payment trace number. (Reference Identifier Code 8G).														
External Reference ID Value	Description																										
ACH	Use the automated clearinghouse trace number. (Reference Identifier Code is 8G).																										
CHK	Use the transaction reference number. (Reference Identifier Code TN).																										
FWT	Use the FEDWIRE confirmation number. (Reference Identifier Code 8I).																										
CAS	Use the transaction reference number. (Reference Identifier Code TN).																										
OBP	Use the online payment trace number. (Reference Identifier Code 8G).																										
Source Customer Number	Uniquely identifies the customer. This is retrieved from the internal customer number reference record. (Reference Identifier Code is IT).																										
MICR	Uniquely identifies the MICR. (Reference Identifier Code is MICR)																										
Check Number	Uniquely identifies the check number. (Reference Identifier Code is CK)																										
Taxpayer Identification Number	Uniquely Identifies the taxpayer. (Reference Identifier Code is EI)																										

Field Name	Description												
Remittance Advice	he following table describes the fields that are involved in the remittance advice:												
	<table border="1"> <thead> <tr> <th>Field</th> <th>Description</th> </tr> </thead> <tbody> <tr> <td>Attributes</td> <td> Following are the attributes: <ul style="list-style-type: none"> • Invoice Number • Payment Amount </td> </tr> <tr> <td>Reference Records</td> <td> Uniquely identifies the remittance advice. The following table indicates the external reference ID based on the payment methods used in the remittance advice: <table border="1"> <thead> <tr> <th>External Reference ID Value</th> <th>Description</th> </tr> </thead> <tbody> <tr> <td>Billing Account ID</td> <td>Uniquely identifies the account. (Reference Identifier Code is I2).</td> </tr> <tr> <td>Bill Group ID</td> <td>Uniquely identifies the billing group. (Reference Identifier Code is U1).</td> </tr> </tbody> </table> </td> </tr> </tbody> </table>	Field	Description	Attributes	Following are the attributes: <ul style="list-style-type: none"> • Invoice Number • Payment Amount 	Reference Records	Uniquely identifies the remittance advice. The following table indicates the external reference ID based on the payment methods used in the remittance advice: <table border="1"> <thead> <tr> <th>External Reference ID Value</th> <th>Description</th> </tr> </thead> <tbody> <tr> <td>Billing Account ID</td> <td>Uniquely identifies the account. (Reference Identifier Code is I2).</td> </tr> <tr> <td>Bill Group ID</td> <td>Uniquely identifies the billing group. (Reference Identifier Code is U1).</td> </tr> </tbody> </table>	External Reference ID Value	Description	Billing Account ID	Uniquely identifies the account. (Reference Identifier Code is I2).	Bill Group ID	Uniquely identifies the billing group. (Reference Identifier Code is U1).
	Field	Description											
	Attributes	Following are the attributes: <ul style="list-style-type: none"> • Invoice Number • Payment Amount 											
Reference Records	Uniquely identifies the remittance advice. The following table indicates the external reference ID based on the payment methods used in the remittance advice: <table border="1"> <thead> <tr> <th>External Reference ID Value</th> <th>Description</th> </tr> </thead> <tbody> <tr> <td>Billing Account ID</td> <td>Uniquely identifies the account. (Reference Identifier Code is I2).</td> </tr> <tr> <td>Bill Group ID</td> <td>Uniquely identifies the billing group. (Reference Identifier Code is U1).</td> </tr> </tbody> </table>	External Reference ID Value	Description	Billing Account ID	Uniquely identifies the account. (Reference Identifier Code is I2).	Bill Group ID	Uniquely identifies the billing group. (Reference Identifier Code is U1).						
External Reference ID Value	Description												
Billing Account ID	Uniquely identifies the account. (Reference Identifier Code is I2).												
Bill Group ID	Uniquely identifies the billing group. (Reference Identifier Code is U1).												

You can refer the following sample of EDI 820 flat file for better understanding:

[Sample EDI 820 Flat File](#) on page 2319

Sample EDI 820 Flat File

Following is the sample of EDI 820 flat file format:

```

ISA*00**00**ZZ*USBANK*ZZ*UHGI*091212*1013*U*00401*000000005*0*P*~ /** Bank Details **/
GS*RA*CASH-01*UHGI*20210301*1013*4*X*004010~
ST*CHK*000000001~ /** CHK is the Tender Set Identifier Code, 000000001 is the Set Number**/
BPR*I*50*C*ACH*****1581282972*****20210105~ /** 50 is the Tender Amount, ACH is Tender Type, and
20210105 is the Date **/
DTM*582*****RD8*20210101-20211231~
N1*PE**FI*513057_003~
REF*8G*00001111~ /** 8G is the Tender Type Id, 00001111 is the ACH Trace Number **/
ENT*1*2J*EI*513-00-0003~ /** ENT is the Entity tag **/
NM1*QE*1**EDI,RECON003****N*HLPN0003~ /** HLPN0003 is the Binder Payment Identification Value **/
RMR*IV*921718966031**50~ /** IV is the Identifier Type and 921718966031 is the Identifier Value **/
SE*1*000000001~
GE*1*135260~
IEA*1*505043666~

```

Related Topics

For more information on...	See...
EDI 820 flat file format description	EDI 820 Flat File Description on page 2317

Upload EDI 820 Files in ORMB

A new batch named **Lockbox Payment Upload - Small Group (C1-PUPSG)** is introduced in this release. This batch is used to read the EDI 820 lockbox file received from the bank containing payment details for accounts and uploads the payment details into the ORMB payment upload staging tables. The batch uses the reference ID available in the payment and remittance record (in the specified order) to identify the account in the system:

- Source System Customer Number
- Invoice ID (if the source system customer number is not available)
- MICR (if the source system customer number and invoice ID are not available)

If all three reference IDs are available in the payment and remittance record, the system uses the source system customer number to identify the customer in ORMB. If the customer is found in ORMB, the system then checks whether the identified customer has an account. If the identified customer has one account, the system checks the following:

- If the **Check Binder Payment** parameter in the **Pay Tender Staging Account Distribution - Pay Oldest Bill First (C1-CCPYTSADS)** algorithm is set to Y, the system checks whether the payment is the first payment for the account and the tender used for the payment is not automatic payment. If so, the payment is applied to the **Binder Payment** contract.
- If the **Check Promise To Pay** parameter in the **Tender Staging Account Distribution - Pay Oldest Bill First (C1-CCPYTSADS)** algorithm is set to Y, the system checks whether there is an active promise to pay for the account. If so, the payment is applied to the **On Account** contract.
- If the **Check Payment Agreement** parameter in the **Tender Staging Account Distribution - Pay Oldest Bill First (C1-CCPYTSADS)** algorithm is set to Y, the system checks whether there is an active payment agreement request for the account. If so, the payment is applied to the **On Account** contract.

However, if the **Check Binder Payment**, **Check Promise To Pay**, and **Check Payment Agreement** parameters are set to N, the payment is applied to the account's open bills in the order of the due date (i.e. oldest bill first). If the payment amount is greater than the account's billed balance plus overpayment threshold amount (defined in the **Tender Staging Account Distribution - Pay Oldest Bill First (C1-CCPYTSADS)** algorithm), the entire amount is applied on the On Account contract. However, if the payment amount is greater than the account's billed balance, but less than account's billed balance plus overpayment threshold amount, the overpayment amount is applied on the On Account contract.

Let us understand this with the help of an example:

Payment Amount	Bill 1 (Due Date 01-Feb-2017)	Bill 2 (Due Date 01-April-2016)	Overpayment Threshold Amount	System Behavior
100	50	50	50	One payment (50\$) is created for Bill 2 (oldest due date); One payment (50\$) is created for Bill 1.
150	50	100	120	One payment (100\$) is created for Bill 2 (oldest due date); One payment (50\$) is created for Bill 1.

Payment Amount	Bill 1 (Due Date 01-Feb-2017)	Bill 2 (Due Date 01-April-2016)	Overpayment Threshold Amount	System Behavior
175	60	75	50	One payment (75\$) is created for Bill 2 (oldest due date); One payment (60\$) is created for Bill 1; The remaining amount (40\$) is applied on the On Account contract.
200	50	50	50	The entire amount (200\$) is applied on the On Account contract. This is because the payment amount is greater than the account's billed balance plus overpayment threshold amount.

If the identified customer has multiple accounts, then the payment is applied to the On Account contract. If there are no accounts for the identified customer, or account could not be found in ORMB, or the customer could not be found in ORMB, the payment is applied to the suspense contract defined on the tender source associated with the external source (lockbox) ID.

If the source system customer number is not available, but the invoice ID and MICR are available in the payment and remittance record, then batch uses the invoice ID to find the account for which the invoice is created. Once the account is identified, the system behaves in the similar manner (listed above) when the identified customer has one account.

If the source system customer number and invoice ID are not available, but the MICR is available in the payment and remittance record, then system finds the payment where the same MICR is stamped as a characteristic and then finds the account for which the respective payment is created. In this way, the system derives the account for which the payment must be applied. However, the MICR is used to derive the account only when the **Search Customer Using MICR (Y/N)** parameter in the batch is set to **Y**. Once the account is derived, the system behaves in the similar manner (listed above) when the identified customer has one account.

Following scenarios must be considered before uploading the **EDI 820** file in the system.

Scenario	System Behavior
If the RMR tag contains the bill Id and the NM1 tag contains the binder payment identification value	The system initiates the payment for the bill Id and defines the binder payment identifier value in the Characteristics tab of the Payment screen.
If the RMR tag contains the bill Id but the NM1 tag does not contains the binder payment identification value	The system initiates the payment for the bill Id and does not process further.

Scenario	System Behavior
If the RMR tag contains some other information besides the bill Id and the NM1 tag contains the binder payment identification value	<p>The system performs the following actions:</p> <ol style="list-style-type: none"> 1. Identifies the appropriate membership using the binder payment identification value provided in the NM1 tag. The binder payment identification value must contain the binder payment applicability flag set to Y. 2. Once the membership is identified and is in the Pending Effectuation status, the system identifies the account of the membership, using the information provided in the RMR tag, and applies the payment against the binder contract. 3. If the membership is in the Active status, the system applies the payment against the account's contract.
If the RMR tag contains some other information besides the bill Id and the NM1 tag does not contains the binder payment identification value	The system identifies the account of the membership using the information provided in the RMR tag and applies the payment against the account's contract.

You can upload payment and remittance advice in the TXT format. You need to ensure that the text file is in the required format; otherwise the file will not be uploaded.

Once the text file is uploaded through the **Lockbox Payment Upload - Small Group (C1-PUPSG)** batch, the deposit control staging, tender control staging, and payment upload staging records are created in the respective tables. You can then execute the **Payment Upload (PUPL)** batch to create the deposit control, tender controls, payment events, tenders, payments, and payment segments using payment records in the staging area.

Note: For more information about the batches, refer to the *Oracle Revenue Management and Billing Batch Guide*.

Chapter

32

Deferred Revenue Recognition

Topics:

- [Prerequisites](#)
- [Deferred Revenue Recognition Status Transition](#)
- [Algorithms Used in Deferred Revenue Recognition](#)
- [Deferred Revenue Recognition Template \(Used for Searching\)](#)
- [Deferred Revenue Recognition Template \(Used for Viewing\)](#)
- [Deferred Revenue Recognition \(Used for Searching\)](#)
- [Deferred Revenue Recognition \(Used for Viewing\)](#)

Most often, insurance company bill policies in installments, but Accounts Receivable (AR) and revenue for the total premium are booked as new business in the beginning of the policy term. Regulations, restrictions, or company policies may require that revenue for the total premium must be initially booked to the general ledger as deferred revenue. As time passes, the deferred revenue is realized as earned revenue. For example, the total premium for six months auto-policy (July 1 to Dec 31) is \$1200. When this new business is booked, the revenue of \$1200 is initially booked as deferred revenue. However, on July 31, August 31, September 30, October 31, November 30, and December 31, \$200 must be transferred from deferred revenue GL to earned revenue GL. In order to manage this process, adjustments are created that transfer amount from deferred revenue GL to earned revenue GL.

A deferred revenue recognition schedule determines when these deferred revenue recognition adjustments must be created and posted. On the recognition date, the deferred revenue recognition adjustment is created to transfer a portion of deferred revenue to earned revenue. The corresponding financial transaction does not impact customer's account balance.

You need to create a deferred revenue recognition template for each distribution code and contract type combination for which you want to create a deferred revenue recognition (when the bill segment and adjustment financial transactions created against the respective contracts are frozen). It is the deferred revenue recognition template which helps the system to determine:

- Adjustment type using which the adjustment should be created when the deferred revenue is recognized
- Whether the recognition amount and date in the deferred revenue recognition schedule are editable until recognized
- Whether the deferred revenue recognition schedule must be generated automatically or manually
- Whether the deferred revenue must be recognized daily, weekly, or monthly
- Whether the deferred revenue amount must be prorated when the recognition schedule is set to Monthly
- Algorithm using which the recognition lines in the deferred revenue recognition schedule should be created
- Algorithm using which the adjustment must be generated when the deferred revenue is recognized

During the deferred revenue recognition process, a deferred revenue recognition creation goes through various statuses in its lifecycle. For more information

about the deferred revenue recognition statuses, see [Deferred Revenue Recognition Status Transition](#) on page 2325.

Note: The lifecycle of a deferred revenue recognition creation is driven by the respective business object using which the deferred revenue recognition is generated. The deferred revenue recognition feature explained in this document is articulated based on the lifecycle and logic defined in the business objects.

For more information on how to setup the deferred revenue recognition process, see [Prerequisites](#) on page 2325.

Prerequisites

To setup the deferred revenue recognition feature, you need to do the following:

- Define the required deferred revenue recognition templates in the system.
- Define the required characteristic types where the characteristic entity is set to **Deferred Revenue Recognition**.
- Define the values for the following parameters in the **C1-REVRECITM** algorithm:
 - Use Calendar or Business Days (C or B)
 - Override Default Recognition Date (Y or N)
 - Override Default Weekly Recognition Day (Mon, Tue, Wed, Thu, Fri, Sat, Sun)
 - Override Default Monthly Recognition Date (1-31)
- Define the value for the **Use Contract Expiration Date (Y or N)** parameter in the **C1-REVRECSCH** algorithm.
- Define the value for the **Create Adjustments (Y or N)** parameter in the **C1-REVITMREC** algorithm.
- Set the batch control type of the **Deferred Revenue Recognition Periodic Monitor (C1-RRSMO)** batch to **Timed** and define the following attributes:
 - Time Interval
 - Timer Active
 - User ID
 - Batch Language
 - Email Address

Deferred Revenue Recognition Status Transition

The following figure graphically indicates how a deferred revenue recognition status transition moves from one status to another:

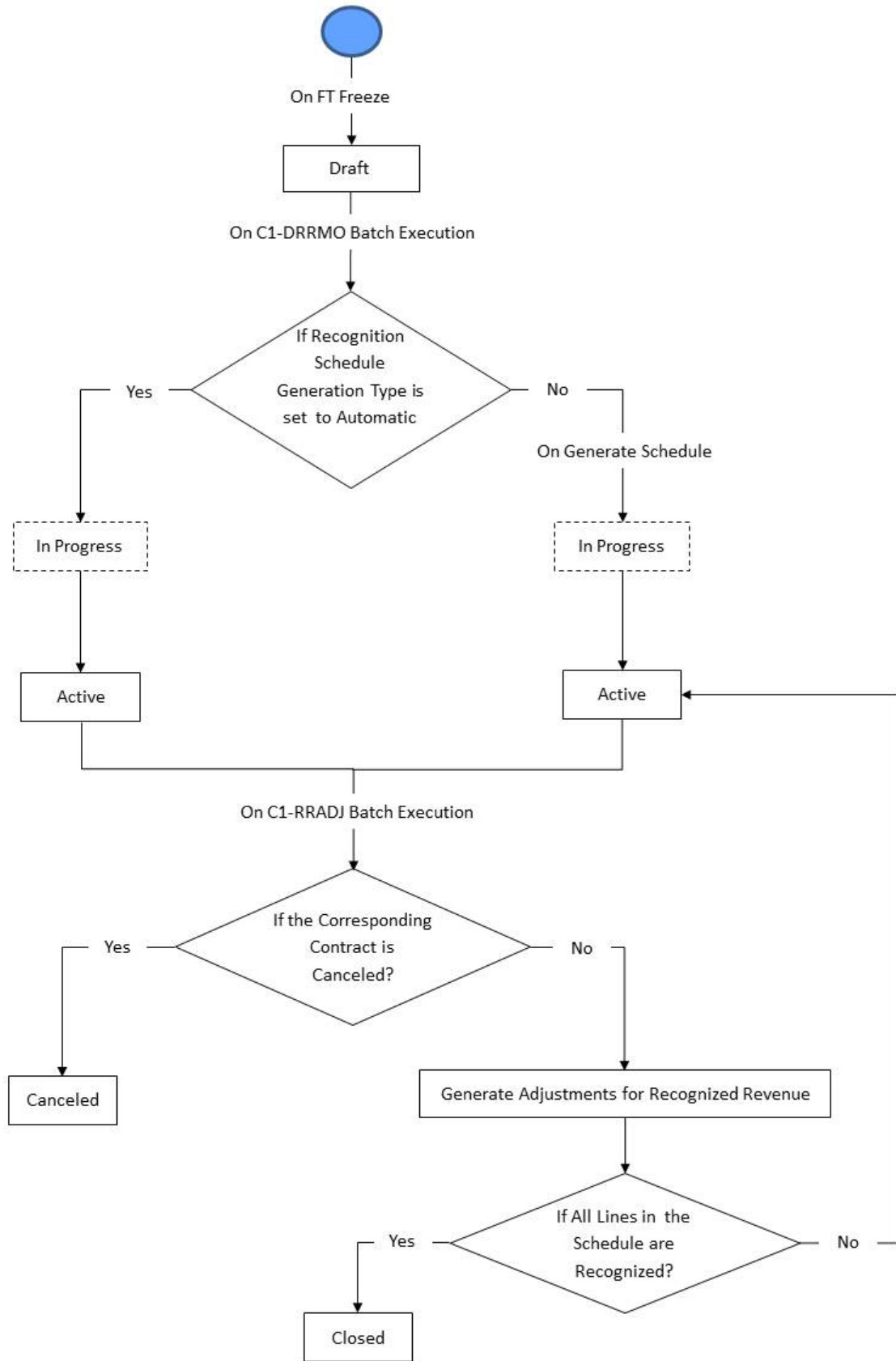

Algorithms Used in Deferred Revenue Recognition

The following table lists the algorithms which are used in the lifecycle of the business object:

Status	System Event	Algorithm	Algorithm Type	Description
		C1-REVRECSCH	C1-REVRECSCH	<p>This algorithm is invoked when the status of the bill segment and adjustment financial transactions created against the contracts (of the contract type to which the algorithm is attached) is set to Frozen. It checks whether an active deferred revenue recognition template exists for the distribution code and contract type combination. If so, it creates a deferred revenue recognition using the template and sets the status of the deferred revenue recognition to Draft. It then checks whether the type of the corresponding financial transaction is Bill Segment or Adjustment. If the type of the corresponding financial transaction is Bill Segment, it sets the valid until date of the deferred revenue recognition to the bill segment end date. However, if the type of the corresponding financial transaction is Adjustment, it checks whether the Use Contract Expiration Date (Y or N) parameter is set to Y or N. If the Use Contract Expiration Date (Y or N) parameter is set to Y, it sets the valid until date of the deferred revenue recognition to the contract expiration date. However, if the Use Contract Expiration Date (Y or N) parameter is set to N, it sets the valid until date of the deferred revenue recognition to the financial transaction arrears date. In addition, on creating the deferred revenue recognition, an appropriate log entry is added which you can view in the Deferred Revenue Recognition Log zone. It contains the following parameter:</p> <ul style="list-style-type: none"> • Use Contract Expiration Date (Y or N) – Used to indicate whether the valid until date must be set to the contract expiration date when the type of the corresponding financial transaction is Adjustment. The valid values are Y and N. This parameter is mandatory.

Status	System Event	Algorithm	Algorithm Type	Description
		C1-REVRECITM	C1-REVRECITM	<p>This algorithm creates schedule for the deferred revenue recognition. It considers the valid until date and accordingly creates the recognition lines within the schedule. If the recognition schedule is Weekly, by default, the recognition day is set to Mon (which means Monday of each week). However, if the recognition schedule is Monthly, by default, the recognition date is set to the last day of the month (i.e. 28, 29, 30, or 31) It contains the following parameters:</p> <ul style="list-style-type: none"> • Use Calendar or Business Days (C or B) - Used to indicate whether you want to use the calendar or business days while generating the recognition schedule. The business days are derived using the work calendar defined on the financial transaction. If you do not specify any value for this parameter, by default, it is set to C. This parameter is mandatory. • Override Default Recognition Date (Y or N) – Used to indicate whether you want to override the default weekly or monthly recognition date. The valid values are Y and N. This parameter is mandatory. • Override Default Weekly Recognition Day (Mon, Tue, Wed, Thu, Fri, Sat, Sun) – Used to indicate the day of the week when you want to recognize the deferred revenue. The valid values are Mon, Tue, Wed, Thu, Fri, Sat, and Sun. This parameter is required when you want to override the default weekly recognition day. • Override Default Monthly Recognition Date (1-31) - Used to indicate the day of the month when you want to recognize the deferred revenue. The valid values are 1, 2, 3, ..., 31. This parameter is required when you want to override the default monthly recognition date.

Status	System Event	Algorithm	Algorithm Type	Description
		C1-REVRECADJ	C1-REVRECADJ	This algorithm creates deferred revenue recognition adjustment using the adjustment type defined on the respective deferred revenue recognition template. Before creating the deferred revenue recognition adjustment, it checks whether the contract for which the deferred revenue recognition is created is cancelled. If so, the status of the deferred revenue recognition is set to Canceled. If all lines in the recognition schedule are recognized, the status of the deferred revenue recognition is set to Closed.
		C1-REVITMREC	C1-REVITMREC	If this algorithm is attached in the deferred revenue recognition template, it is invoked while executing the C1-RRADJ batch. It contains the following parameter: <ul style="list-style-type: none"> • Create Adjustments (Y or N) – Used to indicate whether the deferred revenue recognition adjustment must be created or not when the recognition date is earlier than or equal to the batch business date. The valid values are Y and N. This parameter is mandatory.
		C1-DRRTM-INF	C1-DRRTM-INF	This algorithm generates the deferred revenue recognition template information string which appears throughout the application. It concatenates the following fields separated by a comma in the specified order: <ol style="list-style-type: none"> 1. Deferred Revenue Recognition Template 2. Description

Status	System Event	Algorithm	Algorithm Type	Description
		C1-DRRTMPVAL	C1-DRRTMPVAL	<p>This algorithm validates the deferred revenue recognition template. It checks the following:</p> <ul style="list-style-type: none"> • Whether the data is specified in the mandatory fields, such as Deferred Revenue Recognition Template, Description, Status, Distribution Code, Contract Type, Adjustment Type, Recognition Schedule Generation Type, and Recognition Schedule. • Whether an algorithm is attached to the Create Deferred Revenue Recognition Schedule and Generate Deferred Revenue Recognition Adjustment system events. • Whether a deferred revenue recognition template already exists for the specified distribution code and contract type combination. • Whether special characters except underscore are specified in the Deferred Revenue Recognition Template field. • Whether the high proration limit is between 0 to 31 and is greater than the low proration limit.>> Whether the low proration limit is between 0 to 31 and is less than the high proration limit. <p>In addition, it does not allow you to:</p> <ul style="list-style-type: none"> • Delete a deferred revenue recognition template when it is used to create a deferred revenue recognition. • Edit a deferred revenue recognition template when the corresponding deferred revenue recognition is in the Draft status. • Inactivate a deferred revenue recognition template when the corresponding deferred revenue recognition is not in the Closed status. <p>You must attach this validation algorithm to the custom business object which is used to create a deferred revenue recognition template. Otherwise, erroneous results might occur.</p>

Status	System Event	Algorithm	Algorithm Type	Description
		C1-DRRSC-INF	C1-DRRSC-INF	<p>This algorithm generates the deferred revenue recognition information string which appears throughout the application. It concatenates the following fields separated by a comma in the specified order:</p> <ol style="list-style-type: none"> 1. Deferred Revenue Recognition Template 2. Deferred Revenue Recognition Status 3. Distribution Code 4. Deferred Revenue Recognition ID
		C1-REVMON	C1-REVMON	<p>This algorithm is invoked when the C1-DRRMO batch is executed. It checks whether there are any deferred revenue recognitions in the Draft status. If there is any deferred revenue recognition in the Draft status, it checks whether the recognition schedule generation type in the respective deferred revenue recognition template is set to Automatic or Manual. If the recognition schedule generation type is set to Automatic, the status of the deferred revenue recognition is changed to In Progress. However, if the recognition schedule generation type is set to Manual, the status of the deferred revenue recognition remains as Draft.</p>
		C1-REVRECINP	C1-REVRECINP	<p>This algorithm creates an appropriate log entry when the status of the deferred revenue recognition is changed to In Progress. It invokes the algorithm attached to the Create Deferred Revenue Recognition Schedule system event of the respective deferred revenue recognition template. Once the recognition schedule is successfully created, the status of the deferred revenue recognition is changed to Active.</p>

Status	System Event	Algorithm	Algorithm Type	Description
		C1-REVRECACT	C1-REVRECACT	<p>This algorithm transitions the current status to the specified status. You can specify the status to which you want the business object to transition in the following parameters:</p> <ul style="list-style-type: none"> • Next Status • Next Transition Condition <p>At a time, you can specify value for either the Next Status or Next Transition Condition parameter. If you don't specify any value for these parameters, the system will transition the business object to the default next status specified in its lifecycle. This algorithm creates an appropriate log entry when the status of the deferred revenue recognition is changed to Active.</p>

Deferred Revenue Recognition Template (Used for Searching)

The **Deferred Revenue Recognition** screen allows you to search for a deferred revenue recognition template using various search criteria. Through this screen, you can navigate to the following screen:

- [Deferred Revenue Recognition Template \(Used for Viewing\)](#) on page 2340

This screen consists of the following zone:

- [Search Deferred Revenue Recognition Template](#) on page 2332

Search Deferred Revenue Recognition Template

The **Search Deferred Revenue Recognition Template** zone allows you to search for a deferred revenue recognition template using various search criteria. It contains the following two sections:

- **Search Criteria** – The **Search Criteria** section contains the following fields:

Field Name	Field Description	Mandatory (Yes or No)
Deferred Revenue Recognition Template	Used to search the basic information about the deferred revenue recognition template.	Yes
Description	Used to search the description of the deferred revenue recognition template.	No
Recognition Schedule	Used to search deferred revenue recognition with a particular schedule. The valid values are: <ul style="list-style-type: none"> • Daily • Monthly • Weekly 	No

Field Name	Field Description	Mandatory (Yes or No)
Status	Used to indicate the deferred revenue recognition template with a particular status. The valid values are: <ul style="list-style-type: none"> Active Inactive 	No

Note: You must specify at least one search criterion while searching for a deferred revenue recognition template.

- **Search Results** – On clicking the **Search** button, the search results appear based on the specified search criteria. The **Search Results** section contains the following columns:

Column Name	Column Description
Deferred Revenue Recognition Template	Displays the deferred revenue recognition. Note: It has a link. On clicking the link, the Deferred Revenue Recognition Template screen appears where you can view the details of the respective deferred revenue recognition template.
Distribution Code	Indicates the distribution code associated with the rate component.
Contract Type	Displays the contract which is generated against a particular type of contract.
Recognition Schedule	Displays the schedule when the deferred revenue is recognized.

Related Topics

For more information on...	See...
How to view the details of a deferred revenue recognition template	Viewing the Deferred Revenue Recognition Template Details on page 2339
How to search for a deferred revenue recognition template	Searching for a Deferred Revenue Recognition Template on page 2333

Searching for a Deferred Revenue Recognition Template

Prerequisites

To search for a deferred revenue recognition template, you should have:

- Deferred revenue recognition template defined in the system.
- Deferred Revenue Recognition Schedule defined in the system.

Procedure

To search for a deferred revenue recognition template:

1. Click the **Admin** menu in the **Application** toolbar.
A list appears.
2. From the **Admin** menu, select **D** and then click **Deferred Revenue Recognition Template**.
The **Deferred Revenue Recognition Template** screen appears.
3. Enter the search criteria in the **Search Deferred Revenue Recognition Template** zone.

Note: ORMB search engine supports wildcard search, where you can substitute the percentage (%) symbol as a stand in for any word or letter in a search criteria. You can use the ‘%’ wildcard character in all input fields except the date and ID fields. The ‘%’ wildcard character is suffixed automatically at the end of the partial search criteria. Therefore, you may or may not specify the wildcard character at the end of the partial search criteria. However, you have to prefix the wildcard character manually wherever required.

4. Click **Search**.

A list of deferred revenue recognition templates that meet the search criteria appears in the **Search Results** section.

Related Topics

For more information on...	See...
Deferred Revenue Recognition Template screen	Deferred Revenue Recognition Template (Used for Searching) on page 2332
Search Deferred Revenue Recognition Template zone	Search Deferred Revenue Recognition Template on page 2332

Defining a Deferred Revenue Recognition Template

Prerequisites

To define a deferred revenue recognition template, you should have:

- Contract types defined in the system

Procedure

To define a deferred revenue recognition template:

1. Click the **Admin** menu in the **Application** toolbar.

A list appears.

2. From the **Admin** menu, select **D** and then click **Deferred Revenue Recognition Template**.

The **Deferred Revenue Recognition Template** screen appears.

3. Click the **Add** button in the **Page Title** area of the **Deferred Revenue Recognition Template** screen.

The **Deferred Revenue Recognition Template** screen appears. It contains the following sections:

- **Main** – Used to specify basic details about the deferred revenue recognition template.
- **Parameters** – Used to specify the various parameters for the deferred revenue recognition template.
- **Algorithms** – Used to associate algorithms with the deferred revenue recognition template.
- **Divisions** – Used to associate a deferred revenue recognition template with a division.
- **Characteristics** – Used to define the characteristics for the deferred revenue recognition template.

The **Main** section contains the following fields:

Field Name	Field Description	Mandatory (Yes or No)
Deferred Revenue Recognition Template	Used to specify the deferred revenue recognition template.	Yes
Description	Used to specify the description of the deferred revenue recognition template.	No

Field Name	Field Description	Mandatory (Yes or No)
Status	Used to indicate the status of the deferred revenue recognition template. The valid values are: <ul style="list-style-type: none"> Active Inactive 	Yes

The **Parameters** section contains the following fields:

Field Name	Field Description	Mandatory (Yes or No)
Distribution Code	Used to indicate the distribution code associated with the deferred revenue recognition.	Yes
	Note: The Search (🔍 icon appears corresponding to this field. On clicking the Search icon, the Distribution Code Search window appears.	
Contract Type	Used to indicate a particular type of contract.	Yes
	Note: The Search (🔍 icon appears corresponding to this field. On clicking the Search icon, the Contract Type Search window appears.	
Adjustment Type	Used to indicate the adjustment type using which the adjustment must be created.	No
	Note: The Search (🔍 icon appears corresponding to this field. On clicking the Search icon, the Adjustment Type Search window appears.	
Allow Editing	Used to allow editing of recognition schedule.	No
Generation Type	Used to indicate the type of deferred revenue recognition generation. The valid values are: <ul style="list-style-type: none"> Automatic Manual 	Yes (Conditional)
Recognition Schedule	Used to indicate the schedule of deferred revenue recognition generation. The valid values are: <ul style="list-style-type: none"> Daily Monthly Weekly 	Yes
Allow Proration	Used to allow proration.	Yes
	Note: The Allow Proration field appears when you select Recognition Schedule as Monthly .	

Field Name	Field Description	Mandatory (Yes or No)
High Proration Limit (Days)	Used to specify whether deferred revenue amount must be prorated while revenue recognition. If the number of days from when the policy is enrolled to the end of the month (in which it is enrolled) is greater than the specified limit, then the amount is prorated.	Yes (Conditional)
	Note: This field appears when you check the tick-box for Allow Proration .	Note: This field is required when the recognition schedule is selected as monthly and when the Allow Proration check box is selected.
Low Proration Limit (Days)	Used to specify whether deferred revenue amount must be prorated while revenue recognition. If the number of days from when the policy is enrolled to the end of the month (in which it is enrolled) is less than the specified limit, then the amount is prorated.	Yes (Conditional)
	Note: This field appears when you check the tick-box for Allow Proration .	Note: This field is required when the recognition schedule is selected as monthly and when the Allow Proration check box is selected.

4. Enter the required details.
5. Associate algorithms with the deferred revenue recognition template, if required.
6. View the division to which the deferred revenue recognition template is associated in the **Divisions** section.
7. Define the characteristics specific to division to which the deferred revenue recognition template is associated in the **Characteristics** section.
8. Click **Save**.

The deferred revenue recognition template is created.

Related Topics

For more information on...	See...
Deferred Revenue Recognition Template screen	Deferred Revenue Recognition Template (Used for Searching) on page 2332
How to associate algorithms with the deferred revenue recognition template	Associating Algorithms with a Deferred Revenue Recognition Template on page 2336

Associating Algorithms with a Deferred Revenue Recognition Template

Procedure

To associate algorithms with a deferred revenue recognition template:

1. Ensure that the **Algorithms** section is expanded when you are defining or editing a deferred revenue recognition template.

The **Algorithms** section contains the following fields in a grid:

Field Name	Field Description	Mandatory (Yes or No)
System Event	Used to indicate the system event for an algorithm.	Yes

Field Name	Field Description	Mandatory (Yes or No)
Sequence	Used to specify the sequence number.	Yes
	Note: On specifying the value for a predefined characteristic type, the description of the characteristic value appears corresponding to the Characteristic Value field.	
Algorithm	Used to associate an algorithm to the system event that you have selected.	Yes
	Note: The Search (🔍) icon appears corresponding to this field. On clicking the Search icon, the Algorithm Search window appears. On specifying the algorithm for a system event, the description of the algorithm appears corresponding to the Algorithm field.	

- Enter the required details in the **Algorithms** section.
- If you want to define more than one algorithm for the deferred revenue recognition template, click the **Add** (+) icon, and then repeat 2.

Note: However, if you want to remove an algorithm from the deferred revenue recognition template, click the **Delete** (🗑️) icon corresponding to the algorithm.

Related Topics

For more information on...	See...
How to define a deferred revenue recognition template	Defining a Deferred Revenue Recognition Template on page 2334
How to edit a deferred revenue recognition template	Editing a Deferred Revenue Recognition Template on page 2342

Associating Deferred Revenue Recognition Template With A Division

Prerequisites

To associate deferred revenue recognition template with a division, you should have:

- Divisions defined in the application

Procedure

To associate deferred revenue recognition template with a division:

- Ensure that the **Divisions** section is expanded when you are creating or editing a deferred revenue recognition template.

The **Divisions** section appears. It contains the following fields:

Field Name	Field Description	Mandatory (Yes or No)
Division	Used to indicate the division to which you want to associate the deferred revenue recognition template.	No
	Note: You can only view those divisions to which you have access in the Division list.	

- Select the required division from the list.
- If you want to associate the deferred revenue recognition template with more than one division, click the **Add (+)** icon and then repeat step 2.

Note: However, if you want to remove the deferred revenue recognition template from a division, click the **Delete** (🗑️) icon corresponding to the division.

- Click **Save**.

The deferred revenue recognition template is associated with the divisions.

Related Topics

For more information on...	See...
How to edit a deferred revenue recognition template	Editing a Deferred Revenue Recognition Template on page 2342
How to define a deferred revenue recognition template	Defining a Deferred Revenue Recognition Template on page 2334

Defining a Characteristic for a Deferred Revenue Recognition Template

Prerequisites

To define a characteristic for a deferred revenue recognition template, you should have:

- Characteristic types defined in the application (where the characteristic entity is set to **Deferred Revenue Recognition Template**)

Procedure

To define a characteristic for a deferred revenue recognition template:

- Ensure that the **Characteristics** section is expanded when you are defining or editing a deferred revenue recognition template.

The **Characteristics** section contains the following fields in a grid:

Field Name	Field Description	Mandatory (Yes or No)
Characteristic Type	Used to indicate the characteristic type.	Yes (Conditional)
		Note: This field is required when you are defining a characteristic for the deferred revenue recognition template.

Field Name	Field Description	Mandatory (Yes or No)
Characteristic Value	Used to specify the value for the characteristic type.	Yes (Conditional)
	Note: On specifying the value for a characteristic type, the description of the characteristic value appears corresponding to the Characteristic Valued field.	Note: This field is required when you are defining a characteristic for the deferred revenue recognition template.

- Enter the required details in the **Characteristics** section.
- If you want to define more than one characteristic for the deferred revenue recognition template, click the **Add (+)** icon and then repeat step 2.

Note: However, if you want to remove a characteristic from the deferred revenue recognition template, click the **Delete (🗑)** icon corresponding to the characteristic.

Related Topics

For more information on...	See...
How to edit a deferred revenue recognition template	Editing a Deferred Revenue Recognition Template on page 2342
How to define a deferred revenue recognition template	Defining a Deferred Revenue Recognition Template on page 2334

Viewing the Deferred Revenue Recognition Template Details

Procedure

To view the details of a deferred revenue recognition template:

- Click the **Admin** link in the **Application** toolbar.
A list appears.
- From the **Admin** menu, select **D** and then click **Deferred Revenue Recognition Template**.
The **Deferred Revenue Recognition Template** screen appears.
- Search for the deferred revenue recognition template in the **Deferred Revenue Recognition Template** screen.
- In the **Search Results** section, click the link in the **Deferred Revenue Recognition Template** column corresponding to the deferred revenue recognition template whose details you want to view.
The **Deferred Revenue Recognition Template** screen appears.
- View the details of the deferred revenue recognition template in the **Deferred Revenue Recognition Template** zone.

Related Topics

For more information on...	See...
Deferred Revenue Recognition Template screen	Deferred Revenue Recognition Template (Used for Searching) on page 2332
Deferred Revenue Recognition Template zone	Deferred Revenue Recognition Template on page 2340
How to search for a deferred revenue recognition template	Searching for a Deferred Revenue Recognition Template on page 2333

Deferred Revenue Recognition Template (Used for Viewing)

Once the deferred revenue recognition templates are created, the **Deferred Revenue Recognition Template** screen allows you to:

- Generate the deferred revenue recognition schedule
- View the details of a deferred revenue recognition template
- Edit a deferred revenue recognition template
- Delete a deferred revenue recognition template

This screen consists of the following zone:

- [Deferred Revenue Recognition Template](#) on page 2340

Deferred Revenue Recognition Template

The **Deferred Revenue Recognition Template** zone displays the details of the deferred revenue recognition template. It contains the following sections:

- **Main** – Displays basic information about the deferred revenue recognition template. It contains the following fields:

Field Name	Field Description
Deferred Revenue Recognition Template	Displays the deferred revenue recognition template
Description	Used to specify the description of the deferred revenue recognition template
Status	Used to indicate the status of the deferred revenue recognition template. The valid values are: <ul style="list-style-type: none"> • Active • Inactive

- **Parameters** – Displays the parameters used in the deferred revenue recognition template.

Field Name	Field Description
Distribution Code	Indicates the distribution code. Note: It has a link. On clicking the link, the Distribution Code screen appears where you can view the details of the respective distribution code.
Contract Type	Displays the Deferred Revenue Recognition Template which are generated against a particular type of contract.
Adjustment Type	Indicates the adjustment type using which the adjustment must be created. Note: It has a link. On clicking the link, the Adjustment Type screen appears where you can view the details of the respective adjustment type.

Field Name	Field Description
Generation Type	Displays the type of deferred revenue recognition template. The valid values are: <ul style="list-style-type: none"> Manual Automatic
Allow Editing	Indicates the editing of recognition schedule.
Recognition Schedule	Indicates the schedule when the deferred revenue is recognized. The valid values are: <ul style="list-style-type: none"> Daily Monthly Weekly
Allow Proration	Used to allow proration. Note: The Allow Proration field appears when you select Recognition Schedule as Monthly .
High Proration Limit (Days)	Displays whether deferred revenue amount must be prorated while revenue recognition. If the number of days from when the policy is enrolled to the end of the month (in which it is enrolled) is greater than the specified limit, then the amount is prorated. Note: This field appears when you check the tick-box for Allow Proration .
Low Proration Limit (Days)	Displays whether deferred revenue amount must be prorated while revenue recognition. If the number of days from when the policy is enrolled to the end of the month (in which it is enrolled) is less than the specified limit, then the amount is prorated. Note: This field appears when you check the tick-box for Allow Proration .

- **Divisions** – Displays the associated deferred revenue recognition template with one or more divisions. It contains the following column:

Column Name	Column Description
Division	Displays the division to which you want to associate the deferred revenue recognition template.

- **Algorithms** – Lists the algorithms associated with the deferred revenue recognition template. It contains the following columns:

Column Name	Column Description	Mandatory (Yes or No)
System Event	Indicates the system event on which the algorithm must be executed	No
Sequence	Displays the sequence number.	No

Column Name	Column Description	Mandatory (Yes or No)
Algorithm	Displays an algorithm that needs to be attached to the selected system event.	No
	Note: It has a link. On clicking the link, the Algorithm screen appears where you can view the details of the respective algorithm.	

- **Characteristics** – Lists the characteristics defined for the deferred revenue recognition template. It contains the following fields:

Column Name	Column Description
Characteristic Type	Displays the characteristic type.
Characteristic Type	Displays the value of the characteristic type.

- **Record Actions** – This section contains the following buttons:

Button Name	Button Description
Edit	Used to define, edit, and remove algorithms of the deferred revenue recognition template. Note: The Edit button appears when the deferred revenue recognition template is in the Active status.
Delete	Used to delete the deferred revenue recognition template.

-
- **Record Information** – This section contains the following fields:

Field Name	Field Description
Business Object	Indicates the business object using which the deferred revenue recognition template is created. In addition, a context menu appears corresponding to this field which helps in navigating to other screens in the application. Note: It has a link. On clicking the link, the Business Object screen appears where you can view the details of the respective business object.

Editing a Deferred Revenue Recognition Template

Procedure

To edit a deferred revenue recognition template:

1. Search for the deferred revenue recognition template in the **Deferred Revenue Recognition Template** screen.
2. In the **Search Results** section, click the link in the **Deferred Revenue Recognition Template** column corresponding to the deferred revenue recognition template whose details you want to edit.

The **Deferred Revenue Recognition Template** screen appears.

3. Click the **Edit** button in the **Deferred Revenue Recognition Template** zone.

The **Deferred Revenue Recognition Template** screen appears.

Note: The **Edit** button appears when the deferred revenue recognition template is in the **Active** status.

4. Associate, edit, or remove algorithms from the deferred revenue recognition template, if required.
5. Define, edit, or remove characteristics of the deferred revenue recognition template, if required.
6. Associate deferred revenue recognition template with a division, if required.
7. Click **Save**.

The changes made to the deferred revenue recognition template are saved.

Related Topics

For more information on...	See...
Deferred Revenue Recognition Template screen	Deferred Revenue Recognition Template (Used for Viewing) on page 2340
Deferred Revenue Recognition Template zone	Deferred Revenue Recognition Template on page 2340
How to search for a deferred revenue recognition template	Searching for a Deferred Revenue Recognition Template on page 2333
How to associate algorithms with a deferred revenue recognition template	Associating Algorithms with a Deferred Revenue Recognition Template on page 2336

Deleting a Deferred Revenue Recognition Template

Procedure

To delete a deferred revenue recognition template:

1. Search for the deferred revenue recognition template in the **Deferred Revenue Recognition Template** screen.
2. In the **Search Results** section, click the link in the **Deferred Revenue Recognition Template** column corresponding to the deferred revenue recognition template that you want to delete.

The **Deferred Revenue Recognition Template** screen appears.

3. Click the **Delete** button in the **Deferred Revenue Recognition Template** zone.

A message appears confirming whether you want to delete the deferred revenue recognition template.

4. Click **OK**.

The deferred revenue recognition template is deleted.

Related Topics

For more information on...	See...
Deferred Revenue Recognition Template screen	Deferred Revenue Recognition Template (Used for Viewing) on page 2340
Deferred Revenue Recognition Template zone	Deferred Revenue Recognition Template on page 2340
How to search for a deferred revenue recognition template	Searching for a Deferred Revenue Recognition Template on page 2333

Viewing the Deferred Revenue Recognition Template Details

Procedure

To view the details of a deferred revenue recognition template:

1. Click the **Admin** link in the **Application** toolbar.
A list appears.
2. From the **Admin** menu, select **D** and then click **Deferred Revenue Recognition Template**.
The **Deferred Revenue Recognition Template** screen appears.
3. Search for the deferred revenue recognition template in the **Deferred Revenue Recognition Template** screen.
4. In the **Search Results** section, click the link in the **Deferred Revenue Recognition Template** column corresponding to the deferred revenue recognition template whose details you want to view.
The **Deferred Revenue Recognition Template** screen appears.
5. View the details of the deferred revenue recognition template in the **Deferred Revenue Recognition Template** zone.

Related Topics

For more information on...	See...
Deferred Revenue Recognition Template screen	Deferred Revenue Recognition Template (Used for Searching) on page 2332
Deferred Revenue Recognition Template zone	Deferred Revenue Recognition Template on page 2340
How to search for a deferred revenue recognition template	Searching for a Deferred Revenue Recognition Template on page 2333

Deferred Revenue Recognition (Used for Searching)

The **Deferred Revenue Recognition** screen allows you to search for a deferred revenue recognition using various search criteria. Through this screen, you can navigate to the following screen:

- [Deferred Revenue Recognition \(Used for Viewing\)](#) on page 2350

This screen consists of the following zone:

- [Search Deferred Revenue Recognition](#) on page 2344

Search Deferred Revenue Recognition

The **Search Deferred Revenue Recognition** zone allows you to search for a deferred revenue recognition using various search criteria. It contains the following two sections:

- **Search Criteria** – This section contains the following fields:

Field Name	Field Description	Mandatory (Yes or No)
Search By	Used to indicate whether you want to search for a deferred revenue recognition using the deferred revenue recognition, person, account, or policy details. The valid values are: <ul style="list-style-type: none"> • Account Details • Person Details • Deferred Revenue Recognition Details • Financial Transaction Details • Policy Details 	Yes
	Note: By default, the Account Details option is selected.	
Person ID	Used to search deferred revenue recognition which are assigned to a particular person.	No
	Note: This field appears when you select the Person Details option from the Search By list.	
Account ID	Used to search the account ID.	No
	Note: This field appears only when you select the Account Details option from the Search By list.	
Person Identifier Type	Used to select the identifier type based on which you want to search deferred revenue recognition through which the person's record is created or updated in the system.	Yes (Conditional)
		Note: If you specify the person identifier as a search criteria, you have to select the person identifier type.
Person Identifier	Used to specify the value for the person identifier type.	Yes (Conditional)
		Note: If you specify the person identifier type as a search criteria, you have to specify the person identifier.
Account Identifier Type	Used to specify the account identifier type of the account whose details you want to search.	Yes (Conditional)
		Note: If you specify the account identifier as a search criteria, you have to select the account identifier type.
	Note: This field appears when you select the Account Details option from the Search By list.	

Field Name	Field Description	Mandatory (Yes or No)
Account Identifier	Used to specify the value of the account identifier.	Yes (Conditional)
	Note: This field appears when you select the Account Details option from the Search By list.	
Contract ID	Used to specify the contract ID linked to the account.	No
	Note: This field appears when you select the Account Details option from the Search By list.	
Person Hierarchy	Used to indicate whether to display hierarchy of the person linked to a particular bill.	No
	Note: This field appears when you select the Person Details option from the Search By list.	
Status	Used to search deferred revenue recognition with a particular status. The valid values are: <ul style="list-style-type: none"> • Active • Closed • Canceled • Draft 	No
	Note: This field appears when you select the Person Details , Account Details , or Deferred Revenue Recognition Details option from the Search By list.	
Deferred Revenue Recognition Template	Used to indicate the template used for deferred revenue recognition.	No
	Note: This field appears when you select the Person Details , Account Details , or Deferred Revenue Recognition Details option from the Search By list.	
Valid Until Date	Used to specify the date till which the deferred revenue recognition is valid.	No
	Note: This field appears when you select the Person Details or Account Details option from the Search By list.	
Deferred Revenue Recognition ID	Used to search a particular deferred revenue recognition	No
	Note: This field appears when you select the Deferred Revenue Recognition Details option from the Search By list.	

Field Name	Field Description	Mandatory (Yes or No)
Description	Used to specify the description of the deferred revenue recognition.	No
	Note: This field appears when you select the Deferred Revenue Recognition Details option from the Search By list.	
Recognition Schedule	Used to search deferred revenue recognition with a particular schedule. The valid values are: <ul style="list-style-type: none"> • Daily • Monthly • Weekly 	No
	Note: This field appears when you select the Deferred Revenue Recognition Details option from the Search By list.	
Financial Transaction ID	Used to search deferred revenue recognition which are assigned to a particular financial transaction.	
	Note: This field appears only when you select the Financial Transaction Details option from the Search By list.	
Policy Type	Used to indicate the type of policy.	Yes
	Note: This field appears when you select the Policy Details option from the Search By list.	
Policy Number	Used to indicate the policy number.	No
	Note: This field appears when you select the Policy Details option from the Search By list.	
Plan Number	Used to indicate the plan number of the policy.	No
	Note: This field appears when you select the Policy Details option from the Search By list.	
Source System	Used to indicate the name of the external system from where the policy originated.	No
	Note: This field appears when you select the Policy Details option from the Search By list.	
Start Date	Used to indicate the date from when the policy is effective.	No
	Note: This field appears when you select the Policy Details option from the Search By list.	

Field Name	Field Description	Mandatory (Yes or No)
End Date	Used to indicate the date till when the policy is effective.	No
	Note: This field appears when you select the Policy Details option from the Search By list.	

Note: You must specify at least one search criterion while searching for a deferred revenue recognition.

- **Search Results** – On clicking the **Search** button, the search results appear based on the specified search criteria. The **Search Results** section contains the following columns:

Column Name	Column Description
Deferred Revenue Recognition Information	Displays information about the deferred revenue recognition.
	Note: It has a link. On clicking the link, the Deferred Revenue Recognition screen appears where you can view the details of the respective deferred revenue recognition.
Contract Information	Displays the basic information about the contract corresponding to the deferred revenue recognition. In addition, this column has a context menu which helps in navigating to other screens in the application.
	Note: It has a link. On clicking the link, the Contract screen appears where you can view the details of the respective contract.
Financial Transaction Information	Displays the basic information about the financial transaction corresponding to the deferred revenue recognition.
	Note: It has a link. On clicking the link, the Financial Transaction screen appears where you can view the details of the respective financial transaction.

Related Topics

For more information on...	See...
How to view the details of a deferred revenue recognition	Viewing the Deferred Revenue Recognition Details on page 2349
How to search for a deferred revenue recognition	Searching for a Deferred Revenue Recognition on page 2348

Searching for a Deferred Revenue Recognition

Prerequisites

To search for a deferred revenue recognition, you should have:

- Deferred Revenue Recognition Template defined in the application.
- Person identifier types defined in the application
- Account identifier types defined in the application
- Recognition Schedules defined in the application
- Source Systems defined in the application

Procedure

To search for a deferred revenue recognition:

1. Click the **Menu** link in the **Application** toolbar.
A list appears.
2. From the **Main** menu, select **Accounting and Receivable**.
A sub-menu appears.
3. Click the **Search** option from the **Deferred Revenue Recognition** sub-menu.
The **Deferred Revenue Recognition** screen appears.
4. Enter the search criteria in the **Search Deferred Revenue Recognition** zone.

Note: ORMB search engine supports wildcard search, where you can substitute the percentage (%) symbol as a stand in for any word or letter in a search criteria. You can use the ‘%’ wildcard character in all input fields except the date and ID fields. The ‘%’ wildcard character is suffixed automatically at the end of the partial search criteria. Therefore, you may or may not specify the wildcard character at the end of the partial search criteria. However, you have to prefix the wildcard character manually wherever required.

5. Click **Search**.

A list of deferred revenue recognition that meet the search criteria appears in the **Search Results** section.

Related Topics

For more information on...	See...
Deferred Revenue Recognition screen	Deferred Revenue Recognition (Used for Searching) on page 2344
Search Deferred Revenue Recognition zone	Search Deferred Revenue Recognition on page 2344

Viewing the Deferred Revenue Recognition Details**Procedure**

To view the details of a deferred revenue recognition:

1. Search for the deferred revenue recognition in the **Deferred Revenue Recognition** screen.
2. In the **Search Results** section, click the link in the **Deferred Revenue Recognition Information** column corresponding to the deferred revenue recognition whose details you want to view.

The **Deferred Revenue Recognition** screen appears. It consists of the following tabs:

- [Deferred Revenue Recognition - Main](#) on page 2350
- [Deferred Revenue Recognition - Log](#) on page 2353

3. Ensure that the **Main** tab is selected.
4. View the details of the deferred revenue recognition in the **Deferred Revenue Recognition** zone.

Related Topics

For more information on...	See...
Deferred Revenue Recognition screen	Deferred Revenue Recognition (Used for Viewing) on page 2350
Search Deferred Revenue Recognition zone	Search Deferred Revenue Recognition on page 2344
How to search for a deferred revenue recognition	Searching for a Deferred Revenue Recognition on page 2348

Deferred Revenue Recognition (Used for Viewing)

The **Deferred Revenue Recognition** screen allows you to:

- View the details of a deferred revenue recognition
- Edit a deferred revenue recognition
- Generate the deferred revenue recognition schedule
- Add related deferred revenue recognitions
- Edit the details of a deferred revenue recognition schedule
- View the log of a deferred revenue recognition
- Add a log entry for a deferred revenue recognition

This screen consists of the following tabs:

- [Deferred Revenue Recognition - Main](#) on page 2350
- [Deferred Revenue Recognition - Log](#) on page 2353

Deferred Revenue Recognition - Main

The **Main** tab displays information about the deferred revenue recognition. It contains the following zones:

- [Deferred Revenue Recognition](#) on page 2350
- [Associated Deferred Revenue Recognitions](#) on page 2352
- [Recognition Schedule](#) on page 2352
- [Revenue Recognition Items](#) on page 2353

Deferred Revenue Recognition

The **Deferred Revenue Recognition** zone displays the details of the deferred revenue recognition. It contains the following sections:

- **Main** – Displays basic information about the deferred revenue recognition. It contains the following fields:

Field Name	Field Description
Deferred Revenue Recognition Information	Displays information about the deferred revenue recognition.
Deferred Revenue Recognition Template Information	Displays information about the deferred revenue recognition template. Note: It has a link. On clicking the link, the Deferred Revenue Recognition Template screen appears where you can view the details of the deferred revenue recognition template.
Distribution Code	Displays the distribution code which indicates the template associated with the deferred revenue recognition.
Financial Transaction Information	Displays the basic information about the financial transaction corresponding to the deferred revenue recognition. Note: It has a link. On clicking the link, the Financial Transaction Information screen appears where you can view the details of the financial transaction.

Field Name	Field Description
Total Revenue Deferred	Displays the total revenue deferred.
Total Revenue Recognized	Displays the total revenue recognized.
Status	Indicates the status of the deferred revenue recognition. The valid values are: <ul style="list-style-type: none"> • Active • Closed • Canceled • Draft

- **Related Deferred Revenue Recognitions** - Lists the related deferred revenue recognitions. It contains the following columns:

Column Name	Column Description
Deferred Revenue Recognition Information	Displays the basic information of the related Deferred Revenue Recognition Schedules (i.e. DRR Schedule of the BS/AD, corresponding to the BX/AX)
Create Date Time	Displays the date and time when the deferred revenue recognition is created.
Financial Transaction Information	Displays the basic information about the financial transaction corresponding to the deferred revenue recognition.

- **Record Actions** – This section contains the following buttons:

Button Name	Button Description
Edit	Used to define, edit and remove characteristics, related deferred revenue recognitions of the deferred revenue recognition.
	Note: The Edit button appears when the deferred revenue recognition is in the Active status.
Generate Schedule	Used to generate the deferred revenue recognition schedule.
	Note: The Generate Schedule button appears only when the deferred revenue recognition is in the Draft status.

- **Record Information** – This section contains the following fields:

Field Name	Field Description
Business Object	Indicates the business object using which the deferred revenue recognition is created. In addition, a context menu appears corresponding to this field which helps in navigating to other screens in the application.
	Note: It has a link. On clicking the link, the Business Object screen appears where you can view the details of the respective business object.
Create Date/Time	Displays the date and time when the deferred revenue recognition schedule is created.

Field Name	Field Description
Status Date/Time	Displays the date and time when the deferred revenue recognition status is updated.

- **Characteristics** – Lists the characteristics defined for the deferred revenue recognition. It contains the following columns:

Column Name	Column Description
Effective Date	Displays the date from when the characteristic is effective for the deferred revenue recognition.
Characteristic Type	Indicates the characteristic type.
Characteristic Value	Displays the value of the characteristic type.

Associated Deferred Revenue Recognitions

The **Associated Deferred Revenue Recognitions** zone Displays the basic information of the other schedules linked to the same **FT** having a separate **Schedule** due to the different **Distribution Code**. Purpose of this section is to show all the associated **Schedules** generated for a single **FT**. It contains the following columns:

Column Name	Column Description
Deferred Revenue Recognition Information	Displays information about the deferred revenue recognition.
	Note: It has a link. On clicking the link, the Deferred Revenue Recognition screen appears where you can view the details of the deferred revenue recognition.
Financial Transaction Information	Displays the basic information about the financial transaction corresponding to the deferred revenue recognition.
	Note: It has a link. On clicking the link, the Financial Transaction screen appears where you can view the details of the respective deferred revenue recognition.
Distribution Code	Displays the distribution code which indicates the template associated with the deferred revenue recognitions.
Deferred Revenue Recognition Template Information	Displays information about the deferred revenue recognition template.
	Note: It has a link. On clicking the link, the Deferred Revenue Recognition Template screen appears where you can view the details of the deferred revenue recognition template.
Status	Indicates the status of the associated deferred revenue recognition. The valid values are: <ul style="list-style-type: none"> • Active • Closed • Canceled

Recognition Schedule

The **Recognition Schedule** zone lists the adjustment information and the recognition amount of the deferred revenue recognition. It contains the following columns:

Column Name	Column Description
Recognition Date	Displays the date on which the recognition is scheduled.
Recognition Amount	Displays the amount of the recognition scheduled.
Adjustment Information	Displays information about the adjustments in recognition schedule.

This zone contains the **Edit** button. It is used to edit the details of recognition schedule

Note: This zone appears when the deferred revenue recognition is in the **Active** status.

Revenue Recognition Items

The **Revenue Recognition Items** zone displays the adjustment information about the recognition items. It contains the following columns:

Column Name	Column Description
Recognition Date	Displays the date on which the recognition is scheduled.
Recognition Amount	Displays the amount of the recognition scheduled.
Adjustment Information	Displays information about the adjustments in recognition schedule. “
	Note: It has a link. On clicking the link, the Adjustment screen appears where you can view the details of the deferred revenue recognition.

Deferred Revenue Recognition - Log

The **Log** tab contains the following zone:

- [Deferred Revenue Recognition Log](#) on page 2353

Deferred Revenue Recognition Log

The **Deferred Revenue Recognition Log** zone lists the complete trail of actions performed on the deferred revenue recognition. It contains the following columns:

Column Name	Column Description
Date/Time	Displays the date and time when the action was performed on the deferred revenue recognition
Details	Displays the details about the action performed on the deferred revenue recognition
User	Indicates the user who has performed the action on the deferred revenue recognition
Log Type	Indicates the type of log.
Related Object	Indicates the object or entity which is created when the action is performed on the deferred revenue recognition.
	Note: At present, no data appears in this column. The implementation team can build the custom logic to meet the business requirements.
Status Reason	Indicates the reason why the status of the deferred revenue recognition is changed.
	Note: At present, no data appears in this column. The implementation team can build the custom logic to meet the business requirements.

Note: You can manually add a log entry for the deferred revenue recognition by clicking the **Add Log Entry** link in the upper right corner of the **Deferred Revenue Recognition Log** zone.

Related Topics

For more information on...	See...
How to view the log of a deferred revenue recognition	Viewing the Log of a Deferred Revenue Recognition on page 2358
How to add a log entry for a deferred revenue recognition	Adding a Log Entry for a Deferred Revenue Recognition on page 2359

Editing a Deferred Revenue Recognition

Procedure

To edit a deferred revenue recognition:

1. Search for the deferred revenue recognition in the **Deferred Revenue Recognition** screen.
2. In the **Search Results** section, click the link in the **Deferred Revenue Recognition Information** column \orresponding to the deferred revenue recognition whose details you want to edit.
The **Deferred Revenue Recognition** screen appears.
3. Click the **Edit** button in the **Deferred Revenue Recognition** zone.
The **Deferred Revenue Recognition** screen appears.

Note: The **Edit** button appears when the deferred revenue recognition is in the **Active** status.

4. Modify the required details in the **Main** section.
5. Define, edit, or remove related deferred revenue recognitions from the deferred revenue recognition, if required.
6. Define, edit, or remove characteristics of the deferred revenue recognition, if required.
7. Click **Save**.

The changes made to the deferred revenue recognition are saved.

Related Topics

For more information on...	See...
Deferred Revenue Recognition screen	Deferred Revenue Recognition (Used for Viewing) on page 2350
Deferred Revenue Recognition zone	Deferred Revenue Recognition on page 2350
How to search for a deferred revenue recognition	Searching for a Deferred Revenue Recognition on page 2348
How to add related deferred revenue recognitions	Adding Related Deferred Revenue Recognitions on page 2356
How to define the characteristics for a deferred revenue recognition	Defining a Characteristic for a Deferred Revenue Recognition on page 2355

Creating the Deferred Revenue Recognition Schedule

Prerequisites

To create the deferred revenue recognition schedule, you should have:

- Should have **Revenue Recognition Schedule Creation Algorithm** attached in the **DRR Template**

Procedure

To create the deferred revenue recognition schedule:

1. Search for the deferred revenue recognition in the **Deferred Revenue Recognition** screen.
2. In the **Search Results** section, click the link in the **Deferred Revenue Recognition Information** column corresponding to the deferred revenue recognition whose recognition schedule you want to generate.

The **Deferred Revenue Recognition** screen appears.

3. Click the **Generate Schedule** button in the **Deferred Revenue Recognition** zone.

Note: The **Generate Schedule** button appears when the deferred revenue recognition is in the **Draft** status.

The status of the deferred revenue recognition is changed to **Active**.

Related Topics

For more information on...	See...
Deferred Revenue Recognition screen	Deferred Revenue Recognition (Used for Viewing) on page 2350
Deferred Revenue Recognition zone	Deferred Revenue Recognition on page 2350
How to search for a deferred revenue recognition	Searching for a Deferred Revenue Recognition on page 2348

Defining a Characteristic for a Deferred Revenue Recognition

Prerequisites

To define a characteristic for a deferred revenue recognition, you should have:

- Characteristic types defined in the application (where the characteristic entity is set to **Deferred Revenue Recognition**)

Procedure

To define a characteristic for a deferred revenue recognition:

1. Ensure that the **Characteristics** section is expanded when you are editing a deferred revenue recognition.

The **Characteristics** section contains the following fields in a grid:

Field Name	Field Description	Mandatory (Yes or No)
Effective Date	Used to specify the date from when the characteristic is effective for the deferred revenue recognition.	Yes (Conditional) Note: This field is required when you are defining a characteristic for the deferred revenue recognition.
Characteristic Type	Used to indicate the characteristic type. Note: The list includes only those characteristic types where the characteristic entity is set to Deferred Revenue Recognition .	Yes (Conditional) Note: This field is required when you are defining a characteristic for the deferred revenue recognition.

Field Name	Field Description	Mandatory (Yes or No)
Characteristic Value	Used to specify the value for the characteristic type.	Yes (Conditional)
	Note: On specifying the value for a characteristic type, the description of the characteristic value appears corresponding to the Characteristic Value field.	Note: This field is required when you are defining a characteristic for the deferred revenue recognition.

- Enter the required details in the **Characteristics** section.

Note: If you select a characteristic type, the **Search** (🔍) icon appears corresponding to the **Characteristic Value** field. On clicking the **Search** icon, you can search for a characteristic value.

- If you want to define more than one characteristic for the deferred revenue recognition, click the **Add** (+) icon and then repeat step 2.

Note: However, if you want to remove a characteristic from the deferred revenue recognition, click the **Delete** (🗑️) icon corresponding to the characteristic.

Related Topics

For more information on...	See...
How to edit a deferred revenue recognition	Editing a Deferred Revenue Recognition on page 2354

Adding Related Deferred Revenue Recognitions

Prerequisites

To add related deferred revenue recognitions, you should have:

- Deferred revenue recognition template defined in the system.

Procedure

To add related deferred revenue recognitions:

- Ensure that the **Related Deferred Revenue Recognitions** section is expanded when you are editing a deferred revenue recognition.

The **Related Deferred Revenue Recognitions** section contains the following fields:

Field Name	Field Description	Mandatory (Yes or No)
Deferred Revenue Recognition ID	Used to specify the ID of the deferred revenue recognition.	Yes
	Note: The Search (🔍) icon appears corresponding to this field. On clicking the Search icon, the Deferred Revenue Recognition Search window appears.	
Create Date Time	Used to indicate the creation date and time of the deferred revenue recognition.	Yes

Field Name	Field Description	Mandatory (Yes or No)
Financial Transaction ID	Used to specify the ID of the financial transaction corresponding to the deferred revenue recognition.	Yes
	Note: The Search (🔍) icon appears corresponding to this field. On clicking the Search icon, the Financial Transactions Search window appears.	

- Enter the required details in the **Related Deferred Revenue Recognitions** section.
- If you want to add more than one related deferred revenue recognition for the deferred revenue recognition, click the **Add** (+) icon and then repeat step 2.

Note: However, if you want to remove a related deferred revenue recognition from the deferred revenue recognition, click the **Delete** (🗑️) icon corresponding to the related deferred revenue recognition.

Related Topics

For more information on...	See...
How to edit a deferred revenue recognition	Editing a Deferred Revenue Recognition on page 2354

Editing the Deferred Revenue Recognition Schedule Details

Prerequisites

To edit the details of the deferred revenue recognition schedule, you should have:

- Should have **Allow Editing Switch** as **Yes** on deferred revenue recognition template.

Procedure

To edit the details of the deferred revenue recognition schedule:

- Search for the deferred revenue recognition in the **Deferred Revenue Recognition** screen.
- In the **Search Results** section, click the link in the **Deferred Revenue Recognition Information** column corresponding to the deferred revenue recognition whose deferred revenue recognition schedule details you want to edit.

The **Deferred Revenue Recognition** screen appears.

- Select the recognition whose details you want to edit in the **Recognition Schedule** zone and click the **Edit** button available in the upper left corner above the table in this zone.

The **Edit Recognition Schedule** screen appears.

Note: A recognition schedule from the deferred revenue recognition can be edited when the deferred revenue recognition is in the **Active** status.

The **Edit Recognition Schedule** screen contains the following fields:

Field Name	Field Description
Deferred Revenue Recognition Information	Displays the information about the deferred revenue recognition.
Financial Transaction Information	Displays the information of the financial transaction corresponding to the deferred revenue recognition.

In addition to these fields, this screen contains following columns:

Column Name	Column Description	Mandatory (Yes or No)
Recognition Date	Used to display the date on which the deferred revenue is recognized.	Yes
Recognition Amount	Used to display the amount of the deferred revenue.	Yes
Adjustment ID	Used to display the adjustment id.	Not applicable

- Modify the details of the recognition schedule.
- If you want to define more than one recognition schedule for the deferred revenue recognition, click the **Add (+)** icon and then repeat step 4.

Note: However, if you want to remove a recognition schedule from the deferred revenue recognition, click the **Delete (🗑)** icon corresponding to the recognition schedule.

- Click **Save**.

The changes made to the recognition schedule are saved.

Related Topics

For more information on...	See...
Recognition Schedule zone	Recognition Schedule on page 2352
How to search for a deferred revenue recognition	Searching for a Deferred Revenue Recognition on page 2348

Viewing the Log of a Deferred Revenue Recognition

Procedure

To view the log of a deferred revenue recognition:

- Search for the deferred revenue recognition in the **Deferred Revenue Recognition** screen.
- In the **Search Results** section, click the link in the **Deferred Revenue Recognition Information** column corresponding to the deferred revenue recognition whose log you want to view.

The **Deferred Revenue Recognition** screen appears. It consists of the following tabs:

- [Deferred Revenue Recognition - Main](#) on page 2350
- [Deferred Revenue Recognition - Log](#) on page 2353

- Click the **Log** tab.

The **Log** tab appears.

- View the complete trail of actions performed on the deferred revenue recognition in the **Deferred Revenue Recognition Log** zone.

Column Name	Column Description
Date/Time	Displays the date and time when the action was performed on the dispute request.
Details	Displays the details about the deferred revenue recognition log
User	Indicates the user who has performed deferred revenue recognition
Log Type	Indicates the type of log.

Column Name	Column Description
Related Object	Indicates the object or entity which is generated when the action is performed on the deferred revenue recognition
Status Reason	Displays the status reason of action performed on the deferred revenue recognition

Related Topics

For more information on...	See...
Deferred Revenue Recognition Log zone	Deferred Revenue Recognition Log on page 2353
How to search for a deferred revenue recognition	Searching for a Deferred Revenue Recognition on page 2348
How to add a log entry for a deferred revenue recognition	Adding a Log Entry for a Deferred Revenue Recognition on page 2359

Adding a Log Entry for a Deferred Revenue Recognition

Procedure

To add a log entry for a deferred revenue recognition:

1. Search for the deferred revenue recognition in the **Deferred Revenue Recognition** screen.
2. In the **Search Results** section, click the link in the **Deferred Revenue Recognition Information** column corresponding to the deferred revenue recognition whose log you want to edit.

The **Deferred Revenue Recognition** screen appears. It consists of the following tabs:

- [Deferred Revenue Recognition - Main](#) on page 2350
- [Deferred Revenue Recognition - Log](#) on page 2353

3. Click the **Log** tab.

The **Log** tab appears.

4. Click on the **Add Log Entry** link in the upper right corner of the **Deferred Revenue Recognition Log** zone.

The **Add Deferred Revenue Recognition Schedule Log** window appears. It contains the following fields:

Field Name	Field Description	Mandatory (Yes Or No)
Deferred Revenue Recognition Information	Displays information about the deferred revenue recognition.	Not applicable
Log Details	Used to specify additional comments for the deferred revenue recognition.	Yes

5. Enter the comments in the **Log Details** field.
6. Click **Save**.

The log entry is added in the **Deferred Revenue Recognition Log** zone.

Related Topics

For more information on...	See...
Deferred Revenue Recognition Log zone	Deferred Revenue Recognition Log on page 2353
How to search for a deferred revenue recognition	Searching for a Deferred Revenue Recognition on page 2348

Chapter 33

Reconciliation

Topics:

- [Pre-requisites](#)
- [Reconciliation Status Transition](#)
- [Pay Instruction Status Transition](#)
- [Discrepancy Report Status Transition](#)
- [EDI 820 File Format For Reconciliation](#)
- [Sample EDI 820 File Format](#)
- [Algorithms Used in C1-MemberReconType](#)
- [Algorithms Used in C1-MemberReconciliation](#)
- [Algorithms Used in C1-PayInstruction](#)
- [Algorithms Used in C1-MemberDiscReportType](#)
- [Algorithms Used in C1-DiscrepancyReport](#)
- [Reconciliation Type](#)
- [Reconciliation \(Used for Searching\)](#)
- [Reconciliation \(Used for Viewing\)](#)
- [Pay Instruction](#)
- [Discrepancy Report Type](#)
- [Discrepancy Report \(Used for Searching\)](#)
- [Discrepancy Report \(Used for Viewing\)](#)
- [Member Reconciliation Preference](#)

Oracle Revenue Management and Billing enables you to reconcile pay instructions received from the external system against the bill segments based on the account identifier, policy number, plan number, member identifier, and coverage period combination. The system enables you to upload a pay instruction file in the following formats:

- **CSV File Format** – You can upload pay instruction files in the CSV format from the specified location on the server using the **Pay Instruction CSV File Upload (C1-RECUP)** batch.
- **EDI 820 File Format** – You can upload pay instruction files in the EDI 820 file format from the specified location on the server using the **Upload Lockbox Payment and Pay Instruction Files (C1-PUPSG)** batch.

Note: The **BPR** tag in the EDI 820 file must be set to **I** to indicate that the file contains pay instructions for reconciliation.

While uploading pay instruction files, you need to specify the reconciliation type using which you want to create the reconciliation. A reconciliation type indicates the algorithm which validates the pay instruction file and creates a pay instruction for each record in the file. Two algorithm types named **C1-PAYINSUPL** and **C1-RECONPROC** are shipped with the product. You need to maintain separate reconciliation types for different file formats. If you want to use a reconciliation type while uploading a pay instruction file in the CSV format, you need to create an algorithm using the **C1-PAYINSUPL** algorithm type and attach it to the reconciliation type. However, if you want to use a reconciliation type while uploading a pay instruction file in the EDI 820 format, you need to create an algorithm using the **C1-RECONPROC** algorithm type and attach it to the reconciliation type.

Once a file is successfully validated, the reconciliation is created for the file in the **Draft** status. The reconciliation is immediately transitioned to the **Send Notification** status and the algorithms attached to the Send Notification status are executed. Once the To Do is created, the status of the reconciliation is changed to **Pending**. A pay instruction is created for each record in the file and its status is set to either **Pending** or **Error** depending on whether it is successfully validated or not.

You need to then specify the payment ID against which you want to reconcile the billed items for which you have received the pay instructions. Once you specify the payment information and submit the pay instructions for reconciliation, the payment amount is distributed against the reconciliation contract of the accounts for which you have received the pay instruction. The status of the reconciliation is changed to **Pending Reconciliation**.

On reconciling the pay instructions, the system finds the bill segment against which the pay instruction must be reconciled using the account identifier, policy

number, plan number, member identifier, and coverage period combination. Once the bill segment is identified, the transfer adjustment is created against the bill segment and offset adjustment is created against the respective reconciliation contract. If all pay instructions in the file are successfully reconciled, the status of the reconciliation is changed to **Completed**. However, if one or more pay instruction in the file could not be successfully reconciled, the status of the reconciliation is changed to **Open**. If a file contains a pay instruction for previous coverage period, then system checks whether there is any open pay instruction for that coverage period in the system and accordingly tries to reconcile the pay instruction. However, if an open pay instruction for that coverage period does not exist in the system, the system tries to reconcile the pay instruction against the billed item.

You may manually reconcile the pay instructions which are in the **Pending Reconciliation** status. Alternatively, you can execute the **Reconciliation Periodic Monitor (C1-RCNM)** batch at regular interval to reconcile the pay instructions.

During reconciliation, a pay instruction also goes through various statuses in its lifecycle. You may configure the following two batches to execute at the regular intervals:

- **Pay Instruction Periodic Monitor (for Pending Status) (C1-PIPMO)** – It monitors whether there are any pay instructions in the **Pending** status. If so, it tries to reconcile the pay instruction against a billed item. If the pay instruction is successfully reconciled, the status of the pay instruction is changed to **Completed**. However, if the pay instruction could not be reconciled, the status of the pay instruction is changed to **Open**.
- **Pay Instruction Periodic Monitor (for Open Status) (C1-PIMDF)** – It monitors whether there are any pay instructions in the **Open** status. If so, it tries to reconcile the pay instruction against a billed item. If the pay instruction is successfully reconciled, the status of the pay instruction is changed to **Completed**. However, if the pay instruction could not be reconciled, the status of the pay instruction is changed to **Open**.

If you cancel the payment tender, the payment and reconciliation associated with the payment are automatically canceled. The status of the reconciliation is changed to **Pending Cancellation**. And, the status of all pay instructions in the reconciliation is changed to **Canceled**. If required, you can manually cancel a reconciliation. However, you can cancel a reconciliation when it is in the **Open** or **Completed** status. On canceling a reconciliation, the status of the reconciliation is changed to **Pending Cancellation** and the status of all pay instructions in the reconciliation is changed to **Canceled**.

You need to configure the **Reconciliation Cancellation Periodic Monitor (C1-RCNMD)** batch to execute at the regular intervals. It monitors whether there are reconciliations in the **Pending Cancellation** status. If there is a reconciliation in the **Pending Cancellation** status, the status of the reconciliation is changed to **Canceled**.

The system enables you to create a copy of reconciliation when it is in the **Canceled** status. If the number of pay instructions in the reconciliation does not exceed the value specified in the **Defer Processing Count** option type of the **C1-RECDUPBH** feature configuration, a copy of the reconciliation and pay instructions is created in the real time (i.e. immediately). The status of the reconciliation is set to **Pending**. And, the status of the pay instruction is set to either **Pending** or **Error** depending on whether it is successfully validated or not.

However, if the number of pay instructions in the reconciliation exceeds the value specified in the **Defer Processing Count** option type of the **C1-RECDUPBH** feature configuration, a batch job is automatically created using the **Duplicate Reconciliation (C1-RECUD)** batch. A message appears indicating the batch job ID. This batch job creates a copy of the reconciliation and pay instructions. The status of the reconciliation is set to **Pending**. And, the status of the pay instruction is set to either **Pending** or **Error** depending on whether it is successfully validated or not.

If the policy number, plan number, and member identifier are specified in a pay instruction, then the pay instruction is reconciled at the main subscriber level. If the policy number and plan number are specified in a pay instruction, then the pay instruction is reconciled at the plan level. However, if the policy number is only specified in a pay instruction, then the pay instruction is reconciled at the policy level.

On reconciling, some pay instructions are fully reconciled against the bill segments, some pay instructions are partially reconciled against the bill segments, and some pay instructions are not reconciled against any bill segments. The system enables you to capture such discrepancies for the reporting purposes. If required, you can generate the discrepancy report at the file or account level. If you generate the discrepancy report at the file level, the system lists the following:

- All pay instructions in the file which were partially reconciled due to rate variance
- All pay instructions in the file which could not be reconciled as the amount was paid, but not yet billed

However, if you generate the discrepancy report at the account level, the system lists the following:

- All billed items which were partially reconciled against pay instructions due to rate variance
- All billed items which could not be reconciled as the amount was billed, but not yet paid
- All pay instructions for the account which could not be reconciled as the amount was paid, but not yet billed

While generating a discrepancy report, you need to specify the discrepancy report type using which you want to create the discrepancy report. Once you review and finalize the discrepancy report, its status is changed to **Completed**. At a time, you can only have one discrepancy report for the file or account in the **Pending** status. Until, you finalize a discrepancy report, you cannot create another discrepancy report for the file or account. Also, note that you can create a discrepancy report for a file only when its corresponding reconciliation is in the **Open** status.

The reconciliation process goes through various statuses in its entire lifecycle. For more information about the reconciliation statuses, see...

- [Reconciliation Status Transition](#) on page 2364
- [Pay Instruction Status Transition](#) on page 2365
- [Discrepancy Report Status Transition](#) on page 2367

Pre-requisites

To setup the Member to Member Reconciliation feature, you need to do the following:

- **Configure the following Characteristics:**
 - Define an account eligible for reconciliation process from an **On-Account Contract** of a Universal Generic account.
 - Populate the Policy ID, or Plan ID, or Membership ID linked with the billable charges.
- Define the bills having the status as **Completed** for reconciliation.
- Define the **Contract Types** for reconciliation.
- Ensure that payment on **Suspense Contract** is available to match against the bills.
- Configure the **Customer Class** algorithm for a payer account.

Reconciliation Status Transition

The following figure graphically indicates how a reconciliation goes through various statuses in its lifecycle:

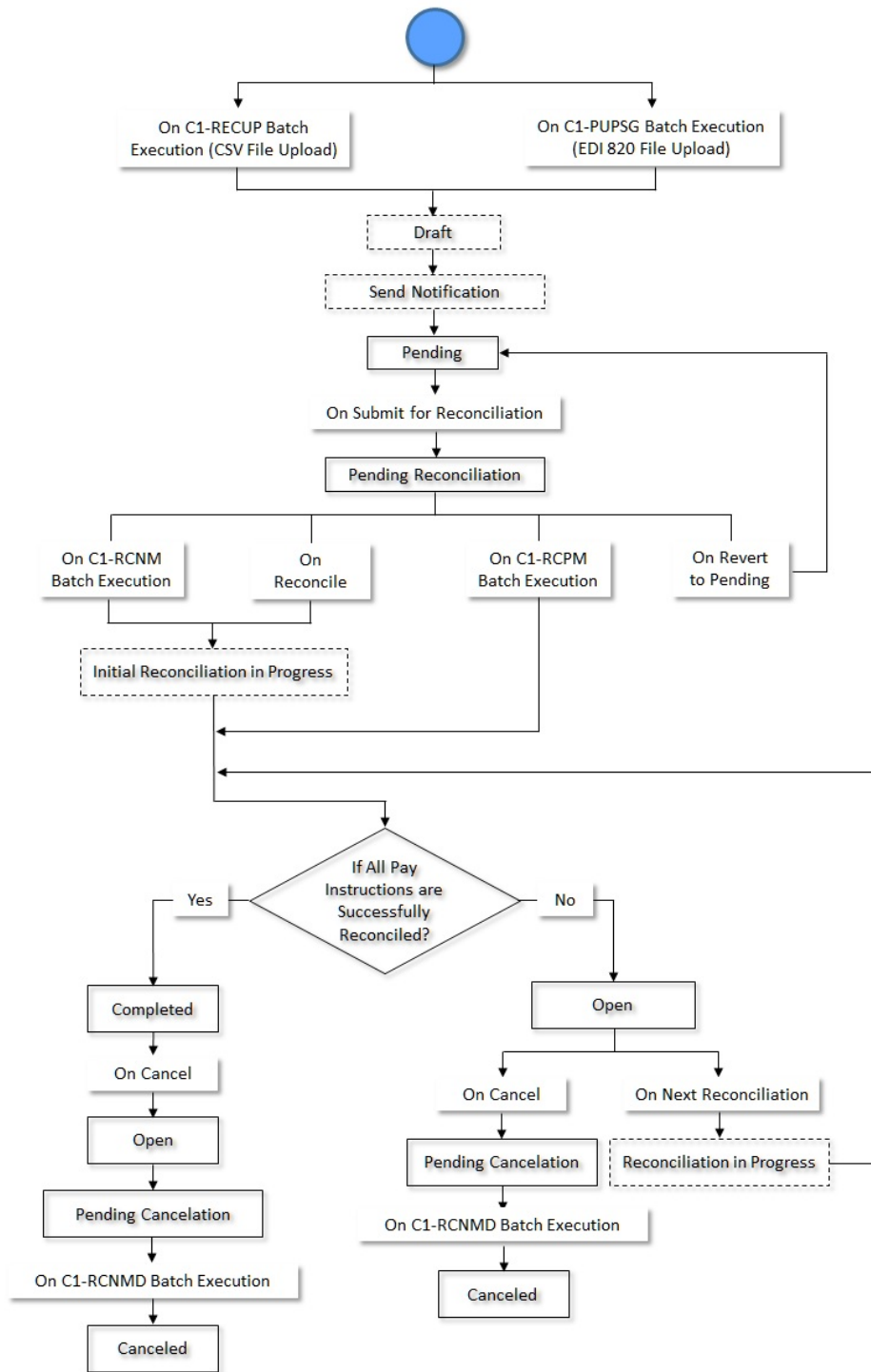

Pay Instruction Status Transition

The following figure graphically indicates how a pay instruction goes through various statuses in its lifecycle:

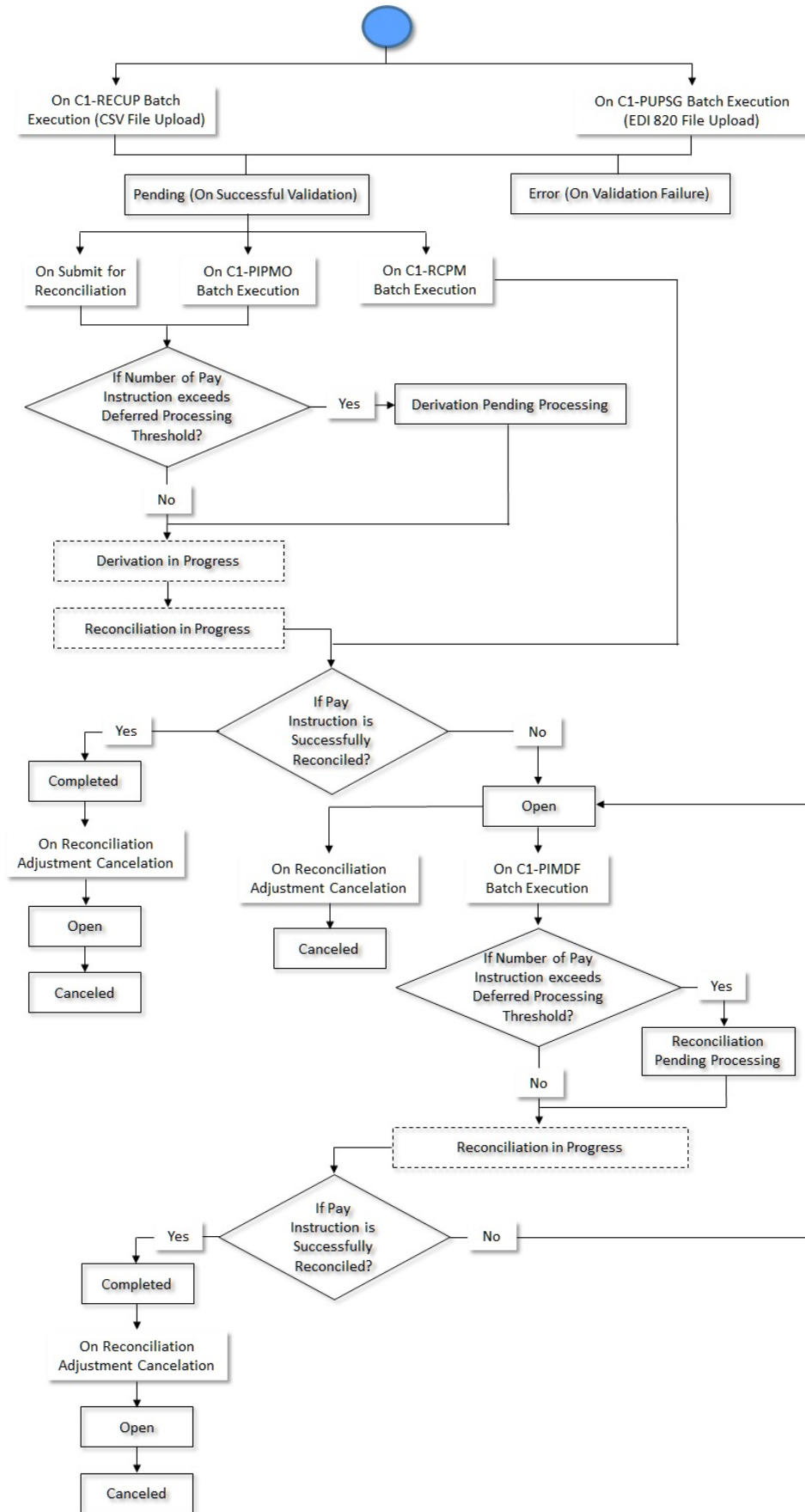

Discrepancy Report Status Transition

The following figure graphically indicates how a Discrepancy Report goes through various statuses in its lifecycle:

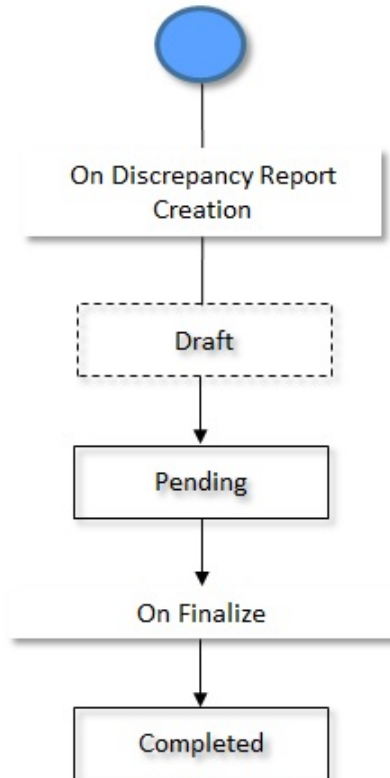

EDI 820 File Format For Reconciliation

Before uploading an EDI 820 file, you need to ensure that the EDI 820 file contains the following columns:

Tag	Attribute	Description	Mandatory (Yes or No)
Algo Param	Account Identifier Type	Used to specify the account identifier type. The valid values are: <ul style="list-style-type: none"> Account Name Base Global Account ID Bill Group Identifier Demo Bank Account Number External Account Identifier Flexcube Account ID International Bank Account Number 	Yes (Conditional)
			Note: This data is required when Account Identifier is provided.

Tag	Attribute	Description	Mandatory (Yes or No)
N1[3]	Account Identifier value	Used to specify the value of the account identifier type.	Yes (Conditional)
			Note: This data is required when Account Identifier Type is provided.
Batch Param	Member Identifier type	Used to specify the member identifier type.	Yes
RMR[2]	Policy Number	Used to specify the policy number of the member.	Yes
Algo Param	Plan Number	Used to specify the plan number of the member.	No
ENT[4]	Member Identifier Value	Used to specify the value of the member identifier type.	Yes
RMR[4]	Amount	Used to specify the amount that has to be paid to the member.	Yes
			Note: The data value of this column must be 0, if no amount is provided.
DTM[6]	Coverage Start Date	Used to specify the date of the policy from where the coverage starts.	Yes
		Note: The Coverage Start Date cannot be later than the coverage end date.	
DTM[6]	Coverage End Date	Used to specify the date of the policy till when the coverage ends.	Yes
		Note: The coverage end date cannot be earlier than the coverage start date.	
NM1[4] [5]	Member Name	Used to specify the name of the member.	Yes
REF[2]	Plan Number	Used to specify the plan number of the member.	Yes (Conditional)
			Note: This data is required when Algo Param tag does not have a value.
Batch Param	Reconciliation Type	Used to specify the type of reconciliation.	Yes
Batch Param	Reconciliation Cancel Status	Used to specify the Reconciliation Cancellation status.	Yes

Sample EDI 820 File Format

```
ISA*00**00**ZZ*USBANK*ZZ*UHGI*091212*1013*U*00401*000000005*0*P*~
GS*RA*LBTEST01*UHGI*20120912*1013*4*X*004010~
```

ST*CHK*000000001~
 BPR*I*100*C*NON*****1581282972*****20130326~
 DTM*582****RD8*20170101-20171231~
 N1*PE**FI*vinodwReconTest534~
 ENT*1*2J*EI*vinodwReconTest534~
 NM1*QE*1**vinodwReconTest534****N*11254331870~
 RMR*AZ*12345**0~
 DTM*582****RD8*20170401-20170430~
 ENT*1*2J*EI*vinodwReconTest534~
 NM1*QE*1**vinodwReconTest534****N*11254331870~
 RMR*AZ*12345**0~
 DTM*582****RD8*20170501-20170531~
 ENT*1*2J*EI*vinodwReconTest534~
 NM1*QE*1**vinodwReconTest534****N*11254331870~
 RMR*AZ*12345**0~
 DTM*582****RD8*20170601-20170630~
 SE*1*000000001~
 GE*1*135260~
 IEA*1*505043666~

Here the tags ISA and IEA resemble Bank Details, whereas LBTEST01 indicates Tender Source information.

Tags like GS and GE, ST and SE are known as Start and End Tags. All of the other tags are embedded inside these Start and End tags.

For more information about the EDI 820 file format, see topic [EDI 820 File Format For Reconciliation](#) on page 2367

Algorithms Used in C1-MemberReconType

The following table lists the algorithms which are attached to the **C1-MemberReconType** business object:

System Event	Algorithm	Algorithm Type	Description
Pre-Processing	C1-REOCNPEP	C1-REOCNPEP	Refer to C1-REOCNPEP on page 2369

C1-REOCNPEP

This algorithm validates a reconciliation type.

It checks the following:

- A duplicate algorithm is not added.
- A duplicate characteristic type is not added.

In addition, it does not allow you to:

- Delete a reconciliation type when the corresponding reconciliation is in a status other than **Completed** or **Canceled**.

Algorithms Used in C1-MemberReconciliation

The following table lists the algorithms which are attached to the **C1-MemberReconciliation** business object:

System Event	Algorithm	Algorithm Type	Description
Information	C1-RECONINFO	C1-RECONINFO	Refer to C1-RECONINFO on page 2371
Validation	C1-MRECONVAL	C1-MRECONVAL	Refer to C1-MRECONVAL on page 2371

The following table lists the algorithms which are used in the lifecycle of the **C1-MemberReconciliation** business object:

Status	System Event	Algorithm	Algorithm Type	Description
Draft	-	-	-	-
Send Notification	Monitor	F1-AT-RQJ	F1-GEN-BOMNJ	Refer to F1-AT-RQJ on page 1567
Send Notification	Enter	C1-RCNCRETD	F1-TDCREATE	Refer to F1-TDCREATE on page 2372
Pending	Enter	C1-VALPAYINS	C1-VALPAYINS	Refer to C1-VALPAYINS on page 2372
Pending	Exit	F1-TODOCOMPL	F1-TODOCOMPL	Refer to F1-TODOCOMPL on page 1566
Pending Reconciliation	Monitor	F1-AT-RQJ	F1-GEN-BOMNJ	Refer to F1-AT-RQJ on page 1567
Pending Reconciliation	Enter	C1-RECONVAL	C1-RECONVAL	Refer to C1-MRECONVAL on page 2371
Initial Reconciliation In Progress	Monitor	C1-MONPAYINS	C1-MONPAYINS	Refer to C1-MONPAYINS on page 2373
Initial Reconciliation In Progress	Enter	C1-TRNPAYRCN	C1-TRNPAYRCN	Refer to C1-TRNPAYRCN on page 2373
Initial Reconciliation In Progress	Enter	C1-RCOPNPYIN	C1-RCOPNPYIN	Refer to C1-RCOPNPYIN on page 2374
Initial Reconciliation In Progress	Exit	C1-RCNOPNMR	C1-RCNOPNMR	Refer to C1-RCNOPNMR on page 2374
Open	-	-	-	-
Reconciliation Progress	In Monitor	C1-MONPAYINS	C1-MONPAYINS	Refer to C1-MONPAYINS on page 2373
Reconciliation Progress	In Exit	C1-RCOPNPYIN	C1-RCOPNPYIN	Refer to C1-RCOPNPYIN on page 2374
Completed	-	-	-	-

Status	System Event	Algorithm	Algorithm Type	Description
Pending Cancellation	Monitor	C1-RCMONPNCN	C1-GNBOMNRSN	Refer to C1-RCMONPNCN on page 2374
Cancelled	Enter	C1-CANPAYINS	C1-CANPAYINS	Refer to C1-CANPAYINS on page 2375
Cancelled	Enter	C1-CANRCNPAY	C1-CANRCNPAY	Refer to C1-CANRCNPAY on page 2375
Cancelled	Enter	C1-RCNCANLTD	F1-TDCREATE	Refer to C1-RCNCANLTD on page 2375
Void	-	-	-	-

C1-RECONINFO

This algorithm generates the reconciliation information string which appears throughout the application. It concatenates the following fields separated by a comma in the specified order:

- Reconciliation Type Description
- Reconciliation Status
- Reconciliation ID

C1-MRECONVAL

This algorithm is invoked when you submit the pay instruction file for reconciliation. It checks the following:

- The payment is not associated with any other reconciliation which is in the status other than **Pending Cancellation** or **Canceled**.
- The payment ID and payor account ID are both available for further processing.

It contains the following parameters:

- **Reconciliation Canceled Status** – Used to specify the status code to which the reconciliation in the **Pending Cancellation** status is transitioned when the **Reconciliation Cancellation Periodic Monitor (C1-RCNMD)** batch is executed.
- **Reconciliation Pending Cancellation Status** - Used to specify the status code to which the reconciliation is transitioned when you click the **Cancel** button.

Both these parameters are mandatory.

F1-AT-RQJ

This algorithm transitions the current status of the business object to the specified status. It contains the following parameters:

- **Next Status** – Used when you want to override the default next status specified in the lifecycle.
- **Next Transition Condition** – Used when you want to override the default next transition condition specified in the lifecycle.

At a time, you can specify value for either the **Next Status** or **Next Transition Condition** parameter. If you don't specify any value for these parameters, the system will transition the business object to the default next status specified in its lifecycle.

F1-TDCREATE

This algorithm is invoked when the status of the reconciliation is changed to **Send Notification**. It creates a To Do using the specified To Do type and assigns it to users with the specified To Do role.

It contains the following parameters:

- **To Do Type** – Used to specify the type of notification that you want to generate when the reconciliation is created for a pay instruction file.
- **To Do Role** – Used to specify the To Do role to indicate the users to whom you want to send the notification when the reconciliation is created for a pay instruction file.

The rest of the parameters, such as **To Do Type Element Name**, **To Do Role Element Name**, **Message Category**, **Message Number**, **Characteristic Type For Log Entry**, **To Do Sort Keys Retriever Script**, **Discard Cancel Terminate Reason Element**, **Discard Cancel Terminate Reason**, **Retry Frequency**, and **Retry Frequency Element Name**, are not used at the moment.

C1-VALPAYINS

This algorithm is invoked when the status of the reconciliation is changed to **Pending**. Once a pay instruction is created, this algorithm validates the following:

- The coverage end date is not earlier than the coverage start date.
- Either the account identifier type and account identifier or the account ID is available in the pay instruction record.
- The member identifier type is available when the member identifier is specified and vice versa.
- A person with the given member identifier type and member identifier combination exists in the system.
- An account with the specified account ID exists in the system.
- The account ID is derived using the account identifier type and account identifier combination when the account ID is not available in the pay instruction record.
- The account is eligible for reconciliation.

If the above mentioned validations are successful, the status of the pay instruction is set to **Pending**. However, if any of the above validation fails, the status of the pay instruction is set to **Error**.

This algorithm contains the following parameters:

- **Eligible for Reconciliation Characteristic Type** – Used to specify the characteristic type which indicates whether the account is eligible for reconciliation. This type of characteristic is defined on the account. You must specify a characteristic type where the characteristic entity is set to Account.
- **Maintenance Object for Generating Pay Instruction Logs** – Used to specify the maintenance object using which you want to generate logs for the pay instruction.
- **Pay Instruction Error Status** – Used to specify the status code to which you want to transition the pay instruction when the validation fails.
- **Pay Instruction Pending Status** – Used to specify the status code to which you want to transition the pay instruction when the validation is successful.

All these parameters are mandatory.

F1-TODOCOMPL

This algorithm completes To Do entries that are created for the business object when the business object exits the given status. It finds and completes all open To Do entries where the business object's primary key is defined as a drill key. However, if the **Exclude To Do Entries From Auto Completion** characteristic is set to **Y** for the business object, the system does not automatically complete the respective To Do entry.

C1-MRECONVAL

This algorithm is invoked when you submit the pay instruction file for reconciliation. It checks the following:

- The payment is not associated with any other reconciliation which is in the status other than **Pending Cancellation** or **Canceled**.
- The payment ID and payor account ID are both available for further processing.

It contains the following parameters:

- **Reconciliation Canceled Status** – Used to specify the status code to which the reconciliation in the **Pending Cancellation** status is transitioned when the **Reconciliation Cancellation Periodic Monitor (C1-RCNMD)** batch is executed.
- **Reconciliation Pending Cancellation Status** - Used to specify the status code to which the reconciliation is transitioned when you click the **Cancel** button.

Both these parameters are mandatory.

C1-MONPAYINS

This algorithm is invoked when the status of the reconciliation is changed to **Initial Reconciliation in Progress** or **Reconciliation in Progress**. It monitors or checks whether there are any pay instructions in the following statuses:

- Reconciliation Pending Processing
- Derivation Pending Processing
- Completed

If all pay instructions in the reconciliation are in the **Completed** status, then the status of the reconciliation is changed to **Completed**. However, if there are any pay instructions in the **Reconciliation Pending Processing** or **Derivation Pending Processing** status, then the status of reconciliation is changed to **Open**.

This algorithm contains the following parameters:

- **Pay Instruction Derivation Pending Processing Status** - Used to specify the status code to which the pending pay instruction is transitioned when the number of pay instructions in the reconciliation exceeds the deferred processing threshold (specified in an algorithm which is created using the **C1-RCOPNPYIN** algorithm type).
- **Pay Instruction Reconciliation Pending Processing Status** - Used to specify the status code to which the open pay instruction is transitioned when the number of pay instructions in the reconciliation exceeds the deferred processing threshold (specified in an algorithm which is created using the **C1-RCOPNPYIN** algorithm type).
- **Pay Instruction Completed Status** - Used to specify the status code to which the pay instruction is transitioned when it is fully reconciled.
- **Reconciliation Open Status** - Used to specify the status code to which you want to transition the reconciliation when there is a pay instruction in the status which is specified in the **Pay Instruction Derivation Pending Processing Status** or **Pay Instruction Reconciliation Pending Processing Status** parameter.
- **Reconciliation Completed Status** - Used to specify the status code to which you want to transition the reconciliation when all its pay instructions are in the status which is specified in the **Pay Instruction Completed Status** parameter.

All these parameters are mandatory.

C1-TRNPAYRCN

This algorithm transfers the payment amount from the payor account's contract to the reconciliation contract of the accounts for which you have received the pay instruction. In this process, the payment against the payor account's contract is canceled and the payment against the payee account's reconciliation contract is created in the **Frozen** status.

It contains the following parameters:

- **Payment Cancel Reason** – Used to indicate the reason that you want to use when the payment on the payor account's contract is canceled.
- **Reconciliation Contract Match Type** – Used to specify the match type using which you want to apply payment against the reconciliation contract.

Both these parameters are mandatory.

C1-RCOPNPYIN

This algorithm checks whether the number of pay instructions in the reconciliation exceeds the limit defined in the **Deferred Processing Threshold** parameter. If the status of the pay instruction is **Pending** and the number of pay instructions in the reconciliation exceeds the limit defined in the **Deferred Processing Threshold** parameter, then the status of the pay instruction is changed to the value defined in the **Pay Instruction Derivation Pending Processing Status** parameter.

However, if the status of the pay instruction is **Open** and the number of pay instructions in the reconciliation exceeds the limit defined in the **Deferred Processing Threshold** parameter, then the status of the pay instruction is changed to the value defined in the **Pay Instruction Reconciliation Pending Processing Status** parameter.

It contains the following parameters:

- **Pay Instruction Pending Status** – Used to specify the status code to which a pay instruction is transitioned when its validation is successful.
- **Pay Instruction Open Status** – Used to specify the status code to which a pay instruction is transitioned when it is not fully reconciled.
- **Pay Instruction Derivation Pending Processing Status** – Used to specify the status code to which you want to transition the pending pay instruction when the number of pay instructions in the reconciliation exceeds the deferred processing threshold limit.
- **Pay Instruction Reconciliation Pending Processing Status** – Used to specify the status code to which you want to transition the open pay instruction when the number of pay instructions in the reconciliation exceeds the deferred processing threshold limit.
- **Deferred Processing Threshold** – Used to specify the maximum number of pay instructions that can be reconciled in the real time (i.e. immediately). If the number of pay instructions in the reconciliation exceeds the deferred processing threshold limit, the pay instruction is reconciled in the deferred mode.

All these parameters are mandatory.

C1-RCNOPNMR

This algorithm initiates the reconciliation process for the past open reconciliation records of the account. It contains the following parameters:

- **Reconciliation Open Status** – Used to specify the status code to which the reconciliation is transitioned when its pay instruction is not fully reconciled.
- **Reconciliation In Progress Status** – Used to specify the status code to which you want to transition the past open reconciliation record when the current reconciliation record of the account is reconciled.

Both these parameters are mandatory.

C1-RCMONPNCN

This algorithm is invoked when the **Reconciliation Cancellation Periodic Monitor (C1-RCNMD)** batch is executed. It checks whether the reason is specified while canceling the reconciliation. If the cancel reason is specified, the status of the reconciliation is changed to **Canceled**. However, if the cancel reason is not specified, an error occurs while executing the **Reconciliation Cancellation Periodic Monitor (C1-RCNMD)** batch.

It contains the following parameters:

- **Reconciliation Cancel Status Reason -**

Used to specify the cancel reason. If you specify the value for this parameter, the system will validate whether the cancel reason specified while canceling the reconciliation matches the cancel reason specified in this parameter. If the cancel reason does not match, an error occurs while executing the **Reconciliation Cancellation Periodic Monitor (C1-RCNMD)** batch. You must specify a reason which is defined for the **Pending Cancellation** status of the **C1-MemberReconciliation** business object.

C1-CANPAYINS

This algorithm is invoked when the **Reconciliation Cancellation Periodic Monitor (C1-RCNMD)** batch is executed. It changes the status of all pay instructions in the reconciliation.

It contains the following parameter:

- **Pay Instruction Canceled Status** – Used to specify the status code to which you want to transition a pay instruction when the reconciliation is canceled. This parameter is mandatory.

C1-CANRCNPAY

This algorithm transfers the payment amount from the payee account's reconciliation contract to the payor account's contract. In this process, the payment against the reconciliation contract is canceled and the payment against the payor account's contract is created in the **Frozen** status.

It contains the following parameters:

- **Payment Cancel Reason** – Used to indicate the reason that you want to use when the payment against the payee account's reconciliation contract is canceled.
- **On Account Match Type** – Used to specify the match type using which you want to apply the payment against the contract of the payor account.

Both these parameters are mandatory.

C1-RCNCANLTD

This algorithm is invoked when the status of the reconciliation is changed to **Canceled**. It creates a To Do using the specified To Do type and assigns it to users with the specified To Do role.

It contains the following parameters:

- **To Do Type** – Used to specify the type of notification that you want to generate when the reconciliation is canceled.
- **To Do Role** – Used to specify the To Do role to indicate the users to whom you want to send the notification when the reconciliation is canceled.

The rest of the parameters, such as **To Do Type Element Name**, **To Do Role Element Name**, **Message Category**, **Message Number**, **Characteristic Type For Log Entry**, **To Do Sort Keys Retriever Script**, **Discard Cancel Terminate Reason Element**, **Discard Cancel Terminate Reason**, **Retry Frequency**, and **Retry Frequency Element Name**, are not used at the moment.

Algorithms Used in C1-PayInstruction

The following table lists the algorithms which are attached to the **C1-PayInstruction** business object:

System Event	Algorithm	Algorithm Type	Description
Information	C1-MPAYININF	C1-MPAYININF	Refer to C1-MPAYININF on page 2376

The following table lists the algorithms which are used in the lifecycle of the **C1-PayInstruction** business object:

Status	System Event	Algorithm	Algorithm Type	Description
Pending	-	-	-	-
Derivation In Progress	Enter	C1-PYINDRVAN	C1-PYINDRVAN	Refer to C1-PYINDRVAN on page 2376
Reconciliation In Progress	Enter	C1-PIRECOCIL	C1-PIRECOCIL	Refer to C1-PIRECOCIL on page 2377
Open	-	-	-	-
Complete	-	-	-	-
Cancelled	Enter	C1-PYICNADJ	C1-PYICNADJ	Refer to C1-PYICNADJ on page 2378
Derivation Pending Processing	Monitor	F1-AT-RQJ	F1-GEN-BOMNJ	Refer to F1-AT-RQJ on page 1567
Reconciliation Pending Processing	Monitor	F1-AT-RQJ	F1-GEN-BOMNJ	Refer to F1-AT-RQJ on page 1567
Error	-	-	-	-

C1-MPAYININF

This algorithm generates the pay instruction information string which appears throughout the application. It concatenates the following fields separated by a comma in the specified order:

- “Period:” Start Date - End Date
- Pay Instruction Amount
- Pay Instruction Status
- Payor Name
- Pay Instruction ID

C1-PYINDRVAN

This algorithm is invoked when the status of the pay instruction is changed to **Derivation in Progress**. It derives the following:

- Policy using the policy number
- Plan using the plan number
- Member using the member identifier type and member identifier
- Payee account using the account identifier type and account identifier

If the policy, plan, and member information is available, it validates whether the member is covered under the specified plan of the policy. However, if the policy and plan information is available, it validates whether the plan is included in the specified policy. If the derivation and validation process is successful, the related object information is derived for policy, plan, and/or member from the system.

However, if the derivation and validation process fails, the related object information is not derived for policy, plan, and/or member and the status of the pay instruction remains as **Pending**.

In addition, the system determines whether the pay instruction must be reconciled at the member, plan, or policy level depending on the information available in the pay instruction. If the policy, plan, and member information is available, the pay instruction is reconciled at the member level. If the policy and plan information is available, the pay instruction

is reconciled at the policy plan level. However, if the policy information is available, the pay instruction is reconciled at the policy level.

It contains the following parameters:

- **Unsuccessful Processing Status** – Used to specify the status code to which you want to transition the pay instruction when the derivation and validation process fails.
- **Pay Instruction Matching Level Characteristic Type** – Used to specify the characteristic type which indicates whether the pay instruction must be reconciled at the member, plan, or policy level. This type of characteristic is defined on the pay instruction. Here, you must specify a characteristic type where the characteristic entity is set to **Payment Instruction**.
- **Member Matching Level Characteristic Value** – Used to specify the value that you want to define for the characteristic type specified in the **Pay Instruction Matching Level Characteristic Type** parameter when the pay instruction must be reconciled at the member level.
- **Plan Matching Level Characteristic Value** - Used to specify the value that you want to define for the characteristic type specified in the **Pay Instruction Matching Level Characteristic Type** parameter when the pay instruction must be reconciled at the policy plan level.
- **Policy Matching Level Characteristic Value** - Used to specify the value that you want to define for the characteristic type specified in the **Pay Instruction Matching Level Characteristic Type** parameter when the pay instruction must be reconciled at the policy level.

All these parameters are mandatory.

C1-PIRECOCIL

This algorithm is invoked when the status of the pay instruction is changed to **Reconciliation in Progress**. It searches whether there is an open bill segment with the policy, plan, member, and coverage period combination for the payee account. If such bill segment exists in the system, this algorithm reconciles the pay instruction against the open bill segment. It creates two reconciliation adjustments – one against the payee account’s reconciliation contract and another against the bill segment’s contract.

If the amount on the pay instruction is fully reconciled, then the status of the pay instruction is changed to **Completed**. However, if the amount on the pay instruction is not fully reconciled, then the status of the pay instruction is changed to **Open**.

It contains the following parameters:

- **Pay Instruction Matching Level Characteristic Type** – Used to specify the characteristic type which indicates whether the pay instruction must be reconciled at the member, plan, or policy level. This type of characteristic is defined on the pay instruction. Here, you must specify a characteristic type where the characteristic entity is set to **Payment Instruction**.
- **Member Matching Level Characteristic Value** – Used to specify the value of the characteristic type specified in the **Pay Instruction Matching Level Characteristic Type** parameter which indicates that the pay instruction must be reconciled at the member level.
- **Plan Matching Level Characteristic Value** – Used to specify the value of the characteristic type specified in the **Pay Instruction Matching Level Characteristic Type** parameter which indicates that the pay instruction must be reconciled at the policy plan level.
- **Policy Matching Level Characteristic Value** – Used to specify the value of the characteristic type specified in the **Pay Instruction Matching Level Characteristic Type** parameter which indicates that the pay instruction must be reconciled at the policy level.
- **Adjustment Type for Bill Segment Contract** – Used to specify the adjustment type using which you want to create the adjustment on the bill segment’s contract when the pay instruction is reconciled.
- **Adjustment Type for Reconciliation Contract** – Used to specify the adjustment type using which you want to create the adjustment on the reconciliation contract when the pay instruction is reconciled.

- **Reconciliation Open Status** – Used to specify the status code to which you want to transition the reconciliation when the status of the pay instruction is changed to **Open**.
- **Pay Instruction Open Status** – Used to specify the status code to which you want to transition the pay instruction when it is not fully reconciled.
- **Pay Instruction Completed Status** – Used to specify the status code to which you want to transition the pay instruction when it is fully reconciled.
- **Reconciliation Characteristic Type** – Used to specify the characteristic type which you want to use to store the reconciliation ID. This type of characteristic is defined on the adjustments which are created on reconciliation. Here, you must specify a characteristic type where the characteristic entity is set to **Adjustment Type**.
- **Payment Event Characteristic Type** – Used to specify the characteristic type which you want to use to store the payment event ID. This type of characteristic is defined on the reconciliation adjustments to indicate the payment event whose payment is distributed against the bill segment.
- **Adjustment Type for Offsetting Debits against Billed Credits** – Used to specify the adjustment type using which you want to create the adjustments when offsetting billed debit verses billed credits.

All these parameters are mandatory.

C1-PYICNADJ

This algorithm is invoked when the status of the pay instruction is changed to **Canceled**. It cancels the reconciliation adjustments which are created while reconciling the pay instruction. It cancels the reconciliation adjustment irrespective of whether the status of the pay instruction is **Open** or **Completed**.

It contains the following parameters:

- **Adjustment Cancel Reason** – Used to indicate the reason that you want to use when the reconciliation adjustments are canceled.
- **Pay Instruction Completed Status** – Used to specify the status code to which the pay instruction is transitioned when it is fully reconciled.
- **Pay Instruction Open Status** – Used to specify the status code to which the pay instruction is transitioned when it is not fully reconciled.
- **Reconciliation Completed Status** – Used to specify the status code to which the reconciliation is transitioned when all its pay instructions are fully reconciled.
- **Reconciliation Open Status** – Used to specify the status code to which the reconciliation is transitioned when its pay instruction is not fully reconciled.

All these parameters are mandatory.

F1-AT-RQJ

This algorithm transitions the current status of the business object to the specified status. It contains the following parameters:

- **Next Status** – Used when you want to override the default next status specified in the lifecycle.
- **Next Transition Condition** – Used when you want to override the default next transition condition specified in the lifecycle.

At a time, you can specify value for either the **Next Status** or **Next Transition Condition** parameter. If you don't specify any value for these parameters, the system will transition the business object to the default next status specified in its lifecycle.

Algorithms Used in C1-MemberDiscReportType

The following table lists the algorithms which are attached to the **C1-MemberDiscReportType** business object:

System Event	Algorithm	Algorithm Type	Description
Pre-Processing	C1-DISCPEP	C1-DISCPEP	Refer to C1-DISCPEP on page 2379

C1-DISCPEP

This algorithm validates a discrepancy report type. It checks the following:

- A duplicate characteristic type is not added.

In addition, it does not allow you to:

- Delete a discrepancy report type when the corresponding discrepancy report is in a status other than **Completed**.

Algorithms Used in C1-DiscrepancyReport

The following table lists the algorithms which are attached to the **C1-DiscrepancyReport** business object:

System Event	Algorithm	Algorithm Type	Description
Information	C1-DISRINFO	C1-DISRINFO	Refer to C1-DISRINFO on page 2379

The following table lists the algorithms which are used in the lifecycle of the **C1-DiscrepancyReport** business object:

Status	System Event	Algorithm	Algorithm Type	Description
Draft	Monitor	F1-AT-RQJ	F1-GEN-BOMNJ	Refer to F1-AT-RQJ on page 1567
	Enter	C1-VALNEWDIS	C1-VALNEWDIS	Refer to C1-VALNEWDIS on page 2380
Pending	Enter	C1-CRDSLNTM	C1-CRDSLNTM	Refer to C1-CRDSLNTM on page 2380
	Exit	F1-TODOCOMPL	F1-TODOCOMPL	Refer to F1-TODOCOMPL on page 1566
Completed	Enter	C1-VALCMPDIS	C1-VALCMPDIS	Refer to C1-VALCMPDIS on page 2380

F1-AT-RQJ

This algorithm transitions the current status of the business object to the specified status. It contains the following parameters:

- **Next Status** – Used when you want to override the default next status specified in the lifecycle.
- **Next Transition Condition** – Used when you want to override the default next transition condition specified in the lifecycle.

At a time, you can specify value for either the **Next Status** or **Next Transition Condition** parameter. If you don't specify any value for these parameters, the system will transition the business object to the default next status specified in its lifecycle.

C1-DISRINFO

This algorithm generates the discrepancy report information string which appears throughout the application. It concatenates the following fields separated by a comma in the specified order:

- Discrepancy Report Type Description
- Discrepancy Report Status

- Discrepancy Report ID

C1-VALNEWDIS

This algorithm allows you to create a discrepancy report when the following conditions are met:

- The account for which discrepancy report is created is eligible for reconciliation.
- A discrepancy report in the **Pending** status does not exist for the account or file.
- A reconciliation record in the **Open** status exists for the account or file.

It contains the following parameters:

- **Eligible for Reconciliation Characteristic Type** – Used to specify the characteristic type which indicates whether the account is eligible for reconciliation. Here, you must specify a characteristic type where the characteristic entity is set to **Account**.
- **Eligible for Reconciliation Characteristic Value** – Used to specify the value of the characteristic type specified in the **Eligible for Reconciliation Characteristic Type** parameter which indicates that the account is eligible for reconciliation.

Both these parameters are mandatory.

C1-CRDSLNTM

This algorithm is invoked when the status of the discrepancy report is changed to **Pending**. If the discrepancy report is created at the account level, this algorithm creates a discrepancy line item for each policy, plan, member, and coverage period combination for which there is an open bill segment for the account and for which there are open and pending pay instructions in the open reconciliation.

However, if the discrepancy report is created at the file level, this algorithm creates a discrepancy line item for each policy, plan, member, and coverage period combination for which there are open and pending pay instructions in the open reconciliation. Note that the discrepancy line items are created for each account whose pay instructions are received in the pay instruction file.

It contains the following parameters:

- **Consumer Status Characteristic Type** – Used to specify the characteristic type which stores the consumer status of the member. The system retrieves the consumer status of the member and stores it against the respective discrepancy line item. Here, you must specify a characteristic type where the characteristic entity is set to **Person**. This parameter is mandatory.

F1-TODOCOMPL

This algorithm completes To Do entries that are created for the business object when the business object exits the given status. It finds and completes all open To Do entries where the business object's primary key is defined as a drill key. However, if the **Exclude To Do Entries From Auto Completion** characteristic is set to **Y** for the business object, the system does not automatically complete the respective To Do entry.

C1-VALCMPDIS

This algorithm is invoked when you click the **Finalize** button. It changes the status of the discrepancy report to **Completed** when the discrepancy category is specified for each discrepancy line item in the report.

Reconciliation Type

Oracle Revenue Management and Billing allows you to define a reconciliation type using which you can create the reconciliation. It is the reconciliation type which helps the system to determine:

- The business object using which the reconciliation should be created.

- The file format through which the pay instruction records can be uploaded in the system.

In addition, a reconciliation type indicates the algorithm which validates the pay instruction file and creates a pay instruction for each record in the file. Two algorithm types named **C1-PAYINSUPL** and **C1-RECONPROC** are shipped with the product. You need to maintain separate reconciliation types for different file formats. If you want to use a reconciliation type while uploading a pay instruction file in the CSV format, you need to create an algorithm using the **C1-PAYINSUPL** algorithm type and attach it to the reconciliation type. However, if you want to use a reconciliation type while uploading a pay instruction file in the EDI 820 format, you need to create an algorithm using the **C1-RECONPROC** algorithm type and attach it to the reconciliation type.

The **Reconciliation Type** screen allows you to define, edit, copy, and delete a reconciliation type. It contains the following zones:

- [Reconciliation Type List](#) on page 2381
- [Reconciliation Type](#) on page 2381

Reconciliation Type List

The **Reconciliation Type List** zone lists the reconciliation types that are already defined in the system. It contains the following columns:

Column Name	Column Description
Reconciliation Type	Displays the reconciliation type.
Description	Displays the description of the reconciliation type.
Edit	On clicking the Edit (✎) icon, the Reconciliation Type screen appears where you can edit the details of the reconciliation type.
Duplicate	On clicking the Duplicate (📄) icon, the Reconciliation Type screen appears where you can define a new reconciliation type using an existing reconciliation type.
Delete	On clicking the Delete (🗑) icon, you can delete the reconciliation type. Note: You can delete a reconciliation type when you have not created a reconciliation using the reconciliation type.

On clicking the **Broadcast** (📡) icon corresponding to a reconciliation type, the **Reconciliation Type** zone appears with the details of the respective reconciliation type.

Related Topics

For more information on...	See...
How to edit a reconciliation type	Editing a Reconciliation Type on page 2387
How to delete a reconciliation type	Deleting a Reconciliation Type on page 2388
How to copy a reconciliation type	Copying a Reconciliation Type on page 2389
How to view the details of a reconciliation type	Viewing the Reconciliation Type Details on page 2390

Reconciliation Type

The **Reconciliation Type** zone displays the details of the reconciliation type. It contains the following sections:

- **Main** - Displays basic information about the reconciliation type. It contains the following fields:

Field Name	Field Description
Reconciliation Type	Displays the reconciliation type.
Reconciliation Business Object	Indicates the business object using which the reconciliation will be created. In addition, a context menu appears corresponding to this field which helps in navigating to other screens in the application. Note: It has a link. On clicking the link, the Business Object screen appears where you can view the details of the respective business object.
Description	Displays the description of the reconciliation type.
Detailed Description	Indicates the status of the reconciliation type. The valid values are: <ul style="list-style-type: none"> Active Inactive
Status	Displays additional information about the reconciliation type.

- **Algorithms** - Lists the algorithms which are associated with the reconciliation type. It contains the following columns:

Column Name	Column Description
Sequence	Indicates the order in which the algorithms with the same system event should be executed.
System Event	Indicates the system event when the algorithm should be executed. The valid value is: <ul style="list-style-type: none"> Upload Pay Instructions
Algorithm	Indicates the algorithm attached to the system event. Note: It has a link. On clicking the link, the Algorithm screen appears where you can view the details of the respective algorithm.

- **Characteristics** - Lists the characteristics defined for the reconciliation type. It contains the following columns:

Column Name	Column Description
Characteristic Type	Indicates the characteristic type.
Characteristic Value	Displays the value of the characteristic type.
Description	Displays the description of the characteristic value. Note: The data appears in this column when the type of characteristic value is set to Predefined Value or Foreign Key Value .

- **Record Actions** - This section contains the following buttons:

Button Name	Button Description
Edit	Used to edit the details of the reconciliation type.

Button Name	Button Description
Delete	Used to delete the reconciliation type.
	Note: You can delete a reconciliation type when you have not created a reconciliation using the reconciliation type.
Duplicate	Used to create a new reconciliation type using an existing reconciliation type.

- **Record Information** - This section contains the following field:

Field Name	Field Description
Business Object	Indicates the business object using which the reconciliation type is created. In addition, a context menu appears corresponding to this field which helps in navigating to other screens in the application.
	Note: It has a link. On clicking the link, the Business Object screen appears where you can view the details of the respective business object.

By default, the **Reconciliation Type** zone does not appear in the **Reconciliation Type** screen. It appears when you click the **Broadcast** () icon corresponding to a reconciliation type in the **Reconciliation Type List** zone.

Related Topics

For more information on...	See...
How to edit a reconciliation type	Editing a Reconciliation Type on page 2387
How to delete a reconciliation type	Deleting a Reconciliation Type on page 2388
How to copy a reconciliation type	Copying a Reconciliation Type on page 2389
How to view the details of a reconciliation type	Viewing the Reconciliation Type Details on page 2390

Defining a Reconciliation Type

Prerequisites

To define a reconciliation type, you should have:

- Reconciliation business objects defined in the application

Procedure

To define a reconciliation type:

1. Click the **Admin** link in the **Application** toolbar.
A list appears.
2. From the **Admin** menu, select **R** and then click **Reconciliation Type**.
A sub-menu appears.
3. Click the **Add** option from the **Reconciliation Type** sub-menu.

The **Select Business Object** screen appears. It contains the following field:

Field Name	Field Description	Mandatory (Yes or No)
Reconciliation Type Business Object	Used to indicate the business object using which you want to create the reconciliation type.	Yes

Tip: Alternatively, you can access this screen by clicking the **Add** button in the **Page Title** area of the **Reconciliation Type** screen.

Note: The **Select Business Object** screen appears when there are multiple reconciliation type business objects defined in the application. If there is only one reconciliation type business object defined in the application, the **Reconciliation Type** screen appears.

4. Select the required reconciliation type business object from the respective field.
5. Click **OK**.

The **Reconciliation Type** screen appears. It contains the following sections:

- **Main** - Used to specify basic details about the reconciliation type.
- **Algorithms** - Used to associate algorithms with the reconciliation type.
- **Characteristics** - Used to define the characteristics for the reconciliation type.

The **Main** section contains the following fields:

Field Name	Field Description	Mandatory (Yes or No)
Reconciliation Type	Used to specify the reconciliation type.	Yes
Business Object	Indicates the reconciliation type business object using which you are defining the reconciliation type.	Not applicable
Reconciliation Business Object	Used to indicate the business object using which you want to create the reconciliation.	Yes
Description	Used to specify the description for the reconciliation type.	Yes
Detailed Description	Used to specify additional information about the reconciliation type.	No
Status	Used to indicate the status of the reconciliation type. The valid values are: <ul style="list-style-type: none"> • Active • Inactive 	Yes

6. Enter the required details in the **Main** section.
7. Associate algorithms with the reconciliation type, if required.
8. Define characteristics for the reconciliation type, if required.
9. Click **Save**.

The reconciliation type is defined.

Related Topics

For more information on...	See...
Reconciliation Type screen	Reconciliation Type on page 2380
How to associate an algorithm with a reconciliation type	Associating an Algorithm with a Reconciliation Type on page 2385
How to define a characteristic for a reconciliation type	Defining a Characteristic for a Reconciliation Type on page 2385

Defining a Characteristic for a Reconciliation Type

Prerequisites

To define a characteristic for a reconciliation type, you should have:

- Characteristic types defined in the application (where the characteristic entity is set to **Reconciliation Type**).

Procedure

To define a characteristic for a reconciliation type:

1. Ensure that the **Characteristics** section is expanded when you are defining, editing, or copying a reconciliation type.

The **Characteristics** section contains the following fields in a grid:

Field Name	Field Description	Mandatory (Yes or No)
Characteristic Type	Used to indicate the characteristic type.	Yes (Conditional)
	Note: The list includes only those characteristic types where the characteristic entity is set to Reconciliation Type .	Note: This field is required when you are defining a characteristic for the reconciliation type.
Characteristic Value	Used to specify the value for the characteristic type.	Yes (Conditional)
	Note: On specifying the value for a predefined characteristic type, the description of the characteristic value appears corresponding to the Characteristic Value field.	Note: This field is required when you are defining a characteristic for the reconciliation type.

2. Enter the required details in the **Characteristics** section.

Note: If you select a predefined characteristic type, the **Search** (🔍) icon appears corresponding to the **Characteristic Value** field. On clicking the **Search** icon, you can search for a predefined characteristic value.

3. If you want to define more than one characteristic for the reconciliation type, click the **Add** (+) icon and then repeat step 2.

Note: However, if you want to remove a characteristic from the reconciliation type, click the **Delete** (🗑️) icon corresponding to the characteristic.

Related Topics

For more information on...	See...
How to define a reconciliation type	Defining a Reconciliation Type on page 2383
How to edit a reconciliation type	Editing a Reconciliation Type on page 2387
How to copy a reconciliation type	Copying a Reconciliation Type on page 2389

Associating an Algorithm with a Reconciliation Type

You can upload a pay instruction file in the CSV and EDI 820 file formats. While uploading a pay instruction file, you need to specify the reconciliation type using which you want to create the reconciliation. A reconciliation type indicates the algorithm which validates the pay instruction file and creates a pay instruction for each record in the file. Two

algorithm types named **C1-PAYINSUPL** and **C1-RECONPROC** are shipped with the product. You need to maintain separate reconciliation types for different file formats. If you want to use a reconciliation type while uploading a pay instruction file in the CSV format, you need to create an algorithm using the **C1-PAYINSUPL** algorithm type and attach it to the reconciliation type. However, if you want to use a reconciliation type while uploading a pay instruction file in the EDI 820 format, you need to create an algorithm using the **C1-RECONPROC** algorithm type and attach it to the reconciliation type.

Prerequisites

To associate an algorithm with a reconciliation type, you should have:

- Algorithm defined using the **C1-PAYINSUPL** or **C1-RECONPROC** algorithm type depending on whether you want to use the reconciliation type while uploading a pay instruction file in the CSV or EDI 820 file format

Procedure

To associate an algorithm with a reconciliation type:

1. Ensure that the **Algorithms** section is expanded when you are defining, editing, or copying a reconciliation type.

The **Algorithms** section contains the following fields in a grid:

Field Name	Field Description	Mandatory (Yes or No)
Sequence	Used to indicate the order in which the algorithms with the same system event should be executed.	Yes (Conditional) Note: This field is required when you are associating an algorithm with the reconciliation type.
System Event	Used to indicate the system event when the algorithm should be executed. The valid value is: <ul style="list-style-type: none"> • Upload Pay Instructions - Used when you want to execute the attached algorithm while uploading a pay instruction file using the Pay Instruction CSV File Upload (C1-RECUP) or Upload Lockbox Payment and Pay Instruction Files (C1-PUPSG) batch. 	Yes (Conditional) Note: This field is required when you are associating an algorithm with the reconciliation type.
Algorithm	Used to indicate the algorithm that you want to attach to the system event. Note: The Search (🔍) icon appears corresponding to this field. On clicking the Search icon, the Algorithm Search window appears.	Yes (Conditional) Note: This field is required when you are associating an algorithm with the reconciliation type.

2. Enter the required details in the **Algorithms** section.
3. If you want to associate more than one algorithm with the reconciliation type, click the **Add** (+) icon and then repeat step 2.

Note: However, if you want to remove an algorithm from the reconciliation type, click the **Delete** (🗑️) icon corresponding to the algorithm.

4. Click **Save**.

The algorithms are associated with the reconciliation type.

Related Topics

For more information on...	See...
How to define a reconciliation type	Defining a Reconciliation Type on page 2383
How to edit a reconciliation type	Editing a Reconciliation Type on page 2387
How to copy a reconciliation type	Copying a Reconciliation Type on page 2389

Editing a Reconciliation Type**Prerequisites**

To edit a reconciliation type, you should have:

- Reconciliation business objects defined in the application

Procedure

To edit a reconciliation type:

1. Click the **Admin** link in the **Application** toolbar.
A list appears.
2. From the **Admin** menu, select **R** and then click **Reconciliation Type**.
A sub-menu appears.
3. Click the **Search** option from the **Reconciliation Type** sub-menu.
The **Reconciliation Type** screen appears.
4. In the **Reconciliation Type List** zone, click the **Edit** (✎) icon in the **Edit** column corresponding to the reconciliation type whose details you want to edit.

The **Reconciliation Type** screen appears. It contains the following sections:

- **Main** - Used to specify basic details about the reconciliation type.
- **Algorithms** - Used to associate algorithms with the reconciliation type.
- **Characteristics** - Used to define the characteristics for the reconciliation type.

The **Main** section contains the following fields:

Field Name	Field Description	Mandatory (Yes or No)
Reconciliation Type	Displays the reconciliation type.	Not applicable
Business Object	Indicates the reconciliation type business object using which you are defining the reconciliation type.	Not applicable
Reconciliation Business Object	Used to indicate the business object using which you want to create the reconciliation.	Yes
Description	Used to specify the description for the reconciliation type.	Yes
Detailed Description	Used to specify additional information about the reconciliation type.	No

Field Name	Field Description	Mandatory (Yes or No)
Status	Used to indicate the status of the reconciliation type. The valid values are: <ul style="list-style-type: none"> Active Inactive 	Yes

Tip: Alternatively, you can edit the details of a reconciliation type by clicking the **Edit** button in the **Reconciliation Type** zone.

- Modify the required details in the **Main** section.
- Associate or remove an algorithm from the reconciliation type, if required.
- Define, edit, or remove characteristics of the reconciliation type, if required.
- Click **Save**.

The changes made to the reconciliation type are saved.

Related Topics

For more information on...	See...
Reconciliation Type screen	Reconciliation Type on page 2380
Reconciliation Type List zone	Reconciliation Type List on page 2381
Reconciliation Type zone	Reconciliation Type on page 2381
How to associate an algorithm with a reconciliation type	Associating an Algorithm with a Reconciliation Type on page 2385
How to define a characteristic for a reconciliation type	Defining a Characteristic for a Reconciliation Type on page 2385

Deleting a Reconciliation Type

Procedure

To delete a reconciliation type:

- Click the **Admin** link in the **Application** toolbar.
A list appears.
- From the **Admin** menu, select **R** and then click **Reconciliation Type**.
A sub-menu appears.
- Click the **Search** option from the **Reconciliation Type** sub-menu.
The **Reconciliation Type** screen appears.
- In the **Reconciliation Type List** zone, click the **Delete** (🗑️) icon in the **Delete** column corresponding to the reconciliation type that you want to delete.
A message appears confirming whether you want to delete the reconciliation type.

Note: You can delete a reconciliation type when you have not created a reconciliation using the reconciliation type.

Tip: Alternatively, you can delete a reconciliation type by clicking the **Delete** button in the **Reconciliation Type** zone.

5. Click **OK**.

The reconciliation type is deleted.

Related Topics

For more information on...	See...
Reconciliation Type screen	Reconciliation Type on page 2380
Reconciliation Type List zone	Reconciliation Type List on page 2381
Reconciliation Type zone	Reconciliation Type on page 2381

Copying a Reconciliation Type

Instead of creating a reconciliation type from scratch, you can create a new reconciliation type using an existing reconciliation type. This is possible through copying a reconciliation type. On copying a reconciliation type, the details including the algorithms and characteristics are copied to the new reconciliation type. You can then edit the details, if required.

Prerequisites

To copy a reconciliation type, you should have:

- Reconciliation type (whose copy you want to create) defined in the application
- Reconciliation business objects defined in the application

Procedure

To copy a reconciliation type:

1. Click the **Admin** link in the **Application** toolbar.

A list appears.

2. From the **Admin** menu, select **R** and then click **Reconciliation Type**.

A sub-menu appears.

3. Click the **Search** option from the **Reconciliation Type** sub-menu.

The **Reconciliation Type** screen appears.

4. In the **Reconciliation Type List** zone, click the **Duplicate**  icon in the **Duplicate** column corresponding to the reconciliation type whose copy you want to create.

The **Reconciliation Type** screen appears. It contains the following sections:

- **Main** - Used to specify basic details about the reconciliation type.
- **Algorithms** - Used to associate algorithms with the reconciliation type.
- **Characteristics** - Used to define the characteristics for the reconciliation type.

The **Main** section contains the following fields:

Field Name	Field Description	Mandatory (Yes or No)
Reconciliation Type	Used to specify the reconciliation type.	Yes
Business Object	Indicates the reconciliation type business object using which you are defining the reconciliation type.	Not applicable

Field Name	Field Description	Mandatory (Yes or No)
Reconciliation Business Object	Used to indicate the business object using which you want to create the reconciliation.	Yes
Description	Used to specify the description for the reconciliation type.	Yes
Detailed Description	Used to specify additional information about the reconciliation type.	No
Status	Used to indicate the status of the reconciliation type. The valid values are: <ul style="list-style-type: none"> Active Inactive 	Yes

Tip: Alternatively, you can copy a reconciliation type by clicking the **Duplicate** button in the **Reconciliation Type** zone.

- Enter the required details in the **Main** section.
- Associate or remove an algorithm from the reconciliation type, if required.
- Define, edit, or remove characteristics of the reconciliation type, if required.
- Click **Save**.

The new reconciliation type is defined.

Related Topics

For more information on...	See...
Reconciliation Type screen	Reconciliation Type on page 2380
Reconciliation Type List zone	Reconciliation Type List on page 2381
Reconciliation Type zone	Reconciliation Type on page 2381
How to associate an algorithm with a reconciliation type	Associating an Algorithm with a Reconciliation Type on page 2385
How to define a characteristic for a reconciliation type	Defining a Characteristic for a Reconciliation Type on page 2385

Viewing the Reconciliation Type Details

Procedure

To view the details of a reconciliation type:

- Click the **Admin** link in the **Application** toolbar.
A list appears.
- From the **Admin** menu, select **R** and then click **Reconciliation Type**.
A sub-menu appears.
- Click the **Search** option from the **Reconciliation Type** sub-menu.
The **Reconciliation Type** screen appears.

4. In the **Reconciliation Type List** zone, click the **Broadcast** () icon corresponding to the reconciliation type whose details you want to view.
The **Reconciliation Type** zone appears.
5. View the details of the reconciliation type in the **Reconciliation Type** zone.

Related Topics

For more information on...	See...
Reconciliation Type screen	Reconciliation Type on page 2380
Reconciliation Type List zone	Reconciliation Type List on page 2381
Reconciliation Type zone	Reconciliation Type on page 2381

Reconciliation (Used for Searching)

The **Reconciliation** screen allows you to search for a reconciliation using various search criteria. It contains the following zone:

- [Search Reconciliation](#) on page 2391

Through this screen, you can navigate to the following screen:

- [Reconciliation \(Used for Viewing\)](#) on page 2395

Search Reconciliation

The **Search Reconciliation** zone allows you to search for a reconciliation using various search criteria. This zone contains the following sections:

- **Search Criteria** - The **Search Criteria** section contains the following fields:

Field Name	Field Description	Mandatory (Yes or No)
Search By	Used to indicate whether you want to search for a reconciliation using the reconciliation, payee account, or payment tender details. The valid values are: <ul style="list-style-type: none"> • Reconciliation Details • Account Details • Payment Tender Details 	Yes
	Note: By default, the Reconciliation Details option is selected.	
Reconciliation ID	Used to search a particular reconciliation.	No
	Note: This field appears when you select the Reconciliation Details option from the Search By list.	
Reconciliation Type	Used to search reconciliations which are created using a particular reconciliation type.	No
	Note: This field appears when you select the Reconciliation Details option from the Search By list.	

Field Name	Field Description	Mandatory (Yes or No)
Created From	Used to search reconciliations which are created from a particular date onwards.	No
	Note: This field appears when you select the Reconciliation Details option from the Search By list.	
Status	Used to search reconciliations with a particular status. The valid values are: <ul style="list-style-type: none"> • Canceled • Completed • Draft • Initial Reconciliation in Progress • Open • Pending Cancellation • Pending • Pending Reconciliation • Reconciliation in Progress 	No
	Note: This field appears when you select the Reconciliation Details option from the Search By list.	
Created Until	Used to search reconciliations which are created till a particular date.	No
	Note: This field appears when you select the Reconciliation Details option from the Search By list.	
File Name	Used to search a reconciliation which is created for a particular pay instruction file.	No
	Note: This field appears when you select the Reconciliation Details option from the Search By list.	
Person Name	Used to search reconciliations which contain a particular member's pay instructions.	No
	Note: This field appears when you select the Account Details option from the Search By list.	
Account Identifier Type	Used to select the identifier type based on which you want to search reconciliations which contain pay instructions for a particular payee account.	Yes (Conditional)
	Note: This field appears when you select the Account Details option from the Search By list.	
		Note: If you specify the account identifier as a search criteria, you have to select the account identifier type.

Field Name	Field Description	Mandatory (Yes or No)
Account ID	Used to search reconciliations which contain pay instructions for a particular payee account.	No
	Note: This field appears when you select the Account Details option from the Search By list.	
Account Identifier	Used to specify the value for the account identifier type.	Yes (Conditional)
	Note: This field appears when you select the Account Details option from the Search By list.	
Check Number	Used to search a reconciliation associated with a payment tender which is received through a particular check.	No
	Note: This field appears when you select the Payment Tender Details option from the Search By list.	
Payor Account ID	Used to search reconciliations which are associated with a particular payor account.	No
	Note: This field appears when you select the Payment Tender Details option from the Search By list.	
MICR ID	Used to search a reconciliation associated with a payment tender which contains a particular MICR code.	No
	Note: This field appears when you select the Payment Tender Details option from the Search By list.	
Tender Amount	Used to search reconciliations associated with payment tenders with a particular amount.	No
	Note: This field appears when you select the Payment Tender Details option from the Search By list.	

Note: You must specify at least one search criterion while searching for a reconciliation.

- **Search Results** - On clicking the **Search** button, the search results appear based on the specified search criteria. The **Search Results** section contains the following columns:

Column Name	Column Description
Creation Date Time	Displays the date and time when the reconciliation is created in the system.
Reconciliation Information	Displays information about the reconciliation.
	Note: It has a link. On clicking the link, the Reconciliation screen appears where you can view the details of the respective reconciliation.

Column Name	Column Description
Status	Indicates the status of the reconciliation. The valid values are: <ul style="list-style-type: none"> • Canceled • Completed • Draft • Initial Reconciliation in Progress • Open • Pending Cancelation • Pending • Pending Reconciliation • Reconciliation in Progress
Payor Account ID	Indicates the payor account to which the reconciliation is associated. Note: It has a link. On clicking the link, the Account screen appears where you can view the details of the respective payor account.
Payment ID	Indicates the payment to which the reconciliation is associated. Note: It has a link. On clicking the link, the Payment screen appears where you can view the details of the respective payment.
File Name	Indicates the pay instruction file for which the reconciliation is created in the system.
Duplicate	Used to create a new reconciliation using an existing reconciliation. Note: The Duplicate button appears when the reconciliation is in the Canceled status.

Related Topics

For more information on...	See...
How to search for a reconciliation	Searching for a Reconciliation on page 2394
How to view the details of a reconciliation	Viewing the Reconciliation Details on page 2395

Searching for a Reconciliation

Prerequisite

To search for a reconciliation, you should have:

- Reconciliation types and account identifier types defined in the application.

Procedure

To search for a reconciliation:

1. Click the **Menu** link in the **Application** toolbar.
A list appears.
2. From the **Main** menu, select **Accounting and Receivable** and then click **Reconciliation**.
The **Reconciliation** screen appears.

- Enter the search criteria in the **Search Reconciliation** zone.

Note: ORMB search engine supports wildcard search, where you can substitute the percentage (%) symbol as a stand in for any word or letter in a search criteria. You can use the ‘%’ wildcard character in all input fields except the date and ID fields. The ‘%’ wildcard character is suffixed automatically at the end of the partial search criteria. Therefore, you may or may not specify the wildcard character at the end of the partial search criteria. However, you have to prefix the wildcard character manually wherever required.

- Click **Search**.

A list of reconciliations that meet the search criteria appears in the **Search Results** section.

Related Topics

For more information on...	See...
Reconciliation screen	Reconciliation (Used for Searching) on page 2391
Search Reconciliation zone	Search Reconciliation on page 2391

Viewing the Reconciliation Details

Procedure

To view the details of a reconciliation:

- Search for the reconciliation in the **Reconciliation** screen.
- In the **Search Results** section, click the link in the **Reconciliation Information** column corresponding to the reconciliation whose details you want to view.

The **Reconciliation** screen appears.

- Ensure that the **Main** tab is selected.
- View the details of the reconciliation in the **Reconciliation** zone.
- View the list of pay instructions uploaded through the file in the **Pay Instructions** zone.

Related Topics

For more information on...	See...
How to search for a reconciliation	Searching for a Reconciliation on page 2394
Reconciliation screen	Reconciliation (Used for Viewing) on page 2395
Reconciliation zone	Reconciliation on page 2396
Pay Instructions zone	Pay Instructions

Reconciliation (Used for Viewing)

The **Reconciliation** screen allows you to:

- View the details and characteristics of the reconciliation
- Edit and delete the details of the reconciliation
- Submit the file for reconciliation
- View the pay instruction statistics for reconciliation
- Cancel the pending reconciliation

This screen contains the following tabs:

- [Reconciliation - Main](#) on page 2396
- [Reconciliation - Pay Instruction](#) on page 2398
- [Reconciliation - Log](#) on page 2400

For more information on...	See...
How to view the details of reconciliation	Viewing the Reconciliation Details on page 2395
How to edit the details of reconciliation	Editing a Reconciliation Type on page 2387
Reconciliation - Main screen	Reconciliation (Used for Viewing) on page 2395
Reconciliation - Main zone	Reconciliation on page 2396

Reconciliation - Main

The **Main** tab displays information about the reconciliation. It contains the following zones:

- [Reconciliation](#) on page 2396

Reconciliation

The **Reconciliation** zone displays the details of the reconciliation. It contains the following sections:

- **Main** - Displays basic information about the reconciliation. It contains the following fields:

Field Name	Field Description
Reconciliation Information	Displays information about the reconciliation.
Reconciliation Type	Indicates the reconciliation type using which the reconciliation is created. Note: It has a link. On clicking the link, the Reconciliation Type screen appears where you can view the details of the reconciliation type.
Status	Indicates the status of the reconciliation. The valid values are: <ul style="list-style-type: none"> • Canceled • Completed • Draft • Initial Reconciliation in Progress • Open • Pending Cancellation • Pending • Pending Reconciliation • Reconciliation in Progress
Status Reason	Indicates the reason why the status of the reconciliation is changed. Note: This field appears when the reconciliation is in the Pending Cancellation or Canceled status.
File Name	Indicates the pay instruction file for which the reconciliation is created in the system.

Field Name	Field Description
Payment Information	Indicates the payment to which the reconciliation is associated. In addition, a context menu appears corresponding to this field which helps in navigating to other screens in the application.
	<p>Note:</p> <p>It has a link. On clicking the link, the Payment screen appears where you can view the details of the respective payment.</p> <p>This field does not appear when the reconciliation is in the Draft or Pending status.</p>
Account Information	Indicates the payor account to which the reconciliation is associated.
	<p>Note: This field does not appear when the reconciliation is in the Draft or Pending status.</p>

- **Characteristics** - Lists the characteristics defined for the reconciliation. It contains the following columns:

Column Name	Column Description
Effective Date	Displays the date from when the characteristic is effective for the reconciliation.
Characteristic Type	Indicates the characteristic type.
Characteristic Value	Displays the value of the characteristic type.
Description	Displays the description of the characteristic value.
	<p>Note: The data appears in this column when the type of characteristic value is set to Predefined Value or Foreign Key Value.</p>

- **Pay Instruction Statistics** - Lists the statistics of records in the reconciliation. It contains the following fields:

Field Name	Field Description
Total Records	Displays total number of records in the reconciliation file.
Total Records Processed	Displays the count of data records derived after processing.
Total Records Cancelled	Displays the count of data records derived after unsuccessful processing.
Total Records in Error	Displays the count of data records in error status.
Total Records Pending	Displays the count of data records pending after successful derivation.
Total Records in Open	Displays the count of data records in open status.

- **Record Actions** - This section contains the following buttons:

Button Name	Button Description
Edit	Used to edit the details of the reconciliation.
	<p>Note: The Edit button appears when the reconciliation is in the Pending or Draft status.</p>

Button Name	Button Description
Delete	Used to delete the reconciliation.
	Note: The Delete button appears when the reconciliation is in the Pending or Draft status.
Submit for Reconciliation	Used to submit the pay instructions for reconciliation.
	Note: The Submit for Reconciliation button appears when the reconciliation is in the Pending status.
Cancel	Used to cancel the reconciliation.
	Note: The Cancel button appears when the reconciliation is in the Completed or Open status.
Reconcile	Used to reconcile the pay instructions in the reconciliation.
	Note: The Reconcile button appears when the reconciliation is in the Pending Reconciliation status.
Revert to Pending	Used to revert the status of the reconciliation to Pending .
	Note: The Revert to Pending button appears when the reconciliation is in the Pending Reconciliation status.

- **Record Information** - This section contains the following fields:

Field Name	Field Description
Business Object	Indicates the business object using which the reconciliation is created. In addition, a context menu appears corresponding to this field which helps in navigating to other screens in the application.
	Note: It has a link. On clicking the link, the Business Object screen appears where you can view the details of the respective business object.
Status Date Time	Displays the date and time when the reconciliation status is updated.
Creation Date Time	Displays the date and time when the reconciliation is created.

Reconciliation - Pay Instruction

The **Pay Instruction** tab allows you to search for a pay instruction using various search criteria. It contains the following zone:

- [Pay Instructions](#) on page 2398

Pay Instructions

The **Pay Instructions** zone allows you to search for a pay instruction using various search criteria. This zone contains the following sections:

- **Search Criteria** - The **Search Criteria** section contains the following fields:

Field Name	Field Description	Mandatory (Yes or No)
Account ID	Used to search pay instructions for a particular payee account.	No
	Note: The Search (🔍) icon appears corresponding to the Account ID field. On clicking the Search icon, the Account Search screen appears.	
Policy Number	Used to search pay instructions with a particular policy number.	No
Member Identifier Type	Used to search pay instructions with a particular member identifier type.	No
Member Identifier	Used to search pay instructions with a particular member identifier.	No
Coverage Start Date	Used to search pay instructions which are created from a particular date.	No
Coverage End Date	Used to search pay instructions which are created till a particular date.	No
Amount From	Used to search pay instructions with a particular minimum amount.	No
Amount To	Used to search pay instructions with a particular minimum amount.	No
Status	Used to search pay instructions with a particular status. The valid values are: <ul style="list-style-type: none"> • Canceled • Complete • Derivation Pending Processing • Error • Open • Pending • Reconciliation Pending Processing 	No

- **Search Results** - On clicking the **Search** button, the search results appear based on the specified search criteria. The **Search Results** section contains the following columns:

Column Name	Column Description
Account Identifier Type	Displays the account identifier type of the member.
Account Identifier	Displays the value for the account identifier type.
Account ID	Displays the account ID of the member.
	Note: It has a link. On clicking the link, the Account screen appears with the details of the respective account.
Policy Number	Displays the policy number of the member.

Column Name	Column Description
Plan Number	Displays the plan number of the member.
Member Identifier Type	Displays the member identifier type of the member.
Member Identifier	Displays the member identifier of the member.
Member Name	Displays the member name of the member.
Coverage Start Date	Displays the date of the policy from where the coverage starts.
Coverage End Date	Displays the coverage end date of the policy till where the coverage ends.
Amount	Displays the amount that has to be paid to the member.
Open Amount	Displays the amount which has not been paid to the member and is still in the open state.
Status	Displays the status of the pay instruction. The valid values are: <ul style="list-style-type: none"> • Canceled • Complete • Derivation Pending Processing • Error • Open • Pending • Reconciliation Pending Processing
Pay Instruction ID	Displays the pay instruction ID.

Note: Pagination is used to display limited number of records in this zone. You can use the navigation buttons, such as **Previous** and **Next** to navigate between pages.

On clicking the **View** (🔍) icon corresponding to an **Account Identifier Type** column, the **Pay Instruction** screen appears with the details of the respective pay instruction record.

You can filter the list using various search criteria (such as, **Account ID**, **Policy Number**, **Member Identifier Type**, **Member Identifier**, **Coverage Start Date**, **Coverage End Date**, **Amount From**, **Amount To**, and **Status**) available in the **Filter** area. By default, the **Filter** area is hidden. You can view the **Filter** area by clicking the **Filters** (🔍) icon in the upper right corner of this zone.

Related Topics

For more information on...	See...
How to search for a pay instruction	Searching for a Pay Instruction on page 2406
How to view the details of a pay instruction	Viewing the Pay Instruction Details on page 2407

Reconciliation - Log

The **Log** tab contains the following zone:

- [Reconciliation Log](#) on page 2401

Reconciliation Log

The **Reconciliation Log** zone lists the complete trail of actions performed on the reconciliation. It contains the following columns:

Column Name	Column Description
Creation Date Time	Displays the date and time when the action was performed on the reconciliation.
Details	Displays the details about the action performed on the reconciliation.
User	Indicates the user who has performed the action on the reconciliation.
Log Type	Indicates the type of log.
Related Object	Indicates the object or entity that is created when the action is performed on the reconciliation.
Status Reason	Indicates the reason why the status of the reconciliation is changed.
	Note: The data appears in this column when the status of the reconciliation is changed to Pending Cancellation or Canceled .

Note: You can manually add a log entry for the reconciliation by clicking the **Add Log Entry** link in the upper right corner of the **Reconciliation Log** zone.

Related Topics

For more information on...	See...
How to view the log of a reconciliation	Viewing the Log of a Reconciliation on page 2405
How to add a log entry for a reconciliation	Adding a Log Entry for a Reconciliation on page 2404

Editing a Reconciliation

Procedure

To edit a reconciliation:

1. Search for the reconciliation in **Reconciliation** screen.
A list appears.
2. In the **Search Results** section, click the link in the **Reconciliation Information** column corresponding to the reconciliation whose details you want to edit.
The **Reconciliation** screen appears.
3. Click the **Edit** button in the **Reconciliation** zone.
The **Member Reconciliation** screen appears.

Note: The **Edit** button appears only when the reconciliation is in the **Pending** status.

4. Define, edit, or remove characteristics of the reconciliation, if required.
5. Click **Save**.
The changes made to the reconciliation are saved.

Related Topics

For more information on...	See...
How to search for a reconciliation	Searching for a Reconciliation on page 2394

Defining a Characteristic for a Reconciliation

Prerequisites

To define a characteristic for a reconciliation, you should have:

- Characteristic Type defined in the application (where the characteristic entity is set to **Reconciliation**)

Procedure

To define a characteristic for a reconciliation:

1. Ensure that the **Characteristics** section is expanded when you are editing a reconciliation.

The **Characteristics** section contains the following fields:

2. Enter the required details in the **Characteristics** section.

Note: If you select a predefined characteristic type, the **Search** (🔍) icon appears corresponding to the **Characteristic Value** field. On clicking the **Search** icon, you can search for a predefined characteristic value.

The **Reconciliation** screen appears.

3. If you want to define more than one characteristic for the reconciliation, click the **Add** (+) icon and then repeat step 2.

Note: However, if you want to remove a characteristic from the reconciliation, click the **Delete** (🗑️) icon corresponding to the characteristic.

4. Click **Search**.

A list of reconciliation files that meet the search criteria appear in the **Search Results** section.

5. In the **Search Results** section, click the link in the **Reconciliation Information** column corresponding to the status column.

The **Reconciliation** screen appears.

6. Click **Edit** button from **Record Actions** section.

The **Member Reconciliation** screen appears. It contains the following sections:

- **Main** - Used to specify the basic details of the reconciliation.
- **Characteristics** - Used to specify the characteristics for the reconciliation. It contains the following fields:

Field Name	Field Description	Mandatory (Yes or No)
Effective Date	Used to specify the date from when the characteristic is effective for the reconciliation.	Yes
Characteristic Type	Used to indicate the characteristic type.	Yes
	Note: The list includes only those characteristic types where the characteristic entity is set to Reconciliation .	

Field Name	Field Description	Mandatory (Yes or No)
Characteristic Value	Used to specify the value for the characteristic type.	Yes
	Note: On specifying the value for a predefined characteristic type, the description of the characteristic value appears corresponding to the Characteristic Value field.	

Related Topics

For more information on...	See...
How to edit an reconciliation	Editing a Reconciliation on page 2401

Deleting a Reconciliation

Procedure

To delete a reconciliation:

1. Search for the reconciliation in the **Reconciliation** screen.
2. In the **Search Results** section, click the link in the **Reconciliation Information** column corresponding to the reconciliation that you want to delete.

The **Reconciliation** screen appears.

3. Click the **Delete** button in the **Reconciliation** zone.

A message appears confirming whether you want to delete the reconciliation.

Note: The **Delete** button appears when the reconciliation is in the **Pending** or **Draft** status.

4. Click **OK**.

The reconciliation object is deleted.

Related Topics

For more information on...	See...
Search Reconciliation screen	Reconciliation (Used for Searching) on page 2391
Search Reconciliation zone	Search Reconciliation on page 2391
How to search for a reconciliation	Searching for a Reconciliation on page 2394

Submitting Pay Instructions for a Reconciliation

Prerequisites

To submit pay instructions for reconciliation, you should have:

- Account ID defined in the application.
- Reconciliation BO status as Pending.

Procedure

To submit pay instructions for a reconciliation:

1. Search for the reconciliation in the **Reconciliation** screen.

2. In the **Search Results** section, click the link in the **Reconciliation Information** column corresponding to the reconciliation that you want to submit.

The **Reconciliation** screen appears.

3. Click the **Submit for Reconciliation** button in the **Reconciliation** zone.

The pay instruction is submitted for reconciliation and the reconciliation status gets changed to **Pending Reconciliation**.

Note:

The **Submit for Reconciliation** button appears when the reconciliation is in the **Pending** status.

Related Topics

For more information on...	See...
How to search a reconciliation	Searching for a Reconciliation on page 2394

Reconciling Pay Instructions

Prerequisites

To reconcile pay instructions, you should have:

- Account ID defined in the application.
- Reconciliation BO Status must be in Pending Reconciliation.

Procedure

To reconcile pay instructions:

1. Search for the reconciliation in the **Reconciliation** screen.
2. In the **Search Results** section, click the link in the **Reconciliation Information** column corresponding to the reconciliation that you want to reconcile.

The **Reconciliation** screen appears.

3. Click the **Reconcile** button in the **Reconciliation** zone.

The pay instructions gets reconciled and the reconciliation BO status gets changed to **Completed**.

Note:

The **Reconcile** button appears when the reconciliation is in the **Pending Reconciliation** status.

Related Topics

For more information on...	See...
How to search for a reconciliation	Searching for a Reconciliation on page 2394

Adding a Log Entry for a Reconciliation

Procedure

To add a log entry for a reconciliation:

1. Search for the reconciliation in the **Reconciliation** screen.
2. In the **Search Results** section, click the link in the **Reconciliation Information** column corresponding to the reconciliation whose log you want to edit.

The **Reconciliation** screen appears.

- Click the **Log** tab.

The **Log** tab appears.

- Click the **Add Log Entry** link in the upper right corner of the **Reconciliation Log** zone.

The **Add Reconciliation Log** window appears. It contains the following fields:

Field Name	Field Description	Mandatory (Yes or No)
Reconciliation Information	Displays information about the reconciliation.	Not applicable
Log Details	Used to specify additional comments for the reconciliation.	Yes

- Enter the comments in the **Log Details** field.
- Click **Save**.

The log entry is added in the **Reconciliation Log** zone.

Related Topics

For more information on...	See...
How to search for a reconciliation	Searching for a Reconciliation on page 2394
Reconciliation screen	Reconciliation (Used for Viewing) on page 2395
Reconciliation Log zone	Reconciliation Log on page 2401

Viewing the Log of a Reconciliation

Procedure

To view the log of a reconciliation:

- Search for the reconciliation in the **Reconciliation** screen.
- In the **Search Results** section, click the link in the **Reconciliation Information** column corresponding to the reconciliation whose log you want to view.

The **Reconciliation** screen appears.

- Click the **Log** tab.

The **Log** tab appears.

- View the complete trail of actions performed on the reconciliation in the **Reconciliation Log** zone.

Related Topics

For more information on...	See...
How to search for a reconciliation	Searching for a Reconciliation on page 2394
How to add a log entry for a reconciliation	Adding a Log Entry for a Reconciliation on page 2404
Reconciliation screen	Reconciliation (Used for Viewing) on page 2395
Reconciliation Log zone	Reconciliation Log on page 2401

Canceling a Reconciliation

Prerequisites

To cancel a reconciliation, you should have:

- Cancellation reasons defined in the application.

Note: While cancelling a reconciliation, you need to specify the reason why you want to cancel the reconciliation. You can select the appropriate cancellation reason when you have defined the reasons for the **Canceled** status of the **C1-MemberReconciliation** business object in the **Status Reason** screen.

Procedure

To cancel a reconciliation:

1. Search for the reconciliation in the **Reconciliation** screen.
2. In the **Search Results** section, click the link in the **Reconciliation Information** column corresponding to the reconciliation that you want to cancel.

The **Reconciliation** screen appears.

- [Reconciliation - Main](#) on page 2396
- [Pay Instructions](#) on page 2398
- [Reconciliation - Log](#) on page 2400

3. Click the **Cancel** button in the **Reconciliation** zone.

The **Status Reason** window appears. It contains following field:

:

Field Name	Field Description	Mandatory (Yes or No)
Status Reason	Used to indicate the reason why you want to cancel the reconciliation.	Yes

Note: The **Cancel** button appears when the reconciliation is in the **Open** or **Completed** status.

4. Select the cancellation status reason from the **Status Reason** list.
5. Click **Save**.

The status of the reconciliation is changed to **Cancelled**.

Related Topics

For more information on...	See...
How to search for a reconciliation	Searching for a Reconciliation on page 2394
Reconciliation screen	Reconciliation (Used for Viewing) on page 2395
Reconciliation zone	Reconciliation on page 2396
How to view details of reconciliation	Viewing the Reconciliation Details on page 2395

Searching for a Pay Instruction

Prerequisite

To search for a pay instruction, you should have:

- Pay instruction statuses and member identifier types defined in the application.

Procedure

To search for a pay instruction:

1. Search for the reconciliation in the **Reconciliation** screen.
2. In the **Search Results** section, click the link in the **Reconciliation Information** column corresponding to the reconciliation whose details you want to view.

The **Reconciliation** screen appears.

3. Ensure that the **Pay Instruction** tab is selected.

The **Pay Instruction** screen appears.

4. Enter the search criteria in the **Pay Instruction** zone.

Note: ORMB search engine supports wildcard search, where you can substitute the percentage (%) symbol as a stand in for any word or letter in a search criteria. You can use the ‘%’ wildcard character in all input fields except the date and ID fields. The ‘%’ wildcard character is suffixed automatically at the end of the partial search criteria. Therefore, you may or may not specify the wildcard character at the end of the partial search criteria. However, you have to prefix the wildcard character manually wherever required.

5. Click **Search**.

A list of pay instruction that meet the search criteria appears in the **Search Results** section.

Related Topics

For more information on...	See...
Reconciliation screen	Reconciliation (Used for Searching) on page 2391
Search Reconciliation zone	Search Reconciliation on page 2391
Pay Instruction zone	Pay Instructions on page 2398

Viewing the Pay Instruction Details

Procedure

To view the details of a pay instruction:

1. Search for a reconciliation in the **Reconciliation** screen.
2. In the **Search Results** section, click the link in the **Reconciliation Information** column corresponding to the reconciliation whose pay instruction details you want to view.

The **Reconciliation** screen appears.

3. The **Reconciliation** screen consists of the following tabs:

- [Reconciliation - Main](#) on page 2396
- [Pay Instructions](#) on page 2398
- [Reconciliation - Log](#) on page 2400

4. Click the **Pay Instruction** tab.

The **Pay Instruction** tab appears.

5. Enter the search criteria in the **Pay Instructions** zone.
6. Click **Search**.

A list of pay instruction that meet the search criteria appears in the **Search Results** section.

7. In the **Search Results** section, click the **View** () icon corresponding to the **Account Identifier Type** column. The **Pay Instruction** screen appears.
8. Ensure that the **Main** tab is selected.
9. View the details of the pay instruction in the **Pay Instruction** zone.

Related Topics

For more information on...	See...
Searching for a Reconciliation	Searching for a Reconciliation on page 2394
Reconciliation screen	Reconciliation (Used for Viewing) on page 2395
Reconciliation - Main zone	Reconciliation - Main on page 2396
Pay Instructions screen	Pay Instruction on page 2408
Pay Instruction zone	Pay Instruction on page 2408

Pay Instruction

The **Pay Instruction** screen displays detailed information of a pay instruction which is the part of reconciliation:

- View the details and characteristics of the pay instruction
- View the details of the reconciliation adjustments
- View the related objects

This screen contains of the following tabs:

- [Pay Instruction - Main](#) on page 2408
- [Pay Instruction - Log](#) on page 2411

Pay Instruction - Main

The **Pay Instruction - Main** tab displays information about the pay instruction. It contains the following zones:

- [Pay Instruction](#) on page 2408
- [Reconciliation Adjustments](#) on page 2410
- [Related Objects](#) on page 2410

Pay Instruction

The **Pay Instruction** zone lists payment related information that is specific to each member. It contains the following sections:

- **Main** - This section provides information about the pay instruction. It contains the following fields:

Field Name	Field Description
Pay Instruction Information	Displays the details of pay instruction in brief.
Reconciliation Information	Displays the details of the reconciliation.
Status	Displays the status of the pay instruction.
Coverage Start Date	Displays the date of the policy from where the coverage starts.

Field Name	Field Description
Coverage End Date	Displays the coverage end date of the policy till where the coverage ends.
Account Identifier Type	Displays the account identifier type of the member.
Account Identifier	Displays the value for the account identifier type.
Account ID	Displays the account ID of the member.
Policy Number	Displays the policy number of the member.
Plan Number	Displays the plan number of the member.
Member Identifier Type	Displays the member identifier type of the member.
Member Identifier	Displays the member identifier of the member.
Member Name	Displays the member name of the member.
Payment Instruction Amount	Displays the amount that has to be paid to the member.
Open Amount	Displays the amount which has not been paid to the member and is still in the open state.

- **Pay Instruction Amount** -This section provides information on the pay instruction amount. It contains the following fields:

Field Name	Field Description
Payment Instruction Amount	Displays the amount that has to be paid to the member.
Open Amount	Displays the amount which has not been paid to the member and is still in the open state.

- **Record Information** - This section provides information on the pay instruction business object. It contains the following fields:

Field Name	Field Description
Business Object	Indicates the business object using which the pay instructions are executed. In addition, a context menu appears corresponding to this field which helps in navigating to other screens in the application. Note: It has a link. On clicking the link, the Business Object screen appears where you can view the details of the respective business object.
Status Date Time	Displays the date and time when the pay instruction object status is updated.
Creation Date Time	Displays the date and time when the pay instruction object is created.

- **Characteristics** - This section provides characteristic information for the pay instruction.

Field Name	Field Description
Characteristic Type	Displays the characteristic type.
Characteristic Value	Displays the value of characteristic type.
Description	Displays the description of the characteristic type.

Related Topics

For more information on...	See...
How to view the details of reconciliation	Viewing the Pay Instruction Details on page 2407
Pay Instruction screen	Pay Instruction on page 2408
Pay Instruction zone	Pay Instruction on page 2408

Reconciliation Adjustments

The **Reconciliation Adjustments** zone displays the adjustment information for each pay instruction. It contains the following fields:

Column Name	Column Description
Transfer Adjustment	Indicates the amount to be transferred from a reconciliation contract against a pay instruction. Note: It has a link. On clicking the link, the Adjustment screen appears where you can view the details of the transferred adjustment.
Transfer Type	Displays the type of transfer transaction made against a pay instruction or an internal offsetting.
Transfer Financial Transaction ID	Displays the transfer financial transaction ID.
Offset Adjustment	Indicates a reciprocal adjustment that is associated with a transfer adjustment. Note: It has a link. On clicking the link, the Adjustment screen appears where you can view the offset adjustment details.
Related Object Type	Displays the related object type whether it is pay instruction / financial transaction.
Related Object ID	Indicates the ID of the related pay instruction / financial transaction created in reconciliation process.. Note: It has a link. On clicking the link, the Financial Transaction screen appears where you can view the details of the financial transaction of reconciliation adjustments.

Note: Pagination is used to display limited number of records in the **Reconciliation Adjustments** zone. By default, 10 records are displayed in this zone. You can use the navigation links, such as Previous and Next to navigate between pages.

You can filter the adjustments using **Show All Adjustments** available in the **Filter** area. By default, the **Filter** area is hidden. You can view the **Filter** area by clicking the **Filters** () icon in the upper right corner of the **Reconciliation Adjustments** zone.

Related Objects

The **Related Objects** zone displays all those business objects based on which reconciliation process takes place. It contains the following fields:

Column Name	Column Description
Related Object Type	Displays the related object type that was used in pay instruction process.

Column Name	Column Description
Related Object Information	Displays the details of related object in brief.

Note: Pagination is used to display limited number of records in the **Related Topics** zone. By default, 10 records are displayed in this zone. You can use the navigation links, such as Previous and Next to navigate between pages.

Pay Instruction - Log

The **Pay Instruction - Log** tab contains the following zone:

- [Pay Instruction Log](#) on page 2411

Pay Instruction Log

The **Pay Instruction Log** zone lists the complete trail of actions performed on the pay instructions. It contains the following columns:

Column Name	Column Description
Creation Date Time	Displays the date and time when the action was performed on the pay instruction.
Details	Displays the details about the action performed on the pay instruction.
User	Indicates the user who has performed the action on the pay instruction.
Log Type	Indicates the type of log.
Related Object	Indicates the object or entity which is generated when the action is performed on the pay instruction.
Status Reason	Displays the status reason of action performed on the pay instruction.

Note: You can manually add a log entry for the pay instruction by clicking the **Add Log Entry** link in the upper right corner of the **Pay Instruction Log** zone.

Related Topics

For more information on...	See...
How to view the log of a pay instruction	Viewing the Log of a Pay Instruction on page 2412
How to add a log entry for a pay instruction	Adding a Log Entry for a Pay Instruction on page 2411

Adding a Log Entry for a Pay Instruction

Procedure

To add a log entry for a pay instruction:

1. Search for the reconciliation in the **Reconciliation** screen.
2. In the **Search Results** section, click the link in the **Reconciliation Information** column corresponding to the reconciliation whose pay instruction log you want to edit.

The **Reconciliation** screen is displayed.

3. In the **Pay Instructions** zone of the **Main**, click the Go To icon (🔗) corresponding to the pay instruction whose log you want to edit.

The **Pay Instruction** screen appears. It consists of the following tabs:

- [Pay Instruction - Main](#) on page 2408

- [Pay Instruction - Log](#) on page 2411
- Click the **Log** tab.
The **Pay Instruction** screen appears.
 - Click the **Add Log Entry** link in the upper right corner of the **Pay Instruction Log** zone.
The **Add Pay Instruction Log** screen appears. It contains the following fields:

Field Name	Field Description	Mandatory (Yes or No)
Pay Instruction Information	Displays information about the pay instruction.	Not applicable
Log Details	Used to specify additional comments for the pay instruction.	Yes

- Enter the comments in the **Log Details** field.
- Click **Save**.
The log entry is added in the **Pay Instruction Log** zone.

Related Topics

For more information on...	See...
How to search for a reconciliation	Searching for a Reconciliation on page 2394

Viewing the Log of a Pay Instruction

Procedure

To view the log of a Pay Instruction:

- Search for the reconciliation information in the **Reconciliation** screen.
- In the **Search Results** section, click the link in the **Reconciliation Information** column corresponding to the reconciliation, whose pay instruction log you want to view.
The **Reconciliation** screen appears.
- In the **Pay Instructions** zone of the **Main**, click the **Go To Payment Instruction** () icon, corresponding to the pay instruction whose log you want to view.
The **Pay Instruction** screen appears. It consists of the following tabs:
 - [Pay Instruction - Main](#) on page 2408
 - [Pay Instruction - Log](#) on page 2411
- Click the **Log** tab.
The **Log** tab appears.
- View the complete trail of actions performed on the pay instruction in the **Pay Instruction Log** zone.

Related Topics

For more information on...	See...
How to add a log entry for a pay instruction	Adding a Log Entry for a Pay Instruction on page 2411
Pay Instruction screen	Pay Instruction on page 2408

For more information on...	See...
Pay Instruction Log zone	Pay Instruction Log on page 2411

Discrepancy Report Type

Oracle Revenue Management and Billing allows you to define a discrepancy report type using which you can create a discrepancy report. The Discrepancy Report Type uses the following business object.

- **C1-DiscrepancyReport**



The **Discrepancy Report Type** screen allows you to define, edit, copy, and delete a discrepancy report type. It consists of the following zones:

- [Discrepancy Report Type List](#) on page 2413
- [Discrepancy Report Type](#) on page 2414

For more information on...	See...
How to define a discrepancy report type	Defining a Discrepancy Report Type on page 2415

Discrepancy Report Type List

The **Discrepancy Report Type List** zone lists the various types of discrepancy report types. It contains the following columns:

Column Name	Column Description
Discrepancy Report Type	Displays the discrepancy report type.
Description	Displays the description of the discrepancy report type.
Edit	On clicking the Edit () icon, the Discrepancy Report Type screen appears where you can edit the details of the discrepancy report type.
Duplicate	On clicking the Duplicate () icon, the Discrepancy Report Type screen appears where you can define a discrepancy report type using an existing discrepancy report type.
Delete	On clicking the Delete () icon, you can delete the discrepancy report type. Note: You can delete a discrepancy report type when you have not created a discrepancy report using the discrepancy report type.

On clicking the **Broadcast** () icon corresponding to a discrepancy report type, the **Discrepancy Report Type** zone appears with the details of the respective discrepancy report type.

Related Topics

For more information on...	See...
How to view the details of discrepancy report type	Viewing the Discrepancy Report Type Details on page 2420
How to edit the details of discrepancy report type	Editing a Discrepancy Report Type on page 2417

For more information on...	See...
How to delete the discrepancy report type	Deleting a Discrepancy Report Type on page 2419
How to copy the discrepancy report type	Copying a Discrepancy Report Type on page 2419

Discrepancy Report Type

The **Discrepancy Report Type** zone displays the details of the discrepancy report type. It consists of the following sections:

- **Main** - This section provides basic information about the discrepancy report type. It contains the following fields:

Field Name	Field Description
Discrepancy Report Type	Displays the discrepancy report type.
Discrepancy Report Business Object	Indicates the business object using which the discrepancy report will be created. In addition, a context menu appears corresponding to this field which helps in navigating to other screens in the application. Note: It has a link. On clicking the link, the Business Object screen appears where you can view the details of the respective business object.
Description	Displays the description of the discrepancy report type.
Detailed Description	Displays additional information about the discrepancy report type.
Status	Indicates the status of the inbound message type. The valid values are: <ul style="list-style-type: none"> • Active • Inactive

- **Characteristics** - This section lists the characteristics of the discrepancy report type. It contains the following columns:

Column Name	Column Description
Characteristic Type	Indicates the characteristic type. Note: The list includes only those characteristic types where the characteristic entity is set to Discrepancy Report Type.
Characteristic Value	Displays the value of the characteristic type. Note: On specifying the value for a predefined characteristic type, the description of the characteristic value appears corresponding to the Characteristic Value field.
Description	Displays detailed description of the characteristic type.

- **Record Actions** - This section contains the following buttons:

Button Name	Button Description
Edit	Used to edit the details of the discrepancy report type.

Button Name	Button Description
Delete	Used to delete the discrepancy report type.
	Note: You can delete a discrepancy report type when you have not created a discrepancy report using the discrepancy report type.
Duplicate	Used to create a new discrepancy report type using an existing discrepancy report type.

- **Record Information** - This section contains the following fields:

Field Name	Field Description
Business Object	Indicates the business object using which the discrepancy report type is created. In addition, a context menu appears corresponding to this field which helps in navigating to other screens in the application.
	Note: It has a link. On clicking the link, the Business Object screen appears where you can view the details of the respective business object.

By default, the **Discrepancy Report Type** zone does not appear in the **Discrepancy Report Type** screen. It appears when you click the **Broadcast** () icon corresponding to a discrepancy report type in the **Discrepancy Report Type List** zone.

Related Topics

For more information on...	See...
How to view the details of discrepancy report type	Viewing the Discrepancy Report Type Details on page 2420

Defining a Discrepancy Report Type

Prerequisites

To define a discrepancy report type, you should have:

- **C1-DiscrepancyReport** Business object defined for discrepancy report.
- Characteristic Type defined for the discrepancy report.

Procedure

To define a discrepancy report type:

1. Click the **Admin** link in the **Application** toolbar.
A list appears.
2. From the **Admin** menu, select **D**, and then click **Discrepancy Report Type**.
The sub-menu appears.
3. Click the **Add** option from the **Discrepancy Report Type** .

The **Select Business Object** screen appears. It contains the following field:

Field Name	Field Description	Mandatory (Yes or No)
Discrepancy Report Type Business Object	Indicates the discrepancy report type business object used to create a discrepancy report type.	Yes

Tip: Alternatively, you can access the **Select Business Object** screen by clicking the **Add** button in the **Page Title** area of the **Discrepancy Report Type** screen.

Note: The **Select Business Object** screen appears when there are multiple discrepancy report type business objects defined in the application. If there is only one discrepancy report type business object defined in the application, the **Discrepancy Report Type** screen appears.

4. Select the business object depending on whether you want to create a discrepancy report type.
5. Click **OK**.

The **Discrepancy Report Type** screen appears. It contains the following sections:

- **Main** - Used to specify basic details about the discrepancy report type.
- **Characteristics** - Used to define the characteristics for the discrepancy report type.

The **Main** section contains the following fields:

Field Name	Field Description	Mandatory (Yes or No)
Discrepancy Report Type	Used to specify the discrepancy report type.	Yes
Business Object	Indicates the discrepancy report type business object using which you are defining the discrepancy report type	Not applicable
Discrepancy Report Business Object	Used to indicate the business object using which you want to create the discrepancy report.	Yes
Description	Used to specify the description for the discrepancy report type.	Yes
Detailed Description	Used to specify additional information about the discrepancy report type.	No
Status	Used to indicate the status of the discrepancy report type. The valid values are: <ul style="list-style-type: none"> • Active • Inactive 	Yes

6. Enter the required details in the **Main** section.
7. Define characteristics for the discrepancy report type, if required.
8. Click **Save**.

The discrepancy report type is defined.

Related Topics

For more information on...	See...
Discrepancy Report Type List zone	Discrepancy Report Type List on page 2413
Discrepancy Report Type zone	Discrepancy Report Type on page 2414

Defining a Characteristic for a Discrepancy Report Type

Prerequisites

To define a characteristic for a discrepancy report type, you should have:

- Characteristic Types defined in the application (where the characteristic entity is set to **Discrepancy Report Type**).

Procedure

To define a characteristic for a discrepancy report type:

1. Ensure that the **Characteristics** section is expanded when you are defining, editing, or copying a discrepancy report type.

The **Characteristics** section contains the following fields:

Field Name	Field Description	Mandatory (Yes or No)
Characteristic Type	Used to indicate the characteristic type.	Yes (Conditional)
	Note: The list includes only those characteristic types where the characteristic entity is set to Discrepancy Report Type .	Note: This field is required when you are defining a characteristic for the discrepancy report type.
Characteristic Value	Used to specify the value for the characteristic type.	Yes (Conditional)
	Note: On specifying the value for a predefined characteristic type, the description of the characteristic value appears corresponding to the Characteristic Value field.	Note: This field is required when you are defining a characteristic for the discrepancy report type.

2. Enter the required details in the **Characteristics** section.

Note: If you select a predefined characteristic type, the **Search** (🔍) icon appears corresponding to the **Characteristic Value** field. On clicking the **Search** icon, you can search for a predefined characteristic value.

3. If you want to define more than one characteristic for the discrepancy report type, click the **Add** (+) icon and then repeat step 2.

Note: However, if you want to remove a characteristic from the discrepancy report type, click the **Delete** (🗑️) icon corresponding to the characteristic.

Related Topics

For more information on...	See...
How to edit a discrepancy report type	Editing a Discrepancy Report Type on page 2417
How to copy a discrepancy report type	Copying a Discrepancy Report Type on page 2419

Editing a Discrepancy Report Type

Prerequisites

To edit a discrepancy report type, you should have:

- **C1-DiscrepancyReport** Business object defined for discrepancy report.
- Characteristic Type defined for the discrepancy report.

Procedure

To edit a discrepancy report type:

1. Click the **Admin** link in the **Application** toolbar.
A list appears.
2. From the **Admin** menu, select **D** and then click **Discrepancy Report Type**.
A sub-menu appears.
3. Click the **Search** option from the **Discrepancy Report Type** sub-menu.
The **Discrepancy Report Type** screen appears.
4. In the **Discrepancy Report Type List** zone, click the **Edit** (✎) icon in the **Edit** column corresponding to the discrepancy report type whose details you want to edit.

The **Discrepancy Report Type** screen appears. It contains the following sections:

- **Main** - Used to specify basic details about the discrepancy report type.
- **Characteristics** - Used to define the characteristics for the discrepancy report type.

The **Main** section contains the following fields:

Field Name	Field Description	Mandatory (Yes or No)
Discrepancy Report Type	Displays the discrepancy report type.	Not applicable
Business Object	Indicates the discrepancy report type business object used while defining the discrepancy report type.	Not applicable
Discrepancy Report Business Object	Used to indicate the business object using which you want to create the discrepancy report.	Yes
Description	Used to specify the description for the discrepancy report type.	Yes
Detailed Description	Used to specify additional information about the discrepancy report type.	No
Status	Used to indicate the status of the discrepancy report type. The valid values are: <ul style="list-style-type: none"> • Active • Inactive 	No

Tip: Alternatively, you can click the **Edit** button in the **Discrepancy Report Type** zone to edit the details of the discrepancy report type.

5. Modify the required details in the **Main** section.
6. Define, edit, or remove characteristics of the discrepancy report type, if required.
7. Click **Save**.

The changes made to the discrepancy report type are saved.

Related Topics

For more information on...	See...
How to define a characteristic for a discrepancy report type	Defining a Characteristic for a Discrepancy Report Type on page 2416

Deleting a Discrepancy Report Type

Procedure

To delete a discrepancy report type:

1. Click the **Admin** link in the **Application** toolbar.
A list appears.
2. From the **Admin** menu, select **D** and then click **Discrepancy Report Type**.
The sub-menu screen appears.
3. Click the **Search** option from the **Discrepancy Report Type** sub-menu.
The **Discrepancy Report Type** screen appears.
4. In the **Discrepancy Report Type List** zone, click the **Delete** (🗑️) icon corresponding to the discrepancy report type that you want to delete.
A message appears confirming whether you want to delete the discrepancy report type.

Note: You can delete a discrepancy report type when you have not created a discrepancy report using the discrepancy report type.

Tip: Alternatively, you can click the **Delete** button in the **Discrepancy Report Type** zone to delete the discrepancy report type

5. Click **OK** .
The discrepancy report type is deleted.

Related Topics

For more information on...	See...
Discrepancy Report Type List zone	Discrepancy Report Type List on page 2413

Copying a Discrepancy Report Type

Prerequisites

To copy a discrepancy report type, you should have:

- **C1-DiscrepancyReport** Business object defined for discrepancy report.
- Characteristic Type defined for the discrepancy report.

Instead of creating a discrepancy report type from scratch, you can create a new discrepancy report type using an existing discrepancy report type. This is possible through copying a discrepancy report type. On copying a discrepancy report type, the details including the characteristics are copied to the new discrepancy report type. You can then edit the details, if required.

Procedure

To copy a discrepancy report type:

1. Click the **Admin** link in the **Application** toolbar.
A list appears.
2. From the **Admin** menu, select **D** and then click **Discrepancy Report Type**.
The sub-menu appears.

- Click the **Search** option from the **Discrepancy Report Type** sub-menu.

The **Discrepancy Report Type** screen appears.

- In the **Discrepancy Report Type List** zone, click the **Duplicate** (📄) icon in the **Duplicate** column corresponding to the discrepancy report type whose copy you want to create.

The **Discrepancy Report Type** screen appears. It contains the following sections:

- Main** - The main section contains the following fields:
- Characteristics** - Used to define the characteristics for the discrepancy report type.

The **Main** section contains the following fields:

Field Name	Field Description	Mandatory (Yes or No)
Discrepancy Report Type	Used to specify the discrepancy report type	Not applicable
Business Object	Indicates the discrepancy report type business object using which you are defining the discrepancy report type.	Not applicable
Discrepancy Report Business Object	Used to indicate the business object using which you want to create the discrepancy report.	Yes
Description	Used to specify the description for the discrepancy report type.	Yes
Detailed Description	Used to specify additional information about the discrepancy report type.	No
Status	Indicates the status of discrepancy report type. The valid values are: <ul style="list-style-type: none"> Active Inactive 	Yes

Tip: Alternatively, you can create a copy of the **Discrepancy Report Type** zone to create a copy of the discrepancy report type.

- Enter the required details in the **Main** section.
- Define, edit, or remove characteristics of the discrepancy report type, if required.
- Click **Save**.

The new discrepancy report type is defined.

Related Topics

For more information on...	See...
How to define a characteristic for a discrepancy report type	Defining a Characteristic for a Discrepancy Report Type on page 2416

Viewing the Discrepancy Report Type Details

Procedure

To view the details of a discrepancy report type:

- Click the **Admin** link in the **Application** toolbar.

A list appears.

- From the **Admin** menu, select **D** and then click **Discrepancy Report Type**.

A sub-menu appears.

- Click the **Search** option from the **Discrepancy Report Type** sub-menu.

The **Discrepancy Report Type** screen appears.

- In the **Discrepancy Report Type List** zone, click the **Broadcast** (📡) icon corresponding to the discrepancy report type whose details you want to view.

The **Discrepancy Report Type** zone appears.

- View the details of the discrepancy type in the **Discrepancy Report Type** zone.

Related Topics

For more information on...	See...
Discrepancy Report Type screen	Discrepancy Report Type on page 2413
Discrepancy Report Type zone	Discrepancy Report Type on page 2414
Discrepancy Report Type List zone	Discrepancy Report Type List on page 2413

Discrepancy Report (Used for Searching)

The **Discrepancy Report** screen allows you to search for a discrepancy report using various search criteria. Through this screen, you can navigate to the following screen:

- [Discrepancy Report \(Used for Viewing\)](#) on page 2426
- [Search Discrepancy Report](#) on page 2421

Search Discrepancy Report

The **Search Discrepancy Report** zone allows you to search for a discrepancy report using various search criteria. It contains the following two sections:

Search Criteria - The **Search Criteria** section contains the following fields:

Field Name	Field Description	Mandatory (Yes or No)
Search By	Used to indicate whether you want to search for a discrepancy report using the discrepancy or account details. The valid values are: <ul style="list-style-type: none"> Discrepancy Details Account Details 	Yes
	Note: By default, the Discrepancy Details option is selected	
Discrepancy Report ID	Used to search a particular discrepancy report..	No
	Note: This field appears when you select the Discrepancy Details option from the Search By list.	

Field Name	Field Description	Mandatory (Yes or No)
Discrepancy Report Type	Used to indicate the levels at which the discrepancy report is generated. It has following options: <ul style="list-style-type: none"> Account Level File Level 	No
	Note: This field appears when Discrepancy Details is selected from the Search By list.	
Status	Used to search a particular discrepancy reports with a particular status. The valid values are: <ul style="list-style-type: none"> Completed Draft Pending 	No
	Note: This field appears when you select the Discrepancy Details option from the Search By list.	
File Name	Used to specify the filename that is provided when a discrepancy report is created at file level.	No
	Note: This field appears when you select the Discrepancy Details option from the Search By list.	
Created From	Used to search discrepancy reports which are created from a particular date onwards.	No
	Note: This field appears when you select the Discrepancy Details option from the Search By list.	
Created To	Used to search for discrepancy report which is created till a particular date.	No
	Note: This field appears when you select the Discrepancy Details option from the Search By list.	
Person Name	Used to search discrepancy reports through which a particular person's record is created or updated in the system.	No
	Note: This field appears when you select the Account Details option from the Search By list.	

Field Name	Field Description	Mandatory (Yes or No)
Account Identifier Type	Used to select the identifier type based on which you want to search discrepancy reports through which the account details are created or updated in the system. <ul style="list-style-type: none"> Account Name Base Global Account ID Bill Group Identifier Demo Bank Account Number External Account Identifier Flexcube Account ID International Bank Account Number 	Yes (Conditional) Note: If you specify the account identifier as a search criteria, you have to select the account identifier type.
	Note: This field appears when you select the Account Details option from the Search By list.	
Account Identifier	Used to specify the value for the account identifier type.	Yes (Conditional) Note: If you specify the account identifier type as a search criteria, you have to specify the account identifier.
	Note: This field appears when Account Details is selected from the Search By list.	
Account ID	Used to search discrepancy reports that are created by a particular user.	No
	Note: This field appears when you select the Account Details option from the Search By list.	

Note: You must specify at least one search criterion while searching for a discrepancy report.

Search Results - On clicking the **Search** button, the search results appear based on the specified search criteria. The **Search Results** section contains the following columns:

Column Name	Column Description
Creation Date Time	Displays date and time when the discrepancy report was created.
Discrepancy Report Information	Displays information about the discrepancy report.
	Note: It has a link. On clicking the link, the Discrepancy Report screen appears where you can view the details of the respective discrepancy report.
Status	Indicates the status of the discrepancy report. The valid values are: <ul style="list-style-type: none"> Pending Draft Completed
Account ID	Displays the account ID of the person who created the discrepancy report.
File Name	Displays the filename given when discrepancy report is created at file level.

Related Topics

For more information on...	See...
How to search for a discrepancy report	Searching for a Discrepancy Report on page 2424
How to view the details of a discrepancy report	Viewing the Discrepancy Report Details on page 2426

Searching for a Discrepancy Report**Prerequisites**

To search for a discrepancy report, you should have:

- **C1-DiscrepancyReport** Business object defined for discrepancy report.
- Discrepancy Report Type defined for discrepancy report.
- Status defined for discrepancy report.

Procedure

To search for a discrepancy report:

1. Click the **Menu** link in the **Application** toolbar.
A list appears.
2. From the **Menu** menu, select **Accounting and Receivable** and then click **Discrepancy Report**.
A sub-menu appears.
3. Click the **Search** option from the **Discrepancy Report** sub-menu.
The **Discrepancy Report** screen appears.
4. Enter the search criteria in the **Search Discrepancy Report** zone.

Note: ORMB search engine supports wildcard search, where you can substitute the percentage (%) symbol as a stand in for any word or letter in a search criteria. You can use the ‘%’ wildcard character in all input fields except the date and ID fields. The ‘%’ wildcard character is suffixed automatically at the end of the partial search criteria. Therefore, you may or may not specify the wildcard character at the end of the partial search criteria. However, you have to prefix the wildcard character manually wherever required.

5. Click **Search**.

A list of discrepancy reports that meet the search criteria appear in the **Search Results** section.

Related Topics

For more information on...	See...
Discrepancy Report screen	Discrepancy Report (Used for Searching) on page 2421
Discrepancy Report zone	Search Discrepancy Report on page 2421

Creating a Discrepancy Report**Prerequisites**

To create a discrepancy report, you should have:

- Discrepancy Report Type defined in the application.
- Report Level defined in the application.

Procedure

To create a discrepancy report:

1. Click the **Menu** link in the **Application** toolbar.
A list appears.
2. From the **Main** menu, select **Accounting and Receivable** and then click **Discrepancy Report**.
A sub-menu appears.
3. Click the **Add** option from the **Discrepancy Report** sub-menu.

The **Discrepancy Report** screen appears. It contains the following fields:

Field Name	Field Description	Mandatory (Yes or No)
Discrepancy Report Type	Used to indicate the discrepancy report type that you want to use to create the discrepancy report. The valid values are: <ul style="list-style-type: none"> • Discrepancy Report Type • File Discrepancy Report Type 	Yes
Report Level	Used to specify the level at which the discrepancy report is created. The valid values are: <ul style="list-style-type: none"> • At Account Level • At File Level 	Yes
File Name	Used to specify a name for the file when report level is selected as At File Level .	Yes (Conditional) Note: This field is required when the report level is selected as At File Level while creating a discrepancy report.
Account ID	Used to specify an account ID when report level is selected as At Account Level .	Yes (Conditional) Note: This field is required when the report level is selected as At Account Level while creating a discrepancy report.

Tip: Alternatively, you can access the **Select Discrepancy Report Type** screen by clicking the **Add** button in the **Page Title** area of the **Discrepancy Report** screen.

4. Enter the required details.
5. Click **Save**.
The **Discrepancy Report** is created.

Related Topics

For more information on...	See...
Discrepancy Line Items zone	Discrepancy Line Items on page 2428

For more information on...	See...
Discrepancy Line Items Related Objects zone	Discrepancy Line Item Related Objects on page 2429
Discrepancy Line Item Characteristics zone	Discrepancy Line Items Characteristics Zone on page 2430

Viewing the Discrepancy Report Details

Procedure

To view the details of a discrepancy report:

1. Search for the discrepancy report in the **Discrepancy Report** screen.
2. In the **Search Results** section, click the link in the **Discrepancy Report Information** column corresponding to the discrepancy report whose details you want to view.

The **Discrepancy Report** screen appears. It contains the following tabs:

- [Discrepancy Report - Main](#) on page 2427
- [Discrepancy Report - Log](#) on page 2430

3. Ensure that the **Main** tab is selected.
4. View the details of the discrepancy report in the **Discrepancy Report** zone.

Related Topics

For more information on...	See...
How to search for a discrepancy report	Searching for a Discrepancy Report on page 2424
Discrepancy Report screen	Discrepancy Report (Used for Viewing) on page 2426
Discrepancy Report zone	Discrepancy Report - Main on page 2427

Discrepancy Report (Used for Viewing)

Once the discrepancy reports are created, the **Discrepancy Report** screen allows you to:

- View the details of discrepancy report.
- Delete a discrepancy report
- Edit a discrepancy line item
- Finalize a discrepancy report
- View the log of a discrepancy report
- Add a log entry for a discrepancy report
- View the discrepancy line item related objects

This screen consists of the following tabs:

- [Discrepancy Report - Main](#) on page 2427
- [Discrepancy Report - Log](#) on page 2430

For more information on...	See...
How to view the details of discrepancy report	Viewing the Discrepancy Report Details on page 2426
How to delete a discrepancy report	Deleting a Discrepancy Report on page 2432
How to edit a discrepancy line item	Editing a Discrepancy Line Item on page 2430
How to add a log entry for a discrepancy report	Adding a Log Entry for a Discrepancy Report on page 2433
How to view the log of a discrepancy report	Viewing the Log of a Discrepancy Report on page 2433
Discrepancy Line Item Related Objects zone	Discrepancy Line Item Related Objects on page 2429

Discrepancy Report - Main

The **Discrepancy Report - Main** tab displays information about the discrepancy report. It contains the following zones:

- [Discrepancy Report](#) on page 2427
- [Discrepancy Line Items](#) on page 2428
- [Discrepancy Line Item Related Objects](#) on page 2429
- [Discrepancy Line Items Characteristics Zone](#) on page 2430

Discrepancy Report

The **Discrepancy Report** zone displays the details of the discrepancy report. It contains the following sections:

- **Main** - Displays basic information about the discrepancy report. It contains the following fields:

Field Name	Field Description
Discrepancy Report Information	Displays information about the discrepancy report.
Discrepancy Report Type	Indicates the discrepancy report type using which the discrepancy report is created. Note: It has a link. On clicking the link, the Discrepancy Report Type screen appears where you can view the details of the discrepancy report type.
File Name	Displays the filename for which the discrepancy report is generated.
Account Information	Displays the details of the account for which discrepancy report is generated.
Status	Indicates the status of the discrepancy report. The valid values are: <ul style="list-style-type: none"> • Pending • Draft • Completed

- **Record Actions** - This section contains the following buttons:

Button Name	Button Description
Delete	Used to delete the discrepancy report.
	Note: The Delete button appears when the discrepancy report is in the Pending status.
Finalize	Used to finalize all the changes and process the discrepancy report.
	Note: Finalize button appears when the discrepancy report is in the Pending status.

- **Record Information** - This section contains the following fields:

Field Name	Field Description
Business Object	Indicates the business object using which the discrepancy report is created. In addition, a context menu appears corresponding to this field which helps in navigating to other screens in the application.
	Note: It has a link. On clicking the link, the Business Object screen appears where you can view the details of the respective business object.
Status Date Time	Displays the date and time when the status of the discrepancy report was defined.
Creation Date Time	Displays the date and time when the discrepancy report was created.

Discrepancy Line Items

The **Discrepancy Line Items** zone displays the details of the discrepancy report It contains the following columns:

Column Name	Column Description
Account ID	Indicates the account for which the discrepancy line item is created.
	Note: This column appears when you select the discrepancy report information where the filename is provided.
Policy Number	Indicates the policy number.
Plan Number	Indicates the plan number of the policy.
Member Identifier Type	Displays the member identifier type.
Member Identifier	Displays the value of the member identifier type.
Member Name	Displays the name of the member to whom the discrepancy report belongs.
Coverage Start Date	Displays the date from when the coverage starts.
Coverage End Date	Displays the date till when the coverage ends.
Billed Amount	Displays the bill segment amount.
Paid Amount	Displays the paid amount of the bill.
Discrepancy Amount	Displays the discrepancy amount.
Discrepancy Category	Displays the discrepancy category.

Column Name	Column Description
Consumer Status	Displays the status of the consumer for its existence in the application.
Comments	Displays the comments, added for the discrepancy line items.
Edit	On clicking the Edit (✎) icon, the Discrepancy Line Item screen appears where you can edit the details of the discrepancy line item. Note: The Edit icon appears when the discrepancy report is in Pending or Draft status.

Note:

On clicking the Broadcast (📡) icon corresponding to the discrepancy line item, the Discrepancy Line Item Related Objects and Discrepancy Line Item Characteristics zones appear.

You can filter the discrepancy line items using Discrepancy Category search criteria available in the Filter area. By default, the Filter area is hidden. You can view the Filter area by clicking the Filters (⌵) icon in the upper right corner of the Discrepancy Line Items zone.

Pagination is used to display limited number of records in the Search Results section. You can change the number of records displayed per page, if required. You can use the navigation links, such as Previous and Next to navigate between pages.

Related Topics

For more information on...	See...
How to view the details of discrepancy report	Viewing the Discrepancy Report Details on page 2426
How to edit the details of discrepancy line items	Editing a Discrepancy Line Item on page 2430

Discrepancy Line Item Related Objects

The **Discrepancy Line Item Related Objects** zone lists the related objects for the discrepancy line item. It contains the following columns:

Column Name	Column Description
Related Object Type	Displays Financial Transaction or Member Pay Instruction as the related object type.
Related Object Information	Displays brief information about the related object type. Note: It has a link. On clicking the link, the Pay Instruction screen appears with the details of the respective related object.

By default, the Discrepancy Line Item Related Objects zone does not appear in the Discrepancy Report screen. It appears when you click the Broadcast (📡) icon corresponding to the discrepancy line item in the Discrepancy Line Items zone.

Pagination is used to display limited number of records in the Search Results section. You can change the number of records displayed per page, if required. You can use the navigation links, such as Previous and Next to navigate between pages.

Related Topics

For more information on...	See...
Discrepancy Line Items zone	Discrepancy Line Items on page 2428

Discrepancy Line Items Characteristics Zone

Note: At present the **Discrepancy Line Item Characteristics** cannot be added. The Discrepancy Line Items Characteristics zone will be fully functional in the future release.

Related Topics

For more information on...	See...
How to view the details of discrepancy report	Viewing the Discrepancy Report Details on page 2426
How to edit the details of discrepancy line items	Editing a Discrepancy Line Item on page 2430

Discrepancy Report - Log

The **Discrepancy Report - Log** tab contains the following zone:

- [Discrepancy Report Log](#) on page 2430

Discrepancy Report Log

The **Discrepancy Report Log** zone lists the complete trail of actions performed on the Discrepancy Report. It contains the following columns:

Column Name	Column Description
Creation Date/Time	Displays the date and time when the action was performed on the discrepancy report.
Details	Displays the details about the action performed on the discrepancy report.
User	Indicates the user who has performed the action on the discrepancy report.
Log Type	Indicates the type of log.
Related Object	Indicates the object or entity which is generated when the action is performed on the discrepancy report.
Status Reason	Displays the status reason of the action performed on the discrepancy report object.

Note: You can manually add a log entry for the discrepancy report by clicking the **Add Log Entry** link in the upper right corner of the **Discrepancy Report Log** zone.

Related Topics

For more information on...	See...
How to view the log of the discrepancy report	Viewing the Log of a Discrepancy Report on page 2433
How to add a log entry for a discrepancy report	Adding a Log Entry for a Reconciliation on page 2404

Editing a Discrepancy Line Item

Prerequisites

To edit a discrepancy line item, you should have:

- Discrepancy Line Item status as Pending or Draft.

Procedure

To edit a discrepancy line item:

1. Search for the discrepancy report in the **Discrepancy Report** screen.
2. In the **Search Results** section, click the link in the **Discrepancy Report Information** column corresponding to the discrepancy report, whose details you want to edit.

The **Discrepancy Report Information** screen appears.

3. In the **Discrepancy Line Items** zone, click the **Edit**  icon in the **Edit** corresponding to the discrepancy line item whose details you want to edit.

The **Discrepancy Line Item** screen appears.

Note: The Edit icon appears when the discrepancy line item is in the Pending or Draft status.

The **Discrepancy Line Item** screen contains the following fields:

Field Name	Field Description
Discrepancy Report ID	Displays the discrepancy report ID.
Account ID	Indicates the account for which the discrepancy line item is created.
Policy Number	Indicates the policy number.
Plan Number	Indicates the plan number of the policy.
Member Identifier Type	Displays the member identifier type.
Member Identifier	Displays the value of the member identifier.
Member Name	Displays the name of the member to whom the discrepancy report belongs.
Coverage Start Date	Displays the start date of the coverage cycle.
Coverage End Date	Displays the end date of the coverage cycle.
Billed Amount	Displays the bill segment amount.
Paid Amount	Displays the paid amount of the bill amount.
Discrepancy Amount	Displays the amount that highlights the discrepancy value.
Discrepancy Category	Used to specify the discrepancy category. The valid values are: <ul style="list-style-type: none"> • Billed Not Paid • Paid Not Billed • Rate Variance
Comments	Used to specify additional details about the Discrepancy Line Item.

4. Modify the required details for the discrepancy line item.
5. Click **Save**.

The changes made to the discrepancy line item are saved.

Related Topics

For more information on...	See...
How to view the details of discrepancy report	Viewing the Discrepancy Report Details on page 2426
Discrepancy Report zone	Discrepancy Report on page 2427

Deleting a Discrepancy Report

Procedure

To delete a discrepancy report:

1. Search for the discrepancy report in the **Discrepancy Report** screen.
2. In the **Search Results** section, click the link in the **Discrepancy Report Information** column corresponding to the discrepancy report that you want to delete.

The **Discrepancy Report** screen appears.

3. Click the **Delete** button in the **Discrepancy Report** zone.

A message appears confirming whether you want to delete the discrepancy report.

Note: The **Delete** button appears when the discrepancy report is in the **Pending** or **Draft** status.

4. Click **OK**.

The discrepancy report is deleted.

Related Topics

For more information on...	See...
How to search for a discrepancy report	Searching for a Discrepancy Report on page 2424

Finalizing a Discrepancy Report

Prerequisites

To finalize a discrepancy report, you should have:

- Discrepancy Report status as Pending or Draft.

Procedure

To finalize a discrepancy report:

1. Search for the discrepancy report in the **Discrepancy Report** screen.
2. In the **Search Results** section, click the link in the **Discrepancy Report Information** column corresponding to the discrepancy report that you want to finalize.

The **Discrepancy Report** screen appears.

3. Click the **Finalize** button in the **Discrepancy Report** zone.

The status of the discrepancy report is changed to **Completed**.

Note: The **Finalize** button appears when the discrepancy report is in the **Pending** status.

Related Topics

For more information on...	See...
How to search for a discrepancy report	Searching for a Discrepancy Report on page 2424

Adding a Log Entry for a Discrepancy Report

Procedure

To add a log entry for a discrepancy report:

1. Search for the discrepancy report in the **Discrepancy Report** screen.
2. In the **Search Results** section, click the link in the **Discrepancy Report Information** column corresponding to the discrepancy report whose log you want to edit.

The **Discrepancy Report** screen is displayed. It consists of following tabs.

- [Discrepancy Report - Main](#) on page 2427
- [Discrepancy Report - Log](#) on page 2430

3. Click the **Log** tab.

The **Log** tab appears.

4. Click the **Add Log Entry** link in the upper right corner of the **Discrepancy Report Log** zone.

The **Add Discrepancy Report Log** window appears. It contains the following fields:

Field Name	Field Description	Mandatory (Yes or No)
Discrepancy Report Information	Displays information about the discrepancy report.	Not applicable
Log Details	Used to specify additional comments for the discrepancy report.	Yes

5. Enter the comments in the **Log Details** field.
6. Click **Save**.

The log entry is added in the **Discrepancy Report Log** zone.

Related Topics

For more information on...	See...
How to search for a discrepancy report	Searching for a Discrepancy Report on page 2424

Viewing the Log of a Discrepancy Report

Procedure

To view the log of a discrepancy report:

1. Search for the discrepancy report in the **Discrepancy Report** screen.
2. In the **Search Results** section, click the link in the **Discrepancy Report Information** column corresponding to the discrepancy report whose log you want to view.

The **Discrepancy Report** screen appears. It consists of the following tabs:

- [Discrepancy Report - Main](#) on page 2427
- [Discrepancy Report - Log](#) on page 2430

3. Click the **Log** tab.

The **Log** tab appears.

4. View the complete trail of actions performed on the discrepancy report in the **Discrepancy Report Log** zone.

Related Topics

For more information on...	See...
How to search for a discrepancy report	Searching for a Discrepancy Report on page 2424

Member Reconciliation Preference

Oracle Revenue Management and Billing enables you to reconcile all pay instructions of a file at the member level through a batch named **C1-RCPM**. While executing the **C1-RCPM** batch, you need to specify a member reconciliation preference whose attributes you want to use while reconciling all pay instructions of a file at the member level. For more information about the batch, see *Oracle Revenue Management and Billing Batch Guide*.

A member reconciliation preference consists of the following attributes:

- Payment Event Characteristic Type
- Pay Instruction Completed Status
- Reconciliation Matching Level Characteristic Type
- Pay Instruction Open Status
- Reconciliation Open Status

For more information about these attributes, see [Defining a Member Reconciliation Preference](#) on page 2435. You can define, edit, delete, and copy a member reconciliation preference through the **Field Mapping** screen.

Searching for a Member Reconciliation Preference

Prerequisites

To search for a member reconciliation preference, you should have:

- Values defined in the **FIELD_CAT_FLG** lookup field

Procedure

To search for a member reconciliation preference:

1. Click the **Admin** link in the **Application** toolbar.
A list appears.
2. From the **Admin** menu, select **F** and then click **Field Mapping**.
A sub-menu appears.
3. Click the **Search** option from the **Field Mapping** sub-menu.
The **Field Mapping** screen appears.
4. Select the **Member Reconciliation** option from the **Preference Category** list.
5. Enter the additional search criteria in the **Search Field Mapping** zone.

Note: ORMB search engine supports wildcard search, where you can substitute the percentage (%) symbol as a stand in for any word or letter in a search criteria. You can use the ‘%’ wildcard character in all input fields except the date and ID fields. The ‘%’ wildcard character is suffixed automatically at the end of the partial search criteria. Therefore, you may or may not specify the wildcard character at the end of the partial search criteria. However, you have to prefix the wildcard character manually wherever required.

6. Click **Search**.

A list of member reconciliation preferences that meet the search criteria appears in the **Search Results** section.

Viewing the Member Reconciliation Preference Details

Procedure

To view the details of a member reconciliation preference:

1. Search for the member reconciliation preference in the **Field Mapping** screen.
2. In the **Search Results** section, click the **Broadcast** () icon corresponding to the member reconciliation preference whose details you want to view.
The **Field Mapping** zone appears.
3. View the details of the member reconciliation preference in the **Field Mapping** zone.

Related Topics

For more information on...	See...
How to search for a member reconciliation preference	Searching for a Member Reconciliation Preference on page 2434

Defining a Member Reconciliation Preference

Prerequisites

To define a member reconciliation preference, you should have:

- Required characteristic types defined in the application
- Required statuses defined in the lifecycle of the **C1-MemberReconciliation** and **C1-PayInstruction** business objects
- Values defined in the **MAP_ENTITY_FLG** lookup field

Procedure

To define a member reconciliation preference:

1. Click the **Admin** link in the **Application** toolbar.
A list appears.
2. From the **Admin** menu, select **F** and then click **Field Mapping**.
A sub-menu appears.
3. Click the **Add** option from the **Field Mapping** sub-menu.

The **Select Business Object** screen appears. It contains the following field:

Field Name	Field Description	Mandatory (Yes or No)
Field Mapping Business Object	Used to indicate the business object using which you want to create the member reconciliation preference. The valid values are: <ul style="list-style-type: none"> • Field Mapping • Medicare Plan Benefit Package • Membership Status Reason Mapping 	Yes

Note: Alternatively, you can access the **Select Business Object** screen by clicking the **Add** button in the **Page Title** area of the **Field Mapping** screen.

4. Select the **Field Mapping** option from the **Field Mapping Business Object** list.
5. Click **OK**.

The **Field Mapping** screen appears. It contains the following sections:

- **Main** - Used to specify basic details of the member reconciliation preference. It contains the following fields:

Field Name	Field Description	Mandatory (Yes or No)
Preference	Used to specify the member reconciliation preference.	Yes
Description	Used to specify the description for the member reconciliation preference.	Yes
Detailed Description	Used to specify additional information about the member reconciliation preference.	No
Status	Used to indicate the status of the member reconciliation preference. The valid values are: <ul style="list-style-type: none"> • Active • Inactive 	Yes

- **Preference Category** - This section contains the following field:

Field Name	Field Description	Mandatory (Yes or No)
Preference Category	Used to indicate the category to which the preference belongs. The valid values are: <ul style="list-style-type: none"> • Billing • Binder Payment • Geographic Rating Area • Individual Membership • Medicare • Medicare Plan Benefit • Member Reconciliation • Member Relationship and Subscription Tier • Membership Status Reason • Statement Construct 	Yes

- **Preference Settings** - Used to set the attributes in the member reconciliation preference. It contains the following fields in a grid:

Field Name	Field Description	Mandatory (Yes or No)
Attribute	<p>Used to indicate the attribute which you want to set in the member reconciliation preference. The valid values are:</p> <ul style="list-style-type: none"> • Payment Event Characteristic Type - Used when a pay instruction is reconciled at the member level through the C1-RCPM batch. • Pay Instruction Completed Status - Used when a pay instruction is fully reconciled at the member level through the C1-RCPM batch. • Reconciliation Matching Level Characteristic Type - Used when reconciliation is created for a pay instruction file where all pay instructions have member data. • Pay Instruction Open Status - Used when a pay instruction is not fully reconciled at the member level through the C1-RCPM batch. • Reconciliation Open Status - Used when one or more pay instructions of a file are not yet fully reconciled at the member level through the C1-RCPM batch. 	<p>Yes (Conditional)</p> <p>Note: This field is required while setting an attribute in the member reconciliation preference.</p>

Field Name	Field Description	Mandatory (Yes or No)				
Value	<p>Used to specify the attribute value. The attribute value that you can specify varies depending on the attribute you want to set in the member reconciliation preference:</p> <table border="1" data-bbox="609 359 1123 1236"> <thead> <tr> <th data-bbox="609 359 857 443">If the attribute is set to...</th> <th data-bbox="857 359 1123 443">Then, this field is...</th> </tr> </thead> <tbody> <tr> <td data-bbox="609 443 857 1236">Payment Event Characteristic Type</td> <td data-bbox="857 443 1123 1236"> <p>Used to specify the characteristic type where you can store the payment event ID. This type of characteristic is defined for the reconciliation adjustments. It indicates the payment event whose payment is distributed against the bill segment. Here, you must specify a characteristic type where the characteristic entity is set to Adjustment.</p> <div data-bbox="862 1041 1118 1220" style="border: 1px solid black; padding: 5px;"> <p>Note: The C1PAYEVT characteristic type is shipped with the product.</p> </div> </td> </tr> </tbody> </table>	If the attribute is set to...	Then, this field is...	Payment Event Characteristic Type	<p>Used to specify the characteristic type where you can store the payment event ID. This type of characteristic is defined for the reconciliation adjustments. It indicates the payment event whose payment is distributed against the bill segment. Here, you must specify a characteristic type where the characteristic entity is set to Adjustment.</p> <div data-bbox="862 1041 1118 1220" style="border: 1px solid black; padding: 5px;"> <p>Note: The C1PAYEVT characteristic type is shipped with the product.</p> </div>	<p>Yes (Conditional)</p> <div data-bbox="1143 264 1468 401" style="border: 1px solid black; padding: 5px;"> <p>Note: This field is required while setting an attribute in the member reconciliation preference.</p> </div>
If the attribute is set to...	Then, this field is...					
Payment Event Characteristic Type	<p>Used to specify the characteristic type where you can store the payment event ID. This type of characteristic is defined for the reconciliation adjustments. It indicates the payment event whose payment is distributed against the bill segment. Here, you must specify a characteristic type where the characteristic entity is set to Adjustment.</p> <div data-bbox="862 1041 1118 1220" style="border: 1px solid black; padding: 5px;"> <p>Note: The C1PAYEVT characteristic type is shipped with the product.</p> </div>					

Field Name	Field Description	Mandatory (Yes or No)				
	<table border="1"> <tr> <td data-bbox="609 222 857 699">Pay Instruction Completed Status</td> <td data-bbox="857 222 1123 699"> <p>Used to specify the status code to which you want to transition the pay instruction when it is fully reconciled.</p> <p>Note: Here, you must specify the status code which is already defined in the lifecycle of the C1-PayInstruction business object.</p> </td> </tr> <tr> <td data-bbox="609 699 857 1461">Reconciliation Matching Level Characteristic Type</td> <td data-bbox="857 699 1123 1461"> <p>Used to specify the characteristic type which indicates all pay instructions in the file must be reconciled at the member level. This type of characteristic is defined for the reconciliation when all pay instructions in a file have member data. Here, you must specify a characteristic type where the characteristic entity is set to Member Reconciliation.</p> <p>Note: The C1-MTLVL characteristic type is shipped with the product.</p> </td> </tr> </table>	Pay Instruction Completed Status	<p>Used to specify the status code to which you want to transition the pay instruction when it is fully reconciled.</p> <p>Note: Here, you must specify the status code which is already defined in the lifecycle of the C1-PayInstruction business object.</p>	Reconciliation Matching Level Characteristic Type	<p>Used to specify the characteristic type which indicates all pay instructions in the file must be reconciled at the member level. This type of characteristic is defined for the reconciliation when all pay instructions in a file have member data. Here, you must specify a characteristic type where the characteristic entity is set to Member Reconciliation.</p> <p>Note: The C1-MTLVL characteristic type is shipped with the product.</p>	
Pay Instruction Completed Status	<p>Used to specify the status code to which you want to transition the pay instruction when it is fully reconciled.</p> <p>Note: Here, you must specify the status code which is already defined in the lifecycle of the C1-PayInstruction business object.</p>					
Reconciliation Matching Level Characteristic Type	<p>Used to specify the characteristic type which indicates all pay instructions in the file must be reconciled at the member level. This type of characteristic is defined for the reconciliation when all pay instructions in a file have member data. Here, you must specify a characteristic type where the characteristic entity is set to Member Reconciliation.</p> <p>Note: The C1-MTLVL characteristic type is shipped with the product.</p>					

Field Name	Field Description	Mandatory (Yes or No)				
	<table border="1"> <tr> <td data-bbox="610 216 854 695">Pay Instruction Open Status</td> <td data-bbox="860 216 1127 695"> <p>Used to specify the status code to which you want to transition the pay instruction when it is not fully reconciled.</p> <p>Note: Here, you must specify the status code which is already defined in the lifecycle of the C1-PayInstruction business object.</p> </td> </tr> <tr> <td data-bbox="610 703 854 1253">Reconciliation Open Status</td> <td data-bbox="860 703 1127 1253"> <p>Used to specify the status code to which you want to transition the reconciliation when the status of the pay instruction is changed to Open.</p> <p>Note: Here, you must specify the status code which is already defined in the lifecycle of the C1-MemberReconciliation business object.</p> </td> </tr> </table>	Pay Instruction Open Status	<p>Used to specify the status code to which you want to transition the pay instruction when it is not fully reconciled.</p> <p>Note: Here, you must specify the status code which is already defined in the lifecycle of the C1-PayInstruction business object.</p>	Reconciliation Open Status	<p>Used to specify the status code to which you want to transition the reconciliation when the status of the pay instruction is changed to Open.</p> <p>Note: Here, you must specify the status code which is already defined in the lifecycle of the C1-MemberReconciliation business object.</p>	
Pay Instruction Open Status	<p>Used to specify the status code to which you want to transition the pay instruction when it is not fully reconciled.</p> <p>Note: Here, you must specify the status code which is already defined in the lifecycle of the C1-PayInstruction business object.</p>					
Reconciliation Open Status	<p>Used to specify the status code to which you want to transition the reconciliation when the status of the pay instruction is changed to Open.</p> <p>Note: Here, you must specify the status code which is already defined in the lifecycle of the C1-MemberReconciliation business object.</p>					
Entity Type	<p>Used to indicate the type of entity for which the attribute is applicable. The valid values are:</p> <ul style="list-style-type: none"> • Account • Billable Charge <p>Note: At present, this data is stored for informational purposes only and is not considered in the business logic. If required, you can add more entity types to the MAP_ENTITY_FLG lookup field.</p>	No				

Note: While defining a member reconciliation preference, you must set at least one attribute in the member reconciliation preference.

6. Select the **Member Reconciliation** option from the **Preference Category** list.
7. Enter the required details in the **Main** section.
8. Select the required attribute and value from the respective fields.

9. If you want to set more than one attribute in the member reconciliation preference, click the **Add (+)** icon and then repeat step 8.

Note: However, if you want to remove an attribute from the member reconciliation preference, click the **Delete (🗑)** icon corresponding to the attribute.

10. Click **Save**.

The member reconciliation preference is defined.

Editing a Member Reconciliation Preference

Prerequisites

To edit a member reconciliation preference, you should have:

- Required characteristic types defined in the application
- Required statuses defined in the lifecycle of the **C1-MemberReconciliation** and **C1-PayInstruction** business objects
- Values defined in the **MAP_ENTITY_FLG** lookup field

Procedure

To edit a member reconciliation preference:

1. Search for the member reconciliation preference in the **Field Mapping** screen.
2. In the **Search Results** section, click the **Edit (📎)** icon in the **Edit** column corresponding to the member reconciliation preference whose details you want to edit.

The **Field Mapping** screen appears. It contains the following sections:

- **Main** - Used to specify basic details of the member reconciliation preference. It contains the following fields:

Field Name	Field Description	Mandatory (Yes or No)
Preference	Displays the member reconciliation preference.	Not applicable
Description	Used to specify the description for the member reconciliation preference.	Yes
Detailed Description	Used to specify additional information about the member reconciliation preference.	No
Status	Used to indicate the status of the member reconciliation preference. The valid values are: <ul style="list-style-type: none"> • Active • Inactive 	Yes
Preference Category	Indicates the category to which the preference belongs. The valid value is: <ul style="list-style-type: none"> • Member Reconciliation 	Not applicable

- **Preference Settings** - Used to set the attributes in the member reconciliation preference. It contains the following fields in a grid:

Field Name	Field Description	Mandatory (Yes or No)
Attribute	<p>Used to indicate the attribute which you want to set in the member reconciliation preference. The valid values are:</p> <ul style="list-style-type: none"> • Payment Event Characteristic Type - Used when a pay instruction is reconciled at the member level through the C1-RCPM batch. • Pay Instruction Completed Status - Used when a pay instruction is fully reconciled at the member level through the C1-RCPM batch. • Reconciliation Matching Level Characteristic Type - Used when reconciliation is created for a pay instruction file where all pay instructions have member data. • Pay Instruction Open Status - Used when a pay instruction is not fully reconciled at the member level through the C1-RCPM batch. • Reconciliation Open Status - Used when one or more pay instructions of a file are not yet fully reconciled at the member level through the C1-RCPM batch. 	<p>Yes (Conditional)</p> <div style="border: 1px solid black; padding: 5px; margin-top: 10px;"> <p>Note: This field is required while setting an attribute in the member reconciliation preference.</p> </div>

Field Name	Field Description	Mandatory (Yes or No)				
Value	Used to specify the attribute value. The attribute value that you can specify varies depending on the attribute you want to set in the member reconciliation preference:	Yes (Conditional)				
	<table border="1" data-bbox="639 390 1182 1327"> <thead> <tr> <th data-bbox="639 390 938 443">If the attribute is set to...</th> <th data-bbox="938 390 1182 443">Then, this field is...</th> </tr> </thead> <tbody> <tr> <td data-bbox="639 443 938 1327">Payment Event Characteristic Type</td> <td data-bbox="938 443 1182 1327">Used to specify the characteristic type where you can store the payment event ID. This type of characteristic is defined for the reconciliation adjustments. It indicates the payment event whose payment is distributed against the bill segment. Here, you must specify a characteristic type where the characteristic entity is set to Adjustment.</td> </tr> </tbody> </table>	If the attribute is set to...	Then, this field is...	Payment Event Characteristic Type	Used to specify the characteristic type where you can store the payment event ID. This type of characteristic is defined for the reconciliation adjustments. It indicates the payment event whose payment is distributed against the bill segment. Here, you must specify a characteristic type where the characteristic entity is set to Adjustment .	<p>Note: This field is required while setting an attribute in the member reconciliation preference.</p>
	If the attribute is set to...	Then, this field is...				
Payment Event Characteristic Type	Used to specify the characteristic type where you can store the payment event ID. This type of characteristic is defined for the reconciliation adjustments. It indicates the payment event whose payment is distributed against the bill segment. Here, you must specify a characteristic type where the characteristic entity is set to Adjustment .					
<p>Note: The CIPAYEV characteristic type is shipped with the product.</p>						

Field Name	Field Description		Mandatory (Yes or No)
	Pay Instruction Completed Status	Used to specify the status code to which you want to transition the pay instruction when it is fully reconciled. Note: Here, you must specify the status code which is already defined in the lifecycle of the C1-PayInstruction business object.	
	Reconciliation Matching Level Characteristic Type	Used to specify the characteristic type which indicates all pay instructions in the file must be reconciled at the member level. This type of characteristic is defined for the reconciliation when all pay instructions in a file have member data. Here, you must specify a characteristic type where the characteristic entity is set to Member Reconciliation . Note: The C1-MTLVL characteristic type is shipped with the product.	

Field Name	Field Description	Mandatory (Yes or No)				
	<table border="1"> <tr> <td data-bbox="639 254 938 793">Pay Instruction Open Status</td> <td data-bbox="938 254 1182 793"> <p>Used to specify the status code to which you want to transition the pay instruction when it is not fully reconciled.</p> <p>Note: Here, you must specify the status code which is already defined in the lifecycle of the C1-PayInstruction business object.</p> </td> </tr> <tr> <td data-bbox="639 793 938 1367">Reconciliation Open Status</td> <td data-bbox="938 793 1182 1367"> <p>Used to specify the status code to which you want to transition the reconciliation when the status of the pay instruction is changed to Open.</p> <p>Note: Here, you must specify the status code which is already defined in the lifecycle of the C1-MemberReconciliation business object.</p> </td> </tr> </table>	Pay Instruction Open Status	<p>Used to specify the status code to which you want to transition the pay instruction when it is not fully reconciled.</p> <p>Note: Here, you must specify the status code which is already defined in the lifecycle of the C1-PayInstruction business object.</p>	Reconciliation Open Status	<p>Used to specify the status code to which you want to transition the reconciliation when the status of the pay instruction is changed to Open.</p> <p>Note: Here, you must specify the status code which is already defined in the lifecycle of the C1-MemberReconciliation business object.</p>	
Pay Instruction Open Status	<p>Used to specify the status code to which you want to transition the pay instruction when it is not fully reconciled.</p> <p>Note: Here, you must specify the status code which is already defined in the lifecycle of the C1-PayInstruction business object.</p>					
Reconciliation Open Status	<p>Used to specify the status code to which you want to transition the reconciliation when the status of the pay instruction is changed to Open.</p> <p>Note: Here, you must specify the status code which is already defined in the lifecycle of the C1-MemberReconciliation business object.</p>					
Entity Type	<p>Used to indicate the type of entity for which the attribute is applicable. The valid values are:</p> <ul style="list-style-type: none"> • Account • Billable Charge <p>Note: At present, this data is stored for informational purposes only and is not considered in the business logic. If required, you can add more entity types to the MAP_ENTITY_FLG lookup field.</p>	No				

Tip: Alternatively, you can edit the details of a member reconciliation preference by clicking the **Edit** button in the **Field Mapping** zone.

3. Modify the required details in the **Main** section.

- Define, edit, or remove the attribute from the member reconciliation preference, if required.

Note: You must set at least one attribute in a member reconciliation preference.

- Click **Save**.

The changes made to the member reconciliation preference are saved.

Related Topics

For more information on...	See...
How to search for a member reconciliation preference	Searching for a Member Reconciliation Preference on page 2434

Copying a Member Reconciliation Preference

Instead of creating a member reconciliation preference from scratch, you can create a new member reconciliation preference using an existing member reconciliation preference. This is possible through copying a member reconciliation preference. On copying a member reconciliation preference, the details including the attributes are copied to the new member reconciliation preference. You can then edit the details, if required.

Prerequisites

To copy a member reconciliation preference, you should have:

- Member reconciliation preference (whose copy you want to create) defined in the application
- Required characteristic types defined in the application
- Required statuses defined in the lifecycle of the **C1-MemberReconciliation** and **C1-PayInstruction** business objects
- Values defined in the **MAP_ENTITY_FLG** lookup field

Procedure

To copy a member reconciliation preference:

- Search for the member reconciliation preference in the **Field Mapping** screen.
- In the **Search Results** section, click the **Duplicate**  icon in the **Duplicate** column corresponding to the member reconciliation preference whose copy you want to create.

The **Field Mapping** screen appears. It contains the following sections:

- Main** - Used to specify basic details of the member reconciliation preference. It contains the following fields:

Field Name	Field Description	Mandatory (Yes or No)
Preference	Used to specify the member reconciliation preference.	Yes
Description	Used to specify the description for the member reconciliation preference.	Yes
Detailed Description	Used to specify additional information about the member reconciliation preference.	No

Field Name	Field Description	Mandatory (Yes or No)
Status	Used to indicate the status of the member reconciliation preference. The valid values are: <ul style="list-style-type: none"> Active Inactive 	Yes
Preference Category	Indicates the category to which the preference belongs. The valid value is: <ul style="list-style-type: none"> Member Reconciliation 	Not applicable

- **Preference Settings** - Used to set the attributes in the member reconciliation preference. It contains the following fields in a grid:

Field Name	Field Description	Mandatory (Yes or No)
Attribute	Used to indicate the attribute which you want to set in the member reconciliation preference. The valid values are: <ul style="list-style-type: none"> Payment Event Characteristic Type - Used when a pay instruction is reconciled at the member level through the C1-RCPM batch. Pay Instruction Completed Status - Used when a pay instruction is fully reconciled at the member level through the C1-RCPM batch. Reconciliation Matching Level Characteristic Type - Used when reconciliation is created for a pay instruction file where all pay instructions have member data. Pay Instruction Open Status - Used when a pay instruction is not fully reconciled at the member level through the C1-RCPM batch. Reconciliation Open Status - Used when one or more pay instructions of a file are not yet fully reconciled at the member level through the C1-RCPM batch. 	Yes (Conditional)
		Note: This field is required while setting an attribute in the member reconciliation preference.

Field Name	Field Description	Mandatory (Yes or No)				
Value	<p>Used to specify the attribute value. The attribute value that you can specify varies depending on the attribute you want to set in the member reconciliation preference:</p> <table border="1" data-bbox="639 390 1182 1362"> <thead> <tr> <th data-bbox="639 390 930 474">If the attribute is set to...</th> <th data-bbox="930 390 1182 474">Then, this field is...</th> </tr> </thead> <tbody> <tr> <td data-bbox="639 474 930 1362">Payment Event Characteristic Type</td> <td data-bbox="930 474 1182 1362"> <p>Used to specify the characteristic type where you can store the payment event ID. This type of characteristic is defined for the reconciliation adjustments. It indicates the payment event whose payment is distributed against the bill segment. Here, you must specify a characteristic type where the characteristic entity is set to Adjustment.</p> <div data-bbox="935 1167 1177 1346" style="border: 1px solid black; padding: 5px;"> <p>Note: The C1PAYEVT characteristic type is shipped with the product.</p> </div> </td> </tr> </tbody> </table>	If the attribute is set to...	Then, this field is...	Payment Event Characteristic Type	<p>Used to specify the characteristic type where you can store the payment event ID. This type of characteristic is defined for the reconciliation adjustments. It indicates the payment event whose payment is distributed against the bill segment. Here, you must specify a characteristic type where the characteristic entity is set to Adjustment.</p> <div data-bbox="935 1167 1177 1346" style="border: 1px solid black; padding: 5px;"> <p>Note: The C1PAYEVT characteristic type is shipped with the product.</p> </div>	<p>Yes (Conditional)</p> <div data-bbox="1198 296 1472 468" style="border: 1px solid black; padding: 5px;"> <p>Note: This field is required while setting an attribute in the member reconciliation preference.</p> </div>
If the attribute is set to...	Then, this field is...					
Payment Event Characteristic Type	<p>Used to specify the characteristic type where you can store the payment event ID. This type of characteristic is defined for the reconciliation adjustments. It indicates the payment event whose payment is distributed against the bill segment. Here, you must specify a characteristic type where the characteristic entity is set to Adjustment.</p> <div data-bbox="935 1167 1177 1346" style="border: 1px solid black; padding: 5px;"> <p>Note: The C1PAYEVT characteristic type is shipped with the product.</p> </div>					

Field Name	Field Description	Mandatory (Yes or No)				
	<table border="1"> <tr> <td data-bbox="638 254 933 762"> Pay Instruction Completed Status </td> <td data-bbox="933 254 1177 762"> Used to specify the status code to which you want to transition the pay instruction when it is fully reconciled. Note: Here, you must specify the status code which is already defined in the lifecycle of the C1-PayInstruction business object. </td> </tr> <tr> <td data-bbox="638 762 933 1623"> Reconciliation Matching Level Characteristic Type </td> <td data-bbox="933 762 1177 1623"> Used to specify the characteristic type which indicates all pay instructions in the file must be reconciled at the member level. This type of characteristic is defined for the reconciliation when all pay instructions in a file have member data. Here, you must specify a characteristic type where the characteristic entity is set to Member Reconciliation. Note: The C1-MTLVL characteristic type is shipped with the product. </td> </tr> </table>	Pay Instruction Completed Status	Used to specify the status code to which you want to transition the pay instruction when it is fully reconciled. Note: Here, you must specify the status code which is already defined in the lifecycle of the C1-PayInstruction business object.	Reconciliation Matching Level Characteristic Type	Used to specify the characteristic type which indicates all pay instructions in the file must be reconciled at the member level. This type of characteristic is defined for the reconciliation when all pay instructions in a file have member data. Here, you must specify a characteristic type where the characteristic entity is set to Member Reconciliation . Note: The C1-MTLVL characteristic type is shipped with the product.	
Pay Instruction Completed Status	Used to specify the status code to which you want to transition the pay instruction when it is fully reconciled. Note: Here, you must specify the status code which is already defined in the lifecycle of the C1-PayInstruction business object.					
Reconciliation Matching Level Characteristic Type	Used to specify the characteristic type which indicates all pay instructions in the file must be reconciled at the member level. This type of characteristic is defined for the reconciliation when all pay instructions in a file have member data. Here, you must specify a characteristic type where the characteristic entity is set to Member Reconciliation . Note: The C1-MTLVL characteristic type is shipped with the product.					

Field Name	Field Description	Mandatory (Yes or No)				
	<table border="1"> <tr> <td data-bbox="639 254 927 762">Pay Instruction Open Status</td> <td data-bbox="927 254 1175 762"> <p>Used to specify the status code to which you want to transition the pay instruction when it is not fully reconciled.</p> <p>Note: Here, you must specify the status code which is already defined in the lifecycle of the C1-PayInstruction business object.</p> </td> </tr> <tr> <td data-bbox="639 762 927 1335">Reconciliation Open Status</td> <td data-bbox="927 762 1175 1335"> <p>Used to specify the status code to which you want to transition the reconciliation when the status of the pay instruction is changed to Open.</p> <p>Note: Here, you must specify the status code which is already defined in the lifecycle of the C1-MemberReconciliation business object.</p> </td> </tr> </table>	Pay Instruction Open Status	<p>Used to specify the status code to which you want to transition the pay instruction when it is not fully reconciled.</p> <p>Note: Here, you must specify the status code which is already defined in the lifecycle of the C1-PayInstruction business object.</p>	Reconciliation Open Status	<p>Used to specify the status code to which you want to transition the reconciliation when the status of the pay instruction is changed to Open.</p> <p>Note: Here, you must specify the status code which is already defined in the lifecycle of the C1-MemberReconciliation business object.</p>	
Pay Instruction Open Status	<p>Used to specify the status code to which you want to transition the pay instruction when it is not fully reconciled.</p> <p>Note: Here, you must specify the status code which is already defined in the lifecycle of the C1-PayInstruction business object.</p>					
Reconciliation Open Status	<p>Used to specify the status code to which you want to transition the reconciliation when the status of the pay instruction is changed to Open.</p> <p>Note: Here, you must specify the status code which is already defined in the lifecycle of the C1-MemberReconciliation business object.</p>					
Entity Type	<p>Used to indicate the type of entity for which the attribute is applicable. The valid values are:</p> <ul style="list-style-type: none"> • Account • Billable Charge <p>Note: At present, this data is stored for informational purposes only and is not considered in the business logic. If required, you can add more entity types to the MAP_ENTITY_FLG lookup field.</p>	No				

Note: While defining a member reconciliation preference, you must set at least one attribute in the member reconciliation preference.

Tip: Alternatively, you can copy a member reconciliation preference by clicking the **Duplicate** button in the **Field Mapping** zone.

3. Enter the required details in the **Main** section.
4. Define, edit, or remove the attribute from the member reconciliation preference, if required.
5. Click **Save**.

The new member reconciliation preference is defined.

Related Topics

For more information on...	See...
How to search for a member reconciliation preference	Searching for a Member Reconciliation Preference on page 2434

Deleting a Member Reconciliation Preference

Procedure

To delete a member reconciliation preference:

1. Search for the member reconciliation preference in the **Field Mapping** screen.
2. In the **Search Results** section, click the **Delete** (🗑️) icon in the **Delete** column corresponding to the member reconciliation preference that you want to delete.

A message appears confirming whether you want to delete the member reconciliation preference.

Tip: Alternatively, you can delete a member reconciliation preference by clicking the **Delete** button in the **Field Mapping** zone.

3. Click **OK**.

The member reconciliation preference is deleted.

Related Topics

For more information on...	See...
How to search for a member reconciliation preference	Searching for a Member Reconciliation Preference on page 2434

Chapter

34

Self-Funded Pricing

Topics:

- [Prerequisites](#)
- [Approval Workflow for the Self-Funded Pricing Rules](#)
- [Line Item Extendable Lookup](#)
- [Extendable Lookup \(Line Item\)](#)
- [Claim Template Extendable Lookup](#)
- [Extendable Lookup \(Claim Template\)](#)
- [Rate Option Extendable Lookup](#)
- [Extendable Lookup \(Rate Option\)](#)
- [Rate Type Extendable Lookup](#)
- [Extendable Lookup \(Rate Type\)](#)
- [Pricing Group](#)
- [Pricing Rule Type](#)
- [Claim Pricing](#)
- [Specific Stop-Loss \(SSL\) Pricing](#)
- [Aggregate Stop-Loss \(ASL\) Pricing](#)
- [Retention Type Claim Based Pricing](#)
- [Retention Type Enrollment Based Pricing](#)
- [Flat Fee Pricing](#)
- [Ancillary Pricing](#)
- [Discount Pricing](#)
- [Level Funding Pricing](#)

Oracle Revenue Management and Billing introduces a new pricing model for the self-funded health insurance business. In this pricing model, you can define pricing rules using a pricing rule type. You can define the following pricing rule types in ORMB:

- Claim
- Aggregate Stop-Loss
- Specific Stop-Loss
- Retention Type Claim Based
- Retention Type Enrollment

- [*Terminal Liability Reserve \(Run Out\) Level Funding Pricing*](#)
- [*Pricing Rule \(Used for Viewing\)*](#)
- [*Self-Funded Pricing Rule Versioning*](#)

Prerequisites

To setup the self-funded pricing feature, you need to do the following:

- Define values for claim template extendable lookup
- Define values for rate option extendable lookup
- Define values for line item extendable lookup
- Setup the **C1-ASOBLNG** feature configuration
- Define price items for the pricing rules
- Define parameters for the pricing rules
- Associate parameters to the price items for the pricing rules

Related Topics

For more information on...	See...
How to setup the C1-ASOBLNG feature configuration	Setting the C1-ASOBLNG Feature Configuration on page 3421

Approval Workflow for the Self-Funded Pricing Rules

Oracle Revenue Management and Billing enables you to configure the approval workflow process for the claim, specific stop-loss, aggregate stop-loss, retention type claim based, retention type enrollment based, flat fees, ancillary, discount, or level funded pricing rules. The following approval workflow groups are shipped with the product:

Approval Workflow Group	Description
C1PRCRLCLM	Claim Pricing Rule
C1PRCSSL	Specific Stop-Loss Pricing Rule
C1PRCASL	Aggregate Stop-Loss Pricing Rule
C1PRETCLM	Retention Type Claim Based Pricing Rule
C1PRRETENR	Retention Type Enrollment Based Pricing Rule
C1PRFLTTEE	Flat Fees Pricing Rule
C1PRCANC	Ancillary Pricing Rule
C1PRCDA	Discount Arrangement Pricing Rule
C1PRCLVLFN	Level Funded Pricing Rule

To enable the approval workflow process for the pricing rules, you need to do the following:

1. Create the required approval workflow chains, approval workflow criterion types, approval workflow group chain linkages, and approval workflow reasons.

Note: The **Field Level Approval** feature is not supported for the self-funded pricing rules. Therefore, you should not define field approval rule criteria while creating the approval workflow group chain linkage for the above listed approval workflow groups.

2. Define the approval workflow settings for the respective approval workflow group and set the **Active** field to **Yes**.

3. Ensure that the following value is set in the respective option type of the **C1-ASOBLNG** feature configuration:

Option Type	Value
Approval Workflow Group for Claim	C1PRCRLCLM
Approval Workflow Group for SSL	C1PRCSSL
Approval Workflow Group for ASL	C1PRCASL
Approval Workflow Group for Retention Type Claim Based	C1PRETCLM
Approval Workflow Group for Retention Type Enrollment Based	C1PRRETENR
Approval Workflow Group for Flat Fees	C1PRFLTFFEE
Approval Workflow Group for Ancillary	C1PRCANC
Approval Workflow Group for Discount Arrangement	C1PRCDA
Approval Workflow Group for Level Funded	C1PRCLVLFN

Once the approval workflow process is enabled for the pricing rules of a particular category (for example, Claim), the system creates an approval transaction whenever you define, edit, or delete a pricing rule of the respective category (i.e. whenever you define, edit, or delete a claim pricing rule). You can view the approval transactions which are created while defining, editing, and deleting the parent customer's and bill groups' pricing rules in the **Pricing Rule Approval Transactions** zone of the **Customer 360° Information** screen. On clicking the link in the **Approval Transaction ID** column corresponding to an approval transaction, the **Comparison: New versus Existing** screen appears. It allows the approver to review the pricing rule and accordingly approve, reject, or cancel the approval transaction.

Tip: Alternatively, you can review the approval transaction and take appropriate action from the **Approval Transaction** screen.

Related Topics

For more information on...	See...
How to setup the C1-ASOBLNG feature configuration	Setting the C1-ASOBLNG Feature Configuration on page 3421

Line Item Extendable Lookup

Different charges, such as consumer-driven amount, traditional health insurance amount, network access fees, and so on are received as part of the claim transaction. These charges which contribute to the total claim amount are defined as the line items in the system. Each line item must be defined in the system using the **Line Item (C1-ExtLookPricingRuleLineItem)** extendable lookup. A line item encapsulates the following information:

- Service Quantity Identifier (SQI) which indicates the transaction field in which the charge amount is stored. It is also used while calculating the percentage based markup or markdown for the charge.
- Billable charge line type using which you want to create the calculation line for the charge.
- Whether the system should write off the charge when it is not eligible for billing.
- Billable charge line type using which you want to create the write off calculation line for the charge.
- Whether the charge should be considered while calculating the percentage based retention type claim based fee.
- The pricing rule type categories to which the charge is associated.

For example, you can create a line item for the following charges:

Charge	Line Item	Write Off, If Not Eligible for Billing	Pricing Rule Type Category
Consumer-Driven Amount	CDH	Yes	Claim
			Specific Stop-Loss
			Aggregate Stop-Loss
			Ancillary
Traditional Health Insurance Amount	THC	Yes	Claim
			Specific Stop-Loss
			Aggregate Stop-Loss
Preventive Care Charges	PCC	No	Ancillary

The CDH and THC line items can be included in a claim template. They can also be considered while calculating specific and aggregate stop-loss. The CDH and PCC line items can be considered while defining pricing arrangements in an ancillary pricing rule type. In addition, any charge received for the CDH and THC line items in a claim transaction will be written off when these line items are not eligible for billing.

The **C1-ExtLookPricingRuleLineItem** extendable lookup is redesigned to:

- Specify a billable charge line type using which the calculation line should be created for a rate type when the system calculates the fees separately for each applicable claim charge
- Specify a billable charge line type using which the calculation line should be created for a rate type when the system calculates the minimum and maximum markup or markdown separately for each eligible claim charge
- Specify a billable charge line type using which the calculation line should be created for a rate type when the system calculates the minimum and maximum amount for a line item

Once you derive the pricing information from a claim pricing rule in a specific stop-loss pricing rule, you need to specify whether the additional fee (if any) is eligible for specific stop-loss. If so, it is considered for calculating specific stop-loss.

Once you derive the pricing information from a claim pricing rule in an aggregate stop-loss pricing rule, you need to specify whether the additional fee (if any) is eligible for aggregate stop-loss. If so, it is considered for calculating aggregate stop-loss.

Once you derive the pricing information from a claim pricing rule in a level-funded pricing rule, you need to specify whether the additional fee (if any) should be settled through level funding. If so, it is considered while accumulating level funded charges.

Until now, when the **Include In Settlement** column was selected corresponding to a line item in a level funded pricing rule, the system settled the charge as well as its markup or markdown through level funding. However, now, the system provides two different options – one which helps to determine whether the charge should be settled through level funding and another which helps to determine whether the corresponding markup or markdown should be settled through level funding.

The **Extendable Lookup Query** screen allows you to search for an extendable lookup. It contains the following zone:

- [Extendable Lookup Search](#) on page 2457

Extendable Lookup Search

The **Extendable Lookup Search** zone allows you to search for an extendable lookup. It contains the following two sections:

- **Search Criteria** – The **Search Criteria** section contains the following fields:

Field Name	Field Description	Mandatory (Yes or No)
Business Object	Used to search a particular extendable lookup business object.	No
Description	Used to search extendable lookups with a particular description.	No

Note: You must specify at least one search criterion while searching for an extendable lookup.

- **Search Results** – On clicking the **Search** button, the search results appear based on the specified search criteria. The **Search Results** section contains the following columns:

Column Name	Column Description
Business Object	Displays the extendable lookup business object.
Description	Displays the description of the extendable lookup business object.
	Note: It has a link. On clicking the link, the Extendable Lookup screen appears where you can view the details of the respective extendable lookup.

Related Topics

For more information on...	See...
How to search for the Line Item extendable lookup	Searching for the Line Item Extendable Lookup on page 2458
How to view the values of the Line Item extendable lookup	Viewing the Values of the Line Item Extendable Lookup on page 2459

Searching for the Line Item Extendable Lookup

Procedure

To search for the **Line Item** extendable lookup:

1. Click the **Admin** link in the **Application** toolbar.
A list appears.
2. From the **Admin** menu, select **E** and then click **Extendable Lookup**.
The **Extendable Lookup Query** screen appears.
3. In the **Extendable Lookup Search** zone, enter **C1-ExtLookPricingRuleLineItem** in the **Business Object** field.

Note: ORMB search engine supports wildcard search, where you can substitute the percentage (%) symbol as a stand in for any word or letter in a search criteria. You can use the ‘%’ wildcard character in all input fields except the date and ID fields. The ‘%’ wildcard character is suffixed automatically at the end of the partial search criteria. Therefore, you may or may not specify the wildcard character at the end of the partial search criteria. However, you have to prefix the wildcard character manually wherever required.

4. Click **Search**.

The **Line Item** extendable lookup business object appears in the **Search Results** section.

Related Topics

For more information on...	See...
Extendable Lookup Query screen	Line Item Extendable Lookup on page 2456
Extendable Lookup Search zone	Extendable Lookup Search on page 2457

Viewing the Values of the Line Item Extendable Lookup

Procedure

To view the values of the **Line Item** extendable lookup:

1. Search for the **Line Item** extendable lookup in the **Extendable Lookup Query** screen.
2. In the **Search Results** section, click the link in the **Description** column corresponding to the extendable lookup business object whose details you want to view. The **Extendable Lookup** screen appears.
3. View the values of the **Line Item** extendable lookup in the **Extendable Lookup Value List** zone.

Related Topics

For more information on...	See...
How to search for the Line Item extendable lookup	Searching for the Line Item Extendable Lookup on page 2458
Extendable Lookup screen	Extendable Lookup (Line Item) on page 2459
Extendable Lookup Value List zone	Extendable Lookup Value List on page 2459

Extendable Lookup (Line Item)



The **Extendable Lookup** screen allows you to view the values of the **Line Item (C1-ExtLookPricingRuleLineItem)** extendable lookup. It also allows you to define, edit, copy, and delete a line item. It contains the following zones:

- [Extendable Lookup Value List](#) on page 2459
- [Extendable Lookup Value](#) on page 2460

Extendable Lookup Value List

The **Extendable Lookup Value List** zone lists the values which are already defined for the **Line Item** extendable lookup. It contains the following columns:

Column Name	Column Description
Value	Displays the line item.
Description	Displays the description of the line item.
Owner	Indicates who has created the line item. The valid values are: <ul style="list-style-type: none"> • Base • Customer Modification • Framework
Edit	On clicking the Edit  icon, the Line Item screen appears where you can edit the details of the line item.

Column Name	Column Description
Duplicate	On clicking the Duplicate () icon, the Line Item screen appears where you can define a new line item using an existing line item.
Delete	On clicking the Delete () icon, you can delete the line item.
	Note: You can delete a line item when it is not yet used in the claim template or while defining the self-funded pricing.
Detailed Description	Displays additional information about the line item.

Note: Pagination is used to display limited number of records in this zone. You can use the navigation buttons, such as **Previous** and **Next** to navigate between pages.

On clicking the **Broadcast** () icon corresponding to a line item, the **Extendable Lookup Value** zone appears with the details of the respective line item.

You can filter the list using various search criteria (such as, **Value** and **Description**) available in the **Filter** area. By default, the **Filter** area is hidden. You can view the **Filter** area by clicking the **Filters** () icon in the upper right corner of this zone.

Related Topics

For more information on...	See...
How to edit a line item	Editing a Line Item on page 2471
How to copy a line item	Copying a Line Item on page 2473
How to delete a line item	Deleting a Line Item on page 2476
How to view the details of a line item	Viewing the Line Item Details on page 2476

Extendable Lookup Value

The **Extendable Lookup Value** zone displays the details of the line item. It contains the following sections:

- **Main** – Displays basic information about the line item. It contains the following fields:

Field Name	Field Description
Line Item	Indicates the charge for which the line item is created.
Description	Displays the description of the line item.
Override Description	Displays the overridden description of the line item.
Detailed Description	Displays additional information about the line item.
Status	Indicates the status of the line item. The valid values are: <ul style="list-style-type: none"> • Active • Inactive
Service Quantity Identifier	Indicates the service quantity identifier associated with the line item.
Billable Charge Line Type	Indicates the billable charge line type using which the calculation line is created for the charge (i.e. line item).

Field Name	Field Description
Write Off Billable Charge Line Type	Indicates the billable charge line type using which the write off calculation line is created for the charge (i.e. line item).
Write Off, if Not Eligible for Billing	Indicates whether the system should write off the charge (i.e. line item) when it is not eligible for billing. The valid values are: <ul style="list-style-type: none"> • Yes • No
Retention Claim Based Percentage Calculation	Indicates whether the charge (i.e. line item) should be considered while calculating the percentage based retention type claim based fee. The valid values are: <ul style="list-style-type: none"> • Yes • No

- **Line Item Usage** – Indicates the pricing rule type categories to which the line item is associated. It contains the following column in a grid:

Column Name	Column Description
Pricing Rule Type Category	Indicates the pricing rule type category which is associated with the charge (i.e. line item). The valid values are: <ul style="list-style-type: none"> • Aggregate Stop-Loss • Ancillary • Claim • Retention Type Claim Based • Specific Stop-Loss

- **Markup or Markdown Billing Information** – Indicates the markup or markdown billing information defined for the line items. It contains the following columns in a grid:

Column Name	Column Description
Rate Type	Indicates the minimum and maximum markup or markdown billing information defined using the rate type.
Billable Charge Line Type	Indicates the billable charge line type using which the calculation line is created for a rate type when the system calculates the minimum and maximum markup or markdown separately for each eligible claim charge.

- **Line Item Billing Information** – Indicates the rate type and billable charge line type to which the line item is associated. It contains the following columns in a grid:

Column Name	Column Description
Rate Type	Indicates the rate type defined for the line item.
Billable Charge Line Type	Indicates the billable charge line type billable charge line type using which the calculation line is created for a rate type when the system calculates the minimum and maximum amount for a line item.

- **Claim Handling Fees Billing Information** – Indicates the claim handling fees billing information. It contains the following columns in a grid:

Column Name	Column Description						
Fee Type	Indicates the type of charge applicable on the line items.						
Fee	Indicates the fee defined for the line items.						
Rate	Indicates the rate and billable charge line type defined for the line items. <table border="1" data-bbox="565 363 1471 611"> <thead> <tr> <th>Column Name</th> <th>Column Description</th> </tr> </thead> <tbody> <tr> <td>Rate Type</td> <td>Indicates the rate type defined for a line item.</td> </tr> <tr> <td>Billable Charge Line Type</td> <td>Indicates the billable charge line type using which the calculation line is created for a rate type when the system calculates the fees separately for each applicable claim charge.</td> </tr> </tbody> </table>	Column Name	Column Description	Rate Type	Indicates the rate type defined for a line item.	Billable Charge Line Type	Indicates the billable charge line type using which the calculation line is created for a rate type when the system calculates the fees separately for each applicable claim charge.
Column Name	Column Description						
Rate Type	Indicates the rate type defined for a line item.						
Billable Charge Line Type	Indicates the billable charge line type using which the calculation line is created for a rate type when the system calculates the fees separately for each applicable claim charge.						

- **Record Actions** – This section contains the following buttons:

Button Name	Button Description
Edit	Used to edit the details of the line item.
Delete	Used to delete the line item. Note: You can delete a line item when it is not yet used in the claim template or while defining the self-funded pricing.
Duplicate	Used to create a new line item using an existing line item.

- **Record Information** – This section contains the following fields:

Field Name	Field Description
Business Object	Indicates the extendable lookup business object using which the line item is created. In addition, a context menu appears corresponding to this field which helps in navigating to other screens in the application. Note: It has a link. On clicking the link, the Business Object screen appears where you can view the details of the respective business object.
Owner	Indicates who has created the line item. The valid values are: <ul style="list-style-type: none"> • Framework • Base • Customer Modification

By default, the **Extendable Lookup Value** zone does not appear in the **Extendable Lookup** screen. It appears when you click the **Broadcast** (📡) icon corresponding to the line item in the **Extendable Lookup Value List** zone.

Related Topics

For more information on...	See...
How to edit a line item	Editing a Line Item on page 2471
How to copy a line item	Copying a Line Item on page 2473
How to delete a line item	Deleting a Line Item on page 2476

For more information on...	See...
How to view the details of a line item	Viewing the Line Item Details on page 2476

Defining a Line Item

Prerequisites

To define a line item, you should have:

- Service quantity identifiers and billable charge line types defined in the application

Procedure

To define a line item:

1. Search for the **Line Item** extendable lookup in the **Extendable Lookup Query** screen.
2. In the **Search Results** section, click the link in the **Description** column corresponding to the extendable lookup business object whose details you want to view.

The **Extendable Lookup** screen appears.

3. Click the **Add** button in the **Page Title** area of the **Extendable Lookup** screen.

The **Line Item** screen appears. It contains the following sections:

- **Main** – Used to specify basic details about the line item.
- **Line Item Usage** – Used to associate the line item with one or more pricing rule type categories.
- **Markup or Markdown Billing Information** – Used to define the markup or markdown billing information for the line items.
- **Line Item Billing Information** – Used to define line item billing information for the line items.
- **Claim Handling Fees Billing Information** – Used to define the claim handling fees billing information for the line items.

The **Main** section contains the following fields:

Field Name	Field Description	Mandatory (Yes or No)
Line Item	Used to specify the charge (for example, consumer-driven amount, traditional health insurance amount, and so on) for which the line item is created.	Yes
Description	Used to specify the description for the line item.	Yes
Override Description	Used when you want to override the description of the line item.	No
Detailed Description	Used to specify additional information about the line item.	No
Status	Used to indicate the status of the line item. The valid values are: <ul style="list-style-type: none"> • Active • Inactive 	No
	Note: By default, the value is set to Active .	

Field Name	Field Description	Mandatory (Yes or No)
Service Quantity Identifier	Used to indicate the service quantity identifier (SQI) for the line item. The SQI indicates the transaction field in which the charge amount is stored. It is also used while calculating the percentage based markup or markdown for the line item.	Yes
Billable Charge Line Type	Used to indicate the billable charge line type using which you want to create the calculation line for the charge (i.e. line item). Note: The Search (🔍) icon appears corresponding to the Billable Charge Line Type Search field. On clicking the Search icon, the Billable Charge Line Type Search window appears. On specifying the billable charge line type, the description of the billable charge line type appears corresponding to the Billable Charge Line Type field.	No
Write Off Billable Charge Line Type	Used to indicate the billable charge line type using which you want to create the write off calculation line for the charge (i.e. line item). Note: The Search (🔍) icon appears corresponding to the Write Off Billable Charge Line Type field. On clicking the Search icon, the Billable Charge Line Type Search window appears. On specifying the billable charge line type, the description of the billable charge line type appears corresponding to the Write Off Billable Charge Line Type field.	Yes (Conditional) Note: This field is required when the Write Off, if Not Eligible for Billing field is set to Yes .
Write Off, if Not Eligible for Billing	Used to indicate whether the system should write off the charge (i.e. line item) when it is not eligible for billing. The valid values are: <ul style="list-style-type: none">• Yes• No Note: By default, the value is set to No .	No
Retention Claim Based Percentage Calculation	Used to indicate whether the charge (i.e. line item) should be considered while calculating the percentage based retention type claim based fee. The valid values are: <ul style="list-style-type: none">• Yes• No Note: By default, the value is set to No .	No

4. Enter the required details in the **Main** section.

5. Associate the line item with one or more pricing rule type categories.
6. Define the markup or markdown billing information for the line items.
7. Define line item billing information for the line items.
8. Define the claim handling fees billing information for the line items.
9. Click **Save**.

The line item is added in the **C1-ExtLookPricingRuleLineItem** extendable lookup.

Related Topics

For more information on...	See...
How to search for the Line Item extendable lookup	Searching for the Line Item Extendable Lookup on page 2458
Extendable Lookup screen	Extendable Lookup (Line Item) on page 2459
How to associate a line item with a pricing rule type category	Associating a Line Item with a Pricing Rule Type Category on page 2465
How to define the markup or markdown billing information for the line item	Defining the Markup or Markdown Billing Information for the Line Items on page 2467
How to define line item billing information for the line item	Defining Line Item Billing Information for the Line Items on page 2468
How to define the claim handling fees billing information for the line item	Defining the Claim Handling Fees Billing Information for the Line Items on page 2469

Associating a Line Item with a Pricing Rule Type Category

Procedure

To associate a line item with a pricing rule type category:

1. Ensure that the **Line Item Usage** section is expanded when you are defining, editing, or copying a line item.

The **Line Item Usage** section contains the following field in a grid:

Field Name	Field Description	Mandatory (Yes or No)												
Pricing Rule Type Category	<p>Used to indicate the pricing rule type category which you want to associate with the charge (i.e. line item). The valid values are:</p> <ul style="list-style-type: none"> Aggregate Stop-Loss Ancillary Claim Retention Type Claim Based Specific Stop-Loss <p>The following table describes the significance of each category that can be associated with the line item:</p> <table border="1"> <thead> <tr> <th>Pricing Rule Type Category</th> <th>Significance</th> </tr> </thead> <tbody> <tr> <td>Claim</td> <td>Whether the line item can be included in a claim template and thereby while defining a claim pricing rule for a parent customer and bill group.</td> </tr> <tr> <td>Specific Stop-Loss</td> <td>Whether the line item can be considered while calculating specific stop-loss.</td> </tr> <tr> <td>Aggregate Stop-Loss</td> <td>Whether the line item can be considered while calculating aggregate stop-loss.</td> </tr> <tr> <td>Retention Type Claim Based</td> <td>Whether the line item can be used while calculating the percentage based retention type claim based fee.</td> </tr> <tr> <td>Ancillary</td> <td>Whether the line item can be considered while defining pricing arrangements in an ancillary pricing rule type.</td> </tr> </tbody> </table> <p>Note: At present, the line items are not used in the pricing rule types where the pricing rule type category is set to Retention Type Enrollment Based and Flat Fees.</p>	Pricing Rule Type Category	Significance	Claim	Whether the line item can be included in a claim template and thereby while defining a claim pricing rule for a parent customer and bill group.	Specific Stop-Loss	Whether the line item can be considered while calculating specific stop-loss.	Aggregate Stop-Loss	Whether the line item can be considered while calculating aggregate stop-loss.	Retention Type Claim Based	Whether the line item can be used while calculating the percentage based retention type claim based fee.	Ancillary	Whether the line item can be considered while defining pricing arrangements in an ancillary pricing rule type.	<p>Yes (Conditional)</p> <p>Note: This field is required when you are associating the line item with a pricing rule type category.</p>
Pricing Rule Type Category	Significance													
Claim	Whether the line item can be included in a claim template and thereby while defining a claim pricing rule for a parent customer and bill group.													
Specific Stop-Loss	Whether the line item can be considered while calculating specific stop-loss.													
Aggregate Stop-Loss	Whether the line item can be considered while calculating aggregate stop-loss.													
Retention Type Claim Based	Whether the line item can be used while calculating the percentage based retention type claim based fee.													
Ancillary	Whether the line item can be considered while defining pricing arrangements in an ancillary pricing rule type.													

- Enter the required details in the **Line Item Usage** section.
- If you want to associate the line item with more than one pricing rule type category, click the **Add (+)** icon and then repeat step 3.

Note: However, if you want to remove a pricing rule type category from the line item, click the **Delete (🗑)** icon corresponding to the pricing rule type category.

- Click **Save**.

The line item is associated with the pricing rule type category.

Related Topics

For more information on...	See...
How to define a line item	Defining a Line Item on page 2463
How to edit a line item	Editing a Line Item on page 2471
How to copy a line item	Copying a Line Item on page 2473

Defining the Markup or Markdown Billing Information for the Line Items**Procedure**

To define the markup or markdown billing information for the line items:

1. Ensure that the **Markup or Markdown Billing Information** section is expanded when you are defining, editing, or copying a line item.

The **Markup or Markdown Billing Information** section contains the following fields:

Field Name	Field Description	Mandatory (Yes or No)
Rate Type	Used to indicate the rate type.	Yes (Conditional) Note: This field is required when you select a billable charge line type from the Billable Charge Line Type field.
Billable Charge Line Type	Used to specify the billable charge line type. Note: On clicking the Search (🔍) icon, the Billable Charge Line Type Search window appears. On specifying the billable charge line type, the description of the billable charge line type appears corresponding to the Billable Charge Line Type field.	Yes (Conditional) Note: This field is required when you select an option from the Rate Type field.

2. Enter the required details in the **Markup or Markdown Billing Information** section.
3. If you want to add more than one markup or markdown billing information for the line item, click the **Add** (+) icon and then repeat step 2.

Note: However, if you want to remove a markup or markdown billing information from the line item, click the **Delete** (🗑️) icon corresponding to the line item.

4. Click **Save**.

The markup or markdown billing information is defined for the line items.

Related Topics

For more information on...	See...
How to define a line item	Defining a Line Item on page 2463

For more information on...	See...
How to edit a line item	Copying a Line Item on page 2473
How to copy a line item	Editing a Line Item on page 2471

Defining Line Item Billing Information for the Line Items

Procedure

To define the line item billing information for the line items:

1. Ensure that the **Line Item Billing Information** section is expanded when you are defining, editing, or copying a line item.

The **Line Item Billing Information** section contains the following fields:

Field Name	Field Description	Mandatory (Yes or No)
Rate Type	Used to indicate the rate type.	Yes (Conditional) Note: This field is required when you select a billable charge line type from the Billable Charge Line Type field.
Billable Charge Line Type	Used to specify the billable charge line type. Note: On clicking the Search (🔍) icon, the Billable Charge Line Type Search window appears. On specifying the billable charge line type, the description of the billable charge line type appears corresponding to the Billable Charge Line Type field.	Yes (Conditional) Note: This field is required when you select an option from the Rate Type field.

2. Enter the required details in the **Line Item Billing Information** section.
3. If you want to add more than one line item billing information for the line item, click the **Add** (+) icon and then repeat step 2.

Note: However, if you want to remove a line item billing information from the line item, click the **Delete** (🗑️) icon corresponding to the line item.

4. Click **Save**.

The line item billing information is defined for the line items.

Related Topics

For more information on...	See...
How to define a line item	Defining a Line Item on page 2463
How to edit a line item	Copying a Line Item on page 2473
How to copy a line item	Editing a Line Item on page 2471

Defining the Claim Handling Fees Billing Information for the Line Items

Procedure

To define the claim handling fees billing information for the line items:

1. Ensure that the **Claim Handling Fees Billing Information** section is expanded when you are defining, editing, or copying a line item.

The **Claim Handling Fees Billing Information** section contains the following fields:

Field Name	Field Description	Mandatory (Yes or No)
Fee Type	Used to indicate the type of charge applicable on the line items.	Yes (Conditional) Note: This field is required when fee is selected from the Fee field.
Fee	Used to indicate the fee defined for the line items.	Yes (Conditional) Note: This field is required when fee type is selected from the Fee Type field.

Field Name	Field Description	Mandatory (Yes or No)									
Rate	Used to indicate the rate and billable charge line type for the line items.	Yes									
	<table border="1"> <thead> <tr> <th>Field Name</th> <th>Field Description</th> <th>Mandatory (Yes or No)</th> </tr> </thead> <tbody> <tr> <td>Rate Type</td> <td>Used to indicate the rate type.</td> <td>Yes (Conditional)</td> </tr> <tr> <td colspan="2"> <p>Note: This field is required when you select a billable charge line type from the Billable Charge Line Type field.</p> </td> <td></td> </tr> </tbody> </table>	Field Name	Field Description	Mandatory (Yes or No)	Rate Type	Used to indicate the rate type.	Yes (Conditional)	<p>Note: This field is required when you select a billable charge line type from the Billable Charge Line Type field.</p>			
	Field Name	Field Description	Mandatory (Yes or No)								
Rate Type	Used to indicate the rate type.	Yes (Conditional)									
<p>Note: This field is required when you select a billable charge line type from the Billable Charge Line Type field.</p>											
Billable Charge Line Type	<p>Used to specify the billable charge line type.</p> <p>Note: On clicking the Search (🔍) icon, the Billable Charge Line Type Search window appears. On specifying the billable charge line type, the description of the billable charge line type appears corresponding to the Billable Charge Line Type field.</p>	<p>Yes (Conditional)</p> <p>Note: This field is required when you select an option from the Rate Type field.</p>									

- Enter the required details in the **Claim Handling Fees Billing Information** section.
- If you want to add more than one claim handling fee billing information for the line item, click the **Add** (+) icon and then repeat step 2.

Note: However, if you want to remove a claim handling fee billing information from the line item, click the **Delete** (🗑️) icon corresponding to the line item.

- If you want to add more than one rate for the line item, click the **Add** (+) icon and then repeat step 2.

Note: However, if you want to remove a rate from the line item, click the **Delete** (🗑️) icon corresponding to the line item.

- Click **Save**.

The claim handling fees billing information is defined for the line items.

Related Topics

For more information on...	See...
How to define a line item	Defining a Line Item on page 2463

For more information on...	See...
How to edit a line item	Copying a Line Item on page 2473
How to copy a line item	Editing a Line Item on page 2471

Editing a Line Item

Prerequisites

To edit a line item, you should have:

- Service quantity identifiers and billable charge line types defined in the application

Procedure

To edit a line item:

1. Search for the **Line Item** extendable lookup in the **Extendable Lookup Query** screen.
2. In the **Search Results** section, click the link in the **Description** column corresponding to the extendable lookup business object whose details you want to view.

The **Extendable Lookup** screen appears.

3. In the **Extendable Lookup Value List** zone, click the **Edit**  icon in the **Edit** column corresponding to the line item whose details you want to edit.

The **Line Item** screen appears. It contains the following sections:

- **Main** – Used to specify basic details about the line item.
- **Line Item Usage** – Used to associate the line item with one or more pricing rule type categories.
- **Markup or Markdown Billing Information** – Used to define the markup and markdown billing information for the line item.
- **Line Item Billing Information** – Used to define the line item billing information for the line item.
- **Claim Handling Fees Billing Information** – Used to define the claim handling fees billing information for the line item.

The **Main** section contains the following fields:

Field Name	Field Description	Mandatory (Yes or No)
Line Item	Indicates the charge (for example, consumer-driven amount, traditional health insurance amount, and so on) for which the line item is created.	Not applicable
Description	Used to specify the description for the line item.	Yes
Override Description	Used when you want to override the description of the line item.	No
Detailed Description	Used to specify additional information about the line item.	No
Status	Used to indicate the status of the line item. The valid values are: <ul style="list-style-type: none"> • Active • Inactive 	Yes
Service Quantity Identifier	Used to indicate the service quantity identifier (SQI) for the line item. The SQI indicates the transaction field in which the charge amount is stored. It is also used while calculating the percentage based markup or markdown for the line item.	Yes

Field Name	Field Description	Mandatory (Yes or No)
Billable Charge Line Type	Used to indicate the billable charge line type using which you want to create the calculation line for the charge (i.e. line item). Note: The Search (🔍) icon appears corresponding to the Billable Charge Line Type Search field. On clicking the Search icon, the Billable Charge Line Type Search window appears. On specifying the billable charge line type, the description of the billable charge line type appears corresponding to the Billable Charge Line Type field.	Yes
Write Off Billable Charge Line Type	Used to indicate the billable charge line type using which you want to create the write off calculation line for the charge (i.e. line item). Note: The Search (🔍) icon appears corresponding to the Write Off Billable Charge Line Type field. On clicking the Search icon, the Billable Charge Line Type Search window appears. On specifying the billable charge line type, the description of the billable charge line type appears corresponding to the Write Off Billable Charge Line Type field.	Yes (Conditional) Note: This field is required when the Write Off, if Not Eligible for Billing field is set to Yes .
Write Off, if Not Eligible for Billing	Used to indicate whether the system should write off the charge (i.e. line item) when it is not eligible for billing. The valid values are: <ul style="list-style-type: none"> • Yes • No 	No
Retention Claim Based Percentage Calculation	Used to indicate whether the charge (i.e. line item) should be considered while calculating the percentage based retention type claim based fee. The valid values are: <ul style="list-style-type: none"> • Yes • No 	No

Tip: Alternatively, you can edit the details of a line item by clicking the **Edit** button in the **Extendable Lookup Value** zone.

4. Modify the required details in the **Main** section.
5. Associate or remove a pricing rule type category from the line item, if required.
6. Modify the markup or markdown billing information for the line items, if required.
7. Add, edit, or remove the line item billing information for the line items, if required.
8. Add, edit, or remove the claim handling fees billing information for the line items, if required.
9. Click **Save**.

The changes made to the line item are saved.

Related Topics

For more information on...	See...
How to search for the Line Item extendable lookup	Searching for the Line Item Extendable Lookup on page 2458
Extendable Lookup screen	Extendable Lookup (Line Item) on page 2459
Extendable Lookup Value List zone	Extendable Lookup Value List on page 2459
Extendable Lookup Value zone	Extendable Lookup Value on page 2460
How to associate a line item with a pricing rule type category	Associating a Line Item with a Pricing Rule Type Category on page 2465
How to define the markup or markdown billing information for the line item	Defining the Markup or Markdown Billing Information for the Line Items on page 2467
How to define the line item billing information for the line item	Defining Line Item Billing Information for the Line Items on page 2468
How to define the claim handling fees billing information for the line item	Defining the Claim Handling Fees Billing Information for the Line Items on page 2469

Copying a Line Item

Instead of creating a line item from scratch, you can create a new line item using an existing line item. This is possible through copying a line item. On copying a line item, the details including the pricing rule type categories to which the line item is associated are copied to the new line item. You can then edit the details, if required.

Prerequisites

To copy a line item, you should have:

- Line item (whose copy you want to create) defined in the application
- Service quantity identifiers and billable charge line types defined in the application

Procedure

To copy a line item:

1. Search for the **Line Item** extendable lookup in the **Extendable Lookup Query** screen.
2. In the **Search Results** section, click the link in the **Description** column corresponding to the extendable lookup business object whose details you want to view.

The **Extendable Lookup** screen appears.

3. In the **Extendable Lookup Value List** zone, click the **Duplicate** (📄) icon in the **Duplicate** column corresponding to the line item whose copy you want to create.

The **Line Item** screen appears. It contains the following sections:

- **Main** – Used to specify basic details about the line item.
- **Line Item Usage** – Used to associate the line item with one or more pricing rule type categories.
- **Markup or Markdown Billing Information** – Used to define the markup or markdown billing information for the line item.
- **Line Item Billing Information** – Used to define the line item billing information for the line item.

- **Claim Handling Fees Billing Information** – Used to define the claim handling fees billing information for the line item.

The **Main** section contains the following fields:

Field Name	Field Description	Mandatory (Yes or No)	
Line Item	Used to specify the charge (for example, consumer-driven amount, traditional health insurance amount, and so on) for which the line item is created.	Yes	
Description	Used to specify the description for the line item.	Yes	
Override Description	Used when you want to override the description of the line item.	No	
Detailed Description	Used to specify additional information about the line item.	No	
Status	Used to indicate the status of the line item. The valid values are: <ul style="list-style-type: none"> • Active • Inactive 	Yes	
Service Identifier	Quantity	Used to indicate the service quantity identifier (SQI) for the line item. The SQI indicates the transaction field in which the charge amount is stored. It is also used while calculating the percentage based markup or markdown for the line item.	Yes
Billable Charge Line Type	Used to indicate the billable charge line type using which you want to create the calculation line for the charge (i.e. line item). <div style="border: 1px solid black; padding: 5px; margin-top: 10px;"> <p>Note:</p> <p>The Search (🔍) icon appears corresponding to the Billable Charge Line Type Search field. On clicking the Search icon, the Billable Charge Line Type Search window appears.</p> <p>On specifying the billable charge line type, the description of the billable charge line type appears corresponding to the Billable Charge Line Type field.</p> </div>	Yes	

Field Name	Field Description	Mandatory (Yes or No)
Write Off Billable Charge Line Type	Used to indicate the billable charge line type using which you want to create the write off calculation line for the charge (i.e. line item).	Yes (Conditional)
	<p>Note:</p> <p>The Search (🔍) icon appears corresponding to the Write Off Billable Charge Line Type field. On clicking the Search icon, the Billable Charge Line Type Search window appears.</p> <p>On specifying the billable charge line type, the description of the billable charge line type appears corresponding to the Write Off Billable Charge Line Type field.</p>	<p>Note: This field is required when the Write Off, if Not Eligible for Billing field is set to Yes.</p>
Write Off, if Not Eligible for Billing	Used to indicate whether the system should write off the charge (i.e. line item) when it is not eligible for billing. The valid values are: <ul style="list-style-type: none"> • Yes • No 	No
Retention Claim Based Percentage Calculation	Used to indicate whether the charge (i.e. line item) should be considered while calculating the percentage based retention type claim based fee. The valid values are: <ul style="list-style-type: none"> • Yes • No 	No

Tip: Alternatively, you can copy a line item by clicking the **Duplicate** button in the **Extendable Lookup Value** zone.

4. Enter the required details in the **Main** section.
5. Associate or remove a pricing rule type category from the line item, if required.
6. Modify the markup or markdown billing information for the line items, if required.
7. Add, edit, or remove the line item billing information for the line items, if required.
8. Add, edit, or remove the claim handling fees billing information for the line items, if required.
9. Click **Save**.

The new line item is added in the **C1-ExtLookPricingRuleLineItem** extendable lookup.

Related Topics

For more information on...	See...
How to search for the Line Item extendable lookup	Searching for the Line Item Extendable Lookup on page 2458
Extendable Lookup screen	Extendable Lookup (Line Item) on page 2459
Extendable Lookup Value List zone	Extendable Lookup Value List on page 2459
Extendable Lookup Value zone	Extendable Lookup Value on page 2460

For more information on...	See...
How to associate a line item with a pricing rule type category	Associating a Line Item with a Pricing Rule Type Category on page 2465
How to define the markup or markdown billing information for the line item	Defining the Markup or Markdown Billing Information for the Line Items on page 2467
How to define line item billing information for the line item	Defining Line Item Billing Information for the Line Items on page 2468
How to define the claim handling fees billing information for the line item	Defining the Claim Handling Fees Billing Information for the Line Items on page 2469

Deleting a Line Item

Procedure

To delete a line item:

1. Search for the **Line Item** extendable lookup in the **Extendable Lookup Query** screen.
2. In the **Search Results** section, click the link in the **Description** column corresponding to the extendable lookup business object whose details you want to view.

The **Extendable Lookup** screen appears.

3. In the **Extendable Lookup Value List** zone, click the **Delete** (🗑️) icon in the **Delete** column corresponding to the line item that you want to delete.

A message appears confirming whether you want to delete the line item.

Note: You can delete a line item when it is not yet used in the claim template or while defining the Administrative Services Only (ASO) pricing.

Tip: Alternatively, you can delete a line item by clicking the **Delete** button in the **Extendable Lookup Value** zone.

4. Click **OK**.

The line item is deleted from the **C1-ExtLookPricingRuleLineItem** extendable lookup.

Related Topics

For more information on...	See...
How to search for the Line Item extendable lookup	Searching for the Line Item Extendable Lookup on page 2458
Extendable Lookup screen	Extendable Lookup (Line Item) on page 2459
Extendable Lookup Value List zone	Extendable Lookup Value List on page 2459
Extendable Lookup Value zone	Extendable Lookup Value on page 2460

Viewing the Line Item Details

Procedure

To view the details of a line item:

1. Search for the **Line Item** extendable lookup in the **Extendable Lookup Query** screen.

- In the **Search Results** section, click the link in the **Description** column corresponding to the extendable lookup business object whose details you want to view.

The **Extendable Lookup** screen appears.

- In the **Extendable Lookup Value List** zone, click the **Broadcast** () icon corresponding to the line item whose details you want to view.

The **Extendable Lookup Value** zone appears.

- View the details of the line item in the **Extendable Lookup Value** zone.

Related Topics

For more information on...	See...
How to search for the Line Item extendable lookup	Searching for the Line Item Extendable Lookup on page 2458
Extendable Lookup screen	Extendable Lookup (Line Item) on page 2459
Extendable Lookup Value List zone	Extendable Lookup Value List on page 2459
Extendable Lookup Value zone	Extendable Lookup Value on page 2460

Claim Template Extendable Lookup

The ASO service provider may bill different charges for a claim transaction to different employers. The system enables you to create different claim templates for different employers. A claim template contains a set of charges (i.e. line items) which can be billed to a parent customer or bill group. You can define multiple claim templates in the system. Each claim template must be defined in the system using the **Claim Template (C1-ExtLookClaimTemplate)** extendable lookup. A claim template encapsulates the following information:

- Whether the claim template can be used while defining a claim pricing rule for a policy which is in the **In Force/Active, Post Runout, or Runout** status.
- Line items which can be billed to a parent customer or bill group.
- Whether you want to calculate the markup or markdown on the line items which are included in the claim template.
- Whether you want to specify a flat markup or markdown amount for the line items or the markup or markdown percentage for the line items which are eligible for percentage based markup or markdown
- Whether a line item is eligible for billing or not.
- Whether you want to define rule based billing eligibility for a line item.
- Whether you want to define billing eligibility for a line item while defining a claim pricing rule.
- Rule type which indicates the rules that should be executed to determine whether the line item is eligible for billing.
- Whether the line item is eligible for percentage based markup or markdown when the markup or markdown type is set to **Percentage**.

Once a claim template is defined in the extendable lookup, you can associate the claim template with a claim pricing rule type. You can associate multiple claim templates with a claim pricing rule type. Then, while defining a claim pricing rule for a parent customer, you can use any one of the claim template associated with the respective claim pricing rule type. The system then inherits the line items and the default markup and markdown values in the claim pricing rule from the claim template.

However, while defining a claim pricing rule for a policy of a bill group, you can only use the claim templates which are defined for the respective policy status and associated with the respective claim pricing rule type.

For example, you can create the claim templates with the following line items:

Claim Template	Policy Status	Line Item	Billing Eligibility	Pricing Strategy	Markup or Markdown Type	Markup or Markdown Amount	Markdown or Markdown Percentage
CT1	In Force/ Active	CDH	Yes	Markup	Flat Amount	\$2	-
		THC	Yes				
		PCC	No				
CT2	Runout	CDH	Yes	Markdown	Percentage	-	2.00
		THC	Yes				
CT3	Post Runout	PCC	Yes	None	-	-	-
		NAF	No				

The **Extendable Lookup Query** screen allows you to search for an extendable lookup. It contains the following zone:

- [Extendable Lookup Search](#) on page 2478

Extendable Lookup Search

The **Extendable Lookup Search** zone allows you to search for an extendable lookup. It contains the following two sections:

- **Search Criteria** – The **Search Criteria** section contains the following fields:

Field Name	Field Description	Mandatory (Yes or No)
Business Object	Used to search a particular extendable lookup business object.	No
Description	Used to search extendable lookups with a particular description.	No

Note: You must specify at least one search criterion while searching for an extendable lookup.

- **Search Results** – On clicking the **Search** button, the search results appear based on the specified search criteria. The **Search Results** section contains the following columns:

Column Name	Column Description
Business Object	Displays the extendable lookup business object.
Description	Displays the description of the extendable lookup business object.
	Note: It has a link. On clicking the link, the Extendable Lookup screen appears where you can view the details of the respective extendable lookup.

Related Topics

For more information on...	See...
How to search for the Claim Template extendable lookup	Searching for the Claim Template Extendable Lookup on page 2479

For more information on...	See...
How to view the values of Claim Template extendable lookup	Viewing the Values of the Claim Template Extendable Lookup on page 2479

Searching for the Claim Template Extendable Lookup

Procedure

To search for the **Claim Template** extendable lookup:

1. Click the **Admin** link in the **Application** toolbar.
A list appears.
2. From the **Admin** menu, select **E** and then click **Extendable Lookup**.
The **Extendable Lookup Query** screen appears.
3. In the **Extendable Lookup Search** zone, enter **C1-ExtLookClaimTemplate** in the **Business Object** field.

Note: ORMB search engine supports wildcard search, where you can substitute the percentage (%) symbol as a stand in for any word or letter in a search criteria. You can use the ‘%’ wildcard character in all input fields except the date and ID fields. The ‘%’ wildcard character is suffixed automatically at the end of the partial search criteria. Therefore, you may or may not specify the wildcard character at the end of the partial search criteria. However, you have to prefix the wildcard character manually wherever required.

4. Click **Search**.

The **Claim Template** extendable lookup business object appears in the **Search Results** section.

Related Topics

For more information on...	See...
Extendable Lookup Query screen	Claim Template Extendable Lookup on page 2477
Extendable Lookup Search zone	Extendable Lookup Search on page 2478

Viewing the Values of the Claim Template Extendable Lookup

Procedure

To view the values of the **Claim Template** extendable lookup:

1. Search for the **Claim Template** extendable lookup in the **Extendable Lookup Query** screen.
2. In the **Search Results** section, click the link in the **Description** column corresponding to the extendable lookup business object whose details you want to view.
The **Extendable Lookup** screen appears.
3. View the values of the **Claim Template** extendable lookup in the **Extendable Lookup Value List** zone.

Related Topics

For more information on...	See...
How to search for the Claim Template extendable lookup	Searching for the Claim Template Extendable Lookup on page 2479
Extendable Lookup screen	Extendable Lookup (Claim Template) on page 2480
Extendable Lookup Value List zone	Extendable Lookup Value List on page 2480

Extendable Lookup (Claim Template)

The **Extendable Lookup** screen allows you to view the values of the **Claim Template (C1-ExtLookClaimTemplate)** extendable lookup. It also allows you to define, edit, copy, and delete a claim template. It contains the following zones:

- [Extendable Lookup Value List](#) on page 2480
- [Extendable Lookup Value](#) on page 2481

Extendable Lookup Value List

The **Extendable Lookup Value List** zone lists the values which are already defined for the **Claim Template** extendable lookup. It contains the following columns:

Column Name	Column Description
Value	Displays the claim template.
Description	Displays the description of the claim template.
Owner	Indicates who has created the claim template. The valid values are: <ul style="list-style-type: none"> • Framework • Base • Customer Modification
Edit	On clicking the Edit (✎) icon, the Claim Template screen appears where you can edit the details of the claim template.
Duplicate	On clicking the Duplicate (📄) icon, the Claim Template screen appears where you can define a new claim template using an existing claim template.
Delete	On clicking the Delete (🗑) icon, you can delete the claim template.
	Note: You can delete a claim template when it is not yet used in a claim pricing rule type.
Detailed Description	Displays additional information about the claim template.

Note: Pagination is used to display limited number of records in this zone. You can use the navigation buttons, such as **Previous** and **Next** to navigate between pages.

On clicking the **Broadcast** (📡) icon corresponding to a claim template, the **Extendable Lookup Value** zone appears with the details of the respective claim template.

You can filter the list using various search criteria (such as, **Value** and **Description**) available in the **Filter** area. By default, the **Filter** area is hidden. You can view the **Filter** area by clicking the **Filters** (🔍) icon in the upper right corner of this zone.

Related Topics

For more information on...	See...
How to edit a claim template	Editing a Claim Template on page 2492
How to copy a claim template	Copying a Claim Template on page 2493
How to delete a claim template	Deleting a Claim Template on page 2495

For more information on...	See...
How to view the details of a claim template	Viewing the Claim Template Details on page 2495

Extendable Lookup Value

The **Extendable Lookup Value** zone displays the details of the claim template. It contains the following sections:

- **Main** – Displays basic information about the claim template. It contains the following fields:

Field Name	Field Description
Claim Template	Displays the claim template.
Description	Displays the description of the claim template.
Override Description	Displays the overridden description of the claim template.
Detailed Description	Displays additional information about the claim template.
Status	Indicates the status of the claim template. The valid values are: <ul style="list-style-type: none"> • Active • Inactive

- **Claim Template Usage** – Indicates when the claim template can be used while defining a claim pricing rule for a policy of a bill group. It contains the following field:

Field Name	Field Description
Policy Status	Indicates whether the claim template should be used while defining a claim pricing rule for a policy which is in the In Force/Active, Post Runout, or Runout status. The valid values are: <ul style="list-style-type: none"> • In Force/Active • Post Runout • Runout

- **Claim Handling Fees** – Indicates the claim handling fees which are applicable to one or more line items in the claim template. It contains the following columns:

Column Name	Column Description
Show Line Items in Pricing Rule	Indicates that claim line item appears when you are defining or editing a claim pricing rule.
Fee Type	Indicates the type of charge applicable on the line items.
Fee	Indicates the fee defined for the line items.
Fee Significance	Indicates the purpose of the imposing the claim handling fees on the line items.
Fee Applicability	Indicates the fee applicability on which the claim handling fees are defined.

Column Name	Column Description								
Rating Information	Indicates the rate type and value that you want to use while defining the rating information for the line items.								
	<table border="1"> <thead> <tr> <th>Column Name</th> <th>Column Description</th> </tr> </thead> <tbody> <tr> <td>Editable</td> <td>Indicates that rate type and rate value fields are editable while defining or editing the claim handling fees for the line items.</td> </tr> <tr> <td>Rate Type</td> <td>Indicates the rate type that you want to use while defining or editing the claim handling fees for the line items.</td> </tr> <tr> <td>Rate</td> <td>Displays the rate that you want to use while defining or editing the claim handling fees for the line items.</td> </tr> </tbody> </table>	Column Name	Column Description	Editable	Indicates that rate type and rate value fields are editable while defining or editing the claim handling fees for the line items.	Rate Type	Indicates the rate type that you want to use while defining or editing the claim handling fees for the line items.	Rate	Displays the rate that you want to use while defining or editing the claim handling fees for the line items.
Column Name	Column Description								
Editable	Indicates that rate type and rate value fields are editable while defining or editing the claim handling fees for the line items.								
Rate Type	Indicates the rate type that you want to use while defining or editing the claim handling fees for the line items.								
Rate	Displays the rate that you want to use while defining or editing the claim handling fees for the line items.								

- **Default Markup or Markdown Values** – Indicates the default markup or markdown values defined for the line items in the claim template. It contains the following fields:

Field Name	Field Description
Pricing Strategy	Indicates whether you want to markup or markdown the line items. The valid values are: <ul style="list-style-type: none"> • Markup • Markdown • None
Markup or Markdown Type	Indicates whether you want a flat or percentage based markup or markdown on the line items. The valid values are: <ul style="list-style-type: none"> • Flat Amount • Percentage <p>Note: This field appears when the Markup or Markdown option is selected from the Pricing Strategy list.</p>
Markup or Markdown Amount	Displays the default flat markup or markdown amount for the line items. <p>Note: This field appears when the Flat Amount option is selected from the Markup or Markdown Type list.</p>
Markup or Markdown Percentage	Displays the default percentage of markup or markdown for all line items. <p>Note: This field appears when the Percentage option is selected from the Markup or Markdown Type list.</p>
Editable	Indicates that rate type and rate value fields are editable while defining or editing the markup or markdown values for the line items.
Rate Type	Displays minimum and maximum markup or markdown defined using the rate type.
Rate	Displays the rate for minimum and maximum markup or markdown defined using the rate type.

- **Line Items** – Lists the line items which are added in the claim template. It contains the following columns:

Column Name	Column Description								
Sequence	Indicates the order in which the calculation line should be generated for the line item.								
Line Item	Indicate the line item which is added in the claim template.								
Billing Eligibility	Indicates whether the line item is eligible for billing. The valid values are: <ul style="list-style-type: none"> • Eligible • Not Eligible • Rule Based • Used Defined (Default No) • User Defined (Default Yes) 								
Rule Type	Indicates that rules of the specified rule type should be executed to determine whether the line item is eligible for billing. Note: The data appears in this column when the Rule Based option is selected from the Billing Eligibility list.								
Markup or Markdown Percentage Eligibility	Indicates whether the line item is eligible for percentage based markup or markdown when the Markup or Markdown Type field is set to Percentage . The valid values are: <ul style="list-style-type: none"> • Eligible • Not Eligible 								
Post-Processing Required	Indicates that the line item is applicable for post-processing once the claim pricing rule is derived for a claim transaction.								
Rating Information	Displays the rate type and rate value that you want to use while defining the rate for the line items. <table border="1" data-bbox="613 1213 1463 1686"> <thead> <tr> <th>Column Name</th> <th>Column Description</th> </tr> </thead> <tbody> <tr> <td>Editable</td> <td>Indicates that the rate type and rate value fields are editable while defining a claim pricing rule.</td> </tr> <tr> <td>Rate Type</td> <td>Indicates the rate type that you want to use while defining the rate for the line items.</td> </tr> <tr> <td>Rate</td> <td>Used to specify the rate that you want to use while defining the rate for the line items. Note: This field is editable when the Editable checkbox is selected in the Rate column of the Additional Fees section while defining or editing the C1-ExtLookClaimTemplate extendable lookup.</td> </tr> </tbody> </table>	Column Name	Column Description	Editable	Indicates that the rate type and rate value fields are editable while defining a claim pricing rule.	Rate Type	Indicates the rate type that you want to use while defining the rate for the line items.	Rate	Used to specify the rate that you want to use while defining the rate for the line items. Note: This field is editable when the Editable checkbox is selected in the Rate column of the Additional Fees section while defining or editing the C1-ExtLookClaimTemplate extendable lookup.
Column Name	Column Description								
Editable	Indicates that the rate type and rate value fields are editable while defining a claim pricing rule.								
Rate Type	Indicates the rate type that you want to use while defining the rate for the line items.								
Rate	Used to specify the rate that you want to use while defining the rate for the line items. Note: This field is editable when the Editable checkbox is selected in the Rate column of the Additional Fees section while defining or editing the C1-ExtLookClaimTemplate extendable lookup.								

- **Record Actions** – This section contains the following buttons:

Button Name	Button Description
Edit	Used to edit the details of the claim template.

Button Name	Button Description
Delete	Used to delete the claim template.
	Note: You can delete a claim template when it is not yet used in a claim pricing rule type.
Duplicate	Used to create a new claim template using an existing claim template.

- **Record Information** – This section contains the following fields:

Field Name	Field Description
Business Object	Indicates the extendable lookup business object using which the claim template is created. In addition, a context menu appears corresponding to this field which helps in navigating to other screens in the application.
	Note: It has a link. On clicking the link, the Business Object screen appears where you can view the details of the respective business object.
Owner	Indicates who has created the claim template. The valid values are: <ul style="list-style-type: none"> • Framework • Base • Customer Modification

By default, the **Extendable Lookup Value** zone does not appear in the **Extendable Lookup** screen. It appears when you click the **Broadcast** () icon corresponding to the claim template in the **Extendable Lookup Value List** zone.

Related Topics

For more information on...	See...
How to edit a claim template	Editing a Claim Template on page 2492
How to copy a claim template	Copying a Claim Template on page 2493
How to delete a claim template	Deleting a Claim Template on page 2495
How to view the details of a claim template	Viewing the Claim Template Details on page 2495

Defining a Claim Template

Procedure

To define a claim template:

1. Search for the **Claim Template** extendable lookup in the **Extendable Lookup Query** screen.
2. In the **Search Results** section, click the link in the **Description** column corresponding to the extendable lookup business object whose details you want to view.

The **Extendable Lookup** screen appears.

3. Click the **Add** button in the **Page Title** area of the **Extendable Lookup** screen.

The **Claim Template** screen appears. It contains the following sections:

- **Main** – Used to specify basic details about the claim template. It contains the following fields:

Field Name	Field Description	Mandatory (Yes or No)
Claim Template	Used to specify the claim template.	Yes
Description	Used to specify the description for the claim template.	Yes
Override Description	Used when you want to override the description of the claim template.	No
Detailed Description	Used to specify additional information about the claim template.	No
Status	Used to indicate the status of the claim template. The valid values are: <ul style="list-style-type: none"> Active Inactive 	Yes
	Note: By default, the value is set to Active .	

- **Claim Template Usage** – Used to indicate when the claim template can be used while defining a claim pricing rule for a policy of a bill group. It contains the following field:

Field Name	Field Description	Mandatory (Yes or No)
Policy Status	Used to indicate whether you want to use the claim template while defining a claim pricing rule for a policy which is in the In Force/Active , Post Runout , or Runout status. The valid values are: <ul style="list-style-type: none"> In Force/Active Post Runout Runout 	Yes

- **Claim Handling Fees** – Used to define the claim handling fees for the claim lines items which are added in the claim template.
 - **Default Markup or Markdown Values** – Used to indicate the default markup or markdown values for the claim line items which are added in the claim template.
 - **Line Items** – Used to add the claim line items in the claim template.
4. Enter the required details in the **Main** section.
 5. Select the **In Force/Active**, **Post Runout**, or **Runout** option from the **Policy Status** dropdown list depending on whether you want to use the claim template while defining a claim pricing rule for a
 6. Define the claim handling fees for the line items in the claim template, if required.
 7. Define the default markup or markdown values for the line items in the claim template, if required.
 8. Add the required the line items in the claim template.
 9. Click **Save**.

The claim template is added in the **C1-ExtLookClaimTemplate** extendable lookup.

Related Topics

For more information on...	See...
How to search for the Claim Template extendable lookup	Searching for the Claim Template Extendable Lookup on page 2479
Extendable Lookup screen	Extendable Lookup (Claim Template) on page 2480
How to define the claim handling fees for the line items in the claim template	Defining the Claim Handling Fees for Line Items in the Claim Template on page 2486
How to define the default markup or markdown values for the line items in the claim template	Defining the Default Markup or Markdown Values for Line Items in a Claim Template on page 2488
How to add the line items in a claim template	Adding a Line Item in a Claim Template on page 2489

Defining the Claim Handling Fees for Line Items in the Claim Template

Procedure

To define the claim handling fees for the line items in the claim template:

1. Ensure that the **Claim Handling Fees** section is expanded when you are defining, editing, or copying a claim template.

The **Claim Handling Fees** section contains the following fields:

Field Name	Field Description	Mandatory (Yes or No)				
Show Line Items in Pricing Rule	Used to indicate whether the claim line item is visible while defining or editing the pricing rules.	Not applicable				
Fee Type	Used to indicate the charge type defined on the line items.	Yes				
Fee	Used to indicate the type of rate defined on the line items.	Yes				
Fee Significance	Used to indicate the purpose of the imposing the fees on the line items.	Yes				
Fee Applicability	Displays one or more applicable claim line item on which the claim handling fees are imposed. <table border="1" data-bbox="537 1308 1252 1472"> <thead> <tr> <th>Field Name</th> <th>Field Description</th> </tr> </thead> <tbody> <tr> <td>Line Items</td> <td>Indicates the line item that you want to use while defining claim handling fees for the claim pricing rule.</td> </tr> </tbody> </table>	Field Name	Field Description	Line Items	Indicates the line item that you want to use while defining claim handling fees for the claim pricing rule.	Yes
Field Name	Field Description					
Line Items	Indicates the line item that you want to use while defining claim handling fees for the claim pricing rule.					

Field Name	Field Description	Mandatory (Yes or No)												
Rating Information	Used to indicate one or more rate options which are valid for a line item.	Yes												
	<table border="1"> <thead> <tr> <th>Field Name</th> <th>Field Description</th> <th>Mandatory (Yes or No)</th> </tr> </thead> <tbody> <tr> <td>Editable</td> <td>Used to indicate whether the rate specified for a rate type is editable when you use the claim template in a claim pricing rule.</td> <td>No</td> </tr> <tr> <td>Rate Type</td> <td>Indicates the rate type that you want to use while defining the rate for the line items.</td> <td>Yes</td> </tr> <tr> <td>Rate</td> <td>Used to specify the rate that you want to use while defining the rate for the line items. <div style="border: 1px solid black; padding: 5px;"> <p>Note: This field is editable when the Editable checkbox is selected in the Rating Information column of the Claim Handling Fees section while defining or editing the C1-ExtLookClaimTemplate extendable lookup.</p> </div> </td> <td>Yes</td> </tr> </tbody> </table>	Field Name	Field Description	Mandatory (Yes or No)	Editable	Used to indicate whether the rate specified for a rate type is editable when you use the claim template in a claim pricing rule.	No	Rate Type	Indicates the rate type that you want to use while defining the rate for the line items.	Yes	Rate	Used to specify the rate that you want to use while defining the rate for the line items. <div style="border: 1px solid black; padding: 5px;"> <p>Note: This field is editable when the Editable checkbox is selected in the Rating Information column of the Claim Handling Fees section while defining or editing the C1-ExtLookClaimTemplate extendable lookup.</p> </div>	Yes	
Field Name	Field Description	Mandatory (Yes or No)												
Editable	Used to indicate whether the rate specified for a rate type is editable when you use the claim template in a claim pricing rule.	No												
Rate Type	Indicates the rate type that you want to use while defining the rate for the line items.	Yes												
Rate	Used to specify the rate that you want to use while defining the rate for the line items. <div style="border: 1px solid black; padding: 5px;"> <p>Note: This field is editable when the Editable checkbox is selected in the Rating Information column of the Claim Handling Fees section while defining or editing the C1-ExtLookClaimTemplate extendable lookup.</p> </div>	Yes												

2. Enter the required details in the **Claim Handling Fees** section.
3. If you want to add more than one claim handling fee in the claim template, click the **Add (+)** icon and then repeat step 2.

Note: However, if you want to remove a claim handling fee from the claim template, click the **Delete (🗑)** icon corresponding to the line item.

4. If you want to add more than one fee applicability in the claim template, click the **Add (+)** icon and then repeat step 2.

Note: However, if you want to remove a fee applicability from the claim template, click the **Delete (🗑)** icon corresponding to the line item.

5. If you want to add more than one rating information in the claim template, click the **Add (+)** icon and then repeat step 2.

Note: However, if you want to remove a rating information from the claim template, click the **Delete (🗑)** icon corresponding to the line item.

6. Click **Save**.

The claim handling fees are defined for the line items in the claim template.

Related Topics

For more information on...	See...
How to define a claim template	Defining a Claim Template on page 2484
How to edit a claim template	Editing a Claim Template on page 2492
How to copy a claim template	Copying a Claim Template on page 2493

Defining the Default Markup or Markdown Values for Line Items in a Claim Template

Procedure

To define the markup or markdown values for line items in a claim pricing rule:

1. Ensure that the **Default Markup or Markdown Values** section is expanded when you are defining, editing, or copying a claim template.

The **Default Markup or Markdown Values** section contains the following fields:

Field Name	Field Description	Mandatory (Yes or No)
Pricing Strategy	Used to indicate the pricing strategy. The valid values are: <ul style="list-style-type: none"> • Markdown • Markup • None 	No
Markup or Markdown Type	Used to indicate the markup or markdown type for the claim line items. The valid values are: <ul style="list-style-type: none"> • Flat Amount • Percentage 	No
Markup or Markdown Amount	Used to specify the markup or markdown amount.	No
Markup or Markdown Percentage	Used to specify the markup or markdown percentage.	No
Editable	Used to indicate whether the rate specified for a rate type is editable when you use the claim template in a claim pricing rule.	Not applicable
Rate Type	Indicates the minimum and maximum markup or markdown defined using the rate type.	Yes (Conditional) Note: This field is required when you define the rate from the respective field.
Rate	Used to specify the value for minimum and maximum markup or markdown using the rate type.	Yes (Conditional) Note: This field is required when you select the rate type from the respective field.

2. Enter the required details in the **Markup or Markdown Values** section.

- If you want to add more than one default markup or markdown value in the claim template, click the **Add (+)** icon and then repeat step 2.

Note: However, if you want to remove a default markup or markdown value from the claim template, click the **Delete (🗑)** icon corresponding to the line item.

- Click **Save**.

The markup or markdown values for line items are defined for the claim template.

Related Topics

For more information on...	See...
How to define a claim template	Defining a Claim Template on page 2484
How to edit a claim template	Editing a Claim Template on page 2492
How to copy a claim template	Copying a Claim Template on page 2493

Adding a Line Item in a Claim Template

Prerequisites

To add a line item in a claim template, you should have:

- The line item defined in the **C1-ExtLookPricingRuleLineItem** extendable lookup.
- Rule types defined in the application (where the rule type usage is set to **ASO Billing Line Item Eligibility**) when you want to define rule based billing eligibility for a line item.

Procedure

To add a line item in a claim template:

- Ensure that the **Line Items** section is expanded when you are defining, editing, or copying a claim template.

The **Line Items** section contains the following fields in a grid:

Field Name	Field Description	Mandatory (Yes or No)
Sequence	Used to indicate the order in which the calculation line should be generated for the line item.	Yes (Conditional) Note: This field is required while adding a line item in the claim template.
Line Item	Used to indicate the line item that you want to include in the claim template. Note: The list includes only those line items which are associated to the Claim pricing rule type category.	Yes (Conditional) Note: This field is required while adding a line item in the claim template.

Field Name	Field Description	Mandatory (Yes or No)
Billing Eligibility	<p>Used to indicate whether the line item is eligible for billing. If line item is not eligible for billing, the system does not create the calculation line for the line item. The valid values are:</p> <ul style="list-style-type: none"> • Eligible - Used when the line item is eligible for billing. • Not Eligible - Used when the line item is not eligible for billing. • Rule Based - Used when you want to determine whether the line item is eligible for billing using certain business rules while executing the Update Status (C1-TXNEX) batch. • Used Defined (Default No) - Used when you want to define billing eligibility for the line item while defining a claim pricing rule using the claim template. If you select this option, by default, the User Defined Billing Option option is not selected for the line item in the claim pricing rule. • User Defined (Default Yes) - Used when you want to define billing eligibility for the line item while defining a claim pricing rule using the claim template. If you select this option, by default, the User Defined Billing Option option is selected for the line item in the claim pricing rule. 	<p>Yes (Conditional)</p> <p>Note: This field is required while adding a line item in the claim template.</p>
Rule Type	<p>Used to indicate that rules of the specified rule type should be executed to determine whether the line item is eligible for billing.</p> <p>Note: The list includes only those rule types where the rule type usage is set to ASO Billing Line Item Eligibility. The values appear in this list when you select the Rule Based option from the Billing Eligibility list.</p>	<p>Yes (Conditional)</p> <p>Note: This field is required when you select the Rule Based option from the Billing Eligibility list.</p>
Markup or Markdown Percentage Eligibility	<p>Used to indicate whether the line item is eligible for percentage based markup or markdown when the Markup or Markdown Type field is set to Percentage. The valid values are:</p> <ul style="list-style-type: none"> • Eligible • Not Eligible 	<p>Yes (Conditional)</p> <p>Note: This field is required while adding a line item in the claim template.</p>
Post-Processing Required	<p>Used to indicate that the line item is applicable for post-processing once the claim pricing rule is derived for a claim transaction.</p>	<p>Yes (Conditional)</p> <p>Note: This field is required while adding a line item in the claim template.</p>

Field Name	Field Description	Mandatory (Yes or No)												
Rating Information	Displays the rate type and rate value that you want to use while defining the rate for the line items.	Yes (Conditional)												
	<table border="1"> <thead> <tr> <th>Field Name</th> <th>Field Description</th> <th>Mandatory (Yes or No)</th> </tr> </thead> <tbody> <tr> <td>Editable</td> <td>Used to indicate that the rate type and rate value fields are editable while defining a claim pricing rule.</td> <td>Not applicable</td> </tr> <tr> <td>Rate Type</td> <td>Used to indicate the rate type that you want to use while defining the rate for the line items.</td> <td>Yes (Conditional) Note: This field is required when you define the rate from the respective field.</td> </tr> <tr> <td>Rate</td> <td>Used to specify the rate that you want to use while defining the rate for the line items.</td> <td>Yes (Conditional) Note: This field is required when you select the rate type from the respective field.</td> </tr> </tbody> </table>	Field Name	Field Description	Mandatory (Yes or No)	Editable	Used to indicate that the rate type and rate value fields are editable while defining a claim pricing rule.	Not applicable	Rate Type	Used to indicate the rate type that you want to use while defining the rate for the line items.	Yes (Conditional) Note: This field is required when you define the rate from the respective field.	Rate	Used to specify the rate that you want to use while defining the rate for the line items.	Yes (Conditional) Note: This field is required when you select the rate type from the respective field.	Note: This field is required while adding a line item in the claim template.
	Field Name	Field Description	Mandatory (Yes or No)											
	Editable	Used to indicate that the rate type and rate value fields are editable while defining a claim pricing rule.	Not applicable											
Rate Type	Used to indicate the rate type that you want to use while defining the rate for the line items.	Yes (Conditional) Note: This field is required when you define the rate from the respective field.												
Rate	Used to specify the rate that you want to use while defining the rate for the line items.	Yes (Conditional) Note: This field is required when you select the rate type from the respective field.												

- Enter the required details in the **Line Items** section.
- If you want to add more than one line item in the claim template, click the **Add (+)** icon and then repeat step 2.

Note: However, if you want to remove a line item from the claim template, click the **Delete (🗑)** icon corresponding to the line item.

- Click **Save**.

The line item is added in the claim template.

Related Topics

For more information on...	See...
How to define a claim template	Defining a Claim Template on page 2484
How to edit a claim template	Editing a Claim Template on page 2492
How to copy a claim template	Copying a Claim Template on page 2493

Editing a Claim Template

Procedure

To edit a claim template:

1. Search for the **Claim Template** extendable lookup in the **Extendable Lookup Query** screen.
2. In the **Search Results** section, click the link in the **Description** column corresponding to the extendable lookup business object whose details you want to view.

The **Extendable Lookup** screen appears.

3. In the **Extendable Lookup Value List** zone, click the **Edit** (✎) icon in the **Edit** column corresponding to the claim template whose details you want to edit.

The **Claim Template** screen appears. It contains the following sections:

- **Main** – Used to specify basic details about the claim template. It contains the following fields:

Field Name	Field Description	Mandatory (Yes or No)
Claim Template	Displays the claim template.	Not applicable
Description	Used to specify the description for the claim template.	Yes
Override Description	Used when you want to override the description of the claim template.	No
Detailed Description	Used to specify additional information about the claim template.	No
Status	Used to indicate the status of the claim template. The valid values are: <ul style="list-style-type: none"> • Active • Inactive 	Yes

- **Claim Template Usage** – Used to indicate when the claim template can be used while defining a claim pricing rule for a policy of a bill group. It contains the following field:

Field Name	Field Description	Mandatory (Yes or No)
Policy Status	Used to indicate whether you want to use the claim template while defining a claim pricing rule for a policy which is in the In Force/Active , Post Runout , or Runout status. The valid values are: <ul style="list-style-type: none"> • In Force/Active • Post Runout • Runout 	Yes

- **Claim Handling Fees** – Used to indicate the claim handling fees for the lines items which are added in the claim template.
- **Default Markup or Markdown Values** – Used to indicate the default markup or markdown values for the claim line items which are added in the claim template.
- **Line Items** – Used to indicate the line items in the claim template.

Tip: Alternatively, you can edit the details of a claim template by clicking the **Edit** button in the **Extendable Lookup Value** zone.

4. Modify the required details in the **Main** section.
5. Modify the policy status in the **Claim Template Usage** section, if required.
6. Add, edit, or remove the claim handling fees for the line items in the claim template, if required.
7. Modify the default markup or markdown values for the line items in the claim template, if required.
8. Add, edit, or remove line items from the claim template, if required.
9. Click **Save**.

The changes made to the claim template are saved.

Related Topics

For more information on...	See...
How to search for the Claim Template extendable lookup	Searching for the Claim Template Extendable Lookup on page 2479
Extendable Lookup screen	Extendable Lookup (Claim Template) on page 2480
Extendable Lookup Value List zone	Extendable Lookup Value List on page 2480
Extendable Lookup Value zone	Extendable Lookup Value on page 2481
How to define the claim handling fees for the line items in the claim template	Defining the Claim Handling Fees for Line Items in the Claim Template on page 2486
How to define the default markup or markdown values for the line items in the claim template	Defining the Default Markup or Markdown Values for Line Items in a Claim Template on page 2488
How to add the line items in a claim template	Adding a Line Item in a Claim Template on page 2489

Copying a Claim Template

Instead of creating a claim template from scratch, you can create a new claim template using an existing claim template. This is possible through copying a claim template. On copying a claim template, the details including the line items and default markup or markdown values are copied to the new claim template. You can then edit the details, if required.

Prerequisites

To copy a claim template, you should have:

- Claim template (whose copy you want to create) defined in the application

Procedure

To copy a claim template:

1. Search for the **Claim Template** extendable lookup in the **Extendable Lookup Query** screen.
2. In the **Search Results** section, click the link in the **Description** column corresponding to the extendable lookup business object whose details you want to view.

The **Extendable Lookup** screen appears.

3. In the **Extendable Lookup Value List** zone, click the **Duplicate**  icon in the **Duplicate** column corresponding to the claim template whose copy you want to create.

The **Claim Template** screen appears. It contains the following sections:

- **Main** – Used to specify basic details about the claim template. It contains the following fields:

Field Name	Field Description	Mandatory (Yes or No)
Claim Template	Used to specify the claim template.	Yes
Description	Used to specify the description for the claim template.	Yes
Override Description	Used when you want to override the description of the claim template.	No
Detailed Description	Used to specify additional information about the claim template.	No
Status	Used to indicate the status of the claim template. The valid values are: <ul style="list-style-type: none"> Active Inactive 	Yes

- **Claim Template Usage** – Used to indicate when the claim template can be used while defining a claim pricing rule for a policy of a bill group. It contains the following field:

Field Name	Field Description	Mandatory (Yes or No)
Policy Status	Used to indicate whether you want to use the claim template while defining a claim pricing rule for a policy which is in the In Force/Active , Post Runout , or Runout status. The valid values are: <ul style="list-style-type: none"> In Force/Active Post Runout Runout 	Yes

- **Claim Handling Fees** – Used to indicate the claim handling fees for the lines items which are added in the claim template.
- **Default Markup or Markdown Values** – Used to indicate the default markup or markdown values for the line items which are added in the claim template.
- **Line Items** – Used to add the claim line items in the claim template.

Tip: Alternatively, you can copy a claim template by clicking the **Duplicate** button in the **Extendable Lookup Value** zone.

4. Enter the required details in the **Main** section.
5. Select the **In Force/Active**, **Post Runout**, or **Runout** option from the **Policy Status** list depending on whether you want to use the claim template while defining a claim pricing rule for a policy in a particular status.
6. Add, edit, or remove the claim handling fees for the line items in the claim template, if required.
7. Modify the default markup or markdown values for the line items in the claim template, if required.
8. Add, edit, or remove the line items from the claim template, if required.
9. Click **Save**.

The new claim template is added in the **C1-ExtLookClaimTemplate** extendable lookup.

Related Topics

For more information on...	See...
How to search for the Claim Template extendable lookup	Searching for the Claim Template Extendable Lookup on page 2479
Extendable Lookup screen	Extendable Lookup (Claim Template) on page 2480
Extendable Lookup Value List zone	Extendable Lookup Value List on page 2480
Extendable Lookup Value zone	Extendable Lookup Value on page 2481
How to define the claim handling fees for the line items in the claim template	Defining the Claim Handling Fees for Line Items in the Claim Template on page 2486
How to define the default markup or markdown values for the line items in the claim template	Defining the Default Markup or Markdown Values for Line Items in a Claim Template on page 2488
How to add the line items in a claim template	Adding a Line Item in a Claim Template on page 2489

Deleting a Claim Template

Procedure

To delete a claim template:

1. Search for the **Claim Template** extendable lookup in the **Extendable Lookup Query** screen.
2. In the **Search Results** section, click the link in the **Description** column corresponding to the extendable lookup business object whose details you want to view.
The **Extendable Lookup** screen appears.

3. In the **Extendable Lookup Value List** zone, click the **Delete** (🗑️) icon in the **Delete** column corresponding to the claim template that you want to delete.

A message appears confirming whether you want to delete the claim template.

Note: You can delete a claim template when it is not yet used in a claim pricing rule type.

Tip: Alternatively, you can delete a claim template by clicking the **Delete** button in the **Extendable Lookup Value** zone.

4. Click **OK**.

The claim template is deleted from the **C1-ExtLookClaimTemplate** extendable lookup.

Related Topics

For more information on...	See...
How to search for the Claim Template extendable lookup	Searching for the Claim Template Extendable Lookup on page 2479
Extendable Lookup screen	Extendable Lookup (Claim Template) on page 2480
Extendable Lookup Value List zone	Extendable Lookup Value List on page 2480
Extendable Lookup Value zone	Extendable Lookup Value on page 2481

Viewing the Claim Template Details

Procedure

To view the details of a claim template:

1. Search for the **Claim Template** extendable lookup in the **Extendable Lookup Query** screen.
2. In the **Search Results** section, click the link in the **Description** column corresponding to the extendable lookup business object whose details you want to view.
The **Extendable Lookup** screen appears.
3. In the **Extendable Lookup Value List** zone, click the **Broadcast** (📡) icon corresponding to the claim template whose details you want to view.
The **Extendable Lookup Value** zone appears.
4. View the details of the claim template in the **Extendable Lookup Value** zone.

Related Topics

For more information on...	See...
How to search for the Claim Template extendable lookup	Searching for the Claim Template Extendable Lookup on page 2479
Extendable Lookup screen	Extendable Lookup (Claim Template) on page 2480
Extendable Lookup Value List zone	Extendable Lookup Value List on page 2480
Extendable Lookup Value zone	Extendable Lookup Value on page 2481

Rate Option Extendable Lookup

The basic pricing details (such as rate schedule, pricing currency) and the transaction aggregation details may vary from one bill group or parent customer to another and from one price item to another. The basic pricing and transaction aggregation details are defined in the rate option. Each rate option must be defined in the system using the **Rate Option (C1-ExtLookRetTypeRateOpt)** extendable lookup. A rate option encapsulates the following information:

- The rate schedule that you want to use while defining the price item pricing.
- Currency in which you want to define the price item pricing.
- Whether zero pricing should be displayed in the bill.
- Whether the transactions mapped to the price item should be ignored for billing.
- Whether the transactions mapped to the price item should be aggregated for billing.
- The aggregation schedule using which the transactions should be aggregated for billing.
- How and when you want to rate the transaction legs which are mapped to the price item.
- Whether you want the price item pricing to be applied to all customers or only to the new customers.

Once the rate options are defined in the extendable lookup, you can associate one or more rate options with a price item while adding the price item in a claim, specific stop-loss, aggregate stop-loss, retention type claim based, retention type enrollment based, or ancillary pricing rule type. You can then use the rate option while defining pricing rule for the respective price item using the respective pricing rule type. The rate option specified in a pricing rule is used while creating the price item pricing or price assignment for the pricing rule. For example,

Claim Pricing Rule Type	Price Item	Rate Option	Claim Pricing Rule	Price Item Pricing
CPRT1	P1	R1	CPR1 (Price Item: P1, Rate Option: R1)	PA1 is created for P1 using the details specified in R1.

Claim Pricing Rule Type	Price Item	Rate Option	Claim Pricing Rule	Price Item Pricing
		R2	-	-
		R3	CPR2 (Price Item: P1, Rate Option: R3)	PA2 is created for P1 using the details specified in R3.
	P2	R1	-	-
		R4	CPR3 (Price Item: P2, Rate Option: R4)	PA3 is created for P2 using the details specified in R4.
CPRT2	P1	R1	CPR4 (Price Item: P1, Rate Option: R1)	PA4 is created for P1 using the details specified in R1.

The **Extendable Lookup Query** screen allows you to search for an extendable lookup. It contains the following zone:

- [Extendable Lookup Search](#) on page 2497

Extendable Lookup Search

The **Extendable Lookup Search** zone allows you to search for an extendable lookup. It contains the following two sections:

- **Search Criteria** – The **Search Criteria** section contains the following fields:

Field Name	Field Description	Mandatory (Yes or No)
Business Object	Used to search a particular extendable lookup business object.	No
Description	Used to search extendable lookups with a particular description.	No

Note: You must specify at least one search criterion while searching for an extendable lookup.

- **Search Results** – On clicking the **Search** button, the search results appear based on the specified search criteria. The **Search Results** section contains the following columns:

Column Name	Column Description
Business Object	Displays the extendable lookup business object.
Description	Displays the description of the extendable lookup business object.
	Note: It has a link. On clicking the link, the Extendable Lookup screen appears where you can view the details of the respective extendable lookup.

Related Topics

For more information on...	See...
How to search for the Rate Option extendable lookup	Searching for the Rate Option Extendable Lookup on page 2498
How to view the values of the Rate Option extendable lookup	Viewing the Values of the Rate Option Extendable Lookup on page 2498

Searching for the Rate Option Extendable Lookup

Procedure

To search for the **Rate Option** extendable lookup:

1. Click the **Admin** link in the **Application** toolbar.
A list appears.
2. From the **Admin** menu, select **E** and then click **Extendable Lookup**.
The **Extendable Lookup Query** screen appears.
3. In the **Extendable Lookup Search** zone, enter **C1-ExtLookRetTypeRateOpt** in the **Business Object** field.

Note: ORMB search engine supports wildcard search, where you can substitute the percentage (%) symbol as a stand in for any word or letter in a search criteria. You can use the ‘%’ wildcard character in all input fields except the date and ID fields. The ‘%’ wildcard character is suffixed automatically at the end of the partial search criteria. Therefore, you may or may not specify the wildcard character at the end of the partial search criteria. However, you have to prefix the wildcard character manually wherever required.

4. Click **Search**.

The **Rate Option** extendable lookup business object appears in the **Search Results** section.

Related Topics

For more information on...	See...
Extendable Lookup Query screen	Rate Option Extendable Lookup on page 2496
Extendable Lookup Search zone	Extendable Lookup Search on page 2497

Viewing the Values of the Rate Option Extendable Lookup

Procedure

To view the values of the **Rate Option** extendable lookup:

1. Search for the **Rate Option** extendable lookup in the **Extendable Lookup Query** screen.
2. In the **Search Results** section, click the link in the **Description** column corresponding to the extendable lookup business object whose details you want to view.
The **Extendable Lookup** screen appears.
3. View the values of the **Rate Option** extendable lookup in the **Extendable Lookup Value List** zone.

Related Topics

For more information on...	See...
How to search for the Rate Option extendable lookup	Searching for the Rate Option Extendable Lookup on page 2498
Extendable Lookup screen	Extendable Lookup (Rate Option) on page 2499
Extendable Lookup Value List zone	Extendable Lookup Value List on page 2499

Extendable Lookup (Rate Option)

The **Extendable Lookup** screen allows you to view the values of the **Rate Option (C1-ExtLookRetTypeRateOpt)** extendable lookup. It also allows you to define, edit, copy, and delete a rate option. It contains the following zones:

- [Extendable Lookup Value List](#) on page 2499
- [Extendable Lookup Value](#) on page 2500

Extendable Lookup Value List

The **Extendable Lookup Value List** zone lists the values which are already defined for the **Rate Option** extendable lookup. It contains the following columns:

Column Name	Column Description
Value	Displays the rate option.
Description	Displays the description of the rate option.
Owner	Indicates who has created the rate option. The valid values are: <ul style="list-style-type: none"> • Framework • Base • Customer Modification
Edit	On clicking the Edit (✎) icon, the Rate Option screen appears where you can edit the details of the rate option.
Duplicate	On clicking the Duplicate (📄) icon, the Rate Option screen appears where you can define a new rate option using an existing rate option.
Delete	On clicking the Delete (🗑) icon, you can delete the rate option.
	Note: You can delete a rate option when it is not yet used in a pricing rule type.
Detailed Description	Displays additional information about the rate option.

Note: Pagination is used to display limited number of records in this zone. You can use the navigation buttons, such as **Previous** and **Next** to navigate between pages.

On clicking the **Broadcast** (📡) icon corresponding to a rate option, the **Extendable Lookup Value** zone appears with the details of the respective rate option.

You can filter the list using various search criteria (such as, **Value** and **Description**) available in the **Filter** area. By default, the **Filter** area is hidden. You can view the **Filter** area by clicking the **Filters** (🔍) icon in the upper right corner of this zone.

Related Topics

For more information on...	See...
How to edit a rate option	Editing a Rate Option on page 2504
How to copy a rate option	Copying a Rate Option on page 2507
How to delete a rate option	Deleting a Rate Option on page 2510

For more information on...	See...
How to view the details of a rate option	Viewing the Rate Option Details on page 2510

Extendable Lookup Value

The **Extendable Lookup Value** zone displays the details of the rate option. It contains the following sections:

- **Main** – Displays basic information about the rate option. It contains the following fields:

Field Name	Field Description
Rate Option	Displays the rate option.
Description	Displays the description of the rate option.
Override Description	Displays the overridden description of the rate option.
Detailed Description	Displays additional information about the rate option.
Status	Indicates the status of the rate option. The valid values are: <ul style="list-style-type: none"> • Active • Inactive
Rate Schedule	Indicates the rate schedule that will be used while defining the price item pricing. It is the rate schedule which helps the system to create calculation lines for a transaction leg. <p>Note: It has a link. On clicking the link, the Rate Schedule screen appears where you can view the details of the respective rate schedule.</p>
Pricing Currency	Indicates the currency in which the price item pricing will be defined.
Print Zero	Indicates whether zero pricing will be displayed in the bill. The valid values are: <ul style="list-style-type: none"> • Yes • No
Ignore Transaction	Indicates whether the transactions mapped to the price item will be ignored for billing. The valid values are: <ul style="list-style-type: none"> • Yes • No
Aggregate Transaction	Indicates whether the transactions mapped to the price item will be aggregated for billing. The valid values are: <ul style="list-style-type: none"> • Yes • No
Aggregation Schedule	Indicates the aggregation schedule using which the transactions will be aggregated for billing.

Field Name	Field Description
Transaction Rating Criteria	Indicates how and when the transaction legs which are mapped to the price item are rated. The valid values are: <ul style="list-style-type: none"> Aggregate Transactions and Then Rate SQs Do Not Rate Transactions Rate Transaction and Aggregate Calc Lines Rate Transactions
Apply To	Indicates whether the price item pricing will be applied to all customers or only to the new customers. The valid values are: <ul style="list-style-type: none"> All Customers New Customers

- **Record Actions** – This section contains the following buttons:

Button Name	Button Description
Edit	Used to edit the details of the rate option.
Delete	Used to delete the rate option.
	Note: You can delete a rate option when it is not yet used in a pricing rule type.
Duplicate	Used to create a new rate option using an existing rate option.

- **Record Information** – This section contains the following fields:

Field Name	Field Description
Business Object	Indicates the extendable lookup business object using which the rate option is created. In addition, a context menu appears corresponding to this field which helps in navigating to other screens in the application.
	Note: It has a link. On clicking the link, the Business Object screen appears where you can view the details of the respective business object.
Owner	Indicates who has created the rate option. The valid values are: <ul style="list-style-type: none"> Framework Base Customer Modification

By default, the **Extendable Lookup Value** zone does not appear in the **Extendable Lookup** screen. It appears when you click the **Broadcast** () icon corresponding to the rate option in the **Extendable Lookup Value List** zone.

Related Topics

For more information on...	See...
How to edit a rate option	Editing a Rate Option on page 2504
How to copy a rate option	Copying a Rate Option on page 2507

For more information on...	See...
How to delete a rate option	Deleting a Rate Option on page 2510
How to view the details of a rate option	Viewing the Rate Option Details on page 2510

Defining a Rate Option

Prerequisites

To define a rate option, you should have:

- Rate schedules, currencies, and aggregation schedules defined in the application

Procedure

To define a rate option:

1. Search for the **Rate Option** extendable lookup in the **Extendable Lookup Query** screen.
2. In the **Search Results** section, click the link in the **Description** column corresponding to the extendable lookup business object whose details you want to view.

The **Extendable Lookup** screen appears.

3. Click the **Add** button in the **Page Title** area of the **Extendable Lookup** screen.

The **Rate Option** screen appears. It contains the following section:

- **Main** – Used to specify basic details about the rate option. It contains the following fields:

Field Name	Field Description	Mandatory (Yes or No)
Rate Option	Used to specify the rate option.	Yes
Description	Used to specify the description for the rate option.	Yes
Override Description	Used when you want to override the description of the rate option.	No
Detailed Description	Used to specify additional information about the rate option.	No
Status	Used to indicate the status of the rate option. The valid values are: <ul style="list-style-type: none"> • Active • Inactive 	Yes
	Note: By default, the value is set to Active .	
Rate Schedule	Used to indicate the rate schedule that you want to use while defining the price item pricing. It is the rate schedule which helps the system to create calculation lines for a transaction leg.	Yes
	Note: The Search (🔍) icon appears corresponding to this field. On clicking the Search icon, the Rate Schedule Search window appears.	
Pricing Currency	Used to indicate the currency in which you want to define the price item pricing.	Yes

Field Name	Field Description	Mandatory (Yes or No)
Print Zero	Used to indicate whether zero pricing should be displayed in the bill. The valid values are: <ul style="list-style-type: none"> • Yes • No 	Yes
	Note: By default, the value is set to Yes .	
Ignore Transaction	Used to indicate whether the transactions mapped to the price item should be ignored for billing. The valid values are: <ul style="list-style-type: none"> • Yes • No 	Yes
	Note: By default, the value is set to No .	
Aggregate Transaction	Used to indicate whether the transactions mapped to the price item should be aggregated for billing. The valid values are: <ul style="list-style-type: none"> • Yes • No 	Yes
	Note: By default, the value is set to No . This field is disabled when the Ignore Transaction field is set to Yes .	
Aggregation Schedule	Used to indicate the aggregation schedule using which the transactions should be aggregated for billing.	Yes (Conditional)
	Note: This field is disabled when the Ignore Transaction field is set to Yes .	

Field Name	Field Description	Mandatory (Yes or No)
Transaction Rating Criteria	<p>Used to indicate how and when you want to rate the transaction legs which are mapped to the price item. The valid values are:</p> <ul style="list-style-type: none"> Aggregate Transactions and Then Rate SQs <p>Note: This value appears in the list when the Ignore Transaction field is set to No and the Aggregate Transaction field is set to Yes.</p> <ul style="list-style-type: none"> Do Not Rate Transactions Rate Transaction and Aggregate Calc Lines <p>Note: This value appears in the list when the Ignore Transaction field is set to No and the Aggregate Transaction field is set to Yes.</p> <ul style="list-style-type: none"> Rate Transactions <p>Note: This value appears in the list only when the Ignore Transaction field is set to either Yes or No and the Aggregate Transaction field is set to No.</p> <p>Note: By default, the value is set to Do Not Rate Transactions.</p>	Yes
Apply To	<p>Used to indicate whether you want the price item pricing to be applied to all customers or only to the new customers. The valid values are:</p> <ul style="list-style-type: none"> All Customers New Customers <p>Note: By default, the value is set to All Customers.</p>	Yes

4. Enter the required details in the **Main** section.

5. Click **Save**.

The rate option is added in the **C1-ExtLookRefTypeRateOpt** extendable lookup.

Related Topics

For more information on...	See...
How to search for the Rate Option extendable lookup	Searching for the Rate Option Extendable Lookup on page 2498
Extendable Lookup screen	Extendable Lookup (Rate Option) on page 2499

Editing a Rate Option

Prerequisites

To edit a rate option, you should have:

- Rate schedules, currencies, and aggregation schedules defined in the application

Procedure

To edit a rate option:

1. Search for the **Rate Option** extendable lookup in the **Extendable Lookup Query** screen.
2. In the **Search Results** section, click the link in the **Description** column corresponding to the extendable lookup business object whose details you want to view.

The **Extendable Lookup** screen appears.

3. In the **Extendable Lookup Value List** zone, click the **Edit**  icon in the **Edit** column corresponding to the rate option whose details you want to edit.

The **Rate Option** screen appears. It contains the following section:

- **Main** – Used to specify basic details about the rate option. It contains the following fields:

Field Name	Field Description	Mandatory (Yes or No)
Rate Option	Displays the rate option.	Not applicable
Description	Used to specify the description for the rate option.	Yes
Override Description	Used when you want to override the description of the rate option.	No
Detailed Description	Used to specify additional information about the rate option.	No
Status	Used to indicate the status of the rate option. The valid values are: <ul style="list-style-type: none"> • Active • Inactive 	Yes
Owner	Indicates who has created the rate option. The valid values are: <ul style="list-style-type: none"> • Framework • Base • Customer Modification 	Not applicable
Rate Schedule	Used to indicate the rate schedule that you want to use while defining the price item pricing. It is the rate schedule which helps the system to create calculation lines for a transaction leg. <div style="border: 1px solid black; padding: 5px; margin-top: 10px;"> <p>Note: The Search  icon appears corresponding to this field. On clicking the Search icon, the Rate Schedule Search window appears.</p> </div>	Yes
Pricing Currency	Used to indicate the currency in which you want to define the price item pricing.	Yes
Print Zero	Used to indicate whether zero pricing should be displayed in the bill. The valid values are: <ul style="list-style-type: none"> • Yes • No 	Yes

Field Name	Field Description	Mandatory (Yes or No)
Ignore Transaction	Used to indicate whether the transactions mapped to the price item should be ignored for billing. The valid values are: <ul style="list-style-type: none"> • Yes • No 	Yes
Aggregate Transaction	Used to indicate whether the transactions mapped to the price item should be aggregated for billing. The valid values are: <ul style="list-style-type: none"> • Yes • No 	Yes
	Note: This field is disabled when the Ignore Transaction field is set to Yes .	
Aggregation Schedule	Used to indicate the aggregation schedule using which the transactions should be aggregated for billing.	Yes (Conditional)
	Note: This field is disabled when the Ignore Transaction field is set to Yes .	
Transaction Rating Criteria	Used to indicate how and when you want to rate the transaction legs which are mapped to the price item. The valid values are: <ul style="list-style-type: none"> • Aggregate Transactions and Then Rate SQs 	Yes
	Note: This value appears in the list when the Ignore Transaction field is set to No and the Aggregate Transaction field is set to Yes .	
	<ul style="list-style-type: none"> • Do Not Rate Transactions • Rate Transaction and Aggregate Calc Lines 	
	Note: This value appears in the list when the Ignore Transaction field is set to No and the Aggregate Transaction field is set to Yes .	
	<ul style="list-style-type: none"> • Rate Transactions 	
	Note: This value appears in the list only when the Ignore Transaction field is set to either Yes or No and the Aggregate Transaction field is set to No .	

Field Name	Field Description	Mandatory (Yes or No)
Apply To	Used to indicate whether you want the price item pricing to be applied to all customers or only to the new customers. The valid values are: <ul style="list-style-type: none"> All Customers New Customers 	Yes

Tip: Alternatively, you can edit the details of a rate option by clicking the **Edit** button in the **Extendable Lookup Value** zone.

- Modify the required details in the **Main** section.
- Click **Save**.

The changes made to the rate option are saved.

Related Topics

For more information on...	See...
How to search for the Rate Option extendable lookup	Searching for the Rate Option Extendable Lookup on page 2498
Extendable Lookup screen	Extendable Lookup (Rate Option) on page 2499
Extendable Lookup Value List zone	Extendable Lookup Value List on page 2499
Extendable Lookup Value zone	Extendable Lookup Value on page 2500

Copying a Rate Option

Instead of creating a rate option from scratch, you can create a new rate option using an existing rate option. This is possible through copying a rate option. On copying a rate option, the pricing and transaction aggregation details are copied to the new rate option. You can then edit the details, if required.

Prerequisites

To copy a rate option, you should have:

- Rate option (whose copy you want to create) defined in the application
- Rate schedules, currencies, and aggregation schedules defined in the application

Procedure

To copy a rate option:

- Search for the **Rate Option** extendable lookup in the **Extendable Lookup Query** screen.
- In the **Search Results** section, click the link in the **Description** column corresponding to the extendable lookup business object whose details you want to view.

The **Extendable Lookup** screen appears.

- In the **Extendable Lookup Value List** zone, click the **Duplicate** () icon in the **Duplicate** column corresponding to the rate option whose copy you want to create.

The **Rate Option** screen appears. It contains the following section:

- Main** – Used to specify basic details about the rate option. It contains the following fields:

Field Name	Field Description	Mandatory (Yes or No)
Rate Option	Used to specify the rate option.	Yes
Description	Used to specify the description for the rate option.	Yes
Override Description	Used when you want to override the description of the rate option.	No
Detailed Description	Used to specify additional information about the rate option.	No
Status	Used to indicate the status of the rate option. The valid values are: <ul style="list-style-type: none"> Active Inactive 	Yes
Rate Schedule	Used to indicate the rate schedule that you want to use while defining the price item pricing. It is the rate schedule which helps the system to create calculation lines for a transaction leg. <div style="border: 1px solid black; padding: 5px; margin-top: 10px;"> <p>Note: The Search (🔍) icon appears corresponding to this field. On clicking the Search icon, the Rate Schedule Search window appears.</p> </div>	Yes
Pricing Currency	Used to indicate the currency in which you want to define the price item pricing.	Yes
Print Zero	Used to indicate whether zero pricing should be displayed in the bill. The valid values are: <ul style="list-style-type: none"> Yes No 	Yes
Ignore Transaction	Used to indicate whether the transactions mapped to the price item should be ignored for billing. The valid values are: <ul style="list-style-type: none"> Yes No 	Yes
Aggregate Transaction	Used to indicate whether the transactions mapped to the price item should be aggregated for billing. The valid values are: <ul style="list-style-type: none"> Yes No <div style="border: 1px solid black; padding: 5px; margin-top: 10px;"> <p>Note: This field is disabled when the Ignore Transaction field is set to Yes.</p> </div>	Yes

Field Name	Field Description	Mandatory (Yes or No)
Aggregation Schedule	Used to indicate the aggregation schedule using which the transactions should be aggregated for billing.	Yes (Conditional)
	Note: This field is disabled when the Ignore Transaction field is set to Yes .	Note: This field is required when the Aggregate Transaction field is set to Yes .
Transaction Rating Criteria	<p>Used to indicate how and when you want to rate the transaction legs which are mapped to the price item. The valid values are:</p> <ul style="list-style-type: none"> Aggregate Transactions and Then Rate SQs <p>Note: This value appears in the list when the Ignore Transaction field is set to No and the Aggregate Transaction field is set to Yes.</p> <ul style="list-style-type: none"> Do Not Rate Transactions Rate Transaction and Aggregate Calc Lines <p>Note: This value appears in the list when the Ignore Transaction field is set to No and the Aggregate Transaction field is set to Yes.</p> <ul style="list-style-type: none"> Rate Transactions <p>Note: This value appears in the list only when the Ignore Transaction field is set to either Yes or No and the Aggregate Transaction field is set to No.</p>	Yes
Apply To	<p>Used to indicate whether you want the price item pricing to be applied to all customers or only to the new customers. The valid values are:</p> <ul style="list-style-type: none"> All Customers New Customers 	Yes

Tip: Alternatively, you can copy a rate option by clicking the **Duplicate** button in the **Extendable Lookup Value** zone.

- Enter the required details in the **Main** section.
- Click **Save**.

The new rate option is added in the **C1-ExtLookRetTypeRateOpt** extendable lookup.

Related Topics

For more information on...	See...
How to search for the Rate Option extendable lookup	Searching for the Rate Option Extendable Lookup on page 2498
Extendable Lookup screen	Extendable Lookup (Rate Option) on page 2499

For more information on...	See...
Extendable Lookup Value List zone	Extendable Lookup Value List on page 2499
Extendable Lookup Value zone	Extendable Lookup Value on page 2500

Deleting a Rate Option

Procedure

To delete a rate option:

1. Search for the **Rate Option** extendable lookup in the **Extendable Lookup Query** screen.
2. In the **Search Results** section, click the link in the **Description** column corresponding to the extendable lookup business object whose details you want to view.
The **Extendable Lookup** screen appears.

3. In the **Extendable Lookup Value List** zone, click the **Delete** (🗑️) icon in the **Delete** column corresponding to the rate option that you want to delete.

A message appears confirming whether you want to delete the rate option.

Note: You can delete a rate option when it is not yet used in a pricing rule type.

Tip: Alternatively, you can delete a rate option by clicking the **Delete** button in the **Extendable Lookup Value** zone.

4. Click **OK**.

The rate option is deleted from the **C1-ExtLookRefTypeRateOpt** extendable lookup.

Related Topics

For more information on...	See...
How to search for the Rate Option extendable lookup	Searching for the Rate Option Extendable Lookup on page 2498
Extendable Lookup screen	Extendable Lookup (Rate Option) on page 2499
Extendable Lookup Value List zone	Extendable Lookup Value List on page 2499
Extendable Lookup Value zone	Extendable Lookup Value on page 2500

Viewing the Rate Option Details

Procedure

To view the details of a rate option:

1. Search for the **Rate Option** extendable lookup in the **Extendable Lookup Query** screen.
2. In the **Search Results** section, click the link in the **Description** column corresponding to the extendable lookup business object whose details you want to view.
The **Extendable Lookup** screen appears.

3. In the **Extendable Lookup Value List** zone, click the **Broadcast** (📡) icon corresponding to the rate option whose details you want to view.
The **Extendable Lookup Value** zone appears.

4. View the details of the rate option in the **Extendable Lookup Value** zone.

Related Topics

For more information on...	See...
How to search for the Rate Option extendable lookup	Searching for the Rate Option Extendable Lookup on page 2498
Extendable Lookup screen	Extendable Lookup (Rate Option) on page 2499
Extendable Lookup Value List zone	Extendable Lookup Value List on page 2499
Extendable Lookup Value zone	Extendable Lookup Value on page 2500

Rate Type Extendable Lookup

A new extendable lookup for rate type named **C1-ExtLookRateType** is introduced in the system. A rate type extendable lookup enables you to specify the following:

- Whether the system should calculate fees on sum of all applicable claim charges or separately for each applicable claim charge.
- The billable charge line type using which the calculation line should be created when the fee is calculated on sum of all applicable claim charges
- Whether the system should calculate percentage based markup or markdown on sum of all eligible claim charges or separately for each eligible claim charge
- The billable charge line type using which the calculation line should be created when the minimum and maximum markup or markdown is calculated on sum of all eligible claim charges
- Whether the rate type can be used while adding fees, default markup or markdown, or claim line items

Following rate types are used in the system:

- Maximum Fee
- Minimum Fee
- Retained Percentage
- Minimum Markup or Markdown
- Maximum Markup or Markdown
- Minimum Amount
- Maximum Amount

The **Extendable Lookup Query** screen allows you to search for an extendable lookup. It contains the following zone:

- [Extendable Lookup Search](#) on page 2511

Extendable Lookup Search

The **Extendable Lookup Search** zone allows you to search for an extendable lookup. It contains the following two sections:

- **Search Criteria** – The **Search Criteria** section contains the following fields:

Field Name	Field Description	Mandatory (Yes or No)
Business Object	Used to search a particular extendable lookup business object.	No

Field Name	Field Description	Mandatory (Yes or No)
Description	Used to search extendable lookups with a particular description.	No

Note: You must specify at least one search criterion while searching for an extendable lookup.

- **Search Results** – On clicking the **Search** button, the search results appear based on the specified search criteria. The **Search Results** section contains the following columns:

Column Name	Column Description
Business Object	Displays the extendable lookup business object.
Description	Displays the description of the extendable lookup business object.
	Note: It has a link. On clicking the link, the Extendable Lookup screen appears where you can view the details of the respective extendable lookup.

Related Topics

For more information on...	See...
How to search for the Rate Type extendable lookup	Searching for the Rate Type Extendable Lookup on page 2512
How to view the values of the Rate Type extendable lookup	Viewing the Values of the Rate Type Extendable Lookup on page 2513

Searching for the Rate Type Extendable Lookup

Procedure

To search for the **Rate Type** extendable lookup:

1. Click the **Admin** link in the **Application** toolbar.
A list appears.
2. From the **Admin** menu, select **E** and then click **Extendable Lookup**.
The **Extendable Lookup Query** screen appears.
3. In the **Extendable Lookup Search** zone, enter **C1-ExtLookRateType** in the **Business Object** field.

Note: ORMB search engine supports wildcard search, where you can substitute the percentage (%) symbol as a stand in for any word or letter in a search criteria. You can use the ‘%’ wildcard character in all input fields except the date and ID fields. The ‘%’ wildcard character is suffixed automatically at the end of the partial search criteria. Therefore, you may or may not specify the wildcard character at the end of the partial search criteria. However, you have to prefix the wildcard character manually wherever required.

4. Click **Search**.
The **Rate Type** extendable lookup business object appears in the **Search Results** section.

Related Topics

For more information on...	See...
Extendable Lookup Query screen	Rate Type Extendable Lookup on page 2511
Extendable Lookup Search zone	Extendable Lookup Search on page 2511

Viewing the Values of the Rate Type Extendable Lookup

Procedure

To view the values of the **Rate Type** extendable lookup:

1. Search for the **Rate Type** extendable lookup in the **Extendable Lookup Query** screen.
2. In the **Search Results** section, click the link in the **Description** column corresponding to the extendable lookup business object whose details you want to view.
The **Extendable Lookup** screen appears.
3. View the values of the **Rate Type** extendable lookup in the **Extendable Lookup Value List** zone.

Related Topics

For more information on...	See...
How to search for the Rate Type extendable lookup	Searching for the Rate Type Extendable Lookup on page 2512
Extendable Lookup screen	Extendable Lookup (Rate Type) on page 2513
Extendable Lookup Value List zone	Extendable Lookup Value List on page 2513



Extendable Lookup (Rate Type)

The **Extendable Lookup** screen allows you to view the values of the **Rate Type (C1-ExtLookRateType)** extendable lookup. It also allows you to define, edit, copy, and delete a rate type. It contains the following zones:

- [Extendable Lookup Value List](#) on page 2499
- [Extendable Lookup Value](#) on page 2500

Extendable Lookup Value List

The **Extendable Lookup Value List** zone lists the values which are already defined for the **Rate Type** extendable lookup. It contains the following columns:

Column Name	Column Description
Value	Displays the rate type.
Description	Displays the description of the rate type.
Owner	Indicates the user who has created the rate type. The valid values are: <ul style="list-style-type: none"> • Framework • Base • Customer Modification
Edit	On clicking the Edit () icon, the Rate Type screen appears where you can edit the details of the rate type.
Duplicate	On clicking the Duplicate () icon, the Rate Type screen appears where you can define a rate type item using an existing rate type.

Column Name	Column Description
Delete	On clicking the Delete (🗑️) icon, you can delete the rate type.
	Note: You can delete a rate type when it is not yet used in a pricing rule type.
Detailed Description	Displays additional information about the rate type.

Note: Pagination is used to display limited number of records in this zone. You can use the navigation buttons, such as **Previous** and **Next** to navigate between pages.

On clicking the **Broadcast** (📡) icon corresponding to a rate type, the **Extendable Lookup Value** zone appears with the details of the respective rate type.

You can filter the list using various search criteria (such as, **Value** and **Description**) available in the **Filter** area. By default, the **Filter** area is hidden. You can view the **Filter** area by clicking the **Filters** (🔍) icon in the upper right corner of this zone.

Related Topics

For more information on...	See...
How to edit a rate type	Editing a Rate Type on page 2517
How to copy a rate type	Copying a Rate Type on page 2519
How to delete a rate type	Deleting a Rate Type on page 2521
How to view the details of a rate type	Viewing the Rate Type Details on page 2521

Extendable Lookup Value

The **Extendable Lookup Value** zone displays the details of the rate type. It contains the following sections:

- **Main** – Displays basic information about the rate type. It contains the following fields:

Field Name	Field Description
Rate Type	Displays the rate type.
Description	Displays the description for the rate type.
Override Description	Displays the overridden description of the rate type.
Detailed Description	Displays the additional information about the rate type.
Status	Indicates the status of the rate type. The valid values are: <ul style="list-style-type: none"> • Active • Inactive
Line-Specific Calculation	Indicates whether the calculation of fees, percentage, or markup and markdown should take place for each and every claim charge or not. The valid values are: <ul style="list-style-type: none"> • Yes • No
Billable Charge Line Type	Indicates the billable charge line type using which the calculation line is created for the charge.

Rate Type Usage – Lists the various charges to which the rate type is associated. It contains the following column in a grid:

Column Name	Column Description
Applicable To	Indicates the claim handling fees that are associated with the rate type.

- **Record Actions** – This section contains the following buttons:

Button Name	Button Description
Edit	Used to edit the details of the rate type.
Delete	Used to delete the rate type. Note: You can delete a rate type when it is not yet used in a pricing rule type.
Duplicate	Used to create a new rate type using an existing line item.

- **Record Information** – This section contains the following fields:

Field Name	Field Description
Business Object	Indicates the extendable lookup business object using which the rate type is created. In addition, a context menu appears corresponding to this field which helps in navigating to other screens in the application. Note: It has a link. On clicking the link, the Business Object screen appears where you can view the details of the respective business object.
Owner	Indicates who has created the line item. The valid values are: <ul style="list-style-type: none"> • Framework • Base • Customer Modification

By default, the **Extendable Lookup Value** zone does not appear in the **Extendable Lookup** screen. It appears when you click the **Broadcast** () icon corresponding to the line item in the **Extendable Lookup Value List** zone.

Related Topics

For more information on...	See...
How to edit a rate type	Editing a Rate Type on page 2517
How to copy a rate type	Copying a Rate Type on page 2519
How to delete a rate type	Deleting a Rate Type on page 2521
How to view the details of a rate type	Viewing the Rate Type Details on page 2521

Defining a Rate Type

Prerequisites

To define a rate type, you should have:

- Billable charge line type and rate types defined in the application.

Procedure

To define a rate type:

1. Search for the **Rate Type** extendable lookup in the **Extendable Lookup Query** screen.
2. In the **Search Results** section, click the link in the **Description** column corresponding to the extendable lookup business object whose details you want to view.

The **Extendable Lookup** screen appears.

3. Click the **Add** button in the **Page Title** area of the **Extendable Lookup** screen.

The **Rate Type** screen appears. It contains the following section:

- **Main** – Used to specify basic details about the rate type. It contains the following fields:

Field Name	Field Description	Mandatory (Yes or No)
Rate Type	Used to specify the rate type.	Yes
Description	Used to specify the description for the rate type.	Yes
Override Description	Used when you want to override the description of the rate type.	No
Detailed Description	Used to specify additional information about the rate type.	No
Status	Used to indicate the status of the rate type. The valid values are: <ul style="list-style-type: none"> • Active • Inactive 	No
	Note: By default, the value is set to Active .	
Line-Specific Calculation	Used to indicate whether the calculation of fees, percentage, or markup and markdown should take place for each and every claim charge or not. The valid values are: <ul style="list-style-type: none"> • Yes • No 	Yes
Billable Charge Line Type	Used to indicate the billable charge line type using which you want to create the calculation line for the charge (i.e. line item).	No
	Note: The Search (🔍) icon appears corresponding to the Billable Charge Line Type field. On clicking the Search icon, the Billable Charge Line Type Search window appears. On specifying the value for a billable charge line type, the description of the billable charge line type appears corresponding to the Billable Charge Line Type field.	

- **Rate Type Usage** – Used to specify the usage of a rate type. It contains the following fields:

Field Name	Field Description	Mandatory (Yes or No)
Applicable To	Used to indicate whether the rate type can be used while adding fees, default markup or markdown, or claim line items. The valid values are: <ul style="list-style-type: none"> • Claim Handling Fees • Claim Line Items • Markup or Markdown 	Yes

4. Enter the required details in the **Main** section.
5. Select the required rate type usage (for the rate type) from the **Rate Type Usage** section.
6. If you want to define more than one rate type usage for the rate type, click the **Add (+)** icon and then repeat step 5.

Note: However, if you want to remove a rate type usage from the rate type, click the **Delete** (🗑️) icon corresponding to the **Applicable To** field.

7. Click **Save**.

The rate type is added in the **C1-ExtLookRateType** extendable lookup.

Related Topics

For more information on...	See...
How to search for the Rate Type extendable lookup	Searching for the Rate Type Extendable Lookup on page 2512
Extendable Lookup screen	Extendable Lookup (Rate Type) on page 2513

Editing a Rate Type

Prerequisites

To edit a rate type, you should have:

- Billable charge line type and rate type usage defined in the application.

Procedure

To edit a rate type:

1. Search for the **Rate Type** extendable lookup in the **Extendable Lookup Query** screen.
2. In the **Search Results** section, click the link in the **Description** column corresponding to the extendable lookup business object whose details you want to view.

The **Extendable Lookup** screen appears.

3. In the **Extendable Lookup Value List** zone, click the **Edit** (✎) icon in the **Edit** column corresponding to the rate type whose details you want to edit.

The **Rate Type** screen appears. It contains the following section:

- **Main** – Used to specify basic details about the rate type. It contains the following fields:

Field Name	Field Description	Mandatory (Yes or No)
Rate Type	Displays the rate type.	Not applicable
Description	Used to specify the description for the rate type.	Yes
Override Description	Used when you want to override the description of the rate type.	No
Detailed Description	Used to specify additional information about the rate type.	No
Status	Used to indicate the status of the rate type. The valid values are: <ul style="list-style-type: none"> Active Inactive 	No
Line-Specific Calculation	Used to indicate whether the calculation of fees, percentage, or markup and markdown should take place for each and every claim charge or not. The valid values are: <ul style="list-style-type: none"> Yes No 	Yes
Billable Charge Line Type	Used to indicate the billable charge line type using which you want to create the calculation line for the charge (i.e. line item). <p>Note:</p> <p>The Search (🔍) icon appears corresponding to the Billable Charge Line Type field. On clicking the Search icon, the Billable Charge Line Type Search window appears.</p> <p>On specifying the value for a billable charge line type, the description of the billable charge line type appears corresponding to the Billable Charge Line Type field.</p>	No

- **Rate Type Usage** – Used to specify the usage of a rate type. It contains the following fields:

Field Name	Field Description	Mandatory (Yes or No)
Applicable To	Used to indicate whether the rate type can be used while adding fees, default markup or markdown, or claim line items. The valid values are: <ul style="list-style-type: none"> Claim Handling Fees Claim Line Items Markup or Markdown 	Yes

Tip: Alternatively, you can edit the details of a rate type by clicking the **Edit** button in the **Extendable Lookup Value** zone.

4. Modify the required details in the **Main** section, if required.
5. Add, edit, or remove usage (for the rate type) from the **Usage** section, if required.
6. If you want to define more than one rate type usage for the rate type, click the **Add (+)** icon and then repeat step 5.

Note: However, if you want to remove a rate type usage from the rate type, click the **Delete** (🗑️) icon corresponding to the **Applicable To** field.

7. Click **Save**.

The changes made to the rate type are saved.

Related Topics

For more information on...	See...
How to search for the Rate Type extendable lookup	Searching for the Rate Type Extendable Lookup on page 2512
Extendable Lookup screen	Extendable Lookup (Rate Type) on page 2513
Extendable Lookup Value List zone	Extendable Lookup Value List on page 2513
Extendable Lookup Value zone	Extendable Lookup Value on page 2514

Copying a Rate Type

Instead of creating a rate type from scratch, you can create a new rate type using an existing rate type. This is possible through copying a rate type. On copying a rate type, the line specific calculation, billable charge type, and usage detailed are copied to the new rate type. You can then edit the details, if required.

Prerequisites

To copy a rate type, you should have:

- Rate type (whose copy you want to create) defined in the application.
- Billable charge line type and rate type usage defined in the application.

Procedure

To copy a rate type:

1. Search for the **Rate Type** extendable lookup in the **Extendable Lookup Query** screen.
2. In the **Search Results** section, click the link in the **Description** column corresponding to the extendable lookup business object whose details you want to view.

The **Extendable Lookup** screen appears.

3. In the **Extendable Lookup Value List** zone, click the **Duplicate** (📄) icon in the **Duplicate** column corresponding to the rate type whose copy you want to create.

The **Rate Type** screen appears. It contains the following section:

- **Main** – Used to specify basic details about the rate type. It contains the following fields:

Field Name	Field Description	Mandatory (Yes or No)
Rate Type	Used to specify the rate type.	Yes
Description	Used to specify the description for the rate type.	Yes

Field Name	Field Description	Mandatory (Yes or No)
Override Description	Used when you want to override the description of the rate type.	No
Detailed Description	Used to specify additional information about the rate type.	No
Status	Used to indicate the status of the rate type. The valid values are: <ul style="list-style-type: none"> Active Inactive 	No
Line-Specific Calculation	Used to indicate whether the calculation of fees, percentage, or markup and markdown should take place for each and every claim charge or not. The valid values are: <ul style="list-style-type: none"> Yes No 	Yes
Billable Charge Line Type	Used to indicate the billable charge line type using which you want to create the calculation line for the charge (i.e. line item). <p>Note:</p> <p>The Search (🔍) icon appears corresponding to the Billable Charge Line Type field. On clicking the Search icon, the Billable Charge Line Type Search window appears.</p> <p>On specifying the value for a billable charge line type, the description of the billable charge line type appears corresponding to the Billable Charge Line Type field.</p>	No

- **Rate Type Usage** – Used to specify the usage of a rate type. It contains the following fields:

Field Name	Field Description	Mandatory (Yes or No)
Applicable To	Used to indicate whether the rate type can be used while adding fees, default markup or markdown, or claim line items.	Yes

Tip: Alternatively, you can copy a rate type by clicking the **Duplicate** button in the **Extendable Lookup Value** zone.

4. Enter the required details in the **Main** section, if required.
5. Select the required rate type usage (for the rate type) from the **Rate Type Usage** section.
6. If you want to define more than one rate type usage for the rate type, click the **Add** (+) icon and then repeat step 5.

Note: However, if you want to remove a rate type usage from the rate type, click the **Delete** (🗑️) icon corresponding to the **Applicable To** field.

7. Click **Save**.

The new rate type is added in the **C1-ExtLookRateType** extendable lookup.

Related Topics

For more information on...	See...
How to search for the Rate Type extendable lookup	Searching for the Rate Type Extendable Lookup on page 2512
Extendable Lookup screen	Extendable Lookup (Rate Type) on page 2513
Extendable Lookup Value List zone	Extendable Lookup Value List on page 2513
Extendable Lookup Value zone	Extendable Lookup Value on page 2514

Deleting a Rate Type

Procedure

To delete a rate type:

1. Search for the **Rate Type** extendable lookup in the **Extendable Lookup Query** screen.
2. In the **Search Results** section, click the link in the **Description** column corresponding to the extendable lookup business object whose details you want to view.

The **Extendable Lookup** screen appears.

3. In the **Extendable Lookup Value List** zone, click the **Delete** (🗑️) icon in the **Delete** column corresponding to the rate type that you want to delete.

A message appears confirming whether you want to delete the rate type.

Note: You can delete a rate type when it is not yet used in a pricing rule type.

Tip: Alternatively, you can delete a rate type by clicking the **Delete** button in the **Extendable Lookup Value** zone.

4. Click **OK**.

The rate type is deleted from the **C1-ExtLookRateType** extendable lookup.

Related Topics

For more information on...	See...
How to search for the Rate Type extendable lookup	Searching for the Rate Type Extendable Lookup on page 2512
Extendable Lookup screen	Extendable Lookup (Rate Type) on page 2513
Extendable Lookup Value List zone	Extendable Lookup Value List on page 2513
Extendable Lookup Value zone	Extendable Lookup Value on page 2514

Viewing the Rate Type Details

Procedure

To view the details of a rate type:

1. Search for the **Rate Option** extendable lookup in the **Extendable Lookup Query** screen.

- In the **Search Results** section, click the link in the **Description** column corresponding to the extendable lookup business object whose details you want to view.

The **Extendable Lookup** screen appears.

- In the **Extendable Lookup Value List** zone, click the **Broadcast** (📡) icon corresponding to the rate option whose details you want to view.

The **Extendable Lookup Value** zone appears.

- View the details of the rate type in the **Extendable Lookup Value** zone.

Related Topics

For more information on...	See...
How to search for the Rate Type extendable lookup	Searching for the Rate Type Extendable Lookup on page 2512
Extendable Lookup screen	Extendable Lookup (Rate Type) on page 2513
Extendable Lookup Value List zone	Extendable Lookup Value List on page 2513
Extendable Lookup Value zone	Extendable Lookup Value on page 2514

Pricing Group

Oracle Revenue Management and Billing enables you to create pricing groups for a bill group. It consists of one or more rules. Each rule has a unique priority. A rule contains one or more criteria. Each criterion can contain the following:

- **Source System** - Indicates the external system from where the claim or enrollment transaction is received.
- **Parameter 1, Parameter 2, Parameter 3, and Parameter 4** - Indicates employee attributes based on which you want to define the pricing.

Note that the source system and parameter 1 are mandatory when you are defining a criterion in a rule. In the **Parameter 1** field, you can only specify the employee attribute which is defined for the bill group and source system combination in the **Bill Group Derivation and Pricing Parameters** zone.

You can specify multiple parameter 2, parameter 3, and parameter 4 combinations in the criterion. You can also specify multiple source system, parameter 1, parameter 2, parameter 3, and parameter 4 combinations (i.e. multiple criteria) in a rule. Once a pricing group is defined for a bill group, you can then use the pricing group while defining a pricing rule for the bill group. This enables you to define various rates for employees with different set of attributes. For example, in a claim pricing rule, you can maintain different markup and markdown values for employees who belong to the Western, Eastern, and Central location of United States.

You can define, edit, copy, and delete a pricing group through the **Bill Group Pricing Groups** zone in the **Pricing** tab of the **Customer 360° Information** screen.

Viewing the Pricing Groups of a Bill Group

Procedure

To view the pricing groups of a bill group:

- Search for the bill group whose is associated with the self-funded policy in the **Customer 360° View** screen.
- In the **Search Results** section, click the **View** (🔍) icon corresponding to the bill group whose details you want to view.

The **Person** tab appears in the **Customer 360° Information** screen.

- Click the **Pricing Information** tab.

The **Pricing Information** tab appears.

- In the **Bill Group Self-Funded Policy Information** zone, click the **Broadcast** (📡) icon corresponding to a bill group whose pricing groups you want to view.

The **Bill Group Self-Funded Policy Pricing Rules** and **Bill Group Pricing Groups** zones appear.

- View the pricing groups which are defined for the bill group and are currently active in the **Bill Group Pricing Groups** zone.

Related Topics

For more information on...	See...
How to search for a person	Searching for a Person on page 648
Customer 360° Information screen	Customer 360° Information on page 659
Pricing Information tab	Customer 360° Information - Pricing Information on page 693
Bill Group Self-Funded Policy Information zone	Bill Group Self-Funded Policy Information on page 701
Bill Group Pricing Groups zone	Bill Group Pricing Groups on page 707

Defining a Pricing Group for a Bill Group

Prerequisites

To define a pricing group for a bill group, you should have:

- Values defined for the **C1-SourceSystemLookup** extendable lookup

Procedure

To define a pricing group for a bill group:

- Search for the Administrative Services Only (ASO) person in the **Customer 360° View** screen.
- In the **Search Results** section, click the **View** (🔗) icon corresponding to the person whose details you want to view.

The **Person** tab in the **Customer 360° Information** screen appears.

- Click the **Pricing** tab.

The **Pricing** tab appears.

- In the **Bill Group ASO Policy Information** zone, click the **Broadcast** (📡) icon corresponding to a bill group for whom you want to define a pricing group.

The **Bill Group ASO Policy Pricing Rules** and **Bill Group Pricing Groups** zones appear.

- Click the **Add** link in the upper right corner of the **Bill Group Pricing Groups** zone.

The **Pricing Group** screen appears. It contains the following sections:

- Main** – Used to specify basic details about the pricing group. It contains the following fields:

Field Name	Field Description	Mandatory (Yes or No)
Bill Group Information	Indicates the bill group for whom you want to define the pricing group.	Not applicable

Field Name	Field Description	Mandatory (Yes or No)
Status	Used to indicate the status of the pricing group. The valid values are: <ul style="list-style-type: none"> Active Inactive 	Yes
Description	Used to specify the description for the pricing group.	Yes

- **Pricing Group Rules** – Used to define rules in the pricing group. It contains the following fields in a grid:

Field Name	Field Description	Mandatory (Yes or No)
Priority	Used to indicate the order in which the rule should be executed while determining the pricing for the price item. Note: You cannot define multiple rules in the pricing group with the same priority.	Yes
Rule	Used to specify the rule in the pricing group.	Yes
Description	Used to specify the description for the pricing group rule.	Yes
Criteria	On clicking the Add  icon, you can define criteria for the pricing group rule.	Not applicable

6. Enter the required details in the **Main** section.
7. Define the required rules in the **Pricing Group Rules** section.
8. Click the **Add**  icon in the **Criteria** field corresponding to the pricing group rule for which you want to define the criteria.

The following fields appear in another grid:

Field Name	Field Description	Mandatory (Yes or No)
Source System	Used to indicate the external system from where the claim or enrollment transaction is received.	Yes
Parameter 1	Used to specify the employee attribute based on which you want to define the pricing. Note: You can only specify the employee attribute which is defined for the bill group and source system combination in the Bill Group Derivation and Pricing Parameters zone. You must not specify the ampersand (&) character in this field. The Search  icon appears corresponding to this field. On clicking the Search icon, the Parameter 1 List for Bill Group window appears.	Yes

Field Name	Field Description	Mandatory (Yes or No)
Parameter 2	Used to specify the employee attribute based on which you want to define the pricing.	No
	Note: You must not specify the ampersand (&) character in this field.	
Parameter 3	Used to specify the employee attribute based on which you want to define the pricing.	No
	Note: You must not specify the ampersand (&) character in this field.	
Parameter 4	Used to specify the employee attribute based on which you want to define the pricing.	No
	Note: You must not specify the ampersand (&) character in this field.	

9. Enter the source system and parameter 1 in the pricing group rule criteria.

Note: You must define at least one rule in the pricing group and at least one source system and parameter 1 combination in the pricing group rule.

10. If required, enter the parameter 2, parameter 3, and parameter 4 for the source system and parameter 1 combination in the pricing group rule criteria.

11. If you want to define more than one parameter 2, parameter 3, and parameter 4 for the source system and parameter 1 combination, click the **Add (+)** icon corresponding to the **Parameter 2** field and then repeat step 10.

Note: However, if you want to remove a parameter 2, parameter 3, and parameter 4 from the source system and parameter 1 combination, click the **Delete (🗑)** icon corresponding to the parameter 2, parameter 3, and parameter 4.

12. If you want to define more than one source system and parameter 1 combination in the pricing group rule, click the **Add (+)** icon corresponding to the **Source System** field and then repeat step 9 and 10.

Note: However, if you want to remove a source system and parameter 1 combination from the pricing group rule, click the **Delete (🗑)** icon corresponding to the combination.

13. If you want to define more than one rule in the pricing group, click the **Add (+)** icon corresponding to the **Priority** field and then repeat the steps from 7 to 10.

Note: However, if you want to remove a rule from the pricing group, click the **Delete (🗑)** icon corresponding to the pricing group rule.

14. Click **Save**.

The pricing group is defined for the bill group.

Related Topics

For more information on...	See...
How to search for a person	Searching for a Person on page 648
Customer 360° Information screen	Customer 360° Information on page 659

For more information on...	See...
Pricing tab	Customer 360° Information - Pricing Information on page 693
Bill Group ASO Policy Information zone	Bill Group Self-Funded Policy Information on page 701
Bill Group Pricing Groups zone	Bill Group Pricing Groups on page 707
Bill Group Derivation and Pricing Parameters zone	Bill Group Derivation and Pricing Parameters on page 671

Editing a Pricing Group of a Bill Group

Prerequisites

To edit a pricing group of a bill group, you should have:

- Values defined for the **C1-SourceSystemLookup** extendable lookup

Procedure

To edit a pricing group of a bill group:

1. Search for the Administrative Services Only (ASO) person in the **Customer 360° View** screen.
2. In the **Search Results** section, click the **View** () icon corresponding to the person whose details you want to view.

The **Person** tab in the **Customer 360° Information** screen appears.

3. Click the **Pricing** tab.

The **Pricing** tab appears.

4. In the **Bill Group ASO Policy Information** zone, click the **Broadcast** () icon corresponding to a bill group whose pricing group you want to edit.

The **Bill Group ASO Policy Pricing Rules** and **Bill Group Pricing Groups** zones appear.

5. In the **Bill Group Pricing Groups** zone, click the **Edit** () icon in the **Edit** column corresponding to the pricing group whose details you want to edit.

The **Pricing Group** screen appears. It contains the following sections:

- **Main** – Used to specify basic details about the pricing group. It contains the following fields:

Field Name	Field Description	Mandatory (Yes or No)
Bill Group Information	Indicates the bill group for whom you want to define the pricing group.	Not applicable
Status	Used to indicate the status of the pricing group. The valid values are: <ul style="list-style-type: none"> • Active • Inactive 	Yes
Description	Used to specify the description for the pricing group.	Yes

- **Pricing Group Rules** – Used to define rules in the pricing group. It contains the following fields in a grid:

Field Name	Field Description	Mandatory (Yes or No)
Priority	Used to indicate the order in which the rule should be executed while determining the pricing for the price item.	Yes
	Note: You cannot define multiple rules in the pricing group with the same priority.	
Rule	Used to specify the rule in the pricing group.	Yes
Description	Used to specify the description for the pricing group rule.	Yes
Criteria	On clicking the Add  icon, you can define criteria for the pricing group rule.	Not applicable

Note: You cannot define, edit, or remove a rule when the pricing group is already used while defining a pricing rule for the bill group.

6. Modify the required details in the **Main** section.
7. Edit the required rules in the **Pricing Group Rules** section.
8. Click the **Add**  icon in the **Criteria** field corresponding to the pricing group rule for which you want to edit the criteria.

The following fields appear in another grid:

Field Name	Field Description	Mandatory (Yes or No)
Source System	Used to indicate the external system from where the claim or enrollment transaction is received.	Yes
Parameter 1	Used to specify the employee attribute based on which you want to define the pricing.	Yes
	<p>Note:</p> <p>You can only specify the employee attribute which is defined for the bill group and source system combination in the Bill Group Derivation and Pricing Parameters zone.</p> <p>You must not specify the ampersand (&) character in this field.</p> <p>The Search  icon appears corresponding to this field. On clicking the Search icon, the Parameter 1 List for Bill Group window appears.</p>	
Parameter 2	Used to specify the employee attribute based on which you want to define the pricing.	No
	Note: You must not specify the ampersand (&) character in this field.	

Field Name	Field Description	Mandatory (Yes or No)
Parameter 3	Used to specify the employee attribute based on which you want to define the pricing.	No
	Note: You must not specify the ampersand (&) character in this field.	
Parameter 4	Used to specify the employee attribute based on which you want to define the pricing.	No
	Note: You must not specify the ampersand (&) character in this field.	

Note: You cannot define, edit, or remove the source system, parameter 1, parameter 2, parameter 3, and parameter 4 from a rule when the pricing group is already used while defining a pricing rule for the bill group.

9. If required, enter the source system and parameter 1 in the pricing group rule criteria.

Note: You must define at least one rule in the pricing group and at least one source system and parameter 1 combination in the pricing group rule.

10. If required, enter the parameter 2, parameter 3, and parameter 4 for the source system and parameter 1 combination in the pricing group rule criteria.

11. If you want to define more than one parameter 2, parameter 3, and parameter 4 for the source system and parameter 1 combination, click the **Add (+)** icon corresponding to the **Parameter 2** field and then repeat step 10.

Note: However, if you want to remove a parameter 2, parameter 3, and parameter 4 from the source system and parameter 1 combination, click the **Delete (🗑)** icon corresponding to the parameter 2, parameter 3, and parameter 4.

12. If you want to define more than one source system and parameter 1 combination in the pricing group rule, click the **Add (+)** icon corresponding to the **Source System** field and then repeat step 9 and 10.

Note: However, if you want to remove a source system and parameter 1 combination from the pricing group rule, click the **Delete (🗑)** icon corresponding to the combination.

13. If you want to define more than one rule in the pricing group, click the **Add (+)** icon corresponding to the **Priority** field and then repeat the steps from 7 to 10.

Note: However, if you want to remove a rule from the pricing group, click the **Delete (🗑)** icon corresponding to the pricing group rule.

14. Click **Save**.

The changes made to the pricing group are saved.

Related Topics

For more information on...	See...
How to search for a person	Searching for a Person on page 648
Customer 360° Information screen	Customer 360° Information on page 659
Pricing tab	Customer 360° Information - Pricing Information on page 693

For more information on...	See...
Bill Group ASO Policy Information zone	Bill Group Self-Funded Policy Information on page 701
Bill Group Pricing Groups zone	Bill Group Pricing Groups on page 707
Bill Group Derivation and Pricing Parameters zone	Bill Group Derivation and Pricing Parameters on page 671

Deleting a Pricing Group of a Bill Group

Procedure

To delete a pricing group of a bill group:

1. Search for the Administrative Services Only (ASO) person in the **Customer 360° View** screen.
2. In the **Search Results** section, click the **View** () icon corresponding to the person whose details you want to view.

The **Person** tab in the **Customer 360° Information** screen appears.

3. Click the **Pricing** tab.

The **Pricing** tab appears.

4. In the **Bill Group ASO Policy Information** zone, click the **Broadcast** () icon corresponding to a bill group whose pricing group you want to delete.

The **Bill Group ASO Policy Pricing Rules** and **Bill Group Pricing Groups** zones appear.

5. In the **Bill Group Pricing Groups** zone, click the **Delete** () icon in the **Delete** column corresponding to the pricing group that you want to delete.

A message appears confirming whether you want to delete the pricing group.

Note: You can delete a pricing group when it is not yet used while defining a pricing rule for the bill group.

6. Click **OK**.

The pricing group is deleted.

Related Topics

For more information on...	See...
How to search for a person	Searching for a Person on page 648
Customer 360° Information screen	Customer 360° Information on page 659
Pricing tab	Customer 360° Information - Pricing Information on page 693
Bill Group ASO Policy Information zone	Bill Group Self-Funded Policy Information on page 701
Bill Group Pricing Groups zone	Bill Group Pricing Groups on page 707

Copying a Pricing Group of a Bill Group

Instead of creating a pricing group from scratch, you can create a new pricing group using an existing pricing group. This is possible through copying a pricing group. On copying a pricing group, the details including the rules are copied to the new pricing group. You can then edit the details, if required.

Prerequisites

To copy a pricing group of a bill group, you should have:

- Pricing group (whose copy you want to create) defined in the application
- Values defined for the **C1-SourceSystemLookup** extendable lookup

Procedure

To copy a pricing group of a bill group:

1. Search for the Administrative Services Only (ASO) person in the **Customer 360° View** screen.
2. In the **Search Results** section, click the **View** () icon corresponding to the person whose details you want to view.

The **Person** tab in the **Customer 360° Information** screen appears.

3. Click the **Pricing** tab.

The **Pricing** tab appears.

4. In the **Bill Group ASO Policy Information** zone, click the **Broadcast** () icon corresponding to a bill group whose pricing group you want to copy.

The **Bill Group ASO Policy Pricing Rules** and **Bill Group Pricing Groups** zones appear.

5. In the **Bill Group Pricing Groups** zone, click the **Duplicate** () icon in the **Duplicate** column corresponding to the pricing group whose copy you want to create.

The **Pricing Group** screen appears. It contains the following sections:

- **Main** – Used to specify basic details about the pricing group. It contains the following fields:

Field Name	Field Description	Mandatory (Yes or No)
Bill Group Information	Indicates the bill group for whom you want to define the pricing group.	Not applicable
Status	Used to indicate the status of the pricing group. The valid values are: <ul style="list-style-type: none"> • Active • Inactive 	Yes
Description	Used to specify the description for the pricing group.	Yes

- **Pricing Group Rules** – Used to define rules in the pricing group. It contains the following fields in a grid:

Field Name	Field Description	Mandatory (Yes or No)
Priority	Used to indicate the order in which the rule should be executed while determining the pricing for the price item. Note: You cannot define multiple rules in the pricing group with the same priority.	Yes
Rule	Used to specify the rule in the pricing group.	Yes
Description	Used to specify the description for the pricing group rule.	Yes
Criteria	On clicking the Add () icon, you can define criteria for the pricing group rule.	Not applicable

6. Enter the required details in the **Main** section.
7. Define, edit, or remove the required rules from the **Pricing Group Rules** section.

8. Click the **Add** (+) icon in the **Criteria** field corresponding to the pricing group rule for which you want to define or edit the criteria.

The following fields appear in another grid:

Field Name	Field Description	Mandatory (Yes or No)
Source System	Used to indicate the external system from where the claim or enrollment transaction is received.	Yes
Parameter 1	Used to specify the employee attribute based on which you want to define the pricing. Note: You can only specify the employee attribute which is defined for the bill group and source system combination in the Bill Group Derivation and Pricing Parameters zone. You must not specify the ampersand (&) character in this field. The Search (🔍) icon appears corresponding to this field. On clicking the Search icon, the Parameter 1 List for Bill Group window appears.	Yes
Parameter 2	Used to specify the employee attribute based on which you want to define the pricing. Note: You must not specify the ampersand (&) character in this field.	No
Parameter 3	Used to specify the employee attribute based on which you want to define the pricing. Note: You must not specify the ampersand (&) character in this field.	No
Parameter 4	Used to specify the employee attribute based on which you want to define the pricing. Note: You must not specify the ampersand (&) character in this field.	No

9. Enter the source system and parameter 1 in the pricing group rule criteria.

Note: You must define at least one rule in the pricing group and at least one source system and parameter 1 combination in the pricing group rule.

10. If required, enter the parameter 2, parameter 3, and parameter 4 for the source system and parameter 1 combination in the pricing group rule criteria.
11. If you want to define more than one parameter 2, parameter 3, and parameter 4 for the source system and parameter 1 combination, click the **Add** (+) icon corresponding to the **Parameter 2** field and then repeat step 10.

Note: However, if you want to remove a parameter 2, parameter 3, and parameter 4 from the source system and parameter 1 combination, click the **Delete** (🗑️) icon corresponding to the parameter 2, parameter 3, and parameter 4.

12. If you want to define more than one source system and parameter 1 combination in the pricing group rule, click the **Add (+)** icon corresponding to the **Source System** field and then repeat step 9 and 10.

Note: However, if you want to remove a source system and parameter 1 combination from the pricing group rule, click the **Delete (🗑)** icon corresponding to the combination.

13. If you want to define more than one rule in the pricing group, click the **Add (+)** icon corresponding to the **Priority** field and then repeat the steps from 7 to 10.

Note: However, if you want to remove a rule from the pricing group, click the **Delete (🗑)** icon corresponding to the pricing group rule.

14. Click **Save**.

The new pricing group is defined for the bill group.

Related Topics

For more information on...	See...
How to search for a person	Searching for a Person on page 648
Customer 360° Information screen	Customer 360° Information on page 659
Pricing tab	Customer 360° Information - Pricing Information on page 693
Bill Group ASO Policy Information zone	Bill Group Self-Funded Policy Information on page 701
Bill Group Pricing Groups zone	Bill Group Pricing Groups on page 707
Bill Group Derivation and Pricing Parameters zone	Bill Group Derivation and Pricing Parameters on page 671

Pricing Rule Type

Pricing rules are created using pricing rule types. Following are the pricing rules:

- **Claim** – can be created using the claim pricing rule type.
- **Retention Type Claim Based** – can be created using the retention type claim base pricing rule type.
- **Retention Type Enrollment Based** – can be created using the retention type enrollment base pricing rule type.
- **Specific Stop-Loss** – can be created using the specific stop-loss pricing rule type.
- **Aggregated Stop-Loss** – can be created using the aggregated stop-loss or specific stop-loss pricing rule type.
- **One-Time Flat Fee** – can be created using the one-time flat fee pricing rule type.
- **Bill Period Based Recurring Flat Fee** – can be created using the bill period based recurring flat fee pricing rule type.
- **Frequency Based Recurring Flat Fee** – can be created using the frequency based recurring flat fee pricing rule type.

Pricing rule type has a parent business object, **C1-PricingRuleType** with all the common elements required for all pricing rule types. Elements that are specific to each pricing rule type are configured using the child business object. Following are the child business objects:

- **C1-PricingRuleTypeClaim** business object for Claim Pricing Rule Type.
- **C1-PrcRuleTypRetClaimBase** business object for Retention Claim Based Pricing Rule Type.

- **C1-PrcRuleTypRetEnrollBased** business object for Retention Enrollment Based Pricing Rule Type.
- **C1-PricingRuleTypeASL** business object for Aggregate Stop-Loss Pricing Rule Type.
- **C1-PricingRuleTypeSSL** business object for Specific Stop-Loss Pricing Rule Type.
- **C1-PricingRuleTypeFlatFees** business object for One-Time Flat Fee, Bill Period Based Recurring Flat Fee, Frequency Based Recurring Flat Fee Pricing Rule Types.

The **C1-GetPrcRuleTypeRateOpt** business service returns the list of rate options associated with a pricing rule type and selected price item. The **C1-GetPrcRuleTypeProd** business service returns the list of products associated with the pricing rule type.



This screen consists of the following zones:

- [Pricing Rule Type List](#) on page 2533
- [Pricing Rule Type](#) on page 2536

Pricing Rule Type List

The **Pricing Rule Type List** zone lists the pricing rule types that are already defined in the system. It contains the following columns:

Column Name	Column Description
Pricing Rule Type	Displays the pricing rule type.
Description	Displays the description of the pricing rule type.
Pricing Rule Type Category	Indicates the category to which the pricing rule type belongs. The valid values are: <ul style="list-style-type: none"> • Claim • Specific Stop-Loss • Aggregate Stop-Loss • Retention Type Claim Based • Retention Type Enrollment Based • Flat Fees • Ancillary • Discount Arrangement • Level Funded • Age Based • Tier Based • Pass-Through Billable Charge • Benefit • Additional Charge

Column Name	Column Description
Edit	On clicking the Edit () icon, the Claim Pricing Rule Type , Specific Stop-Loss (SSL) Pricing Rule Type , Aggregate Stop-Loss (ASL) Pricing Rule Type , Retention Type Claim Based Pricing Rule Type , Retention Type Enrollment Based Pricing Rule Type , Flat Fees Pricing Rule Type , Ancillary Pricing Rule Type , Discount Arrangement Pricing Rule Type , Level Funded Pricing Rule Type , Age Based Pricing Rule Type , Tier Based Pricing Rule Type , Pass-Through Billable Charge Pricing Rule Type , Benefit Pricing Rule Type , or Additional Charge Pricing Rule Type screen appears, based on the pricing rule type category, where you can edit the details of the respective pricing rule type.
Delete	On clicking the Delete () icon, you can delete the pricing rule type.
	Note: You can delete a pricing rule type when it is not yet used in the system.

Note: Pagination is used to display limited number of records in this zone. You can use the navigation links, such as **Previous** and **Next** to navigate between pages.

On clicking the **Broadcast** () icon corresponding to a pricing rule type, the **Pricing Rule Type** zone appears with the details of the respective pricing rule type.

You can filter the list using the **Pricing Rule Type Category** field available in the **Filter** area. By default, the **Filter** area is hidden. You can view the **Filter** area by clicking the **Filters** () icon in the upper right corner of this zone.

Related Topics

For more information on...	See...
How to edit a claim pricing rule type	Editing a Claim Pricing Rule Type on page 2572
How to delete a claim pricing rule type	Deleting a Claim Pricing Rule Type on page 2574
How to view the details of a claim pricing rule type	Viewing the Claim Pricing Rule Type Details on page 2575
How to edit a specific stop-loss pricing rule type	Editing a Specific Stop-Loss (SSL) Pricing Rule Type on page 2603
How to delete a specific stop-loss pricing rule type	Deleting a Specific Stop-Loss (SSL) Pricing Rule Type on page 2606
How to view the details of a specific stop-loss pricing rule type	Viewing the Specific Stop-Loss (SSL) Pricing Rule Type Details on page 2606
How to edit an aggregate stop-loss pricing rule type	Editing an Aggregate Stop-Loss (ASL) Pricing Rule Type on page 2639
How to delete an aggregate stop-loss pricing rule type	Deleting an Aggregate Stop-Loss (ASL) Pricing Rule Type on page 2642
How to view the details of an aggregate stop-loss pricing rule type	Viewing the Aggregate Stop-Loss (ASL) Pricing Rule Type Details on page 2642
How to edit a retention type claim based pricing rule type	Editing a Retention Type Claim Based Pricing Rule Type on page 2673
How to delete a retention type claim based pricing rule type	Deleting a Retention Type Claim Based Pricing Rule Type on page 2675

For more information on...	See...
How to view the details of a retention type claim based pricing rule type	Viewing the Retention Type Claim Based Pricing Rule Type Details on page 2676
How to edit a retention type enrollment based pricing rule type	Editing a Retention Type Enrollment Based Pricing Rule Type on page 2702
How to delete a retention type enrollment based pricing rule type	Deleting a Retention Type Enrollment Based Pricing Rule Type on page 2704
How to view the details of a retention type enrollment based pricing rule type	Viewing the Retention Type Enrollment Based Pricing Rule Type Details on page 2705
How to edit a one-time flat fee pricing rule type	Editing a One-Time Flat Fee Pricing Rule Type on page 2731
How to delete a one-time flat fee pricing rule type	Deleting a One-Time Flat Fee Pricing Rule Type on page 2734
How to view the details of a one-time flat fee pricing rule type	Viewing the One-Time Flat Fee Pricing Rule Type Details on page 2735
How to edit a bill period based recurring flat fee pricing rule type	Editing a Bill Period Based Recurring Flat Fee Pricing Rule Type on page 2746
How to delete a bill period based recurring flat fee pricing rule type	Deleting a Bill Period Based Recurring Flat Fee Pricing Rule Type on page 2749
How to view the details of a bill period based recurring flat fee pricing rule type	Viewing the Bill Period Based Recurring Flat Fee Pricing Rule Type Details on page 2750
How to edit a frequency based recurring flat fee pricing rule type	Editing a Frequency Based Recurring Flat Fee Pricing Rule Type on page 2761
How to delete a frequency based recurring flat fee pricing rule type	Deleting a Frequency Based Recurring Flat Fee Pricing Rule Type on page 2764
How to view the details of a frequency based recurring flat fee pricing rule type	Viewing the Frequency Based Recurring Flat Fee Pricing Rule Type Details on page 2764
How to edit an ancillary pricing rule type	Editing an Ancillary Pricing Rule Type on page 2799
How to delete an ancillary pricing rule type	Deleting an Ancillary Pricing Rule Type on page 2803
How to view the details of an ancillary pricing rule type	Viewing the Ancillary Pricing Rule Type Details on page 2804
How to edit a discount arrangement pricing rule type	Editing a Discount Arrangement Pricing Rule Type on page 2838
How to delete a discount arrangement pricing rule type	Deleting a Discount Arrangement Pricing Rule Type on page 2841
How to view the details of a discount arrangement pricing rule type	Viewing the Discount Arrangement Pricing Rule Type Details on page 2842
How to edit a level funded pricing rule type	Editing a Level Funded Pricing Rule Type on page 2871
How to delete a level funded pricing rule type	Deleting a Level Funded Pricing Rule Type on page 2874
How to view the details of a level funded pricing rule type	Viewing the Level Funded Pricing Rule Type Details on page 2874

For more information on...	See...
How to edit an age based pricing rule type	Editing an Age Based Pricing Rule Type on page 3031
How to delete an age based pricing rule type	Deleting an Age Based Pricing Rule Type on page 3034
How to view the details of an age based pricing rule type	Viewing the Age Based Pricing Rule Type Details on page 3034
How to edit a tier based pricing rule type	Editing a Tier Based Pricing Rule Type on page 3049
How to delete a tier based pricing rule type	Deleting a Tier Based Pricing Rule Type on page 3051
How to view the details of a tier based pricing rule type	Viewing the Tier Based Pricing Rule Type Details on page 3052
How to edit a pass-through billable charge pricing rule type	Editing a Pass-Through Billable Charge Pricing Rule Type on page 3061
How to delete a pass-through billable charge pricing rule type	Deleting a Pass-Through Billable Charge Pricing Rule Type on page 3063
How to view the details of a pass-through billable charge pricing rule type	Viewing the Pass-Through Billable Charge Pricing Rule Type Details on page 3064
How to edit the details of an additional charge pricing rule type	Editing an Additional Charge Pricing Rule Type on page 3077
How to delete the details of an additional charge pricing rule type	Deleting an Additional Charge Pricing Rule Type on page 3079
How to view the details of an additional charge pricing rule type	Viewing the Additional Charge Pricing Rule Type Details on page 3080
How to view the details of a benefit pricing rule type	Viewing the Benefit Pricing Rule Type Details on page 3093
How to edit the details of a benefit pricing rule type	Editing a Benefit Pricing Rule Type on page 3090
How to delete the details of a benefit pricing rule type	Deleting a Benefit Pricing Rule Type on page 3092

Pricing Rule Type

The **Pricing Rule Type** zone displays the details of the pricing rule type for claim, aggregate stop-loss, specific stop-loss, retention type enrollment based, retention type claim based, one-time flat fee, bill period based recurring flat fee, and frequency based recurring flat fee. This zone contains the following sections:

- **Main** – This section provides basic information about the pricing rule type. It contains the following fields:

Field Name	Field Description
Pricing Rule Type	Displays the pricing rule type.
Description	Displays the description for the pricing rule type.
Detailed Description	Displays additional information about the pricing rule type category.

Field Name	Field Description
Pricing Rule Business Object	<p>Indicates the pricing rule business object. In addition, a context menu appears corresponding to this field which helps in navigating to other screens in the application. The valid values are:</p> <ul style="list-style-type: none"> • Claim Pricing Rule • Aggregate Stop-Loss (ASL) Pricing Rule • Specific Stop-Loss (SSL) Pricing Rule • Retention Type Claim Based Pricing Rule • Retention Type Enrollment Based Pricing Rule • Flat Fee Pricing Rule <p>Note: It has a link. On clicking the link, the Business Object screen appears where you can view the details of the respective business object.</p>
Business Object	<p>Indicates the pricing rule type business object. In addition, a context menu appears corresponding to this field which helps in navigating to other screens in the application. The valid values are:</p> <ul style="list-style-type: none"> • Claim Pricing Rule Type • Aggregate Stop-Loss (ASL) Pricing Rule Type • Specific Stop-Loss (SSL) Pricing Rule Type • Retention Type Claim Based Pricing Rule Type • Retention Type Enrollment Based Pricing Rule Type • Flat Fee Pricing Rule Type <p>Note: It has a link. On clicking the link, the Business Object screen appears where you can view the details of the respective business object.</p>
Status	<p>Indicates the status of the pricing rule type. The valid values are:</p> <ul style="list-style-type: none"> • Active • Inactive
Primary	Displays whether the pricing rule type is primary or not.
Pricing Rule Type Category	<p>Indicates the pricing rule type category for the pricing rule type. The valid values are:</p> <ul style="list-style-type: none"> • Claim • Aggregate Stop-Loss • Specific Stop-Loss • Retention Type Claim Based • Retention Type Enrollment Based • Flat Fees

- **Related Pricing Rule Types** – This section lists the pricing rule types which are related to the parent pricing rule type. It contains the following columns:

Column Name	Column Description
Sequence	Displays the order in which pricing rule type is executed.
Pricing Rule Type	Displays the related pricing rule type for the parent rule type. Note: It has a link. On clicking the link, the Pricing Rule Type screen appears where you can view the details of the respective pricing rule type.

Note: This section appears when the pricing rule type is a primary pricing rule type.

- **Transaction Field Mapping** – This section displays the transaction related data mapped to the pricing rule type. It contains the following fields:

Field Name	Field Description
Source System	Displays the external system from where the transaction data is mapped.
Parameter 1 ... Parameter 4	Displays the parameters mapped for the transactions.
Incurred Date	Displays the date incurred for transaction.
Paid Date	Displays the transaction paid date.
Source of Funds	Displays the source of funds used to make the payment.
Composite	Displays the composite transaction data.
Claim Disposition	Displays the disposition of the claims transaction.
Provider's Tax Identification Number	Displays the tax identification number of the provider.
Member ID	Displays the member ID.
Main Subscriber ID	Displays the customer ID.
Run-in Identifier	Displays the run-in identifier.
Runout Identifier	Displays the runout identifier.
Coverage Start Date	Displays the transaction coverage start date.
Coverage End Date	Displays the transaction coverage end date.
Retroactivity Indicator	Displays information of the retroactivity indicator.

Note: This section appears when the pricing rule type is a primary pricing rule type.

- **Algorithms** – This section displays the algorithms used for the pricing rule type. It contains the following columns:

Column Name	Column Description
System Event	Indicates the system event on which the algorithm must be executed. The valid values are: <ul style="list-style-type: none"> Account and Price Item Derivation Bill After Date Determination Bill Group Derivation Pricing Rule Post Processing Transaction Validation
Sequence	Displays the order in which the algorithms for each system event must be executed.
Algorithm	Displays the algorithm. Note: It has a link. On clicking the link, the Algorithm screen appears with the details of the respective algorithm.



- **Additional Data** – This section displays the additional information about the pricing rule type. It contains the following fields:

Field Name	Field Description
Eligible for Level Funding	Indicates whether the pricing rule type is eligible for level funding or not. The valid values are: <ul style="list-style-type: none"> Yes No
Eligible for Specific Stop-Loss	Indicates whether the pricing rule type is eligible for specific stop-loss or not. The valid values are: <ul style="list-style-type: none"> Yes No <p>Note: This field appears when the option selected for the Pricing Rule Type Category is Claim, Retention Type Claim Based, or Retention Type Enrollment Based.</p>
Run-in Identifier Value	Displays the value for run-in identifier.
Runout Identifier Value	Displays the value for runout identifier.

Note: This section does not appear when the pricing rule type category is flat fees.

- **Price Items** – This section displays the price items assigned to the pricing rule type. It contains the following columns:

Column Name	Column Description
Price Item	Displays the price item information. Note: It has a link. On clicking the link, the Price Item screen appears where you can view the details of the respective price item.

Column Name	Column Description						
Rate Option	On clicking the Add  icon, the following column appears:						
	<table border="1"> <thead> <tr> <th>Column Name</th> <th>Column Description</th> </tr> </thead> <tbody> <tr> <td>Rate Option</td> <td>Indicates the rate option for the price item.</td> </tr> </tbody> </table>	Column Name	Column Description	Rate Option	Indicates the rate option for the price item.		
	Column Name	Column Description					
Rate Option	Indicates the rate option for the price item.						
Note: This column does not appear when the pricing rule type category is flat fees.							
Bill To Account	On clicking the Add  icon, the following columns appear:						
	<table border="1"> <thead> <tr> <th>Column Name</th> <th>Column Description</th> </tr> </thead> <tbody> <tr> <td>Priority</td> <td>Displays the order in which the invoice type was considered while defining a price item.</td> </tr> <tr> <td>Invoice Type</td> <td>Displays the invoice type for the price item.</td> </tr> </tbody> </table>	Column Name	Column Description	Priority	Displays the order in which the invoice type was considered while defining a price item.	Invoice Type	Displays the invoice type for the price item.
	Column Name	Column Description					
	Priority	Displays the order in which the invoice type was considered while defining a price item.					
Invoice Type	Displays the invoice type for the price item.						

- **Price Item Parameters** – This section displays the price item parameters in the pricing rule type. It contains the following columns:

Column Name	Column Description
Price Item Parameter	Displays the parameter associated with the price item.
	Note: It has a link. On clicking the link, the Parameter screen appears where you can view the details of the respective parameter.
Transaction Field	Displays the additional transaction data.
	Note: It has a link. On clicking the link, the Field screen appears where you can view the details of the respective transaction field.
	This column does not appear when the pricing rule type category is flat fees.
Eligible for Specific Stop-Loss	Displays the parameter eligible for Specific Stop-Loss when the eligibility checkbox was checked.
	Note: This field appears only when the option selected for the Pricing Rule Type Category is Claim , Retention Type Claim Based , or Retention Type Enrollment Based .
Eligible for Level Funding	Displays the parameter eligible for level funding when the eligibility checkbox was checked.

- **Characteristics** – This section displays the pricing rule type characteristics. It contains the following columns:

Column Name	Column Description
Characteristic Type	Indicates the characteristic type.
Characteristic Value	Displays the value for the characteristic type.

- **Event Management** – This section displays the audit event details. It contains the following columns:

Column Name	Column Description
Audit Event Type	Displays the audit event type which you can use while adding elements for audit in a fully-insured benefit pricing rule type.
Element Type	Indicates the type of audit element for a fully-insured benefit pricing rule type. The valid values are: <ul style="list-style-type: none"> • Business Object Status • Characteristic • Field
Element Name	Displays the element name for a fully-insured benefit pricing rule type.
Element Value	Displays the value for an element name.

- **Claim Templates** – This section list the pricing rule type for claim template. It contains the following field:

Field Name	Field Description
Claim Template	Indicates the claim template.

Note: This section appears when the **Business Object** is **Claim Pricing Rule Type**.

- **Claim-Specific Additional Data** – This section displays the claim specific additional data. It contains the following fields:

Field Name	Field Description
Rule Based Billing Eligibility Field	Displays whether the rule based field is eligible for billing or not.
	Note: It has a link. On clicking the link, the Field screen appears where you can view the details of the respective field.
Rule Based Markup or Markdown Eligibility Field	Displays whether the rule based markup or markdown field is eligible for billing or not.
	Note: It has a link. On clicking the link, the Field screen appears where you can view the details of the respective field.
Markup or Markdown Billable Charge Line Type	Displays the markup or markdown billable charge line type.

Note: This section appears when the **Business Object** is **Claim Pricing Rule Type**.

- **ASL-Specific Additional Data** – This section displays the Aggregated Stop-Loss specific additional data. It contains the following fields:

Field Name	Field Description
ASL Billable Charge Line Type	Displays the Aggregated Stop-Loss billable charge line type.
Domestic Provider Claim Billable Charge Line Type	Displays the claim billable charge line type for domestic provider.
Rule Based Domestic Provider Claim Eligibility Field	Displays the rule based domestic provider for claim eligibility field.

Field Name	Field Description
ASL Limit Price Item	Displays the Aggregated Stop-Loss limit price item.
Rule Based Billing Eligibility Field	Displays whether the rule based field is eligible for billing or not.
	Note: It has a link. On clicking the link, the Field screen appears where you can view the details of the respective field.
Rule Based Markup or Markdown Eligibility Field	Displays whether the rule based markup or markdown field is eligible for billing or not.
	Note: It has a link. On clicking the link, the Field screen appears where you can view the details of the respective field.
Markup or Markdown Billable Charge Line Type	Displays the markup or markdown billable charge line type.

Note: This section appears when the **Business Object** is **Aggregate Stop-Loss (ASL) Pricing Rule Type**.

- **Enrollment-Specific Additional Data** – This section displays the enrollment specific additional data. It contains the following fields:

Field Name	Field Description
Retroactivity Indicator Value	Displays the value for the retroactivity indicator.

Note: This section appears when the **Business Object** is **Retention Type Enrollment Based Pricing Rule Type**.

- **Claim Disposition Details** – This section displays the details of claim disposition. It contains the following columns:

Column Name	Column Description
Claim Disposition	Indicates the claim disposition.
Disposition Mode	Indicates the claim disposition mode. The valid values are: <ul style="list-style-type: none"> • Align Signage • Zero Out

Note: This section appears when the **Business Object** is **Retention Type Claim Based Pricing Rule Type**.

- **SSL-Specific Additional Data** – This section displays the Specific Stop-Loss additional data. It contains the following fields:

Field Name	Field Description
SSL Billable Charge Line Type	Displays the Specific Stop-Loss billable charge line type.
Domestic Provider Claim Billable Charge Line Type	Displays the claim billable charge line type for domestic provider.
Rule Based Domestic Provider Claim Eligibility Field	Displays the rule based domestic provider for claim eligibility field.

Field Name	Field Description
Rule Based Billing Eligibility Field	Displays whether the rule based field is eligible for billing or not. Note: It has a link. On clicking the link, the Field screen appears where you can view the details of the respective field.
Rule Based Markup or Markdown Eligibility Field	Displays whether the rule based markup or markdown field is eligible for billing or not. Note: It has a link. On clicking the link, the Field screen appears where you can view the details of the respective field.
Markup or Markdown Billable Charge Line Type	Displays the markup or markdown billable charge line type.

Note: This section appears when the **Business Object** is **Specific Stop-Loss (SSL) Pricing Rule Type**.

- **Billable Charge Line Types** – This section list the billable charge line type. It contains the following column:

Column Name	Column Description
Billable Charge Line Type	Indicates the billable charge line type.

Note: This section appears when the **Business Object** is **Flat Fees Pricing Rule Type**.

- **Flat Fees - Specific Additional Data** – This section displays the recurring flat fee that is specific and considered as additional data. It contains the following fields:

Field Name	Field Description
Bill Segment Cancel Reason	Indicates the reason for cancelling the bill segment.
Recurring Fee	Displays whether the recurring flat fee is required or not.
Recurring Method	Indicates the recurring method if recurring fee is required. The valid values are: <ul style="list-style-type: none"> • Bill Period • Frequency Note: This field appears when the checkbox for Recurring Fee field is selected.

Note: This section appears when the **Business Object** is **Flat Fees Pricing Rule Type**.

This section contains the following sub-section:

- **Bill Periods** – This section displays the bill period for the recurring flat fee. It contains the following column:

Column Name	Column Description
Bill Period	Indicates the bill period.

Note: This section appears when the **Recurring Method** is **Bill Period**.

- **Additional Fee Indicator** – This section displays the additional fees which are applicable to one or more line items in the claim pricing rule. It contains the following fields:

Column Name	Column Description
Fee	Indicates the charge type category for the claim pricing rule.
Claim Additional Fee Indicator	Indicates the charge type sub category for the claim pricing rule.

Note: This section appears when the **Business Object** is **Claim Pricing Rule Type**.

- **Record Actions** – This section contains the following buttons:

Button Name	Button Description
Edit	Used to edit the details of the pricing rule type.
Delete	Used to delete the pricing rule type.

- **Record Information** – This section contains the following fields:

Field Name	Field Description
Business Object	Indicates the business object using which the extendable lookup value for pricing rule type is created. In addition, a context menu appears corresponding to this field which helps in navigating to other screens in the application.
	Note: It has a link. On clicking the link, the Business Object screen appears with the details of the respective business object.

By default, the **Pricing Rule Type** zone does not appear in the **Pricing Rule Type** screen. It appears when you click the **Broadcast** () icon corresponding to the pricing rule type in the **Pricing Rule Type List** zone.

Related Topics

For more information on...	See...
Pricing Rule Type screen	Pricing Rule Type on page 2532
Pricing Rule Type List zone	Pricing Rule Type List on page 2533
How to edit the claim pricing rule type	Editing a Claim Pricing Rule Type on page 2572
How to edit the specific stop-loss pricing rule type	Editing a Specific Stop-Loss (SSL) Pricing Rule Type on page 2603
How to edit the aggregate stop-loss pricing rule type	Editing an Aggregate Stop-Loss (ASL) Pricing Rule Type on page 2639
How to edit the retention type claim based pricing rule type	Editing a Retention Type Claim Based Pricing Rule Type on page 2673
How to edit the retention type enrollment based pricing rule type	Editing a Retention Type Enrollment Based Pricing Rule Type on page 2702
How to edit the one-time flat fee pricing rule type	Editing a One-Time Flat Fee Pricing Rule Type on page 2731
How to edit the bill period based recurring flat fee pricing rule type	Editing a Bill Period Based Recurring Flat Fee Pricing Rule Type on page 2746
How to edit the frequency based recurring flat fee pricing rule type	Editing a Frequency Based Recurring Flat Fee Pricing Rule Type on page 2761

For more information on...	See...
How to delete a pricing rule type	Deleting a Pricing Rule Type
How to edit the fully-insured benefit pricing rule type	<< add links >>
How to delete a fully-insured benefit pricing rule type	<< add links >>

Claim Pricing

The ASO service provider processes the claims as part of the ASO agreement and pays the claim amount to either hospital or main subscriber. The employer, in turn, reimburses the claim amount to the ASO service provider at the end of the bill period (i.e. typically, every month). Apart from charging the claim amount to the employer, the ASO service provider charges various additional fees, such as fee for network access, fee for non-network access, fee for collection services provided by external vendor, fee for hospital audit performed by external vendor, and so on.

Oracle Revenue Management and Billing allows the ASO service provider to bill the employers for the claim amount and various additional fees. You can use any custom mechanism or the file upload utility in ORMB to upload the claim transactions. The pricing for the claim transactions can be defined using the claim pricing rules. You can define a claim pricing rule at the parent customer and bill group levels. The claim pricing rule at the bill group level takes precedence over the claim pricing rule at the parent customer level. You can define claim pricing rules for parent customers and bill groups from the **Customer 360° Information** screen. You can define a claim pricing rule using a claim pricing rule type.

It is the claim pricing rule type which helps the system to determine:

- Business object using which the claim pricing rule should be created in the system.
- Whether it is the primary pricing rule type from where the related pricing rule types, such as specific stop-loss, aggregate stop-loss, and retention type claim based pricing rule types, will inherit the attributes.

Note: You must select the **Primary** option while defining a claim pricing rule type. On selecting the **Primary** option, the **Related Pricing Rule Types** and **Transaction Field Mapping** sections appear in the **Claim Pricing Rule Type** screen.

- Pricing rule types which are related to claim pricing rule type.
- Transaction fields from where the data for claim, specific stop-loss, aggregate stop-loss, retention type claim based processing should be retrieved.
- Algorithm which should be triggered while validating a transaction.

Note: An algorithm type for validating a transaction is not shipped from the product. You need to create a custom algorithm type, if required.

- Algorithms which should be triggered while deriving bill group, account, and price item for a transaction.

Note: You must create an algorithm using the **C1_TXNBGDRV** algorithm type and attach it to the **Bill Group Derivation** system event. Similarly, you must create an algorithm using the **C1_ACCPRIDRV** algorithm type and attach it to the **Account and Price Item Derivation** system event.

- Algorithm which should be triggered while determining the bill after date.

Note: You must create an algorithm using the **C1_BAFTDRV** algorithm type and attach it to the **Bill After Date Determination** system event. The **C1_BAFTDRV** algorithm sets the bill after date to the end date of the aggregation schedule which is specified in the respective rate option. For example, if the aggregation schedule is monthly, the bill after date is set to the last day of the month.

- Post-processing algorithm which should be triggered once the claim pricing rule is derived.

Note: A post-processing algorithm type is not shipped from the product. You need to create a custom algorithm type, if required.

- Price items for which you can define claim pricing rules using the claim pricing rule type.
- Rate options that you can use while defining the pricing for a price item.
- Different type of account to which the price item should be billed based on the specified priority.
- Price item parameters which you can use while accumulating specific stop-loss and aggregate stop-loss and while aggregating transactions.
- Claim templates which can be used while defining claim pricing rules using the claim pricing rule type.
- Additional information, such as:
 - Whether the price items included in the claim pricing rule type are eligible for specific stop-loss and aggregate stop-loss.
 - Identifiers which help to determine whether the claim transaction is received during the run-in period of the policy.
 - Billable charge line type using which you want to create markup or markdown calculation lines.
 - Transaction field which you want to use in the rules as the output parameter to determine whether the line item is eligible for billing.
 - Transaction field which you want to use in the rules as the output parameter to determine whether the markup or markdown calculation line is eligible for billing.

Once a claim pricing rule type is defined, you can create claim pricing rules using the claim pricing rule type. While defining a claim pricing rule for a parent customer and bill group, you need to specify the following:

- Price item for which you want to define the pricing.
- Pricing date range during which the pricing is effective.
- Rate option and claim template which you want to use while defining the claim pricing.
- Whether you want to markup or markdown the various charges.
- Whether you want to use a flat amount for markup or markdown on overall charges.
- Whether you want to calculate markup or markdown amount based on percentage for each eligible charge.
- Whether a line item is eligible for billing when the billing eligibility for the line item in the claim template is set to **User Defined**.

Note: You can override the default markup and markdown values which are retrieved from the claim template.

In addition, while defining a claim pricing rule for a bill group, you need to specify the status of the policy for which you want to define the claim pricing rule. You can also specify a pricing group while defining a claim pricing rule for a bill group. If you specify a pricing group while defining a claim pricing rule for a bill group, you will have to define the following details for each rule defined in the pricing group:

- Whether you want to markup or markdown the various charges.
- Whether you want to use a flat amount for markup or markdown on overall charges.
- Whether you want to calculate markup or markdown amount based on percentage for each eligible charge.
- Whether a line item is eligible for billing when the billing eligibility for the line item in the claim template is set to **User Defined**.

Once a claim pricing rule is defined for a parent customer and bill group, the system creates one price assignment, one price list, and one price list assignment.

Defining a Claim Pricing Rule Type

Prerequisites

To define a claim pricing rule type, you should have:

- Business Object **C1-PricingRuleTypeClaim** defined for pricing rule type.
- Business Object **C1-PricingRuleClaim** defined for pricing rule.
- Pricing rule type category for claim defined in the application

Procedure

To define a claim pricing rule type:

1. Click the **Admin** link in the **Application** toolbar.
A list appears.
2. From the **Admin** menu, select **P** and then click **Pricing Rule Type**.
A sub-menu appears.
3. Click the **Add** option from the **Pricing Rule Type** sub-menu.

The **Select Business Object** screen appears. It contains the following field:

Field Name	Field Description	Mandatory (Yes or No)
Pricing Rule Type Business Object	Used to indicate the business object using which you want to create the pricing rule type.	Yes
	Note: You can create a claim pricing rule type using the Claim Pricing Rule Type business object.	

Tip: Alternatively, you can access this screen by clicking the **Add** button in the **Page Title** area of the **Pricing Rule Type** screen.

4. Select the **Claim Pricing Rule Type** business object.
5. Click **OK**.

The **Claim Pricing Rule Type** screen appears. It contains the following sections:

- **Main** – Used to specify basic details about the claim pricing rule type.
- **Related Pricing Rule Types** – Used to define the pricing rule types which are related to the parent pricing rule type.
- **Transaction Field Mapping** – Used to specify the transaction related data mapped to the pricing rule type
- **Algorithms** – Used to define the algorithms used for the pricing rule type.
- **Additional Data** – Used to specify the additional information about the pricing rule type.
- **Price Items** – Used to define the price items assigned to the pricing rule type.
- **Price Item Parameters** – Used to define the price item parameters in the pricing rule type.
- **Characteristics** – Used to define the characteristics for the pricing rule type.
- **Claim Templates** – Used to define the pricing rule type for claim template.
- **Claim-Specific Additional Data** – Used to specify the claim specific additional data.

The **Main** section contains the following fields:

Field Name	Field Description	Mandatory (Yes or No)
Pricing Rule Type	Used to specify the pricing rule type.	Yes
Description	Used to specify the description for the pricing rule type.	Yes
Detailed Description	Used to specify additional information about the pricing rule type.	No
Related Transaction Business Object	Used to indicate the pricing rule business object. The valid values are: <ul style="list-style-type: none"> • Claim Pricing Rule • Aggregate Stop-Loss (ASL) Pricing Rule • Specific Stop-Loss (SSL) Pricing Rule • Retention Type Claim Based Pricing Rule • Retention Type Enrollment Based Pricing Rule 	Yes
Business Object	Indicate the pricing rule type business object for claim.	Not applicable
Status	Used to indicate the status of the pricing rule type. The valid values are: <ul style="list-style-type: none"> • Active • Inactive 	Yes
Primary	Used to select the checkbox if the pricing rule type is primary.	No
Pricing Rule Type Category	Used to indicate the pricing rule type category for the pricing rule type. The valid values are: <ul style="list-style-type: none"> • Claim • Aggregate Stop-Loss • Specific Stop-Loss • Retention Type Claim Based • Retention Type Enrollment Based 	Yes

6. Enter the required details in the **Main** section.
7. Add the related pricing rule types in the primary pricing rule type, if required.

Note: Related Pricing Rule Types section appears when the pricing rule type is primary.

8. Define the transaction field mapping in the primary pricing rule type, if required.

Note: Transaction Field Mapping section appears when the pricing rule type is primary.

9. Associate algorithms with the pricing rule type, if required.
10. Define additional data for the pricing rule type, if required.
11. Add pricing items in the pricing rule type, if required.
12. Add price item parameters in the pricing rule type, if required.

13. Define characteristics for the pricing rule type, if required.
14. Add claim templates in the claim pricing rule type, if required.
15. Add the claim-specific data in the pricing rule type, if required.
16. Define claim handling fees indicator in the claim pricing rule type, if required.
17. Click **Save**.

The claim pricing rule type is defined.

Related Topics

For more information on...	See...
Pricing Rule Type screen	Pricing Rule Type on page 2532
How to add the related pricing rule types in the primary pricing rule type	Adding Related Pricing Rule Types in a Primary Pricing Rule Type on page 2549
How to define the transaction field mapping in the primary pricing rule type	Defining Transaction Field Mapping in a Primary Pricing Rule Type on page 2551
How to associate algorithms with the pricing rule type	Associating Algorithms with a Pricing Rule Type on page 2557
How to define additional data for the pricing rule type	Defining Additional Data for a Pricing Rule Type on page 2559
How to add pricing items in the pricing rule type	Adding Price Items in a Pricing Rule Type on page 2561
How to add price item parameters in the pricing rule type	Adding a Price Item Parameter in a Pricing Rule Type on page 2564
How to define a characteristic for the pricing rule type	Defining a Characteristic for a Pricing Rule Type on page 2566
How to add claim templates in the claim pricing rule type	Adding Claim Templates in a Claim Pricing Rule Type on page 2568
How to add the claim-specific data in the pricing rule type	Adding the Claim-Specific Data in a Pricing Rule Type on page 2569
How to define the claim handling fees indicators in the claim pricing rule type	Adding Claim Handling Fees Indicator in a Claim Pricing Rule Type on page 2570

Adding Related Pricing Rule Types in a Primary Pricing Rule Type

Prerequisites

To add related pricing rule types in a primary pricing rule type, you should have:

- Aggregate Stop Loss pricing rule type defined in the application.
- Specific Stop Loss pricing rule type defined in the application.
- Level Funding pricing rule type defined in the application.

Procedure

To add related pricing rule types in a primary pricing rule type:

1. Ensure that the **Related Pricing Rule Types** section is expanded when you are defining or editing a primary pricing rule type.

Note:

This section appears when you have chosen the **Primary** from the **Main** section.

The **Related Pricing Rule Types** section contains the following columns in a grid:

Column Name	Column Description	Mandatory (Yes or No)
Sequence	Used to specify the order in which the related pricing rule type should be invoked.	Yes (Conditional) Note: This field is required when you are defining a pricing rule type for the related pricing rule type.
Pricing Rule Type	Used to specify the pricing rule type which should be executed to determine whether the related pricing rule type is eligible for deriving the transaction legs. Note: On clicking the Search (🔍) icon that appears corresponding to the Pricing Rule Type field, the Pricing Rule Type Search window appears. On specifying the related pricing rule type, the description of the pricing rule type appears corresponding to the Pricing Rule Type field.	Yes (Conditional) Note: This field is required when the corresponding Sequence and Eligibility Rule Type field is specified for the related pricing rule type.
Eligibility Rule Type	Used to indicate the rule type eligibility for the related pricing rule type. Note: The Eligibility Rule Type list includes only those rule-types where the rule type eligibility is Related Pricing Rule Type Eligibility .	No

- Enter the required details in the **Related Pricing Rule Types** section.
- If you want to define more than one related pricing rule type for the primary pricing rule type, click the **Add** (+) icon and then repeat step 2.

Note: However, if you want to remove a related pricing rule type from the primary pricing rule type, click the **Delete** (🗑️) icon corresponding to the related pricing rule type.

- Click **Save**.

The related pricing rule types are added for the primary pricing rule type.

Related Topics

For more information on...	See...
How to define a claim pricing rule type	Defining a Claim Pricing Rule Type on page 2547
How to define a specific stop-loss (SSL) pricing rule type	Defining a Specific Stop-Loss (SSL) Pricing Rule Type on page 2598

For more information on...	See...
How to define an aggregate stop-loss (ASL) pricing rule type	Defining a Aggregate Stop-Loss (ASL) Pricing Rule Type on page 2634
How to define a retention type claim based pricing rule type	Defining a Retention Type Claim Based Pricing Rule Type on page 2669
How to define a retention type enrollment based pricing rule type	Defining a Retention Type Enrollment Based Pricing Rule Type on page 2698
How to define a one-time flat fee pricing rule type	Defining a One-Time Flat Fee Pricing Rule Type on page 2727
How to define a bill period based recurring flat fee pricing rule type	Defining a Bill Period Based Recurring Flat Fee Pricing Rule Type on page 2742
How to define a frequency based recurring flat fee pricing rule type	Defining a Frequency Based Recurring Flat Fee Pricing Rule Type on page 2757
How to edit a claim pricing rule type	Editing a Claim Pricing Rule Type on page 2572
How to edit a specific stop-loss (SSL) pricing rule type	Editing a Specific Stop-Loss (SSL) Pricing Rule Type on page 2603
How to edit an aggregate stop-loss (ASL) pricing rule type	Editing an Aggregate Stop-Loss (ASL) Pricing Rule Type on page 2639
How to edit a retention type claim based pricing rule type	Editing a Retention Type Claim Based Pricing Rule Type on page 2673
How to edit a retention type enrollment based pricing rule type	Editing a Retention Type Enrollment Based Pricing Rule Type on page 2702
How to edit a one-time flat fee pricing rule type	Editing a One-Time Flat Fee Pricing Rule Type on page 2731
How to edit a bill period based recurring flat fee pricing rule type	Editing a Bill Period Based Recurring Flat Fee Pricing Rule Type on page 2746
How to edit a frequency based recurring flat fee pricing rule type	Editing a Frequency Based Recurring Flat Fee Pricing Rule Type on page 2761

Defining Transaction Field Mapping in a Primary Pricing Rule Type

Prerequisites

To define the transaction field mapping for a primary pricing rule type, you should have:

- Transaction fields defined in the application

Procedure

To define the transaction field mapping for a primary pricing rule type:

1. Ensure that the **Transaction Field Mapping** section is expanded when you are defining a primary pricing rule type.

Note:

This section appears when you have chosen the **Primary** option from the **Main** section.

The **Transaction Field Mapping** section contains the following fields:

Field Name	Field Description
Source System	<p>Used to specify the external system from where the transaction data is mapped.</p> <p>Note:</p> <p>On clicking the Search (🔍) icon that appears corresponding to the Source System field, the Transaction Field Search window appears.</p> <p>On specifying the source system, the description of the source system appears corresponding to the Source System field.</p>
Parameter 1.....Parameter 4	<p>Used to specify the parameters mapped for the transaction.</p> <p>Note:</p> <p>On clicking the Search (🔍) icon that appears corresponding to the Parameter 1, Parameter 2, Parameter 3, Parameter 4 field, the Transaction Field Search window appears.</p> <p>On specifying the parameter, the description of the parameter appears corresponding to the Parameter 1, Parameter 2, Parameter 3, Parameter 4 field respectively.</p>
Incurred Date	<p>Used to specify the date incurred for transaction.</p> <p>Note:</p> <p>On clicking the Search (🔍) icon that appears corresponding to the Incurred Date field, the Transaction Field Search window appears.</p> <p>On specifying the incurred date, the description of the incurred date appears corresponding to the Incurred Date field.</p>
Paid Date	<p>Used to specify the transaction paid date.</p> <p>Note:</p> <p>On clicking the Search (🔍) icon that appears corresponding to the Paid Date field, the Transaction Field Search window appears.</p> <p>On specifying the paid date, the description of the paid date appears corresponding to the Paid Date field.</p>
Source of Funds	<p>Used to specify the source of funds used to make the payment.</p> <p>Note:</p> <p>On clicking the Search (🔍) icon that appears corresponding to the Source of Funds field, the Transaction Field Search window appears.</p> <p>On specifying the source of funds, the description of the source of funds appears corresponding to the Source of Funds field.</p>

Field Name	Field Description
Composite	<p>Used to specify the composite transaction data.</p> <p>Note:</p> <p>On clicking the Search (🔍) icon that appears corresponding to the Composite field, the Transaction Field Search window appears.</p> <p>On specifying the composite, the description of the composite appears corresponding to the Composite field.</p>
Claim Disposition	<p>Used to specify the disposition of the claims transaction.</p> <p>Note:</p> <p>On clicking the Search (🔍) icon that appears corresponding to the Claim Disposition field, the Transaction Field Search window appears.</p> <p>On specifying the claim disposition, the description of the claim disposition appears corresponding to the Claim Disposition field.</p>
Provider's Tax Identification Number	<p>Used to specify the tax identification number of the provider.</p> <p>Note:</p> <p>On clicking the Search (🔍) icon that appears corresponding to the Provider's Tax Identification Number field, the Transaction Field Search window appears.</p> <p>On specifying the provider's tax identification number, the description of the provider's tax identification number appears corresponding to the Provider's Tax Identification Number field.</p>
Member ID	<p>Used to specify the member ID.</p> <p>Note:</p> <p>On clicking the Search (🔍) icon that appears corresponding to the Member ID field, the Transaction Field Search window appears.</p> <p>On specifying the member ID, the description of the member ID appears corresponding to the Member ID field.</p>
Main Subscriber ID	<p>Used to specify the customer ID.</p> <p>Note:</p> <p>On clicking the Search (🔍) icon that appears corresponding to the Main Subscriber ID field, the Transaction Field Search window appears.</p> <p>On specifying the main subscriber ID, the description of the main subscriber ID appears corresponding to the Main Subscriber ID field.</p>

Field Name	Field Description
Run-in Identifier	Used to specify the run-in identifier.
	<p>Note:</p> <p>On clicking the Search (🔍) icon that appears corresponding to the Run-in Identifier field, the Transaction Field Search window appears.</p> <p>On specifying the run-in identifier, the description of the run-in identifier appears corresponding to the Run-in Identifier field.</p>
Runout Identifier	Used to specify the runout identifier.
	<p>Note:</p> <p>On clicking the Search (🔍) icon that appears corresponding to the Runout Identifier field, the Transaction Field Search window appears.</p> <p>On specifying the runout identifier, the description of the runout identifier appears corresponding to the Runout Identifier field.</p>
Third Party Identifier	Used to specify the third party identifier to determine that the claim transaction is received from an external source system while defining a claim pricing rule type.
	<p>Note:</p> <p>On clicking the Search (🔍) icon that appears corresponding to the Third Party Identifier field, the Transaction Field Search window appears.</p> <p>On specifying the third party identifier, the description of the third party identifier appears corresponding to the Third Party Identifier field.</p>
Coverage Start Date	Used to specify the transaction coverage start date.
	<p>Note:</p> <p>On clicking the Search (🔍) icon that appears corresponding to the Coverage Start Date field, the Transaction Field Search window appears.</p> <p>On specifying the coverage start date, the description of the coverage start date appears corresponding to the Coverage Start Date field.</p>
Coverage End Date	Used to specify the transaction coverage end date.
	<p>Note:</p> <p>On clicking the Search (🔍) icon that appears corresponding to the Coverage End Date field, the Transaction Field Search window appears.</p> <p>On specifying the coverage end date, the description of the coverage end date appears corresponding to the Coverage End Date field.</p>

Field Name	Field Description
Retroactivity Indicator	Used to specify information of the retroactivity indicator.
	<p>Note:</p> <p>On clicking the Search (🔍) icon that appears corresponding to the Retroactivity Indicator field, the Transaction Field Search window appears.</p> <p>On specifying the retroactivity indicator, the description of the retroactivity indicator appears corresponding to the Retroactivity Indicator field.</p>
Network Indicator	Used to map to a transaction field which indicates whether the service provider is in network or out of network.
	<p>Note:</p> <p>On clicking the Search (🔍) icon that appears corresponding to the Network Indicator field, the Transaction Field Search window appears.</p> <p>On specifying the network indicator, the description of the network indicator appears corresponding to the Network Indicator field.</p>
Covered Charged Amount	Used to map to a transaction field which indicates the amount which is covered for the employee in the policy.
	<p>Note:</p> <p>On clicking the Search (🔍) icon that appears corresponding to the Covered Charged Amount field, the Transaction Field Search window appears.</p> <p>On specifying the covered charged amount, the description of the covered charged amount appears corresponding to the Covered Charged Amount field.</p>
Discount Savings Amount	Used to map to a transaction field which indicates the amount which is offered as the discount to the service provider.
	<p>Note:</p> <p>On clicking the Search (🔍) icon that appears corresponding to the Discount Savings Amount field, the Transaction Field Search window appears.</p> <p>On specifying the discount savings amount, the description of the discount savings amount appears corresponding to the Discount Savings Amount field.</p>

Field Name	Field Description
Accumulation Only Identifier	<p>Used to map to a transaction field which indicates that the claim transaction should only be used for calculating charges for the accumulated products, such as Specific Stop-Loss, Aggregate Stop-Loss, and so on. This means that the system should not derive the claim transaction leg. Instead, it should only derive the specific stop-loss or aggregate stop loss transaction legs for the claim transaction.</p> <p>Note:</p> <p>On clicking the Search (🔍) icon that appears corresponding to the Accumulation Only Identifier field, the Transaction Field Search window appears.</p> <p>On specifying the accumulation only identifier, the description of the accumulation only identifier appears corresponding to the Accumulation Only Identifier field.</p>
Billing Eligibility Identifier	<p>Used to specify whether the transaction is eligible for billing or not.</p> <p>Note:</p> <p>On clicking the Search (🔍) icon that appears corresponding to the Billing Eligibility Identifier field, the Transaction Field Search window appears.</p> <p>On specifying the billing eligibility identifier, the description of the billing eligibility identifier appears corresponding to the Billing Eligibility Identifier field.</p>
Transaction Upload Date	<p>Used to map to a transaction field which indicates the date when the transaction was uploaded in the external system. The system does not derive the discount transaction leg when the transaction upload date is later than the settlement date.</p> <p>Note:</p> <p>On clicking the Search (🔍) icon that appears corresponding to the Transaction Upload Date field, the Transaction Field Search window appears.</p> <p>On specifying the transaction upload date, the description of the transaction upload date appears corresponding to the Transaction Upload Date field.</p>
Claim Handling Fees Indicator	<p>Used to specify the claim handling fees which are applicable to one or more line items in the claim pricing rule.</p> <p>Note:</p> <p>On clicking the Search (🔍) icon that appears corresponding to the Claim Handling Fees Indicator field, the Transaction Field Search window appears.</p> <p>On specifying the claim handling fees indicator, the description of the claim handling fees indicator appears corresponding to the Claim Handling Fees Indicator field.</p>

2. Enter the required details in the **Transaction Field Mapping** section.
3. Click **Save**.

The transaction field mapping is defined for the primary pricing rule type.

Related Topics

For more information on...	See...
How to define a claim pricing rule type	Defining a Claim Pricing Rule Type on page 2547
How to define a specific stop-loss (SSL) pricing rule type	Defining a Specific Stop-Loss (SSL) Pricing Rule Type on page 2598
How to define an aggregate stop-loss (ASL) pricing rule type	Defining a Aggregate Stop-Loss (ASL) Pricing Rule Type on page 2634
How to define a retention type claim based pricing rule type	Defining a Retention Type Claim Based Pricing Rule Type on page 2669
How to define a retention type enrollment based pricing rule type	Defining a Retention Type Enrollment Based Pricing Rule Type on page 2698
How to define a one-time flat fee pricing rule type	Defining a One-Time Flat Fee Pricing Rule Type on page 2727
How to define a bill period based recurring flat fee pricing rule type	Defining a Bill Period Based Recurring Flat Fee Pricing Rule Type on page 2742
How to define a frequency based recurring flat fee pricing rule type	Defining a Frequency Based Recurring Flat Fee Pricing Rule Type on page 2757
How to edit a claim pricing rule type	Editing a Claim Pricing Rule Type on page 2572
How to edit a specific stop-loss (SSL) pricing rule type	Editing a Specific Stop-Loss (SSL) Pricing Rule Type on page 2603
How to edit an aggregate stop-loss (ASL) pricing rule type	Editing an Aggregate Stop-Loss (ASL) Pricing Rule Type on page 2639
How to edit a retention type claim based pricing rule type	Editing a Retention Type Claim Based Pricing Rule Type on page 2673
How to edit a retention type enrollment based pricing rule type	Editing a Retention Type Enrollment Based Pricing Rule Type on page 2702
How to edit a one-time flat fee pricing rule type	Editing a One-Time Flat Fee Pricing Rule Type on page 2731
How to edit a bill period based recurring flat fee pricing rule type	Editing a Bill Period Based Recurring Flat Fee Pricing Rule Type on page 2746
How to edit a frequency based recurring flat fee pricing rule type	Editing a Frequency Based Recurring Flat Fee Pricing Rule Type on page 2761

Associating Algorithms with a Pricing Rule Type**Prerequisites**

To associate algorithms with a pricing rule type, you should have:

- Algorithm and Algorithm Type defined in the application.
- System event defined in the application.

Procedure

To associate algorithms with a pricing rule type:

1. Ensure that the **Algorithms** section is expanded when you are defining a pricing rule type.

The **Algorithms** section contains the following columns in a grid:

Column Name	Column Description	Mandatory (Yes or No)
System Event	Used to indicate the system event on which the algorithm is executed. The valid values are: <ul style="list-style-type: none"> Account and Price Item Derivation Accumulation Billable Charge Post-Processing Accumulation Billable Charge Pre-Processing Accumulation Post-Processing Accumulation Pre-Processing Bill After Date Determination Bill Group Derivation Final Settlement Derivation Billable Charge Creation Pre-Processing Billable Charge Creation Post-Processing Pricing Rule Post-Processing Pricing Rule Pre-Processing Premium Calculation Transaction Validation 	Yes Note: This field is required when you are defining an algorithm for the pricing rule type.
Sequence	Used to specify the order in which the algorithms for each system event must be executed.	Yes (Conditional) Note: This field is required when you are defining an algorithm for the pricing rule type.
Algorithm	Used to specify the algorithm. Note: If you select the system event option, the Search (🔍) icon appears corresponding to the Algorithm field. On clicking the Search (🔍) icon, the Algorithm Search window appears. On specifying the algorithm, the description of the algorithm appears corresponding to the Algorithm field.	Yes (Conditional) Note: This field is required when you are defining an algorithm for the pricing rule type.

- Enter the required details in the **Algorithms** section.
- If you want to associate more than one algorithm for the pricing rule type, click the **Add** (+) icon and then repeat step 2.

Note: However, if you want to disassociate an algorithm from the pricing rule type, click the **Delete** (🗑️) icon corresponding to the algorithm.

- Click **Save**.
The algorithms are associated with the pricing rule type.

Related Topics

For more information on...	See...
How to define a claim pricing rule type	Defining a Claim Pricing Rule Type on page 2547
How to define a specific stop-loss (SSL) pricing rule type	Defining a Specific Stop-Loss (SSL) Pricing Rule Type on page 2598
How to define an aggregate stop-loss (ASL) pricing rule type	Defining a Aggregate Stop-Loss (ASL) Pricing Rule Type on page 2634
How to define a retention type claim based pricing rule type	Defining a Retention Type Claim Based Pricing Rule Type on page 2669
How to define a retention type enrollment based pricing rule type	Defining a Retention Type Enrollment Based Pricing Rule Type on page 2698
How to define a one-time flat fee pricing rule type	Defining a One-Time Flat Fee Pricing Rule Type on page 2727
How to define a bill period based recurring flat fee pricing rule type	Defining a Bill Period Based Recurring Flat Fee Pricing Rule Type on page 2742
How to define a frequency based recurring flat fee pricing rule type	Defining a Frequency Based Recurring Flat Fee Pricing Rule Type on page 2757
How to edit a claim pricing rule type	Editing a Claim Pricing Rule Type on page 2572
How to edit a specific stop-loss (SSL) pricing rule type	Editing a Specific Stop-Loss (SSL) Pricing Rule Type on page 2603
How to edit an aggregate stop-loss (ASL) pricing rule type	Editing an Aggregate Stop-Loss (ASL) Pricing Rule Type on page 2639
How to edit a retention type claim based pricing rule type	Editing a Retention Type Claim Based Pricing Rule Type on page 2673
How to edit a retention type enrollment based pricing rule type	Editing a Retention Type Enrollment Based Pricing Rule Type on page 2702
How to edit a one-time flat fee pricing rule type	Editing a One-Time Flat Fee Pricing Rule Type on page 2731
How to edit a bill period based recurring flat fee pricing rule type	Editing a Bill Period Based Recurring Flat Fee Pricing Rule Type on page 2746
How to edit a frequency based recurring flat fee pricing rule type	Editing a Frequency Based Recurring Flat Fee Pricing Rule Type on page 2761

Defining Additional Data for a Pricing Rule Type**Procedure**

To define additional data for a pricing rule type:

1. Ensure that the **Additional Data** section is expanded when you are defining a pricing rule type.

Note: This section does not appear when the Pricing Rule Type Category is Flat Fees .
--

The **Additional Data** section contains the following fields:

Field Name	Field Description
Eligible for Level Funding	Used to indicate whether the pricing rule type is eligible for level funding or not. The valid values are: <ul style="list-style-type: none"> • Yes • No
Eligible for Specific Stop-Loss	Used to whether the pricing rule type is eligible for specific stop-loss or not. The valid values are: <ul style="list-style-type: none"> • Yes • No <p>Note: This field appears when the option selected for the Pricing Rule Type Category is Claim, Retention Type Claim Based, or Retention Type Enrollment Based.</p>
Run-in Identifier Value	Used to specify the identifier value to determine that the ancillary transaction is received during the run-in period of the policy.
Third Party Identifier Value	Used to specify the identifier value to determine that the ancillary transaction is received from an external source system.
Accumulation Only Identifier Value	Used to specify the identifier value to determine that the ancillary transaction contains the accumulated information of ASL, SSL, and Level Funding pricing types.
Eligible for Write-Off in Post Runout	Used to indicate whether the pricing rule is eligible for Write-Off in Post Runout or not. The valid values are: <ul style="list-style-type: none"> • Yes • No
Post Runout Write-Off Adjustment Type	Used to specify the adjustment type using which the post runout write-off adjustments must be created.
Rule Based Price Item Eligibility Field	Used to specify the price item eligibility field that satisfies the pricing rule.
Rule Based Related Pricing Rule Type Eligibility Field	Used to specify the pricing rule type eligibility field that satisfies the pricing rule.
Rule Based Eligibility Value	Used to specify the eligibility value that satisfies the pricing rule.

2. Enter the required details in the **Additional Data** section.
3. Click **Save**.

The additional data is defined for the pricing rule type.

Related Topics

For more information on...	See...
How to define a claim pricing rule type	Defining a Claim Pricing Rule Type on page 2547
How to define a specific stop-loss (SSL) pricing rule type	Defining a Specific Stop-Loss (SSL) Pricing Rule Type on page 2598

For more information on...	See...
How to define an aggregate stop-loss (ASL) pricing rule type	Defining a Aggregate Stop-Loss (ASL) Pricing Rule Type on page 2634
How to define a retention type claim based pricing rule type	Defining a Retention Type Claim Based Pricing Rule Type on page 2669
How to define a retention type enrollment based pricing rule type	Defining a Retention Type Enrollment Based Pricing Rule Type on page 2698
How to define a one-time flat fee pricing rule type	Defining a One-Time Flat Fee Pricing Rule Type on page 2727
How to define a bill period based recurring flat fee pricing rule type	Defining a Bill Period Based Recurring Flat Fee Pricing Rule Type on page 2742
How to define a frequency based recurring flat fee pricing rule type	Defining a Frequency Based Recurring Flat Fee Pricing Rule Type on page 2757
How to edit the claim pricing rule type	Editing a Claim Pricing Rule Type on page 2572
How to edit the specific stop-loss (SSL) pricing rule type	Editing a Specific Stop-Loss (SSL) Pricing Rule Type on page 2603
How to edit the aggregate stop-loss (ASL) pricing rule type	Editing an Aggregate Stop-Loss (ASL) Pricing Rule Type on page 2639
How to edit the retention type claim based pricing rule type	Editing a Retention Type Claim Based Pricing Rule Type on page 2673
How to edit the retention type enrollment based pricing rule type	Editing a Retention Type Enrollment Based Pricing Rule Type on page 2702
How to edit a one-time flat fee pricing rule type	Editing a One-Time Flat Fee Pricing Rule Type on page 2731
How to edit a bill period based recurring flat fee pricing rule type	Editing a Bill Period Based Recurring Flat Fee Pricing Rule Type on page 2746
How to edit a frequency based recurring flat fee pricing rule type	Editing a Frequency Based Recurring Flat Fee Pricing Rule Type on page 2761

Adding Price Items in a Pricing Rule Type

Prerequisites

To add price items in a pricing rule type, you should have:

- Price items defined in the application
- Rate Options defined in the application
- Invoice Type defined in the application

Procedure

To add price items in a pricing rule type:

1. Ensure that the **Price Items** section is expanded when you are defining or editing a pricing rule type.

The **Price Items** section contains the following columns in a grid:

Column Name	Column Description						
Price Item	<p>Used to specify the price item information.</p> <p>Note:</p> <p>On clicking the Search (🔍) icon that appears corresponding to the Price Item field, the Price Item Search window appears.</p> <p>On specifying the price item, the description of the price item appears corresponding to the Price Items field.</p>						
Rate Option	<p>On clicking the Add (+) icon, the following column appears in a grid:</p> <table border="1"> <thead> <tr> <th>Column Name</th> <th>Column Description</th> <th>Mandatory (Yes or No)</th> </tr> </thead> <tbody> <tr> <td>Rate Option</td> <td> <p>Used to indicate the rate option for the price item. The valid values are:</p> <ul style="list-style-type: none"> • Aggregate Stop Loss • Ancillary • Claims • Discount Share • Enrollment Based Retention Per Member Per Month • Enrollment Based Retention Per Subscriber Per Month • Flat Dollar Per Claim - Aggregate Daily • Percentage of Claim - Aggregate Daily • Retention Claim Percentage Based Service Agreement • Retention - Aggregate Monthly • Specific Stop Loss • TFM Claim Weekly </td> <td> <p>Yes (Conditional)</p> <p>Note: This field is required when the Price Item field is present.</p> </td> </tr> </tbody> </table> <p>Note: The Rate Option column does not appear when the Pricing Rule Type Category is Flat Fees.</p>	Column Name	Column Description	Mandatory (Yes or No)	Rate Option	<p>Used to indicate the rate option for the price item. The valid values are:</p> <ul style="list-style-type: none"> • Aggregate Stop Loss • Ancillary • Claims • Discount Share • Enrollment Based Retention Per Member Per Month • Enrollment Based Retention Per Subscriber Per Month • Flat Dollar Per Claim - Aggregate Daily • Percentage of Claim - Aggregate Daily • Retention Claim Percentage Based Service Agreement • Retention - Aggregate Monthly • Specific Stop Loss • TFM Claim Weekly 	<p>Yes (Conditional)</p> <p>Note: This field is required when the Price Item field is present.</p>
Column Name	Column Description	Mandatory (Yes or No)					
Rate Option	<p>Used to indicate the rate option for the price item. The valid values are:</p> <ul style="list-style-type: none"> • Aggregate Stop Loss • Ancillary • Claims • Discount Share • Enrollment Based Retention Per Member Per Month • Enrollment Based Retention Per Subscriber Per Month • Flat Dollar Per Claim - Aggregate Daily • Percentage of Claim - Aggregate Daily • Retention Claim Percentage Based Service Agreement • Retention - Aggregate Monthly • Specific Stop Loss • TFM Claim Weekly 	<p>Yes (Conditional)</p> <p>Note: This field is required when the Price Item field is present.</p>					

Column Name	Column Description		
Bill To Account	On clicking the Add (+) icon, the following columns appear in a grid:		
	Column Name	Column Description	Mandatory (Yes or No)
	Priority	Used to specify the order in which the invoice type is considered for a price item.	Yes (Conditional) Note: This field is required when you are defining the invoice type.
Invoice Type	Used to specify the invoice type for the price item. Note: On clicking the Search (🔍) icon that appears corresponding to the Invoice Type field, the Invoice Type Search window appears.	No	

- Enter the required details in the **Price Items** section.
- If you want to define more than one price item for the pricing rule type, click the **Add** (+) icon and then repeat step 2.

Note: However, if you want to remove a price item from the pricing rule type, click the **Delete** (🗑️) icon corresponding to the price item.

- If you want to define more than one rate option to the price item for the pricing rule type, click the **Add** (+) icon and then repeat step 2.

Note: However, if you want to remove a rate option from the price item for the pricing rule type, click the **Delete** (🗑️) icon corresponding to the rate option.

- If you want to define more than one invoice types to the price item for the pricing rule type, click the **Add** (+) icon and then repeat step 2.

Note: However, if you want to remove a invoice type from the price item for the pricing rule type, click the **Delete** (🗑️) icon corresponding to the invoice type.

- Click **Save**.

The price items are added for the pricing rule type.

Related Topics

For more information on...	See...
How to define a claim pricing rule type	Defining a Claim Pricing Rule Type on page 2547
How to define a specific stop-loss (SSL) pricing rule type	Defining a Specific Stop-Loss (SSL) Pricing Rule Type on page 2598
How to define an aggregate stop-loss (ASL) pricing rule type	Defining a Aggregate Stop-Loss (ASL) Pricing Rule Type on page 2634

For more information on...	See...
How to define a retention type claim based pricing rule type	Defining a Retention Type Claim Based Pricing Rule Type on page 2669
How to define a retention type enrollment based pricing rule type	Defining a Retention Type Enrollment Based Pricing Rule Type on page 2698
How to define a one-time flat fee pricing rule type	Defining a One-Time Flat Fee Pricing Rule Type on page 2727
How to define a bill period based recurring flat fee pricing rule type	Defining a Bill Period Based Recurring Flat Fee Pricing Rule Type on page 2742
How to define a frequency based recurring flat fee pricing rule type	Defining a Frequency Based Recurring Flat Fee Pricing Rule Type on page 2757
How to edit the claim pricing rule type	Editing a Claim Pricing Rule Type on page 2572
How to edit the specific stop-loss (SSL) pricing rule type	Editing a Specific Stop-Loss (SSL) Pricing Rule Type on page 2603
How to edit the aggregate stop-loss (ASL) pricing rule type	Editing an Aggregate Stop-Loss (ASL) Pricing Rule Type on page 2639
How to edit the retention type claim based pricing rule type	Editing a Retention Type Claim Based Pricing Rule Type on page 2673
How to edit the retention type enrollment based pricing rule type	Editing a Retention Type Enrollment Based Pricing Rule Type on page 2702
How to edit a one-time flat fee pricing rule type	Editing a One-Time Flat Fee Pricing Rule Type on page 2731
How to edit a bill period based recurring flat fee pricing rule type	Editing a Bill Period Based Recurring Flat Fee Pricing Rule Type on page 2746
How to edit a frequency based recurring flat fee pricing rule type	Editing a Frequency Based Recurring Flat Fee Pricing Rule Type on page 2761

Adding a Price Item Parameter in a Pricing Rule Type

Prerequisites

To add a price item parameter in a pricing rule type, you should have:

- Parameters defined in the application
- Transaction field defined in the application
- Price item parameter associated with the price item

Procedure

To add a price item parameter in a pricing rule type:

1. Ensure that the **Price Item Parameters** section is expanded when you are defining or editing a pricing rule type.

The **Price Item Parameters** section contains the following columns in a grid:

Column Name	Column Description	Mandatory (Yes or No)
Price Item Parameter	Used to specify the parameter which you can use while defining the pricing for the price item.	Yes (Conditional)
	<p>Note:</p> <p>On clicking the Search (🔍) icon corresponding to the Price Item Parameter field, the Parameter Search window appears.</p> <p>On specifying the parameter, the description of the price item parameter appears corresponding to the Price Item Parameter field.</p>	<p>Note: This field is required when you are defining the pricing rule type.</p>
Transaction Field	Used to specify the transaction field from where the data should be retrieved.	Yes (Conditional)
	<p>Note:</p> <p>On clicking the Search (🔍) icon corresponding to the Transaction Field field, the Transaction Field Search window appears.</p> <p>On specifying the transaction field, the description of the transaction field appears corresponding to the Transaction Field.</p>	<p>Note: This field is required once the price item parameter is specified.</p>
Eligible for Specific Stop-Loss	Used to indicate whether the price item parameter can be used in the accumulation criteria.	No
Eligible for Level Funding	Used to specify whether the price item parameter can be used in level funding or not.	No

- Enter the required details in the **Price Item Parameters** section.
- If you want to add more than one price item parameter for the pricing rule type, click the **Add** (+) icon and then repeat step 2.

Note: However, if you want to remove a price item parameter from the pricing rule type, click the **Delete** (🗑️) icon corresponding to the price item parameter.

- Click **Save**.
A price item parameter is added for the pricing rule type.

Related Topics

For more information on...	See...
How to define a claim pricing rule type	Defining a Claim Pricing Rule Type on page 2547
How to define a specific stop-loss (SSL) pricing rule type	Defining a Specific Stop-Loss (SSL) Pricing Rule Type on page 2598
How to define an aggregate stop-loss (ASL) pricing rule type	Defining a Aggregate Stop-Loss (ASL) Pricing Rule Type on page 2634

For more information on...	See...
How to define a retention type claim based pricing rule type	Defining a Retention Type Claim Based Pricing Rule Type on page 2669
How to define a retention type enrollment based pricing rule type	Defining a Retention Type Enrollment Based Pricing Rule Type on page 2698
How to define a one-time flat fee pricing rule type	Defining a One-Time Flat Fee Pricing Rule Type on page 2727
How to define a bill period based recurring flat fee pricing rule type	Defining a Bill Period Based Recurring Flat Fee Pricing Rule Type on page 2742
How to define a frequency based recurring flat fee pricing rule type	Defining a Frequency Based Recurring Flat Fee Pricing Rule Type on page 2757
How to edit the claim pricing rule type	Editing a Claim Pricing Rule Type on page 2572
How to edit the specific stop-loss (SSL) pricing rule type	Editing a Specific Stop-Loss (SSL) Pricing Rule Type on page 2603
How to edit the aggregate stop-loss (ASL) pricing rule type	Editing an Aggregate Stop-Loss (ASL) Pricing Rule Type on page 2639
How to edit the retention type claim based pricing rule type	Editing a Retention Type Claim Based Pricing Rule Type on page 2673
How to edit the retention type enrollment based pricing rule type	Editing a Retention Type Enrollment Based Pricing Rule Type on page 2702
How to edit a one-time flat fee pricing rule type	Editing a One-Time Flat Fee Pricing Rule Type on page 2731
How to edit a bill period based recurring flat fee pricing rule type	Editing a Bill Period Based Recurring Flat Fee Pricing Rule Type on page 2746
How to edit a frequency based recurring flat fee pricing rule type	Editing a Frequency Based Recurring Flat Fee Pricing Rule Type on page 2761

Defining a Characteristic for a Pricing Rule Type

Prerequisites

To define the characteristics for a pricing rule type, you should have:

- Characteristic types defined in the application (where the characteristic entity is set to **Pricing Rule Type**)

Procedure

To define a characteristic for a pricing rule type:

1. Ensure that the **Characteristics** section is expanded when you are defining a pricing rule type.

The **Characteristics** section contains the following columns in a grid:

Column Name	Column Description	Mandatory (Yes or No)
Characteristic Type	Used to indicate the characteristic type.	Yes (Conditional)
	Note: The list includes only those characteristic types where the characteristic entity is set to Pricing Rule Type .	Note: This field is required when you are defining a characteristic for the pricing rule type.

Column Name	Column Description	Mandatory (Yes or No)
Characteristic Value	Used to specify the value for the characteristic type.	Yes (Conditional)
	<p>Note:</p> <p>If you select a predefined characteristic type, the Search (🔍) icon appears corresponding to the Characteristic Value field. On clicking the Search icon, the Predefined Characteristic Search window appears.</p> <p>On specifying the value for a predefined characteristic type, the description of the characteristic value appears corresponding to the Characteristic Value field.</p>	<p>Note: This field is required when you are defining a characteristic for the pricing rule type.</p>

- Enter the required details in the **Characteristics** section.
- If you want to define more than one characteristic for the pricing rule type, click the **Add** (+) icon and then repeat step 2.

Note: However, if you want to remove a characteristic from the pricing rule type, click the **Delete** (🗑️) icon corresponding to the characteristic.

- Click **Save**.

The characteristics are defined for the pricing rule type.

Related Topics

For more information on...	See...
How to define a claim pricing rule type	Defining a Claim Pricing Rule Type on page 2547
How to define a specific stop-loss (SSL) pricing rule type	Defining a Specific Stop-Loss (SSL) Pricing Rule Type on page 2598
How to define an aggregate stop-loss (ASL) pricing rule type	Defining a Aggregate Stop-Loss (ASL) Pricing Rule Type on page 2634
How to define a retention type claim based pricing rule type	Defining a Retention Type Claim Based Pricing Rule Type on page 2669
How to define a retention type enrollment based pricing rule type	Defining a Retention Type Enrollment Based Pricing Rule Type on page 2698
How to define a one-time flat fee pricing rule type	Defining a One-Time Flat Fee Pricing Rule Type on page 2727
How to define a bill period based recurring flat fee pricing rule type	Defining a Bill Period Based Recurring Flat Fee Pricing Rule Type on page 2742
How to define a frequency based recurring flat fee pricing rule type	Defining a Frequency Based Recurring Flat Fee Pricing Rule Type on page 2757
How to edit the claim pricing rule type	Editing a Claim Pricing Rule Type on page 2572
How to edit the specific stop-loss (SSL) pricing rule type	Editing a Specific Stop-Loss (SSL) Pricing Rule Type on page 2603

For more information on...	See...
How to edit the aggregate stop-loss (ASL) pricing rule type	Editing an Aggregate Stop-Loss (ASL) Pricing Rule Type on page 2639
How to edit the retention type claim based pricing rule type	Editing a Retention Type Claim Based Pricing Rule Type on page 2673
How to edit the retention type enrollment based pricing rule type	Editing a Retention Type Enrollment Based Pricing Rule Type on page 2702
How to edit a one-time flat fee pricing rule type	Editing a One-Time Flat Fee Pricing Rule Type on page 2731
How to edit a bill period based recurring flat fee pricing rule type	Editing a Bill Period Based Recurring Flat Fee Pricing Rule Type on page 2746
How to edit a frequency based recurring flat fee pricing rule type	Editing a Frequency Based Recurring Flat Fee Pricing Rule Type on page 2761

Adding Claim Templates in a Claim Pricing Rule Type

Prerequisites

To add claim templates in a claim pricing rule type, you should have:

- Claim templates defined in the application

Procedure

To add claim templates in a claim pricing rule type:

1. Ensure that the **Claim Templates** section is expanded when you are defining or editing a pricing rule type.

The **Claim Templates** section contains the following columns in a grid:

Column Name	Column Description	Mandatory (Yes or No)
Claim Template	Used to indicate the claim template.	Yes (Conditional)
		Note: This field is required when you are defining a claim template for the pricing rule type.

2. Enter the required details in the **Claim Templates** section.
3. If you want to define more than one claim template for the pricing rule type, click the **Add (+)** icon and then repeat step 2.

Note: However, if you want to remove a claim template from the pricing rule type, click the **Delete (🗑)** icon corresponding to the claim template.

4. Click **Save**.

The claim templates are defined for the pricing rule type.

Related Topics

For more information on...	See...
How to define a claim pricing rule type	Defining a Claim Pricing Rule Type on page 2547

For more information on...	See...
How to define a specific stop-loss (SSL) pricing rule type	Defining a Specific Stop-Loss (SSL) Pricing Rule Type on page 2598
How to define an aggregate stop-loss (ASL) pricing rule type	Defining a Aggregate Stop-Loss (ASL) Pricing Rule Type on page 2634
How to define a retention type claim based pricing rule type	Defining a Retention Type Claim Based Pricing Rule Type on page 2669
How to define a retention type enrollment based pricing rule type	Defining a Retention Type Enrollment Based Pricing Rule Type on page 2698
How to edit the claim pricing rule type	Editing a Claim Pricing Rule Type on page 2572
How to edit the specific stop-loss (SSL) pricing rule type	Editing a Specific Stop-Loss (SSL) Pricing Rule Type on page 2603
How to edit the aggregate stop-loss (ASL) pricing rule type	Editing an Aggregate Stop-Loss (ASL) Pricing Rule Type on page 2639
How to edit the retention type claim based pricing rule type	Editing a Retention Type Claim Based Pricing Rule Type on page 2673
How to edit the retention type enrollment based pricing rule type	Editing a Retention Type Enrollment Based Pricing Rule Type on page 2702

Adding the Claim-Specific Data in a Pricing Rule Type

Procedure

To add the Claim-Specific additional data in a pricing rule type:

1. Ensure that the **Claim-Specific Additional Data** section is expanded when you are defining or editing a pricing rule type.

The **Claim-Specific Additional Data** section contains the following fields:

Field Name	Field Description	Mandatory (Yes or No)
Rule Based Billing Eligibility Field	Used to specify whether the rule based field is eligible for billing or not. Note: On clicking the Search (🔍) icon that appears corresponding to the Rule Based Billing Eligibility Field field, the Field Search window appears. On specifying the field, the description of the field appears corresponding to the Rule Based Billing Eligibility Field field.	No

Field Name	Field Description	Mandatory (Yes or No)
Rule Based Markup or Markdown Eligibility Field	<p>Used to specify whether the rule based markup or markdown field is eligible for billing or not.</p> <p>Note:</p> <p>On clicking the Search (🔍) icon that appears corresponding to the Rule Based Markup or Markdown Eligibility Field field, the Field Search window appears.</p> <p>On specifying the field, the description of the field appears corresponding to the Rule Based Markup or Markdown Eligibility Field field.</p>	No
Markup or Markdown Billable Charge Line Type	<p>Used to specify the markup or markdown billable charge line type.</p> <p>Note:</p> <p>On clicking the Search (🔍) icon that appears corresponding to the Markup or Markdown Billable Charge Line Type field, the Billable Charge Line Type Search window appears.</p> <p>On specifying the billable charge line type, the description of the billable charge line type appears corresponding to the Markup or Markdown Billable Charge Line Type field.</p>	No

2. Enter the required details in the **Claim-Specific Additional Data** section.
3. Click **Save**.

The Claim-Specific Additional data is added in the pricing rule type.

Related Topics

For more information on...	See...
How to define a claim pricing rule type	Defining a Claim Pricing Rule Type on page 2547
How to edit the claim pricing rule type	Editing a Claim Pricing Rule Type on page 2572

Adding Claim Handling Fees Indicator in a Claim Pricing Rule Type

Procedure

To add claim handling fees indicator in a claim pricing rule type:

1. Ensure that the **Claim Handling Fees Indicator** section is expanded when you are defining or editing a claim pricing rule type.

The **Claim Handling Fees Indicator** section contains the following fields in a grid:

Field Name	Field Description	Mandatory (Yes or No)
Fee	Used to indicate the charge type category for the claim pricing rule type.	Yes (Conditional) Note: This field is required while adding claim handling fees indicator in a claim pricing rule.
Fee Indicator	Used to specify the charge type sub category for the claim pricing rule type.	No

- Enter the required details in the **Claim Handling Fees Indicator** section.
- If you want to define more than one claim handling fees indicator for the claim pricing rule type, click the **Add (+)** icon and then repeat step 2.

Note: However, if you want to remove a claim handling fees indicator from the claim pricing rule type, click the **Delete (🗑)** icon corresponding to the fee.

- Click **Save**.

The claim handling fees indicator is defined for the claim pricing rule type.

Related Topics

For more information on...	See...
How to define a claim pricing rule type	Defining a Claim Pricing Rule Type on page 2547
How to define a specific stop-loss (SSL) pricing rule type	Defining a Specific Stop-Loss (SSL) Pricing Rule Type on page 2598
How to define an aggregate stop-loss (ASL) pricing rule type	Defining a Aggregate Stop-Loss (ASL) Pricing Rule Type on page 2634
How to define a retention type claim based pricing rule type	Defining a Retention Type Claim Based Pricing Rule Type on page 2669
How to define a retention type enrollment based pricing rule type	Defining a Retention Type Enrollment Based Pricing Rule Type on page 2698
How to edit the claim pricing rule type	Editing a Claim Pricing Rule Type on page 2572
How to edit the specific stop-loss (SSL) pricing rule type	Editing a Specific Stop-Loss (SSL) Pricing Rule Type on page 2603
How to edit the aggregate stop-loss (ASL) pricing rule type	Editing an Aggregate Stop-Loss (ASL) Pricing Rule Type on page 2639
How to edit the retention type claim based pricing rule type	Editing a Retention Type Claim Based Pricing Rule Type on page 2673
How to edit the retention type enrollment based pricing rule type	Editing a Retention Type Enrollment Based Pricing Rule Type on page 2702

Editing a Claim Pricing Rule Type

Prerequisites

To edit the claim pricing rule type, you should have:

- Business Object **C1-PricingRuleClaim** defined for pricing rule.
- Pricing rule type category for claim defined in the application

Procedure

To edit a claim pricing rule type:

1. Click the **Admin** link in the **Application** toolbar.
A list appears.
2. From the **Admin** menu, select **P** and then click **Pricing Rule Type**.
A sub-menu appears.
3. Click the **Search** option from the **Pricing Rule Type** sub-menu.
The **Pricing Rule Type** screen appears.
4. In the **Pricing Rule Type List** zone, click the **Edit** (✎) icon in the **Edit** column corresponding to the pricing rule type for claim whose details you want to edit.

The **Claim Pricing Rule Type** screen appears. It contains the following sections:

- **Main** – Used to specify basic details about the claim pricing rule type.
- **Related Pricing Rule Types** – Used to define the pricing rule types which are related to the parent pricing rule type.
- **Transaction Field Mapping** – Used to specify the transaction related data mapped to the pricing rule type
- **Algorithms** – Used to define the algorithms used for the pricing rule type.
- **Additional Data** – Used to specify the additional information about the pricing rule type.
- **Price Items** – Used to define the price items assigned to the pricing rule type.
- **Price Item Parameters** – Used to define the price item parameters in the pricing rule type.
- **Characteristics** – Used to define the characteristics for the pricing rule type.
- **Claim Templates** – Used to define the pricing rule type for claim template.
- **Claim-Specific Additional Data** – Used to specify the claim specific additional data.

The **Main** section contains the following fields:

Field Name	Field Description	Mandatory (Yes or No)
Pricing Rule Type	Displays the pricing rule type.	Not applicable
Description	Used to specify the description for the pricing rule type.	Yes
Detailed Description	Used to specify additional information about the pricing rule type.	No

Field Name	Field Description	Mandatory (Yes or No)
Related Transaction Business Object	Used to indicate the pricing rule business object. The valid values are: <ul style="list-style-type: none"> • Claim Pricing Rule • Aggregate Stop-Loss (ASL) Pricing Rule • Specific Stop-Loss (SSL) Pricing Rule • Retention Type Claim Based Pricing Rule • Retention Type Enrollment Based Pricing Rule 	Yes
Business Object	Displays the pricing rule type business object for claim.	Not applicable
Status	Used to indicate the status of the pricing rule type. The valid values are: <ul style="list-style-type: none"> • Active • Inactive 	Yes
Primary	Used to select the checkbox if the pricing rule type is primary.	No
Pricing Rule Type Category	Used to indicate the pricing rule type category for the pricing rule type. The valid values are: <ul style="list-style-type: none"> • Claim • Aggregate Stop-Loss • Specific Stop-Loss • Retention Type Claim Based • Retention Type Enrollment Based 	Yes

Tip: Alternatively, you can click the **Edit** button in the **Pricing Rule Type** zone to edit the pricing rule type for claim.

5. Modify the details in the **Main** section, if required.
6. Add, edit, or remove the related pricing rule types in the primary pricing rule type, if required.
7. Modify the transaction field mapping in the primary pricing rule type, if required.
8. Add, edit, or remove algorithms with the pricing rule type, if required.
9. Modify the additional data for the pricing rule type, if required.
10. Add, edit, or remove pricing items in the pricing rule type, if required.
11. Add, edit, or remove price item parameters in the pricing rule type, if required.
12. Add, edit, or remove characteristics for the pricing rule type, if required.
13. Add, edit, or remove claim templates in the claim pricing rule type, if required.
14. Modify the claim-specific data in the pricing rule type, if required.
15. Click **Save**.

The changes made to the claim pricing rule type are saved.

Related Topics

For more information on...	See...
Pricing Rule Type screen	Pricing Rule Type on page 2532
Pricing Rule Type List zone	Pricing Rule Type List on page 2533
Pricing Rule Type zone	Pricing Rule Type on page 2536
How to add the related pricing rule types in the primary pricing rule type	Adding Related Pricing Rule Types in a Primary Pricing Rule Type on page 2549
How to define the transaction field mapping in the primary pricing rule type	Defining Transaction Field Mapping in a Primary Pricing Rule Type on page 2551
How to associate algorithms with the pricing rule type	Associating Algorithms with a Pricing Rule Type on page 2557
How to define additional data for the pricing rule type	Defining Additional Data for a Pricing Rule Type on page 2559
How to add pricing items in the pricing rule type	Adding Price Items in a Pricing Rule Type on page 2561
How to add price item parameters in the pricing rule type	Adding a Price Item Parameter in a Pricing Rule Type on page 2564
How to define a characteristic for the pricing rule type	Defining a Characteristic for a Pricing Rule Type on page 2566
How to add claim templates in the claim pricing rule type	Adding Claim Templates in a Claim Pricing Rule Type on page 2568
How to add the claim-specific data in the pricing rule type	Adding the Claim-Specific Data in a Pricing Rule Type on page 2569

Deleting a Claim Pricing Rule Type

Procedure

To delete a claim pricing rule type:

1. Click the **Admin** link in the **Application** toolbar.
A list appears.
2. From the **Admin** menu, select **P** and then click **Pricing Rule Type**.
A sub-menu appears.
3. Click the **Search** option from the **Pricing Rule Type** sub-menu.
The **Pricing Rule Type** screen appears.

- In the **Pricing Rule Type List** zone, click the **Delete** (🗑️) icon in the **Delete** column corresponding to the claim pricing rule type that you want to delete.

A message appears confirming whether you want to delete the claim pricing rule type.

Note: You can delete a claim pricing rule type when it is not yet used in the system.

Tip: Alternatively, you can delete a claim pricing rule type by clicking the **Delete** button in the **Pricing Rule Type** zone.

- Click **OK**.

The claim pricing rule type is deleted.

Related Topics

For more information on...	See...
Pricing Rule Type screen	Pricing Rule Type on page 2532
Pricing Rule Type List zone	Pricing Rule Type List on page 2533
Pricing Rule Type zone	Pricing Rule Type on page 2536

Viewing the Claim Pricing Rule Type Details

Procedure

To view the details of a claim pricing rule type:

- Click the **Admin** link in the **Application** toolbar.
A list appears.
- From the **Admin** menu, select **P** and then click **Pricing Rule Type**.
A sub-menu appears.
- Click the **Search** option from the **Pricing Rule Type** sub-menu.
The **Pricing Rule Type** screen appears.
- In the **Pricing Rule Type List** zone, click the **Broadcast** (📡) icon corresponding to the claim pricing rule type whose details you want to view.
The **Pricing Rule Type** zone appears.
- View the details of the claim pricing rule type in the **Pricing Rule Type** zone.

Related Topics

For more information on...	See...
Pricing Rule Type screen	Pricing Rule Type on page 2532
Pricing Rule Type List zone	Pricing Rule Type List on page 2533
Pricing Rule Type zone	Pricing Rule Type on page 2536

Defining a Claim Pricing Rule for a Parent Customer

Prerequisites

To define a claim pricing rule for a parent customer, you should have:

- Business Object **C1-PricingRule** defined for pricing rule.
- Business Object **C1-PricingRuleClaim** defined for claim pricing rule.
- Pricing rule type defined in the application.
- Price item defined in the application.
- Rate options defined in the Rate Option (**C1-ExtLookRateType**) extendable lookup.
- Claim template defined in the Claim Template (**C1-ExtLookClaimTemplate**) extendable lookup.
- Line items defined in the Line Item (**C1-ExtLookPricingRuleLineItem**) extendable lookup.

Procedure

To define a claim pricing rule for a parent customer:

1. Search for the account, person, or policy whose pricing details you want to view in the **Customer 360° View** screen.
2. In the **Search Results** section, click the **View** () icon corresponding to the account, person, or policy whose pricing details you want to view.

The **Account**, **Person**, or **Policy** tab in the **Customer 360° Information** screen appears.

3. Click the **Pricing** tab and then click the **Add** link in the upper right corner of the **Parent Customer Pricing Rules** zone.

The **Pricing Rule** screen appears. It contains the following fields:

Field Name	Field Description	Mandatory (Yes or No)
Person Name	Displays the person name.	Not applicable
Person Type	Displays the person type.	Not applicable
Pricing Rule Type	Used to indicate the pricing rule type to create the pricing rule. Note: You can create a claim pricing rule using the Pricing Rule Type for claim.	Yes

4. Click **OK**.

The **Claim Pricing Rule** screen appears. It contains the following sections:

- **Customer Information** – Displays the customer information.
- **Main** – Used to specify basic details about the claim pricing rule.
- **Claim Handling Fees** – Used to define the claim handling fees for the line items in the claim pricing rule.
- **Markup or Markdown Values** – Used to define the markup or markdown values for the line items in the claim pricing rule.
- **Line Items** – Used to associate line items eligible for billing in the claim pricing rule.
- **Characteristics** – Used to define the characteristics for the claim pricing rule.

The **Customer Information** section contains the following fields:

Field Name	Field Description
Parent Customer Information	Displays the parent customer information.
Pricing Rule Type	Indicates the pricing rule type.

Field Name	Field Description
Status	Indicates the status of the parent customer for the claim pricing rule. The valid values are: <ul style="list-style-type: none"> • Active • Inactive • Pending

The **Main** section contains the following fields:

Field Name	Field Description	Mandatory (Yes or No)
Price Item	Used to indicate the price item.	Yes
Pricing Start Date	Used to specify the pricing rule start date. Note: This field is enabled when an option from Price Item field is selected. By default it displays the Policy Start Date .	Yes
Pricing End Date	Used to specify the pricing rule end date. Note: This field is enabled when an option from Price Item field is selected. By default it displays the Policy End Date .	Yes
Rate Option	Used to indicate the rate option to define the claim pricing rule for the price item.	Yes
Claim Template	Used to indicate the claim template to define the claim pricing rule for a parent customer. Note: This field is enabled for selection when an option from Price Item field is selected.	Yes

5. Enter the required details in the **Main** section.
6. Define the claim handling fees for the line items in a claim pricing rule, if required.

Note: The **Claim Handling Fees** section appears when an option from **Claim Template** field is selected.

7. Define the markup or markdown values for the line items in a claim pricing rule, if required.

Note: The **Markup or Markdown Values** section appears when an option from **Claim Template** field is selected.

8. Define line items in a claim pricing rule, if required.

Note: The **Line Items** section appears when an option from **Claim Template** field is selected.

9. Define characteristics for a claim pricing rule, if required.

10. Click Save.

The claim pricing rule for a parent customer is defined.

Related Topics

For more information on...	See...
Customer 360° Information – Pricing tab	Customer 360° Information - Pricing Information on page 693
Parent Customer Pricing Rules zone	Parent Customer Pricing Rules on page 696
How to define claim handling fees on line items in a claim pricing rule	Defining the Claim Handling Fees For Line Items in a Claim Pricing Rule
How to define markup or markdown values on line items in a claim pricing rule	Defining the Markup or Markdown Values For Line Items in a Claim Pricing Rule on page 2578
How to define line items in a claim pricing rule	Defining the Line Items in a Claim Pricing Rule
How to define a characteristic for a claim pricing rule	Defining a Characteristic for a Claim Pricing Rule on page 2581

Defining the Markup or Markdown Values For Line Items in a Claim Pricing Rule**Procedure**

To define the markup or markdown values for the line items in a claim pricing rule:

1. Ensure that the **Markup or Markdown Values** section is expanded when you have selected an option from the **Claim Template** field of **Main** section while defining a claim pricing rule.

The **Markup or Markdown Values** section contains the following fields:

Field Name	Field Description	Mandatory (Yes or No)
Pricing Strategy	Used to indicate the pricing strategy. The valid values are: <ul style="list-style-type: none"> • Markdown • Markup • None 	No
	Note: This field is disabled when the Post Run Out Claims option is selected from the Claim Template field of the Main section.	
Markup or Markdown Type	Used to indicate the markup or markdown value type for claim pricing rule. The valid values are: <ul style="list-style-type: none"> • Flat Amount • Percentage 	No
	Note: This field is disabled when the Post Run Out Claims option is selected from the Claim Template field of Main section.	

Field Name	Field Description	Mandatory (Yes or No)
Markup or Markdown Amount	Used to specify the markup or markdown amount.	Yes (Conditional)
	Note: This field is disabled when you select, <ul style="list-style-type: none"> the Post Run Out Claims option from the Claim Template field of the Main section. or the Percentage option from the Markup or Markdown Type field. 	Note: This field is required when you select Flat Amount option from the Markup or Markdown Type field.
Rate Type	Indicates the minimum and maximum markup or markdown defined using the rate type.	Not applicable
Rate Value	Used to specify the value for minimum and maximum markup or markdown using the rate type.	Yes (Conditional)
	Note: This field is editable only when the Editable checkbox is selected in the Rate column of the Additional Fees section while defining or editing the C1-ExtLookClaimTemplate extendable lookup.	Note: This field is required when you select Percentage option from the Markup or Markdown Type field.

2. Enter the required details in the **Markup or Markdown Values** section.
3. Click **Save**.

The markup or markdown values for the line items are defined for the claim pricing rule.

Related Topics

For more information on...	See...
How to define a claim pricing rule for a parent customer	Defining a Claim Pricing Rule for a Parent Customer on page 2575
How to edit the claim pricing rule for a parent customer	Editing a Claim Pricing Rule of a Parent Customer on page 2582

Defining the Markup or Markdown Values for Line Items for Each Rule in a Claim Pricing Rule

Procedure

To define the markup or markdown values for line items for each rule in a claim pricing rule:

1. Ensure that sections for each rule are expanded when you have selected an option from the **Claim Template** field of **Main** section while defining a claim pricing rule.
2. Expand the **Markup or Markdown Values** and **Line Items** sections relevant to each rule.

The **Markup or Markdown Values** section contains the following fields:

Field Name	Field Description	Mandatory (Yes or No)
Pricing Strategy	Used to indicate the pricing strategy. The valid values are: <ul style="list-style-type: none"> • Markdown • Markup • None 	No
Markup or Markdown Type	Used to indicate the markup or markdown value type for claim pricing rule. The valid values are: <ul style="list-style-type: none"> • Flat Amount • Percentage 	No
Markup or Markdown Amount	Used to specify the markup or markdown amount.	Yes (Conditional)
	Note: This field is disabled when you select the Flat Amount option from the Markup or Markdown Type field.	Note: This field is required when you selecting Percentage option from the Markup or Markdown Type field.

The **Line Items** section contains the following fields:

Field Name	Field Description	Mandatory (Yes or No)
Sequence	Displays the sequence number for the line items.	Not applicable
Line Item	Displays the billing line items.	Not applicable
Billing Eligibility	Displays whether the line item is user defined, eligible or not eligible for billing. The valid values are: <ul style="list-style-type: none"> • Eligible • Not Eligible • User Defined (Default Yes) • User Defined (Default No) 	Not applicable
User Defined Billing Option	Used to specify whether the billing option is user defined, eligible or not eligible.	Yes
	Note: The checkbox for this field is by default checked and disabled for values Eligible , Rule Based , or Not Eligible in the Billing Eligibility field. The checkbox for this field is enabled for values User Defined (Default Yes) or User Defined (Default No) in the Billing Eligibility .	

Field Name	Field Description	Mandatory (Yes or No)
Markup or Markdown Percentage Eligibility	Displays whether the line item is eligible or not eligible for markup or markdown percentage. The valid values are: <ul style="list-style-type: none"> Eligible Not Eligible 	Not applicable
Markup or Markdown Percentage	Used to specify the percentage for markup or markdown value. Note: This field is enabled when the Markup or Markdown Percentage Eligibility is Eligible and when the Markup or Markdown Type is Percentage .	Yes

- Enter the required details in the **Markup or Markdown Values** section.
- Enter the required details in the **Line Items** section.
- Click **Save**.

The markup or markdown values for line items for each rule are defined in the claim pricing rule.

Related Topics

For more information on...	See...
How to define a claim pricing rule for a bill group using a pricing group	Defining a Claim Pricing Rule for a Bill Group Using a Pricing Group on page 2589
How to edit the claim pricing rule of a bill group	Editing a Claim Pricing Rule of a Bill Group on page 2592

Defining a Characteristic for a Claim Pricing Rule

Prerequisites

To define a characteristic for a claim pricing rule, you should have:

- Characteristic types defined in the application (where the characteristic entity is set to **Pricing Rule**)

Procedure

To define a characteristic for a claim pricing rule:

- Ensure that the **Characteristics** section is expanded when you are defining or editing a pricing rule.

The **Characteristics** section contains the following fields in a grid:

Field Name	Field Description	Mandatory (Yes or No)
Effective Date	Used to specify the date from when the characteristic is effective for the claim pricing rule.	Yes (Conditional) Note: This field is required when you are defining a characteristic for the claim pricing rule.

Field Name	Field Description	Mandatory (Yes or No)
Characteristic Type	Used to indicate the characteristic type.	Yes (Conditional)
	Note: The list includes only those characteristic types where the characteristic entity is set to Pricing Rule .	Note: This field is required when you are defining a characteristic for the claim pricing rule.
Characteristic Value	Used to specify the value for the characteristic type.	Yes (Conditional)
	Note: If you select a predefined characteristic type, the Search (🔍) icon appears corresponding to the Characteristic Value field. On clicking the Search icon, the Predefined Characteristic Search window appears. On specifying the value for a predefined characteristic type, the description of the characteristic value appears corresponding to the Characteristic Value field.	Note: This field is required when you are defining a characteristic for the claim pricing rule.

- Enter the required details in the **Characteristics** section.
- If you want to define more than one characteristic for the claim pricing rule, click the **Add** (+) icon and then repeat step 2.

Note: However, if you want to remove a characteristic from the claim pricing rule, click the **Delete** (🗑️) icon corresponding to the characteristic.

- Click **Save**.

The characteristics are defined for the claim pricing rule.

Related Topics

For more information on...	See...
How to define a claim pricing rule for a parent customer	Defining a Claim Pricing Rule for a Parent Customer on page 2575
How to edit the claim pricing rule for a parent customer	Editing a Claim Pricing Rule of a Parent Customer on page 2582

Editing a Claim Pricing Rule of a Parent Customer

Prerequisites

To edit a claim pricing rule of a parent customer, you should have:

- Business Object **C1-PricingRuleClaim** defined for claim pricing rule.
- Rate options defined in the Rate Option (**C1-ExtLookRateType**) extendable lookup.
- Claim template defined in the Claim Template (**C1-ExtLookClaimTemplate**) extendable lookup.
- Line items defined in the Line Item (**C1-ExtLookPricingRuleLineItem**) extendable lookup.

Procedure

To edit a claim pricing rule of a parent customer:

1. Search for the account, person, or policy whose pricing details you want to view in the **Customer 360° View** screen.
2. In the **Search Results** section, click the **View** (🔗) icon corresponding to the account, person, or policy whose pricing details you want to view.

The **Account, Person, or Policy** tab in the **Customer 360° Information** screen appears.

3. Click the **Pricing Information** tab.

The **Pricing Information** tab appears.

4. In the **Parent Customer Pricing Rules** zone, click the **Edit** (✎) icon in the **Edit** column corresponding to the pricing rule type for claim whose claim pricing rule details you want to edit.

The **Claim Pricing Rule** screen appears. It contains the following sections:

- **Customer Information** – Displays the customer information.
- **Main** – Used to specify basic details about the claim pricing rule.
- **Claim Handling Fees** – Used to define the claim handling fees for the lines items in the claim pricing rule.
- **Markup or Markdown Values** – Used to define the markup or markdown values for the lines items in the claim pricing rule.
- **Line Items** – Used to associate line items eligible for billing in the claim pricing rule.
- **Characteristics** – Used to define the characteristics for the claim pricing rule.

The **Customer Information** section contains the following fields:

Column Name	Column Description
Parent Customer Information	Displays the parent customer information
Pricing Rule Type	Indicates the pricing rule type.
Status	Indicates the status of the parent customer for the claim pricing rule. The valid values are: <ul style="list-style-type: none"> • Active • Inactive • Pending

The **Main** section contains the following fields:

Field Name	Field Description	Mandatory (Yes or No)
Price Item	Used to indicate the price item for which you want to edit the pricing.	Yes
Pricing Start Date	Used to specify the start date from when the pricing will be effective for the price item.	Yes (Conditional)
	Note: The pricing start date cannot be later than the pricing end date.	
		Note: Pricing Start Date should be entered if Pricing End Date has been mentioned.

Field Name	Field Description	Mandatory (Yes or No)
Pricing End Date	Used to specify the end date till when the pricing will be effective for the price item.	No
	Note: The pricing end date cannot be earlier than the pricing start date.	
Rate Option	Used to indicate the rate option that you want to use while editing the pricing for the price item.	Yes
Claim Template	Used to indicate the claim template of the claim pricing rule for a parent customer.	Yes (Conditional)
		Note: This field is required when you are reapplying for a claim template.

Note: This section also consists of a button, **Reapply**, on clicking the button a message occurs indicating that updating the claim template will reset all the default fields on the pricing rule.

5. Modify the details in the **Main** section, if required.
6. Modify the claim handling fees specified for the line items in a claim pricing rule, if required.
7. Modify the markup or markdown values for the line items in a claim pricing rule, if required.
8. Modify the line items in a claim pricing rule, if required.
9. Add, edit, or remove characteristics for a claim pricing rule, if required.
10. Click **Save**.

The changes made to a claim pricing rule for a parent customer are saved.

Related Topics

For more information on...	See...
Customer 360° Information – Pricing tab	Customer 360° Information - Pricing Information on page 693
Parent Customer Pricing Rules zone	Parent Customer Pricing Rules on page 696
How to define claim handling fees for line items in a claim pricing rule	Defining the Claim Handling Fees For Line Items in a Claim Pricing Rule
How to define markup or markdown values for line items in a claim pricing rule	Defining the Markup or Markdown Values For Line Items in a Claim Pricing Rule on page 2578
How to define a characteristic for a claim pricing rule	Defining a Characteristic for a Claim Pricing Rule on page 2581

Viewing a Claim Pricing Rule of a Parent Customer

Procedure

To view a claim pricing rule of a parent customer:

1. Search for a parent customer whose pricing details you want to view in the **Customer 360° View** screen.
2. In the **Search Results** section, click the **View** () icon corresponding to the account, person, or policy whose pricing details you want to view.

The **Person** tab appears in the **Customer 360° Information** screen

3. Click the **Pricing** tab.

The **Pricing** tab appears.

4. In the **Parent Customer Pricing Rules** zone, click the link in the **Pricing Rule Information** column corresponding to the claim pricing rule type whose claim pricing rule parent customer details you want to view.

The **Claim** screen appears. It contains the following zone:

- **Claim** – Displays the pricing rule claim details for a parent customer. It contains the following sections:
 - **Main** – Displays the basic details of the claim pricing rule.
 - **Claim Handling Fees** – Displays the claim handling fees defined for the lines items in the claim pricing rule.
 - **Markup or Markdown Values** – Displays the markup or markdown values for the lines items in the claim pricing rule.
 - **Line Items** – Displays the associated line items eligible for billing in the claim pricing rule.
 - **Characteristics** – Displays the characteristics defined for the claim pricing rule.
5. View the basic details of claim pricing rule in the **Main** section.
 6. View the claim handling fees defined for the line items in the **Claim Handling Fees** section.
 7. View the markup or markdown values for the lines items in the **Markup or Markdown Values** section.
 8. View the associated line items eligible for billing in the **Line Items** section.
 9. View the characteristics of the claim pricing rule in the **Characteristics** section.



Related Topics

For more information on...	See...
Customer 360° Information – Pricing tab	Customer 360° Information - Pricing Information on page 693
Parent Customer Pricing Rules zone	Parent Customer Pricing Rules on page 696
Pricing Rule screen	Pricing Rule (Used for Viewing) on page 2902
Claim zone	Claim on page 2903

Deleting a Claim Pricing Rule of a Parent Customer

Procedure

To delete a claim pricing rule of a parent customer:

1. Search for the account, person, or policy whose pricing details you want to view in the **Customer 360° View** screen.
2. In the **Search Results** section, click the **View** () icon corresponding to the account, person, or policy whose pricing details you want to view.
The **Account**, **Person**, or **Policy** tab in the **Customer 360° Information** screen appears.
3. Click the **Pricing** tab, in the **Parent Customer Pricing Rules** zone, click the **Delete** () icon in the **Delete** column corresponding to the claim pricing rule type whose claim pricing rule you want to delete.
A message appears confirming whether you want to delete the claim pricing rule.
4. Click **OK**.

The claim pricing rule of a parent customer is deleted.

Related Topics

For more information on...	See...
Customer 360° Information – Pricing tab	Customer 360° Information - Pricing Information on page 693
Parent Customer Pricing Rules zone	Parent Customer Pricing Rules on page 696

Defining a Claim Pricing Rule for a Bill Group

Prerequisites

To define a claim pricing rule for a bill group, you should have:

- Business Object **C1-PricingRule** defined for pricing rule.
- Business Object **C1-PricingRuleClaim** defined for claim pricing rule.
- Pricing rule type defined in the application.
- Policy status defined in the application.
- Price item defined in the application.
- Rate options defined in the Rate Option (**C1-ExtLookRateType**) extendable lookup.
- Claim template defined in the Claim Template (**C1-ExtLookClaimTemplate**) extendable lookup.
- Line items defined in the Line Item (**C1-ExtLookPricingRuleLineItem**) extendable lookup.

Procedure

To define a claim pricing rule for a bill group:

1. Search for the account, person, or policy whose pricing details you want to view in the **Customer 360° View** screen.
2. In the **Search Results** section, click the **View** (🔍) icon corresponding to the account, person, or policy whose pricing details you want to view. The **Account, Person, or Policy** tab in the **Customer 360° Information** screen appears.
3. Click the **Pricing** tab and then click the **Add** link in the upper right corner of the **Bill Group ASO Policy Pricing Rules** zone.

The **Pricing Rule** screen appears. It contains the following fields:

Field Name	Field Description	Mandatory (Yes or No)
Person Name	Indicates the name of the parent customer.	Not applicable
Person Type	Indicates the type of the parent customer.	Not applicable
Pricing Rule Type	Used to indicate the pricing rule type using which you want to create a claim pricing rule for the bill group.	Yes
	Note: You can create a claim pricing rule using the Pricing Rule Type for claim.	

Field Name	Field Description	Mandatory (Yes or No)
Pricing Group	Used to indicate the pricing group for the bill group.	No
	Note: Select the pricing group option when the claim pricing rule has to be defined for a bill group using the pricing group.	
Policy Status	Used to indicate the policy status for the bill group. The valid values are: <ul style="list-style-type: none"> • In Force/Active • Post Runout • Runout 	Yes
	Note: Claim pricing rule cannot be created for Runout or Post Runout policy statuses, where the policy run out end date is missing.	

4. Click **OK**.

The **Claim Pricing Rule** screen appears. It contains the following sections:

- **Customer Information** – Displays the customer information for bill group.
- **Main** – Used to specify basic details about the claim pricing rule.
- **Claim Handling Fees** – Used to define the claim handling fees on the lines items for the claim pricing rule.
- **Markup or Markdown Values** – Used to define the markup or markdown values for the line items in the claim pricing rule.
- **Line Items** – Used to associate line items eligible for billing in the claim pricing rule.
- **Characteristics** – Used to define the characteristics for the claim pricing rule.

The **Customer Information** section contains the following fields:

Field Name	Field Description
Bill Group Information	Displays the bill group information.
Policy Start Date	Displays the date from when the policy is effective.
Policy End Date	Displays the date till when the policy is effective.
Policy Status	Indicates the policy status for the claim pricing rule. The valid values are: <ul style="list-style-type: none"> • In Force/Active • Post Runout • Runout
Pricing Rule Type	Indicates the pricing rule type.
Status	Indicates the bill group status for the claim pricing rule. The valid values are: <ul style="list-style-type: none"> • Active • Inactive • Pending

The **Main** section contains the following fields:

Field Name	Field Description	Mandatory (Yes or No)
Price Item	Used to indicate the price item for which you want to edit the pricing.	Yes
Pricing Start Date	Used to specify the start date from when the pricing will be effective for the price item.	Yes (Conditional) Note: Pricing Start Date should be entered if Pricing End Date has been mentioned.
	Note: The pricing start date cannot be later than the pricing end date.	
Pricing End Date	Used to specify the end date till when the pricing will be effective for the price item.	No
	Note: The pricing end date cannot be earlier than the pricing start date.	
Rate Option	Used to indicate the rate option that you want to use while editing the pricing for the price item.	Yes
Claim Template	Used to indicate the claim template of the claim pricing rule for a bill group.	Yes (Conditional)
		Note: This field is required when you are reapplying for a claim template.

Note: This section also consists of a button, **Reapply**, on clicking the button a message occurs indicating that updating the claim template will reset all the default fields on the pricing rule.

- Enter the required details in the **Main** section.
- Define the claim handling fees for the line items in a claim pricing rule, if required.

Note: The **Claim Handling Fees** section appears when an option from **Claim Template** field is selected.

- Define the markup or markdown values for the line items in a claim pricing rule, if required.

Note: The **Markup or Markdown Values** section appears when an option from **Claim Template** field is selected.

- Define line items in a claim pricing rule, if required.

Note: The **Line Items** section appears when an option from **Claim Template** field is selected.

- Define characteristics for a claim pricing rule, if required.

- Click **Save**.

The claim pricing rule for a bill group is defined.

Note: A price list and price assignment is created, the created price list is assigned to the claim pricing rule.

Related Topics

For more information on...	See...
Customer 360° Information – Pricing tab	Customer 360° Information - Pricing Information on page 693
Bill Group ASO Policy Pricing Rules zone	Bill Group Self-Funded Policy Pricing Rules on page 702
How to define claim handling fees for the line items in a claim pricing rule	Defining the Claim Handling Fees For Line Items in a Claim Pricing Rule
How to define markup or markdown values for the line items in a claim pricing rule	Defining the Markup or Markdown Values For Line Items in a Claim Pricing Rule on page 2578
How to define a characteristic for a claim pricing rule	Defining a Characteristic for a Claim Pricing Rule on page 2581

Defining a Claim Pricing Rule for a Bill Group Using a Pricing Group

Prerequisites

To define a claim pricing rule for a bill group using a pricing group, you should have:

- Business Object **C1-PricingRule** defined for pricing rule.
- Business Object **C1-PricingRuleClaim** defined for claim pricing rule.
- Pricing rule type defined in the application.
- Pricing group defined in the application.
- Policy status defined in the application.
- Price item defined in the application.
- Rate option defined in the application.
- Claim template defined in the application.

Procedure

To define a claim pricing rule for a bill group using a pricing group:

1. Search for the account, person, or policy whose pricing details you want to view in the **Customer 360° View** screen.
2. In the **Search Results** section, click the **View** (🔗) icon corresponding to the account, person, or policy whose pricing details you want to view.
The **Account, Person, or Policy** tab in the **Customer 360° Information** screen appears.
3. Click the **Pricing** tab and then click the **Add** link in the upper right corner of the **Bill Group ASO Policy Pricing Rules** zone.

The **Pricing Rule** screen appears. It contains the following fields:

Field Name	Field Description	Mandatory (Yes or No)
Person Name	Displays the person name.	Not applicable
Person Type	Displays the person type.	Not applicable
Pricing Rule Type	Used to indicate the pricing rule type to create the pricing rule. Note: You can create a claim pricing rule using the Pricing Rule Type for claim.	Yes

Field Name	Field Description	Mandatory (Yes or No)
Pricing Group	Used to indicate the pricing group.	Yes
Policy Status	Used to indicate the policy status for pricing rule. The valid values are: <ul style="list-style-type: none"> In Force/Active Post Runout Runout 	Yes
	Note: Claim pricing rule cannot be created for Runout or Post Runout policy status where the policy run out End Date is missing.	

4. Click **OK**.

The **Claim Pricing Rule** screen appears. It contains the following sections:

- **Customer Information** – Displays the customer information for bill group using pricing group.
- **Main** – Used to specify basic details about the claim pricing rule.
- **Markup or Markdown Values** – Used to define the markup or markdown values for line items for each rule.
- **Line Items** – Used to associate line items eligible for billing for each rule.
- **Characteristics** – Used to define the characteristics for the claim pricing rule.

The **Customer Information** section contains the following fields:

Field Name	Field Description	Mandatory (Yes or No)
Bill Group Information	Displays the bill group information.	Not applicable
Policy Start Date	Displays the policy start date.	Not applicable
Policy End Date	Displays the policy end date.	Not applicable
Policy Status	Indicates the policy status for pricing rule. The valid values are: <ul style="list-style-type: none"> In Force/Active Post Runout Runout 	Not applicable
Pricing Group	Displays the pricing group.	Not applicable
Pricing Rule Type	Indicates the pricing rule type.	Not applicable

The **Main** section contains the following fields:

Field Name	Field Description	Mandatory (Yes or No)
Price Item	Used to indicate the price item.	Yes

Field Name	Field Description	Mandatory (Yes or No)
Pricing Start Date	Used to specify the pricing rule start date.	Yes
	Note: This field is enabled when an option from Price Item field is selected. By default it displays the Policy Start Date .	
Pricing End Date	Used to specify the pricing rule end date.	Yes
	Note: This field is enabled when an option from Price Item field is selected. By default it displays the Policy End Date .	
Rate Option	Used to indicate the rate option to define the claim pricing rule for the price item.	Yes
Claim Template	Used to indicate the claim template to define the claim pricing rule for a bill group.	Yes
	Note: This field is enabled for selection when an option from Price Item field is selected.	

- Enter the required details in the **Main** section.
- Define markup or markdown values for line items for each rule in a claim pricing rule, if required.

Note: The **Markup or Markdown Values** section appears in the rule section and the rule section appears when an option from **Claim Template** field is selected.

- Define line items for each rule in a claim pricing rule, if required.

Note: The **Line Items** section appears in the rule section and the rule section appears when an option from **Claim Template** field is selected.

- Define characteristics for a claim pricing rule, if required.
- Click **Save**.

The claim pricing rule for a bill group using a pricing group is defined.

Note: A price list and price assignment is created, the price list created is assigned to the claim pricing rule.

Related Topics

For more information on...	See...
Customer 360° Information – Pricing tab	Customer 360° Information - Pricing Information on page 693
Bill Group ASO Policy Pricing Rules zone	Bill Group Self-Funded Policy Pricing Rules on page 702

For more information on...	See...
How to define markup or markdown values for line items for each rule in a claim pricing rule	Defining the Markup or Markdown Values for Line Items for Each Rule in a Claim Pricing Rule on page 2579
How to define a characteristic for a claim pricing rule	Defining a Characteristic for a Claim Pricing Rule on page 2581

Editing a Claim Pricing Rule of a Bill Group



Prerequisites

To edit a claim pricing rule of a bill group, you should have:

- Business Object **C1-PricingRuleClaim** defined for claim pricing rule.
- Rate options defined in the Rate Option (**C1-ExtLookRateType**) extendable lookup.
- Claim template defined in the Claim Template (**C1-ExtLookClaimTemplate**) extendable lookup.
- Line items defined in the Line Item (**C1-ExtLookPricingRuleLineItem**) extendable lookup.

Procedure

To edit a claim pricing rule of a bill group:

1. Search for the account, person, or policy whose pricing details you want to view in the **Customer 360° View** screen.
2. In the **Search Results** section, click the **View** () icon corresponding to the account, person, or policy whose pricing details you want to view.
The **Account, Person, or Policy** tab in the **Customer 360° Information** screen appears.
3. Click the **Pricing Information** tab.
The **Pricing Information** tab appears.
4. Click the **Broadcast** () icon in the **Bill Group ASO Policy Information** zone, corresponding to the **Bill Group Information** column, whose bill group details you want to view.
The **Bill Group ASO Policy Pricing Rules** zone appears.
5. Click the **Edit** () icon in the **Bill Group ASO Policy Pricing Rules** zone, corresponding to the **Pricing Group Information** column, whose pricing details you want to edit.

The **Claim Pricing Rule** screen appears. It contains the following sections:

- **Customer Information** – Displays the customer information for the bill group.
- **Main** – Used to specify basic details about the claim pricing rule.
- **Claim Handling Fees** – Used to define the claim handling fees on the lines items in the claim pricing rule.
- **Markup or Markdown Values** – Used to define the markup or markdown values on the lines items in the claim pricing rule.
- **Line Items** – Used to associate line items eligible for billing.
- **Characteristics** – Used to define the characteristics for the claim pricing rule.

The **Customer Information** section contains the following fields:

Column Name	Column Description
Bill Group Information	Displays the bill group name.
Policy Start Date	Displays the date from when the policy is effective.
Policy End Date	Displays the date till when the policy is effective.
Policy Status	Indicates the policy status for the claim pricing rule. The valid values are: <ul style="list-style-type: none"> • In Force/Active • Post Runout • Runout
Pricing Rule Type	Indicates the pricing rule type.
Status	Indicates the bill group status for the claim pricing rule. The valid values are: <ul style="list-style-type: none"> • Active • Inactive • Pending

The **Main** section contains the following fields:

Field Name	Field Description	Mandatory (Yes or No)
Price Item	Used to indicate the price item for which you want to edit the pricing.	Yes
Pricing Start Date	Used to specify the start date from when the pricing will be effective for the price item.	Yes (Conditional) Note: Pricing Start Date should be entered if Pricing End Date has been mentioned.
	Note: The pricing start date cannot be later than the pricing end date.	
Pricing End Date	Used to specify the end date till when the pricing will be effective for the price item.	No
	Note: The pricing end date cannot be earlier than the pricing start date.	
Rate Option	Used to indicate the rate option that you want to use while editing the pricing for the price item.	Yes
Claim Template	Used to indicate the claim template of the claim pricing rule for a bill group.	Yes

Note: This section also consists of a button, **Reapply**, on clicking the button a message occurs indicating that updating the claim template will reset all the default fields on the pricing rule.

6. Modify the details in the **Main** section, if required.
7. Modify the claim handling fees specified on the line items in a claim pricing rule, if required.
8. Modify the markup or markdown values on the line items in a claim pricing rule, if required.
9. Modify the line items in a claim pricing rule, if required.

10. Add, edit, or remove the characteristics for a claim pricing rule, if required.

11. Click **Save**.

The changes made to a claim pricing rule for a bill group are saved.

Related Topics

For more information on...	See...
Customer 360° Information – Pricing tab	Customer 360° Information - Pricing Information on page 693
Bill Group ASO Policy Pricing Rules zone	Bill Group Self-Funded Policy Pricing Rules on page 702
How to define the claim handling fees for line items in a claim pricing rule	Defining the Claim Handling Fees For Line Items in a Claim Pricing Rule
How to define the markup or markdown values for line items in a claim pricing rule	Defining the Markup or Markdown Values For Line Items in a Claim Pricing Rule on page 2578
How to define a characteristic for a claim pricing rule	Defining a Characteristic for a Claim Pricing Rule on page 2581

Viewing a Claim Pricing Rule of a Bill Group

Procedure

To view a claim pricing rule of a bill group:

1. Search for a bill group in the **Customer 360° View** screen.
2. In the **Search Results** section, click the **View** () icon corresponding to the account, person, or policy whose pricing details you want to view.

The **Person** tab appears in the **Customer 360° Information** screen.

3. Click the **Pricing** tab.

The **Pricing** tab appears.

4. In the **Bill Group ASO Policy Information** zone, click the **Broadcast** () icon corresponding to the bill group whose claim pricing rule bill group details you want to view.

5. In the **Bill Group ASO Policy Pricing Rules** zone, click the link in the **Pricing Rule Information** column corresponding to the claim pricing rule type whose claim pricing rule bill group you want to view.

The **Pricing Rule** screen appears. It contains the following zone:

- **Claim** – Displays the pricing rule claim details for a bill group. It contains the following sections:
 - **Main** – Displays the basic details of the claim pricing rule.
 - **Claim Handling Fees** – Displays the claim handling fees specified for the lines items in the claim pricing rule.
 - **Markup or Markdown Values** – Displays the markup or markdown values for the lines items in the claim pricing rule.
 - **Line Items** – Displays the associated line items eligible for billing.
 - **Characteristics** – Displays the characteristics defined for the claim pricing rule.

6. View the basic details of claim pricing rule in the **Main** section.

7. View the claim handling fees specified for the line items in the **Claim Handling Fees** section.
8. View the markup or markdown values for the line items in the **Markup or Markdown Values** section.
9. View the associated line items eligible for billing in the **Line Items** section.
10. View the characteristics of the claim pricing rule in the **Characteristics** section.

Related Topics

For more information on...	See...
Customer 360° Information – Pricing tab	Customer 360° Information - Pricing Information on page 693
Bill Group ASO Policy Pricing Rules zone	Bill Group Self-Funded Policy Pricing Rules on page 702
Pricing Rule screen	Pricing Rule (Used for Viewing) on page 2902
Claim zone	Claim on page 2903

Deleting a Claim Pricing Rule of a Bill Group

Procedure

To delete a claim pricing rule of a bill group:

1. Search for the account, person, or policy whose pricing details you want to view in the **Customer 360° View** screen.
2. In the **Search Results** section, click the **View** (🔗) icon corresponding to the account, person, or policy whose pricing details you want to view.
The **Account, Person, or Policy** tab in the **Customer 360° Information** screen appears.
3. Click the **Pricing** tab, in the **Bill Group ASO Policy Pricing Rules** zone, click the **Delete** (🗑️) icon in the **Delete** column corresponding to the pricing rule type that you want to delete.
A message appears confirming whether you want to delete the claim pricing rule.
4. Click **OK**.

The claim pricing rule of a bill group is deleted.

Related Topics

For more information on...	See...
Customer 360° Information – Pricing tab	Customer 360° Information - Pricing Information on page 693
Bill Group ASO Policy Pricing Rules zone	Bill Group Self-Funded Policy Pricing Rules on page 702

Specific Stop-Loss (SSL) Pricing

Stop-Loss coverage provides liability limits on claims for individuals and for the employer group as a whole. Specific Stop-Loss (SSL) is the form of excess risk coverage that provides protection for the employer against a high claim on any one individual. This is protection against abnormal severity of a single member claim rather than abnormal frequency of claims in total. Specific stop-loss is also known as individual stop-loss. The specific stop-loss is calculated on the claim transactions received for an individual.

You can define a specific stop-loss pricing rule at the parent customer and bill group levels. The specific stop-loss pricing rule at the bill group level takes precedence over the specific stop-loss pricing rule at the parent customer level. You can define specific stop-loss pricing rules for parent customers and bill groups from the **Customer 360° Information** screen. You can define a specific stop-loss pricing rule using a specific stop-loss pricing rule type.

It is the specific stop-loss pricing rule type which helps the system to determine:

- Business object using which the specific stop-loss pricing rule should be created in the system.

Note: The specific stop-loss pricing rule type is not a primary pricing rule type. It inherits the attributes from a claim pricing rule type where it is included as a related pricing rule type.

- Algorithm which should be triggered while validating a transaction.

Note: An algorithm type for validating a transaction is not shipped from the product. You need to create a custom algorithm type, if required.

- Algorithms which should be triggered while deriving account and price item for a transaction.

Note: You must create an algorithm using the **C1_ACCPRISL** algorithm type and attach it to the **Account and Price Item Derivation** system event.

- Post-processing algorithm which should be triggered once the specific stop-loss pricing rule is derived.

Note: A post-processing algorithm type is not shipped from the product. You need to create a custom algorithm type, if required.

- Price items for which you can define specific stop-loss pricing rules using the specific stop-loss pricing rule type.
- Rate options that you can use while defining the pricing for a price item.
- Different type of account to which the price item should be billed based on the specified priority.

Note: Ideally, the price item parameters should not be specified in a specific stop-loss pricing rule type. The price item parameters which are specified in the claim pricing rule type are used for accumulating specific stop-loss.

- Additional information, such as:
 - Identifier which helps to determine whether the specific stop-loss should be calculated for claim transactions which are received during the run-in period of the policy.
 - SSL billable charge line type using which you want to create specific stop-loss billable charges.
 - Domestic provider claim billable charge line type using which you want to create domestic provider claim calculation lines.
 - Markup or markdown billable charge line type using which you want to create markup or markdown calculation lines.
 - Transaction field which you want to use in the rules as the output parameter to determine whether the line item is eligible for billing.
 - Transaction field which you want to use in the rules as the output parameter to determine whether the markup or markdown calculation line is eligible for billing.
 - Transaction field which you want to use in the rules as the output parameter to determine whether the domestic provider claim calculation line is eligible for billing.

Once a specific stop-loss pricing rule type is defined, you can create specific stop-loss pricing rules using the specific stop-loss pricing rule type. While defining a specific stop-loss pricing rule for a parent customer, you need to specify the following:

- Price item for which you want to define the pricing.
- Pricing date range during which the pricing is effective.

- Rate option which you want to use while defining the specific stop-loss pricing.
- Whether the specific stop-loss pricing rule must be used for only pricing or for pricing and billing.
- Whether the specific stop-loss must be accumulated at the member or main subscriber level.
- Settlement frequency which helps to determine the bill after date. The valid values are:
 - Immediately – If you select this option from the list, the bill after date is not calculated. The specific stop-loss billable charge is billed immediately in the next bill cycle.
 - Manually (At Required Intervals) - If you select this option from the list, the bill after date which is specified in the **Manual Settlement Bill After Date** parameter while executing the **C1-BCSSL** batch is stamped on the specific stop-loss billable charge.
 - Never - If you select this option from the list, the bill after date which is specified in the **Manual Settlement Bill After Date** parameter while executing the **C1-BCSSL** batch is stamped on the specific stop-loss billable charge.
 - Yearly – If you select this option from the list, the bill after date in the specific stop-loss billable charge is set to the pricing end date.
- Accumulation parameters (such as incurred start date, incurred end date, paid start date, paid end date, etc.) based on which you want to accumulate the specific stop-loss for the claim transactions which are processed in the run-in or active period of the policy.
- The maximum limit defined for specific stop-loss at the member or main subscriber level.
- Settlement days which helps to calculate the settlement date (i.e. pricing end date, incurred end date, or paid end date whichever is later + settlement days)
- Whether the Aggregate Specific Stop-Loss (ASSL) should be calculated during the C1-BCSSL batch run for each bill group
- The ASSL limit indicating that the aggregate specific stop-loss amount beyond this limit will be paid by the insurance company to the ASSL credit account.
- Whether any member, main subscriber, or provider is excluded during the specific stop-loss calculation Different SSL limit (i.e. lasered amount) for a member, main subscriber, or provider who are expected to have higher claim amount.

However, while defining a specific stop-loss pricing rule for a bill group, you need to specify the following:

- The status of the policy for which you want to define the specific stop-loss pricing rule.
- Price item for which you want to define the pricing.
- Parent customer's SSL pricing rule from which you want to inherit the accumulation parameters and exclusion and lasering information.

Note: The pricing date range is derived from the parent customer's specific stop-loss pricing rule because the specific stop-loss pricing rules for parent customer and bill group should have the same date range.

- Rate option which you want to use while defining the specific stop-loss pricing.
- Whether the specific stop-loss calculated for the claim transactions which are mapped to the specified price items and price item parameters should be accumulated.
- The SSL limit indicating that the specific stop-loss amount beyond this limit will be paid by the insurance company.
- The maximum specific stop-loss limit defined for the member when the claim transactions are received in the run-in period of the policy.
- Whether line items in a claim pricing rule are eligible for specific stop-loss

Note: By default, the line items where the pricing rule type category is set to Specific Stop-Loss appear in the Line Items section. If you want to set specific stop-loss eligibility for the line items which belong to a particular claim pricing rule, you must select the respective claim pricing rule.

- Whether certain percentage of SSL should be excluded while calculating specific stop-loss for domestic provider claim.

You can also specify a pricing group while defining a specific stop-loss pricing rule for a bill group. If you specify a pricing group while defining a stop-loss pricing rule for a bill group, you will have to define the following details for each rule defined in the pricing group:

- Whether the specific stop-loss calculated for the claim transactions which are mapped to the specified price items and price item parameters should be accumulated.
- The SSL limit indicating that the specific stop-loss amount beyond this limit will be paid by the insurance company.
- The maximum specific stop-loss limit defined for the member when the claim transactions are received in the run-in period of the policy.
- Whether line items in a claim pricing rule are eligible for specific stop-loss.

Note: By default, the line items where the pricing rule type category is set to Specific Stop-Loss appear in the Line Items section. If you want to set specific stop-loss eligibility for the line items which belong to a particular claim pricing rule, you must select the respective claim pricing rule.

- Whether certain percentage of SSL should be excluded while calculating specific stop-loss for domestic provider claim.

Once a specific stop-loss pricing rule is defined for a parent customer and bill group, the system creates one price assignment, one price list, and one price list assignment.

Defining a Specific Stop-Loss (SSL) Pricing Rule Type

Prerequisites

To define a specific stop-loss (SSL) pricing rule type, you should have:

- Business Object **C1-PricingRuleTypeSSL** defined for pricing rule type.
- Business Object **C1-PricingRuleSSL** defined for pricing rule.
- Pricing rule type category for specific stop-loss defined in the application

Procedure

To define a specific stop-loss pricing rule type:

1. Click the **Admin** link in the **Application** toolbar.
A list appears.
2. From the **Admin** menu, select **P** and then click **Pricing Rule Type**.
A sub-menu appears.
3. Click the **Add** option from the **Pricing Rule Type** sub-menu.
The **Select Business Object** screen appears. It contains the following field:

Field Name	Field Description	Mandatory (Yes or No)
Pricing Rule Type Business Object	Used to indicate the business object using which you want to create the pricing rule type.	Yes
	Note: You can create a specific stop-loss pricing rule type using the Specific Stop-Loss (SSL) Pricing Rule Type business object.	

Tip: Alternatively, you can access this screen by clicking the **Add** button in the **Page Title** area of the **Pricing Rule Type** screen.

4. Select the **Specific Stop-Loss (SSL) Pricing Rule Type** business object.
5. Click **OK**.

The **Specific Stop-Loss (SSL) Pricing Rule Type** screen appears. It contains the following sections:

- **Main** – Used to specify basic details about the specific stop-loss pricing rule type.
- **Related Pricing Rule Types** – Used to define the pricing rule types which are related to the parent pricing rule type.
- **Transaction Field Mapping** – Used to specify the transaction related data mapped to the pricing rule type
- **Algorithms** – Used to define the algorithms used for the pricing rule type.
- **Additional Data** – Used to specify the additional information about the pricing rule type.
- **Price Items** – Used to define the price items assigned to the pricing rule type.
- **Price Item Parameters** – Used to define the price item parameters in the pricing rule type.
- **Characteristics** – Used to define the characteristics for the pricing rule type.
- **SSL-Specific Additional Data** – Used to specify the specific stop-loss related additional data.

The **Main** section contains the following fields:

Field Name	Field Description	Mandatory (Yes or No)
Pricing Rule Type	Used to specify the pricing rule type.	Yes
Description	Used to specify the description for the pricing rule type.	Yes
Detailed Description	Used to specify additional information about the pricing rule type.	No
Related Transaction Business Object	Used to indicate the pricing rule business object. The valid values are: <ul style="list-style-type: none"> • Claim Pricing Rule • Aggregate Stop-Loss (ASL) Pricing Rule • Specific Stop-Loss (SSL) Pricing Rule • Retention Type Claim Based Pricing Rule • Retention Type Enrollment Based Pricing Rule 	Yes
Business Object	Indicate the pricing rule type business object for specific stop-loss.	Not applicable

Field Name	Field Description	Mandatory (Yes or No)
Status	Used to indicate the status of the pricing rule type. The valid values are: <ul style="list-style-type: none"> Active Inactive 	Yes
Primary	Used to select the checkbox if the pricing rule type is primary.	No
Pricing Rule Type Category	Used to indicate the pricing rule type category for the pricing rule type. The valid values are: <ul style="list-style-type: none"> Claim Aggregate Stop-Loss Specific Stop-Loss Retention Type Claim Based Retention Type Enrollment Based 	Yes

- Enter the required details in the **Main** section.
- Add the related pricing rule types in the primary pricing rule type, if required.

Note: Related Pricing Rule Types section appears when the pricing rule type is primary.

- Define the transaction field mapping in the primary pricing rule type, if required.

Note: Transaction Field Mapping section appears when the pricing rule type is primary.

- Associate algorithms with the pricing rule type, if required.
- Define additional data for the pricing rule type, if required.
- Add pricing items in the pricing rule type, if required.
- Add price item parameters in the pricing rule type, if required.
- Define characteristics for the pricing rule type, if required.
- Add the SSL-Specific data in the pricing rule type, if required.
- Click **Save**.

The specific stop-loss pricing rule type is defined.

Related Topics

For more information on...	See...
Pricing Rule Type screen	Pricing Rule Type on page 2532
How to add the related pricing rule types in the primary pricing rule type	Adding Related Pricing Rule Types in a Primary Pricing Rule Type on page 2549
How to define the transaction field mapping in the primary pricing rule type	Defining Transaction Field Mapping in a Primary Pricing Rule Type on page 2551
How to associate algorithms with the pricing rule type	Associating Algorithms with a Pricing Rule Type on page 2557

For more information on...	See...
How to define additional data for the pricing rule type	Defining Additional Data for a Pricing Rule Type on page 2559
How to add pricing items in the pricing rule type	Adding Price Items in a Pricing Rule Type on page 2561
How to add price item parameters in the pricing rule type	Adding a Price Item Parameter in a Pricing Rule Type on page 2564
How to define a characteristic for the pricing rule type	Defining a Characteristic for a Pricing Rule Type on page 2566
How to add the SSL-Specific data in the pricing rule type	Adding the SSL-Specific Data in a Pricing Rule Type on page 2601

Adding the SSL-Specific Data in a Pricing Rule Type

Procedure

To add the SSL-Specific additional data in a pricing rule type:

1. Ensure that the **SSL-Specific Additional Data** section is expanded when you are defining or editing a pricing rule type.

The **SSL-Specific Additional Data** section contains the following fields:

Field Name	Field Description	Mandatory (Yes or No)
SSL Billable Charge Line Type	Used to specify the Specific Stop-Loss billable charge line type. Note: On clicking the Search (🔍) icon that appears corresponding to the SSL Billable Charge Line Type field, the Billable Charge Line Type Search window appears. On specifying the billable charge line type, the description of the billable charge line type appears corresponding to the SSL Billable Charge Line Type field.	No

Field Name	Field Description	Mandatory (Yes or No)
Domestic Provider Claim Billable Charge Line Type	<p>Used to specify the claim billable charge line type for domestic provider.</p> <p>Note:</p> <p>On clicking the Search (🔍) icon that appears corresponding to the Domestic Provider Claim Billable Charge Line Type field, the Billable Charge Line Type Search window appears.</p> <p>On specifying the billable charge line type, the description of the billable charge line type appears corresponding to the Domestic Provider Claim Billable Charge Line Type field.</p>	No
Markup or Markdown Billable Charge Line Type	<p>Used to specify the markup or markdown billable charge line type.</p> <p>Note:</p> <p>On clicking the Search (🔍) icon that appears corresponding to the Markup or Markdown Billable Charge Line Type field, the Billable Charge Line Type Search window appears.</p> <p>On specifying the billable charge line type, the description of the billable charge line type appears corresponding to the Markup or Markdown Billable Charge Line Type field.</p>	No
Rule Based Billing Eligibility Field	<p>Used to specify whether the rule based field is eligible for billing or not.</p> <p>Note:</p> <p>On clicking the Search (🔍) icon that appears corresponding to the Rule Based Billing Eligibility Field field, the Field Search window appears.</p> <p>On specifying the field, the description of the field appears corresponding to the Rule Based Billing Eligibility Field field.</p>	No

Field Name	Field Description	Mandatory (Yes or No)
Rule Based Markup or Markdown Eligibility Field	<p>Used to specify whether the rule based markup or markdown field is eligible for billing or not.</p> <p>Note:</p> <p>On clicking the Search (🔍) icon that appears corresponding to the Rule Based Markup or Markdown Eligibility Field field, the Field Search window appears.</p> <p>On specifying the field, the description of the field appears corresponding to the Rule Based Markup or Markdown Eligibility Field field.</p>	No
Rule Based Domestic Provider Claim Eligibility Field	<p>Used to specify the rule based domestic provider for claim eligibility field.</p> <p>Note:</p> <p>On clicking the Search (🔍) icon that appears corresponding to the Rule Based Domestic Provider Claim Eligibility Field field, the Field Search window appears.</p> <p>On specifying the field, the description of the field appears corresponding to the Rule Based Domestic Provider Claim Eligibility Field field.</p>	No

2. Enter the required details in the **SSL-Specific Additional Data** section.
3. Click **Save**.

The SSL-Specific Additional data is added in the pricing rule type.

Related Topics

For more information on...	See...
How to define a specific stop-loss (SSL) pricing rule type	Defining a Specific Stop-Loss (SSL) Pricing Rule Type on page 2598
How to edit the specific stop-loss (SSL) pricing rule type	Editing a Specific Stop-Loss (SSL) Pricing Rule Type on page 2603

Editing a Specific Stop-Loss (SSL) Pricing Rule Type

Prerequisites

To edit the specific stop-loss (SSL) pricing rule type, you should have:

- Business Object **C1-PricingRuleSSL** defined for pricing rule.
- Pricing rule type category for specific stop-loss (SSL) defined in the application

Procedure

To edit the specific stop-loss (SSL) pricing rule type:

1. Click the **Admin** link in the **Application** toolbar.

A list appears.

- From the **Admin** menu, select **P** and then click **Pricing Rule Type**.

A sub-menu appears.

- Click the **Search** option from the **Pricing Rule Type** sub-menu.

The **Pricing Rule Type** screen appears.

- In the **Pricing Rule Type List** zone, click the **Edit**  icon in the **Edit** column corresponding to the pricing rule type for specific stop-loss (SSL) whose details you want to edit.

The **Specific Stop-Loss (SSL) Pricing Rule Type** screen appears. It contains the following sections:

- **Main** – Used to specify basic details about the specific stop-loss pricing rule type.
- **Related Pricing Rule Types** – Used to define the pricing rule types which are related to the parent pricing rule type.
- **Transaction Field Mapping** – Used to specify the transaction related data mapped to the pricing rule type.
- **Algorithms** – Used to define the algorithms used for the pricing rule type.
- **Additional Data** – Used to specify the additional information about the pricing rule type.
- **Price Items** – Used to define the price items assigned to the pricing rule type.
- **Price Item Parameters** – Used to define the price item parameters in the pricing rule type.
- **Characteristics** – Used to define the characteristics for the pricing rule type.
- **SSL-Specific Additional Data** – Used to specify the specific stop-loss additional data.

The **Main** section contains the following fields:

Field Name	Field Description	Mandatory (Yes or No)
Pricing Rule Type	Displays the pricing rule type.	Not applicable
Description	Used to specify the description for the pricing rule type.	Yes
Detailed Description	Used to specify additional information about the pricing rule type.	No
Related Transaction Business Object	Used to indicate the pricing rule business object. The valid values are: <ul style="list-style-type: none"> • Claim Pricing Rule • Aggregate Stop-Loss (ASL) Pricing Rule • Specific Stop-Loss (SSL) Pricing Rule • Retention Type Claim Based Pricing Rule • Retention Type Enrollment Based Pricing Rule 	Yes
Business Object	Displays the pricing rule type business object for specific stop-loss.	Not applicable
Status	Used to indicate the status of the pricing rule type. The valid values are: <ul style="list-style-type: none"> • Active • Inactive 	Yes

Field Name	Field Description	Mandatory (Yes or No)
Primary	Used to select the checkbox if the pricing rule type is primary.	No
Pricing Rule Type Category	Used to indicate the pricing rule type category for the pricing rule type. The valid values are: <ul style="list-style-type: none"> • Claim • Aggregate Stop-Loss • Specific Stop-Loss • Retention Type Claim Based • Retention Type Enrollment Based 	Yes

Tip: Alternatively, you can click the **Edit** button in the **Pricing Rule Type** zone to edit the pricing rule type for specific stop-loss.

5. Modify the details in the **Main** section, if required.
6. Add, edit, or remove the related pricing rule types in the primary pricing rule type, if required.
7. Modify the transaction field mapping in the primary pricing rule type, if required.
8. Add, edit, or remove algorithms with the pricing rule type, if required.
9. Modify the additional data for the pricing rule type, if required.
10. Add, edit, or remove pricing items in the pricing rule type, if required.
11. Add, edit, or remove price item parameters in the pricing rule type, if required.
12. Add, edit, or remove characteristics for the pricing rule type, if required.
13. Modify the SSL-Specific data in the pricing rule type, if required.
14. Click **Save**.

The changes made to the specific stop-loss pricing rule type are saved.

Related Topics

For more information on...	See...
Pricing Rule Type screen	Pricing Rule Type on page 2532
Pricing Rule Type List zone	Pricing Rule Type List on page 2533
Pricing Rule Type zone	Pricing Rule Type on page 2536
How to add the related pricing rule types in the primary pricing rule type	Adding Related Pricing Rule Types in a Primary Pricing Rule Type on page 2549
How to define the transaction field mapping in the primary pricing rule type	Defining Transaction Field Mapping in a Primary Pricing Rule Type on page 2551
How to associate algorithms with the pricing rule type	Associating Algorithms with a Pricing Rule Type on page 2557
How to define additional data for the pricing rule type	Defining Additional Data for a Pricing Rule Type on page 2559
How to add pricing items in the pricing rule type	Adding Price Items in a Pricing Rule Type on page 2561

For more information on...	See...
How to add price item parameters in the pricing rule type	Adding a Price Item Parameter in a Pricing Rule Type on page 2564
How to define a characteristic for the pricing rule type	Defining a Characteristic for a Pricing Rule Type on page 2566
How to add the SSL-Specific data in the pricing rule type	Adding the SSL-Specific Data in a Pricing Rule Type on page 2601

Deleting a Specific Stop-Loss (SSL) Pricing Rule Type

Procedure

To delete a specific stop-loss pricing rule type:

1. Click the **Admin** link in the **Application** toolbar.
A list appears.
2. From the **Admin** menu, select **P** and then click **Pricing Rule Type**.
A sub-menu appears.
3. Click the **Search** option from the **Pricing Rule Type** sub-menu.
The **Pricing Rule Type** screen appears.
4. In the **Pricing Rule Type List** zone, click the **Delete** (🗑️) icon in the **Delete** column corresponding to the specific stop-loss pricing rule type that you want to delete.
A message appears confirming whether you want to delete the specific stop-loss pricing rule type.

Note: You can delete a specific stop-loss pricing rule type when it is not yet used in the system.

Tip: Alternatively, you can delete a specific stop-loss pricing rule type by clicking the **Delete** button in the **Pricing Rule Type** zone.

5. Click **OK**.
The specific stop-loss pricing rule type is deleted.

Related Topics

For more information on...	See...
Pricing Rule Type screen	Pricing Rule Type on page 2532
Pricing Rule Type List zone	Pricing Rule Type List on page 2533
Pricing Rule Type zone	Pricing Rule Type on page 2536

Viewing the Specific Stop-Loss (SSL) Pricing Rule Type Details

Procedure

To view the details of a specific stop-loss pricing rule type:

1. Click the **Admin** link in the **Application** toolbar.
A list appears.
2. From the **Admin** menu, select **P** and then click **Pricing Rule Type**.

A sub-menu appears.

- Click the **Search** option from the **Pricing Rule Type** sub-menu.

The **Pricing Rule Type** screen appears.

- In the **Pricing Rule Type List** zone, click the **Broadcast** () icon corresponding to the specific stop-loss pricing rule type whose details you want to view.

The **Pricing Rule Type** zone appears.

- View the details of the specific stop-loss pricing rule type in the **Pricing Rule Type** zone.

Related Topics

For more information on...	See...
Pricing Rule Type screen	Pricing Rule Type on page 2532
Pricing Rule Type List zone	Pricing Rule Type List on page 2533
Pricing Rule Type zone	Pricing Rule Type on page 2536

Defining a Specific Stop-Loss Pricing Rule for a Parent Customer

Prerequisites

To define a specific stop-loss pricing rule for a parent customer, you should have:

- Business Object **C1-PricingRule** defined for pricing rule.
- Business Object **C1-PricingRuleSSL** defined for specific stop-loss pricing rule.
- Pricing rule type defined in the application.
- Price item defined in the application.
- Rate option defined in the application.
- Pricing rule usage defined in the application.
- SSL accumulation level defined in the application.
- Settlement frequency defined in the application.
- Underwriter review defined in the application.

Procedure

To define a specific stop-loss pricing rule for a parent customer:

- Search for the account, person, or policy whose pricing details you want to view in the **Customer 360° View** screen.
- In the **Search Results** section, click the **View** () icon corresponding to the account, person, or policy whose pricing details you want to view.

The **Account**, **Person**, or **Policy** tab in the **Customer 360° Information** screen appears.

- Click the **Pricing** tab and then click the **Add** link in the upper right corner of the **Parent Customer Pricing Rules** zone.

The **Pricing Rule** screen appears. It contains the following fields:

Field Name	Field Description	Mandatory (Yes or No)
Person Name	Displays the person name.	Not applicable

Field Name	Field Description	Mandatory (Yes or No)
Person Type	Displays the person type.	Not applicable
Pricing Rule Type	Used to indicate the pricing rule type to create the pricing rule.	Yes
	Note: You can create a specific stop-loss pricing rule using the Pricing Rule Type for specific stop-loss.	

4. Click **OK**.

The **Specific Stop-Loss (SSL) Pricing Rule** screen appears. It contains the following sections:

- **Customer Information** – Displays the customer information.
- **Main** – Used to specify basic details about the specific stop-loss pricing rule.
- **Accumulation Parameters** – Used to define the accumulation parameters based on which you want to accumulate the specific stop-loss for the transactions which are processed in the run-in or active period of the policy.
- **Run-In Parameters** – Used to define run-in parameters in the run-in period of the policy.
- **Lasering and Exclusion** – Used to define the lasering and exclusion information to inherit the accumulation parameters.
- **Characteristics** – Used to define the characteristics for a specific stop-loss pricing rule.

The **Customer Information** section contains the following fields:

Field Name	Field Description	Mandatory (Yes or No)
Parent Customer Information	Displays the parent customer information	Not applicable
Pricing Rule Type	Indicates the pricing rule type.	Not applicable

The **Main** section contains the following fields:

Field Name	Field Description	Mandatory (Yes or No)
Price Item	Used to indicate the price item which you want to define for pricing.	Yes
Pricing Start Date	Used to specify the pricing rule start date.	Yes
	Note: This field is enabled when an option from Price Item field is selected. By default it displays the Policy Start Date .	
Pricing End Date	Used to specify the pricing rule end date.	Yes
	Note: This field is enabled when an option from Price Item field is selected. By default it displays the Policy End Date .	

Field Name	Field Description	Mandatory (Yes or No)
Rate Option	Used to indicate the rate option which you want to use for defining the specific stop-loss pricing rule for the price item.	Yes
Pricing Rule Usage	Used to indicate whether the pricing rule is used only for pricing or for pricing and billing. The valid values are: <ul style="list-style-type: none"> • Pricing • Pricing and Billing 	Yes
	Note: This field is enabled when an option from Price Item field is selected.	
SSL Accumulation Level	Used to indicate whether the specific stop-loss must be accumulated at the member or main subscriber level. The valid values are: <ul style="list-style-type: none"> • Member • Main Subscriber 	
Settlement Frequency	Used to indicate the settlement frequency which helps to determine the bill after date. The valid values are: <ul style="list-style-type: none"> • Immediately – The bill after date is not calculated. The specific stop-loss billable charge is billed immediately in the next cycle. • Manually (At Required Intervals) – The bill after date specified in the Manual Settlement Bill After Date parameter while executing the C1-BCSSL batch is stamped on the specific stop-loss billable charge. • Never – The bill after date specified in the Manual Settlement Bill After Date parameter while executing the C1-BCSSL batch is stamped on the specific stop-loss billable charge. • Yearly – The bill after date in the specific stop-loss billable charge is set to the pricing end date. 	Yes
	Note: This field is disabled when you select Pricing and Billing option from the Pricing Rule Usage field.	

Field Name	Field Description	Mandatory (Yes or No)
Underwriter Review	Used to indicate whether the underwriter settlement review flag is on or off. The valid values are: <ul style="list-style-type: none"> • Yes • No 	Yes
Claim Template	Used to indicate the claim template to define the claim pricing rule for a parent customer.	Yes
	Note: This field is enabled for selection when an option from Price Item field is selected.	

- Enter the required details in the **Main** section.
- Define accumulation parameters in a specific stop-loss pricing rule, if required.

Note: The **Accumulation Parameters** section appears when an option from the **Price Item** field is selected.

- Define run-in parameters in a specific stop-loss pricing rule, if required.

Note: The **Run-In Parameters** section appears when an option from the **Price Item** field is selected.

- Define lasering and exclusion information in a specific stop-loss pricing rule, if required.

Note: The **Lasering and Exclusion** section appears when an option from the **Price Item** field is selected.

- Define characteristics for a specific stop-loss pricing rule, if required.
- Click **Save**.

The specific stop-loss pricing rule for a parent customer is defined.

Related Topics

For more information on...	See...
Customer 360° Information – Pricing tab	Customer 360° Information - Pricing Information on page 693
Parent Customer Pricing Rules zone	Parent Customer Pricing Rules on page 696
How to define accumulation parameters in a specific stop-loss pricing rule	Defining Accumulation Parameters in a Specific Stop-Loss Pricing Rule on page 2610
How to define run in parameters in a specific stop-loss pricing rule	Defining Run-in Parameters in a Specific Stop-Loss Pricing Rule on page 2612
How to define lasering and exclusion information in a specific stop-loss pricing rule	Defining Lasering and Exclusion Information in a Specific Stop-Loss Pricing Rule on page 2613
How to define a characteristic for a specific stop-loss pricing rule	Defining a Characteristic for a Specific Stop-Loss Pricing Rule on page 2614

Defining Accumulation Parameters in a Specific Stop-Loss Pricing Rule

Procedure

To define accumulation parameters in a specific stop-loss pricing rule:

1. Ensure that the **Accumulation Parameters** section is expanded when you have selected an option from the **Price Item** field of **Main** section while defining a specific stop-loss pricing rule.

The **Accumulation Parameters** section contains the following fields:

Field Name	Field Description	Mandatory (Yes or No)
Accumulation Group ID	Displays blank field, accumulation group ID is generated when accumulation parameter values are defined for a specific stop-loss.	Not applicable
Incurred Start Date	Used to specify the incurred start date based on which you want to accumulate the specific stop-loss.	Yes
	Note: The accumulated specific stop-loss for claim transactions are processed in the run-in or active period of the policy.	
Incurred End Date	Used to specify the incurred end date based on which you want to accumulate the specific stop-loss.	Yes
	Note: The accumulated specific stop-loss for claim transactions are processed in the run-in or active period of the policy.	
SSL Payout Limit	Used to specify the maximum limit defined for specific stop-loss at the member or main subscriber level.	Yes
Paid Start Date	Used to specify the paid start date based on which you want to accumulate the specific stop-loss.	Yes
	Note: The accumulated specific stop-loss for claim transactions are processed in the run-in or active period of the policy.	
Paid End Date	Used to specify the paid end date based on which you want to accumulate the specific stop-loss.	Yes
	Note: The accumulated specific stop-loss for claim transactions are processed in the run-in or active period of the policy.	
Settlement Days	Used to indicate the settlement days which helps to calculate the settlement date.	Yes
	Note: Settlement date is calculated as the pricing end date, incurred end date, or paid end date whichever is later added with the settlement days.	
Compute Aggregate SSL (ASSL)	Used to indicate whether the aggregate specific stop-loss (ASSL) should be calculated or not during the C1-BCSSL batch run for each bill group. The valid values are: <ul style="list-style-type: none"> • Yes • No 	Yes

Field Name	Field Description	Mandatory (Yes or No)
ASSL Credit Count	Used to indicate that the aggregate specific stop-loss amount beyond the ASSL limit will be paid by the insurance company to the ASSL credit account.	Yes
	Note: This field is enabled when you select Yes option from the Compute Aggregate SSL (ASSL) field.	
ASSL Limit	Note: This field is enabled when you select Yes option from the Compute Aggregate SSL (ASSL) field.	Yes

- Enter the required details in the **Accumulation Parameters** section.
- Click **Save**.

The accumulation parameters are defined in the specific stop-loss pricing rule.

Related Topics

For more information on...	See...
How to define a specific stop-loss pricing rule for a parent customer	Defining a Specific Stop-Loss Pricing Rule for a Parent Customer on page 2607
How to edit a specific stop-loss pricing rule of a parent customer	Editing a Specific Stop-Loss Pricing Rule of a Parent Customer on page 2615

Defining Run-in Parameters in a Specific Stop-Loss Pricing Rule

Procedure

To define run-in parameters in a specific stop-loss pricing rule:

- Ensure that the **Run-In Parameters** section is expanded when you have selected an option from the **Price Item** field of **Main** section while defining a specific stop-loss pricing rule.

The **Run-In Parameters** section contains the following fields:

Field Name	Field Description	Mandatory (Yes or No)
Run-In	Used to specify whether the run-in parameters of the run-in period of policy are to be considered or not in a specific stop-loss pricing	No
Incurred Start Date	Used to specify the incurred start date based on the run-in period of the policy in the specific stop-loss.	Yes
	Note: This field is enabled when you select the checkbox for the Run-In field.	
Incurred End Date	Used to specify the incurred end date based on the run-in period of the policy in the specific stop-loss.	Yes
	Note: This field is enabled when you select the checkbox for the Run-In field.	

Field Name	Field Description	Mandatory (Yes or No)
Paid Start Date	Used to specify the paid start date based on the run-in period of the policy in the specific stop-loss.	Yes
	Note: This field is enabled when you select the checkbox for the Run-In field.	
Paid End Date	Used to specify the paid end date based on the run-in period of the policy in the specific stop-loss.	Yes
	Note: This field is enabled when you select the checkbox for the Run-In field.	

- Enter the required details in the **Run-In Parameters** section.
- Click **Save**.

The run-in parameters are defined in the specific stop-loss pricing rule.

Related Topics

For more information on...	See...
How to define a specific stop-loss pricing rule for a parent customer	Defining a Specific Stop-Loss Pricing Rule for a Parent Customer on page 2607
How to edit a specific stop-loss pricing rule of a parent customer	Editing a Specific Stop-Loss Pricing Rule of a Parent Customer on page 2615

Defining Lasering and Exclusion Information in a Specific Stop-Loss Pricing Rule

Prerequisites

To define lasering and exclusion information in a specific stop-loss pricing rule, you should have:

- Lasering or exclusion level defined in the application.
- Exception type defined in the application.

Procedure

To define lasering and exclusion information in a specific stop-loss pricing rule:

- Ensure that the **Lasering and Exclusion** section is expanded when you have selected an option from the **Price Item** field of **Main** section while defining a specific stop-loss pricing rule.

The **Lasering and Exclusion** section contains the following columns in a grid:

Column Name	Column Description	Mandatory (Yes or No)
Accumulation Group ID	Displays blank column, accumulation group ID is generated when accumulation parameter values are defined for a specific stop-loss.	Not applicable
Level Identifier	Used to specify the lasering or exclusion level identifier.	Yes

Column Name	Column Description	Mandatory (Yes or No)
Lasering or Exclusion Level	Used to indicate the lasering or exclusion in a specific stop-loss. The valid values are: <ul style="list-style-type: none"> • Main Subscriber • Member • Provider 	Yes
Exception Type	Used to indicate the exception type. The valid values are: <ul style="list-style-type: none"> • Lasering • Exclusion 	Yes
	Note: This field displays Exclusion option and is disabled on selection of Provider option from the Lasering or Exclusion Level column.	
Comments	Used to specify the comments.	No
Lasered Amount	Used to specify the lasered amount.	Yes (Conditional)
	Note: This field is disabled when Exclusion option is selected from the Exception Type column.	Note: This column is mandatory when Lasering option is selected from the Exception Type column.

- Enter the required details in the **Lasering and Exclusion** section.
- If you want to define more than one lasering and exclusion information in a specific stop-loss pricing rule, click the **Add (+)** icon and then repeat step 2.

Note: However, if you want to remove a lasering and exclusion information from the specific stop-loss pricing rule, click the **Delete (🗑)** icon corresponding to the level identifier.

- Click **Save**.

The lasering and exclusion information is defined in a specific stop-loss pricing rule.

Related Topics

For more information on...	See...
How to define a specific stop-loss pricing rule for a parent customer	Defining a Specific Stop-Loss Pricing Rule for a Parent Customer on page 2607
How to edit the specific stop-loss pricing rule for a parent customer	Editing a Specific Stop-Loss Pricing Rule of a Parent Customer on page 2615

Defining a Characteristic for a Specific Stop-Loss Pricing Rule

Prerequisites

To define a characteristic for a specific stop-loss pricing rule, you should have:

- Characteristic types defined in the application (where the characteristic entity is set to **Pricing Rule**)

Procedure

To define a characteristic for a specific stop-loss pricing rule:

1. Ensure that the **Characteristics** section is expanded when you are defining or editing a pricing rule.

The **Characteristics** section contains the following columns in a grid:

Column Name	Column Description	Mandatory (Yes or No)
Effective Date	Used to specify the date from when the characteristic is effective for the specific stop-loss pricing rule.	Yes (Conditional)
		Note: This field is required when you are defining a characteristic for the specific stop-loss pricing rule.
Characteristic Type	Used to indicate the characteristic type. Note: The list includes only those characteristic types where the characteristic entity is set to Pricing Rule .	Yes (Conditional)
		Note: This field is required when you are defining a characteristic for the specific stop-loss pricing rule.
Characteristic Value	Used to specify the value for the characteristic type. Note: If you select a predefined characteristic type, the Search (🔍) icon appears corresponding to the Characteristic Value field. On clicking the Search icon, the Predefined Characteristic Search window appears. On specifying the value for a predefined characteristic type, the description of the characteristic value appears corresponding to the Characteristic Value field.	Yes (Conditional)
		Note: This field is required when you are defining a characteristic for the specific stop-loss pricing rule.

2. Enter the required details in the **Characteristics** section.
3. If you want to define more than one characteristic for the specific stop-loss pricing rule, click the **Add** (+) icon and then repeat step 2.

Note: However, if you want to remove a characteristic from the specific stop-loss pricing rule, click the **Delete** (🗑️) icon corresponding to the characteristic.

4. Click **Save**.

The characteristics are defined for the specific stop-loss pricing rule.

Related Topics

For more information on...	See...
How to define a specific stop-loss pricing rule for a parent customer	Defining a Specific Stop-Loss Pricing Rule for a Parent Customer on page 2607
How to edit the specific stop-loss pricing rule for a parent customer	Editing a Specific Stop-Loss Pricing Rule of a Parent Customer on page 2615

Editing a Specific Stop-Loss Pricing Rule of a Parent Customer

Prerequisites

To edit a specific stop-loss pricing rule of a parent customer, you should have:

- Business Object **C1-PricingRuleSSL** defined for specific stop-loss pricing rule.
- Pricing rule usage defined in the application.
- SSL accumulation level defined in the application.
- Underwriter review defined in the application.

Procedure

To edit a specific stop-loss pricing rule of a parent customer:

1. Search for the account, person, or policy whose pricing details you want to view in the **Customer 360° View** screen.

2. In the **Search Results** section, click the

View () icon corresponding to the account, person, or policy whose pricing details you want to view.

The **Account, Person, or Policy** tab in the **Customer 360° Information** screen appears.

3. Click the **Pricing** tab, in the **Parent Customer Pricing Rules** zone click the **Edit** () icon in the **Edit** column corresponding to the pricing rule type for specific stop-loss whose specific stop-loss pricing rule details you want

The **Specific Stop-Loss (SSL) Pricing Rule** screen appears. It contains the following sections:

- **Customer Information** – Displays the customer information.
- **Main** – Used to specify basic details about the specific stop-loss pricing rule.
- **Accumulation Parameters** – Used to define the accumulation parameters based on which you want to accumulate the specific stop-loss for the transactions which are processed in the run-in or active period of the policy.
- **Run-In Parameters** – Used to define run-in parameters in the run-in period of the policy.
- **Lasering and Exclusion** – Used to define the lasering and exclusion information to inherit the accumulation parameters.
- **Characteristics** – Used to define the characteristics for a specific stop-loss pricing rule.

The **Customer Information** section contains the following fields:

Field Name	Field Description	Mandatory (Yes or No)
Parent Customer Information	Displays the parent customer information	Not applicable
Pricing Rule Type	Indicates the pricing rule type.	Not applicable

The **Main** section contains the following fields:

Field Name	Field Description	Mandatory (Yes or No)
Price Item	Indicates the price item defined for pricing.	Not applicable
Pricing Start Date	Used to specify the pricing rule start date.	Yes
Pricing End Date	Used to specify the pricing rule end date.	Yes
Rate Option	Indicates the rate option used for defining the specific stop-loss pricing rule for the price item.	Not applicable

Field Name	Field Description	Mandatory (Yes or No)
Pricing Rule Usage	Used to indicate whether the pricing rule is used only for pricing or for pricing and billing. The valid values are: <ul style="list-style-type: none"> • Pricing • Pricing and Billing 	Yes
SSL Accumulation Level	Used to indicate whether the specific stop-loss must be accumulated at the member or main subscriber level. The valid values are: <ul style="list-style-type: none"> • Member • Main Subscriber 	
Settlement Frequency	Indicates the settlement frequency to determine the bill after date. The valid values are: <ul style="list-style-type: none"> • Immediately – The bill after date is not calculated. The specific stop-loss billable charge is billed immediately in the next cycle. • Manually (At Required Intervals) – The bill after date specified in the Manual Settlement Bill After Date parameter while executing the C1-BCSSL batch is stamped on the specific stop-loss billable charge. • Never – • Yearly – The bill after date in the specific stop-loss billable charge is set to the pricing end date. <p>Note: This field is disabled when you select Pricing and Billing option from the Pricing Rule Usage field.</p>	Not applicable
Underwriter Review	Used to indicate whether the underwriter settlement review flag is on or off. The valid values are: <ul style="list-style-type: none"> • Yes • No 	Yes

4. Modify the details in the **Main** section, if required.
5. Modify the accumulation parameters in a specific stop-loss pricing rule, if required.
6. Modify the run-in parameters in a specific stop-loss pricing rule, if required.
7. Add, edit, or remove the lasering and exclusion information for the specific stop-loss pricing rule, if required.
8. Add, edit, or remove characteristics for the specific stop-loss pricing rule, if required.
9. Click **Save**.

The changes made to a specific stop-loss pricing rule for a parent customer are saved.

Related Topics

For more information on...	See...
Customer 360° Information – Pricing tab	Customer 360° Information - Pricing Information on page 693
Parent Customer Pricing Rules zone	Parent Customer Pricing Rules on page 696
How to define accumulation parameters in a specific stop-loss pricing rule	Defining Accumulation Parameters in a Specific Stop-Loss Pricing Rule on page 2610
How to define run-in parameters in a specific stop-loss pricing rule	Defining Run-in Parameters in a Specific Stop-Loss Pricing Rule on page 2612
How to define lasering and exclusion information in a specific stop-loss pricing rule	Defining Lasering and Exclusion Information in a Specific Stop-Loss Pricing Rule on page 2613
How to define a characteristic for a specific stop-loss pricing rule	Defining a Characteristic for a Specific Stop-Loss Pricing Rule on page 2614

Viewing a Specific Stop-Loss Pricing Rule of a Parent Customer**Procedure**

To view a specific stop-loss pricing rule of a parent customer:

1. Search for the account, person, or policy whose pricing details you want to view in the **Customer 360° View** screen.
2. In the **Search Results** section, click the **View** () icon corresponding to the account, person, or policy whose pricing details you want to view.
The **Account, Person, or Policy** tab in the **Customer 360° Information** screen appears.
3. Click the **Pricing** tab.
4. In the **Parent Customer Pricing Rules** zone, click the link in the **Pricing Rule Information** column corresponding to the specific stop-loss pricing rule type whose specific stop-loss pricing rule you want to view.
The **Pricing Rule** screen appears. It contains the following zone:
 - **Specific Stop-Loss** – Displays the pricing rule specific stop-loss details for a parent customer. It contains the following sections:
 - **Main** – Displays the basic details of the specific stop-loss pricing rule.
 - **Accumulation Parameters** – Displays the accumulation parameters based on which accumulated specific stop-loss for the transactions are processed in the run-in or active period of the policy.
 - **Run-In Parameters** – Displays the run-in parameters in the run-in period of the policy.
 - **Lasering and Exclusion** – Displays the lasering and exclusion information that inherits the accumulation parameters
 - **Characteristics** – Displays the characteristics defined for the specific stop-loss pricing rule.
5. View the basic details of specific stop-loss pricing rule in the **Main** zone.
6. View the accumulated parameters in the **Accumulation Parameters** zone.
7. View the run-in parameters in the **Run-In Parameters** zone.
8. View the lasering and exclusion information in the **Lasering and Exclusion** zone.
9. View the characteristics of the specific stop-loss pricing rule in the **Characteristics** zone.

Related Topics

For more information on...	See...
Customer 360° Information – Pricing tab	Customer 360° Information - Pricing Information on page 693
Parent Customer Pricing Rules zone	Parent Customer Pricing Rules on page 696
Pricing Rule screen	Pricing Rule (Used for Viewing) on page 2902
Specific Stop-Loss zone	Specific Stop-Loss on page 2912

Deleting a Specific Stop-Loss Pricing Rule of a Parent Customer**Procedure**

To delete a specific stop-loss pricing rule of a parent customer:

1. Search for the account, person, or policy whose pricing details you want to view in the **Customer 360° View** screen.
2. In the **Search Results** section, click the **View** () icon corresponding to the account, person, or policy whose pricing details you want to view.

The **Account, Person, or Policy** tab in the **Customer 360° Information** screen appears.
3. Click the **Pricing** tab, in the **Parent Customer Pricing Rules** zone, click the **Delete** () icon in the **Delete** column corresponding to the specific stop-loss pricing rule type whose specific stop-loss pricing rule you want to delete.

A message appears confirming whether you want to delete the specific stop-loss pricing rule.
4. Click **OK**.

The specific stop-loss pricing rule is deleted.

Related Topics

For more information on...	See...
Customer 360° Information – Pricing tab	Customer 360° Information - Pricing Information on page 693
Parent Customer Pricing Rules zone	Parent Customer Pricing Rules on page 696

Defining a Specific Stop-Loss Pricing Rule for a Bill Group**Prerequisites**

To define a specific stop-loss pricing rule for a bill group, you should have:

- Business Object **C1-PricingRule** defined for pricing rule.
- Business Object **C1-PricingRuleSSL** defined for specific stop-loss pricing rule.
- Pricing rule type defined in the application.
- Policy status defined in the application.
- Price item defined in the application.
- Rate option defined in the application.

Procedure

To define a specific stop-loss pricing rule for a bill group:

1. Search for the account, person, or policy whose pricing details you want to view in the **Customer 360° View** screen.

- In the **Search Results** section, click the **View** () icon corresponding to the account, person, or policy whose pricing details you want to view.

The **Account, Person, or Policy** tab in the **Customer 360° Information** screen appears.

- Click the **Pricing** tab and then click the **Add** link in the upper right corner of the **Bill Group ASO Policy Pricing Rules** zone.

The **Pricing Rule** screen appears. It contains the following fields:

Field Name	Field Description	Mandatory (Yes or No)
Person Name	Displays the person name.	Not applicable
Person Type	Displays the person type.	Not applicable
Pricing Rule Type	Used to indicate the pricing rule type to create the pricing rule.	Yes
	Note: You can create a specific stop-loss pricing rule using the Pricing Rule Type for specific stop-loss.	
Pricing Group	Used to indicate the pricing group.	No
Policy Status	Used to indicate the policy status for pricing rule. The valid values are: <ul style="list-style-type: none"> In Force/Active Post Runout Runout 	Yes
	Note: Specific stop-loss pricing rule cannot be created for Runout or Post Runout policy status where the policy run out end date is missing.	

- Click **OK**.

The **Specific Stop-Loss (SSL) Pricing Rule** screen appears. It contains the following sections:

- Customer Information** – Displays the customer information for bill group.
- Main** – Used to specify basic details about the specific stop-loss pricing rule.
- Accumulation Criteria** – Used to define the accumulation criteria in a specific stop-loss pricing rule.
- Pricing Information** – Used to define stop-loss eligibility for claim line items.
- Characteristics** – Used to define the characteristics for the specific stop-loss pricing rule.

The **Customer Information** section contains the following fields:

Field Name	Field Description	Mandatory (Yes or No)
Bill Group Information	Displays the bill group information.	Not applicable
Policy Start Date	Displays the policy start date.	Not applicable
Policy End Date	Displays the policy end date.	Not applicable

Field Name	Field Description	Mandatory (Yes or No)
Policy Status	Indicates the policy status for pricing rule. The valid values are: <ul style="list-style-type: none"> In Force/Active Post Runout Runout 	Not applicable
Pricing Rule Type	Indicates the pricing rule type.	Not applicable

The **Main** section contains the following fields:

Field Name	Field Description	Mandatory (Yes or No)
Price Item	Used to indicate the price item.	Yes
	Note: Once an option is selected for this field, the field appears disabled.	
Parent Customer's SSL Pricing Rules	Used to indicate the pricing date range derived from the parent customer's specific stop-loss pricing rule.	Yes
	Note: This field is enabled for selection when an option from Price Item field is selected.	
Pricing Start Date	Displays the pricing rule start date.	Not applicable
	Note: This field displays the Policy Start Date .	
Pricing End Date	Displays the pricing rule end date.	Not applicable
	Note: This field displays the Policy End Date .	
Rate Option	Used to indicate the rate option to define the specific stop-loss pricing rule for the price item.	Yes
	Note: Rate options in this field appears for selection, when you select an option from the Price Item field.	

- Enter the required details in the **Main** section.
- Define accumulation criteria in a specific stop-loss pricing rule, if required.

<p>Note:</p> <p>The Accumulation Criteria section appears when an option from Parent Customer's SSL Pricing Rules field is selected.</p> <p>You can also define the Accumulation Criteria for each rule in a specific stop-loss pricing rule.</p>

- Define stop-loss eligibility for claim line items, if required.

Note:

The **Pricing Information** section appears when an option from **Parent Customer's SSL Pricing Rules** field is selected.

You can also define the **Pricing Information** for each rule in a specific stop-loss pricing rule.

8. Define characteristics for a specific stop-loss pricing rule, if required.
9. Click **Save**.

The specific stop-loss pricing rule for a bill group is defined.

Note: A price list and price assignment is created, the price list created is assigned to the specific stop-loss pricing rule.

Related Topics

For more information on...	See...
Customer 360° Information – Pricing tab	Customer 360° Information - Pricing Information on page 693
Bill Group ASO Policy Pricing Rules zone	Bill Group Self-Funded Policy Pricing Rules on page 702
How to define accumulation criteria in a specific stop-loss pricing rule	Defining Accumulation Criteria in a Specific Stop-Loss Pricing Rule on page 2622
How to define claim pricing information in a specific stop loss pricing rule	Defining Claim Pricing Information in a Specific Stop Loss Pricing Rule on page 2624
How to define a characteristic for a specific stop-loss pricing rule	Defining a Characteristic for a Specific Stop-Loss Pricing Rule on page 2614

Defining Accumulation Criteria in a Specific Stop-Loss Pricing Rule**Procedure**

To define accumulation criteria in a specific stop-loss pricing rule:

1. Ensure that the **Accumulation Criteria** section is expanded when you have selected an option from the **Parent Customer's SSL Pricing Rules** field of **Main** section while defining or editing a specific stop-loss pricing rule.

The **Accumulation Criteria** section contains the following fields:

Field Name	Field Description	Mandatory (Yes or No)
Accumulation Group ID	Displays blank field, accumulation group ID is generated when accumulation criteria values are defined for a specific stop-loss.	Not applicable
Run-In Maximum Limit	Used to specify the maximum specific stop-loss limit defined for the member when the claim transactions are received in the run-in period of the policy.	Yes
	Note: This field is enabled when the start date and end date selected from the Parent Customer's SSL Pricing Rules field of Main section is greater than today's date.	

Field Name	Field Description	Mandatory (Yes or No)									
SSL Limit	Used to specify whether the SSL limit indicating that the specific stop-loss amount beyond this limit will be paid by the insurance company.	Yes									
Price Item	Used to specify the price item information. Note: On clicking the Search (🔍) icon that appears corresponding to the Price Item field, the Price Item Search window appears.	No									
Price Item Parameters	This field contains the following columns: <table border="1" data-bbox="532 611 1024 1791"> <thead> <tr> <th>Column Name</th> <th>Column Description</th> <th>Mandatory (Yes or No)</th> </tr> </thead> <tbody> <tr> <td>Price Item Parameter</td> <td>Used to specify multiple parameters based on which you want to determine the price item utilization. Note: On clicking the Search (🔍) icon that appears corresponding to the Price Item Parameter field, the Price Item Parameter Search window appears.</td> <td>No</td> </tr> <tr> <td>Parameter Value</td> <td>Used to specify the value of the parameter. Note: On selecting the Price Item Parameter, the Search (🔍) icon appears corresponding to this field, and on clicking the icon, the Parameter Value Search window appears.</td> <td>No</td> </tr> </tbody> </table>	Column Name	Column Description	Mandatory (Yes or No)	Price Item Parameter	Used to specify multiple parameters based on which you want to determine the price item utilization. Note: On clicking the Search (🔍) icon that appears corresponding to the Price Item Parameter field, the Price Item Parameter Search window appears.	No	Parameter Value	Used to specify the value of the parameter. Note: On selecting the Price Item Parameter , the Search (🔍) icon appears corresponding to this field, and on clicking the icon, the Parameter Value Search window appears.	No	No
Column Name	Column Description	Mandatory (Yes or No)									
Price Item Parameter	Used to specify multiple parameters based on which you want to determine the price item utilization. Note: On clicking the Search (🔍) icon that appears corresponding to the Price Item Parameter field, the Price Item Parameter Search window appears.	No									
Parameter Value	Used to specify the value of the parameter. Note: On selecting the Price Item Parameter , the Search (🔍) icon appears corresponding to this field, and on clicking the icon, the Parameter Value Search window appears.	No									

- Enter the required details in the **Accumulation Criteria** section.

- If you want to define more than one price item in the accumulation group, click the **Add (+)** icon and then repeat step 2.

Note: However, if you want to remove a price item from the accumulation group, click the **Delete** (🗑️) icon corresponding to the price item.

- If you want to define more than one price item parameters for the price item, click the **Add (+)** icon and then repeat step 2.

Note: However, if you want to remove a price item parameter from the price item, click the **Delete** (🗑️) icon corresponding to the price item parameter.

- Click **Save**.

The accumulation criteria is defined in the specific stop-loss pricing rule.

- You can define accumulation rules for each rule in a specific stop-loss pricing rule.

Note: You can exclude a rule from the specific stop-loss pricing by selecting the **Exclude Rule** checkbox.

Related Topics

For more information on...	See...
How to define a specific stop-loss pricing rule for a bill group	Defining a Specific Stop-Loss Pricing Rule for a Bill Group on page 2619
How to edit a specific stop-loss pricing rule of a bill group	Editing a Specific Stop-Loss Pricing Rule of a Bill Group on page 2629

Defining Claim Pricing Information in a Specific Stop Loss Pricing Rule

Procedure

To define the stop-loss eligibility for claim line items:

- Ensure that the **Pricing Information** section is expanded when you have selected an option from the **Parent Customer's SSL Pricing Rules** field of **Main** section while defining or editing a specific stop-loss pricing rule.

The **Pricing Information** section contains the following section:

- Claim Pricing Rule** – Used to indicate the claim pricing rule. It contains the following sub-sections:
 - Domestic Provider Claims** – Used to specify the domestic provider claim while calculating specific stop-loss.
 - Markup or Markdown Values** – Used to define the markup or markdown values for billable charge line.
 - Line Items** – Used to associate line items eligible for billing.

The **Claim Pricing Rule** section contains the following field:

Field Name	Field Description	Mandatory (Yes or No)
Effective Claim Pricing Rule	Used to indicate the claim pricing rule effective for pricing.	No

On clicking the **Reapply Claim Template** button to the right side of the **Effective Claim Pricing Rule** field you can reapply for claim pricing rule.

Note: The **Reapply Claim Template** button appears when you are editing a specific stop-loss.

The **Domestic Provider Claims** section contains the following field:

Field Name	Field Description	Mandatory (Yes or No)
Exclude SSL (Percentage)	Used to specify the domestic provider claim billable charge line excluding the specific stop-loss in percentage to create domestic provider claim calculation lines.	No

The **Markup or Markdown Values** section contains the following fields:

Field Name	Field Description	Mandatory (Yes or No)
Pricing Strategy	Indicates the pricing strategy. The valid values are: <ul style="list-style-type: none"> • Markdown • Markup • None 	Not applicable
Markup or Markdown Type	Indicates the markup or markdown value type for claim line items. The valid values are: <ul style="list-style-type: none"> • Flat Amount • Percentage 	Not applicable
Markup or Markdown Amount	Displays the markup or markdown amount. Note: This field displays amount when Markup or Markdown Type field is Flat Amount .	Not applicable

The **Line Items** section contains the following fields:

Field Name	Field Description	Mandatory (Yes or No)
Sequence	Displays the sequence number for the line items.	Not applicable
Line Item	Displays the billing line items.	Not applicable
Eligible for Specific Stop-Loss	Used to specify whether the line item is eligible or not eligible for specific stop-loss.	No
Markup or Markdown Percentage Eligibility	Displays whether the line item is eligible or not eligible for markup or markdown percentage. The valid values are: <ul style="list-style-type: none"> • Eligible • Not Eligible 	Not applicable
Markup or Markdown Percentage	Displays the percentage for markup or markdown value.	Not applicable

2. Select the required details in the **Claim Pricing Rule** section, if required.

3. Enter the required details in the **Domestic Provider Claims** section, if required.
4. Select the required details in the **Line Items** section, if required.
5. Click **Save**.

The claim line items are defined in the specific stop-loss pricing rule.

6. You can define eligibility claim line items for each rule in a specific stop-loss pricing rule.

Note: You can exclude a rule from the specific stop-loss pricing by selecting the **Exclude Rule** checkbox.

Related Topics

For more information on...	See...
How to define a specific stop-loss pricing rule for a bill group	Defining a Specific Stop-Loss Pricing Rule for a Bill Group on page 2619
How to edit a specific stop-loss pricing rule of a bill group	Editing a Specific Stop-Loss Pricing Rule of a Bill Group on page 2629

Defining a Specific Stop-Loss Pricing Rule for a Bill Group Using a Pricing Group

Prerequisites

To define a specific stop-loss pricing rule for a bill group using a pricing group, you should have:

- Business Object **C1-PricingRule** defined for pricing rule.
- Business Object **C1-PricingRuleSSL** defined for specific stop-loss pricing rule.
- Pricing rule type defined in the application.
- Pricing group defined in the application.
- Policy status defined in the application.
- Price item defined in the application.
- Rate option defined in the application.

Procedure

To define a specific stop-loss pricing rule for a bill group using a pricing group:

1. Search for the account, person, or policy whose pricing details you want to view in the **Customer 360° View** screen.
2. In the **Search Results** section, click the **View** () icon corresponding to the account, person, or policy whose pricing details you want to view.

The **Account, Person, or Policy** tab in the **Customer 360° Information** screen appears.

3. Click the **Pricing** tab and then click the **Add** link in the upper right corner of the **Bill Group ASO Policy Pricing Rules** zone.

The **Pricing Rule** screen appears. It contains the following fields:

Field Name	Field Description	Mandatory (Yes or No)
Person Name	Displays the person name.	Not applicable
Person Type	Displays the person type.	Not applicable

Field Name	Field Description	Mandatory (Yes or No)
Pricing Rule Type	Used to indicate the pricing rule type to create the pricing rule.	Yes
	Note: You can create a specific stop-loss pricing rule using the Pricing Rule Type for specific stop-loss.	
Pricing Group	Used to indicate the pricing group.	Yes
Policy Status	Used to indicate the policy status for pricing rule. The valid values are: <ul style="list-style-type: none"> • In Force/Active • Post Runout • Runout 	Yes
	Note: Specific stop-loss pricing rule cannot be created for Runout or Post Runout policy status where the policy run out End Date is missing.	

4. Click **OK**.

The **Specific Stop-Loss (SSL) Pricing Rule** screen appears. It contains the following sections:

- **Customer Information** – Displays the customer information for bill group using pricing group.
- **Main** – Used to specify basic details about the claim pricing rule.
- **Markup or Markdown Values** – Used to define the markup or markdown values for billable charge line for each rule.
- **Line Items** – Used to associate line items eligible for billing for each rule.
- **Characteristics** – Used to define the characteristics for the claim pricing rule.

The **Customer Information** section contains the following fields:

Field Name	Field Description	Mandatory (Yes or No)
Bill Group Information	Displays the bill group information.	Not applicable
Policy Start Date	Displays the policy start date.	Not applicable
Policy End Date	Displays the policy end date.	Not applicable
Policy Status	Indicates the policy status for pricing rule. The valid values are: <ul style="list-style-type: none"> • In Force/Active • Post Runout • Runout 	Not applicable
Pricing Group	Displays the pricing group.	Not applicable
Pricing Rule Type	Indicates the pricing rule type.	Not applicable

The **Main** section contains the following fields:

Field Name	Field Description	Mandatory (Yes or No)
Price Item	Used to indicate the price item.	Yes
	Note: Once an option is selected for this field, the field appears disabled.	
Parent Customer's SSL Pricing Rules	Used to indicate the pricing date range derived from the parent customer's specific stop-loss pricing rule.	Yes
	Note: This field is enabled for selection when an option from Price Item field is selected.	
Pricing Start Date	Displays the pricing rule start date.	Yes
Pricing End Date	Displays the pricing rule end date.	Yes
Rate Option	Used to indicate the rate option to define the specific stop-loss pricing rule for the price item.	Yes
	Note: Rate options in this field appears for selection, when you select an option from the Price Item field.	

- Enter the required details in the **Main** section.
- Define accumulation criteria for each rule in a specific stop-loss pricing rule pricing rule, if required.

Note: The **Accumulation Criteria** section appears in the rule section and the rule section appears when an option from **Parent Customer's SSL Pricing Rules** field is selected.

- Define stop-loss eligibility for claim line items, if required.

Note: The **Pricing Information** section appears in the rule section and the rule section appears when an option from **Parent Customer's SSL Pricing Rules** field is selected.

- Define characteristics for a specific stop-loss pricing rule, if required.
- Click **Save**.

The specific stop-loss pricing rule for a bill group using a pricing group is defined.

Note: A price list and price assignment is created, the price list created is assigned to the specific stop-loss pricing rule.

Related Topics

For more information on...	See...
Customer 360° Information – Pricing tab	Customer 360° Information - Pricing Information on page 693
Bill Group ASO Policy Pricing Rules zone	Bill Group Self-Funded Policy Pricing Rules on page 702
How to define Accumulation Criteria in a specific stop-loss pricing rule	Defining Accumulation Criteria in a Specific Stop-Loss Pricing Rule on page 2622
How to define claim pricing information in a specific stop loss pricing rule	Defining Claim Pricing Information in a Specific Stop Loss Pricing Rule on page 2624

For more information on...	See...
How to define a characteristic for a specific stop-loss pricing rule	Defining a Characteristic for a Specific Stop-Loss Pricing Rule on page 2614

Editing a Specific Stop-Loss Pricing Rule of a Bill Group

Prerequisites

To edit a specific stop-loss pricing rule of a bill group, you should have:

- Business Object **C1-PricingRuleSSL** defined for specific stop-loss pricing rule.

Procedure

To edit a specific stop-loss pricing rule of a bill group:

1. Search for the account, person, or policy whose pricing details you want to view in the **Customer 360° View** screen.
2. In the **Search Results** section, click the **View** (🔗) icon corresponding to the account, person, or policy whose pricing details you want to view.

The **Account**, **Person**, or **Policy** tab in the **Customer 360° Information** screen appears.

3. Click the **Pricing** tab, in the **Bill Group ASO Policy Pricing Rules** zone click the **Edit** (✎) icon in the **Edit** column corresponding to the pricing rule type for specific stop-loss whose specific stop-loss pricing rule details you want to edit.

The **Specific Stop-Loss (SSL) Pricing Rule** screen appears. It contains the following sections:

- **Customer Information** – Displays the customer information for bill group.
- **Main** – Displays the basic details of the specific stop-loss pricing rule.
- **Accumulation Criteria** – Used to define the accumulation criteria in a specific stop-loss pricing rule.
- **Pricing Information** – Used to define stop-loss eligibility for claim line items.
- **Characteristics** – Used to define the characteristics for the specific stop-loss pricing rule.

The **Customer Information** section contains the following fields:

Field Name	Field Description	Mandatory (Yes or No)
Bill Group Information	Displays the bill group information.	Not applicable
Policy Start Date	Displays the policy start date.	Not applicable
Policy End Date	Displays the policy end date.	Not applicable
Policy Status	Indicates the policy status for pricing rule. The valid values are: <ul style="list-style-type: none"> • In Force/Active • Post Runout • Runout 	Not applicable
Pricing Rule Type	Indicates the pricing rule type.	Not applicable

The **Main** section contains the following fields:

Field Name	Field Description	Mandatory (Yes or No)
Price Item	Indicates the price item.	Not applicable

Field Name	Field Description	Mandatory (Yes or No)
Parent Customer's SSL Pricing Rules	Indicates the pricing date range derived from the parent customer's specific stop-loss pricing rule.	Not applicable
Pricing Start Date	Displays the pricing rule start date.	Not applicable
Pricing End Date	Displays the pricing rule end date.	Not applicable
Rate Option	Indicates the rate option of the specific stop-loss pricing rule for the price item.	Not applicable

- Modify the accumulation criteria in a specific stop-loss pricing rule, if required.

Note: You can add, edit, or remove price item and its price item parameters in the accumulation criteria for a specific stop-loss, if required.

- Modify the stop-loss eligibility for claim line items, if required.

Note: This section also consists of a button, **Reapply Claim Template**, on clicking the button a message occurs indicating that updating the claim template will reset all the default fields on the claim pricing rule.

- Add, edit, or remove characteristics for a specific stop-loss pricing rule, if required.
- Click **Save**.

The changes made to a specific stop-loss pricing rule for a bill group are saved.

Related Topics

For more information on...	See...
Customer 360° Information – Pricing tab	Customer 360° Information - Pricing Information on page 693
Bill Group ASO Policy Pricing Rules zone	Bill Group Self-Funded Policy Pricing Rules on page 702
How to define accumulation criteria in a specific stop-loss pricing rule	Defining Accumulation Criteria in a Specific Stop-Loss Pricing Rule on page 2622
How to define claim pricing information in a specific stop loss pricing rule	Defining Claim Pricing Information in a Specific Stop Loss Pricing Rule on page 2624
How to define a characteristic for a specific stop-loss pricing rule	Defining a Characteristic for a Specific Stop-Loss Pricing Rule on page 2614

Viewing a Specific Stop-Loss Pricing Rule of a Bill Group

Procedure

To view a claim pricing rule of a bill group:

- Search for the account, person, or policy whose pricing details you want to view in the **Customer 360° View** screen.
- In the **Search Results** section, click the **View** () icon corresponding to the account, person, or policy whose pricing details you want to view.

The **Account, Person, or Policy** tab in the **Customer 360° Information** screen appears.

- Click the **Pricing** tab.
- In the **Bill Group ASO Policy Information** zone, click the **Broadcast** () icon corresponding to the bill group whose specific stop-loss pricing rule bill group details you want to view.

- In the **Bill Group ASO Policy Pricing Rules** zone, click the link in the **Pricing Rule Information** column corresponding to the specific stop-loss pricing rule type whose specific stop-loss pricing rule bill group you want to view.

The **Pricing Rule** screen appears. It contains the following zone:

- **Specific Stop-Loss** – Displays the pricing rule specific stop-loss details for a bill group. It contains the following sections:
 - **Main** – Displays the basic details of the specific stop-loss pricing rule.
 - **Accumulation Criteria** – Displays the accumulation criteria in a specific stop-loss pricing rule.
 - **Pricing Information** – Displays the stop-loss eligibility for claim line items.
 - **Characteristics** – Displays the characteristics defined for the specific stop-loss pricing rule.
- View the basic details of specific stop-loss pricing rule in the **Main** section.
 - View the accumulation criteria in the **Markup or Markdown Values** section.
 - View the stop-loss eligibility for claim line items in the **Line Items** section.
 - View the characteristics of the specific stop-loss pricing rule in the **Characteristics** section.



Related Topics

For more information on...	See...
Customer 360° Information – Pricing tab	Customer 360° Information - Pricing Information on page 693
Bill Group ASO Policy Pricing Rules zone	Bill Group Self-Funded Policy Pricing Rules on page 702
Pricing Rule screen	Pricing Rule (Used for Viewing) on page 2902
Specific Stop-Loss zone	Specific Stop-Loss on page 2912

Deleting a Specific Stop-Loss Pricing Rule of a Bill Group

Procedure

To delete a specific stop-loss pricing rule of a bill group:

- Search for the account, person, or policy whose pricing details you want to view in the **Customer 360° View** screen.
- In the **Search Results** section, click the **View** () icon corresponding to the account, person, or policy whose pricing details you want to view.
The **Account, Person, or Policy** tab in the **Customer 360° Information** screen appears.
- Click the **Pricing** tab, in the **Bill Group ASO Policy Pricing Rules** zone, click the **Delete** () icon in the **Delete** column corresponding to the specific stop-loss pricing rule type whose specific stop-loss pricing rule you want to delete.
A message appears confirming whether you want to delete the specific stop-loss pricing rule.
- Click **OK**.

The specific stop-loss pricing rule is deleted.

Related Topics

For more information on...	See...
Customer 360° Information – Pricing tab	Customer 360° Information - Pricing Information on page 693
Bill Group ASO Policy Pricing Rules zone	Bill Group Self-Funded Policy Pricing Rules on page 702

Aggregate Stop-Loss (ASL) Pricing

ASL provides a ceiling on the eligible expenses that an employer would pay, in total for all members or subscribers, during a contract period. The amount that exceeds this limit will be paid by the insurance company.

You can define an aggregate stop-loss pricing rule at the parent customer and bill group levels. The aggregate stop-loss pricing rule at the bill group level takes precedence over the aggregate stop-loss pricing rule at the parent customer level. You can define aggregate stop-loss pricing rules for parent customers and bill groups from the **Customer 360° Information** screen. You can define an aggregate stop-loss pricing rule using an aggregate stop-loss pricing rule type. It is the aggregate stop-loss pricing rule type which helps the system to determine:

- Business object using which the aggregate stop-loss pricing rule should be created in the system.

Note: The aggregate stop-loss pricing rule type is not a primary pricing rule type. It inherits the attributes from a claim pricing rule type where it is included as a related pricing rule type.

- Algorithm which should be triggered while validating a transaction.

Note: An algorithm type for validating a transaction is not shipped from the product. You need to create a custom algorithm type, if required.

- Algorithms which should be triggered while deriving account and price item for a transaction.

Note: You must create an algorithm using the **C1_ACCPRISL** algorithm type and attach it to the **Account and Price Item Derivation** system event.

- Post-processing algorithm which should be triggered once the aggregate stop-loss pricing rule is derived.

Note: A post-processing algorithm type is not shipped from the product. You need to create a custom algorithm type, if required.

- Price items for which you can define aggregate stop-loss pricing rules using the aggregate stop-loss pricing rule type.
- Rate options that you can use while defining the pricing for a price item.
- Different type of account to which the price item should be billed based on the specified priority.

Note: Ideally, the price item parameters should not be specified in an aggregate stop-loss pricing rule type. The price item parameters which are specified in the claim pricing rule type are used for accumulating aggregate stop-loss.

- Additional information, such as:
 - Identifier which helps to determine whether the aggregate stop-loss should be calculated for claim transactions which are received during the run-in period of the policy.
 - ASL billable charge line type using which you want to create aggregate stop-loss billable charges.
 - Domestic provider claim billable charge line type using which you want to create domestic provider claim calculation lines.
 - Markup or markdown billable charge line type using which you want to create markup or markdown calculation lines.
 - Transaction field which you want to use in the rules as the output parameter to determine whether the line item is eligible for billing.
 - Transaction field which you want to use in the rules as the output parameter to determine whether the markup or markdown calculation line is eligible for billing.

- Transaction field which you want to use in the rules as the output parameter to determine whether the domestic provider claim calculation line is eligible for billing.
- ASL limit price item whose effective retention type enrollment based pricing should be used to calculate the enrollment based limit when the ASL Limit (During Policy Period) or ASL Limit (During Settlement Period) field is set to Enrollment Based Limit, Enrollment Based or Minimum ASL Limit (Whichever is Greater), or Percentage of Enrollment Based Limit in the aggregate stop-loss pricing rule which is defined for a parent customer.

Once an aggregate stop-loss pricing rule type is defined, you can create aggregate stop-loss pricing rules using the aggregate stop-loss pricing rule type. While defining an aggregate stop-loss pricing rule for a parent customer, you need to specify the following:

- Price item for which you want to define the pricing.
- Parent customer's SSL pricing rule from which you want to inherit the settlement frequency, settlement days, accumulation parameters (such as incurred start date, incurred end date, paid start date, and paid end date).

Note: The pricing date range is derived from the parent customer's specific stop-loss pricing rule because the specific stop-loss and aggregate stop-loss pricing rules for a parent customer should have the same date range.

- Rate option which you want to use while defining the aggregate stop-loss pricing.
- Settlement frequency which helps to determine the bill after date. The valid values are:
 - Immediately – If you select this option from the list, the bill after date is not calculated. The aggregate stop-loss billable charge is billed immediately in the next bill cycle.
 - Manually (At Required Intervals) - If you select this option from the list, the bill after date which is specified in the **Manual Settlement Date** parameter while executing the **C1-BCASL** batch is stamped on the aggregate stop-loss billable charge.
 - Monthly - If you select this option from the list, the bill after date which is specified in the **Manual Settlement Date** parameter while executing the **C1-BCASL** batch is stamped on the aggregate stop-loss billable charge.
 - Yearly – If you select this option from the list, the bill after date in the aggregate stop-loss billable charge is set to the pricing end date.
- Account in which the aggregate stop-loss amount should be credited.
- Accumulation parameters (such as incurred start date, incurred end date, paid start date, paid end date, etc.) based on which you want to accumulate the aggregate stop-loss for the claim transactions which are processed in the run-in or active period of the policy.
- The maximum limit defined for aggregate stop-loss at the parent customer level.
- Settlement days which helps to calculate the settlement date (i.e. pricing end date, incurred end date, or paid end date whichever is later + settlement days)
- Whether the ASL limit should be set to either of the following during the policy period:
 - Policy Based Limit
 - Enrollment Based or Minimum ASL Limit (Whichever is Greater)
 - Enrollment Based Limit
 - Percentage of Enrollment Based Limit
- Whether the ASL limit should be set to either of the following during the settlement period:
 - Policy Based Limit
 - Enrollment Based or Minimum ASL Limit (Whichever is Greater)
 - Enrollment Based Limit

However, while defining an aggregate stop-loss pricing rule for a bill group, you need to specify the following:

- The status of the policy for which you want to define the aggregate stop-loss pricing rule.
- Price item for which you want to define the pricing.
- Parent customer's ASL pricing rule from which you want to inherit the pricing date range.

Note: The pricing date range is derived from the parent customer's aggregate stop-loss pricing rule because the aggregate stop-loss pricing rules for parent customer and bill group should have the same date range.

- Rate option which you want to use while defining the aggregate stop-loss pricing.
- Whether the aggregate stop-loss calculated for the claim transactions which are mapped to the specified price items and price item parameters should be accumulated.
- Whether line items in a claim pricing rule are eligible for aggregate stop-loss.

Note: By default, the line items where the pricing rule type category is set to Aggregate Stop-Loss appear in the Line Items section. If you want to set aggregate stop-loss eligibility for the line items which belong to a particular claim pricing rule, you must select the respective claim pricing rule.

- Whether certain percentage of ASL should be excluded while calculating aggregate stop-loss for domestic provider claim.

You can also specify a pricing group while defining an aggregate stop-loss pricing rule for a bill group. If you specify a pricing group while defining an aggregate stop-loss pricing rule for a bill group, you will have to define the following details for each rule defined in the pricing group:

- Whether the aggregate stop-loss calculated for the claim transactions which are mapped to the specified price items and price item parameters should be accumulated.
- Whether line items in a claim pricing rule are eligible for aggregate stop-loss.

Note: By default, the line items where the pricing rule type category is set to Aggregate Stop-Loss appear in the Line Items section. If you want to set aggregate stop-loss eligibility for the line items which belong to a particular claim pricing rule, you must select the respective claim pricing rule.

- Whether certain percentage of ASL should be excluded while calculating aggregate stop-loss for domestic provider claim.

Once an aggregate stop-loss pricing rule is defined for a parent customer and bill group, the system creates one price assignment, one price list, and one price list assignment.

Defining a Aggregate Stop-Loss (ASL) Pricing Rule Type

Prerequisites

To define an aggregate stop-loss (SSL) pricing rule type, you should have:

- Business Object **C1-PricingRuleTypeASL** defined for pricing rule type.
- Business Object **C1-PricingRuleASL** defined for pricing rule.
- Pricing rule type category for aggregate stop-loss defined in the application

Procedure

To define an aggregate stop-loss pricing rule type:

1. Click the **Admin** link in the **Application** toolbar.
A list appears.
2. From the **Admin** menu, select **P** and then click **Pricing Rule Type**.
A sub-menu appears.

- Click the **Add** option from the **Pricing Rule Type** sub-menu.

The **Select Business Object** screen appears. It contains the following field:

Field Name	Field Description	Mandatory (Yes or No)
Pricing Rule Type Business Object	Used to indicate the business object using which you want to create the pricing rule type. Note: You can create an aggregate stop-loss pricing rule type using the Aggregate Stop-Loss (ASL) Pricing Rule Type business object.	Yes

Tip: Alternatively, you can access this screen by clicking the **Add** button in the **Page Title** area of the **Pricing Rule Type** screen.

- Select the **Aggregate Stop-Loss (ASL) Pricing Rule Type** business object.
- Click **OK**.

The **Aggregate Stop-Loss (ASL) Pricing Rule Type** screen appears. It contains the following sections:

- Main** – Used to specify basic details about the aggregate stop-loss pricing rule type.
- Related Pricing Rule Types** – Used to define the pricing rule types which are related to the parent pricing rule type.
- Transaction Field Mapping** – Used to specify the transaction related data mapped to the pricing rule type.
- Algorithms** – Used to define the algorithms used for the pricing rule type.
- Additional Data** – Used to specify the additional information about the pricing rule type.
- Price Items** – Used to define the price items assigned to the pricing rule type.
- Price Item Parameters** – Used to define the price item parameters in the pricing rule type.
- Characteristics** – Used to define the characteristics for the pricing rule type.
- ASL-Specific Additional Data** – Used to specify the aggregate stop-loss related additional data.

The **Main** section contains the following fields:

Field Name	Field Description	Mandatory (Yes or No)
Pricing Rule Type	Used to specify the pricing rule type.	Yes
Description	Used to specify the description for the pricing rule type.	Yes
Detailed Description	Used to specify additional information about the pricing rule type.	No
Related Transaction Business Object	Used to indicate the pricing rule business object. The valid values are: <ul style="list-style-type: none"> Claim Pricing Rule Aggregate Stop-Loss (ASL) Pricing Rule Specific Stop-Loss (SSL) Pricing Rule Retention Type Claim Based Pricing Rule Retention Type Enrollment Based Pricing Rule 	Yes

Field Name	Field Description	Mandatory (Yes or No)
Business Object	Indicate the pricing rule type business object for aggregate stop-loss.	Not applicable
Status	Used to indicate the status of the pricing rule type. The valid values are: <ul style="list-style-type: none"> Active Inactive 	Yes
Primary	Used to select the checkbox if the pricing rule type is primary.	No
Pricing Rule Type Category	Used to indicate the pricing rule type category for the pricing rule type. The valid values are: <ul style="list-style-type: none"> Claim Aggregate Stop-Loss Specific Stop-Loss Retention Type Claim Based Retention Type Enrollment Based 	Yes

- Enter the required details in the **Main** section.
- Add the related pricing rule types in the primary pricing rule type, if required.

Note: Related Pricing Rule Types section appears when the pricing rule type is primary.

- Define the transaction field mapping in the primary pricing rule type, if required.

Note: Transaction Field Mapping section appears when the pricing rule type is primary.

- Associate algorithms with the pricing rule type, if required.
- Define additional data for the pricing rule type, if required.
- Add pricing items in the pricing rule type, if required.
- Add price item parameters in the pricing rule type, if required.
- Define characteristics for the pricing rule type, if required.
- Add the ASL-Specific additional data in the pricing rule type, if required.
- Click **Save**.

The aggregate stop-loss pricing rule type is defined.

Related Topics

For more information on...	See...
Pricing Rule Type screen	Pricing Rule Type on page 2532
How to add the related pricing rule types in the primary pricing rule type	Adding Related Pricing Rule Types in a Primary Pricing Rule Type on page 2549
How to define the transaction field mapping in the primary pricing rule type	Defining Transaction Field Mapping in a Primary Pricing Rule Type on page 2551

For more information on...	See...
How to associate algorithms with the pricing rule type	Associating Algorithms with a Pricing Rule Type on page 2557
How to define additional data for the pricing rule type	Defining Additional Data for a Pricing Rule Type on page 2559
How to add pricing items in the pricing rule type	Adding Price Items in a Pricing Rule Type on page 2561
How to add price item parameters in the pricing rule type	Adding a Price Item Parameter in a Pricing Rule Type on page 2564
How to define a characteristic for the pricing rule type	Defining a Characteristic for a Pricing Rule Type on page 2566
How to add the ASL-Specific data in the pricing rule type	Adding the ASL-Specific Data in a Pricing Rule Type on page 2637

Adding the ASL-Specific Data in a Pricing Rule Type

Procedure

To add the ASL-Specific additional data in a pricing rule type:

1. Ensure that the **ASL-Specific Additional Data** section is expanded when you are defining or editing a pricing rule type.

The **ASL-Specific Additional Data** section contains the following fields:

Field Name	Field Description	Mandatory (Yes or No)
ASL Billable Charge Line Type	Used to specify the Aggregate Stop-Loss billable charge line type. Note: On clicking the Search (🔍) icon that appears corresponding to the ASL Billable Charge Line Type field, the Billable Charge Line Type Search window appears. On specifying the billable charge line type, the description of the billable charge line type appears corresponding to the ASL Billable Charge Line Type field.	No

Field Name	Field Description	Mandatory (Yes or No)
Domestic Provider Claim Billable Charge Line Type	<p>Used to specify the claim billable charge line type for domestic provider.</p> <p>Note:</p> <p>On clicking the Search (🔍) icon that appears corresponding to the Domestic Provider Claim Billable Charge Line Type field, the Billable Charge Line Type Search window appears.</p> <p>On specifying the billable charge line type, the description of the billable charge line type appears corresponding to the Domestic Provider Claim Billable Charge Line Type field.</p>	No
Markup or Markdown Billable Charge Line Type	<p>Used to specify the markup or markdown billable charge line type.</p> <p>Note:</p> <p>On clicking the Search (🔍) icon that appears corresponding to the Markup or Markdown Billable Charge Line Type field, the Billable Charge Line Type Search window appears.</p> <p>On specifying the billable charge line type, the description of the billable charge line type appears corresponding to the Markup or Markdown Billable Charge Line Type field.</p>	No
Rule Based Billing Eligibility Field	<p>Used to specify whether the rule based field is eligible for billing or not.</p> <p>Note:</p> <p>On clicking the Search (🔍) icon that appears corresponding to the Rule Based Billing Eligibility Field field, the Field Search window appears.</p> <p>On specifying the field, the description of the field appears corresponding to the Rule Based Billing Eligibility Field field.</p>	No

Field Name	Field Description	Mandatory (Yes or No)
Rule Based Markup or Markdown Eligibility Field	Used to specify whether the rule based markup or markdown field is eligible for billing or not.	No
	<p>Note:</p> <p>On clicking the Search (🔍) icon that appears corresponding to the Rule Based Markup or Markdown Eligibility Field field, the Field Search window appears.</p> <p>On specifying the field, the description of the field appears corresponding to the Rule Based Markup or Markdown Eligibility Field field.</p>	
Rule Based Domestic Provider Claim Eligibility Field	Used to specify the rule based domestic provider for claim eligibility field.	No
	<p>Note:</p> <p>On clicking the Search (🔍) icon that appears corresponding to the Rule Based Domestic Provider Claim Eligibility Field field, the Field Search window appears.</p> <p>On specifying the field, the description of the field appears corresponding to the Rule Based Domestic Provider Claim Eligibility Field field.</p>	
ASL Limit Price Item	Used to specify the Aggregated Stop-Loss limit price item.	No

2. Enter the required details in the **ASL-Specific Additional Data** section.
3. Click **Save**.

The ASL-Specific Additional data is added in the pricing rule type.

Related Topics

For more information on...	See...
How to define an aggregate stop-loss (ASL) pricing rule type	Defining a Aggregate Stop-Loss (ASL) Pricing Rule Type on page 2634
How to edit the aggregate stop-loss (ASL) pricing rule type	Editing an Aggregate Stop-Loss (ASL) Pricing Rule Type on page 2639

Editing an Aggregate Stop-Loss (ASL) Pricing Rule Type

Prerequisites

To edit the aggregate stop-loss (ASL) pricing rule type, you should have:

- Business Object **C1-PricingRuleASL** defined for pricing rule.
- Pricing rule type category for aggregate stop-loss (ASL) defined in the application

Procedure

To edit the aggregate stop-loss (ASL) pricing rule type:

1. Click the **Admin** link in the **Application** toolbar.

A list appears.

2. From the **Admin** menu, select **P** and then click **Pricing Rule Type**.

A sub-menu appears.

3. Click the **Search** option from the **Pricing Rule Type** sub-menu.

The **Pricing Rule Type** screen appears.

4. In the **Pricing Rule Type List** zone, click the **Edit**  icon in the **Edit** column corresponding to the pricing rule type for aggregate stop-loss (ASL) whose details you want to edit.

The **Aggregate Stop-Loss (ASL) Pricing Rule Type** screen appears. It contains the following sections:

- **Main** – Used to specify basic details about the aggregate stop-loss pricing rule type.
- **Related Pricing Rule Types** – Used to define the pricing rule types which are related to the parent pricing rule type.
- **Transaction Field Mapping** – Used to specify the transaction related data mapped to the pricing rule type
- **Algorithms** – Used to define the algorithms used for the pricing rule type.
- **Additional Data** – Used to specify the additional information about the pricing rule type.
- **Price Items** – Used to define the price items assigned to the pricing rule type.
- **Price Item Parameters** – Used to define the price item parameters in the pricing rule type.
- **Characteristics** – Used to define the characteristics for the pricing rule type.
- **ASL-Specific Additional Data** – Used to specify the aggregate stop-loss additional data.

The **Main** section contains the following fields:

Field Name	Field Description	Mandatory (Yes or No)
Pricing Rule Type	Displays the pricing rule type.	Not applicable
Description	Used to specify the description for the pricing rule type.	Yes
Detailed Description	Used to specify additional information about the pricing rule type.	No
Related Transaction Business Object	Used to indicate the pricing rule business object. The valid values are: <ul style="list-style-type: none"> • Claim Pricing Rule • Aggregate Stop-Loss (ASL) Pricing Rule • Specific Stop-Loss (SSL) Pricing Rule • Retention Type Claim Based Pricing Rule • Retention Type Enrollment Based Pricing Rule 	Yes
Business Object	Displays the pricing rule type business object for aggregate stop-loss.	Not applicable
Status	Used to indicate the status of the pricing rule type. The valid values are: <ul style="list-style-type: none"> • Active • Inactive 	Yes

Field Name	Field Description	Mandatory (Yes or No)
Primary	Used to select the checkbox if the pricing rule type is primary.	No
Pricing Rule Type Category	Used to indicate the pricing rule type category for the pricing rule type. The valid values are: <ul style="list-style-type: none"> • Claim • Aggregate Stop-Loss • Specific Stop-Loss • Retention Type Claim Based • Retention Type Enrollment Based 	Yes

Tip: Alternatively, you can click the **Edit** button in the **Pricing Rule Type** zone to edit the pricing rule type for specific stop-loss.

5. Modify the details in the **Main** section, if required.
6. Add, edit, or remove the related pricing rule types in the primary pricing rule type, if required.
7. Modify the transaction field mapping in the primary pricing rule type, if required.
8. Add, edit, or remove algorithms with the pricing rule type, if required.
9. Modify the additional data for the pricing rule type, if required.
10. Add, edit, or remove pricing items in the pricing rule type, if required.
11. Add, edit, or remove price item parameters in the pricing rule type, if required.
12. Add, edit, or remove characteristics for the pricing rule type, if required.
13. Modify the ASL-Specific data in the pricing rule type, if required.
14. Click **Save**.

The changes made to the aggregate stop-loss pricing rule type are saved.

Related Topics

For more information on...	See...
Pricing Rule Type screen	Pricing Rule Type on page 2532
Pricing Rule Type List zone	Pricing Rule Type List on page 2533
Pricing Rule Type zone	Pricing Rule Type on page 2536
How to add the related pricing rule types in the primary pricing rule type	Adding Related Pricing Rule Types in a Primary Pricing Rule Type on page 2549
How to define the transaction field mapping in the primary pricing rule type	Defining Transaction Field Mapping in a Primary Pricing Rule Type on page 2551
How to associate algorithms with the pricing rule type	Associating Algorithms with a Pricing Rule Type on page 2557
How to define additional data for the pricing rule type	Defining Additional Data for a Pricing Rule Type on page 2559
How to add pricing items in the pricing rule type	Adding Price Items in a Pricing Rule Type on page 2561

For more information on...	See...
How to add price item parameters in the pricing rule type	Adding a Price Item Parameter in a Pricing Rule Type on page 2564
How to define a characteristic for the pricing rule type	Defining a Characteristic for a Pricing Rule Type on page 2566
How to add the ASL-Specific data in the pricing rule type	Adding the ASL-Specific Data in a Pricing Rule Type on page 2637

Deleting an Aggregate Stop-Loss (ASL) Pricing Rule Type

Procedure

To delete an aggregate stop-loss pricing rule type:

1. Click the **Admin** link in the **Application** toolbar.
A list appears.
2. From the **Admin** menu, select **P** and then click **Pricing Rule Type**.
A sub-menu appears.
3. Click the **Search** option from the **Pricing Rule Type** sub-menu.
The **Pricing Rule Type** screen appears.
4. In the **Pricing Rule Type List** zone, click the **Delete** (🗑️) icon in the **Delete** column corresponding to the aggregate stop-loss pricing rule type that you want to delete.
A message appears confirming whether you want to delete the aggregate stop-loss pricing rule type.

Note: You can delete an aggregate stop-loss pricing rule type when it is not yet used in the system.

Tip: Alternatively, you can delete an aggregate stop-loss pricing rule type by clicking the **Delete** button in the **Pricing Rule Type** zone.

5. Click **OK**.
The aggregate stop-loss pricing rule type is deleted.

Related Topics

For more information on...	See...
Pricing Rule Type screen	Pricing Rule Type on page 2532
Pricing Rule Type List zone	Pricing Rule Type List on page 2533
Pricing Rule Type zone	Pricing Rule Type on page 2536

Viewing the Aggregate Stop-Loss (ASL) Pricing Rule Type Details

Procedure

To view the details of an aggregate stop-loss pricing rule type:

1. Click the **Admin** link in the **Application** toolbar.
A list appears.
2. From the **Admin** menu, select **P** and then click **Pricing Rule Type**.

A sub-menu appears.

3. Click the **Search** option from the **Pricing Rule Type** sub-menu.

The **Pricing Rule Type** screen appears.

4. In the **Pricing Rule Type List** zone, click the **Broadcast** () icon corresponding to the aggregate stop-loss pricing rule type whose details you want to view.

The **Pricing Rule Type** zone appears.

5. View the details of the aggregate stop-loss pricing rule type in the **Pricing Rule Type** zone.

Related Topics

For more information on...	See...
Pricing Rule Type screen	Pricing Rule Type on page 2532
Pricing Rule Type List zone	Pricing Rule Type List on page 2533
Pricing Rule Type zone	Pricing Rule Type on page 2536

Defining an Aggregate Stop-Loss Pricing Rule for a Parent Customer

Prerequisites

To define an aggregate stop-loss pricing rule for a parent customer, you should have:

- Business Object **C1-PricingRule** defined for pricing rule.
- Business Object **C1-PricingRuleASL** defined for aggregate stop-loss pricing rule.
- Pricing rule type defined in the application.
- Price item defined in the application.
- Rate option defined in the application.
- Settlement frequency defined in the application.
- Underwriter review defined in the application.

Procedure

To define an aggregate stop-loss pricing rule for a parent customer:

1. Search for the account, person, or policy whose pricing details you want to view in the **Customer 360° View** screen.
2. In the **Search Results** section, click the **View** () icon corresponding to the account, person, or policy whose pricing details you want to view.

The **Account**, **Person**, or **Policy** tab in the **Customer 360° Information** screen appears.

3. Click the **Pricing** tab and then click the **Add** link in the upper right corner of the **Parent Customer Pricing Rules** zone.

The **Pricing Rule** screen appears. It contains the following fields:

Field Name	Field Description	Mandatory (Yes or No)
Person Name	Displays the person name.	Not applicable
Person Type	Displays the person type.	Not applicable

Field Name	Field Description	Mandatory (Yes or No)
Pricing Rule Type	Used to indicate the pricing rule type to create the pricing rule.	Yes
	Note: You can create an aggregate stop-loss pricing rule using the Pricing Rule Type for aggregate stop-loss.	

4. Click **OK**.

The **Aggregate Stop-Loss (ASL) Pricing Rule** screen appears. It contains the following sections:

- **Customer Information** – Displays the customer information.
- **Main** – Used to specify basic details about the aggregate stop-loss pricing rule.
- **Accumulation Parameters** – Used to define the accumulation parameters based on which you want to accumulate the aggregate stop-loss for the transactions which are processed in the run-in or active period of the policy.
- **Run-In Parameters** – Used to define run-in parameters in the run-in period of the policy.
- **Characteristics** – Used to define the characteristics for an aggregation stop-loss pricing rule.

The **Customer Information** section contains the following fields:

Field Name	Field Description	Mandatory (Yes or No)
Parent Customer Information	Displays the parent customer information	Not applicable
Pricing Rule Type	Indicates the pricing rule type.	Not applicable

The **Main** section contains the following fields:

Field Name	Field Description	Mandatory (Yes or No)
Price Item	Used to indicate the price item which you want to define for pricing.	Yes
Parent Customer's SSL or ASL Pricing Rules	Used to indicate the pricing date range derived from the parent customer's specific stop-loss or aggregate stop-loss pricing rules.	Yes
	Note: This field is enabled when you select an option from the Price Item field.	
Pricing Start Date	Displays the pricing rule start date.	Not applicable
	Note: By default it displays the Policy Start Date .	
Pricing End Date	Displays the pricing rule end date.	Not applicable
	Note: This field displays date when you select the date range from Parent Customer's SSL or ASL Pricing Rules .	

Field Name	Field Description	Mandatory (Yes or No)
Rate Option	Used to indicate the rate option which you want to use for defining the aggregate stop-loss pricing rule for the price item.	Yes
	Note: Options appears in this field when you select an option from the Price Item field.	
Settlement Frequency	Used to indicate the settlement frequency which helps to determine the bill after date. The valid values are: <ul style="list-style-type: none"> • Immediately – The bill after date is not calculated. The aggregate stop-loss billable charge is billed immediately in the next cycle. • Manually (At Required Intervals) – The bill after date specified in the Manual Settlement Date parameter while executing the C1-BCASL batch is stamped on the aggregate stop-loss billable charge. • Monthly – The bill after date specified in the Manual Settlement Date parameter while executing the C1-BCASL batch is stamped on the aggregate stop-loss billable charge. • Yearly – The bill after date in the aggregate stop-loss billable charge is set to the pricing end date. 	Yes
	Note: This field is enabled when you select an option from the Price Item field.	
Underwriter Review	Used to indicate whether the underwriter settlement review flag is on or off. The valid values are: <ul style="list-style-type: none"> • Yes • No 	Yes
	Note: This field is enabled when you select an option from the Price Item field.	

5. Enter the required details in the **Main** section.
6. Define accumulation parameters in an aggregate stop-loss pricing rule, if required.

Note: The **Accumulation Parameters** section appears when an option from the **Price Item** field is selected.

7. Define run-in parameters in an aggregate stop-loss pricing rule, if required.

Note: The **Run-In Parameters** section appears when an option from the **Price Item** field is selected.

8. Define characteristics for an aggregate stop-loss pricing rule, if required.
9. Click **Save**.

The aggregate stop-loss pricing rule for a parent customer is defined.

Related Topics

For more information on...	See...
Customer 360° Information – Pricing tab	Customer 360° Information - Pricing Information on page 693
Parent Customer Pricing Rules zone	Parent Customer Pricing Rules on page 696
How to define accumulation parameters in an aggregate stop-loss pricing rule	Defining Accumulation Parameters in an Aggregate Stop-Loss Pricing Rule on page 2646
How to define run-in parameters in an aggregate stop-loss pricing rule	Defining Run-in Parameters in an Aggregate Stop-Loss Pricing Rule on page 2649
How to define a characteristic for an aggregate stop-loss pricing rule	Defining a Characteristic for an Aggregate Stop-Loss Pricing Rule on page 2650

Defining Accumulation Parameters in an Aggregate Stop-Loss Pricing Rule

Procedure

To define accumulation parameters in an aggregate stop-loss pricing rule:

1. Ensure that the **Accumulation Parameters** section is expanded when you have selected an option from the **Price Item** field of **Main** section while defining an aggregation stop-loss pricing rule.

The **Accumulation Parameters** section contains the following fields:

Field Name	Field Description	Mandatory (Yes or No)
Accumulation Group ID	Displays blank field, accumulation group ID is generated when accumulation parameter values are defined for an aggregation stop-loss.	Not applicable
ASL Credit Account	Used to indicate the account in which the aggregate stop-loss amount should be credited. Note: This field becomes read when you select a date range from the Parent Customer's SSL or ASL Pricing Rules .	Not applicable
Incurred Start Date	Displays the incurred start date based on which you want to accumulate the aggregate stop-loss. Note: The accumulated aggregated stop-loss for claim transactions are processed in the run-in or active period of the policy. This field displays date when you select a date range from the Parent Customer's SSL or ASL Pricing Rules . Incurred Start Date is equal to the pricing rule start date.	Not applicable

Field Name	Field Description	Mandatory (Yes or No)
Incurred End Date	<p>Displays the incurred end date based on which you want to accumulate the aggregate stop-loss.</p> <p>Note:</p> <p>The accumulated aggregated stop-loss for claim transactions are processed in the run-in or active period of the policy.</p> <p>This field displays date when you select a date range from the Parent Customer's SSL or ASL Pricing Rules.</p> <p>Incurred End Date is equal to the pricing rule end date.</p>	Not applicable
ASL Payout Limit	Used to specify the maximum limit defined for aggregated stop-loss at the member or main subscriber level.	Yes
Paid Start Date	<p>Used to specify the paid start date based on which you want to accumulate the aggregate stop-loss.</p> <p>Note:</p> <p>The accumulated specific stop-loss for claim transactions are processed in the run-in or active period of the policy.</p> <p>This field displays date when you select a date range from the Parent Customer's SSL or ASL Pricing Rules.</p> <p>Paid Start Date is equal to the pricing rule start date.</p>	Yes
Paid End Date	<p>Used to specify the paid end date based on which you want to accumulate the aggregate stop-loss.</p> <p>Note:</p> <p>The accumulated specific stop-loss for claim transactions are processed in the run-in or active period of the policy.</p> <p>This field displays date when you select a date range from the Parent Customer's SSL or ASL Pricing Rules.</p> <p>Paid End Date is equal to the pricing rule end date.</p>	Yes
Settlement Days	<p>Used to indicate the settlement days which helps to calculate the settlement date.</p> <p>Note: Settlement date is calculated as the pricing end date, incurred end date, or paid end date whichever is later added with the settlement days.</p>	Yes

Field Name	Field Description	Mandatory (Yes or No)
ASL Limit (During Policy Period)	Used to indicate the aggregate stop-loss limit set during the policy period. The valid values are: <ul style="list-style-type: none"> • Policy Based Limit • Enrollment Based Limit • Percentage of Enrollment Based Limit • Enrollment Based or Minimum ASL Limit (Whichever is Greater) 	Yes
ASL Limit (During Settlement Period)	Used to indicate the aggregate stop-loss limit set during the settlement period. The valid values are: <ul style="list-style-type: none"> • Policy Based Limit • Enrollment Based Limit • Enrollment Based or Minimum ASL Limit (Whichever is Greater) 	Yes
Minimum ASL Limit	Used to specify the minimum ASL limit.	Yes (Conditional)
	Note: This field is enabled when you select the Enrollment Based or Minimum ASL Limit (Whichever is Greater) option from the ASL Limit (During Policy Period) or ASL Limit (During Settlement Period) field.	Note: This field is required when the ASL Limit (During Policy Period) or ASL Limit (During Settlement Period) is Enrollment Based or Minimum ASL Limit (Whichever is Greater) .
Percentage of Enrollment Based Limit	Used to specify the percentage of enrollment based limit.	Yes (Conditional)
	Note: This field is enabled when you select the Percentage of Enrollment Based Limit option from ASL Limit (During Policy Period) field.	Note: This field is required when the ASL Limit (During Policy Period) is Percentage of Enrollment Based Limit .
Policy Based Limit	Used to specify the policy based limit.	Yes (Conditional)
	Note: This field is enabled when you select the Policy Based Limit option from the ASL Limit (During Policy Period) or ASL Limit (During Settlement Period) field.	Note: This field is required when the ASL Limit (During Policy Period) or ASL Limit (During Settlement Period) is Policy Based Limit .

2. Enter the required details in the **Accumulation Parameters** section.
3. Click **Save**.

The accumulation parameters are defined in the aggregated stop-loss pricing rule.

Related Topics

For more information on...	See...
How to define an aggregated stop-loss pricing rule for a parent customer	Defining an Aggregate Stop-Loss Pricing Rule for a Parent Customer on page 2643
How to edit an aggregated stop-loss pricing rule of a parent customer	Editing an Aggregate Stop-Loss Pricing Rule of a Bill Group on page 2665

Defining Run-in Parameters in an Aggregate Stop-Loss Pricing Rule**Prerequisites**

To define run-in parameters in an aggregate stop-loss pricing rule, you should have:

- Settlement days defined in the application.
- ASL limit during the policy period defined in the application.
- ASL limit during the settlement period defined in the application.

Procedure

To define run-in parameters in an aggregate stop-loss pricing rule:

1. Ensure that the **Run-In Parameters** section is expanded when you have selected an option from the **Price Item** field of **Main** section while defining an aggregate stop-loss pricing rule.

The **Run-In Parameters** section contains the following fields:

Field Name	Field Description	Mandatory (Yes or No)
Run-In	Used to specify whether the run-in parameters of the run-in period of policy are to be considered or not in an aggregate stop-loss pricing	No
Accumulation Group ID	Displays blank column, accumulation group ID is generated when accumulation parameter values are defined for an aggregate stop-loss.	Not applicable
Incurred Start Date	Used to specify the incurred start date based on the run-in period of the policy in the aggregate stop-loss.	Yes
	Note: This field is enabled when you select the checkbox for the Run-In field.	
Incurred End Date	Used to specify the incurred end date based on the run-in period of the policy in the aggregate stop-loss.	Yes
	Note: This field is enabled when you select the checkbox for the Run-In field.	

Field Name	Field Description	Mandatory (Yes or No)
Paid Start Date	Used to specify the paid start date based on the run-in period of the policy in the aggregate stop-loss.	Yes
	Note: This field is enabled when you select the checkbox for the Run-In field.	
Paid End Date	Used to specify the paid end date based on the run-in period of the policy in the aggregate stop-loss.	Yes
	Note: This field is enabled when you select the checkbox for the Run-In field.	
Run-In Maximum Limit	Used to specify the maximum limit of the run-in parameters.	Yes
	Note: This field is enabled when you select the checkbox for the Run-In field.	

- Enter the required details in the **Run-In Parameters** section.
- Click **Save**.

The run-in parameters are defined in the aggregate stop-loss pricing rule.

Related Topics

For more information on...	See...
How to define an aggregate stop-loss pricing rule for a parent customer	Defining an Aggregate Stop-Loss Pricing Rule for a Parent Customer on page 2643
How to edit an aggregate stop-loss pricing rule of a parent customer	Editing an Aggregate Stop-Loss Pricing Rule of a Parent Customer on page 2651

Defining a Characteristic for an Aggregate Stop-Loss Pricing Rule

Prerequisites

To define a characteristic for an aggregate stop-loss pricing rule, you should have:

- Characteristic types defined in the application (where the characteristic entity is set to **Pricing Rule**)

Procedure

To define a characteristic for an aggregate stop-loss pricing rule:

- Ensure that the **Characteristics** section is expanded when you are defining or editing a pricing rule.

The **Characteristics** section contains the following columns in a grid:

Column Name	Column Description	Mandatory (Yes or No)
Effective Date	Used to specify the date from when the characteristic is effective for the aggregate stop-loss pricing rule.	Yes (Conditional)
		Note: This field is required when you are defining a characteristic for the aggregate stop-loss pricing rule.

Column Name	Column Description	Mandatory (Yes or No)
Characteristic Type	Used to indicate the characteristic type.	Yes (Conditional)
	Note: The list includes only those characteristic types where the characteristic entity is set to Pricing Rule .	Note: This field is required when you are defining a characteristic for the aggregate stop-loss pricing rule.
Characteristic Value	Used to specify the value for the characteristic type.	Yes (Conditional)
	<p>Note:</p> <p>If you select a predefined characteristic type, the Search (🔍) icon appears corresponding to the Characteristic Value field. On clicking the Search icon, the Predefined Characteristic Search window appears.</p> <p>On specifying the value for a predefined characteristic type, the description of the characteristic value appears corresponding to the Characteristic Value field.</p>	Note: This field is required when you are defining a characteristic for the aggregate stop-loss pricing rule.

- Enter the required details in the **Characteristics** section.
- If you want to define more than one characteristic for the aggregate stop-loss pricing rule, click the **Add** (+) icon and then repeat step 2.

Note: However, if you want to remove a characteristic from the aggregate stop-loss pricing rule, click the **Delete** (🗑️) icon corresponding to the characteristic.

- Click **Save**.

The characteristics are defined for the aggregate stop-loss pricing rule.

Related Topics

For more information on...	See...
How to define an aggregate stop-loss pricing rule for a parent customer	Defining an Aggregate Stop-Loss Pricing Rule for a Parent Customer on page 2643
How to edit the aggregate stop-loss pricing rule for a parent customer	Editing an Aggregate Stop-Loss Pricing Rule of a Parent Customer on page 2651

Editing an Aggregate Stop-Loss Pricing Rule of a Parent Customer

Prerequisites

To edit an aggregate stop-loss pricing rule of a parent customer, you should have:

- Business Object **C1-PricingRuleASL** defined for aggregate stop-loss pricing rule.
- SSL accumulation level defined in the application.
- Underwriter review defined in the application.

Procedure

To edit an aggregate stop-loss pricing rule of a parent customer:

1. Search for the account, person, or policy whose pricing details you want to view in the **Customer 360° View** screen.
2. In the **Search Results** section, click the **View** (🔗) icon corresponding to the account, person, or policy whose pricing details you want to view.

The **Account, Person, or Policy** tab in the **Customer 360° Information** screen appears.

3. Click the **Pricing** tab, in the **Parent Customer Pricing Rules** zone click the **Edit** (🔗) icon in the **Edit** column corresponding to the pricing rule type for aggregate stop-loss whose aggregate stop-loss pricing rule details you v

The **Aggregate Stop-Loss (ASL) Pricing Rule** screen appears. It contains the following sections:

- **Customer Information** – Displays the customer information.
- **Main** – Used to specify basic details about the aggregate stop-loss pricing rule.
- **Accumulation Parameters** – Used to define the accumulation parameters based on which you want to accumulate the aggregate stop-loss for the transactions which are processed in the run-in or active period of the policy.
- **Run-In Parameters** – Used to define run-in parameters in the run-in period of the policy.
- **Characteristics** – Used to define the characteristics for an aggregate stop-loss pricing rule.

The **Customer Information** section contains the following fields:

Field Name	Field Description	Mandatory (Yes or No)
Parent Customer Information	Displays the parent customer information	Not applicable
Pricing Rule Type	Indicates the pricing rule type.	Not applicable

The **Main** section contains the following fields:

Field Name	Field Description	Mandatory (Yes or No)
Price Item	Indicates the price item defined for pricing.	Not applicable
Parent Customer's SSL or ASL Pricing Rules	Indicates the pricing date range derived from the parent customer's specific stop-loss or aggregate stop-loss pricing rules.	Not applicable
Pricing Start Date	Displays the pricing rule start date.	Not applicable
Pricing End Date	Displays the pricing rule end date.	Not applicable
Rate Option	Indicates the rate option used for defining the aggregate stop-loss pricing rule for the price item.	Not applicable

Field Name	Field Description	Mandatory (Yes or No)
Settlement Frequency	<p>Indicates the settlement frequency to determine the bill after date. The valid values are:</p> <ul style="list-style-type: none"> • Immediately – The bill after date is not calculated. The aggregate stop-loss billable charge is billed immediately in the next cycle. • Manually (At Required Intervals) – The bill after date specified in the Manual Settlement Bill After Date parameter while executing the C1-BCASL batch is stamped on the aggregate stop-loss billable charge. • Monthly – The bill after date specified in the Manual Settlement Date parameter while executing the C1-BCASL batch is stamped on the aggregate stop-loss billable charge. • Yearly – The bill after date in the aggregate stop-loss billable charge is set to the pricing end date. 	Yes
Underwriter Review	<p>Used to indicate whether the underwriter settlement review flag is on or off. The valid values are:</p> <ul style="list-style-type: none"> • Yes • No 	Yes

4. Modify the details in the **Main** section, if required.
5. Modify the accumulation parameters in an aggregate stop-loss pricing rule, if required.
6. Modify the run-in parameters in an aggregate stop-loss pricing rule, if required.
7. Add, edit, or remove characteristics for the aggregate stop-loss pricing rule, if required.
8. Click **Save**.

The changes made to an aggregate stop-loss pricing rule for a parent customer are saved.

Related Topics

For more information on...	See...
Customer 360° Information – Pricing tab	Customer 360° Information - Pricing Information on page 693
Parent Customer Pricing Rules zone	Parent Customer Pricing Rules on page 696
How to define accumulation parameters in an aggregate stop-loss pricing rule	Defining Accumulation Parameters in an Aggregate Stop-Loss Pricing Rule on page 2646
How to define run-in parameters in an aggregate stop-loss pricing rule	Defining Run-in Parameters in an Aggregate Stop-Loss Pricing Rule on page 2649
How to define a characteristic for an aggregate stop-loss pricing rule	Defining a Characteristic for an Aggregate Stop-Loss Pricing Rule on page 2650

Viewing an Aggregate Stop-Loss Pricing Rule of a Parent Customer

Procedure

To view an aggregate stop-loss pricing rule of a parent customer:

1. Search for the account, person, or policy whose pricing details you want to view in the **Customer 360° View** screen.
2. In the **Search Results** section, click the **View** () icon corresponding to the account, person, or policy whose pricing details you want to view.
The **Account, Person, or Policy** tab in the **Customer 360° Information** screen appears.
3. Click the **Pricing** tab.
4. In the **Parent Customer Pricing Rules** zone, click the link in the **Pricing Rule Information** column corresponding to the aggregate stop-loss pricing rule type whose aggregate stop-loss pricing rule parent customer details you want to view.

The **Pricing Rule** screen appears. It contains the following zone:

- **Aggregate Stop-Loss** – Displays the pricing rule aggregate stop-loss details for a parent customer. It contains the following sections:
 - **Main** – Displays the basic details of the aggregate stop-loss pricing rule.
 - **Accumulation Parameters** – Displays the accumulation parameters based on which accumulated aggregate stop-loss for the transactions are processed in the run-in or active period of the policy.
 - **Run-In Parameters** – Displays the run-in parameters in the run-in period of the policy.
 - **Characteristics** – Displays the characteristics defined for the aggregate stop-loss pricing rule.
5. View the basic details of aggregate stop-loss pricing rule in the **Main** zone.
 6. View the accumulated parameters in the **Accumulation Parameters** zone.
 7. View the run-in parameters in the **Run-In Parameters** zone.
 8. View the characteristics of the aggregate stop-loss pricing rule in the **Characteristics** zone.

Related Topics

For more information on...	See...
Customer 360° Information – Pricing tab	Customer 360° Information - Pricing Information on page 693
Parent Customer Pricing Rules zone	Parent Customer Pricing Rules on page 696
Pricing Rule screen	Pricing Rule (Used for Viewing) on page 2902
Aggregate Stop-Loss zone	Aggregate Stop-Loss on page 2906

Deleting an Aggregate Stop-Loss Pricing Rule of a Parent Customer

Procedure

To delete an aggregate stop-loss pricing rule of a parent customer:

1. Search for the account, person, or policy whose pricing details you want to view in the **Customer 360° View** screen.
2. In the **Search Results** section, click the **View** () icon corresponding to the account, person, or policy whose pricing details you want to view.

The **Account**, **Person**, or **Policy** tab in the **Customer 360° Information** screen appears.

3. Click the **Pricing** tab, in the **Parent Customer Pricing Rules** zone, click the **Delete** (🗑️) icon in the **Delete** column corresponding to the aggregate stop-loss pricing rule type whose aggregate stop-loss pricing rule you want to delete.
A message appears confirming whether you want to delete the aggregate stop-loss pricing rule.
4. Click **OK**.

The aggregate stop-loss pricing rule is deleted.

Related Topics

For more information on...	See...
Customer 360° Information – Pricing tab	Customer 360° Information - Pricing Information on page 693
Parent Customer Pricing Rules zone	Parent Customer Pricing Rules on page 696

Defining an Aggregate Stop-Loss Pricing Rule for a Bill Group

Prerequisites

To define an aggregate stop-loss pricing rule for a bill group, you should have:

- Business Object **C1-PricingRule** defined for pricing rule.
- Business Object **C1-PricingRuleASL** defined for aggregate stop-loss pricing rule.
- Pricing rule type defined in the application.
- Policy status defined in the application.
- Price item defined in the application.
- Rate option defined in the application.

Procedure

To define an aggregate stop-loss pricing rule for a bill group:

1. Search for the account, person, or policy whose pricing details you want to view in the **Customer 360° View** screen.
2. In the **Search Results** section, click the **View** (🔗) icon corresponding to the account, person, or policy whose pricing details you want to view.

The **Account**, **Person**, or **Policy** tab in the **Customer 360° Information** screen appears.

3. Click the **Pricing** tab and then click the **Add** link in the upper right corner of the **Bill Group ASO Policy Pricing Rules** zone.

The **Pricing Rule** screen appears. It contains the following fields:

Field Name	Field Description	Mandatory (Yes or No)
Person Name	Displays the person name.	Not applicable
Person Type	Displays the person type.	Not applicable
Pricing Rule Type	Used to indicate the pricing rule type to create the pricing rule. Note: You can create an aggregate stop-loss pricing rule using the Pricing Rule Type for aggregate stop-loss.	Yes

Field Name	Field Description	Mandatory (Yes or No)
Pricing Group	Used to indicate the pricing group.	No
Policy Status	Used to indicate the policy status for pricing rule. The valid values are: <ul style="list-style-type: none"> In Force/Active Post Runout Runout 	Yes
	Note: Aggregate stop-loss pricing rule cannot be created for Runout or Post Runout policy status where the policy run out end date is missing.	

4. Click OK.

The **Aggregate Stop-Loss (ASL) Pricing Rule** screen appears. It contains the following sections:

- **Customer Information** – Displays the customer information for bill group.
- **Main** – Used to specify basic details about the aggregate stop-loss pricing rule.
- **Accumulation Criteria** – Used to define the accumulation criteria in an aggregate stop-loss pricing rule.
- **Pricing Information** – Used to define stop-loss eligibility for claim line items.
- **Characteristics** – Used to define the characteristics for the aggregate stop-loss pricing rule.

The **Customer Information** section contains the following fields:

Field Name	Field Description	Mandatory (Yes or No)
Bill Group Information	Displays the bill group information.	Not applicable
Policy Start Date	Displays the policy start date.	Not applicable
Policy End Date	Displays the policy end date.	Not applicable
Policy Status	Indicates the policy status for pricing rule. The valid values are: <ul style="list-style-type: none"> In Force/Active Post Runout Runout 	Not applicable
Pricing Rule Type	Indicates the pricing rule type.	Not applicable

The **Main** section contains the following fields:

Field Name	Field Description	Mandatory (Yes or No)
Price Item	Used to indicate the price item.	Yes
	Note: Once an option is selected for this field, the field appears disabled.	

Field Name	Field Description	Mandatory (Yes or No)
Parent Customer's SSL or ASL Pricing Rules	Used to indicate the pricing date range derived from the parent customer's specific stop-loss or aggregate stop-loss pricing rule.	Yes
	Note: This field is enabled for selection when an option from Price Item field is selected.	
Pricing Start Date	Displays the pricing rule start date.	Not applicable
	Note: This field displays the Policy Start Date .	
Pricing End Date	Displays the pricing rule end date.	Not applicable
	Note: This field displays the Policy End Date .	
Rate Option	Used to indicate the rate option to define the aggregate stop-loss pricing rule for the price item.	Yes
	Note: Rate options in this field appears for selection, when you select an option from the Price Item field.	

- Enter the required details in the **Main** section.
- Define accumulation criteria in an aggregate stop-loss pricing rule, if required.

Note:
The **Accumulation Criteria** section appears when an option from **Parent Customer's SSL or ASL Pricing Rules** field is selected.
You can also define the **Accumulation Criteria** for each rule in an aggregate stop-loss pricing rule.

- Define stop-loss eligibility for claim line items, if required.

Note:
The **Pricing Information** section appears when an option from **Parent Customer's SSL or ASL Pricing Rules** field is selected.
You can also define the **Pricing Information** for each rule in an aggregate stop-loss pricing rule.

- Define characteristics for an aggregate stop-loss pricing rule, if required.
- Click **Save**.

The aggregate stop-loss pricing rule for a bill group is defined.

Note: A price list and price assignment is created, the price list created is assigned to the aggregate stop-loss pricing rule.

Related Topics

For more information on...	See...
Customer 360° Information – Pricing tab	Customer 360° Information - Pricing Information on page 693

For more information on...	See...
Bill Group ASO Policy Pricing Rules zone	<i>Bill Group Self-Funded Policy Pricing Rules</i> on page 702
How to define accumulation criteria in an aggregate stop-loss pricing rule	<i>Defining Accumulation Criteria in an Aggregate Stop-Loss Pricing Rule</i> on page 2658
How to define stop-loss eligibility for claim line items	<i>Defining Claim Pricing Rules in an Aggregate Stop-Loss Pricing Rule</i> on page 2660
How to define a characteristic for an aggregate stop-loss pricing rule	<i>Defining a Characteristic for an Aggregate Stop-Loss Pricing Rule</i> on page 2650

Defining Accumulation Criteria in an Aggregate Stop-Loss Pricing Rule

Procedure

To define accumulation criteria in an aggregate stop-loss pricing rule:

1. Ensure that the **Accumulation Criteria** section is expanded when you have selected an option from the **Parent Customer's SSL or ASL Pricing Rules** field of **Main** section while defining or editing an aggregate stop-loss pricing rule.

The **Accumulation Criteria** section contains the following fields:

Field Name	Field Description	Mandatory (Yes or No)
Accumulation Group ID	Displays blank field, accumulation group ID is generated when accumulation criteria values are defined for an aggregate stop-loss.	Not applicable
Price Item	Used to specify the price item information. Note: On clicking the Search (🔍) icon that appears corresponding to the Price Item field, the Price Item Search window appears.	No

Field Name	Field Description	Mandatory (Yes or No)									
Price Item Parameters	This field contains the following columns:	No									
	<table border="1"> <thead> <tr> <th>Column Name</th> <th>Column Description</th> <th>Mandatory (Yes or No)</th> </tr> </thead> <tbody> <tr> <td>Price Item Parameter</td> <td>Used to specify multiple parameters based on which you want to determine the price item utilization. Note: On clicking the Search (🔍) icon that appears corresponding to the Price Item Parameter field, the Price Item Parameter Search window appears.</td> <td>No</td> </tr> <tr> <td>Parameter Value</td> <td>Used to specify the value of the parameter. Note: On selecting the Price Item Parameter, the Search (🔍) icon appears corresponding to this field, and on clicking the icon, the Parameter Value Search window appears.</td> <td>No</td> </tr> </tbody> </table>		Column Name	Column Description	Mandatory (Yes or No)	Price Item Parameter	Used to specify multiple parameters based on which you want to determine the price item utilization. Note: On clicking the Search (🔍) icon that appears corresponding to the Price Item Parameter field, the Price Item Parameter Search window appears.	No	Parameter Value	Used to specify the value of the parameter. Note: On selecting the Price Item Parameter , the Search (🔍) icon appears corresponding to this field, and on clicking the icon, the Parameter Value Search window appears.	No
	Column Name		Column Description	Mandatory (Yes or No)							
Price Item Parameter	Used to specify multiple parameters based on which you want to determine the price item utilization. Note: On clicking the Search (🔍) icon that appears corresponding to the Price Item Parameter field, the Price Item Parameter Search window appears.	No									
Parameter Value	Used to specify the value of the parameter. Note: On selecting the Price Item Parameter , the Search (🔍) icon appears corresponding to this field, and on clicking the icon, the Parameter Value Search window appears.	No									

2. Enter the required details in the **Accumulation Criteria** section.
3. If you want to define more than one price item in the accumulation group, click the **Add** (+) icon and then repeat step 2.

Note: However, if you want to remove a price item from the accumulation group, click the **Delete** (🗑️) icon corresponding to the price item.

4. If you want to define more than one price item parameters for the price item, click the **Add** (+) icon and then repeat step 2.

Note: However, if you want to remove a price item parameter from the price item, click the **Delete** (🗑️) icon corresponding to the price item parameter.

5. Click **Save**.

The accumulation criteria is defined in the aggregate stop-loss pricing rule.

6. You can define accumulation rules for each rule in an aggregate stop-loss pricing rule.

Note: You can exclude a rule from the aggregate stop-loss pricing by selecting the **Exclude Rule** checkbox.

Related Topics

For more information on...	See...
How to define an aggregate stop-loss pricing rule for a bill group	Defining an Aggregate Stop-Loss Pricing Rule for a Bill Group on page 2655
How to edit an aggregate stop-loss pricing rule of a bill group	Editing an Aggregate Stop-Loss Pricing Rule of a Bill Group on page 2665

Defining Claim Pricing Rules in an Aggregate Stop-Loss Pricing Rule

Procedure

To define claim pricing rules in an aggregate stop-loss pricing rule:

1. Ensure that the **Pricing Information** section is expanded when you have selected an option from the **Parent Customer's SSL or ASL Pricing Rules** field of **Main** section while defining or editing an aggregate stop-loss pricing rule.

The **Pricing Information** section contains the following section:

- **Claim Pricing Rule** – Used to indicate the claim pricing rule. It contains the following sub-sections:
 - **Domestic Provider Claims** – Used to specify the domestic provider claim while calculating aggregate stop-loss.
 - **Markup or Markdown Values** – Used to define the markup or markdown values for billable charge line.
 - **Line Items** – Used to associate line items eligible for billing.

The **Claim Pricing Rule** section contains the following field:

Field Name	Field Description	Mandatory (Yes or No)
Effective Claim Pricing Rule	Used to indicate the claim pricing rule effective for pricing.	No

On clicking the **Reapply Claim Template** button to the right side of the **Effective Claim Pricing Rule** field you can reapply for claim pricing rule.

Note: The **Reapply Claim Template** button appears when you are editing an aggregate stop-loss.

The **Domestic Provider Claims** section contains the following field:

Field Name	Field Description	Mandatory (Yes or No)
Exclude ASL (Percentage)	Used to specify the domestic provider claim billable charge line excluding the aggregate stop-loss in percentage to create domestic provider claim calculation lines.	No

The **Markup or Markdown Values** section contains the following fields:

Field Name	Field Description	Mandatory (Yes or No)
Pricing Strategy	Indicates the pricing strategy. The valid values are: <ul style="list-style-type: none"> • Markdown • Markup • None 	Not applicable
Markup or Markdown Type	Indicates the markup or markdown value type for claim line items. The valid values are: <ul style="list-style-type: none"> • Flat Amount • Percentage 	Not applicable
Markup or Markdown Amount	Displays the markup or markdown amount. Note: This field displays amount when Markup or Markdown Type field is Flat Amount .	Not applicable

The **Line Items** section contains the following fields:

Field Name	Field Description	Mandatory (Yes or No)
Sequence	Displays the sequence number for the line items.	Not applicable
Line Item	Displays the billing line items.	Not applicable
Eligible for Specific Stop-Loss	Used to specify whether the line item is eligible or not eligible for aggregate stop-loss.	No
Markup or Markdown Percentage Eligibility	Displays whether the line item is eligible or not eligible for markup or markdown percentage. The valid values are: <ul style="list-style-type: none"> • Eligible • Not Eligible 	Not applicable
Markup or Markdown Percentage	Displays the percentage for markup or markdown value.	Not applicable

2. Select the required details in the **Claim Pricing Rule** section, if required.
3. Enter the required details in the **Domestic Provider Claims** section, if required.
4. Select the required details in the **Line Items** section, if required.

5. Click **Save**.

The claim line items are defined in the aggregate stop-loss pricing rule.

6. You can define eligibility claim line items for each rule in an aggregate stop-loss pricing rule.

Note: You can exclude a rule from the aggregate stop-loss pricing by selecting the **Exclude Rule** checkbox.

Related Topics

For more information on...	See...
How to define an aggregate stop-loss pricing rule for a bill group	Defining an Aggregate Stop-Loss Pricing Rule for a Bill Group on page 2655
How to edit an aggregate stop-loss pricing rule of a bill group	Editing an Aggregate Stop-Loss Pricing Rule of a Bill Group on page 2665

Defining an Aggregate Stop-Loss Pricing Rule for a Bill Group Using a Pricing Group**Prerequisites**

To define an aggregate stop-loss pricing rule for a bill group using a pricing group, you should have:

- Business Object **C1-PricingRule** defined for pricing rule.
- Business Object **C1-PricingRuleASL** defined for aggregate stop-loss pricing rule.
- Pricing rule type defined in the application.
- Pricing group defined in the application.
- Policy status defined in the application.
- Price item defined in the application.
- Rate option defined in the application.

Procedure

To define an aggregate stop-loss pricing rule for a bill group using a pricing group:

1. Search for the account, person, or policy whose pricing details you want to view in the **Customer 360° View** screen.
2. In the **Search Results** section, click the **View** (🔗) icon corresponding to the account, person, or policy whose pricing details you want to view.

The **Account**, **Person**, or **Policy** tab in the **Customer 360° Information** screen appears.

3. Click the **Pricing** tab and then click the **Add** link in the upper right corner of the **Bill Group ASO Policy Pricing Rules** zone.

The **Pricing Rule** screen appears. It contains the following fields:

Field Name	Field Description	Mandatory (Yes or No)
Person Name	Displays the person name.	Not applicable
Person Type	Displays the person type.	Not applicable

Field Name	Field Description	Mandatory (Yes or No)
Pricing Rule Type	Used to indicate the pricing rule type to create the pricing rule.	Yes
	Note: You can create an aggregate stop-loss pricing rule using the Pricing Rule Type for aggregate stop-loss.	
Pricing Group	Used to indicate the pricing group.	Yes
Policy Status	Used to indicate the policy status for pricing rule. The valid values are: <ul style="list-style-type: none"> • In Force/Active • Post Runout • Runout 	Yes
	Note: Aggregate stop-loss pricing rule cannot be created for Runout or Post Runout policy status where the policy run out End Date is missing.	

4. Click **OK**.

The **Aggregate Stop-Loss (ASL) Pricing Rule** screen appears. It contains the following sections:

- **Customer Information** – Displays the customer information for bill group using pricing group.
- **Main** – Used to specify basic details about the claim pricing rule.
- **Markup or Markdown Values** – Used to define the markup or markdown values for billable charge line for each rule.
- **Line Items** – Used to associate line items eligible for billing for each rule.
- **Characteristics** – Used to define the characteristics for the claim pricing rule.

The **Customer Information** section contains the following fields:

Field Name	Field Description	Mandatory (Yes or No)
Bill Group Information	Displays the bill group information.	Not applicable
Policy Start Date	Displays the policy start date.	Not applicable
Policy End Date	Displays the policy end date.	Not applicable
Policy Status	Indicates the policy status for pricing rule. The valid values are: <ul style="list-style-type: none"> • In Force/Active • Post Runout • Runout 	Not applicable
Pricing Group	Displays the pricing group.	Not applicable
Pricing Rule Type	Indicates the pricing rule type.	Not applicable

The **Main** section contains the following fields:

Field Name	Field Description	Mandatory (Yes or No)
Price Item	Used to indicate the price item.	Yes
	Note: Once an option is selected for this field, the field appears disabled.	
Parent Customer's SSL or ASL Pricing Rules	Used to indicate the pricing date range derived from the parent customer's specific stop-loss or aggregate stop-loss pricing rule.	Yes
	Note: This field is enabled for selection when an option from Price Item field is selected.	
Pricing Start Date	Displays the pricing rule start date.	Yes
Pricing End Date	Displays the pricing rule end date.	Yes
Rate Option	Used to indicate the rate option to define the aggregate stop-loss pricing rule for the price item.	Yes
	Note: Rate options in this field appears for selection, when you select an option from the Price Item field.	

5. Enter the required details in the **Main** section.
6. Define accumulation criteria for each rule in an aggregate stop-loss pricing rule pricing rule, if required.

Note: The **Accumulation Criteria** section appears in the rule section and the rule section appears when an option from **Parent Customer's SSL or ASL Pricing Rules** field is selected.

7. Define stop-loss eligibility for claim line items, if required.

Note: The **Pricing Information** section appears in the rule section and the rule section appears when an option from **Parent Customer's SSL or ASL Pricing Rules** field is selected.

8. Define characteristics for an aggregate stop-loss pricing rule, if required.
9. Click **Save**.

The aggregate stop-loss pricing rule for a bill group using a pricing group is defined.

Note: A price list and price assignment is created, the price list created is assigned to the aggregate stop-loss pricing rule.

Related Topics

For more information on...	See...
Customer 360° Information – Pricing tab	Customer 360° Information - Pricing Information on page 693
Bill Group ASO Policy Pricing Rules zone	Bill Group Self-Funded Policy Pricing Rules on page 702
How to define Accumulation Criteria in an aggregate stop-loss pricing rule	Defining Accumulation Criteria in an Aggregate Stop-Loss Pricing Rule on page 2658

For more information on...	See...
How to define stop-loss eligibility for claim line items	Defining Claim Pricing Rules in an Aggregate Stop-Loss Pricing Rule on page 2660
How to define a characteristic for an aggregate stop-loss pricing rule	Defining a Characteristic for an Aggregate Stop-Loss Pricing Rule on page 2650

Editing an Aggregate Stop-Loss Pricing Rule of a Bill Group

Prerequisites

To edit an aggregate stop-loss pricing rule of a bill group, you should have:

- Business Object **C1-PricingRuleASL** defined for aggregate stop-loss pricing rule.

Procedure

To edit an aggregate stop-loss pricing rule of a bill group:

1. Search for the account, person, or policy whose pricing details you want to view in the **Customer 360° View** screen.
2. In the **Search Results** section, click the **View** (🔗) icon corresponding to the account, person, or policy whose pricing details you want to view. The **Account, Person, or Policy** tab in the **Customer 360° Information** screen appears.
3. Click the **Pricing** tab, in the **Bill Group ASO Policy Pricing Rules** zone click the **Edit** (✎) icon in the **Edit** column corresponding to the pricing rule type for aggregate stop-loss whose aggregate stop-loss pricing rule details you want to view.

The **Aggregate Stop-Loss (ASL) Pricing Rule** screen appears. It contains the following sections:

- **Customer Information** – Displays the customer information for bill group.
- **Main** – Displays the basic details of the aggregate stop-loss pricing rule.
- **Accumulation Criteria** – Used to define the accumulation criteria in an aggregate stop-loss pricing rule.
- **Pricing Information** – Used to define stop-loss eligibility for claim line items.
- **Characteristics** – Used to define the characteristics for the aggregate stop-loss pricing rule.

The **Customer Information** section contains the following fields:

Field Name	Field Description	Mandatory (Yes or No)
Bill Group Information	Displays the bill group information.	Not applicable
Policy Start Date	Displays the policy start date.	Not applicable
Policy End Date	Displays the policy end date.	Not applicable
Policy Status	Indicates the policy status for pricing rule. The valid values are: <ul style="list-style-type: none"> • In Force/Active • Post Runout • Runout 	Not applicable
Pricing Rule Type	Indicates the pricing rule type.	Not applicable

The **Main** section contains the following fields:

Field Name	Field Description	Mandatory (Yes or No)
Price Item	Indicates the price item.	Not applicable
Parent Customer's SSL or ASL Pricing Rules	Indicates the pricing date range derived from the parent customer's specific stop-loss or aggregate stop-loss pricing rule.	Not applicable
Pricing Start Date	Displays the pricing rule start date.	Not applicable
Pricing End Date	Displays the pricing rule end date.	Not applicable
Rate Option	Indicates the rate option of the aggregate stop-loss pricing rule for the price item.	Not applicable

- Modify the accumulation criteria in an aggregate stop-loss pricing rule, if required.

Note: You can add, edit, or remove price item and its price item parameters in the accumulation criteria for an aggregate stop-loss, if required.

- Modify the stop-loss eligibility for claim line items, if required.

Note: This section also consists of a button, **Reapply Claim Template**, on clicking the button a message occurs indicating that updating the claim template will reset all the default fields on the claim pricing rule.

- Add, edit, or remove characteristics for an aggregate stop-loss pricing rule, if required.
- Click **Save**.

The changes made to an aggregate stop-loss pricing rule for a bill group are saved.

Related Topics

For more information on...	See...
Customer 360° Information – Pricing tab	Customer 360° Information - Pricing Information on page 693
Bill Group ASO Policy Pricing Rules zone	Bill Group Self-Funded Policy Pricing Rules on page 702
How to define accumulation criteria in an aggregate stop-loss pricing rule	Defining Accumulation Criteria in an Aggregate Stop-Loss Pricing Rule on page 2658
How to define stop-loss eligibility for claim line items	Defining Claim Pricing Rules in an Aggregate Stop-Loss Pricing Rule on page 2660
How to define a characteristic for an aggregate stop-loss pricing rule	Defining a Characteristic for an Aggregate Stop-Loss Pricing Rule on page 2650

Viewing an Aggregate Stop-Loss Pricing Rule of a Bill Group

Procedure

To view an aggregate stop-loss pricing rule of a bill group:

- Search for the account, person, or policy whose pricing details you want to view in the **Customer 360° View** screen.
- In the **Search Results** section, click the **View** () icon corresponding to the account, person, or policy whose pricing details you want to view.

The **Account**, **Person**, or **Policy** tab in the **Customer 360° Information** screen appears.

- Click the **Pricing** tab.

4. In the **Bill Group ASO Policy Information** zone, click the **Broadcast** (📡) icon corresponding to the bill group whose aggregate stop-loss pricing rule bill group details you want to view.
5. In the **Bill Group ASO Policy Pricing Rules** zone, click the link in the **Pricing Rule Information** column corresponding to the aggregate stop-loss pricing rule type whose aggregate stop-loss pricing rule bill group you want to view.

The **Pricing Rule** screen appears. It contains the following zone:

- **Aggregate Stop-Loss** – Displays the pricing rule aggregate stop-loss details for a bill group. It contains the following sections:
 - **Main** – Displays the basic details of the aggregate stop-loss pricing rule.
 - **Accumulation Criteria** – Displays the accumulation criteria in an aggregate stop-loss pricing rule.
 - **Pricing Information** – Displays the stop-loss eligibility for claim line items.
 - **Characteristics** – Displays the characteristics defined for the aggregate stop-loss pricing rule.
6. View the basic details of aggregate stop-loss pricing rule in the **Main** section.
 7. View the accumulated criteria in the **Accumulation Criteria** section.
 8. View the stop-loss eligibility for claim line items in the **Pricing Information** section.
 9. View the characteristics of the aggregate stop-loss pricing rule in the **Characteristics** section.

Related Topics

For more information on...	See...
Customer 360° Information – Pricing tab	Customer 360° Information - Pricing Information on page 693
Bill Group ASO Policy Pricing Rules zone	Bill Group Self-Funded Policy Pricing Rules on page 702
Pricing Rule screen	Pricing Rule (Used for Viewing) on page 2902
Aggregate Stop-Loss zone	Aggregate Stop-Loss on page 2906

Deleting an Aggregate Stop-Loss Pricing Rule of a Bill Group

Procedure

To delete an aggregate stop-loss pricing rule of a bill group:

1. Search for the account, person, or policy whose pricing details you want to view in the **Customer 360° View** screen.
2. In the **Search Results** section, click the **View** (🔍) icon corresponding to the account, person, or policy whose pricing details you want to view.
The **Account, Person, or Policy** tab in the **Customer 360° Information** screen appears.
3. Click the **Pricing** tab, in the **Bill Group ASO Policy Pricing Rules** zone, click the **Delete** (🗑️) icon in the **Delete** column corresponding to the aggregate stop-loss pricing rule type whose aggregate stop-loss pricing rule you want to delete.
A message appears confirming whether you want to delete the aggregate stop-loss pricing rule.
4. Click **OK**.
The aggregate stop-loss pricing rule is deleted.

Related Topics

For more information on...	See...
Customer 360° Information – Pricing tab	Customer 360° Information - Pricing Information on page 693
Bill Group ASO Policy Pricing Rules zone	Bill Group Self-Funded Policy Pricing Rules on page 702

Retention Type Claim Based Pricing

The ASO service provider provides claim administrative services and pays the claim amount on behalf of the employer. Different charges, such as administration fees, network fees, managed care fees, are typically charged as retention type claim based fees. The system enables you to charge a flat or percentage based retention type claim based fee. The rate schedule defined in the respective rate option indicates whether the retention type claim based fee is a flat fee or percentage based fee. The system considers the claim line items for calculating the percentage based retention type claim based fee when the **Retention Claim Based Percentage Calculation** field is set to **Yes**.

You can define a retention type claim based pricing rule at the parent customer and bill group levels. The retention type claim based pricing rule at the bill group level takes precedence over the retention type claim based pricing rule at the parent customer level. You can define retention type claim based pricing rules for parent customers and bill groups from the **Customer 360° Information** screen. You can define a retention type claim based pricing rule using a retention type claim based pricing rule type. It is the retention type claim based pricing rule type which helps the system to determine:

- Business object using which the retention type claim based pricing rule should be created in the system.
- Algorithm which should be triggered while validating a transaction.

Note: An algorithm type for validating a transaction is not shipped from the product. You need to create a custom algorithm type, if required.

- Algorithms which should be triggered while deriving account and price item for a transaction.

Note: You must create an algorithm using the **C1_ACCPRIDRV** algorithm type and attach it to the **Account and Price Item Derivation** system event. The **C1_BAFTDRV** algorithm sets the bill after date to the end date of the aggregation schedule which is specified in the respective rate option. For example, if the aggregation schedule is monthly, the bill after date is set to the last day of the month.

- Algorithm which should be triggered while determining the bill after date.

Note: You must create an algorithm using the **C1_BAFTDRV** algorithm type and attach it to the **Bill After Date Determination** system event.

- Post-processing algorithm which should be triggered once the claim pricing rule is derived.

Note: A post-processing algorithm type is not shipped from the product. You need to create a custom algorithm type, if required.

- Price items for which you can define retention type claim based pricing rules using the retention type claim based pricing rule type.
- Rate options that you can use while defining the pricing for a price item.
- Different type of account to which the price item should be billed based on the specified priority.
- Price item parameters which you can use while defining retention type claim based pricing rules.
- Additional information, such as:
 - Whether the price items included in the retention type claim based pricing rule type are used while accumulating specific stop-loss and aggregate stop-loss.
 - Identifiers which help to determine whether the claim transaction is received during the run-in period of the policy.

- Indicates how the claim must be disposed. If the **Claim Disposition** field in the transaction is set to Yes, you must set the disposition mode to **Align Signage**. However, if the **Claim Disposition** field in the transaction is set to **No**, you must set the disposition mode to **Zero Out**.

Note: If the **Disposition Mode** field is set to **Align Signage**, the claim based fees is positive for positive claims and the claim based fees is negative for negative claims. However, if the **Disposition Mode** field is set to **Zero Out**, the claim based fees for the negative claims is set to zero (0).

Once a retention type claim based pricing rule type is defined, you can create retention type claim based pricing rules using the retention type claim based pricing rule type. While defining a retention type claim based pricing rule for a parent customer and bill group, you need to specify the following:

- Price item for which you want to define the pricing.
- Pricing date range during which the pricing is effective.
- Rate option which you want to use while defining the retention type claim based pricing.
- Price item parameters based on which you want to define the pricing.

Note: You can only use those price item parameters which are included in the respective retention type claim based pricing rule type.

- Flat or percentage based fee which you want to charge for a price item and price item parameters combination.

In addition, while defining a retention type claim based pricing rule for a bill group, you need to specify the status of the policy for which you want to define the retention type claim based pricing rule. You can also specify a pricing group while defining a retention type claim based pricing rule for a bill group. If you specify a pricing group while defining a retention type claim based pricing rule for a bill group, you will have to define the following details for each rule defined in the pricing group:

- Price item parameters based on which you want to define the pricing.

Note: You can only use those price item parameters which are included in the respective retention type claim based pricing rule type.

- Flat or percentage based fee which you want to charge for a price item and price item parameters combination.

The system enables you to define different flat or percentage based fee for different set of price item parameters combination. For example, you can define one flat fee for the claim transactions where health coverage is set to Dental and submission type is set to Paper and another flat fee for the claim transactions where health coverage is set to Dental and submission type is set to Paper.

Once a retention type claim based pricing rule is defined for a parent customer and bill group, the system creates one price assignment for each set of price item parameters combination, one price list, and one price list assignment.

Defining a Retention Type Claim Based Pricing Rule Type

Prerequisites

To define a retention type claim based pricing rule type, you should have:

- Business Object **C1-PricingRuleRetTypeClaim** defined for retention type claim based pricing rule type.
- Business Object **C1-PricingRule** defined for pricing rule.
- Pricing rule type category for the retention type claim defined in the application.

Procedure

To define a retention type claim based pricing rule type:

1. Click the **Admin** link in the **Application** toolbar.

A list appears.

- From the **Admin** menu, select **P** and then click **Pricing Rule Type**.

A sub-menu appears.

- Click the **Add** option from the **Pricing Rule Type** sub-menu.

The **Select Business Object** screen appears. It contains the following field:

Field Name	Field Description	Mandatory (Yes or No)
Pricing Rule Type Business Object	Used to indicate the business object using which you want to create the retention type claim based pricing rule type Note: You can create a retention type claim based pricing rule type using the Claim Pricing Rule Type business object.	Yes

Tip: Alternatively, you can access this screen by clicking the **Add** button in the **Page Title** area of the **Pricing Rule Type** screen.

- Select the **Retention Type Claim Based Pricing Rule Type** business object.
- Click **OK**.

The **Retention Type Claim Based Pricing Rule Type** screen appears. It contains the following sections:

- Main** – Used to specify basic details about the retention type claim based pricing rule type.
- Algorithms** – Used to associate the algorithms with the retention type claim based pricing rule type.
- Additional Data** – Used to specify the additional information about the retention type claim based pricing rule type.
- Price Items** – Used to add the price items for which you can define the retention type claim based pricing rules using the retention type claim based pricing rule type.
- Price Item Parameters** – Used to add the price item parameters based on which you want to define the price item pricing.
- Characteristics** – Used to define the characteristics for the retention type claim based pricing rule type.
- Claim Disposition Details** – Used to define the disposition details of the claims transaction.

The **Main** section contains the following fields:

Field Name	Field Description	Mandatory (Yes or No)
Pricing Rule Type	Used to specify the retention type claim based pricing rule type.	Yes
Description	Used to specify the description for the retention type claim based pricing rule type.	Yes
Detailed Description	Used to specify the additional information about the retention type claim based pricing rule type.	No
Pricing Rule Business Object	Used to indicate the retention type claim based pricing rule business object. The valid value is: <ul style="list-style-type: none"> Retention Type Claim Based Pricing Rule 	Yes

Field Name	Field Description	Mandatory (Yes or No)
Business Object	Indicate the retention type claim based pricing rule type business object using which you are defining the retention type claim based pricing rule type.	Not applicable
Status	Used to indicate the status of the retention type claim based pricing rule type. The valid values are: <ul style="list-style-type: none"> Active Inactive 	Yes
Primary	Used to indicate whether the pricing rule type is a primary pricing rule type.	Not applicable
	Note: You must not select the Primary option while defining the retention type claim based pricing rule type.	
Pricing Rule Type Category	Used to indicate the category to which the pricing rule type belongs. The valid value is: <ul style="list-style-type: none"> Retention Type Claim Based 	Yes

- Enter the required details in the **Main** section.
- Ensure that **Primary** option is not selected when you are defining a retention type claim based pricing rule type.
- Associate the following algorithms with the retention type claim based pricing rule type:

System Event	Algorithm	Algorithm Type	Description
Pricing Rule Post Processing	C1-PRCRETPOS	C1-PRCRETPOS	Retention Claim Based - Post Processing
Transaction Validation	C1-RETCLMVAL	C1-RETCLMVAL	Retention Claim Based - Validation

- Define additional data for the retention type claim based pricing rule type.
- Add the required price items for retention type claim based pricing rule type.
- Add price item parameters for the retention type claim based pricing rule type.
- Define characteristics for the retention type claim based pricing rule type.
- Add the claim disposition details for retention type claim based pricing rule type.
- Click **Save**.

The retention type claim based pricing rule type is defined.

Related Topics

For more information on...	See...
Pricing Rule Type screen	Pricing Rule Type on page 2532
How to add the related pricing rule types in the primary pricing rule type	Adding Related Pricing Rule Types in a Primary Pricing Rule Type on page 2549
How to define the transaction field mapping in the primary pricing rule type	Defining Transaction Field Mapping in a Primary Pricing Rule Type on page 2551
How to associate algorithms with the pricing rule type	Associating Algorithms with a Pricing Rule Type on page 2557

For more information on...	See...
How to define additional data for the pricing rule type	Defining Additional Data for a Pricing Rule Type on page 2559
How to add pricing items in the pricing rule type	Adding Price Items in a Pricing Rule Type on page 2561
How to add price item parameters in the pricing rule type	Adding a Price Item Parameter in a Pricing Rule Type on page 2564
How to define a characteristic for the pricing rule type	Defining a Characteristic for a Pricing Rule Type on page 2566
How to add claim templates in the claim pricing rule type	Adding Claim Templates in a Claim Pricing Rule Type on page 2568
How to add the claim-specific data in the pricing rule type	Adding the Claim-Specific Data in a Pricing Rule Type on page 2569

Adding Claim Based Disposition Details in a Pricing Rule Type

Prerequisites

To add claim based disposition details in a pricing rule type, you should have:

- Pricing rule types defined in the application.
- Account and Price Item Derivation Algorithm defined in the application.
- Claim Disposition and Disposition Mode defined in the application.

Procedure

To add claim based disposition details in a pricing rule type:

1. Ensure that the **Claim Disposition Details** section is expanded when you are defining or editing for a primary pricing rule type.

The **Claim Disposition Details** section contains the following fields:

Field Name	Field Description	Mandatory (Yes or No)
Claim Disposition	Used to specify the type of claim disposition.	No
Disposition Mode	Used to specify the mode of claim disposition.	No

2. Enter the required details in the **Claim Disposition Details** section.

Note:

If the **Claim Disposition** field in the transaction is set to **Yes**, you must set the disposition mode to **Align Signage**. However, if the **Claim Disposition** field in the transaction is set to **No**, you must set the disposition mode to **Zero Out**.

If the **Disposition Mode** field is set to **Align Signage**, the claim based fees is positive for positive claims and the claim based fees is negative for negative claims. However, if the **Disposition Mode** field is set to **Zero Out**, the claim based fees for the negative claims is set to zero (0).

3. If you want to define more than one claim disposition entry for the primary pricing rule type, click the **Add (+)** icon and then repeat step 2.

Note: However, if you want to remove a claim disposition entry for the primary pricing rule type, click the **Delete** (🗑️) icon corresponding to the related pricing rule type.

Related Topics

For more information on...	See...
Defining a retention type claim based pricing rule type	Defining a Retention Type Claim Based Pricing Rule Type on page 2669
How to define related pricing rule types for retention type claim based pricing rule type	Adding Related Pricing Rule Types in a Primary Pricing Rule Type on page 2549
How to define transaction field mapping for retention type claim based pricing rule type	Defining Transaction Field Mapping in a Primary Pricing Rule Type on page 2551
How to associate algorithms for retention type claim based pricing rule type	Associating Algorithms with a Pricing Rule Type on page 2557
How to define additional data for retention type claim based pricing rule type	Defining Additional Data for a Pricing Rule Type on page 2559
How to define price items for retention type claim based pricing rule type	Adding Price Items in a Pricing Rule Type on page 2561
How to define price item parameters for retention type claim based pricing rule type	Adding a Price Item Parameter in a Pricing Rule Type on page 2564
How to define a characteristic for pricing rule type	Defining a Characteristic for a Pricing Rule Type on page 2566

Editing a Retention Type Claim Based Pricing Rule Type

Prerequisites

To edit the retention type claim based pricing rule type, you should have:

- Business Object **C1-PricingRuleRefTypeClaim** defined for the retention type claim based pricing rule type.
- Business Object **C1-PrcRuleTypRetClaimBase** defined for the retention type claim based pricing rule type.
- Pricing rule type category for the retention type claim based pricing rule type defined in the application

Procedure

To edit a retention type claim based pricing rule type:

1. Click the **Admin** link in the **Application** toolbar.
A list appears.
2. From the **Admin** menu, select **P** and then click **Pricing Rule Type**.
A sub-menu appears.
3. Click the **Search** option from the **Pricing Rule Type** sub-menu.
The **Pricing Rule Type** screen appears.
4. In the **Pricing Rule Type List** zone, click the **Edit** (✎) icon in the **Edit** column corresponding to the pricing rule type for claim whose details you want to edit.

The **Retention Type Enrollment Based Pricing Rule Type** screen appears. It contains the following sections:

- **Main** – Used to specify basic details about the retention type claim based pricing rule type.

- **Related Pricing Rule Types** – Used to define the pricing rule types which are related to the parent pricing rule type.
- **Transaction Field Mapping** – Used to specify the transaction related data mapped to the pricing rule type
- **Algorithms** – Used to define the algorithms used for the retention type claim based pricing rule type.
- **Additional Data** – Used to specify the additional information about the retention type claim based pricing rule type.
- **Price Items** – Used to define the price items assigned to the retention type claim based pricing rule type.
- **Price Item Parameters** – Used to define the price item parameters in the retention type claim based pricing rule type.
- **Characteristics** – Used to define the characteristics for the retention type claim based pricing rule type.
- **Claim Templates** – Used to define the pricing rule type for retention type claim based template.
- **Claim-Specific Additional Data** – Used to specify the retention type claim based specific additional data.

The **Main** section contains the following fields:

Field Name	Field Description	Mandatory (Yes or No)
Pricing Rule Type	Displays the pricing rule type.	Not applicable
Description	Used to specify the description for the pricing rule type.	Yes
Detailed Description	Used to specify additional information about the pricing rule type.	No
Related Transaction Business Object	Used to indicate the retention type claim based pricing rule type business object. The valid values are: <ul style="list-style-type: none"> • Claim Pricing Rule • Aggregate Stop-Loss (ASL) Pricing Rule • Specific Stop-Loss (SSL) Pricing Rule • Retention Type Claim Based Pricing Rule • Retention Type Enrollment Based Pricing Rule 	Yes
Business Object	Displays the retention type claim based pricing rule type business object for retention type claim.	Not applicable
Status	Used to indicate the status of the retention type claim based pricing rule type. The valid values are: <ul style="list-style-type: none"> • Active • Inactive 	
Primary	Used to select the checkbox if the retention type claim based pricing rule type is primary.	No

Field Name	Field Description	Mandatory (Yes or No)
Pricing Rule Type Category	Used to indicate the pricing rule type category for the retention type claim based pricing rule type. The valid values are: <ul style="list-style-type: none"> Aggregate Stop-Loss Claim Discounted Agreement Retention Type Claim Based Retention Type Enrollment Based Specific Stop-Loss 	Yes

Tip: Alternatively, you can click the **Edit** button in the **Pricing Rule Type** zone to edit the pricing rule type for retention type claim.

- Modify the details in the **Main** section, if required.
- Add, edit, or remove the related pricing rule types in the retention type claim based pricing rule type, if required.
- Modify the transaction field mapping in the retention type claim based pricing rule type, if required.
- Add, edit, or remove algorithms with the retention type claim based pricing rule type, if required.
- Modify the additional data for the retention type claim based pricing rule type, if required.
- Add, edit, or remove pricing items in the retention type claim based pricing rule type, if required.
- Add, edit, or remove price item parameters in the retention type claim based pricing rule type, if required.
- Add, edit, or remove characteristics for the retention type claim based pricing rule type, if required.
- Add, edit, or remove claim templates in the retention type claim based pricing rule type, if required.
- Modify the claim-specific data in the retention type claim based pricing rule type, if required.
- Click **Save**.

The changes made to the Retention Type Claim Based Pricing Rule Type are saved.

Related Topics

For more information on...	See...
Pricing Rule Type screen	Pricing Rule Type on page 2532
Pricing Rule Type List zone	Pricing Rule Type List on page 2533
Pricing Rule Type zone	Pricing Rule Type on page 2536

Deleting a Retention Type Claim Based Pricing Rule Type

Procedure

To delete a retention type claim based pricing rule type:

- Click the **Admin** link in the **Application** toolbar.
A list appears.
- From the **Admin** menu, select **P** and then click **Pricing Rule Type**.
A sub-menu appears.

- Click the **Search** option from the **Pricing Rule Type** sub-menu.

The **Pricing Rule Type** screen appears.

- In the **Pricing Rule Type List** zone, click the **Delete** (🗑️) icon in the **Delete** column corresponding to the retention type claim based pricing rule type that you want to delete.

A message appears confirming whether you want to delete the retention type claim based pricing rule type.

Note: You can delete a retention type claim based pricing rule type when it is not yet used in the system.

Tip: Alternatively, you can delete a retention type claim based pricing rule type by clicking the **Delete** button in the **Pricing Rule Type** zone.

- Click **OK**.

The retention type claim based pricing rule type is deleted.

Related Topics

For more information on...	See...
Pricing Rule Type screen	Pricing Rule Type on page 2532
Pricing Rule Type List zone	Pricing Rule Type List on page 2533
Pricing Rule Type zone	Pricing Rule Type on page 2536

Viewing the Retention Type Claim Based Pricing Rule Type Details

Procedure

To view the details of a retention type claim based pricing rule type:

- Click the **Admin** link in the **Application** toolbar.

A list appears.

- From the **Admin** menu, select **P** and then click **Pricing Rule Type**.

A sub-menu appears.

- Click the **Search** option from the **Pricing Rule Type** sub-menu.

The **Pricing Rule Type** screen appears.

- In the **Pricing Rule Type List** zone, click the **Broadcast** (📡) icon corresponding to the retention type claim based pricing rule type whose details you want to view.

The **Pricing Rule Type** zone appears.

- View the details of the retention type claim based pricing rule type in the **Pricing Rule Type** zone.

Related Topics

For more information on...	See...
Pricing Rule Type screen	Pricing Rule Type on page 2532
Pricing Rule Type List zone	Pricing Rule Type List on page 2533
Pricing Rule Type zone	Pricing Rule Type on page 2536

Defining a Retention Type Claim Based Pricing Rule for a Parent Customer

Prerequisites

To define a retention type claim based pricing rule for a parent customer, you should have:

- Business Object **C1-PricingRule** defined for the pricing rule.
- Business Object **C1-PricingRuleRetTypeClaim** defined for retention type claim based pricing rule type.
- Algorithms **C1-APPTXNBAS**, **C1-PRCRETPOS**, and **C1-RETCLMVAL** defined for retention type claim based pricing rule type.

Note: A custom algorithm type must be created to validate a transaction.

Procedure

To define a retention type claim based pricing rule for a parent customer:

1. Search for a parent customer in the **Customer 360° View** screen.
The **Search Result** screen appears.
2. In the **Search Results** section, click the **View** () icon corresponding to the parent customer whose pricing details you want to view.
The **Person** tab appears in the **Customer 360° Information** screen.
3. Click the **Pricing** tab.
The **Pricing** tab appears.
4. Click the **Add** link in the upper-right corner of the **Parent Customer Pricing Rules** zone.
The **Pricing Rule** screen appears. It contains the following fields:

Field Name	Field Description	Mandatory (Yes or No)
Person Name	Indicates the parent customer for whom you want to create a discount arrangement pricing rule type.	Not applicable
Person Type	Displays the person type.	Not applicable
Pricing Rule Type	Used to indicate the pricing rule type. The valid values is: <ul style="list-style-type: none"> • Retention Type Claim Based Pricing Rule 	Yes
		Note: If the pricing rule type is not selected then the application displays an error message.

5. Select the required pricing rule type in the respective field.
6. Click **OK**.

The **Retention Type Claim Based Pricing Rule** screen appears. It contains the following sections:

- **Customer Information** - Displays information about the parent customer for whom you are defining the retention type claim based pricing rule. It contains the following fields:

Field Name	Field Description
Parent Customer Information	Indicates the parent customer for whom you are defining the retention type claim based pricing rule.
Pricing Rule Type	Indicates the pricing rule type using which you are defining the retention type claim based pricing rule.

- **Main** - This section contains the following fields:

Field Name	Field Description	Mandatory (Yes or No)
Price Item	Used to indicate the price item for which you want to define the retention type claim based pricing. The valid value is: <ul style="list-style-type: none"> • Admin Fee 	Yes
Pricing Start Date	Used to specify the start date from when the retention type claim based pricing will be effective for the price item.	Yes (Conditional)
	Note: The pricing start date cannot be later than the pricing end date.	Note: Pricing Start Date should be entered if Pricing End Date has been mentioned.
Pricing End Date	Used to specify the end date till when the retention type claim based pricing will be effective for the price item.	No
	Note: The pricing end date cannot be earlier than the pricing start date.	

Field Name	Field Description	Mandatory (Yes or No)									
Rate Option	<p>Used to indicate the rate option that you want to use while defining the pricing for the price item. The valid value is:</p> <ul style="list-style-type: none"> Flat Dollar Per Claim - Agg Daily <p>On selecting an option from the Rate Option field, following fields appear in a grid:</p> <table border="1" data-bbox="516 453 1256 1667"> <thead> <tr> <th data-bbox="516 453 667 569">Field Name</th> <th data-bbox="667 453 1110 569">Field Description</th> <th data-bbox="1110 453 1256 569">Mandatory (Yes or No)</th> </tr> </thead> <tbody> <tr> <td data-bbox="516 569 667 1100">Price Item Parameter</td> <td data-bbox="667 569 1110 1100"> <p>Used to specify multiple price item parameters based on which you want to determine the price item utilization.</p> <div data-bbox="672 688 1105 1087" style="border: 1px solid black; padding: 5px;"> <p>Note:</p> <p>The Search (🔍) icon appears corresponding to the Price Item Parameter field. On clicking the Search icon, the Price Item Parameter Search screen appears.</p> <p>On specifying the price item, the description of the price item appears corresponding to the Price Item Parameter field.</p> </div> </td> <td data-bbox="1110 569 1256 1100">No</td> </tr> <tr> <td data-bbox="516 1100 667 1667">Parameter Value</td> <td data-bbox="667 1100 1110 1667"> <p>Used to specify multiple price item parameter values based on which you want to determine the price item utilization.</p> <div data-bbox="672 1255 1105 1654" style="border: 1px solid black; padding: 5px;"> <p>Note:</p> <p>The Search (🔍) icon appears corresponding to the Parameter Value field. On clicking the Search icon, the Predefined Parameter Value Search screen appears.</p> <p>On specifying the price item, the description of the price item appears corresponding to the Parameter Value Search field.</p> </div> </td> <td data-bbox="1110 1100 1256 1667">No</td> </tr> </tbody> </table>	Field Name	Field Description	Mandatory (Yes or No)	Price Item Parameter	<p>Used to specify multiple price item parameters based on which you want to determine the price item utilization.</p> <div data-bbox="672 688 1105 1087" style="border: 1px solid black; padding: 5px;"> <p>Note:</p> <p>The Search (🔍) icon appears corresponding to the Price Item Parameter field. On clicking the Search icon, the Price Item Parameter Search screen appears.</p> <p>On specifying the price item, the description of the price item appears corresponding to the Price Item Parameter field.</p> </div>	No	Parameter Value	<p>Used to specify multiple price item parameter values based on which you want to determine the price item utilization.</p> <div data-bbox="672 1255 1105 1654" style="border: 1px solid black; padding: 5px;"> <p>Note:</p> <p>The Search (🔍) icon appears corresponding to the Parameter Value field. On clicking the Search icon, the Predefined Parameter Value Search screen appears.</p> <p>On specifying the price item, the description of the price item appears corresponding to the Parameter Value Search field.</p> </div>	No	Not applicable
Field Name	Field Description	Mandatory (Yes or No)									
Price Item Parameter	<p>Used to specify multiple price item parameters based on which you want to determine the price item utilization.</p> <div data-bbox="672 688 1105 1087" style="border: 1px solid black; padding: 5px;"> <p>Note:</p> <p>The Search (🔍) icon appears corresponding to the Price Item Parameter field. On clicking the Search icon, the Price Item Parameter Search screen appears.</p> <p>On specifying the price item, the description of the price item appears corresponding to the Price Item Parameter field.</p> </div>	No									
Parameter Value	<p>Used to specify multiple price item parameter values based on which you want to determine the price item utilization.</p> <div data-bbox="672 1255 1105 1654" style="border: 1px solid black; padding: 5px;"> <p>Note:</p> <p>The Search (🔍) icon appears corresponding to the Parameter Value field. On clicking the Search icon, the Predefined Parameter Value Search screen appears.</p> <p>On specifying the price item, the description of the price item appears corresponding to the Parameter Value Search field.</p> </div>	No									
<p>Note:</p> <p>If you want to define more than one price item parameter to the price item in a retention type claim based pricing rule type, click the Add (+) icon.</p> <p>However, if you want to remove a price item parameter from the price item in a retention type claim based pricing rule type, click the Delete (🗑️) icon corresponding to the Price Item Parameter field.</p>											

Field Name	Field Description	Mandatory (Yes or No)
Fee	Used to specify the fee for the price item parameter.	

- **Characteristics** - Used to define the characteristics for the retention type claim based pricing rule for parent customer.

7. Add the required details in the main and characteristics section.

8. Click **Save**.

The retention type claim based pricing rule for a parent customer is defined.

Note:

If the approval workflow group setting is set as **Active** for the parent customer, for which the retention type claim based pricing rule is defined then an approval transaction is created for that particular parent customer. The retention type claim based pricing rule for a parent customer is defined, once the approval transaction is approved.

Related Topics

For more information on...	See...
How to define a characteristic for a retention type claim based pricing rule.	Defining a Characteristic for a Retention Type Claim Based Pricing Rule on page 2680

Defining a Characteristic for a Retention Type Claim Based Pricing Rule

Prerequisites

To define a characteristic for a retention type claim based pricing rule, you should have:

- Characteristic types defined in the application (where the characteristic entity is set to **Pricing Rule**)

Procedure

To define a characteristic for a retention type claim based pricing rule:

1. Ensure that the **Characteristics** section is expanded when you are defining or editing a retention type claim based pricing rule.

The **Characteristics** section contains the following fields in a grid:

Field Name	Field Description	Mandatory (Yes or No)
Effective Date	Used to specify from when the pricing rule will be effective.	Yes
Characteristic Type	Used to indicate the characteristic type for the retention type claim based pricing rule of a parent customer.	Yes (Conditional)
		Note: This field is required when you are defining a characteristic for retention type claim based pricing rule.

Field Name	Field Description	Mandatory (Yes or No)
Characteristic Value	Used to specify the characteristic value for the retention type claim based pricing rule of a parent customer.	Yes (Conditional)
	<p>Note:</p> <p>If you select a predefined characteristic type, the Search (🔍) icon appears corresponding to the Characteristic Value field. On clicking the Search icon, the Predefined Characteristic Search window appears.</p> <p>On specifying the value for a predefined characteristic type, the description of the characteristic value appears corresponding to the Characteristic Value field.</p>	<p>Note: This field is required when you are defining a characteristic for retention type claim based pricing rule.</p>

- Enter the required details in the **Characteristics** section.
- If you want to define more than one characteristic for retention type claim based pricing rule, click the **Add** (+) icon and then repeat step 2.

Note: However, if you want to remove a characteristic from retention type claim based pricing rule, click the **Delete** (🗑️) icon corresponding to the characteristic.

- Click **Save**.

The characteristics are defined for the retention type claim based pricing rule.

Related Topics

For more information on...	See...
How to define a retention type claim based pricing rule for a parent customer	Defining a Retention Type Claim Based Pricing Rule for a Parent Customer on page 2677

Editing a Retention Type Claim Based Pricing Rule of a Parent Customer

Prerequisites

To edit a retention type claim based pricing rule of a parent customer, you should have:

- Business Object **C1-PricingRule** defined for the pricing rule.
- Business Object **C1-PricingRuleRetTypeClaim** defined for retention type claim based pricing rule type.
- Algorithms **C1-APPTXNBAS**, **C1-PRCRETPOS**, and **C1-RETCLMVAL** defined for retention type claim based pricing rule type.

Note: A custom algorithm type must be created to validate a transaction.

Procedure

To edit a retention type claim based pricing rule of a parent customer:

- Search for a parent customer in the **Customer 360° View** screen.
- In the **Search Results** section, click the **View** (🔗) icon corresponding to the parent customer whose pricing details you want to view.

The **Person** tab appears in the **Customer 360° Information** screen.

- Click the **Pricing** tab. It consists of the following zones:

The **Pricing** tab appears.

4. In the **Parent Customer Pricing Rules** zone, click the **Edit** (✎) icon in the **Edit** column corresponding to the retention type claim based pricing rule, whose details you want to edit.

The **Retention Type Claim Based Pricing Rule** screen appears. It contains the following zones:

- **Customer Information** - Displays information about the parent customer for whom the retention type claim based pricing rule is defined. It contains the following fields:

Field Name	Field Description
Parent Customer Information	Indicates the parent customer for whom the discount arrangement pricing rule is defined.
Pricing Rule Type	Displays the pricing rule type that is chosen to define the retention type claim based pricing rule of a parent customer.

- **Main** - This section contains the following fields:

Field Name	Field Description	Mandatory (Yes or No)
Price Item	Indicates the price item for which you want to define the pricing.	Not applicable
Pricing Start Date	Used to specify the start date from when the pricing will be effective for the price item.	Yes (Conditional)
	Note: The pricing start date cannot be later than the pricing end date.	
Pricing End Date	Used to specify the end date till when the pricing will be effective for the price item.	No
	Note: The pricing end date cannot be earlier than the pricing start date.	

Field Name	Field Description	Mandatory (Yes or No)									
Rate Option	<p>Used to indicate the rate option that you want to use while defining the pricing for the price item. The valid value is:</p> <ul style="list-style-type: none"> Flat Dollar Per Claim - Agg Daily <p>On clicking the Add (+) icon, the following fields appear in a grid:</p> <table border="1" data-bbox="548 436 1247 1654"> <thead> <tr> <th data-bbox="548 436 667 548">Field Name</th> <th data-bbox="667 436 1097 548">Field Description</th> <th data-bbox="1097 436 1247 548">Mandatory (Yes or No)</th> </tr> </thead> <tbody> <tr> <td data-bbox="548 548 667 1083">Price Item Parameter</td> <td data-bbox="667 548 1097 1083"> <p>Used to specify multiple price item parameters based on which you want to determine the price item utilization.</p> <p>Note:</p> <p>The Search (🔍) icon appears corresponding to the Price Item Parameter field. On clicking the Search icon, the Price Item Parameter Search screen appears.</p> <p>On specifying the price item, the description of the price item appears corresponding to the Price Item Parameter field.</p> </td> <td data-bbox="1097 548 1247 1083">No</td> </tr> <tr> <td data-bbox="548 1083 667 1654">Parameter Value</td> <td data-bbox="667 1083 1097 1654"> <p>Used to specify multiple price item parameter values based on which you want to determine the price item utilization.</p> <p>Note:</p> <p>The Search (🔍) icon appears corresponding to the Parameter Value field. On clicking the Search icon, the Predefined Parameter Value Search screen appears.</p> <p>On specifying the price item, the description of the price item appears corresponding to the Parameter Value Search field.</p> </td> <td data-bbox="1097 1083 1247 1654">No</td> </tr> </tbody> </table> <p>Note:</p> <p>If you want to define more than one price item parameter to the price item in a retention type claim based pricing rule type, click the Add (+) icon.</p> <p>However, if you want to remove a price item parameter from the price item in a retention type claim based pricing rule type, click the Delete (🗑️) icon corresponding to the Price Item Parameter field.</p>	Field Name	Field Description	Mandatory (Yes or No)	Price Item Parameter	<p>Used to specify multiple price item parameters based on which you want to determine the price item utilization.</p> <p>Note:</p> <p>The Search (🔍) icon appears corresponding to the Price Item Parameter field. On clicking the Search icon, the Price Item Parameter Search screen appears.</p> <p>On specifying the price item, the description of the price item appears corresponding to the Price Item Parameter field.</p>	No	Parameter Value	<p>Used to specify multiple price item parameter values based on which you want to determine the price item utilization.</p> <p>Note:</p> <p>The Search (🔍) icon appears corresponding to the Parameter Value field. On clicking the Search icon, the Predefined Parameter Value Search screen appears.</p> <p>On specifying the price item, the description of the price item appears corresponding to the Parameter Value Search field.</p>	No	Not applicable
Field Name	Field Description	Mandatory (Yes or No)									
Price Item Parameter	<p>Used to specify multiple price item parameters based on which you want to determine the price item utilization.</p> <p>Note:</p> <p>The Search (🔍) icon appears corresponding to the Price Item Parameter field. On clicking the Search icon, the Price Item Parameter Search screen appears.</p> <p>On specifying the price item, the description of the price item appears corresponding to the Price Item Parameter field.</p>	No									
Parameter Value	<p>Used to specify multiple price item parameter values based on which you want to determine the price item utilization.</p> <p>Note:</p> <p>The Search (🔍) icon appears corresponding to the Parameter Value field. On clicking the Search icon, the Predefined Parameter Value Search screen appears.</p> <p>On specifying the price item, the description of the price item appears corresponding to the Parameter Value Search field.</p>	No									

Field Name	Field Description	Mandatory (Yes or No)
Fee	Used to specify the fee for the price item parameter.	Not applicable

- **Characteristics** - Used to define the characteristics for the retention type claim based pricing rule for parent customer. It contains the following fields:

Field Name	Field Description	Mandatory (Yes or No)
Effective Date	Used to specify the effective date from when the characteristic is effective for the retention type claim based pricing rule of a parent customer.	No
Characteristic Type	Used to indicate the characteristic type for the retention type claim based pricing rule of a parent customer.	No
Characteristic Value	Used to specify the characteristic value for the retention type claim based pricing rule of a parent customer. Note: If you select a predefined characteristic type, the Search (🔍) icon appears corresponding to the Characteristic Value field. On clicking the Search icon, the Predefined Characteristic Search window appears. On specifying the value for a predefined characteristic type, the description of the characteristic value appears corresponding to the Characteristic Value field.	No

Note:

If the approval workflow group setting is set as **Active** for the parent customer, for which the retention type claim based pricing rule is edited then an approval transaction is created for that particular parent customer. The retention type claim based pricing rule for a parent customer is defined, once the approval transaction is approved.

5. Click **Save**.

The retention type claim based pricing rule of a parent customer is edited.

Related Topics

For more information on...	See...
Customer 360° Information – Pricing tab	Customer 360° Information - Pricing Information on page 693
Parent Customer Pricing Rules zone	Parent Customer Pricing Rules on page 696
How to search for a parent customer	Searching for a Person on page 648
How to define the characteristics for a retention type claim based pricing rule	Defining a Characteristic for a Retention Type Claim Based Pricing Rule on page 2680

Deleting a Retention Type Claim Based Pricing Rule of a Parent Customer

Procedure

To delete a retention type claim based pricing rule of a parent customer:

1. Search for a parent customer in the **Customer 360° Information** screen.

2. In the **Search Results** section, click the **View** (🔗) icon corresponding to the parent customer whose pricing details you want to view.
The **Person** tab in the **Customer 360° Information** screen.
3. Click the **Pricing** tab. It consists of the following zones:
The **Pricing** tab appears.
4. In the **Parent Customer Pricing Rules** zone, click the **Delete** (🗑️) icon in the **Delete** column corresponding to the retention type claim based pricing rule that you want to delete.
A message appears confirming whether you want to delete the retention type claim based pricing rule type of a parent customer.
5. Click **OK**.
The retention type claim based pricing rule of a parent customer is deleted.

Related Topics

For more information on...	See...
How to search for a parent customer	Searching for a Person on page 648
Parent Customer Pricing Rules zone	Parent Customer Pricing Rules on page 696

Defining a Retention Type Claim Based Pricing Rule for a Bill Group

Prerequisites

To define a retention type claim based pricing rule for a bill group, you should have:

- Business Object **C1-PricingRule** and **C1-PricingRuleType**, and **C1-PricingGroup** defined for the pricing rule.
- Business Object **C1-PolicyBOStatusReason** defined for the policy status.
- Business Object **C1-PricingRuleRefTypeClaim** defined for retention type claim based pricing rule type.
- Algorithms **C1-APPTXNBAS**, **C1-PRCRETPOS**, **C1-RETCLMVAL**, **C1-PRRTPREP**, **C1-PRCRLTY** defined for retention type claim based pricing rule type.

Note: A custom algorithm type must be created to validate a transaction.

Procedure

To define a retention type claim based pricing rule for a bill group:

1. Search for the Administrative Services Only (ASO) person, whose person type is set to **Bill Group**, in the **Customer 360° View** screen.
2. In the **Search Results** section, click the **View** (🔗) icon corresponding to the person whose pricing details you want to view.
The **Person** tab appears in the **Customer 360° Information** screen.
3. Click the **Pricing** tab.
The **Pricing** tab appears.
4. Click the **Broadcast** (📡) icon in the **Bill Group ASO Policy Information** zone, corresponding to the **Bill Group Information** column, whose bill group details you want to view.
The **Bill Group ASO Policy Pricing Rules** zone is displayed.
5. Click the **Add** link in the upper right corner of the **Bill Group ASO Policy Pricing Rules** zone.

The **Pricing Rule** screen appears. It contains the following fields:

Field Name	Field Description	Mandatory (Yes or No)
Person Name	Indicates the name of the parent customer.	Not applicable
Person Type	Indicates the type of the parent customer.	Not applicable
	Note: If you are defining the pricing rule type for the parent customer, then the person type will be Parent Customer .	
Pricing Rule Type	Used to indicate the pricing rule type using which you want to create a retention type claim based pricing rule.	Yes
	Note: Select the Retention Type Claim Based Pricing Rule Type option, as the pricing rule type.	Note: If the pricing rule type is not selected then the application displays an error message.
Pricing Group	Used to indicate the pricing group for the bill group.	No
	Note: Select the pricing group option when the retention type claim based pricing rule has to be defined for a bill group using the pricing group.	
Policy Status	Used to indicate the policy status for the bill group. The valid values are:	Yes (Conditional)
	<ul style="list-style-type: none"> • In Force/Active • Post Runout • Runout 	Note: Policy Status is required once the Pricing Rule Type is selected.

6. Select the appropriate fields in the **Main** section.

7. Click **OK**.

The **Retention Type Claim Based Pricing Rule** screen appears. It contains the following sections:

- **Main** - This section contains the following fields:

Field Name	Field Description	Mandatory (Yes or No)
Price Item	Used to indicate the price item for which you want to define the pricing. The valid value are: <ul style="list-style-type: none"> • Admin Fee 	Yes
Pricing Start Date	Used to specify the start date from when the pricing will be effective for the price item.	Yes (Conditional)
		Note: Pricing Start Date should be entered if Pricing End Date has been mentioned.
Pricing End Date	Used to specify the end date till when the pricing will be effective for the price item.	No

Field Name	Field Description	Mandatory (Yes or No)
Rate Option	Used to specify the rate option for the price item. The valid value are: <ul style="list-style-type: none"> Flat Dollar Per Claim - Agg Daily 	Yes
Price Item Parameter	Used to specify multiple price item parameters based on which you want to determine the price item utilization. Note: The Search (🔍) icon does appear corresponding to this field. On clicking the Search icon, the Price Item Parameters screen appears.	No
Parameter Value	Used to specify multiple price item parameter values based on which you want to determine the price item utilization. Note: The Search (🔍) icon does appear corresponding to this field. On clicking the Search icon, the Parameter Value Search screen appears.	No
Fee	Used to specify the fee for the price item parameter.	No

- **Characteristics** - Used to define the characteristics for the retention type claim based pricing rule for a bill group.

8. Add the required details in the main and characteristics section.

9. Click **Save**.

The retention type claim based pricing rule for a bill group is defined.

Note:

If the approval workflow group setting is set as **Active** for the bill group, for which the retention type claim based pricing rule is defined then an approval transaction is created for that particular bill group. The retention type claim based pricing rule for a bill group is defined, once the approval transaction is approved.

Related Topics

For more information on...	See...
How to define a characteristic for a retention type claim based pricing rule.	Defining a Characteristic for a Retention Type Claim Based Pricing Rule on page 2687

Defining a Characteristic for a Retention Type Claim Based Pricing Rule

Prerequisites

To define a characteristic for a retention type claim based pricing rule, you should have:

- Characteristic types defined in the application (where the characteristic entity is set to **Pricing Rule**)

Procedure

To define a characteristic for a retention type claim based pricing rule:

1. Ensure that the **Characteristics** section is expanded when you are defining or editing a retention type claim based pricing rule.

The **Characteristics** section contains the following columns in a grid:

Column Name	Column Description	Mandatory (Yes or No)
Effective Date	Used to specify from when the pricing rule will be effective.	Yes
Characteristic Type	Used to indicate the characteristic type. The valid values are: <ul style="list-style-type: none"> Eligible for Billing 	Yes (Conditional)
	Note: The list includes only those characteristic types where the characteristic entity is set to Pricing Rule Type .	Note: This field is required when you are defining a characteristic for retention type claim based pricing rule.
Characteristic Value	Used to specify the value for the characteristic type.	Yes (Conditional)
	Note: If you select a predefined characteristic type, the Search (🔍) icon appears corresponding to the Characteristic Value field. On clicking the Search icon, the Predefined Characteristic Search window appears. On specifying the value for a predefined characteristic type, the description of the characteristic value appears corresponding to the Characteristic Value field.	Note: This field is required when you are defining a characteristic for retention type claim based pricing rule.

- Enter the required details in the **Characteristics** section.
- If you want to define more than one characteristic for retention type claim based pricing rule, click the **Add** (+) icon and then repeat step 2.

Note: However, if you want to remove a characteristic from retention type claim based pricing rule, click the **Delete** (🗑️) icon corresponding to the characteristic.

- Click **Save**.

The characteristics are defined for the retention type claim based pricing rule.

Related Topics

For more information on...	See...
How to define a retention type claim based pricing rule for a bill group	Defining a Retention Type Claim Based Pricing Rule for a Bill Group on page 2685

Editing a Retention Type Claim Based Pricing Rule of a Bill Group

Prerequisites

To edit a retention type claim based pricing rule of a parent customer, you should have:

- Business Object **C1-PricingRule** defined for the pricing rule.
- Business Object **C1-PricingRuleRefTypeClaim** defined for retention type claim based pricing rule type.
- Algorithms **C1-APPTXNBAS**, **C1-PRCRETPOS**, and **C1-RETCLMVAL** defined for retention type claim based pricing rule type.

Note: A custom algorithm type must be created to validate a transaction.

Procedure

To edit a retention type claim based pricing rule of a bill group:

1. Search for a bill group in the **Customer 360° View** screen.
2. In the **Search Results** section, click the **View** (🔗) icon corresponding to the bill group whose pricing details you want to view.
The **Person** tab appears in the **Customer 360° Information** screen.
3. Click the **Pricing** tab.
The **Pricing** tab appears.
4. Click the **Broadcast** (📡) icon in the **Bill Group ASO Policy Information** zone, corresponding to the **Bill Group Information** column, whose bill group details you want to view.
The **Bill Group ASO Policy Pricing Rules** zone appears.
5. Click the **Edit** (✎) icon in the **Bill Group ASO Policy Pricing Rules** zone, corresponding to the **Pricing Rule Type** column, whose details you want to edit.

The **Retention Type Claim Based Pricing Rule** screen appears. It contains the following zones:

- **Customer Information** - Displays the basic information about the customer. It contains the following fields:

Column Name	Column Description
Bill Group Information	Displays the bill group name.
Policy Start Date	Displays the date from when the policy is effective.
Policy End Date	Displays the date till when the policy is effective.
Policy Status	Displays the status of the policy.
Pricing Rule Type	Displays the pricing rule type that is chosen to define the retention type claim based pricing rule of a bill group.

- **Main** - This section contains the following fields:

Field Name	Field Description	Mandatory (Yes or No)
Price Item	Indicates the price item for which you want to define the pricing.	Not applicable
Pricing Start Date	Used to specify the start date from when the pricing will be effective for the price item.	Yes (Conditional) Note: Pricing Start Date should be entered if Pricing End Date has been mentioned.
Pricing End Date	Used to specify the end date till when the pricing will be effective for the price item.	No
Rate Option	Indicates the rate option for the price item.	Not applicable

Field Name	Field Description	Mandatory (Yes or No)
Price Item Parameter	Used to specify multiple price item parameters based on which you want to determine the price item utilization.	No
	Note: The Search (🔍) icon does appear corresponding to this field. On clicking the Search icon, the Price Item Parameters screen appears.	
Parameter Value	Used to specify multiple price item parameter values based on which you want to determine the price item utilization.	No
	Note: The Search (🔍) icon does appear corresponding to this field. On clicking the Search icon, the Parameter Value Search screen appears.	
Fee	Indicates the fee for the price item parameter.	Not applicable

- **Characteristics** - Used to define the characteristics for the retention type claim based pricing rule for parent customer. It contains the following fields:

Field Name	Field Description	Mandatory (Yes or No)
Effective Date	Used to specify the effective date from when the characteristic is effective for the retention type claim based pricing rule of a bill group.	No
Characteristic Type	Used to indicate the characteristic type for the retention type claim based pricing rule of a bill group. The valid values are: <ul style="list-style-type: none"> • Eligible for Billing 	No
Characteristic Value	Used to specify the characteristic value for the retention type claim based pricing rule of a bill group.	No
	Note: If you select a predefined characteristic type, the Search (🔍) icon appears corresponding to the Characteristic Value field. On clicking the Search icon, the Predefined Characteristic Search window appears. On specifying the value for a predefined characteristic type, the description of the characteristic value appears corresponding to the Characteristic Value field.	

6. Click Save.

The **Approval Transaction Information** pop-up window appears with the Approval Transaction ID that is generated by the application.

7. Click OK

The retention type claim based pricing rule of a bill group is edited.

Note:

If the approval workflow group setting is set as **Active** for the bill group, for which the retention type claim based pricing rule is defined then an approval transaction is created for that particular bill group. The retention type claim based pricing rule for a bill group is defined, once the approval transaction is approved.

Related Topics

For more information on...	See...
How to define a retention type claim based pricing rule of a parent customer	Defining a Retention Type Claim Based Pricing Rule for a Parent Customer on page 2677

Deleting a Retention Type Claim Based Pricing Rule of a Bill Group**Procedure**

To delete a retention type claim based pricing rule of a bill group:

1. Search for a bill group in the **Customer 360° View** screen.
2. In the **Search Results** section, click the **View** () icon corresponding to the bill group whose pricing details you want to view.

The **Person** tab appears in the **Customer 360° Information** screen.

3. Click the **Pricing** tab.

The **Pricing** tab appears.

4. Click the **Broadcast** () icon in the **Bill Group ASO Policy Information** zone, corresponding to the **Bill Group Information** column, whose bill group details you want to delete.

The **Bill Group ASO Policy Pricing Rules** zone appears.

5. Click the **Delete** () icon in the **Delete** column corresponding to the **Pricing Group Information** column, whose bill group information you want to delete.

A message appears confirming whether you want to delete the retention type claim based pricing rule of a bill group.

Note: You can delete a retention type claim based pricing rule when it is not yet used in the system.

6. Click **OK**.

The retention type claim based pricing rule of a bill group is deleted.

Related Topics

For more information on...	See...
How to define a characteristic for a retention type claim based pricing rule.	Defining a Characteristic for a Retention Type Claim Based Pricing Rule on page 2680

Defining a Retention Type Claim Based Pricing Rule for a Bill Group Using a Pricing Group**Procedure**

To define a retention type claim based pricing rule for a bill group using pricing group:

1. Search for the Administrative Services Only (ASO) person, whose person type is set to **Bill Group**, in the **Customer 360° View** screen.
2. In the **Search Results** section, click the **View** () icon corresponding to the bill group whose pricing details you want to view.

The **Person** tab appears in the **Customer 360° Information** screen.

3. Click the **Pricing** tab.

The **Pricing** tab appears.

4. Click the **Broadcast** () icon in the **Bill Group ASO Policy Information** zone, corresponding to the **Bill Group Information** column, whose bill group details you want to view.

The **Bill Group ASO Policy Pricing Rules** zone is displayed.

5. Click the **Add** link in the upper right corner of the **Bill Group ASO Policy Pricing Rules** zone.

The **Pricing Rule** screen appears. It contains the following sections:

- **Main** - This section contains the following fields:

Field Name	Field Description	Mandatory (Yes or No)
Person Name	Displays the person name.	Not applicable
Person Type	Displays the person type.	Not applicable
Pricing Rule Type	Used to indicate the pricing rule type. The valid values are: <ul style="list-style-type: none"> • Aggregate Stop-Loss (ASL) Pricing Rule • Claim Pricing Rule • Discount Arrangement Pricing Rule • Retention Type Claim Based Pricing Rule • Retention Type Enrollment Based Pricing Rule • Specific Stop-Loss (SSL) Pricing Rule 	Yes Note: If the pricing rule type is not selected then the application displays an error message.
	Note: Select the Retention Type Claim Based Pricing Rule option, as the pricing rule type.	
Pricing Group	Used to indicate the pricing group for the bill group. Note: You must select a pricing group for the bill group on which the retention type claim based pricing rule is to be defined.	Yes
Policy Status	Used to indicate the policy status for the bill group. The valid values are: <ul style="list-style-type: none"> • In Force/Active • Post Runout • Runout 	Yes (Conditional) Note: Policy Status is required once the Pricing Rule Type is selected.

6. Select the appropriate fields in the **Main** section.
7. Click **OK**.

The **Retention Type Claim Based Pricing Rule** screen appears. It contains the following sections:

- **Main** - This section contains the following fields:

Field Name	Field Description	Mandatory (Yes or No)
Price Item	Used to indicate the price item for which you want to define the pricing. The valid value are: <ul style="list-style-type: none"> • Admin Fee 	Yes
Pricing Start Date	Used to specify the start date from when the pricing will be effective for the price item.	Yes (Conditional)
		Note: Pricing Start Date should be entered if Pricing End Date has been mentioned.
Pricing End Date	Used to specify the end date till when the pricing will be effective for the price item.	No
Rate Option	Used to specify the rate option for the price item. The valid value are: <ul style="list-style-type: none"> • Flat Dollar Per Claim - Agg Daily 	Yes
Pricing Group Rule Code	Displays the code of the pricing group rule.	Not applicable
Description	Displays the description of the pricing group rule.	Not applicable
Price Item Parameter	Used to specify multiple price item parameters based on which you want to determine the price item utilization. <p>Note: The Search (🔍) icon does appear corresponding to this field. On clicking the Search icon, the Price Item Parameters screen appears.</p>	No
Parameter Value	Used to specify multiple price item parameter values based on which you want to determine the price item utilization. <p>Note: The Search (🔍) icon does appear corresponding to this field. On clicking the Search icon, the Parameter Value Search screen appears.</p>	No
Fee	Used to specify the fee for the price item parameter.	No

- **Characteristics** - Used to define the characteristics for the Retention Type Claim Based Pricing Rule for a Bill Group Using a Pricing Group.

8. Add the required details in the main and characteristics section.

9. Click **Save**.

The retention type claim based pricing rule for a bill group using a pricing group is defined.

Note:

If the approval workflow group setting is set as **Active** for the bill group, for which the retention type claim based pricing rule is defined then an approval transaction is created for that particular bill group. The retention type claim based pricing rule for a bill group using a pricing group is defined, once the approval transaction is approved.

Related Topics

For more information on...	See...
How to define a characteristic for a retention type claim based pricing rule for a bill group using pricing group.	Defining a Characteristic for a Retention Type Claim Based Pricing Rule for a Bill Group Using a Pricing Group on page 2694

Defining a Characteristic for a Retention Type Claim Based Pricing Rule for a Bill Group Using a Pricing Group

Prerequisites

To define a characteristic for a retention type claim based pricing rule for a bill group using a pricing group, you should have:

- Characteristic types defined in the application (where the characteristic entity is set to **Pricing Rule**)

Procedure

To define a characteristic for a retention type claim based pricing rule for a bill group using a pricing group:

1. Ensure that the **Characteristics** section is expanded when you are defining or editing a retention type claim based pricing rule for a bill group

The **Characteristics** section contains the following columns in a grid:

Column Name	Column Description	Mandatory (Yes or No)
Effective Date	Used to specify from when the pricing rule will be effective.	Yes
Characteristic Type	Used to indicate the characteristic type. The valid values are: <ul style="list-style-type: none"> • Eligible for Billing 	Yes (Conditional)
	Note: The list includes only those characteristic types where the characteristic entity is set to Pricing Rule Type .	

Column Name	Column Description	Mandatory (Yes or No)
Characteristic Value	Used to specify the value for the characteristic type.	Yes (Conditional)
	<p>Note:</p> <p>If you select a predefined characteristic type, the Search (🔍) icon appears corresponding to the Characteristic Value field. On clicking the Search icon, the Predefined Characteristic Search window appears.</p> <p>On specifying the value for a predefined characteristic type, the description of the characteristic value appears corresponding to the Characteristic Value field.</p>	<p>Note: This field is required when you are defining a characteristic for retention type claim based pricing rule for a bill group using a pricing group.</p>

- Enter the required details in the **Characteristics** section.
- If you want to define more than one characteristic, click the **Add** (+) icon and then repeat step 2.

Note: However, if you want to remove a characteristic, click the **Delete** (🗑️) icon corresponding to the characteristic.

- Click **Save**.

The characteristics are defined for the retention type claim based pricing rule for a bill group using a pricing group.

Related Topics

For more information on...	See...
How to define a retention type claim based pricing rule for a bill group using a pricing group.	Defining a Retention Type Claim Based Pricing Rule for a Bill Group Using a Pricing Group on page 2691

Viewing a Retention Type Claim Based Pricing Rule of a Parent Customer

Procedure

To view a retention type claim based pricing rule for a parent customer:

- Search for a parent customer whose pricing details you want to view in the **Customer 360° View** screen.
- In the **Search Results** section, click the **View** (🔗) icon corresponding to the parent customer whose pricing details you want to view.

The **Person** tab appears in the **Customer 360° Information** screen appears.

- Click the **Pricing** tab.

The **Pricing** tab appears.

- In the **Parent Customer Pricing Rules** zone, click the link in the **Pricing Rule Information** column corresponding to the pricing rule type whose details you want to view.

The **Pricing Rule** screen appears. It contains the following zone:

- **Retention Type Claim Based** – Displays Retention Type Claim Based Pricing Rule of a Parent. It contains the following sections:
 - **Main** – Displays the basic details of the retention type claim based pricing rule of a parent customer.
 - **Price Item Parameters** – Displays the price item parameters defined for the retention type claim based pricing rule of a parent customer.

- **Characteristics** – Displays the characteristics defined for the retention type claim based pricing rule of a parent customer.
5. View the basic details of a retention type claim based pricing rule of a parent customer in the **Main** section.
 6. View the price item parameters of a retention type claim based pricing rule of a parent customer in the **Price Item Parameters** section.
 7. View the characteristics of a retention type claim based pricing rule of a parent customer in the **Characteristics** section.



Related Topics

For more information on...	See...
Customer 360° Information – Pricing tab	Customer 360° Information - Pricing Information on page 693

Viewing a Retention Type Claim Based Pricing Rule of a Bill Group

Procedure

To view a retention type claim based pricing rule of a bill group:

1. Search for a bill group in the **Customer 360° View** screen.
2. In the **Search Results** section, click the **View** () icon corresponding to the bill group whose pricing details you want to view.
The **Person** tab appears in the **Customer 360° Information** screen.
3. Click the **Pricing** tab.
The **Pricing** tab appears.
4. Click the **Broadcast** () icon in the **Bill Group ASO Policy Information** zone, corresponding to the **Bill Group Information** column, whose bill group details you want to view.
The **Bill Group ASO Policy Pricing Rules** zone appears.
5. In the **Bill Group ASO Policy Pricing Rules** zone, click the link in the **Pricing Rule Information** column corresponding to the pricing rule type whose details you want to view.

The **Pricing Rule** screen appears. It contains the following zone:

- **Retention Type Claim Based** – Displays Retention Type Claim Based Pricing Rule of a Bill Group. It contains the following sections:
 - **Main** – Displays the basic details of the retention type claim based pricing rule of a bill group.
 - **Price Item Parameters** – Displays the price item parameters defined for the retention type claim based pricing rule of a bill group.
 - **Characteristics** – Displays the characteristics defined for the retention type claim based pricing rule of a bill group.
6. View the basic details of a retention type claim based pricing rule of a bill group in the **Main** section.
 7. View the price item parameters of a retention type claim based pricing rule of a bill group in the **Price Item Parameters** section.
 8. View the characteristics of a retention type claim based pricing rule of a bill group in the **Characteristics** section.

Related Topics

For more information on...	See...
Customer 360° Information – Pricing tab	<i>Customer 360° Information - Pricing Information</i> on page 693

Retention Type Enrollment Based Pricing

Some of the charges, such as stop-loss premium, administrative fees, etc. are typically calculated based on the number of enrollments. In addition, the ASL limit can also be based on the number of enrollments for the month. These charges can be calculated using the retention type enrollment based pricing rules.

You can define a retention type enrollment based pricing rule at the parent customer and bill group levels. The retention type enrollment based pricing rule at the bill group level takes precedence over the retention type enrollment based pricing rule at the parent customer level. You can define retention type enrollment based pricing rules for parent customers and bill groups from the **Customer 360° Information** screen. You can define a retention type enrollment based pricing rule using a retention type enrollment based pricing rule type. It is the retention type enrollment based pricing rule type which helps the system to determine:

- Business object using which the retention type enrollment based pricing rule should be created in the system.
- Whether it is the primary pricing rule type.

Note: You must select the **Primary** option while defining a retention type enrollment based pricing rule type. On selecting the **Primary** option, the **Related Pricing Rule Types** and **Transaction Field Mapping** sections appear in the **Retention Type Enrollment Based Pricing Rule Type** screen. At present, the system does not allow you to define any pricing rule type which inherits the attributes from the retention type enrollment based pricing rule type.

- Transaction fields from where the data for retention type enrollment based processing should be retrieved.
- Algorithm which should be triggered while validating a transaction.

Note: An algorithm type for validating a transaction is not shipped from the product. You need to create a custom algorithm type, if required.

- Algorithms which should be triggered while deriving bill group, account, and price item for a transaction.

Note: You must create an algorithm using the **C1_TXNBGDRV** algorithm type and attach it to the **Bill Group Derivation** system event. Similarly, you must create an algorithm using the **C1_ACCPRIDRV** algorithm type and attach it to the **Account and Price Item Derivation** system event.

- Algorithm which should be triggered while determining the bill after date.

Note: You must create an algorithm using the **C1_BAFTDRV** algorithm type and attach it to the **Bill After Date Determination** system event. The **C1_BAFTDRV** algorithm sets the bill after date to the end date of the aggregation schedule which is specified in the respective rate option. For example, if the aggregation schedule is monthly, the bill after date is set to the last day of the month.

- Post-processing algorithm which should be triggered once the retention type enrollment based pricing rule is derived.

Note: A post-processing algorithm type is not shipped from the product. You need to create a custom algorithm type, if required.

- Price items for which you can define retention type enrollment based pricing rules using the retention type enrollment based pricing rule type.
- Rate options that you can use while defining the pricing for a price item.
- Different type of account to which the price item should be billed based on the specified priority.
- Price item parameters which you can use while defining retention type enrollment based pricing rules.

- Additional information, such as:
 - Whether the price items included in the retention type enrollment based pricing rule type are used while accumulating specific stop-loss and aggregate stop-loss.
 - Retroactivity indicator which helps to determine whether the enrollment transaction is retro or non-retro transaction.

Once a retention type enrollment based pricing rule type is defined, you can create retention type enrollment based pricing rules using the retention type enrollment based pricing rule type. While defining a retention type enrollment based pricing rule for a parent customer and bill group, you need to specify the following:

- Price item for which you want to define the pricing.
- Pricing date range during which the pricing is effective.
- Rate option which you want to use while defining the retention type enrollment based pricing.
- Whether you want to exempt the retrospective transactions while calculating retention type enrollment based fees.
- Price item parameters based on which you want to define the pricing.

Note: You can only use those price item parameters which are included in the respective retention type enrollment based pricing rule type.

- Price item parameters based on which you want to define the pricing.

Note: You can only use those price item parameters which are included in the respective retention type enrollment based pricing rule type.

- Flat fee which you want to charge for a price item and price item parameters combination.

The system enables you to define different flat fee for different set of price item parameters combination. For example, you can define one flat fee for the enrollment transactions where health coverage class is set to Medical and health coverage tier is set to Family and another flat fee for the enrollment transactions where health coverage class is set to Dental and health coverage tier is set to Employee.

Once a retention type enrollment based pricing rule is defined for a parent customer and bill group, the system creates one price assignment for each set of price item parameters combination, one price list, and one price list assignment.

Defining a Retention Type Enrollment Based Pricing Rule Type

Prerequisites

To define a retention type retention based pricing rule type, you should have:

- Business Object **C1-PrcRuleTypRetEnrollBased** defined for retention type enrollment based pricing rule type.
- Business Object **C1-PricingRuleRetTypeEnroll** defined for pricing rule.
- Pricing rule type category for the retention type enrollment defined in the application.

Procedure

To define a retention type retention based pricing rule type:

1. Click the **Admin** link in the **Application** toolbar.
A list appears.
2. From the **Admin** menu, select **P** and then click **Pricing Rule Type**.
A sub-menu appears.
3. Click the **Add** option from the **Pricing Rule Type** sub-menu.

The **Select Business Object** screen appears. It contains the following field:

Field Name	Field Description	Mandatory (Yes or No)
Pricing Rule Type Business Object	Used to indicate the business object using which you want to create the retention type enrollment based pricing rule type.	Yes
	Note: You can create a retention type enrollment based pricing rule type using the Claim Pricing Rule Type business object.	

Tip: Alternatively, you can access this screen by clicking the **Add** button in the **Page Title** area of the **Pricing Rule Type** screen.

4. Select the **Retention Type Claim Based Pricing Rule Type** business object.
5. Click **OK**.

The **Retention Type Claim Based Pricing Rule Type** screen appears. It contains the following sections:

- **Main** – Used to specify basic details about the retention type enrollment based pricing rule type.
- **Related Pricing Rule Types** – Used to define the pricing rule types which are related to the enrollment based parent pricing rule type.
- **Transaction Field Mapping** – Used to specify the transaction related data mapped to the enrollment based pricing rule type.
- **Algorithms** – Used to define the algorithms used for the enrollment based pricing rule type.
- **Additional Data** – Used to specify the additional information about the enrollment based pricing rule type.
- **Price Items** – Used to define the price items assigned to the enrollment based pricing rule type.
- **Price Item Parameters** – Used to define the price item parameters in the enrollment based pricing rule type.
- **Characteristics** – Used to define the characteristics for the enrollment based pricing rule type.
- **Enrollment-Specific Additional Data** – Used to specify the enrollment specific additional data.

The **Main** section contains the following fields:

Field Name	Field Description	Mandatory (Yes or No)
Pricing Rule Type	Used to specify the pricing rule type.	Yes
Description	Used to specify the description for the pricing rule type.	Yes
Detailed Description	Used to specify additional information about the pricing rule type.	No
Related Transaction Business Object	Used to indicate the pricing rule business object. The valid values are: <ul style="list-style-type: none"> • Aggregate Stop-Loss (ASL) Pricing Rule • Claim Pricing Rule • Discount Arrangement Pricing Rule • Retention Type Claim Based Pricing Rule • Retention Type Enrollment Based Pricing Rule • Specific Stop-Loss (SSL) Pricing Rule 	Yes

Field Name	Field Description	Mandatory (Yes or No)
Business Object	Indicate the retention type enrollment based pricing rule type business object for the claim.	Not applicable
Status	Used to indicate the status of the pricing rule type. The valid values are: <ul style="list-style-type: none"> Active Inactive 	
Primary	Used to select the checkbox if the pricing rule type is primary.	No
Pricing Rule Type Category	Used to indicate the pricing rule type category for the pricing rule type. The valid values are: <ul style="list-style-type: none"> Aggregate Stop-Loss Claim Discount Arrangement Retention Type Claim Based Retention Type Enrollment Based Specific Stop-Loss 	Yes

- Enter the required details in the **Main** section.
- Add the related pricing rule types in the primary pricing rule type, if required.

Note: Related Pricing Rule Types section appears when the pricing rule type is primary.

- Define the transaction field mapping in the primary pricing rule type, if required.

Note: Transaction Field Mapping section appears when the pricing rule type is primary.

- Associate algorithms with the enrollment based pricing rule type, if required.
- Define additional data for the enrollment based pricing rule type, if required.
- Add pricing items in the enrollment based pricing rule type, if required.
- Add price item parameters in the enrollment based pricing rule type, if required.
- Define characteristics for the enrollment based pricing rule type, if required.
- Add the enrollment-specific data, if required.
- Click **Save**.

The retention type enrollment based pricing rule type is defined.

Related Topics

For more information on...	See...
Pricing Rule Type screen	Pricing Rule Type on page 2532
How to add the related pricing rule types in the primary pricing rule type	Adding Related Pricing Rule Types in a Primary Pricing Rule Type on page 2549

For more information on...	See...
How to define the transaction field mapping in the primary pricing rule type	Defining Transaction Field Mapping in a Primary Pricing Rule Type on page 2551
How to associate algorithms with the pricing rule type	Associating Algorithms with a Pricing Rule Type on page 2557
How to define additional data for the pricing rule type	Defining Additional Data for a Pricing Rule Type on page 2559
How to add pricing items in the pricing rule type	Adding Price Items in a Pricing Rule Type on page 2561
How to add price item parameters in the pricing rule type	Adding a Price Item Parameter in a Pricing Rule Type on page 2564
How to define a characteristic for the pricing rule type	Defining a Characteristic for a Pricing Rule Type on page 2566
How to add claim templates in the claim pricing rule type	Adding Claim Templates in a Claim Pricing Rule Type on page 2568
How to add the claim-specific data in the pricing rule type	Adding the Claim-Specific Data in a Pricing Rule Type on page 2569

Adding the Enrollment Specific Data in a Pricing Rule Type

Prerequisites

To add enrollment specific data in a pricing rule type, you should have:

- Pricing rule types defined in the application.
- Account and Price Item Derivation Algorithm defined in the application.
- Bill Group Derivation Algorithm defined in the application.

Procedure

To add enrollment specific data in a pricing rule type in a pricing rule type:

1. Ensure that the **Enrollment-Specific Additional Data** section is expanded when you are adding enrollment specific data for a primary pricing rule type.

The **Enrollment-Specific Additional Data** section contains the following fields:

Field Name	Field Description	Mandatory (Yes or No)
Retroactivity Indicator Value	Used to specify that retroactivity indicator value should not be a part of enrollment based pricing rule type.	No
	Note: Set the retroactivity indicator value to R if the field should be excluded from enrollment based pricing rule types.	

2. Enter the required details in the **Enrollment-Specific Additional Data** section.
3. Click **Save**.

The enrollment-specific data has been added in the pricing rule type.

Related Topics

For more information on...	See...
Defining a retention type enrollment based pricing rule type	Defining a Retention Type Enrollment Based Pricing Rule Type on page 2698

Editing a Retention Type Enrollment Based Pricing Rule Type

Prerequisites

To edit the retention type enrollment based pricing rule type, you should have:

- Business Object **C1-PricingRuleRefTypeEnroll** defined for the retention type enrollment based pricing rule type.
- Business Object **C1-PrcRuleTypRetEnrollBased** defined for the retention type enrollment based pricing rule type.
- Pricing rule type category for retention type enrollment based pricing rule type defined in the application

Procedure

To edit a retention type enrollment based pricing rule type:

1. Click the **Admin** link in the **Application** toolbar.
A list appears.
2. From the **Admin** menu, select **P** and then click **Pricing Rule Type**.
A sub-menu appears.
3. Click the **Search** option from the **Pricing Rule Type** sub-menu.
The **Pricing Rule Type** screen appears.
4. In the **Pricing Rule Type List** zone, click the **Edit**  icon in the **Edit** column corresponding to the pricing rule type for claim whose details you want to edit.

The **Retention Type Enrollment Based Pricing Rule Type** screen appears. It contains the following sections:

- **Main** – Used to specify basic details about the retention type enrollment based pricing rule type.
- **Related Pricing Rule Types** – Used to define the pricing rule types which are related to the retention type enrollment based pricing rule type.
- **Transaction Field Mapping** – Used to specify the transaction related data mapped to the pricing rule type.
- **Algorithms** – Used to define the algorithms used for the retention type enrollment based pricing rule type.
- **Additional Data** – Used to specify the additional information about the retention type enrollment based pricing rule type.
- **Price Items** – Used to define the price items assigned to the retention type enrollment based pricing rule type.
- **Price Item Parameters** – Used to define the price item parameters in the retention type enrollment based pricing rule type.
- **Characteristics** – Used to define the characteristics for the retention type enrollment based pricing rule type.
- **Claim Templates** – Used to define the pricing rule type for the retention type enrollment based pricing rule type.
- **Claim-Specific Additional Data** – Used to specify the retention type enrollment based specific additional data.

The **Main** section contains the following fields:

Field Name	Field Description	Mandatory (Yes or No)
Pricing Rule Type	Displays the pricing rule type.	Not applicable
Description	Used to specify the description for the pricing rule type.	Yes
Detailed Description	Used to specify additional information about the pricing rule type.	No
Related Transaction Business Object	Used to indicate the retention type claim based pricing rule type business object. The valid values are: <ul style="list-style-type: none"> • Claim Pricing Rule • Aggregate Stop-Loss (ASL) Pricing Rule • Specific Stop-Loss (SSL) Pricing Rule • Retention Type Claim Based Pricing Rule • Retention Type Enrollment Based Pricing Rule 	Yes
Business Object	Displays the retention type enrollment based pricing rule type business object for retention type claim.	Not applicable
Status	Used to indicate the status of the retention type enrollment based pricing rule type. The valid values are: <ul style="list-style-type: none"> • Active • Inactive 	
Primary	Used to select the checkbox if the retention type enrollment based pricing rule type is primary.	No
Pricing Rule Type Category	Used to indicate the pricing rule type category for the retention type enrollment based pricing rule type. The valid values are: <ul style="list-style-type: none"> • Aggregate Stop-Loss • Claim • Discounted Agreement • Retention Type Claim Based • Retention Type Enrollment Based • Specific Stop-Loss 	Yes

Tip: Alternatively, you can click the **Edit** button in the **Pricing Rule Type** zone to edit the pricing rule type for retention type enrollment.

5. Modify the details in the **Main** section, if required.
6. Add, edit, or remove the related pricing rule types in the retention type enrollment based pricing rule type, if required.
7. Modify the transaction field mapping in the retention type enrollment based pricing rule type, if required.

8. Add, edit, or remove algorithms with the retention type enrollment based pricing rule type, if required.
9. Modify the additional data for the retention type enrollment based pricing rule type, if required.
10. Add, edit, or remove pricing items in the retention type enrollment based pricing rule type, if required.
11. Add, edit, or remove price item parameters in the retention type enrollment based pricing rule type, if required.
12. Add, edit, or remove characteristics for the retention type enrollment based pricing rule type, if required.
13. Modify the enrollment-specific data in the retention type enrollment based pricing rule type, if required.
14. Click **Save**.

The changes made to the Retention Type Enrollment Based Pricing Rule Type are saved.

Related Topics

For more information on...	See...
Pricing Rule Type screen	Pricing Rule Type on page 2532
Pricing Rule Type List zone	Pricing Rule Type List on page 2533
Pricing Rule Type zone	Pricing Rule Type on page 2536

Deleting a Retention Type Enrollment Based Pricing Rule Type

Procedure

To delete a retention type enrollment based pricing rule type:

1. Click the **Admin** link in the **Application** toolbar.
A list appears.
2. From the **Admin** menu, select **P** and then click **Pricing Rule Type**.
A sub-menu appears.
3. Click the **Search** option from the **Pricing Rule Type** sub-menu.
The **Pricing Rule Type** screen appears.
4. In the **Pricing Rule Type List** zone, click the **Delete** (🗑) icon in the **Delete** column corresponding to the retention type enrollment based pricing rule type that you want to delete.

A message appears confirming whether you want to delete the retention type enrollment based pricing rule type.

Note: You can delete a retention type enrollment based pricing rule type when it is not yet used in the system.

Tip: Alternatively, you can delete a retention type enrollment based pricing rule type by clicking the **Delete** button in the **Pricing Rule Type** zone.

5. Click **OK**.

The retention type enrollment based pricing rule type is deleted.

Related Topics

For more information on...	See...
Pricing Rule Type screen	Pricing Rule Type on page 2532
Pricing Rule Type List zone	Pricing Rule Type List on page 2533
Pricing Rule Type zone	Pricing Rule Type on page 2536

Viewing the Retention Type Enrollment Based Pricing Rule Type Details

Procedure

To view the details of a retention type enrollment based pricing rule type:

1. Click the **Admin** link in the **Application** toolbar.
A list appears.
2. From the **Admin** menu, select **P** and then click **Pricing Rule Type**.
A sub-menu appears.
3. Click the **Search** option from the **Pricing Rule Type** sub-menu.
The **Pricing Rule Type** screen appears.
4. In the **Pricing Rule Type List** zone, click the **Broadcast** () icon corresponding to the retention type enrollment based pricing rule type whose details you want to view.
The **Pricing Rule Type** zone appears.
5. View the details of the retention type enrollment based pricing rule type in the **Pricing Rule Type** zone.

Related Topics

For more information on...	See...
Pricing Rule Type screen	Pricing Rule Type on page 2532
Pricing Rule Type List zone	Pricing Rule Type List on page 2533
Pricing Rule Type zone	Pricing Rule Type on page 2536

Defining a Retention Type Enrollment Based Pricing Rule for a Parent Customer

Prerequisites

To define a retention type enrollment based pricing rule for a parent customer, you should have:

- Business Object **C1-PricingRule** defined for the pricing rule.
- Business Object **C1-PrcRuleTypRetEnrollBased** defined for retention type enrollment based pricing rule type.
- Algorithms **C1-APPTXNBAS** defined for retention type enrollment based pricing rule type.

Note: A custom algorithm type must be created to validate a transaction.

Procedure

To define a retention type enrollment based pricing rule for a parent customer:

1. Search for a parent customer in the **Customer 360° View** screen.
The **Search Result** screen appears.
2. In the **Search Results** section, click the **View** () icon corresponding to the parent customer whose pricing details you want to view.
The **Person** tab appears in the **Customer 360° Information** screen.
3. Click the **Pricing** tab.
The **Pricing** tab appears.
4. Click the **Add** link in the upper-right corner of the **Parent Customer Pricing Rules** zone.

The **Pricing Rule** screen appears. It contains the following fields:

Field Name	Field Description	Mandatory (Yes or No)
Person Name	Displays the person name.	Not applicable
Person Type	Displays the person type.	Not applicable
Pricing Rule Type	Used to indicate the pricing rule type. The valid values are: <ul style="list-style-type: none"> Retention Type Enrollment Based Pricing Rule 	Yes Note: If the pricing rule type is not selected then the application displays an error message.

- Select the required pricing rule type in the respective field.
- Click **OK**.

The **Retention Type Enrollment Based Pricing Rule** screen appears. It contains the following sections:

- Customer Information** - Displays information about the parent customer for whom you are defining the retention type enrollment based pricing rule. It contains the following fields:

Field Name	Field Description
Parent Customer Information	Indicates the parent customer for whom you are defining the retention type enrollment based pricing rule.
Pricing Rule Type	Indicates the pricing rule type using which you are defining the retention type enrollment based pricing rule.

- Main** - This section contains the following fields:

Field Name	Field Description	Mandatory (Yes or No)
Price Item	Used to indicate the price item for which you want to define the pricing. The valid value are: <ul style="list-style-type: none"> Administrative Services Fees Administrative Services Fees (No Mandatory Parameters) AS_RET_ENRB Consultant Oversight Fees 	Yes
Pricing Start Date	Used to specify the start date from when the pricing will be effective for the price item. Note: The pricing start date cannot be later than the pricing end date.	Yes (Conditional) Note: Pricing Start Date should be entered if Pricing End Date has been mentioned.
Pricing End Date	Used to specify the end date till when the retention type enrollment based pricing will be effective for the price item. Note: The pricing end date cannot be earlier than the pricing start date.	No

Field Name	Field Description	Mandatory (Yes or No)															
Rate Option	<p>Used to specify the rate option for the price item. The valid values are:</p> <ul style="list-style-type: none"> • Flat Dollar Per Claim - Agg Daily • Retention - Aggregate Monthly • Claims • Percentage of Claim - Agg Daily • Flat Dollar Per Claim - Agg Daily <p>On selecting an option from the Rate Option field, following fields appear in a grid:</p> <table border="1" data-bbox="558 642 1227 1969"> <thead> <tr> <th data-bbox="558 642 695 758">Field Name</th> <th data-bbox="695 642 1081 758">Field Description</th> <th data-bbox="1081 642 1227 758">Mandatory (Yes or No)</th> </tr> </thead> <tbody> <tr> <td data-bbox="558 758 695 905">Price Item Parameter</td> <td data-bbox="695 758 1081 905">Used to specify multiple price item parameters based on which you want to determine the price item utilization.</td> <td data-bbox="1081 758 1227 905">No</td> </tr> <tr> <td data-bbox="558 905 695 1367"></td> <td data-bbox="695 905 1081 1367" style="background-color: #f2f2f2;"> <p>Note:</p> <p>The Search (🔍) icon appears corresponding to the Price Item Parameter field. On clicking the Search icon, the Price Item Parameter Search screen appears.</p> <p>On specifying the price item, the description of the price item appears corresponding to the Price Item Parameter field.</p> </td> <td data-bbox="1081 905 1227 1367"></td> </tr> <tr> <td data-bbox="558 1367 695 1514">Parameter Value</td> <td data-bbox="695 1367 1081 1514">Used to specify multiple price item parameter values based on which you want to determine the price item utilization.</td> <td data-bbox="1081 1367 1227 1514">No</td> </tr> <tr> <td data-bbox="558 1514 695 1969"></td> <td data-bbox="695 1514 1081 1969" style="background-color: #f2f2f2;"> <p>Note:</p> <p>The Search (🔍) icon appears corresponding to the Parameter Value field. On clicking the Search icon, the Predefined Parameter Value Search screen appears.</p> <p>On specifying the price item, the description of the price item appears corresponding to the Parameter Value Search field.</p> </td> <td data-bbox="1081 1514 1227 1969"></td> </tr> </tbody> </table>	Field Name	Field Description	Mandatory (Yes or No)	Price Item Parameter	Used to specify multiple price item parameters based on which you want to determine the price item utilization.	No		<p>Note:</p> <p>The Search (🔍) icon appears corresponding to the Price Item Parameter field. On clicking the Search icon, the Price Item Parameter Search screen appears.</p> <p>On specifying the price item, the description of the price item appears corresponding to the Price Item Parameter field.</p>		Parameter Value	Used to specify multiple price item parameter values based on which you want to determine the price item utilization.	No		<p>Note:</p> <p>The Search (🔍) icon appears corresponding to the Parameter Value field. On clicking the Search icon, the Predefined Parameter Value Search screen appears.</p> <p>On specifying the price item, the description of the price item appears corresponding to the Parameter Value Search field.</p>		Yes
Field Name	Field Description	Mandatory (Yes or No)															
Price Item Parameter	Used to specify multiple price item parameters based on which you want to determine the price item utilization.	No															
	<p>Note:</p> <p>The Search (🔍) icon appears corresponding to the Price Item Parameter field. On clicking the Search icon, the Price Item Parameter Search screen appears.</p> <p>On specifying the price item, the description of the price item appears corresponding to the Price Item Parameter field.</p>																
Parameter Value	Used to specify multiple price item parameter values based on which you want to determine the price item utilization.	No															
	<p>Note:</p> <p>The Search (🔍) icon appears corresponding to the Parameter Value field. On clicking the Search icon, the Predefined Parameter Value Search screen appears.</p> <p>On specifying the price item, the description of the price item appears corresponding to the Parameter Value Search field.</p>																

Field Name	Field Description	Mandatory (Yes or No)
	<p>Note:</p> <p>If you want to define more than one price item parameter to the price item in a retention type enrollment based pricing rule type, click the Add (+) icon.</p> <p>However, if you want to remove a price item parameter from the price item in a retention type enrollment based pricing rule type, click the Delete (🗑) icon corresponding to the Price Item Parameter field.</p>	
Exempt Retro Transactions	Used to indicate that retro transactions should not be considered for calculation purposes.	No
Fee	Used to specify the fee for the price item parameter.	No

- **Characteristics** - Used to define the characteristics for the retention type enrollment based pricing rule for a parent customer.

7. Add the required details in the main and characteristics section.

8. Click **Save**.

The retention type enrollment based pricing rule for a parent customer is defined.

Note:

If the approval workflow group setting is set as **Active** for the parent customer, for whom the retention type enrollment based pricing rule is defined then an approval transaction is created for that particular parent customer. The retention type enrollment based pricing rule for a parent customer is defined, once the approval transaction is approved.

Related Topics

For more information on...	See...
How to define a characteristic for a retention type enrollment based pricing rule.	Defining a Characteristic for a Retention Type Enrollment Based Pricing Rule on page 2708

Defining a Characteristic for a Retention Type Enrollment Based Pricing Rule

Prerequisites

To define a characteristic for a retention type enrollment based pricing rule, you should have:

- Characteristic types defined in the application (where the characteristic entity is set to **Pricing Rule**)

Procedure

To define a characteristic for a retention type claim based pricing rule:

1. Ensure that the **Characteristics** section is expanded when you are defining or editing a retention type enrollment based pricing rule.

The **Characteristics** section contains the following columns in a grid:

Column Name	Column Description	Mandatory (Yes or No)
Effective Date	Used to specify from when the pricing rule will be effective.	Yes
Characteristic Type	Used to indicate the characteristic type. The valid values are: <ul style="list-style-type: none"> Eligible for Billing 	Yes (Conditional)
	Note: The list includes only those characteristic types where the characteristic entity is set to Pricing Rule Type .	Note: This field is required when you are defining a characteristic for retention type enrollment based pricing rule.
Characteristic Value	Used to specify the value for the characteristic type.	Yes (Conditional)
	Note: If you select a predefined characteristic type, the Search (🔍) icon appears corresponding to the Characteristic Value field. On clicking the Search icon, the Predefined Characteristic Search window appears. On specifying the value for a predefined characteristic type, the description of the characteristic value appears corresponding to the Characteristic Value field.	Note: This field is required when you are defining a characteristic for retention type enrollment based pricing rule.

- Enter the required details in the **Characteristics** section.
- If you want to define more than one characteristic for retention type enrollment based pricing rule, click the **Add** (+) icon and then repeat step 2.

Note: However, if you want to remove a characteristic from retention type enrollment based pricing rule, click the **Delete** (🗑️) icon corresponding to the characteristic.

- Click **Save**.

The characteristics are defined for the retention type enrollment based pricing rule.

Related Topics

For more information on...	See...
How to define a retention type enrollment based pricing rule for a parent customer	Defining a Retention Type Enrollment Based Pricing Rule for a Parent Customer on page 2705

Editing a Retention Type Enrollment Based Pricing Rule of a Parent Customer

Prerequisites

To edit a retention type enrollment based pricing rule of a parent customer, you should have:

- Business Object **C1-PricingRule** defined for the pricing rule.
- Business Object **C1-PrcRuleTypRetEnrollBased** defined for retention type enrollment based pricing rule type.
- Algorithms **C1-APPTXNBAS** defined for retention type enrollment based pricing rule type.

Note: A custom algorithm type must be created to validate a transaction.

Procedure

To edit a retention type enrollment based pricing rule of a parent customer:

1. Search for a parent customer in the **Customer 360° View** screen.
2. In the **Search Results** section, click the **View** () icon corresponding to the parent customer whose pricing details you want to view.

The **Person** tab appears in the **Customer 360° Information** screen.

3. Click the **Pricing** tab.

The **Pricing** tab appears.

4. In the **Parent Customer Pricing Rules** zone, click the **Edit** () icon in the **Edit** column corresponding to the retention type enrollment based pricing rule, whose details you want to edit.

The **Retention Type Enrollment Based Pricing Rule** screen appears. It contains the following zones:

- **Customer Information** - Displays the basic information about the customer. It contains the following fields:

Column Name	Column Description
Parent Customer Information	Displays the parent name.
Pricing Rule Type	Displays the pricing rule type that is chosen to define the retention type claim based pricing rule of a parent customer.

- **Main** - This section contains the following fields:

Field Name	Field Description	Mandatory (Yes or No)
Price Item	Indicates the price item for which you want to define the pricing.	Not applicable
Pricing Start Date	Used to specify the start date from when the pricing will be effective for the price item.	Yes (Conditional)
		Note: Pricing Start Date should be entered if Pricing End Date has been mentioned.
Pricing End Date	Used to specify the end date till when the pricing will be effective for the price item.	No
Rate Option	Indicates the rate option for the price item.	Not applicable
Exempt Retro Transactions	Used to indicate that retro transactions should not be considered for calculation purposes.	No
Price Item Parameter	Used to specify multiple price item parameters based on which you want to determine the price item utilization.	No
	Note: The Search () icon does appear corresponding to this field. On clicking the Search icon, the Price Item Parameters screen appears.	

Field Name	Field Description	Mandatory (Yes or No)
Parameter Value	Used to specify multiple price item parameter values based on which you want to determine the price item utilization.	No
	Note: The Search (🔍) icon does appear corresponding to this field. On clicking the Search icon, the Parameter Value Search screen appears.	
Fee	Indicates the fee for the price item parameter.	Not applicable

- **Characteristics** - Used to define the characteristics for the Retention Type Enrollment based pricing rule for parent customer. It contains the following fields:

Field Name	Field Description	Mandatory (Yes or No)
Effective Date	Used to specify the effective date from when the characteristic is effective for the retention type enrollment based pricing rule of a parent customer.	No
Characteristic Type	Used to indicate the characteristic type for the retention type enrollment based pricing rule of a parent customer. The valid values are: <ul style="list-style-type: none"> • Eligible for Billing 	No
Characteristic Value	Used to specify the characteristic value for the retention type enrollment based pricing rule of a parent customer.	No
	Note: If you select a predefined characteristic type, the Search (🔍) icon appears corresponding to the Characteristic Value field. On clicking the Search icon, the Predefined Characteristic Search window appears. On specifying the value for a predefined characteristic type, the description of the characteristic value appears corresponding to the Characteristic Value field.	

5. Click **Save**.

Note:

If the approval workflow group setting is set as **Active** for the parent customer, for which the retention type enrollment based pricing rule is defined then an approval transaction is created for that particular parent customer. The retention type enrollment based pricing rule for a parent customer is defined, once the approval transaction is approved.

6. Click **OK**

The retention type enrollment based pricing rule of a parent customer is edited.

Related Topics

For more information on...	See...
Customer 360° Information – Pricing tab	Customer 360° Information - Pricing Information on page 693
Parent Customer Pricing Rules zone	Parent Customer Pricing Rules on page 696

For more information on...	See...
How to search for a parent customer	Searching for a Person on page 648
How to define the characteristics for a retention type enrollment based pricing rule	Defining a Characteristic for a Retention Type Enrollment Based Pricing Rule on page 2708

Deleting a Retention Type Enrollment Based Pricing Rule of a Parent Customer

Procedure

To delete a retention type enrollment based pricing rule of a parent customer:

1. Search for a parent customer in the **Customer 360° View** screen.
2. In the **Search Results** section, click the **View** () icon corresponding to the parent customer whose pricing details you want to view.

The **Person** tab in the **Customer 360° Information** screen appears.

3. Click the **Pricing** tab.

The **Pricing** tab appears.

4. In the **Parent Customer Pricing Rules** zone, click the **Delete** () icon in the **Delete** column corresponding to the retention type enrollment based pricing rule that you want to delete.

A message appears confirming whether you want to delete the retention type enrollment based pricing rule.

Note: You can delete a retention type enrollment based pricing rule when it is not yet used in the system.

5. Click **OK**.

The retention type enrollment based pricing rule of a parent customer is deleted.

Related Topics

For more information on...	See...
How to search for a parent customer	Searching for a Person on page 648
Parent Customer Pricing Rules zone	Parent Customer Pricing Rules on page 696

Defining a Retention Type Enrollment Based Pricing Rule for a Bill Group

Prerequisites

To define a retention type enrollment based pricing rule for a bill group, you should have:

- Business Object **C1-PricingRule** and **C1-PricingRuleType**, and **C1-PricingGroup** defined for the pricing rule.
- Business Object **C1-PolicyBOStatusReason** defined for the policy status.
- Business Object **C1-PrcRuleTypRetEnrollBased** defined for retention type enrollment based pricing rule type.
- Algorithms **C1-APPTXNBAS** defined for retention type enrollment based pricing rule type.

Note: A custom algorithm type must be created to validate a transaction.

Procedure

To define a retention type enrollment based pricing rule for a bill group:

1. Search for the Administrative Services Only (ASO) person, whose person type is set to **Bill Group**, in the **Customer 360° View** screen.

- In the **Search Results** section, click the **View** (🔗) icon corresponding to the person whose pricing details you want to view.

The **Person** tab appears in the **Customer 360° Information** screen.

- Click the **Pricing** tab.

The **Pricing** tab appears.

- Click the **Broadcast** (📡) icon in the **Bill Group ASO Policy Information** zone, corresponding to the **Bill Group Information** column, whose bill group details you want to view.

The **Bill Group ASO Policy Pricing Rules** zone is displayed.

- Click the **Add** link in the upper right corner of the **Bill Group ASO Policy Pricing Rules** zone.

The **Pricing Rule** screen appears. It contains the following fields:

Field Name	Field Description	Mandatory (Yes or No)
Person Name	Indicates the name of the parent customer.	Not applicable
Person Type	Indicates the type of the parent customer. Note: If you are defining the pricing rule type for the parent customer, then the person type will be Parent Customer .	Not applicable
Pricing Rule Type	Used to indicate the pricing rule type using which you want to create a retention type enrollment based pricing rule. Note: Select the Retention Type Enrollment Based Pricing Rule option, as the pricing rule type.	Yes Note: If the pricing rule type is not selected then the application displays an error message.
Pricing Group	Used to indicate the pricing group for the bill group. Note: Select the pricing group option when the retention type enrollment based pricing rule has to be defined for a bill group using the pricing group.	No
Policy Status	Used to indicate the policy status for the bill group. The valid values are: <ul style="list-style-type: none"> In Force/Active Post Runout Runout 	Yes (Conditional) Note: Policy Status is required once the Pricing Rule Type is selected.

- Select the appropriate fields in the **Main** section.

- Click **OK**.

The **Retention Type Enrollment Based Pricing Rule** screen appears. It contains the following sections:

- Main** - This section contains the following fields:

Field Name	Field Description	Mandatory (Yes or No)
Price Item	Used to indicate the price item for which you want to define the pricing. The valid value are: <ul style="list-style-type: none"> Administrative Services Fees Administrative Services Fees (No Mandatory Parameters) AS_RET_ENRB Consultant Oversight Fees 	Yes
Pricing Start Date	Used to specify the start date from when the pricing will be effective for the price item.	Yes (Conditional) Note: Pricing Start Date should be entered if Pricing End Date has been mentioned.
Pricing End Date	Used to specify the end date till when the pricing will be effective for the price item. Note: If the pricing end date is mentioned, once the price parameters and fees have been already entered, then the price parameter value and fee field values are reset.	No
Rate Option	Used to specify the rate option for the price item. The valid values are: <ul style="list-style-type: none"> Flat Dollar Per Claim - Agg Daily Retention - Aggregate Monthly Claims Percentage of Claim - Agg Daily Flat Dollar Per Claim - Agg Daily 	Yes
Exempt Retro Transactions	Used to indicate that retro transactions should not be considered for calculation purposes.	No
Pricing Group Rule Code	Displays the name of the pricing group rule code. Note: If a particular bill group has a single or multiple pricing group rule codes then all of those pricing group rule codes are shown along with their respective description.	No
Price Item Parameter	Used to specify multiple price item parameters based on which you want to determine the price item utilization. Note: The Search (🔍) icon does appear corresponding to this field. On clicking the Search icon, the Price Item Parameters screen appears.	No

Field Name	Field Description	Mandatory (Yes or No)
Parameter Value	Used to specify multiple price item parameter values based on which you want to determine the price item utilization.	No
	Note: The Search (🔍) icon does appear corresponding to this field. On clicking the Search icon, the Parameter Value Search screen appears.	
Fee	Used to specify the fee for the price item parameter.	No

- **Characteristics** - Used to define the characteristics for the retention type enrollment based pricing rule for a bill group.

8. Add the required details in the main and characteristics section.

9. Click **Save**.

The retention type enrollment based pricing rule for a bill group is defined.

Note:

If the approval workflow group setting is set as **Active** for the bill group, for which the retention type enrollment based pricing rule is defined then an approval transaction is created for that particular bill group. The retention type enrollment based pricing rule for a bill group is defined, once the approval transaction is approved.

Related Topics

For more information on...	See...
How to define a characteristic for a retention type enrollment based pricing rule for a bill group.	Defining a Characteristic for a Retention Type Enrollment Based Pricing Rule on page 2715

Defining a Characteristic for a Retention Type Enrollment Based Pricing Rule

Prerequisites

To define a characteristic for a retention type enrollment based pricing rule, you should have:

- Characteristic types defined in the application (where the characteristic entity is set to **Pricing Rule**)

Procedure

To define a characteristic for a retention type enrollment based pricing rule:

1. Ensure that the **Characteristics** section is expanded when you are defining or editing a retention type claim based pricing rule.

The **Characteristics** section contains the following columns in a grid:

Column Name	Column Description	Mandatory (Yes or No)
Effective Date	Used to specify from when the pricing rule will be effective.	Yes

Column Name	Column Description	Mandatory (Yes or No)
Characteristic Type	Used to indicate the characteristic type. The valid values are: <ul style="list-style-type: none"> Eligible for Billing 	Yes (Conditional)
	Note: The list includes only those characteristic types where the characteristic entity is set to Pricing Rule Type .	Note: This field is required when you are defining a characteristic for retention type enrollment based pricing rule.
Characteristic Value	Used to specify the value for the characteristic type.	Yes (Conditional)
	Note: If you select a predefined characteristic type, the Search (🔍) icon appears corresponding to the Characteristic Value field. On clicking the Search icon, the Predefined Characteristic Search window appears. On specifying the value for a predefined characteristic type, the description of the characteristic value appears corresponding to the Characteristic Value field.	Note: This field is required when you are defining a characteristic for retention type enrollment based pricing rule.

- Enter the required details in the **Characteristics** section.
- If you want to define more than one characteristic for retention type enrollment based pricing rule, click the **Add** (+) icon and then repeat step 2.

Note: However, if you want to remove a characteristic from retention type enrollment based pricing rule, click the **Delete** (🗑️) icon corresponding to the characteristic.

- Click **Save**.

The characteristics are defined for the retention type enrollment based pricing rule.

Related Topics

For more information on...	See...
How to define a retention type enrollment based pricing rule for a bill group	Defining a Retention Type Enrollment Based Pricing Rule for a Bill Group on page 2712

Editing a Retention Type Enrollment Based Pricing Rule of a Bill Group

Prerequisites

To edit a retention type enrollment based pricing rule of a bill group, you should have:

- Business Object **C1-PricingRule** defined for the pricing rule.
- Business Object **C1-PrcRuleTypRetEnrollBased** defined for retention type enrollment based pricing rule type.
- Algorithms **C1-APPTXNBAS** defined for retention type enrollment based pricing rule type.

Note: A custom algorithm type must be created to validate a transaction.

Procedure

To edit a retention type enrollment based pricing rule of a bill group:

- Search for a bill group in the **Customer 360° View** screen.

- In the **Search Results** section, click the **View** (🔗) icon corresponding to the bill group whose pricing details you want to view.

The **Person** tab appears in the **Customer 360° Information** screen.

- Click the **Pricing** tab.

The **Pricing** tab appears.

- Click the **Broadcast** (📡) icon in the **Bill Group ASO Policy Information** zone, corresponding to the **Bill Group Information** column, whose bill group details you want to view.

The **Bill Group ASO Policy Pricing Rules** zone appears.

- Click the **Edit** (✎) icon in the **Bill Group ASO Policy Pricing Rules** zone, corresponding to the **Pricing Rule Type** column, whose details you want to edit.

The **Retention Type Enrollment Based Pricing Rule** screen appears. It contains the following zones:

- Customer Information** - Displays the basic information about the customer. It contains the following fields:

Column Name	Column Description
Bill Group Information	Displays the bill group name.
Policy Start Date	Displays the date from when the policy is effective.
Policy End Date	Displays the date till when the policy is effective.
Policy Status	Displays the status of the policy.
Pricing Group	Displays the pricing group information.
Pricing Rule Type	Displays the pricing rule type that is chosen to define the retention type claim based pricing rule of a bill group.

- Main** - This section contains the following fields:

Field Name	Field Description	Mandatory (Yes or No)
Price Item	Indicates the price item for which you want to define the pricing.	Not applicable
Pricing Start Date	Used to specify the start date from when the pricing will be effective for the price item.	Yes (Conditional) Note: Pricing Start Date should be entered if Pricing End Date has been mentioned.
Pricing End Date	Used to specify the end date till when the pricing will be effective for the price item.	No
Rate Option	Indicates the rate option for the price item.	Not applicable
Exempt Retro Transactions	Used to indicate that retro transactions should not be considered for calculation purposes.	No

Field Name	Field Description	Mandatory (Yes or No)
Pricing Group Rule Code	Displays the name of the pricing group rule code.	Not applicable
	Note: If a particular bill group has a single or multiple pricing group rule codes then all of those pricing group rule codes are shown along with their respective description.	
Price Item Parameter	Used to specify multiple price item parameters based on which you want to determine the price item utilization.	No
	Note: The Search (🔍) icon does appear corresponding to this field. On clicking the Search icon, the Price Item Parameters screen appears.	
Parameter Value	Used to specify multiple price item parameter values based on which you want to determine the price item utilization.	No
	Note: The Search (🔍) icon does appear corresponding to this field. On clicking the Search icon, the Parameter Value Search screen appears.	
Fee	Indicates the fee for the price item parameter.	Not applicable

Note: If you want to define more than one price item parameter information, click the **Add (+)** icon. However, if you want to remove more than one price item or price item bundle, click the **Delete (🗑)** icon corresponding to the price item parameter.

- **Characteristics** - Used to define the characteristics for the retention type claim based pricing rule for parent customer. It contains the following fields:

Field Name	Field Description	Mandatory (Yes or No)
Effective Date	Used to specify the effective date from when the characteristic is effective for the retention type claim based pricing rule of a bill group.	No
Characteristic Type	Used to indicate the characteristic type for the retention type claim based pricing rule of a bill group. The valid values are: <ul style="list-style-type: none"> • Eligible for Billing 	No

Field Name	Field Description	Mandatory (Yes or No)
Characteristic Value	Used to specify the characteristic value for the retention type claim based pricing rule of a bill group. Note: If you select a predefined characteristic type, the Search (🔍) icon appears corresponding to the Characteristic Value field. On clicking the Search icon, the Predefined Characteristic Search window appears. On specifying the value for a predefined characteristic type, the description of the characteristic value appears corresponding to the Characteristic Value field.	No

Note: If you want to define more than one characteristic, click the **Add** (+) icon. However, if you want to remove more than one characteristic, click the **Delete** (🗑️) icon corresponding to the characteristic.

6. Click **Save**.

Note:

If the approval workflow group setting is set as **Active** for the bill group, for which the retention type enrollment based pricing rule is defined then an approval transaction is created for that particular bill group. The retention type enrollment based pricing rule for a bill group is defined, once the approval transaction is approved.

7. Click **OK**

The retention type enrollment based pricing rule of a bill group is edited.

Related Topics

For more information on...	See...
How to define a retention type enrollment based pricing rule of a parent customer	Defining a Retention Type Enrollment Based Pricing Rule for a Parent Customer on page 2705

Deleting a Retention Type Enrollment Based Pricing Rule of a Bill Group

Procedure

To delete a retention type enrollment based pricing rule of a bill group:

1. Search for the Administrative Services Only (ASO) person, whose person type is set to **Bill Group**, in the **Customer 360° View** screen.
2. In the **Search Results** section, click the **View** (🔗) icon corresponding to the person whose pricing details you want to view.
The **Person** tab appears in the **Customer 360° Information** screen.
3. Click the **Pricing** tab.
The **Pricing** tab appears.
4. Click the **Broadcast** (📡) icon in the **Bill Group ASO Policy Information** zone, corresponding to the **Bill Group Information** column, whose bill group details you want to view.
The **Bill Group ASO Policy Pricing Rules** zone appears.

- Click the **Delete** (🗑️) icon in the **Bill Group ASO Policy Pricing Rules** zone, corresponding to the **Pricing Rule Type** column, whose details you want to edit.

A message appears confirming whether you want to delete the retention type enrollment based pricing rule of a bill group.

- Click **OK**.

The retention type enrollment based pricing rule of a bill group is deleted.

Related Topics

For more information on...	See...
How to define retention type enrollment based pricing rule for a bill group	Defining a Retention Type Enrollment Based Pricing Rule for a Bill Group on page 2712

Defining a Retention Type Enrollment Based Pricing Rule for a Bill Group Using a Pricing Group

Procedure

To define a retention type enrollment based pricing rule for a bill group using pricing group:

- Search for the Administrative Services Only (ASO) person, whose person type is set to **Bill Group**, in the **Customer 360° View** screen.
- In the **Search Results** section, click the **View** (🔗) icon corresponding to the person whose pricing details you want to view.

The **Person** tab appears in the **Customer 360° Information** screen.

- Click the **Pricing** tab.

The **Pricing** tab appears.

- Click the **Broadcast** (📡) icon in the **Bill Group ASO Policy Information** zone, corresponding to the **Bill Group Information** column, whose bill group details you want to view.

The **Bill Group ASO Policy Pricing Rules** zone is displayed.

- Click the **Add** link in the upper right corner of the **Bill Group ASO Policy Pricing Rules** zone.

The **Pricing Rule** screen appears. It contains the following sections:

- Main** - This section contains the following fields:

Field Name	Field Description	Mandatory (Yes or No)
Person Name	Displays the person name.	Not applicable
Person Type	Displays the person type.	Not applicable

Field Name	Field Description	Mandatory (Yes or No)
Pricing Rule Type	Used to indicate the pricing rule type. The valid values are: <ul style="list-style-type: none"> Aggregate Stop-Loss (ASL) Pricing Rule Claim Pricing Rule Discount Arrangement Pricing Rule Retention Type Claim Based Pricing Rule Retention Type Enrollment Based Pricing Rule Specific Stop-Loss (SSL) Pricing Rule 	Yes
	Note: Select the Retention Type Enrollment Based Pricing Rule option, as the pricing rule type.	Note: If the pricing rule type is not selected then the application displays an error message.
Pricing Group	Used to indicate the pricing group for the bill group.	Yes
	Note: You must select a pricing group for the bill group on which a retention type enrollment based pricing rule is to be defined.	
Policy Status	Used to indicate the policy status for the bill group. The valid values are: <ul style="list-style-type: none"> In Force/Active Post Runout Runout 	Yes (Conditional)
		Note: Policy Status is required once the Pricing Rule Type is selected.

6. Select the appropriate fields in the **Main** section.

7. Click **OK**.

The **Retention Type Enrollment Based Pricing Rule** screen appears. It contains the following sections:

- Main** - This section contains the following fields:

Field Name	Field Description	Mandatory (Yes or No)
Price Item	Used to indicate the price item for which you want to define the pricing. The valid value are: <ul style="list-style-type: none"> Administrative Services Fees Administrative Services Fees (No Mandatory Parameters) AS_RET_ENRB Consultant Oversight Fees 	Yes
Pricing Start Date	Used to specify the start date from when the pricing will be effective for the price item.	Yes (Conditional)
		Note: Pricing Start Date should be entered if Pricing End Date has been mentioned.

Field Name	Field Description	Mandatory (Yes or No)
Pricing End Date	Used to specify the end date till when the pricing will be effective for the price item.	No
	Note: If the pricing end date is mentioned, once the price parameters and fees have been already entered, then the price parameter value and fee field values are reset.	
Rate Option	Used to specify the rate option for the price item. The valid values are: <ul style="list-style-type: none"> • Flat Dollar Per Claim - Agg Daily • Retention - Aggregate Monthly • Claims • Percentage of Claim - Agg Daily • Flat Dollar Per Claim - Agg Daily 	Yes
Exempt Retro Transactions	Used to indicate that retro transactions should not be considered for calculation purposes.	No
Pricing Group Rule Code	Displays the code of the pricing group rule.	Not applicable
Description	Displays the description of the pricing group rule.	Not applicable
Price Item Parameter	Used to specify multiple price item parameters based on which you want to determine the price item utilization.	No
	Note: The Search (🔍) icon does appear corresponding to this field. On clicking the Search icon, the Price Item Parameters screen appears.	
Parameter Value	Used to specify multiple price item parameter values based on which you want to determine the price item utilization.	No
	Note: The Search (🔍) icon does appear corresponding to this field. On clicking the Search icon, the Parameter Value Search screen appears.	
Fee	Used to specify the fee for the price item parameter.	No

Note: If you want to define more than one price item parameter information, click the **Add (+)** icon. However, if you want to remove more than one price item or price item bundle, click the **Delete (🗑)** icon corresponding to the price item parameter.

- **Characteristics** - Used to define the characteristics for the Retention Type Enrollment Based Pricing Rule for a Bill Group Using a Pricing Group.

8. Add the required details in the main and characteristics section.

9. Click **Save**.

The retention type claim based pricing rule for a bill group using a pricing group is defined.

If the approval workflow group setting is set as **Active** for the bill group, for which the retention type enrollment based pricing rule is defined then an approval transaction is created for that particular bill group. The retention type enrollment based pricing rule for a bill group using a pricing group is defined, once the approval transaction is approved.

Related Topics

For more information on...	See...
How to define a characteristic for a retention type enrollment based pricing rule for a bill group using pricing group.	Defining a Characteristic for a Retention Type Enrollment Based Pricing Rule for a Bill Group Using a Pricing Group on page 2723

Defining a Characteristic for a Retention Type Enrollment Based Pricing Rule for a Bill Group Using a Pricing Group

Prerequisites

To define a characteristic for a retention type enrollment based pricing rule for a bill group using a pricing group, you should have:

- Characteristic types defined in the application (where the characteristic entity is set to **Pricing Rule**)

Procedure

To define a characteristic for a retention type enrollment based pricing rule for a bill group using a pricing group:

1. Ensure that the **Characteristics** section is expanded when you are defining or editing a retention type claim based pricing rule for a bill group using a pricing group.

The **Characteristics** section contains the following columns in a grid:

Column Name	Column Description	Mandatory (Yes or No)
Effective Date	Used to specify from when the pricing rule will be effective.	Yes
Characteristic Type	Used to indicate the characteristic type. The valid values are: <ul style="list-style-type: none"> • Eligible for Billing 	Yes (Conditional) Note: This field is required when you are defining a characteristic for retention type enrollment based pricing rule for a bill group using a pricing group.
	Note: The list includes only those characteristic types where the characteristic entity is set to Pricing Rule Type .	
Characteristic Value	Used to specify the value for the characteristic type.	Yes (Conditional) Note: This field is required when you are defining a characteristic for retention type enrollment based pricing rule for a bill group using a pricing group.
	Note: If you select a predefined characteristic type, the Search (🔍) icon appears corresponding to the Characteristic Value field. On clicking the Search icon, the Predefined Characteristic Search window appears. On specifying the value for a predefined characteristic type, the description of the characteristic value appears corresponding to the Characteristic Value field.	

2. Enter the required details in the **Characteristics** section.
3. If you want to define more than one characteristic, click the **Add (+)** icon and then repeat step 2.

Note: However, if you want to remove a characteristic, click the **Delete (🗑)** icon corresponding to the characteristic.

4. Click **Save**.

The characteristics are defined for the retention type enrollment based pricing rule for a bill group using a pricing group.

Related Topics

For more information on...	See...
How to define a retention type enrollment based pricing rule for a bill group using a pricing group.	Defining a Retention Type Enrollment Based Pricing Rule for a Bill Group Using a Pricing Group on page 2720

Viewing a Retention Type Enrollment Based Pricing Rule of a Parent Customer

Procedure

To view a retention type enrollment based pricing rule for a parent customer:

1. Search for a parent customer whose pricing details you want to view in the **Customer 360° View** screen.
2. In the **Search Results** section, click the **View (🔗)** icon corresponding to the parent customer whose pricing details you want to view.

The **Person** tab appears in the **Customer 360° Information** screen.

3. Click the **Pricing** tab.

The **Pricing** tab appears.

4. In the **Parent Customer Pricing Rules** zone, click the link in the **Pricing Rule Information** column corresponding to the pricing rule type whose details you want to view.

The **Pricing Rule** screen appears. It contains the following zone:

- **Retention Type Enrollment Based** – Displays Retention Type Enrollment Based Pricing Rule of a Parent. It contains the following sections:
 - **Main** – Displays the basic details of the retention type enrollment based pricing rule of a parent customer.
 - **Price Item Parameters** – Displays the price item parameters defined for the retention type enrollment based pricing rule of a parent customer.
 - **Characteristics** – Displays the characteristics defined for the retention type enrollment based pricing rule of a parent customer.
- 5. View the basic details of a retention type enrollment based pricing rule of a parent customer in the **Main** section.
- 6. View the price item parameters of a retention type enrollment based pricing rule of a parent customer in the **Price Item Parameters** section.
- 7. View the characteristics of a retention type enrollment based pricing rule of a parent customer in the **Characteristics** section.

Related Topics

For more information on...	See...
Customer 360° Information – Pricing tab	Customer 360° Information - Pricing Information on page 693

Viewing a Retention Type Enrollment Based Pricing Rule of a Bill Group

Procedure

To view a retention type enrollment based pricing rule of a bill group:

1. Search for a bill group in the **Customer 360° View** screen.
2. In the **Search Results** section, click the **View** (🔗) icon corresponding to the bill group whose pricing details you want to view.
The **Person** tab appears in the **Customer 360° Information** screen.
3. Click the **Pricing** tab.
The **Pricing** tab appears.
4. Click the **Broadcast** (📡) icon in the **Bill Group ASO Policy Information** zone, corresponding to the **Bill Group Information** column, whose bill group details you want to view.
The **Bill Group ASO Policy Pricing Rules** zone appears.
5. In the **Bill Group ASO Policy Pricing Rules** zone, click the link in the **Pricing Rule Information** column corresponding to the pricing rule type whose details you want to view.

The **Pricing Rule** screen appears. It contains the following zone:

- **Retention Type Enrollment Based** – Displays Retention Type Enrollment Based Pricing Rule of a Bill Group. It contains the following sections:
 - **Main** – Displays the basic details of the retention type enrollment based pricing rule of a bill group.
 - **Price Item Parameters** – Displays the price item parameters defined for the retention type enrollment based pricing rule of a bill group.
 - **Characteristics** – Displays the characteristics defined for the retention type enrollment based pricing rule of a bill group.
- 6. View the basic details of a retention type enrollment based pricing rule of a bill group in the **Main** section.
- 7. View the price item parameters of a retention type enrollment based pricing rule of a bill group in the **Price Item Parameters** section.
- 8. View the characteristics of a retention type enrollment based pricing rule of a bill group in the **Characteristics** section.

Related Topics

For more information on...	See...
Customer 360° Information – Pricing tab	Customer 360° Information - Pricing Information on page 693

Flat Fee Pricing

The Administrative Services Only (ASO) provider would like to charge one-time or recurring flat fee to the self-funded employer. Oracle Revenue Management and Billing enables you to process and bill such one-time and recurring charges to the bill group. The system enables you to define one-time or recurring flat fee for a price item. You can define recurring

flat fee based on bill period or frequency. The one-time flat fee, bill period based recurring flat fee, and frequency based recurring flat fee can be defined using the respective flat fee pricing rules. You can only define one-time flat fee, bill period based recurring flat fee, and frequency based recurring flat fee pricing rules for a bill group.

You can define the flat fee pricing rules for bill groups from the **Customer 360° Information** screen. You can define a one-time flat fee, bill period based recurring flat fee, and frequency based recurring flat fee pricing rule using the respective flat fee pricing rule type. It is the flat fee pricing rule type which helps the system to determine:

- Business object using which the flat fee pricing rule should be created in the system.

Note: You must not select the **Primary** option while defining a one-time flat fee, bill period based recurring flat fee, and frequency based recurring flat fee pricing rule type.

- Price items for which you can define the flat fee pricing rules.
- Rate options that you can use while defining the pricing for the price item.
- Different type of account to which a price item should be billed based on the specified priority.
- Rule type which indicates the rules that should be executed to determine whether the price item is eligible for billing.
- Additional flat fee specific data, such as:
 - Bill segment cancel reason which you want to use when the one-time or recurring flat fee bill segment is canceled due to change in the flat fee amount.
 - Whether the pricing rule type is defined for one-time flat fee or recurring flat fee.
 - Recurring method which indicates that the system should create recurring flat fee charge based on bill period or frequency. This information is required when you are defining a recurring flat fee pricing rule type.
 - Bill period that you can use while defining a bill period based recurring flat fee pricing rule. This information is required when you are defining a bill period based recurring flat fee pricing rule type.

Once a one-time flat fee pricing rule type is defined, you can define one-time flat fee pricing rules using the one-time flat fee pricing rule type. While defining a one-time flat fee pricing rule for a bill group, you need to specify the following:

- The policy status in which the one-time flat fee pricing rule is applicable. Note that you cannot define a one-time flat fee pricing rule for the post runout period of the policy.
- Price item for which you want to create the one-time flat fee billable charge.
- Date which you want to specify as the start and end dates in the one-time flat fee billable charge.
- Billable charge line type using which you want to create the one-time flat fee billable charge.
- Bill after date which you want to stamp on the one-time flat fee billable charge.
- Flat fee amount for which you want to create the one-time flat fee billable charge.
- Override account when you want to create the one-time flat fee billable charge on a particular account. If you do not specify the bill to override account, the system will derive the account using the priority defined for the price item in the one-time flat fee pricing rule type.

Once a bill period based recurring flat fee pricing rule type is defined, you can define bill period based recurring flat fee pricing rules using the bill period based recurring flat fee pricing rule type. While defining a bill period based recurring flat fee pricing rule for a bill group, you need to specify the following:

- The policy status in which the bill period based recurring flat fee pricing rule is applicable. Note that you cannot define a bill period based recurring flat fee pricing rule for the post runout period of the policy.
- Price item for which you want to create the bill period based recurring flat fee billable charge.
- Dates which you want to specify as the start and end dates in the bill period based recurring flat fee billable charge.
- Billable charge line type using which you want to create the bill period based recurring flat fee billable charge.

- Bill period using which the recurring bill segments should be created in the system.
- Flat fee amount for which you want to create the bill period based recurring flat fee billable charge.
- Override account when you want to create the bill period based recurring flat fee billable charge on a particular account. If you do not specify the bill to override account, the system will derive the account using the priority defined for the price item in the bill period based recurring flat fee pricing rule type.

Once a frequency based recurring flat fee pricing rule type is defined, you can define frequency based recurring flat fee pricing rules using the frequency based recurring flat fee pricing rule type. While defining a frequency based recurring flat fee pricing rule for a bill group, you need to specify the following:

- The policy status in which the frequency based recurring flat fee pricing rule is applicable. Note that you cannot define a frequency based recurring flat fee pricing rule for the post runout period of the policy.
- Price item for which you want to create the frequency based recurring flat fee billable charge.
- Dates which you want to specify as the start and end dates in the frequency based recurring flat fee billable charge.
- Billable charge line type using which you want to create the frequency based recurring flat fee billable charge.
- Frequency using which the recurring bill segments should be created in the system.
- Flat fee amount for which you want to create the frequency based recurring flat fee billable charge.
- Override account when you want to create the frequency based recurring flat fee billable charge on a particular account. If you do not specify the bill to override account, the system will derive the account using the priority defined for the price item in the frequency based recurring flat fee pricing rule type.

Once a one-time flat fee, bill period based recurring flat fee, or frequency based recurring flat fee pricing rule is defined for a bill group, the system creates the one-time or recurring flat fee billable charge, respectively. The system does not create any price assignment, price list, or price list assignment in case of flat fee pricing.

Defining a One-Time Flat Fee Pricing Rule Type

Prerequisites

To define a one-time flat fee pricing rule type, you should have:

- Business Object **C1-PricingRuleTypeFlatFees** defined for pricing rule type.
- Business Object **C1-PricingRuleFlatFees** defined for pricing rule.
- Pricing rule type category for flat fees defined in the application.

Procedure

To define a one-time flat fee pricing rule type:

1. Click the **Admin** link in the **Application** toolbar.
A list appears.
2. From the **Admin** menu, select **P** and then click **Pricing Rule Type**.
A sub-menu appears.
3. Click the **Add** option from the **Pricing Rule Type** sub-menu.
The **Select Business Object** screen appears. It contains the following field:

Field Name	Field Description	Mandatory (Yes or No)
Pricing Rule Type Business Object	Used to indicate the business object using which you want to create the pricing rule type.	Yes
	Note: You can create a one-time flat fee pricing rule type using the Flat Fee Pricing Rule Type business object.	

Tip: Alternatively, you can access this screen by clicking the **Add** button in the **Page Title** area of the **Pricing Rule Type** screen.

4. Select the **Flat Fee Pricing Rule Type** business object.
5. Click **OK**.

The **Flat Fee Pricing Rule Type** screen appears. It contains the following sections:

- **Main** – Used to specify basic details about the flat fee pricing rule type.
- **Related Pricing Rule Types** – Used to define the pricing rule types which are related to the parent pricing rule type.
- **Transaction Field Mapping** – Used to specify the transaction related data mapped to the pricing rule type
- **Algorithms** – Used to define the algorithms used for the pricing rule type.
- **Additional Data** – Used to specify the additional information about the pricing rule type.
- **Price Items** – Used to define the price items assigned to the pricing rule type.
- **Price Item Parameters** – Used to define the price item parameters in the pricing rule type.
- **Characteristics** – Used to define the characteristics for the pricing rule type.
- **Billable Charge Line Types** – Used to define the pricing rule type for billable charge line type.
- **Flat Fees - Specific Additional Data** – Used to specify the flat fees specific for additional data.

The **Main** section contains the following fields:

Field Name	Field Description	Mandatory (Yes or No)
Pricing Rule Type	Used to specify the pricing rule type.	Yes
Description	Used to specify the description for the pricing rule type.	Yes
Detailed Description	Used to specify additional information about the pricing rule type.	No
Pricing Rule Business Object	Used to indicate the pricing rule business object. The valid values are: <ul style="list-style-type: none"> • Claim Pricing Rule • Aggregate Stop-Loss (ASL) Pricing Rule • Specific Stop-Loss (SSL) Pricing Rule • Retention Type Claim Based Pricing Rule • Retention Type Enrollment Based Pricing Rule • Flat Fee Pricing Rule 	Yes

Field Name	Field Description	Mandatory (Yes or No)
Business Object	Indicates the pricing rule type business object for flat fees.	Not applicable
Status	Used to indicate the status of the pricing rule type. The valid values are: <ul style="list-style-type: none"> Active Inactive 	Yes
Primary	Used to select the checkbox if the pricing rule type is primary.	No
	Note: This field is not enabled for selection if the Pricing Rule Type Category is Flat Fees .	
Pricing Rule Type Category	Used to indicate the pricing rule type category for the pricing rule type. The valid values are: <ul style="list-style-type: none"> Claim Aggregate Stop-Loss Specific Stop-Loss Retention Type Claim Based Retention Type Enrollment Based Flat Fees 	Yes

- Enter the required details in the **Main** section.
- Add the related pricing rule types in the primary pricing rule type, if required.

Note:

Related Pricing Rule Types section appears when the pricing rule type is primary. This section does not appear when the **Pricing Rule Type Category** is **Flat Fees**.

- Define the transaction field mapping in the primary pricing rule type, if required.

Note:

Transaction Field Mapping section appears when the pricing rule type is primary. This section does not appear when the **Pricing Rule Type Category** is **Flat Fees**.

- Associate algorithms with the pricing rule type, if required.
- Define additional data for the pricing rule type, if required.

Note: This section does not appear when the **Pricing Rule Type Category** is **Flat Fees**.

- Add pricing items in the pricing rule type, if required.
- Add price item parameters in the pricing rule type, if required.
- Define characteristics for the pricing rule type, if required.
- Define billable charge line types in the flat fees pricing rule type, if required.
- Add the flat fees - specific additional data in the pricing rule type, if required.

Note: This section appears when the **Business Object** is **Flat Fees Pricing Rule Type**.

16. Click Save.

The one-time flat fee pricing rule type is defined.

Related Topics

For more information on...	See...
Pricing Rule Type screen	Pricing Rule Type on page 2532
How to add the related pricing rule types in the primary pricing rule type	Adding Related Pricing Rule Types in a Primary Pricing Rule Type on page 2549
How to define the transaction field mapping in the primary pricing rule type	Defining Transaction Field Mapping in a Primary Pricing Rule Type on page 2551
How to associate algorithms with the pricing rule type	Associating Algorithms with a Pricing Rule Type on page 2557
How to define additional data for the pricing rule type	Defining Additional Data for a Pricing Rule Type on page 2559
How to add pricing items in the pricing rule type	Adding Price Items in a Pricing Rule Type on page 2561
How to add price item parameters in the pricing rule type	Adding a Price Item Parameter in a Pricing Rule Type on page 2564
How to define a characteristic for the pricing rule type	Defining a Characteristic for a Pricing Rule Type on page 2566
How to add the one-time flat fee specific additional data in the pricing rule type	Adding the One-Time Flat Fee Specific Data in a Pricing Rule Type on page 2730

Adding the One-Time Flat Fee Specific Data in a Pricing Rule Type

Procedure

To add the one-time flat fee specific data in a pricing rule type:

1. Ensure that the **Flat Fees - Specific Additional Data** section is expanded when you are defining or editing a pricing rule type.

The **Flat Fees - Specific Additional Data** section contains the following fields:

Field Name	Field Description	Mandatory (Yes or No)
Bill Segment Cancel Reason	Used to indicate the bill segment cancel reason.	No
Recurring Fee	Used to specify whether the recurring flat fee or one-time flat fee is required.	No
	Note: This field cannot be edited.	

Field Name	Field Description	Mandatory (Yes or No)
Recurring Method	Used to indicate whether recurring bill segments must be created at the intervals defined in the bill period or at the set invoice frequency. The valid values are: <ul style="list-style-type: none"> • Bill Period • Frequency 	Yes (Conditional)
	<p>Note:</p> <p>This field appears when you select the checkbox for Recurring Fee field.</p> <p>This field cannot be edited.</p>	<p>Note: This field is required when you are specifying whether the recurring flat fee is based on bill period or frequency.</p>

- Enter the required details in the **Flat Fees - Specific Additional Data** section.
- Click **Save**.

The Flat Fees - Specific Additional data is added in the pricing rule type.

Related Topics

For more information on...	See...
How to define a one-time flat fee pricing rule type	Defining a One-Time Flat Fee Pricing Rule Type on page 2727
How to edit a one-time flat fee pricing rule type	Editing a One-Time Flat Fee Pricing Rule Type on page 2731

Editing a One-Time Flat Fee Pricing Rule Type

Prerequisites

To edit a one-time flat fee pricing rule type, you should have:

- Business Object **C1-PricingRuleFlatFees** defined for pricing rule.
- Pricing rule type category for flat fees defined in the application.

Procedure

To edit a one-time flat fee pricing rule type:

- Click the **Admin** link in the **Application** toolbar.
A list appears.
- From the **Admin** menu, select **P** and then click **Pricing Rule Type**.
A sub-menu appears.
- Click the **Search** option from the **Pricing Rule Type** sub-menu.
The **Pricing Rule Type** screen appears.
- In the **Pricing Rule Type List** zone, click the **Edit** (✎) icon in the **Edit** column corresponding to the Pricing rule type whose details you want to edit.

The **Pricing Rule Type** screen appears. It contains the following sections:

- **Main** – Used to specify basic details about the flat fee pricing rule type.

- **Related Pricing Rule Types** – Used to define the pricing rule types which are related to the parent pricing rule type.
- **Transaction Field Mapping** – Used to specify the transaction related data mapped to the pricing rule type
- **Algorithms** – Used to define the algorithms used for the pricing rule type.
- **Additional Data** – Used to specify the additional information about the pricing rule type.
- **Price Items** – Used to define the price items assigned to the pricing rule type.
- **Price Item Parameters** – Used to define the price item parameters in the pricing rule type.
- **Characteristics** – Used to define the characteristics for the pricing rule type.
- **Billable Charge Line Types** – Used to define the pricing rule type for billable charge line type.
- **Flat Fees - Specific Additional Data** – Used to specify the flat fees specific for additional data.

The **Main** section contains the following fields:

Field Name	Field Description	Mandatory (Yes or No)
Pricing Rule Type	Displays the pricing rule type.	Not applicable
Description	Used to specify the description for the pricing rule type.	Yes
Detailed Description	Used to specify additional information about the pricing rule type.	No
Pricing Rule Business Object	Used to indicate the pricing rule business object. The valid values are: <ul style="list-style-type: none"> • Claim Pricing Rule • Aggregate Stop-Loss (ASL) Pricing Rule • Specific Stop-Loss (SSL) Pricing Rule • Retention Type Claim Based Pricing Rule • Retention Type Enrollment Based Pricing Rule • Flat Fee Pricing Rule 	Yes
Business Object	Indicates the pricing rule type business object for flat fees.	Not applicable
Status	Used to indicate the status of the pricing rule type. The valid values are: <ul style="list-style-type: none"> • Active • Inactive 	Yes
Primary	Used to select the checkbox if the pricing rule type is primary. Note: This field is not enabled for selection if the Pricing Rule Type Category is Flat Fees .	No

Field Name	Field Description	Mandatory (Yes or No)
Pricing Rule Type Category	Used to indicate the pricing rule type category for the pricing rule type. The valid values are: <ul style="list-style-type: none"> • Claim • Aggregate Stop-Loss • Specific Stop-Loss • Retention Type Claim Based • Retention Type Enrollment Based • Flat Fees 	Yes

Tip: Alternatively, you can edit the details of a one-time flat fees pricing rule type by clicking the **Edit** button in the **Pricing Rule Type** zone.

5. Modify the required details in the **Main** section.
6. Define, edit or remove related pricing rule types from the primary pricing rule type, if required.

Note:

Related Pricing Rule Types section appears when the pricing rule type is primary.
This section does not appear when the **Pricing Rule Type Category** is **Flat Fees**.

7. Modify the details of transaction field mapping, if required.

Note:

Transaction Field Mapping section appears when the pricing rule type is primary.
This section does not appear when the **Pricing Rule Type Category** is **Flat Fees**.

8. Define, edit or remove algorithms from the pricing rule type, if required.
9. Modify additional data for the pricing rule type, if required.

Note: This section does not appear when the **Pricing Rule Type Category** is **Flat Fees**.

10. Define, edit or remove price items from the pricing rule type, if required.
11. Define, edit or remove price items from the pricing rule type, if required.
12. Define, edit, or remove characteristics of the pricing rule type, if required.
13. Define, edit or remove billable charge line types for the flat fees pricing rule type, if required.
14. Modify flat fees - specific additional data in the pricing rule type, if required.

Note: This section appears when the **Business Object** is **Flat Fees Pricing Rule Type**.

15. Click **Save**.

The changes made to the one-time flat fees pricing rule type are saved.

Related Topics

For more information on...	See...
Pricing Rule Type screen	Pricing Rule Type on page 2532

For more information on...	See...
Pricing Rule Type List zone	Pricing Rule Type List on page 2533
Pricing Rule Type zone	Pricing Rule Type on page 2536
How to add the related pricing rule types in the primary pricing rule type	Adding Related Pricing Rule Types in a Primary Pricing Rule Type on page 2549
How to define the transaction field mapping in the primary pricing rule type	Defining Transaction Field Mapping in a Primary Pricing Rule Type on page 2551
How to associate algorithms with the pricing rule type	Associating Algorithms with a Pricing Rule Type on page 2557
How to define additional data for the pricing rule type	Defining Additional Data for a Pricing Rule Type on page 2559
How to add pricing items in the pricing rule type	Adding Price Items in a Pricing Rule Type on page 2561
How to add price item parameters in the pricing rule type	Adding a Price Item Parameter in a Pricing Rule Type on page 2564
How to define a characteristic for the pricing rule type	Defining a Characteristic for a Pricing Rule Type on page 2566
How to add the one-time flat fee specific additional data in the pricing rule type	Adding the One-Time Flat Fee Specific Data in a Pricing Rule Type on page 2730

Deleting a One-Time Flat Fee Pricing Rule Type

Procedure

To delete a one-time flat fee pricing rule type:

1. Click the **Admin** link in the **Application** toolbar.
A list appears.
2. From the **Admin** menu, select **P** and then click **Pricing Rule Type**.
A sub-menu appears.
3. Click the **Search** option from the **Pricing Rule Type** sub-menu.
The **Pricing Rule Type** screen appears.
4. In the **Pricing Rule Type List** zone, click the **Delete** (🗑️) icon in the **Delete** column corresponding to the one-time flat fee pricing rule type that you want to delete.
A message appears confirming whether you want to delete the one-time flat fee pricing rule type.

Note: You can delete a one-time flat fee pricing rule type when it is not yet used in the system.

Tip: Alternatively, you can delete a one-time flat fee pricing rule type by clicking the **Delete** button in the **Pricing Rule Type** zone.

5. Click **OK**.
The one-time flat fee pricing rule type is deleted.

Related Topics

For more information on...	See...
Pricing Rule Type screen	Pricing Rule Type on page 2532
Pricing Rule Type List zone	Pricing Rule Type List on page 2533
Pricing Rule Type zone	Pricing Rule Type on page 2536

Viewing the One-Time Flat Fee Pricing Rule Type Details

Procedure

To view the details of a one-time flat fee pricing rule type:

1. Click the **Admin** link in the **Application** toolbar.
A list appears.
2. From the **Admin** menu, select **P** and then click **Pricing Rule Type**.
A sub-menu appears.
3. Click the **Search** option from the **Pricing Rule Type** sub-menu.
The **Pricing Rule Type** screen appears.
4. In the **Pricing Rule Type List** zone, click the **Broadcast** (📡) icon corresponding to the one-time flat fee pricing rule type whose details you want to view.
The **Pricing Rule Type** zone appears.
5. View the details of the one-time flat fee pricing rule type in the **Pricing Rule Type** zone.

Related Topics

For more information on...	See...
Pricing Rule Type screen	Pricing Rule Type on page 2532
Pricing Rule Type List zone	Pricing Rule Type List on page 2533
Pricing Rule Type zone	Pricing Rule Type on page 2536

Defining a One-Time Flat Fee Pricing Rule for a Bill Group

Prerequisites

To define a one-time flat fee pricing rule for a bill group, you should have:

- Business Object **C1-PricingRule** defined for pricing rule.
- Business Object **C1-PricingRuleFlatFees** defined for one-time flat fee pricing rule.
- Pricing rule type defined in the application.
- Policy status defined in the application.
- Price item defined in the application.
- Billable Charge Line Type defined in the application.

Procedure

To define a one-time flat fee pricing rule for a bill group:

1. Search for the account, person, or policy whose pricing details you want to view in the **Customer 360° View** screen.

- In the **Search Results** section, click the **View** (🔗) icon corresponding to the account, person, or policy whose pricing details you want to view.
The **Account**, **Person**, or **Policy** tab in the **Customer 360° Information** screen appears.
- Click the **Pricing** tab and then click the **Add** link in the upper right corner of the **Bill Group ASO Policy Pricing Rules** zone.

The **Pricing Rule** screen appears. It contains the following fields:

Field Name	Field Description	Mandatory (Yes or No)
Person Name	Displays the person name.	Not applicable
Person Type	Displays the person type.	Not applicable
Pricing Rule Type	Used to indicate the pricing rule type to create the pricing rule. Note: You can create a one-time flat fee pricing rule using the Pricing Rule Type for flat fees.	Yes
Policy Status	Used to indicate the policy status for pricing rule. The valid values are: <ul style="list-style-type: none"> In Force/Active Runout 	Yes

- Click **OK**.

The **Flat Fee Pricing Rule** screen appears. It contains the following sections:

- Customer Information** – Displays the customer information for bill group.
- Main** – Used to specify basic details about the one-time flat fee pricing rule.
- Characteristics** – Used to define the characteristics for the one-time flat fee pricing rule.

The **Customer Information** section contains the following fields:

Field Name	Field Description	Mandatory (Yes or No)
Bill Group Information	Displays the bill group information.	Not applicable
Policy Start Date	Displays the policy start date.	Not applicable
Policy End Date	Displays the policy end date.	Not applicable
Policy Status	Indicates the policy status for pricing rule. The valid values are: <ul style="list-style-type: none"> In Force/Active Runout 	Not applicable
Pricing Rule Type	Indicates the pricing rule type.	Not applicable

The **Main** section contains the following fields:

Field Name	Field Description	Mandatory (Yes or No)
Price Item	Used to indicate the price item.	Yes

Field Name	Field Description	Mandatory (Yes or No)
Charge Date	Used to specify the flat fee charge date.	Yes
	Note: By default this field displays the policy start date or policy runout start date.	
Billable Charge Line Type	Used to specify the billable charge line type.	No
	Note: On clicking the Search (🔍) icon, the Billable Charge Line Type Search window appears. On specifying the billable charge line type, the description of the billable charge line type appears corresponding to the Billable Charge Line Type field.	
Bill After Date	Used to specify the bills after the specific date.	No
Fee	Used to specify the amount of flat fee.	Yes
	Note: This field appears when you select the billable charge line type in the Billable Charge Line Type field.	
Bill To Account Override	Used to specify the account to which the bill is override.	Yes
	Note: On clicking the Search (🔍) icon, the Account Search window appears. On specifying the account, the description of the account appears corresponding to the Bill To Account Override field.	

5. Enter the required details in the **Main** section.
6. Define characteristics for a one-time flat fee pricing rule, if required.
7. Click **Save**.

The one-time flat fee pricing rule for a bill group is defined.

Note: A billable charge is created and assigned to the one-time flat fee pricing rule.

Related Topics

For more information on...	See...
Customer 360° Information – Pricing tab	Customer 360° Information - Pricing Information on page 693
Bill Group ASO Policy Pricing Rules zone	Bill Group Self-Funded Policy Pricing Rules on page 702
How to define a characteristic for a one-time flat fee pricing rule	Defining a Characteristic for a One-Time Flat Fee Pricing Rule on page 2738

Defining a Characteristic for a One-Time Flat Fee Pricing Rule

Prerequisites

To define a characteristic for a one-time flat fee pricing rule, you should have:

- Characteristic types defined in the application (where the characteristic entity is set to **Pricing Rule**)

Procedure

To define a characteristic for a one-time flat fee pricing rule:

1. Ensure that the **Characteristics** section is expanded when you are defining or editing a pricing rule.

The **Characteristics** section contains the following columns in a grid:

Column Name	Column Description	Mandatory (Yes or No)
Effective Date	Used to specify the date from when the characteristic is effective for the one-time flat fee pricing rule.	Yes (Conditional)
		Note: This field is required when you are defining a characteristic for the one-time flat fee pricing rule.
Characteristic Type	Used to indicate the characteristic type. Note: The list includes only those characteristic types where the characteristic entity is set to Pricing Rule .	Yes (Conditional)
		Note: This field is required when you are defining a characteristic for the one-time flat fee pricing rule.
Characteristic Value	Used to specify the value for the characteristic type. Note: If you select a predefined characteristic type, the Search (🔍) icon appears corresponding to the Characteristic Value field. On clicking the Search icon, the Predefined Characteristic Search window appears. On specifying the value for a predefined characteristic type, the description of the characteristic value appears corresponding to the Characteristic Value field.	Yes (Conditional)
		Note: This field is required when you are defining a characteristic for the one-time flat fee pricing rule.

2. Enter the required details in the **Characteristics** section.
3. If you want to define more than one characteristic for the one-time flat fee pricing rule, click the **Add** (+) icon and then repeat step 2.

Note: However, if you want to remove a characteristic from the one-time flat fee pricing rule, click the **Delete** (🗑️) icon corresponding to the characteristic.

4. Click **Save**.

The characteristics are defined for the one-time flat fee pricing rule.

Related Topics

For more information on...	See...
How to define a one-time flat fee pricing rule for a bill group	Defining a One-Time Flat Fee Pricing Rule for a Bill Group on page 2735
How to edit the one-time flat fee pricing rule for a bill group	Editing a One-Time Flat Fee Pricing Rule of a Bill Group on page 2739

Editing a One-Time Flat Fee Pricing Rule of a Bill Group

Prerequisites

To edit a one-time flat fee pricing rule of a bill group, you should have:

- Business Object **C1-PricingRuleFlatFees** defined for one-time flat fee pricing rule.

Procedure

To edit a one-time flat fee pricing rule of a bill group:

1. Search for the account, person, or policy whose pricing details you want to view in the **Customer 360° View** screen.
2. In the **Search Results** section, click the **View** (🔗) icon corresponding to the account, person, or policy whose pricing details you want to view. The **Account, Person, or Policy** tab in the **Customer 360° Information** screen appears.
3. Click the **Pricing** tab, in the **Bill Group ASO Policy Pricing Rules** zone click the **Edit** (✎) icon in the **Edit** column corresponding to the pricing rule type for one-time flat fee whose one-time flat fee pricing rule details you want to view.

The **Flat Fee Pricing Rule** screen appears. It contains the following sections:

- **Customer Information** – Displays the customer information for bill group.
- **Main** – Displays the basic details of the one-time flat fee pricing rule.
- **Characteristics** – Used to define the characteristics for the one-time flat fee pricing rule.

The **Customer Information** section contains the following fields:

Field Name	Field Description	Mandatory (Yes or No)
Bill Group Information	Displays the bill group information.	Not applicable
Policy Start Date	Displays the policy start date.	Not applicable
Policy End Date	Displays the policy end date.	Not applicable
Policy Status	Indicates the policy status for pricing rule. The valid values are: <ul style="list-style-type: none"> • In Force/Active • Runout 	Not applicable
Pricing Rule Type	Indicates the pricing rule type.	Not applicable

The **Main** section contains the following fields:

Field Name	Field Description	Mandatory (Yes or No)
Price Item	Indicates the price item.	Not applicable
Charge Date	Used to specify the flat fee charge date.	Yes

Field Name	Field Description	Mandatory (Yes or No)
Billable Charge Line Type	Displays the billable charge line type.	Not applicable
Bill After Date	Displays the bills after the specific date.	Not applicable
Fee	Used to specify the amount of flat fee.	Yes
	Note: This field appears when you have added the billable charge line type in the Billable Charge Line Type field.	
Bill To Account Override	Displays the account to which the bill is override.	Not applicable
Billable Charge Information	Displays the billable charge information.	Not applicable

4. Modify the basic details of the one-time flat fee pricing rule, if required.
5. Add, edit, or remove characteristics for a one-time flat fee pricing rule, if required.
6. Click **Save**.

Note: If **Fee** or **Charge Date** is modified then it checks whether bill segment is created, and if it is created then,

- If it is in frozen or pending cancelled status then,
 - Bill segment and billable charge is cancelled and new billable charge is created.
- If it is in any other status other than cancelled then,
 - Bill segment is deleted and existing billable charge billable charge is updated.

Charge Date is set to billable charge start date and end date.

When characteristics are updated, billable charge is updated with those characteristics.

The changes made to a one-time flat fee pricing rule for a bill group are saved.

Related Topics

For more information on...	See...
Customer 360° Information – Pricing tab	Customer 360° Information - Pricing Information on page 693
Bill Group ASO Policy Pricing Rules zone	Bill Group Self-Funded Policy Pricing Rules on page 702
How to define a characteristic for a one-time flat fee pricing rule	Defining a Characteristic for a One-Time Flat Fee Pricing Rule on page 2738

Viewing a One-Time Flat Fee Pricing Rule of a Bill Group

Procedure

To view a one-time flat fee pricing rule of a bill group:

1. Search for the account, person, or policy whose pricing details you want to view in the **Customer 360° View** screen.
2. In the **Search Results** section, click the **View** () icon corresponding to the account, person, or policy whose pricing details you want to view.

The **Account, Person, or Policy** tab in the **Customer 360° Information** screen appears.

3. Click the **Pricing** tab.
4. In the **Bill Group ASO Policy Information** zone, click the **Broadcast** () icon corresponding to the bill group whose one-time flat fee pricing rule bill group details you want to view.
5. In the **Bill Group ASO Policy Pricing Rules** zone, click the link in the **Pricing Rule Information** column corresponding to the one-time flat fee pricing rule type whose one-time flat fee pricing rule

The **Pricing Rule** screen appears. It contains the following zone:

- **Flat Fee** – Displays the pricing rule one-time flat fee details for a bill group. It contains the following sections:
 - **Main** – Displays the basic details of the one-time flat fee pricing rule.
 - **Characteristics** – Displays the characteristics defined for the one-time flat fee pricing rule.
- 6. View the basic details of one-time flat fee pricing rule in the **Main** section.
- 7. View the characteristics of the one-time flat fee pricing rule in the **Characteristics** section.



Related Topics

For more information on...	See...
Customer 360° Information – Pricing tab	Customer 360° Information - Pricing Information on page 693
Bill Group ASO Policy Pricing Rules zone	Bill Group Self-Funded Policy Pricing Rules on page 702
Pricing Rule screen	Pricing Rule (Used for Viewing) on page 2902
Flat Fee zone	Flat Fee on page 2920

Deleting a One-Time Flat Fee Pricing Rule of a Bill Group

Procedure

To delete a one-time flat fee pricing rule of a bill group:

1. Search for the account, person, or policy whose pricing details you want to view in the **Customer 360° View** screen.
2. In the **Search Results** section, click the **View** () icon corresponding to the account, person, or policy whose pricing details you want to view.
The **Account, Person, or Policy** tab in the **Customer 360° Information** screen appears.
3. Click the **Pricing** tab, in the **Bill Group ASO Policy Pricing Rules** zone, click the **Delete** () icon in the **Delete** column corresponding to the one-time flat fee pricing rule type whose one-time flat fee pricing rule you want to delete.
A message appears confirming whether you want to delete the one-time flat fee pricing rule.
4. Click **OK**.

Note:

If flat fees is not linked to billable charge whose bill segment is in frozen or pending cancelled status then the pricing rule is not deleted.

If bill segment is either not created or is in any other status other than cancelled then delete bill segment, billable charge and pricing rule.

If bill segment is cancelled then billable charge is cancelled and pricing rule is deleted.

The one-time flat fee pricing rule is deleted.

Related Topics

For more information on...	See...
Customer 360° Information – Pricing tab	Customer 360° Information - Pricing Information on page 693
Bill Group ASO Policy Pricing Rules zone	Bill Group Self-Funded Policy Pricing Rules on page 702

Defining a Bill Period Based Recurring Flat Fee Pricing Rule Type**Prerequisites**

To define a bill period based recurring flat fee pricing rule type, you should have:

- Business Object **C1-PricingRuleTypeFlatFees** defined for pricing rule type.
- Business Object **C1-PricingRuleFlatFees** defined for pricing rule.
- Pricing rule type category for flat fees defined in the application.

Procedure

To define a bill period based recurring flat fee pricing rule type:

1. Click the **Admin** link in the **Application** toolbar.
A list appears.
2. From the **Admin** menu, select **P** and then click **Pricing Rule Type**.
A sub-menu appears.
3. Click the **Add** option from the **Pricing Rule Type** sub-menu.

The **Select Business Object** screen appears. It contains the following field:

Field Name	Field Description	Mandatory (Yes or No)
Pricing Rule Type Business Object	Used to indicate the business object using which you want to create the pricing rule type.	Yes
	Note: You can create a bill period based recurring flat fee pricing rule type using the Flat Fee Pricing Rule Type business object.	

Tip: Alternatively, you can access this screen by clicking the **Add** button in the **Page Title** area of the **Pricing Rule Type** screen.

4. Select the **Flat Fee Pricing Rule Type** business object.
5. Click **OK**.

The **Flat Fee Pricing Rule Type** screen appears. It contains the following sections:

- **Main** – Used to specify basic details about the flat fee pricing rule type.
- **Related Pricing Rule Types** – Used to define the pricing rule types which are related to the parent pricing rule type.
- **Transaction Field Mapping** – Used to specify the transaction related data mapped to the pricing rule type
- **Algorithms** – Used to define the algorithms used for the pricing rule type.
- **Additional Data** – Used to specify the additional information about the pricing rule type.
- **Price Items** – Used to define the price items assigned to the pricing rule type.

- **Price Item Parameters** – Used to define the price item parameters in the pricing rule type.
- **Characteristics** – Used to define the characteristics for the pricing rule type.
- **Billable Charge Line Types** – Used to define the pricing rule type for billable charge line type.
- **Flat Fees - Specific Additional Data** – Used to specify the flat fees specific for additional data.
 - **Bill Periods** – Used to specify the bill periods for specifying intervals for creating recurring bill segments.

The **Main** section contains the following fields:

Field Name	Field Description	Mandatory (Yes or No)
Pricing Rule Type	Used to specify the pricing rule type.	Yes
Description	Used to specify the description for the pricing rule type.	Yes
Detailed Description	Used to specify additional information about the pricing rule type.	No
Pricing Rule Business Object	Used to indicate the pricing rule business object. The valid values are: <ul style="list-style-type: none"> • Claim Pricing Rule • Aggregate Stop-Loss (ASL) Pricing Rule • Specific Stop-Loss (SSL) Pricing Rule • Retention Type Claim Based Pricing Rule • Retention Type Enrollment Based Pricing Rule • Flat Fee Pricing Rule 	Yes
Business Object	Indicates the pricing rule type business object for flat fees.	Not applicable
Status	Used to indicate the status of the pricing rule type. The valid values are: <ul style="list-style-type: none"> • Active • Inactive 	Yes
Primary	Used to select the checkbox if the pricing rule type is primary. <div style="border: 1px solid black; padding: 2px; margin-top: 5px;"> <p>Note: This field is not enabled for selection if the Pricing Rule Type Category is Flat Fees.</p> </div>	No

Field Name	Field Description	Mandatory (Yes or No)
Pricing Rule Type Category	Used to indicate the pricing rule type category for the pricing rule type. The valid values are: <ul style="list-style-type: none"> • Claim • Aggregate Stop-Loss • Specific Stop-Loss • Retention Type Claim Based • Retention Type Enrollment Based • Flat Fees 	Yes

- Enter the required details in the **Main** section.
- Add the related pricing rule types in the primary pricing rule type, if required.

Note:

Related Pricing Rule Types section appears when the pricing rule type is primary. This section does not appear when the **Pricing Rule Type Category** is **Flat Fees**.

- Define the transaction field mapping in the primary pricing rule type, if required.

Note:

Transaction Field Mapping section appears when the pricing rule type is primary. This section does not appear when the **Pricing Rule Type Category** is **Flat Fees**.

- Associate algorithms with the pricing rule type, if required.
- Define additional data for the pricing rule type, if required.

Note: This section does not appear when the **Pricing Rule Type Category** is **Flat Fees**.

- Add pricing items in the pricing rule type, if required.
- Add price item parameters in the pricing rule type, if required.
- Define characteristics for the pricing rule type, if required.
- Define billable charge line types in the flat fees pricing rule type, if required.
- Add the flat fees - specific additional data in the pricing rule type, if required.

Note:

This section appears when the **Business Object** is **Flat Fees Pricing Rule Type**. Add the bill periods in the pricing rule type, if required.

- Click **Save**.

The bill period based recurring flat fee pricing rule type is defined.

Related Topics

For more information on...	See...
Pricing Rule Type screen	Pricing Rule Type on page 2532

For more information on...	See...
How to add the related pricing rule types in the primary pricing rule type	Adding Related Pricing Rule Types in a Primary Pricing Rule Type on page 2549
How to define the transaction field mapping in the primary pricing rule type	Defining Transaction Field Mapping in a Primary Pricing Rule Type on page 2551
How to associate algorithms with the pricing rule type	Associating Algorithms with a Pricing Rule Type on page 2557
How to define additional data for the pricing rule type	Defining Additional Data for a Pricing Rule Type on page 2559
How to add pricing items in the pricing rule type	Adding Price Items in a Pricing Rule Type on page 2561
How to add price item parameters in the pricing rule type	Adding a Price Item Parameter in a Pricing Rule Type on page 2564
How to define a characteristic for the pricing rule type	Defining a Characteristic for a Pricing Rule Type on page 2566
How to add the recurring flat fee specific data in the pricing rule type	Adding the Recurring Flat Fee Specific Data in a Pricing Rule Type on page 2745

Adding the Recurring Flat Fee Specific Data in a Pricing Rule Type

Procedure

To add the recurring flat fee specific data in a pricing rule type:

1. Ensure that the **Flat Fees - Specific Additional Data** section is expanded when you are defining or editing a pricing rule type.

The **Flat Fees - Specific Additional Data** section contains the following fields:

Field Name	Field Description	Mandatory (Yes or No)
Bill Segment Cancel Reason	Used to indicate the bill segment cancel reason.	No
Recurring Fee	Used to specify whether the recurring flat fee or one-time flat fee is required. Note: This field cannot be edited.	No
Recurring Method	Used to indicate whether recurring bill segments must be created at the intervals defined in the bill period or at the invoice frequency. The valid values are: <ul style="list-style-type: none"> • Bill Period • Frequency Note: This field appears when you select the checkbox for Recurring Fee field. This field cannot be edited.	Yes (Conditional) Note: This field is required when you are specifying whether the recurring flat fee is based on bill period or frequency.

The **Flat Fees - Specific Additional Data** section contains the following sub-section:

The **Bill Periods** sub-section contains the following column in a grid:

Column Name	Column Description	Mandatory (Yes or No)
Bill Period	Used to indicate the bill period that you want to use for specifying the intervals at which the recurring bill segments must be created.	Yes

- Enter the required details in the **Flat Fees - Specific Additional Data** section.
- Enter the details in the **Bill Periods** sub-section, if required.

Note: This sub-section appears when you have selected **Bill Period** as **Recurring Method**.

- Click **Save**.

The Flat Fees - Specific Additional data is added in the pricing rule type.

Related Topics

For more information on...	See...
How to define a bill period based recurring flat fee pricing rule type	Defining a Bill Period Based Recurring Flat Fee Pricing Rule Type on page 2742
How to define a frequency based recurring flat fee pricing rule type	Defining a Frequency Based Recurring Flat Fee Pricing Rule Type on page 2757
How to edit a bill period based recurring flat fee pricing rule type	Editing a Bill Period Based Recurring Flat Fee Pricing Rule Type on page 2746
How to edit a frequency based recurring flat fee pricing rule type	Editing a Frequency Based Recurring Flat Fee Pricing Rule Type on page 2761

Editing a Bill Period Based Recurring Flat Fee Pricing Rule Type

Prerequisites

To edit a bill period based recurring flat fee pricing rule type, you should have:

- Business Object **C1-PricingRuleFlatFees** defined for pricing rule.
- Pricing rule type category for flat fees defined in the application.

Procedure

To edit a bill period based recurring flat fee pricing rule type:

- Click the **Admin** link in the **Application** toolbar.
A list appears.
- From the **Admin** menu, select **P** and then click **Pricing Rule Type**.
A sub-menu appears.
- Click the **Search** option from the **Pricing Rule Type** sub-menu.
The **Pricing Rule Type** screen appears.
- In the **Pricing Rule Type List** zone, click the **Edit** (✎) icon in the **Edit** column corresponding to the Pricing rule type whose details you want to edit.

The **Pricing Rule Type** screen appears. It contains the following sections:

- **Main** – Used to specify basic details about the flat fee pricing rule type.
- **Related Pricing Rule Types** – Used to define the pricing rule types which are related to the parent pricing rule type.
- **Transaction Field Mapping** – Used to specify the transaction related data mapped to the pricing rule type
- **Algorithms** – Used to define the algorithms used for the pricing rule type.
- **Additional Data** – Used to specify the additional information about the pricing rule type.
- **Price Items** – Used to define the price items assigned to the pricing rule type.
- **Price Item Parameters** – Used to define the price item parameters in the pricing rule type.
- **Characteristics** – Used to define the characteristics for the pricing rule type.
- **Billable Charge Line Types** – Used to define the pricing rule type for billable charge line type.
- **Flat Fees - Specific Additional Data** – Used to specify the flat fees specific for additional data.
 - **Bill Periods** – Used to specify the bill periods for specifying intervals for creating recurring bill segments.

The **Main** section contains the following fields:

Field Name	Field Description	Mandatory (Yes or No)
Pricing Rule Type	Displays the pricing rule type.	Not applicable
Description	Used to specify the description for the pricing rule type.	Yes
Detailed Description	Used to specify additional information about the pricing rule type.	No
Pricing Rule Business Object	Used to indicate the pricing rule business object. The valid values are: <ul style="list-style-type: none"> • Claim Pricing Rule • Aggregate Stop-Loss (ASL) Pricing Rule • Specific Stop-Loss (SSL) Pricing Rule • Retention Type Claim Based Pricing Rule • Retention Type Enrollment Based Pricing Rule • Flat Fee Pricing Rule 	Yes
Business Object	Indicates the pricing rule type business object for flat fees.	Not applicable
Status	Used to indicate the status of the pricing rule type. The valid values are: <ul style="list-style-type: none"> • Active • Inactive 	Yes
Primary	Used to select the checkbox if the pricing rule type is primary. Note: This field is not enabled for selection if the Pricing Rule Type Category is Flat Fees .	No

Field Name	Field Description	Mandatory (Yes or No)
Pricing Rule Type Category	Used to indicate the pricing rule type category for the pricing rule type. The valid values are: <ul style="list-style-type: none"> • Claim • Aggregate Stop-Loss • Specific Stop-Loss • Retention Type Claim Based • Retention Type Enrollment Based • Flat Fees 	Yes

Tip: Alternatively, you can edit the details of a bill period based recurring flat fees pricing rule type by clicking the **Edit** button in the **Pricing Rule Type** zone.

5. Modify the required details in the **Main** section.
6. Define, edit or remove related pricing rule types from the primary pricing rule type, if required.

Note:

Related Pricing Rule Types section appears when the pricing rule type is primary.
This section does not appear when the **Pricing Rule Type Category** is **Flat Fees**.

7. Modify the details of transaction field mapping, if required.

Note:

Transaction Field Mapping section appears when the pricing rule type is primary.
This section does not appear when the **Pricing Rule Type Category** is **Flat Fees**.

8. Define, edit or remove algorithms from the pricing rule type, if required.
9. Modify additional data for the pricing rule type, if required.

Note: This section does not appear when the **Pricing Rule Type Category** is **Flat Fees**.

10. Define, edit or remove price items from the pricing rule type, if required.
11. Define, edit or remove price items from the pricing rule type, if required.
12. Define, edit, or remove characteristics of the pricing rule type, if required.
13. Define, edit or remove billable charge line types for the flat fees pricing rule type, if required.
14. Modify flat fees - specific additional data in the pricing rule type, if required.

Note:

This section appears when the **Business Object** is **Flat Fees Pricing Rule Type**.
Define, edit or remove bill periods from the pricing rule type, if required.

15. Click **Save**.

The changes made to the bill period based recurring flat fee pricing rule type are saved.

Related Topics

For more information on...	See...
Pricing Rule Type screen	Pricing Rule Type on page 2532
Pricing Rule Type List zone	Pricing Rule Type List on page 2533
Pricing Rule Type zone	Pricing Rule Type on page 2536
How to add the related pricing rule types in the primary pricing rule type	Adding Related Pricing Rule Types in a Primary Pricing Rule Type on page 2549
How to define the transaction field mapping in the primary pricing rule type	Defining Transaction Field Mapping in a Primary Pricing Rule Type on page 2551
How to associate algorithms with the pricing rule type	Associating Algorithms with a Pricing Rule Type on page 2557
How to define additional data for the pricing rule type	Defining Additional Data for a Pricing Rule Type on page 2559
How to add pricing items in the pricing rule type	Adding Price Items in a Pricing Rule Type on page 2561
How to add price item parameters in the pricing rule type	Adding a Price Item Parameter in a Pricing Rule Type on page 2564
How to define a characteristic for the pricing rule type	Defining a Characteristic for a Pricing Rule Type on page 2566
How to add the recurring flat fee specific data in the pricing rule type	Adding the Recurring Flat Fee Specific Data in a Pricing Rule Type on page 2745

Deleting a Bill Period Based Recurring Flat Fee Pricing Rule Type

Procedure

To delete a bill period based recurring flat fee pricing rule type:

1. Click the **Admin** link in the **Application** toolbar.
A list appears.
2. From the **Admin** menu, select **P** and then click **Pricing Rule Type**.
A sub-menu appears.
3. Click the **Search** option from the **Pricing Rule Type** sub-menu.
The **Pricing Rule Type** screen appears.
4. In the **Pricing Rule Type List** zone, click the **Delete** (🗑️) icon in the **Delete** column corresponding to the bill period based recurring flat fee pricing rule type that you want to delete.
A message appears confirming whether you want to delete the bill period based recurring flat fee pricing rule type.

Note: You can delete a bill period based recurring flat fee pricing rule type when it is not yet used in the system.

Tip: Alternatively, you can delete a bill period based recurring flat fee pricing rule type by clicking the **Delete** button in the **Pricing Rule Type** zone.

5. Click **OK**.
The bill period based recurring flat fee pricing rule type is deleted.

Related Topics

For more information on...	See...
Pricing Rule Type screen	Pricing Rule Type on page 2532
Pricing Rule Type List zone	Pricing Rule Type List on page 2533
Pricing Rule Type zone	Pricing Rule Type on page 2536

Viewing the Bill Period Based Recurring Flat Fee Pricing Rule Type Details

Procedure

To view the details of a bill period based recurring flat fee pricing rule type:

1. Click the **Admin** link in the **Application** toolbar.
A list appears.
2. From the **Admin** menu, select **P** and then click **Pricing Rule Type**.
A sub-menu appears.
3. Click the **Search** option from the **Pricing Rule Type** sub-menu.
The **Pricing Rule Type** screen appears.
4. In the **Pricing Rule Type List** zone, click the **Broadcast** () icon corresponding to the bill period based recurring flat fee pricing rule type whose details you want to view.
The **Pricing Rule Type** zone appears.
5. View the details of the bill period based recurring flat fee pricing rule type in the **Pricing Rule Type** zone.

Related Topics

For more information on...	See...
Pricing Rule Type screen	Pricing Rule Type on page 2532
Pricing Rule Type List zone	Pricing Rule Type List on page 2533
Pricing Rule Type zone	Pricing Rule Type on page 2536

Defining a Bill Period Based Recurring Flat Fee Pricing Rule for a Bill Group

Prerequisites

To define a bill period based recurring flat fee pricing rule for a bill group, you should have:

- Business Object **C1-PricingRule** defined for pricing rule.
- Business Object **C1-PricingRuleFlatFees** defined for bill period based recurring flat fee pricing rule.
- Pricing rule type defined in the application.
- Policy status defined in the application.
- Price item defined in the application.
- Billable Charge Line Type defined in the application.

Procedure

To define a bill period based recurring flat fee pricing rule for a bill group:

1. Search for the account, person, or policy whose pricing details you want to view in the **Customer 360° View** screen.

2. In the **Search Results** section, click the **View** () icon corresponding to the account, person, or policy whose pricing details you want to view.

The **Account, Person, or Policy** tab in the **Customer 360° Information** screen appears.

3. Click the **Pricing** tab and then click the **Add** link in the upper right corner of the **Bill Group ASO Policy Pricing Rules** zone.

The **Pricing Rule** screen appears. It contains the following fields:

Field Name	Field Description	Mandatory (Yes or No)
Person Name	Displays the person name.	Not applicable
Person Type	Displays the person type.	Not applicable
Pricing Rule Type	Used to indicate the pricing rule type to create the pricing rule.	Yes
	Note: You can create a bill period based recurring flat fee pricing rule using the Pricing Rule Type for flat fees.	
Policy Status	Used to indicate the policy status for pricing rule. The valid values are: <ul style="list-style-type: none"> In Force/Active Runout 	Yes

4. Click **OK**.

The **Flat Fee Pricing Rule** screen appears. It contains the following sections:

- Customer Information** – Displays the customer information for bill group.
- Main** – Used to specify basic details about the bill period based recurring flat fee pricing rule.
- Characteristics** – Used to define the characteristics for the bill period based recurring flat fee pricing rule.

The **Customer Information** section contains the following fields:

Field Name	Field Description	Mandatory (Yes or No)
Bill Group Information	Displays the bill group information.	Not applicable
Policy Start Date	Displays the policy start date.	Not applicable
Policy End Date	Displays the policy end date.	Not applicable
Policy Status	Indicates the policy status for pricing rule. The valid values are: <ul style="list-style-type: none"> In Force/Active Runout 	Not applicable
Pricing Rule Type	Indicates the pricing rule type.	Not applicable

The **Main** section contains the following fields:

Field Name	Field Description	Mandatory (Yes or No)
Price Item	Used to indicate the price item.	Yes

Field Name	Field Description	Mandatory (Yes or No)
Charge Start Date	Used to specify the flat fee charge start date.	Yes
Billable Charge Line Type	Used to specify the billable charge line type. Note: On clicking the Search (🔍) icon, the Billable Charge Line Type Search window appears. On specifying the billable charge line type, the description of the billable charge line type appears corresponding to the Billable Charge Line Type field.	No
Charge End Date	Used to specify the flat fee charge end date.	No
Bill Period	Used to indicate the bill period for flat fee.	Yes
Fee	Used to specify the amount of flat fee. Note: This field appears when you select the billable charge line type in the Billable Charge Line Type field.	Yes
Bill To Account Override	Used to specify the account to which the bill is override. Note: On clicking the Search (🔍) icon, the Account Search window appears. On specifying the account, the description of the account appears corresponding to the Bill To Account Override field.	Yes

5. Enter the required details in the **Main** section.
6. Define characteristics for a bill period based recurring flat fee pricing rule, if required.
7. Click **Save**.

The bill period based recurring flat fee pricing rule for a bill group is defined.

Note: A billable charge is created and assigned to the bill period based recurring flat fee pricing rule.

Related Topics

For more information on...	See...
Customer 360° Information – Pricing tab	Customer 360° Information - Pricing Information on page 693
Bill Group ASO Policy Pricing Rules zone	Bill Group Self-Funded Policy Pricing Rules on page 702
How to define a characteristic for a bill period based recurring flat fee pricing rule	Defining a Characteristic for a Bill Period Based Recurring Flat Fee Pricing Rule on page 2753

Defining a Characteristic for a Bill Period Based Recurring Flat Fee Pricing Rule

Prerequisites

To define a characteristic for a bill period based recurring flat fee pricing rule, you should have:

- Characteristic types defined in the application (where the characteristic entity is set to **Pricing Rule**)

Procedure

To define a characteristic for a bill period based recurring flat fee pricing rule:

1. Ensure that the **Characteristics** section is expanded when you are defining or editing a pricing rule.

The **Characteristics** section contains the following columns in a grid:

Column Name	Column Description	Mandatory (Yes or No)
Effective Date	Used to specify the date from when the characteristic is effective for the bill period based recurring flat fee pricing rule.	Yes (Conditional)
		Note: This field is required when you are defining a characteristic for the bill period based recurring flat fee pricing rule.
Characteristic Type	Used to indicate the characteristic type. Note: The list includes only those characteristic types where the characteristic entity is set to Pricing Rule .	Yes (Conditional)
		Note: This field is required when you are defining a characteristic for the bill period based recurring flat fee pricing rule.
Characteristic Value	Used to specify the value for the characteristic type. Note: If you select a predefined characteristic type, the Search (🔍) icon appears corresponding to the Characteristic Value field. On clicking the Search icon, the Predefined Characteristic Search window appears. On specifying the value for a predefined characteristic type, the description of the characteristic value appears corresponding to the Characteristic Value field.	Yes (Conditional)
		Note: This field is required when you are defining a characteristic for the bill period based recurring flat fee pricing rule.

2. Enter the required details in the **Characteristics** section.
3. If you want to define more than one characteristic for the bill period based recurring flat fee pricing rule, click the **Add** (+) icon and then repeat step 2.

Note: However, if you want to remove a characteristic from the bill period based recurring flat fee pricing rule, click the **Delete** (🗑️) icon corresponding to the characteristic.

4. Click **Save**.

The characteristics are defined for the bill period based recurring flat fee pricing rule.

Related Topics

For more information on...	See...
How to define a bill period based recurring flat fee pricing rule for a bill group	Defining a Bill Period Based Recurring Flat Fee Pricing Rule for a Bill Group on page 2750
How to edit the bill period based recurring flat fee pricing rule for a bill group	Editing a Bill Period Based Recurring Flat Fee Pricing Rule of a Bill Group on page 2754

Editing a Bill Period Based Recurring Flat Fee Pricing Rule of a Bill Group**Prerequisites**

To edit a bill period based recurring flat fee pricing rule of a bill group, you should have:

- Business Object **C1-PricingRuleFlatFees** defined for bill period based recurring flat fee pricing rule.

Procedure

To edit a bill period based recurring flat fee pricing rule of a bill group:

1. Search for the account, person, or policy whose pricing details you want to view in the **Customer 360° View** screen.
2. In the **Search Results** section, click the **View** (🔍) icon corresponding to the account, person, or policy whose pricing details you want to view.

The **Account, Person, or Policy** tab in the **Customer 360° Information** screen appears.

3. Click the **Pricing** tab, in the **Bill Group ASO Policy Pricing Rules** zone click the **Edit** (✎) icon in the **Edit** column corresponding to the pricing rule type for bill period based recurring flat fee whose bill period based recurring flat fee pricing rule details you want to edit.

The **Flat Fee Pricing Rule** screen appears. It contains the following sections:

- **Customer Information** – Displays the customer information for bill group.
- **Main** – Displays the basic details of the bill period based recurring flat fee pricing rule.
- **Characteristics** – Used to define the characteristics for the bill period based recurring flat fee pricing rule.

The **Customer Information** section contains the following fields:

Field Name	Field Description	Mandatory (Yes or No)
Bill Group Information	Displays the bill group information.	Not applicable
Policy Start Date	Displays the policy start date.	Not applicable
Policy End Date	Displays the policy end date.	Not applicable
Policy Status	Indicates the policy status for pricing rule. The valid values are: <ul style="list-style-type: none"> • In Force/Active • Runout 	Not applicable
Pricing Rule Type	Indicates the pricing rule type.	Not applicable

The **Main** section contains the following fields:

Field Name	Field Description	Mandatory (Yes or No)
Price Item	Indicates the price item.	Not applicable

Field Name	Field Description	Mandatory (Yes or No)
Charge Start Date	Used to specify the flat fee charge start date.	Yes
Charge End Date	Used to specify the flat fee charge end date.	Yes
Billable Charge Line Type	Displays the billable charge line type.	Not applicable
Bill Period	Indicates the bill period for flat fee.	Not applicable
Fee	Used to specify the amount of flat fee.	Yes
	Note: This field appears when you have added the billable charge line type in the Billable Charge Line Type field.	
Bill To Account Override	Displays the account to which the bill is override.	Not applicable
Billable Charge Information	Displays the billable charge information.	Not applicable

4. Modify the basic details of the bill period based recurring flat fee pricing rule, if required.
5. Add, edit, or remove characteristics for a bill period based recurring flat fee pricing rule, if required.
6. Click **Save**.

<p>Note:</p> <p>If Fee is modified then,</p> <ul style="list-style-type: none"> • The bill period based recurring flat fee is saved as a one time charge process. <p>If Charge Start Date is modified then it checks whether bill segment is already created for a period which is not available for the updated duration then,</p> <ul style="list-style-type: none"> • Bill segment is deleted and existing billable charge is updated. • For recurring flat fee bill segments are not created or is in cancelled status. <p>Note: The modified charge start date should be a future date and not past date.</p>

The changes made to a bill period based recurring flat fee pricing rule for a bill group are saved.

Related Topics



For more information on...	See...
Customer 360° Information – Pricing tab	Customer 360° Information - Pricing Information on page 693
Bill Group ASO Policy Pricing Rules zone	Bill Group Self-Funded Policy Pricing Rules on page 702
How to define a characteristic for a bill period based recurring flat fee pricing rule	Defining a Characteristic for a Bill Period Based Recurring Flat Fee Pricing Rule on page 2753

Viewing a Bill Period Based Recurring Flat Fee Pricing Rule of a Bill Group

Procedure

To view a bill period based recurring flat fee pricing rule of a bill group:

1. Search for the account, person, or policy whose pricing details you want to view in the **Customer 360° View** screen.

2. In the **Search Results** section, click the **View** () icon corresponding to the account, person, or policy whose pricing details you want to view.
The **Account, Person, or Policy** tab in the **Customer 360° Information** screen appears.
3. Click the **Pricing** tab.
4. In the **Bill Group ASO Policy Information** zone, click the **Broadcast** () icon corresponding to the bill group whose bill period based recurring flat fee pricing rule bill group details you want to view.
5. In the **Bill Group ASO Policy Pricing Rules** zone, click the link in the **Pricing Rule Information** column corresponding to the bill period based recurring flat fee pricing rule type whose bill period
The **Pricing Rule** screen appears. It contains the following zone:
 - **Flat Fee** – Displays the pricing rule bill period based recurring flat fee details for a bill group. It contains the following sections:
 - **Main** – Displays the basic details of the bill period based recurring flat fee pricing rule.
 - **Characteristics** – Displays the characteristics defined for the bill period based recurring flat fee pricing rule.
6. View the basic details of bill period based recurring flat fee pricing rule in the **Main** section.
7. View the characteristics of the bill period based recurring flat fee pricing rule in the **Characteristics** section.



Related Topics

For more information on...	See...
Customer 360° Information – Pricing tab	Customer 360° Information - Pricing Information on page 693
Bill Group ASO Policy Pricing Rules zone	Bill Group Self-Funded Policy Pricing Rules on page 702
Pricing Rule screen	Pricing Rule (Used for Viewing) on page 2902
Flat Fee zone	Flat Fee on page 2920

Deleting a Bill Period Based Recurring Flat Fee Pricing Rule of a Bill Group

Procedure

To delete a bill period based recurring flat fee pricing rule of a bill group:

1. Search for the account, person, or policy whose pricing details you want to view in the **Customer 360° View** screen.
2. In the **Search Results** section, click the **View** () icon corresponding to the account, person, or policy whose pricing details you want to view.
The **Account, Person, or Policy** tab in the **Customer 360° Information** screen appears.
3. Click the **Pricing** tab, in the **Bill Group ASO Policy Pricing Rules** zone, click the **Delete** () icon in the **Delete** column corresponding to the bill period based recurring flat fee pricing rule type whose bill period based recurring flat
A message appears confirming whether you want to delete the bill period based recurring flat fee pricing rule.
4. Click **OK**.
The bill period based recurring flat fee pricing rule is deleted.

Related Topics

For more information on...	See...
Customer 360° Information – Pricing tab	Customer 360° Information - Pricing Information on page 693
Bill Group ASO Policy Pricing Rules zone	Bill Group Self-Funded Policy Pricing Rules on page 702

Defining a Frequency Based Recurring Flat Fee Pricing Rule Type

Prerequisites

To define a frequency based recurring flat fee pricing rule type, you should have:

- Business Object **C1-PricingRuleTypeFlatFees** defined for pricing rule type.
- Business Object **C1-PricingRuleFlatFees** defined for pricing rule.
- Pricing rule type category for flat fees defined in the application.

Procedure

To define a frequency based recurring flat fee pricing rule type:

1. Click the **Admin** link in the **Application** toolbar.
A list appears.
2. From the **Admin** menu, select **P** and then click **Pricing Rule Type**.
A sub-menu appears.
3. Click the **Add** option from the **Pricing Rule Type** sub-menu.

The **Select Business Object** screen appears. It contains the following field:

Field Name	Field Description	Mandatory (Yes or No)
Pricing Rule Type Business Object	Used to indicate the business object using which you want to create the pricing rule type. Note: You can create a frequency based recurring flat fee pricing rule type using the Flat Fee Pricing Rule Type business object.	Yes

Tip: Alternatively, you can access this screen by clicking the **Add** button in the **Page Title** area of the **Pricing Rule Type** screen.

4. Select the **Flat Fee Pricing Rule Type** business object.
5. Click **OK**.

The **Flat Fee Pricing Rule Type** screen appears. It contains the following sections:

- **Main** – Used to specify basic details about the flat fee pricing rule type.
- **Related Pricing Rule Types** – Used to define the pricing rule types which are related to the parent pricing rule type.
- **Transaction Field Mapping** – Used to specify the transaction related data mapped to the pricing rule type
- **Algorithms** – Used to define the algorithms used for the pricing rule type.
- **Additional Data** – Used to specify the additional information about the pricing rule type.
- **Price Items** – Used to define the price items assigned to the pricing rule type.
- **Price Item Parameters** – Used to define the price item parameters in the pricing rule type.

- **Characteristics** – Used to define the characteristics for the pricing rule type.
- **Billable Charge Line Types** – Used to define the pricing rule type for billable charge line type.
- **Flat Fees - Specific Additional Data** – Used to specify the flat fees specific for additional data.

The **Main** section contains the following fields:

Field Name	Field Description	Mandatory (Yes or No)
Pricing Rule Type	Used to specify the pricing rule type.	Yes
Description	Used to specify the description for the pricing rule type.	Yes
Detailed Description	Used to specify additional information about the pricing rule type.	No
Pricing Rule Business Object	Used to indicate the pricing rule business object. The valid values are: <ul style="list-style-type: none"> • Claim Pricing Rule • Aggregate Stop-Loss (ASL) Pricing Rule • Specific Stop-Loss (SSL) Pricing Rule • Retention Type Claim Based Pricing Rule • Retention Type Enrollment Based Pricing Rule • Flat Fee Pricing Rule 	Yes
Business Object	Indicates the pricing rule type business object for flat fees.	Not applicable
Status	Used to indicate the status of the pricing rule type. The valid values are: <ul style="list-style-type: none"> • Active • Inactive 	Yes
Primary	Used to select the checkbox if the pricing rule type is primary. Note: This field is not enabled for selection if the Pricing Rule Type Category is Flat Fees .	No
Pricing Rule Type Category	Used to indicate the pricing rule type category for the pricing rule type. The valid values are: <ul style="list-style-type: none"> • Claim • Aggregate Stop-Loss • Specific Stop-Loss • Retention Type Claim Based • Retention Type Enrollment Based • Flat Fees 	Yes

6. Enter the required details in the **Main** section.

7. Add the related pricing rule types in the primary pricing rule type, if required.

Note:

Related Pricing Rule Types section appears when the pricing rule type is primary.

This section does not appear when the **Pricing Rule Type Category** is **Flat Fees**.

8. Define the transaction field mapping in the primary pricing rule type, if required.

Note:

Transaction Field Mapping section appears when the pricing rule type is primary.

This section does not appear when the **Pricing Rule Type Category** is **Flat Fees**.

9. Associate algorithms with the pricing rule type, if required.

10. Define additional data for the pricing rule type, if required.

Note: This section does not appear when the **Pricing Rule Type Category** is **Flat Fees**.

11. Add pricing items in the pricing rule type, if required.

12. Add price item parameters in the pricing rule type, if required.

13. Define characteristics for the pricing rule type, if required.

14. Define billable charge line types in the flat fees pricing rule type, if required.

15. Add the flat fees - specific additional data in the pricing rule type, if required.

Note:

This section appears when the **Business Object** is **Flat Fees Pricing Rule Type**.

16. Click **Save**.

The frequency based recurring flat fee pricing rule type is defined.

Related Topics

For more information on...	See...
Pricing Rule Type screen	Pricing Rule Type on page 2532
How to add the related pricing rule types in the primary pricing rule type	Adding Related Pricing Rule Types in a Primary Pricing Rule Type on page 2549
How to define the transaction field mapping in the primary pricing rule type	Defining Transaction Field Mapping in a Primary Pricing Rule Type on page 2551
How to associate algorithms with the pricing rule type	Associating Algorithms with a Pricing Rule Type on page 2557
How to define additional data for the pricing rule type	Defining Additional Data for a Pricing Rule Type on page 2559
How to add pricing items in the pricing rule type	Adding Price Items in a Pricing Rule Type on page 2561
How to add price item parameters in the pricing rule type	Adding a Price Item Parameter in a Pricing Rule Type on page 2564
How to define a characteristic for the pricing rule type	Defining a Characteristic for a Pricing Rule Type on page 2566

For more information on...	See...
How to add the recurring flat fee specific data in the pricing rule type	Adding the Recurring Flat Fee Specific Data in a Pricing Rule Type on page 2745

Adding the Recurring Flat Fee Specific Data in a Pricing Rule Type

Procedure

To add the recurring flat fee specific data in a pricing rule type:

1. Ensure that the **Flat Fees - Specific Additional Data** section is expanded when you are defining or editing a pricing rule type.

The **Flat Fees - Specific Additional Data** section contains the following fields:

Field Name	Field Description	Mandatory (Yes or No)
Bill Segment Cancel Reason	Used to indicate the bill segment cancel reason.	No
Recurring Fee	Used to specify whether the recurring flat fee or one-time flat fee is required.	No
	Note: This field cannot be edited.	
Recurring Method	Used to indicate whether recurring bill segments must be created at the intervals defined in the bill period or at the invoice frequency. The valid values are: <ul style="list-style-type: none"> • Bill Period • Frequency 	Yes (Conditional)
	Note: This field is required when you are specifying whether the recurring flat fee is based on bill period or frequency.	
	Note: This field appears when you select the checkbox for Recurring Fee field. This field cannot be edited.	

The **Flat Fees - Specific Additional Data** section contains the following sub-section:

The **Bill Periods** sub-section contains the following column in a grid:

Column Name	Column Description	Mandatory (Yes or No)
Bill Period	Used to indicate the bill period that you want to use for specifying the intervals at which the recurring bill segments must be created.	Yes

2. Enter the required details in the **Flat Fees - Specific Additional Data** section.
3. Enter the details in the **Bill Periods** sub-section, if required.

Note: This sub-section appears when you have selected **Bill Period** as **Recurring Method**.

4. Click **Save**.

The Flat Fees - Specific Additional data is added in the pricing rule type.

Related Topics

For more information on...	See...
How to define a bill period based recurring flat fee pricing rule type	Defining a Bill Period Based Recurring Flat Fee Pricing Rule Type on page 2742
How to define a frequency based recurring flat fee pricing rule type	Defining a Frequency Based Recurring Flat Fee Pricing Rule Type on page 2757
How to edit a bill period based recurring flat fee pricing rule type	Editing a Bill Period Based Recurring Flat Fee Pricing Rule Type on page 2746
How to edit a frequency based recurring flat fee pricing rule type	Editing a Frequency Based Recurring Flat Fee Pricing Rule Type on page 2761

Editing a Frequency Based Recurring Flat Fee Pricing Rule Type**Prerequisites**

To edit a frequency based recurring flat fee pricing rule type, you should have:

- Business Object **C1-PricingRuleFlatFees** defined for pricing rule.
- Pricing rule type category for flat fees defined in the application.

Procedure

To edit a frequency based recurring flat fee pricing rule type:

1. Click the **Admin** link in the **Application** toolbar.

A list appears.

2. From the **Admin** menu, select **P** and then click **Pricing Rule Type**.

A sub-menu appears.

3. Click the **Search** option from the **Pricing Rule Type** sub-menu.

The **Pricing Rule Type** screen appears.

4. In the **Pricing Rule Type List** zone, click the **Edit** (✎) icon in the **Edit** column corresponding to the Pricing rule type whose details you want to edit.

The **Pricing Rule Type** screen appears. It contains the following sections:

- **Main** – Used to specify basic details about the flat fee pricing rule type.
- **Related Pricing Rule Types** – Used to define the pricing rule types which are related to the parent pricing rule type.
- **Transaction Field Mapping** – Used to specify the transaction related data mapped to the pricing rule type
- **Algorithms** – Used to define the algorithms used for the pricing rule type.
- **Additional Data** – Used to specify the additional information about the pricing rule type.
- **Price Items** – Used to define the price items assigned to the pricing rule type.
- **Price Item Parameters** – Used to define the price item parameters in the pricing rule type.
- **Characteristics** – Used to define the characteristics for the pricing rule type.
- **Billable Charge Line Types** – Used to define the pricing rule type for billable charge line type.
- **Flat Fees - Specific Additional Data** – Used to specify the flat fees specific for additional data.

The **Main** section contains the following fields:

Field Name	Field Description	Mandatory (Yes or No)
Pricing Rule Type	Displays the pricing rule type.	Not applicable
Description	Used to specify the description for the pricing rule type.	Yes
Detailed Description	Used to specify additional information about the pricing rule type.	No
Pricing Rule Business Object	Used to indicate the pricing rule business object. The valid values are: <ul style="list-style-type: none"> • Claim Pricing Rule • Aggregate Stop-Loss (ASL) Pricing Rule • Specific Stop-Loss (SSL) Pricing Rule • Retention Type Claim Based Pricing Rule • Retention Type Enrollment Based Pricing Rule • Flat Fee Pricing Rule 	Yes
Business Object	Indicates the pricing rule type business object for flat fees.	Not applicable
Status	Used to indicate the status of the pricing rule type. The valid values are: <ul style="list-style-type: none"> • Active • Inactive 	Yes
Primary	Used to select the checkbox if the pricing rule type is primary. Note: This field is not enabled for selection if the Pricing Rule Type Category is Flat Fees .	No
Pricing Rule Type Category	Used to indicate the pricing rule type category for the pricing rule type. The valid values are: <ul style="list-style-type: none"> • Claim • Aggregate Stop-Loss • Specific Stop-Loss • Retention Type Claim Based • Retention Type Enrollment Based • Flat Fees 	Yes

Tip: Alternatively, you can edit the details of a frequency based recurring flat fees pricing rule type by clicking the **Edit** button in the **Pricing Rule Type** zone.

5. Modify the required details in the **Main** section.
6. Define, edit or remove related pricing rule types from the primary pricing rule type, if required.

Note:

Related Pricing Rule Types section appears when the pricing rule type is primary.
This section does not appear when the **Pricing Rule Type Category** is **Flat Fees**.

7. Modify the details of transaction field mapping, if required.

Note:

Transaction Field Mapping section appears when the pricing rule type is primary.
This section does not appear when the **Pricing Rule Type Category** is **Flat Fees**.

8. Define, edit or remove algorithms from the pricing rule type, if required.
9. Modify additional data for the pricing rule type, if required.

Note: This section does not appear when the **Pricing Rule Type Category** is **Flat Fees**.

10. Define, edit or remove price items from the pricing rule type, if required.
11. Define, edit or remove price items from the pricing rule type, if required.
12. Define, edit, or remove characteristics of the pricing rule type, if required.
13. Define, edit or remove billable charge line types for the flat fees pricing rule type, if required.
14. Modify flat fees - specific additional data in the pricing rule type, if required.

Note: This section appears when the **Business Object** is **Flat Fees Pricing Rule Type**.

15. Click **Save**.

The changes made to the frequency based recurring flat fee pricing rule type are saved.

Related Topics

For more information on...	See...
Pricing Rule Type screen	Pricing Rule Type on page 2532
Pricing Rule Type List zone	Pricing Rule Type List on page 2533
Pricing Rule Type zone	Pricing Rule Type on page 2536
How to add the related pricing rule types in the primary pricing rule type	Adding Related Pricing Rule Types in a Primary Pricing Rule Type on page 2549
How to define the transaction field mapping in the primary pricing rule type	Defining Transaction Field Mapping in a Primary Pricing Rule Type on page 2551
How to associate algorithms with the pricing rule type	Associating Algorithms with a Pricing Rule Type on page 2557
How to define additional data for the pricing rule type	Defining Additional Data for a Pricing Rule Type on page 2559
How to add pricing items in the pricing rule type	Adding Price Items in a Pricing Rule Type on page 2561
How to add price item parameters in the pricing rule type	Adding a Price Item Parameter in a Pricing Rule Type on page 2564
How to define a characteristic for the pricing rule type	Defining a Characteristic for a Pricing Rule Type on page 2566

For more information on...	See...
How to add the recurring flat fee specific data in the pricing rule type	Adding the Recurring Flat Fee Specific Data in a Pricing Rule Type on page 2745

Deleting a Frequency Based Recurring Flat Fee Pricing Rule Type

Procedure

To delete a frequency based recurring flat fee pricing rule type:

1. Click the **Admin** link in the **Application** toolbar.
A list appears.
2. From the **Admin** menu, select **P** and then click **Pricing Rule Type**.
A sub-menu appears.
3. Click the **Search** option from the **Pricing Rule Type** sub-menu.
The **Pricing Rule Type** screen appears.
4. In the **Pricing Rule Type List** zone, click the **Delete** (🗑️) icon in the **Delete** column corresponding to the frequency based recurring flat fee pricing rule type that you want to delete.

A message appears confirming whether you want to delete the frequency based recurring flat fee pricing rule type.

Note: You can delete a frequency based recurring flat fee pricing rule type when it is not yet used in the system.

Tip: Alternatively, you can delete a frequency based recurring flat fee pricing rule type by clicking the **Delete** button in the **Pricing Rule Type** zone.

5. Click **OK**.

The frequency based recurring flat fee pricing rule type is deleted.

Related Topics

For more information on...	See...
Pricing Rule Type screen	Pricing Rule Type on page 2532
Pricing Rule Type List zone	Pricing Rule Type List on page 2533
Pricing Rule Type zone	Pricing Rule Type on page 2536

Viewing the Frequency Based Recurring Flat Fee Pricing Rule Type Details

Procedure

To view the details of a frequency based recurring flat fee pricing rule type:

1. Click the **Admin** link in the **Application** toolbar.
A list appears.
2. From the **Admin** menu, select **P** and then click **Pricing Rule Type**.
A sub-menu appears.
3. Click the **Search** option from the **Pricing Rule Type** sub-menu.
The **Pricing Rule Type** screen appears.

4. In the **Pricing Rule Type List** zone, click the **Broadcast** (📡) icon corresponding to the frequency based recurring flat fee pricing rule type whose details you want to view.

The **Pricing Rule Type** zone appears.

5. View the details of the frequency based recurring flat fee pricing rule type in the **Pricing Rule Type** zone.

Related Topics

For more information on...	See...
Pricing Rule Type screen	Pricing Rule Type on page 2532
Pricing Rule Type List zone	Pricing Rule Type List on page 2533
Pricing Rule Type zone	Pricing Rule Type on page 2536

Defining a Frequency Based Recurring Flat Fee Pricing Rule for a Bill Group

Prerequisites

To define a frequency based recurring flat fee pricing rule for a bill group, you should have:

- Business Object **C1-PricingRule** defined for pricing rule.
- Business Object **C1-PricingRuleFlatFees** defined for frequency based recurring flat fee pricing rule.
- Pricing rule type defined in the application.
- Policy status defined in the application.
- Price item defined in the application.
- Billable Charge Line Type defined in the application.

Procedure

To define a frequency based recurring flat fee pricing rule for a bill group:

1. Search for the account, person, or policy whose pricing details you want to view in the **Customer 360° View** screen.
2. In the **Search Results** section, click the **View** (🔍) icon corresponding to the account, person, or policy whose pricing details you want to view.
The **Account**, **Person**, or **Policy** tab in the **Customer 360° Information** screen appears.
3. Click the **Pricing** tab and then click the **Add** link in the upper right corner of the **Bill Group ASO Policy Pricing Rules** zone.

The **Pricing Rule** screen appears. It contains the following fields:

Field Name	Field Description	Mandatory (Yes or No)
Person Name	Displays the person name.	Not applicable
Person Type	Displays the person type.	Not applicable
Pricing Rule Type	Used to indicate the pricing rule type to create the pricing rule. Note: You can create a frequency based recurring flat fee pricing rule using the Pricing Rule Type for flat fees.	Yes

Field Name	Field Description	Mandatory (Yes or No)
Policy Status	Used to indicate the policy status for pricing rule. The valid values are: <ul style="list-style-type: none"> In Force/Active Runout 	Yes

4. Click **OK**.

The **Flat Fee Pricing Rule** screen appears. It contains the following sections:

- **Customer Information** – Displays the customer information for bill group.
- **Main** – Used to specify basic details about the frequency based recurring flat fee pricing rule.
- **Characteristics** – Used to define the characteristics for the frequency based recurring flat fee pricing rule.

The **Customer Information** section contains the following fields:

Field Name	Field Description	Mandatory (Yes or No)
Bill Group Information	Displays the bill group information.	Not applicable
Policy Start Date	Displays the policy start date.	Not applicable
Policy End Date	Displays the policy end date.	Not applicable
Policy Status	Indicates the policy status for pricing rule. The valid values are: <ul style="list-style-type: none"> In Force/Active Runout 	Not applicable
Pricing Rule Type	Indicates the pricing rule type.	Not applicable

The **Main** section contains the following fields:

Field Name	Field Description	Mandatory (Yes or No)
Price Item	Used to indicate the price item.	Yes
Charge Start Date	Used to specify the flat fee charge start date.	Yes
Billable Charge Line Type	Used to specify the billable charge line type. <div style="border: 1px solid black; padding: 5px; margin-top: 5px;"> <p>Note:</p> <p>On clicking the Search (🔍) icon, the Billable Charge Line Type Search window appears.</p> <p>On specifying the billable charge line type, the description of the billable charge line type appears corresponding to the Billable Charge Line Type field.</p> </div>	No
Charge End Date	Used to specify the flat fee charge end date.	No
Frequency	Used to indicate the frequency for flat fee.	Yes

Field Name	Field Description	Mandatory (Yes or No)
Fee	Used to specify the amount of flat fee.	Yes
	Note: This field appears when you select the billable charge line type in the Billable Charge Line Type field.	
Bill To Account Override	Used to specify the account to which the bill is override.	Yes
	Note: On clicking the Search (🔍) icon, the Account Search window appears. On specifying the account, the description of the account appears corresponding to the Bill To Account Override field.	

5. Enter the required details in the **Main** section.
6. Define characteristics for a frequency based recurring flat fee pricing rule, if required.
7. Click **Save**.

The frequency based recurring flat fee pricing rule for a bill group is defined.

Note: A billable charge is created and assigned to the frequency based recurring flat fee pricing rule.

Related Topics

For more information on...	See...
Customer 360° Information – Pricing tab	Customer 360° Information - Pricing Information on page 693
Bill Group ASO Policy Pricing Rules zone	Bill Group Self-Funded Policy Pricing Rules on page 702
How to define a characteristic for a frequency based recurring flat fee pricing rule	Defining a Characteristic for a Frequency Based Recurring Flat Fee Pricing Rule on page 2767

Defining a Characteristic for a Frequency Based Recurring Flat Fee Pricing Rule

Prerequisites

To define a characteristic for a frequency based recurring flat fee pricing rule, you should have:

- Characteristic types defined in the application (where the characteristic entity is set to **Pricing Rule**)

Procedure

To define a characteristic for a frequency based recurring flat fee pricing rule:

1. Ensure that the **Characteristics** section is expanded when you are defining or editing a pricing rule.

The **Characteristics** section contains the following columns in a grid:

Column Name	Column Description	Mandatory (Yes or No)
Effective Date	Used to specify the date from when the characteristic is effective for the frequency based recurring flat fee pricing rule.	Yes (Conditional)
		Note: This field is required when you are defining a characteristic for the frequency based recurring flat fee pricing rule.
Characteristic Type	Used to indicate the characteristic type. Note: The list includes only those characteristic types where the characteristic entity is set to Pricing Rule .	Yes (Conditional)
		Note: This field is required when you are defining a characteristic for the frequency based recurring flat fee pricing rule.
Characteristic Value	Used to specify the value for the characteristic type. Note: If you select a predefined characteristic type, the Search (🔍) icon appears corresponding to the Characteristic Value field. On clicking the Search icon, the Predefined Characteristic Search window appears. On specifying the value for a predefined characteristic type, the description of the characteristic value appears corresponding to the Characteristic Value field.	Yes (Conditional)
		Note: This field is required when you are defining a characteristic for the frequency based recurring flat fee pricing rule.

- Enter the required details in the **Characteristics** section.
- If you want to define more than one characteristic for the frequency based recurring flat fee pricing rule, click the **Add** (+) icon and then repeat step 2.

Note: However, if you want to remove a characteristic from the frequency based recurring flat fee pricing rule, click the **Delete** (🗑️) icon corresponding to the characteristic.

- Click **Save**.

The characteristics are defined for the frequency based recurring flat fee pricing rule.

Related Topics

For more information on...	See...
How to define a frequency based recurring flat fee pricing rule for a bill group	Defining a Frequency Based Recurring Flat Fee Pricing Rule for a Bill Group on page 2765
How to edit the frequency based recurring flat fee pricing rule for a bill group	Editing a Frequency Based Recurring Flat Fee Pricing Rule of a Bill Group on page 2768

Editing a Frequency Based Recurring Flat Fee Pricing Rule of a Bill Group

Prerequisites

To edit a frequency based recurring flat fee pricing rule of a bill group, you should have:

- Business Object **C1-PricingRuleFlatFees** defined for frequency based recurring flat fee pricing rule.

Procedure

To edit a frequency based recurring flat fee pricing rule of a bill group:

1. Search for the account, person, or policy whose pricing details you want to view in the **Customer 360° View** screen.
2. In the **Search Results** section, click the **View** (🔗) icon corresponding to the account, person, or policy whose pricing details you want to view.

The **Account, Person, or Policy** tab in the **Customer 360° Information** screen appears.

3. Click the **Pricing** tab, in the **Bill Group ASO Policy Pricing Rules** zone click the **Edit** (🔗) icon in the **Edit** column corresponding to the pricing rule type for frequency based recurring flat fee whose frequency based recurring flat

The **Flat Fee Pricing Rule** screen appears. It contains the following sections:

- **Customer Information** – Displays the customer information for bill group.
- **Main** – Displays the basic details of the frequency based recurring flat fee pricing rule.
- **Characteristics** – Used to define the characteristics for the frequency based recurring flat fee pricing rule.

The **Customer Information** section contains the following fields:

Field Name	Field Description	Mandatory (Yes or No)
Bill Group Information	Displays the bill group information.	Not applicable
Policy Start Date	Displays the policy start date.	Not applicable
Policy End Date	Displays the policy end date.	Not applicable
Policy Status	Indicates the policy status for pricing rule. The valid values are: <ul style="list-style-type: none"> • In Force/Active • Runout 	Not applicable
Pricing Rule Type	Indicates the pricing rule type.	Not applicable

The **Main** section contains the following fields:

Field Name	Field Description	Mandatory (Yes or No)
Price Item	Indicates the price item.	Not applicable
Charge Start Date	Used to specify the flat fee charge start date.	Yes
Charge End Date	Used to specify the flat fee charge end date.	Yes
Billable Charge Line Type	Displays the billable charge line type.	Not applicable
Frequency	Indicates the frequency for flat fee.	Not applicable
Fee	Used to specify the amount of flat fee.	Yes
	Note: This field appears when you have added the billable charge line type in the Billable Charge Line Type field.	

Field Name	Field Description	Mandatory (Yes or No)
Bill To Account Override	Displays the account to which the bill is override.	Not applicable
Billable Charge Information	Displays the billable charge information.	Not applicable

4. Modify the basic details of the frequency based recurring flat fee pricing rule, if required.
5. Add, edit, or remove characteristics for a frequency based recurring flat fee pricing rule, if required.
6. Click **Save**.

Note:

If **Fee** is modified then,

- The frequency based recurring flat fee is saved as a one time charge process.

If **Charge Start Date** is modified then it checks whether bill segment is already created for a period which is not available for the updated duration then,

- Bill segment is deleted and existing billable charge is updated.
- For recurring flat fee bill segments are not created or is in cancelled status.

Note: The modified charge start date should be a future date and not past date.

The changes made to a frequency based recurring flat fee pricing rule for a bill group are saved.

Related Topics

For more information on...	See...
Customer 360° Information – Pricing tab	Customer 360° Information - Pricing Information on page 693
Bill Group ASO Policy Pricing Rules zone	Bill Group Self-Funded Policy Pricing Rules on page 702
How to define a characteristic for a frequency based recurring flat fee pricing rule	Defining a Characteristic for a Frequency Based Recurring Flat Fee Pricing Rule on page 2767

Viewing a Frequency Based Recurring Flat Fee Pricing Rule of a Bill Group**Procedure**

To view a frequency based recurring flat fee pricing rule of a bill group:

1. Search for the account, person, or policy whose pricing details you want to view in the **Customer 360° View** screen.
2. In the **Search Results** section, click the **View** (🔗) icon corresponding to the account, person, or policy whose pricing details you want to view.

The **Account, Person, or Policy** tab in the **Customer 360° Information** screen appears.

3. Click the **Pricing** tab.
4. In the **Bill Group ASO Policy Information** zone, click the **Broadcast** (📡) icon corresponding to the bill group whose frequency based recurring flat fee pricing rule bill group details you want to view.
5. In the **Bill Group ASO Policy Pricing Rules** zone, click the link in the **Pricing Rule Information** column corresponding to the frequency based recurring flat fee pricing rule type whose frequency based flat fee pricing rule bill group

The **Pricing Rule** screen appears. It contains the following zone:

- **Flat Fee** – Displays the pricing rule frequency based recurring flat fee details for a bill group. It contains the following sections:
 - **Main** – Displays the basic details of the frequency based recurring flat fee pricing rule.
 - **Characteristics** – Displays the characteristics defined for the frequency based recurring flat fee pricing rule.
6. View the basic details of frequency based recurring flat fee pricing rule in the **Main** section.
 7. View the characteristics of the frequency based recurring flat fee pricing rule in the **Characteristics** section.

Related Topics

For more information on...	See...
Customer 360° Information – Pricing tab	Customer 360° Information - Pricing Information on page 693
Bill Group ASO Policy Pricing Rules zone	Bill Group Self-Funded Policy Pricing Rules on page 702
Pricing Rule screen	Pricing Rule (Used for Viewing) on page 2902
Flat Fee zone	Flat Fee on page 2920

Deleting a Frequency Based Recurring Flat Fee Pricing Rule of a Bill Group

Procedure

To delete a frequency based recurring flat fee pricing rule of a bill group:

1. Search for the account, person, or policy whose pricing details you want to view in the **Customer 360° View** screen.
2. In the **Search Results** section, click the **View** () icon corresponding to the account, person, or policy whose pricing details you want to view.

The **Account, Person, or Policy** tab in the **Customer 360° Information** screen appears.

3. Click the **Pricing** tab, in the **Bill Group ASO Policy Pricing Rules** zone, click the **Delete** () icon in the **Delete** column corresponding to the frequency based recurring flat fee pricing rule type whose frequency based recurring flat fee pricing rule you want to delete. A message appears confirming whether you want to delete the frequency based recurring flat fee pricing rule.
4. Click **OK**.

The frequency based recurring flat fee pricing rule is deleted.

Related Topics

For more information on...	See...
Customer 360° Information – Pricing tab	Customer 360° Information - Pricing Information on page 693
Bill Group ASO Policy Pricing Rules zone	Bill Group Self-Funded Policy Pricing Rules on page 702

Ancillary Pricing

The Administrative Services Only (ASO) provider may process some adhoc charges with respect to preventive care, vaccination, diagnostic, and so on. These adhoc charges may also occur due to some corrections in the claim transactions which are already billed to the customer. Oracle Revenue Management and Billing enables you to process and bill these ancillary transactions to the self-funded employer.

The system enables you to create an ancillary charge in either of the following ways:

- Create a pass through charge without markup or markdown (i.e. flat charge).
- Create a pass through charge with a flat or percentage based markup or markdown.
- Create a rate based charge using the rate defined in the ancillary pricing and the service quantity specified in the ancillary transaction. You can also apply markup or markdown to a rate based charge.

You can use any custom mechanism or the file upload utility in ORMB to upload the ancillary transactions. The pricing for the ancillary transactions can be defined using the ancillary pricing rules. You can define an ancillary pricing rule at the parent customer and bill group levels. The ancillary pricing rule at the bill group level takes precedence over the ancillary pricing rule at the parent customer level. You can define the ancillary pricing rules for parent customers and bill groups from the **Customer 360^o Information** screen. You can define an ancillary pricing rule using an ancillary pricing rule type. It is the ancillary pricing rule type which helps the system to determine:

- Business object using which the ancillary pricing rule should be created in the system.
- Whether it is the primary pricing rule type from where the related pricing rule types will inherit the transaction field mapping details.

Note: You must select the **Primary** option while defining an ancillary pricing rule type. On selecting the **Primary** option, the **Related Pricing Rule Types** and **Transaction Field Mapping** sections appear in the **Ancillary Pricing Rule Type** screen.

- Rule type which indicates the rules that should be executed to determine whether the related pricing rule type is eligible for deriving the transaction legs.
- Transaction fields from where the data from the ancillary transaction should be stored in the respective fields (for example, the data from the **UDF_CHAR_1** transaction field must be stored in the **Parameter 1** field which will be used for deriving the bill group and pricing).
- Algorithm which should be triggered for validating an ancillary transaction.

Note: An algorithm type for validating an ancillary transaction is not shipped with the product. You can create a custom algorithm type, if required.

- Algorithm which should be triggered for deriving the bill group, parent customer, and policy for an ancillary transaction.

Note: You must create an algorithm using the **C1_TXNBGDRV** algorithm type and attach it to the **Bill Group Derivation** system event.

- Algorithm which should be triggered for deriving the account and price item for an ancillary transaction.

Note: You must create an algorithm using the **C1_ACCPRIDRV** algorithm type and attach it to the **Account and Price Item Derivation** system event.

- Algorithm which should be triggered for determining the bill after date.

Note: You must create an algorithm using the **C1_BAFTDRV** algorithm type and attach it to the **Bill After Date Determination** system event.

- Pricing rule post-processing algorithm which should be triggered once the effective ancillary pricing rule is derived.

Note: A pricing rule post-processing algorithm type is not shipped with the product. You can create a custom algorithm type, if required.

- Additional generic information, such as:
 - Whether the price items included in the ancillary pricing rule type are eligible for specific stop-loss and aggregate stop-loss.

- Whether the price items included in the ancillary pricing rule type are eligible for level funding.
- Whether the ancillary charges should be written off when the bill is generated in the post runout period of the policy. In this case, a write-off adjustment is created against the respective bill segment during the post bill completion. The write-off adjustment is created using the post runout write-off adjustment type which is specified in the ancillary pricing rule type.
- Transaction field which you want to use in the rules as the output parameter to determine whether the price item should be considered for billing.
- Transaction field which you want to use in the rules as the output parameter to determine whether the related pricing rule type should be considered for deriving the transaction legs.
- Value which the output parameter in the rule should return when the price item and related pricing rule type in the ancillary pricing rule type should be considered for processing.
- Price items for which you can define ancillary pricing rules using the ancillary pricing rule type.
- Rate options that you can use while defining the pricing for the ancillary price items.
- Different type of account to which a price item should be billed based on the specified priority.
- Rule type which indicates the rules that should be executed to determine whether the price item is eligible for billing.
- Price item parameters based on which you want to define the price item pricing. Two price item parameters are mandatory in the ancillary pricing rule type – one which stores the billable charge line type from the ancillary transaction and another which stores the pricing arrangement from the ancillary transaction. The following pricing arrangements are supported in the ancillary pricing rule:
 - Pass Through Charge Without Markup and Markdown
 - Pass Through Charge With Markup and Markdown
 - Rate Based Charge Without Markup and Markdown
 - Rate Based Charge With Markup and Markdown

Note: The price item parameters (for example, BCHGLINETYPE and PRICINGARRANGEMENT) which you include in the ancillary pricing rule type must be defined in the **Billable Charge Line Type Parameter** and **Pricing Arrangement Parameter** option types of the **C1-ASOBLNG** feature configuration, respectively.

- Additional ancillary-specific information, such as:
 - Identifiers which help to determine whether the ancillary transaction is eligible for billing for not.
 - Transaction field which you want to use in the rules as the output parameter to determine whether the markup or markdown calculation line is eligible for billing.
 - Billable charge line type using which you want to create billable charges for markup and markdown.
 - Rule type which indicates the rules which should be executed to determine whether the markup or markdown calculation line is eligible for billing.
 - How the system should interpret the value stored in the pricing arrangement price item parameter (i.e. whether the value means the ancillary charge should be a pass through charge without markup or markdown, pass through charge with markup or markdown, or rate based charge with or without markup or markdown). Accordingly, the system will search for the pricing in the effective ancillary pricing rule where:
 - Billable charge line type matches the one specified in the ancillary transaction
 - Line defined for the billable charge line type has the pricing arrangement as mentioned in the ancillary transaction
 - Line item which indicates the SQI using which the ancillary charge should be created. You need to specify the line item for each pricing arrangement which is defined in the ancillary pricing rule type.

Once an ancillary pricing rule type is defined, you can create ancillary pricing rules using the ancillary pricing rule type. While defining an ancillary pricing rule for a parent customer and bill group, you need to specify the following:

- Price item for which you want to define the pricing.
- Pricing date range during which the pricing is effective.
- Rate option which you want to use while defining the ancillary pricing.
- Whether you want to define the pricing for a pass through charge without markup or markdown. If you select the **Pass Through without Markup or Markdown** option, you cannot define the pricing for a pass through charge with markup or markdown and the pricing for rate based charge with or without markup or markdown in the ancillary pricing rule. However, if the **Pass Through without Markup or Markdown** option is not selected, you can define pricing for different billable charge line types which can be with markup or markdown or which can be rate based with or without markup or markdown. In addition, if the **Pass Through without Markup or Markdown** option is not selected, by default, the system will define the pricing for a pass through charge without markup or markdown. Depending on the billable charge line type and pricing arrangement information in the ancillary transaction, the system will accordingly fetch the appropriate pricing for billing the ancillary charge. For example, if the ancillary transaction contains BCLT1 as the billable charge line type and PASSMK as the pricing arrangement and the effective ancillary pricing rule contains the following pricing:

Ancillary Pricing	Billable Charge Line Type	Pricing Arrangement	Rate	Pricing Strategy	Markup Amount	Markdown Amount
AP1	BCLT0	Pass Through with Markup or Markdown	-	Markup	\$10	-
AP2	BCLT1	Pass Through with Markup or Markdown	-	Markdown	-	\$5
AP3	BCLT2	Rate Based without Markup or Markdown	\$5	-	-	-
AP4	BCLT3	Rate Based with Markup or Markdown	\$5	Markup	\$10	-
AP5	BCLT4	Rate Based with Markup or Markdown	\$5	Markdown	-	\$5
AP6	-	Pass Through without Markup or Markdown	-	-	-	-

In this case, the system will use the AP2 pricing defined in the ancillary pricing rule. The system will markdown the SQI with the specified amount (i.e. \$5).

- Whether the billable charge line type is eligible for billing or not. Accordingly, the system will create billable charge for the ancillary transaction.

In addition, while defining an ancillary pricing rule for a bill group, you need to indicate the policy status for which the ancillary pricing rule is applicable. You can also specify a pricing group while defining an ancillary pricing rule for a bill group. Once an ancillary pricing rule is created, the system creates multiple price assignments in a price list and assigns the price list to the bill group.

Defining an Ancillary Pricing Rule Type

Prerequisites

To define an ancillary pricing rule type, you should have:

- Ancillary pricing rule type business object defined in the application.
- Ancillary pricing rule business object defined in the application.

Procedure

To define an ancillary pricing rule type:

1. Click the **Admin** link in the **Application** toolbar.
A list appears.
2. From the **Admin** menu, select **P** and then click **Pricing Rule Type**.

A sub-menu appears.

3. Click the **Add** option from the **Pricing Rule Type** sub-menu.

The **Select Business Object** screen appears. It contains the following field:

Field Name	Field Description	Mandatory (Yes or No)
Pricing Rule Type Business Object	<p>Used to indicate the business object using which you want to create an ancillary pricing rule type. The valid values are:</p> <ul style="list-style-type: none"> • Aggregate Stop-Loss (ASL) Pricing Rule Type • Ancillary Pricing Rule Type • Claim Pricing Rule Type • Discount Arrangement Pricing Rule Type • Flat Fee Pricing Rule Type • Level Funded (LF) Pricing Rule Type • Retention Type Claim Based Pricing Rule Type • Retention Type Enrollment Based Pricing Rule Type • Specific Stop-Loss (SSL) Pricing Rule Type <p>Note: You must select the Ancillary Pricing Rule Type option from the Pricing Rule Type Business Object list while defining an ancillary pricing rule type.</p>	Yes

Tip: Alternatively, you can access this screen by clicking the **Add** button in the **Page Title** area of the **Pricing Rule Type** screen.

4. Select the **Ancillary Pricing Rule Type** option from the **Pricing Rule Type Business Object** list.
5. Click **OK**.

The **Ancillary Pricing Rule Type** screen appears. It contains the following sections:

- **Main** – Used to specify the basic details about the ancillary pricing rule type.
- **Related Pricing Rule Types** – Used to indicate the non-primary pricing rule types which should inherit the transaction field mapping details from the ancillary pricing rule type. You can add a pricing rule type which belongs to the following category:
 1. Specific Stop Loss
 2. Aggregate Stop Loss
 3. Level Funding

Note: You can use any of the above specified pricing rule types as the related pricing rule type in an ancillary pricing rule type.

- **Transaction Field Mapping** – Used to map the transaction fields in a ancillary transaction to the appropriate fields in the ancillary pricing rule type. This helps the system to determine the field where the data from the transaction field must be stored. This data is then used in the system for various reasons, such as for deriving a bill group and pricing, deriving an effective related pricing rule, and so on.

Note: The **Billing Eligibility Identifier** field is required when you are defining the **Transaction Field Mapping** for an ancillary pricing rule type.

- **Algorithms** – Used to associate the algorithms with an ancillary pricing rule type.
- **Additional Data** – Used to specify additional information about the ancillary pricing rule type.
- **Price Items** – Used to add the price items for which you can define the ancillary pricing rules using the ancillary pricing rule type.
- **Price Item Parameters** – Used to add the price item parameters based on which you want to define the price item pricing.

Note: There are two price item parameters that are mandatory in the ancillary pricing rule type:

- A price item which stores the billable charge line type from the ancillary transaction.
- A price item which stores the pricing arrangement from the ancillary transaction.

- **Characteristics** – Used to define the characteristics for an ancillary pricing rule type.
- **Ancillary-Specific Additional Data** – Used to define the ancillary-specific additional data in an ancillary pricing rule type.

Note: Following fields are required when you are defining the **Ancillary-Specific Additional Data** for the ancillary pricing rule type.

- **Billing Eligibility Identifier Value**
- **Billing Non-Eligibility Identifier Value**

- **Pricing Arrangements** – Used to define the following pricing arrangements that are used while defining an ancillary pricing rule type.
 - **Pass Through (Markup or Markdown Optional)**
 - **Pass Through Without Markup or Markdown**
 - **Rate Based (Markup or Markdown Optional)**

The **Main** section contains the following fields:

Field Name	Field Description	Mandatory (Yes or No)
Pricing Rule Type	Used to specify the ancillary pricing rule type.	Yes
Description	Used to specify the description for the ancillary pricing rule type.	Yes
Detailed Description	Used to specify additional information about the ancillary pricing rule type.	No

Field Name	Field Description	Mandatory (Yes or No)
Pricing Rule Business Object	<p>Used to indicate the business object using which you want to create the ancillary pricing rule. The valid values are:</p> <ul style="list-style-type: none"> • Aggregate Stop-Loss (ASL) Pricing Rule • Ancillary Pricing Rule • Claim Pricing Rule • Discount Arrangement Pricing Rule • Flat Fee Pricing Rule • Level Funded (LF) Pricing Rule • Retention Type Claim Based Pricing Rule • Retention Type Enrollment Based Pricing Rule • Specific Stop-Loss (SSL) Pricing Rule <p>Note: You must select the Ancillary Pricing Rule option from the Pricing Rule Business Object list while defining an ancillary pricing rule type.</p>	Yes
Business Object	Indicates the business object using which you are defining the ancillary pricing rule type.	Not applicable
Status	<p>Used to indicate the status of the ancillary pricing rule type. The valid values are:</p> <ul style="list-style-type: none"> • Active • Inactive 	Yes
Primary	Used to indicate whether the ancillary pricing rule type is a primary pricing rule type.	No
Pricing Rule Type Category	<p>Used to indicate the category to which the ancillary pricing rule type belongs. The valid value are:</p> <ul style="list-style-type: none"> • Aggregate Stop-Loss • Ancillary • Claim • Discount Arrangement • Flat Fees • Level Funded • Retention Type Claim Based • Retention Type Enrollment Based • Specific Stop-Loss <p>Note: You must select the Ancillary option from the Pricing Rule Type Category list while defining an ancillary pricing rule type.</p>	Yes

6. Enter the required details in the **Main** section.

7. Select the **Ancillary Pricing Rule** option from the **Pricing Rule Business Object** list.
8. Select the **Primary** option in the **Main** section.

The **Related Pricing Rule Types** and **Transaction Field Mapping** sections appear.

9. Select the **Ancillary** option from the **Pricing Rule Type Category** list.
10. Add the related pricing rule types in the ancillary pricing rule type, if required.
11. Map the transaction fields of an ancillary transaction to the appropriate fields in the ancillary pricing rule type.
12. Associate the following algorithms with the ancillary pricing rule type:

System Event	Algorithm	Algorithm Type	Description
Bill Group Derivation	C1_TXNBGDRV	C1_TXNBGDRV	Derive Bill Group
Account and Price Item Derivation	C1_ACCPRIDRV	C1_ACCPRIDRV	Account and Price Item Derivation
Bill After Date Determination	C1_BAFTDRV	C1_BAFTDRV	Bill After Date Determination

13. Define additional data for an ancillary pricing rule type, if required.
14. Add the required price items for which you can define ancillary pricing rules using the ancillary pricing rule type.
15. Add the price item parameters based on which you want to define the ancillary pricing, if required.
16. Define the characteristics for an ancillary pricing rule type, if required.
17. Define the required ancillary-specific additional data in the ancillary pricing rule type.
18. Define the pricing arrangements for an ancillary pricing rule type, if required.
19. Click **Save**.

The ancillary pricing rule type is defined.

Related Topics

For more information on...	See...
How to add the related pricing rule types in the primary pricing rule type	Adding Related Pricing Rule Types in a Primary Pricing Rule Type on page 2549
How to define the transaction field mapping in the primary pricing rule type	Defining Transaction Field Mapping in a Primary Pricing Rule Type on page 2551
How to associate algorithms with the pricing rule type	Associating Algorithms with a Pricing Rule Type on page 2557
How to define additional data for the pricing rule type	Defining Additional Data for a Pricing Rule Type on page 2559
How to add pricing items in the pricing rule type	Adding Price Items in a Pricing Rule Type on page 2561
How to add price item parameters in the pricing rule type	Adding a Price Item Parameter in a Pricing Rule Type on page 2564
How to define a characteristic for the pricing rule type	Defining a Characteristic for a Pricing Rule Type on page 2566
How to define ancillary-specific data in the pricing rule type	Defining the Ancillary-Specific Data in an Ancillary Pricing Rule Type on page 2795

For more information on...	See...
How to define pricing arrangements for the pricing rule type	Defining Pricing Arrangements in an Ancillary Pricing Rule Type on page 2797

Adding a Related Pricing Rule Type in an Ancillary Pricing Rule Type

The **Administrative Services Only (ASO)** feature is designed in such a way that all non-primary pricing rule types should inherit the transaction field mapping details from a primary pricing rule type. These non-primary pricing rule types are added in a primary pricing rule type as the related pricing rule types.

Prerequisites

To add related pricing rule types in an ancillary pricing rule type, you should have:

- Aggregate Stop Loss pricing rule type defined in the application.
- Specific Stop Loss pricing rule type defined in the application.
- Level Funding pricing rule type defined in the application.
- Rule types defined in the application (where the rule type usage is set to **Related Pricing Rule Type Eligibility**)

Procedure

To add related pricing rule type in an ancillary pricing rule type:

1. Ensure that the **Related Pricing Rule Types** section is expanded when you are defining or editing an ancillary pricing rule type.

Note: The **Related Pricing Rule Types** section appears when the **Primary** option is selected in the **Main** section.

The **Related Pricing Rule Types** section contains the following columns in a grid:

Column Name	Column Description	Mandatory (Yes or No)
Sequence	Used to specify the order in which the related pricing rule type should be invoked.	Yes (Conditional)
		Note: This field is required when you are adding a related pricing rule type in the ancillary pricing rule type.

Column Name	Column Description	Mandatory (Yes or No)
Pricing Rule Type	<p>Used to indicate the non-primary pricing rule type which should inherit the transaction field mapping details from the claim pricing rule type. You can add a non-primary pricing rule type of the following categories in the claim pricing rule type:</p> <ol style="list-style-type: none"> 1. Retention Type Claim Based 2. Discount Arrangement 3. Specific Stop-Loss 4. Aggregate Stop-Loss 5. Level Funding <p>Note: We recommend you to add the required related pricing rule types in the above specified sequence. Otherwise, erroneous results might occur.</p> <p>The Search (🔍) icon appears corresponding to the Pricing Rule Type field.. On clicking the Search (🔍) icon corresponding to the Pricing Rule Type field, the Pricing Rule Type Search window appears.</p> <p>On specifying the pricing rule type, the description of the pricing rule type appears corresponding to the Pricing Rule Type field.</p>	<p>Yes (Conditional)</p> <p>Note: This field is required when the corresponding Sequence field is specified for the related pricing rule type.</p>
Eligibility Rule Type	<p>Used to specify the rule type which indicates the rules that should be executed to determine whether the related pricing rule type is eligible for deriving the transaction legs.</p> <p>Note: The list includes only those rule types where the rule type usage is set to Related Pricing Rule Type Eligibility.</p>	No

2. Enter the required details in the **Related Pricing Rule Types** section.
3. If you want to define more than one related pricing rule type for the ancillary pricing rule type, click the **Add** (+) icon and then repeat step 2.

Note: However, if you want to remove a related pricing rule type from the ancillary pricing rule type, click the **Delete** (🗑️) icon corresponding to the related pricing rule type.

4. Click **Save**.

The related pricing rule type is added in the ancillary pricing rule type.

Related Topics

For more information on...	See...
How to define an ancillary pricing rule type	Defining an Ancillary Pricing Rule Type on page 2774

For more information on...	See...
How to edit an ancillary pricing rule type	Editing an Ancillary Pricing Rule Type on page 2799

Mapping the Transaction Field in an Ancillary Pricing Rule Type

Prerequisites

To map the transaction field mapping for an ancillary pricing rule type, you should have:

- Transaction fields defined in the application

Procedure

To map the transaction field mapping for an ancillary pricing rule type:

1. Ensure that the **Transaction Field Mapping** section is expanded when you are defining an ancillary pricing rule type.

Note:

This section appears when you have chosen the **Primary** option from the **Main** section.

The **Transaction Field Mapping** section contains the following fields:

Field Name	Field Description	Mandatory (Yes or No)
Source System	Used to map to a transaction field which indicates the external system from where the ancillary transaction is received. The information stored in this field is then used for deriving the bill group, parent customer, and policy for the ancillary transaction.	Yes
Parameter 1	Used to map to a transaction field which indicates the employee attribute based on which you want to derive the bill group.	Yes
Parameter 2	Used to map to a transaction field which indicates the employee attribute based on which you want to derive the bill group.	Yes (Conditional) Note: This field is required when you want to derive the bill group using multiple employee attributes.
Parameter 3	Used to map to a transaction field which indicates the employee attribute based on which you want to derive the bill group.	Yes (Conditional) Note: This field is required when you want to derive the bill group using multiple employee attributes.
Parameter 4	Used to map to a transaction field which indicates the employee attribute based on which you want to derive the bill group.	Yes (Conditional) Note: This field is required when you want to derive the bill group using multiple employee attributes.

Field Name	Field Description	Mandatory (Yes or No)
Incurred Date	Used to map to a transaction field which contains the date when the health insurance service was availed by the employee.	Yes (Conditional)
		Note: This field is required when you want to fetch an effective specific stop-loss or aggregate stop-loss pricing rule for the claim transaction.
Paid Date	Used to map to a transaction field which contains the date when the claim amount was paid to the employee.	Yes (Conditional)
		Note: This field is required when you want to fetch an effective specific stop-loss or aggregate stop-loss pricing rule for the ancillary transaction.
Source of Funds	Used to map to a transaction field which indicates the source of funding. At present, this field is not used in the system.	No
Composite	Used to map to a transaction field which indicates whether the employee is covered under the composite insurance.	No
Claim Disposition	Used to map to a transaction field which helps to determine how the claim based fees should be charged for the positive and negative claim transactions.	Yes (Conditional)
		Note: This field is required while calculating the retention type claim based fees for the claim transaction.
Provider's Tax Identification Number	Used to map to a transaction field which states the health insurance provider's identification number. The information stored in this field is then used to determine whether the health insurance provider is excluded from the specific stop-loss coverage.	Yes (Conditional)
		Note: This field is required while calculating specific stop-loss for the ancillary transaction.
Member ID	Used to map to a transaction field which states the member's identification number. The information stored in this field is then used to determine whether the member is excluded from the specific stop-loss coverage.	Yes (Conditional)
		Note: This field is required while calculating specific stop-loss for the ancillary transaction.
Main Subscriber ID	Used to map to a transaction field which states the main subscriber's identification number. The information stored in this field is then used to determine whether the main subscriber is excluded from the specific stop-loss coverage.	Yes (Conditional)
		Note: This field is required while calculating specific stop-loss for the ancillary transaction.

Field Name	Field Description	Mandatory (Yes or No)
Run-in Identifier	Used to map to a transaction field which indicates whether the ancillary transaction is a run-in ancillary transaction.	Yes (Conditional)
		Note: This field is required while defining a ancillary pricing rule type.
Runout Identifier	Used to map to a transaction field which indicates whether the ancillary transaction is a runout ancillary transaction. At present, this field is not used in the system.	No
Third Party Identifier	Used to specify the third party identifier to determine that the ancillary transaction is received from an external source system while defining an ancillary pricing rule type.	No
Coverage Start Date	Used to map to a transaction field which indicates the coverage start date. The information stored in this field is then used to fetch an effective retention type enrollment based pricing rule for a non-retroactive enrollment transaction.	Yes (Conditional)
		Note: This field is required while defining a retention type enrollment based pricing rule type.
Coverage End Date	Used to map to a transaction field which indicates the coverage end date. The information stored in this field is then used to fetch an effective retention type enrollment based pricing rule for a retroactive enrollment transaction.	Yes (Conditional)
		Note: This field is required while defining a retention type enrollment based pricing rule type.
Retroactivity Indicator	Used to map to a transaction field which indicates whether the enrollment transaction is a retroactive enrollment transaction.	Yes (Conditional)
		Note: This field is required while defining a retention type enrollment based pricing rule type.
Network Indicator	Used to map to a transaction field which indicates whether the service provider is in network or out of network.	Yes (Conditional)
		Note: This field is required while defining a discount arrangement pricing rule.
Covered Charge Amount	Used to map to a transaction field which indicates the amount which is covered for the employee in the policy.	Yes (Conditional)
		Note: This field is required while calculating the discount using a discount guarantee pricing rule.

Field Name	Field Description	Mandatory (Yes or No)
Discount Savings Amount	Used to map to a transaction field which indicates the amount which is offered as the discount to the service provider.	Yes (Conditional) Note: This field is required while calculating the discount using a discount guarantee or discount share pricing rule.
Accumulation Only Identifier	Used to map to a transaction field which indicates that the ancillary transaction should only be used for calculating charges for the accumulated products, such as Specific Stop-Loss, Aggregate Stop-Loss, and so on. This means that the system should not derive the ancillary transaction leg. Instead, it should only derive the specific stop-loss or aggregate stop loss transaction legs for the ancillary transaction.	No
Billing Eligibility Identifier	Used to map to a transaction field which indicates whether the ancillary transaction is eligible for billing.	Yes (Conditional) Note: This field is required while defining an ancillary pricing rule type.
Transaction Upload Date	Used to map to a transaction field which indicates the date when the transaction was uploaded in the external system. The system does not derive the discount transaction leg when the transaction upload date is later than the settlement date.	Yes (Conditional) Note: This field is required while calculating the discount using a discount guarantee or discount share pricing rule.

Note:

The **Search** (🔍) icon appears corresponding to each field. On clicking the **Search** icon, the **Transaction Field Search** window appears.

On specifying the transaction field, the description of the transaction field appears corresponding to the respective field.

2. Enter the required details in the **Transaction Field Mapping** section.
3. Click **Save**.

The transaction fields are mapped to the appropriate fields in the claim pricing rule type.

Related Topics

For more information on...	See...
How to define an ancillary pricing rule type	Defining an Ancillary Pricing Rule Type on page 2774
How to edit an ancillary pricing rule type	Editing an Ancillary Pricing Rule Type on page 2799

Associating an Algorithm with an Ancillary Pricing Rule Type

Prerequisites

To associate algorithms with an ancillary pricing rule type, you should have:

- Algorithms defined using the **C1_TXNBGDRV**, **C1_ACCPRIDRV**, and **C1_BAFTDRV** algorithm types.

Procedure

To associate an algorithm with an ancillary pricing rule type:

1. Ensure that the **Algorithms** section is expanded when you are defining or editing an ancillary pricing rule type.

The **Algorithms** section contains the following columns in a grid:

Column Name	Column Description	Mandatory (Yes or No)
System Event	<p>Used to indicate the system event when you want to invoke the algorithm. The valid values are:</p> <ul style="list-style-type: none"> • Account and Price Item Derivation - Used to derive the account and price item for the ancillary transaction. • Accumulation Billable Charge Post Proc - Used to introduce a custom logic after creating discount share or discount guarantee billable charges. This algorithm is invoked in the C1-BCDA (Create Billable Charge for Discount) batch. • Accumulation Billable Charge Pre Proc - Used to introduce a custom logic before creating discount share or discount guarantee billable charges. This algorithm is invoked in the C1-BCDA (Create Billable Charge for Discount) batch. • Accumulation Post Processing - Used to introduce a custom logic after accumulating the discount share or discount guarantee amount. This algorithm is invoked in the C1-ACDA (Accumulate Discount Arrangement) batch. • Accumulation Pre Processing - Used to introduce a custom logic before accumulating the discount share or discount guarantee amount. This algorithm is invoked in the C1-ACDA (Accumulate Discount Arrangement) batch. • Bill After Date Determination - Used to determine the bill after date for the ancillary transaction. • Bill Group Derivation - Used to derive the bill group, parent customer, and policy for the ancillary transaction. • Pricing Rule Post Processing - Used to introduce a custom logic once the effective ancillary pricing rule is derived for the ancillary transaction. • Transaction Validation - Used to introduce a custom validation for the ancillary transaction. <p>Note: You must specify Account and Price Item Derivation and Bill Group Derivation algorithms when you are associating the algorithms with an ancillary pricing rule type.</p>	<p>Yes</p> <p>Note: This field is required when you are associating an algorithm with the ancillary pricing rule type.</p>
Sequence	<p>Used to specify the order in which the algorithms with the same system event should be executed.</p>	<p>Yes (Conditional)</p> <p>Note: This field is required when you are associating an algorithm with the ancillary pricing rule type.</p>

Column Name	Column Description	Mandatory (Yes or No)
Algorithm	Used to indicate the algorithm that you want to execute on the system event.	Yes (Conditional)
	<p>Note:</p> <p>Once you select the system event, the Search (🔍) icon appears corresponding to the Algorithm field. On clicking the Search (🔍) icon, the Algorithm Search window appears.</p> <p>On specifying the algorithm, the description of the algorithm appears corresponding to the Algorithm field.</p>	<p>Note: This field is required when you are associating an algorithm with the ancillary pricing rule type.</p>

2. Enter the required details in the **Algorithms** section:

System Event	Algorithm	Mandatory (Yes or No)	For more information, see...
Account and Price Item Derivation	C1_ACCPRIDRV	Yes	Account and Price Item Derivation (for the Claim Pricing Rule Type Category) on page 2960
Accumulation Billable Charge Post Proc	-	No	-
	<p>Note: An accumulation billable charge post processing algorithm type is not shipped with the product. You can create a custom algorithm type, if required.</p>		
Accumulation Billable Charge Pre Proc	-	No	-
	<p>Note: An accumulation billable charge pre processing algorithm type is not shipped with the product. You can create a custom algorithm type, if required.</p>		
Accumulation Post Processing	-	No	-
	<p>Note: An accumulation post processing algorithm type is not shipped with the product. You can create a custom algorithm type, if required.</p>		
Accumulation Pre Processing	-	No	-
	<p>Note: A accumulation pre processing algorithm type is not shipped with the product. You can create a custom algorithm type, if required.</p>		
Bill After Date Determination	C1_BAFTDRV	Yes	Bill After Date Determination on page 3008

System Event	Algorithm	Mandatory (Yes or No)	For more information, see...
Bill Group Derivation	C1_TXNBGDRV	Yes	Bill Group Derivation on page 2957
Pricing Rule Post Processing	- Note: A pricing rule post processing algorithm type is not shipped with the product. You can create a custom algorithm type, if required.	No	-
Transaction Validation	- Note: An algorithm type for validating an ancillary transaction is not shipped with the product. You can create a custom algorithm type, if required.	No	-

- If you want to associate more than one algorithm with an ancillary pricing rule type, click the **Add (+)** icon and then repeat step 2.

Note: However, if you want to remove an algorithm from the ancillary pricing rule type, click the **Delete** (🗑️) icon corresponding to the algorithm.

- Click **Save**.

The algorithms are associated with an ancillary pricing rule type.

Related Topics

For more information on...	See...
How to define an ancillary pricing rule type	Defining an Ancillary Pricing Rule Type on page 2774
How to edit an ancillary pricing rule type	Editing an Ancillary Pricing Rule Type on page 2799

Defining Additional Data in an Ancillary Pricing Rule Type

Procedure

To define additional data in an ancillary pricing rule type:

- Ensure that the **Additional Data** section is expanded when you are defining or editing an ancillary pricing rule type.

Note: This section does not appear when the **Pricing Rule Type Category** is **Flat Fees**.

The **Additional Data** section contains the following fields:

Field Name	Field Description	Mandatory (Yes or No)
Eligible for Specific Stop-Loss	<p>Used to indicate whether the price items included in the ancillary pricing rule type are eligible for specific stop-loss. The valid values are:</p> <ul style="list-style-type: none"> • Yes • No <p>Note:</p> <p>This field appears when the Pricing Rule Type Category is either Ancillary, Claim, Retention Type Claim Based, or Retention Type Enrollment Based.</p> <p>If you do not specify the value for this field, by default, it is set to No</p>	No
Eligible for Level Funding	<p>Used to indicate whether the price items included in the ancillary pricing rule type are eligible for level funding. The valid values are:</p> <ul style="list-style-type: none"> • Yes • No 	No
Run-in Identifier Value	Used to specify the identifier value to determine whether the ancillary transaction is received during the run-in period of the policy.	No
Third Party Identifier Value	Used to specify the identifier value to determine whether the ancillary transaction is received from an external source system.	No
Accumulation Only Identifier Value	Used to specify the value when received in an ancillary transaction indicates that the ancillary transaction should only be considered for calculating specific stop-loss and aggregate stop-loss. In such case, a transaction leg is not derived for the ancillary transaction.	No
Eligible for Write-Off in Post Runout	<p>Used to indicate whether the pricing rule is eligible for Write-Off in Post Runout or not. The valid values are:</p> <ul style="list-style-type: none"> • Yes • No <p>For more information, refer to the Write-Off Charges during Post Runout section.</p> <p>Note: By default, the value is set to No.</p>	No

Field Name	Field Description	Mandatory (Yes or No)
Post Runout Write-Off Adjustment Type	Used to specify the adjustment type using which the post runout write-off adjustments must be created.	Yes (Conditional)
	<p>Note:</p> <p>This field appears when the Eligible for Write-Off in Post Runout field is set to Yes.</p> <p>The Search (🔍) icon appears corresponding to the Post Runout Write-Off Adjustment Type field. On clicking the Search icon, the Adjustment Type Search window appears.</p> <p>On specifying the adjustment type, the description of the adjustment type appears corresponding to the Eligible for Write-Off in Post Runout field.</p>	<p>Note: This field is required when the Eligible for Write-Off in Post Runout field is set to Yes.</p>
Rule Based Price Item Eligibility Field	Used to indicate the transaction field which you want to use in the rules as the output parameter to determine whether the price item should be considered for billing. For more information, refer to the Price Item Eligibility on page 2950.	No
<p>Note:</p> <p>This field appears when the Eligible for Write-Off in Post Runout field is set to Yes.</p> <p>The Search (🔍) icon appears corresponding to the Rule Based Price Item Eligibility Field field. On clicking the Search icon, the Field Search window appears.</p> <p>On specifying the field name, the description of the field name appears corresponding to the Rule Based Price Item Eligibility Field.</p>		
Rule Based Related Pricing Rule Type Eligibility Field	Used to indicate the transaction field which you want to use in the rules as the output parameter to determine whether the related pricing rule type should be considered for deriving the transaction legs. For more information, refer to Related Pricing Rule Type Eligibility on page 2948.	No
<p>Note:</p> <p>The Search (🔍) icon appears corresponding to the Rule Based Related Pricing Rule Type Eligibility Field field. On clicking the Search icon, the Field Search window appears.</p> <p>On specifying the field, the description of the field appears corresponding to the Rule Based Related Pricing Rule Type Eligibility Field field.</p>		

Field Name	Field Description	Mandatory (Yes or No)
Rule Based Eligibility Value	Used to specify the value which the output parameter in the rule should return when the price item and related pricing rule type in the ancillary pricing rule type should be considered for processing.	Yes (Conditional)
		Note: This field is required when a value is specified in the Rule Based Price Item Eligibility Field or Rule Based Related Pricing Rule Type Eligibility Field field.

2. Enter the required details in the **Additional Data** section.
3. Click **Save**.

The additional data is defined in the ancillary pricing rule type.

Related Topics

For more information on...	See...
How to define an ancillary pricing rule type	Defining an Ancillary Pricing Rule Type on page 2774
How to edit an ancillary pricing rule type	Editing an Ancillary Pricing Rule Type on page 2799

Adding a Price Item in an Ancillary Pricing Rule Type

Prerequisites

To add a price item in an ancillary pricing rule type, you should have:

- Price item defined in the application
- Rate options defined in the **Rate Option (C1-ExtLookRetTypeRateOpt)** extendable lookup
- Values defined for the **Invoice Type (C1INVTYP)** characteristic type
- The **C1INVTYP** characteristic type set in the **Invoice Type Characteristic Type** option type of the **C1-ASOBLNG** feature configuration
- Rule types defined in the application (where the rule type usage is set to **Price Item Eligibility**)

Procedure

To add a price item in an ancillary pricing rule type:

1. Ensure that the **Price Items** section is expanded when you are defining or editing an ancillary pricing rule type.

The **Price Items** section contains the following fields in a grid:

Field Name	Field Description	Mandatory (Yes or No)				
Price Item	Used to indicate the price item that you want to include in an ancillary pricing rule type.	Yes (Conditional) Note: This field is required when you are adding a rate option and bill to account in the discount arrangement pricing rule type.				
	<p>Note:</p> <p>The Search (🔍) icon appears corresponding to the Price Item field. On clicking the Search (🔍) icon, the Price Item Search window appears.</p> <p>On specifying the price item, the description of the price item appears corresponding to the Price Items field.</p>					
Rate Option	Used to indicate one or more rate options which are valid for a price item.	Not applicable				
	On clicking the Add (+) icon, the following field appears in a grid:					
	<table border="1"> <thead> <tr> <th>Field Name</th> <th>Field Description</th> <th>Mandatory (Yes or No)</th> </tr> </thead> <tbody> <tr> <td>Rate Option</td> <td>Used to indicate the rate option that you want to use while defining pricing for the price item.</td> <td>Yes</td> </tr> </tbody> </table>		Field Name	Field Description	Mandatory (Yes or No)	Rate Option
Field Name	Field Description	Mandatory (Yes or No)				
Rate Option	Used to indicate the rate option that you want to use while defining pricing for the price item.	Yes				
<p>Note:</p> <p>If you want to define more than one rate option to the price item in an ancillary pricing rule type, click the Add (+) icon.</p> <p>However, if you want to remove a price item from an ancillary pricing rule type, click the Delete (🗑️) icon corresponding to the Rate Option field.</p>						

Field Name	Field Description	Mandatory (Yes or No)									
Bill To Account	<p>Used to indicate a order in which the account should be considered while deriving a transaction leg.</p> <p>On clicking the Add (+) icon, the following fields appear in a grid:</p> <table border="1"> <thead> <tr> <th>Field Name</th> <th>Field Description</th> <th>Mandatory (Yes or No)</th> </tr> </thead> <tbody> <tr> <td>Priority</td> <td>Used to specify the order in which the invoice type is considered for a price item.</td> <td>Yes</td> </tr> <tr> <td>Invoice Type</td> <td>Used to indicate the type which is considered for billing. For more information, refer to the Bill Group's Account on page 65 section.</td> <td>Yes</td> </tr> </tbody> </table> <div style="border: 1px solid black; padding: 5px; margin-top: 5px;"> <p>Note: The Search (🔍) icon appears corresponding to the Invoice Type field. On clicking the Search icon, the Invoice Type Search window appears.</p> </div>	Field Name	Field Description	Mandatory (Yes or No)	Priority	Used to specify the order in which the invoice type is considered for a price item.	Yes	Invoice Type	Used to indicate the type which is considered for billing. For more information, refer to the Bill Group's Account on page 65 section.	Yes	Not applicable
Field Name	Field Description	Mandatory (Yes or No)									
Priority	Used to specify the order in which the invoice type is considered for a price item.	Yes									
Invoice Type	Used to indicate the type which is considered for billing. For more information, refer to the Bill Group's Account on page 65 section.	Yes									
	<p>Note:</p> <p>If you want to define more than one invoice type to the price item in an ancillary pricing rule type, click the Add (+) icon.</p> <p>However, if you want to remove a invoice type from the price item in an ancillary pricing rule type, click the Delete (🗑️) icon corresponding to the Priority field.</p>										
Eligibility Rule Type	Used to indicate the rule type which indicates the rules that should be executed to determine whether the price item is eligible for billing.	No									

2. Enter the required details in the **Price Items** section.
3. If you want to define more than one price item for an ancillary pricing rule type, click the **Add** (+) icon and then repeat step 2.

Note: However, if you want to remove a price item from an ancillary pricing rule type, click the **Delete** (🗑️) icon corresponding to the price item.

4. Click **Save**.

The price items are added for an ancillary pricing rule type.

Related Topics

For more information on...	See...
How to define an ancillary pricing rule type	Defining an Ancillary Pricing Rule Type on page 2774

For more information on...	See...
How to edit an ancillary pricing rule type	Editing an Ancillary Pricing Rule Type on page 2799

Adding a Price Item Parameter in an Ancillary Pricing Rule Type

Prerequisites

To add a price item parameter in an ancillary pricing rule type, you should have:

- Parameters defined in the application where parameter usage is set to **Price Item**.
- Parameters associated with the price item.
- Billable Charge Line Type Parameter** and **Pricing Arrangement Parameter** defined in the application.
- Billable Charge Line Type Parameter** and **Pricing Arrangement Parameter** set as option types in the **C1-ASOBLLNG** feature configuration.
- Transaction fields defined in the application.

Procedure

To add a price item parameter in an ancillary pricing rule type:

1. Ensure that the **Price Item Parameters** section is expanded when you are defining or editing an ancillary pricing rule type.

The **Price Item Parameters** section contains the following fields in a grid:

Field Name	Field Description	Mandatory (Yes or No)
Price Item Parameter	Used to specify the parameter which you can use while defining an ancillary pricing for the price item.	Yes (Conditional)
	<p>Note:</p> <p>The Search (🔍) icon appears corresponding to the Price Item Parameter field. On clicking the Search (🔍) icon corresponding to the Price Item Parameter field, the Parameter Search window appears.</p> <p>On specifying the parameter, the description of the price item parameter appears corresponding to the Price Item Parameter field.</p>	<p>Note: This field is required while adding a price item parameter in an ancillary pricing rule type.</p>
Transaction Field	Used to map to a transaction field which contains the parameter value.	Yes (Conditional)
	<p>Note:</p> <p>The Search (🔍) icon appears corresponding to the Transaction Field field. On clicking the Search (🔍) icon corresponding to the Transaction Field field, the Transaction Field Search window appears.</p> <p>On specifying the transaction field, the description of the transaction field appears corresponding to the Transaction Field.</p>	<p>Note: This field is required while adding a price item parameter in an ancillary pricing rule type.</p>

Field Name	Field Description	Mandatory (Yes or No)
Eligible for Specific Stop-Loss	Used to indicate whether the price item parameter can be used while defining the accumulation criteria in the specific stop-loss or aggregate stop-loss pricing rules at the bill group level.	No
Eligible for Level Funding	Used to indicate whether the price item parameter can be used while defining the accumulation criteria in the level funding pricing rules at the bill group level.	No

- Enter the required details in the **Price Item Parameters** section.
- If you want to add more than one price item parameter for an ancillary pricing rule type, click the **Add (+)** icon and then repeat step 2.

Note: However, if you want to remove a price item parameter from an ancillary pricing rule type, click the **Delete** (🗑️) icon corresponding to the price item parameter.

- Click **Save**.

The price item parameter is added in the ancillary pricing rule type.

Related Topics

For more information on...	See...
How to define an ancillary pricing rule type	Defining an Ancillary Pricing Rule Type on page 2774
How to edit an ancillary pricing rule type	Editing an Ancillary Pricing Rule Type on page 2799

Defining the Ancillary-Specific Data in an Ancillary Pricing Rule Type

Procedure

To add the ancillary-specific additional data in an ancillary pricing rule type:

- Ensure that the **Ancillary-Specific Additional Data** section is expanded when you are defining or editing an ancillary pricing rule type.

The **Ancillary-Specific Additional Data** section contains the following fields:

Field Name	Field Description	Mandatory (Yes or No)
Billing Eligibility Identifier Value	Used to specify the billing eligibility identifiers which help to determine whether the ancillary transaction is eligible for billing.	Yes (Conditional) Note: This field is required when you are adding the ancillary-specific additional data.
Billing Non-Eligibility Identifier Value	Used to specify the billing non-eligibility identifiers which help to determine whether the ancillary transaction is eligible for billing.	Yes (Conditional) Note: This field is required when you are adding the ancillary-specific additional data.

Field Name	Field Description	Mandatory (Yes or No)
Rule Based Markup or Markdown Eligibility Field	Used to specify the transaction field that you want to use in the rules as the output parameter to determine whether the markup or markdown calculation line is eligible for billing.	Yes (Conditional) Note: This field is required when the Markup or Markdown Eligibility Rule Type field is specified.
	<p>Note:</p> <p>On clicking the Search (🔍) icon corresponding to the Rule Based Markup or Markdown Eligibility Field field, the Field Search window appears.</p> <p>On specifying the field, the description of the field appears corresponding to the Rule Based Markup or Markdown Eligibility Field field.</p>	
Markup or Markdown Billable Charge Line Type	Used to specify the billable charge line type using which you want to create the billable charges for markup and markdown.	No
	<p>Note:</p> <p>On clicking the Search (🔍) icon corresponding to the Markup or Markdown Billable Charge Line Type field, the Billable Charge Line Type Search window appears.</p> <p>On specifying the billable charge line type, the description of the billable charge line type appears corresponding to the Markup or Markdown Billable Charge Line Type field.</p>	
Markup or Markdown Eligibility Rule Type	Used to specify the markup or markdown eligibility rule type for the ancillary pricing rule type. The valid values are:	No
	<ul style="list-style-type: none"> • Rule 1 <p>Note: The Markup or Markdown Eligibility Rule Type list includes only those rule-types where the rule type eligibility is ASO Billing Mark Up / Down Eligibility.</p>	

2. Enter the required details in the **Ancillary-Specific Additional Data** section.
3. Define pricing arrangements for ancillary-specific data in the **Ancillary-Specific Additional Data** section.
4. Click **Save**.

The ancillary-specific additional data is added in the ancillary pricing rule type.

Related Topics

For more information on...	See...
How to define an ancillary pricing rule type	Defining an Ancillary Pricing Rule Type on page 2774

For more information on...	See...
How to edit an ancillary pricing rule type	Editing an Ancillary Pricing Rule Type on page 2799
How to define pricing arrangements in an ancillary pricing rule type	Defining Pricing Arrangements in an Ancillary Pricing Rule Type on page 2797

Defining Pricing Arrangements in an Ancillary Pricing Rule Type

Prerequisites

To define pricing arrangements in an ancillary pricing rule type, you should have:

- Line Items where category is set to **Ancillary**, as defined in the application.

Procedure

To add pricing arrangements in an ancillary pricing rule type:

- Ensure that the **Ancillary-Specific Data** and **Pricing Arrangements** section is expanded when you are defining or editing a pricing rule type.

The **Pricing Arrangements** section contains the following columns in a grid:

Column Name	Column Description	Mandatory (Yes or No)
Pricing Arrangement Identifier	Used to indicate the pricing arrangement identifier that you can define through an ancillary pricing rule type. The valid values are: <ul style="list-style-type: none"> Pass Through (Markup or Markdown Optional) Pass Through without Markup or Markdown Rate Based (Markup or Markdown Optional) 	Yes (Conditional) Note: This field is required when you are defining pricing arrangements for an ancillary pricing rule type.
Pricing Arrangement Identifier Value	Used to specify the value for the pricing arrangement identifier. The valid values are: <ul style="list-style-type: none"> Pass Through (Markup or Markdown Optional) Pass Through without Markup or Markdown Rate Based (Markup or Markdown Optional) 	Yes (Conditional) Note: This field is required when you are defining pricing arrangements for an ancillary pricing rule type.
Line Item	Used to indicate the line item which using the billable charge is created for a pricing arrangement.	Yes (Conditional) Note: This field is required when you are defining pricing arrangements for an ancillary pricing rule type.

- Enter the required details in the **Pricing Arrangements** section.
- If you want to define more than one pricing arrangement in an ancillary pricing rule type, click the **Add (+)** icon and then repeat step 2.

Note: However, if you want to remove a pricing arrangement from the ancillary pricing rule type, click the **Delete** (🗑️) icon corresponding to the pricing arrangement identifier.

- Click **Save**.

The pricing arrangements are defined for the ancillary pricing rule type.

Related Topics

For more information on...	See...
How to define an ancillary pricing rule type	Defining an Ancillary Pricing Rule Type on page 2774
How to edit an ancillary pricing rule type	Editing an Ancillary Pricing Rule Type on page 2799

Defining a Characteristic for a Ancillary Pricing Rule Type**Prerequisites**

To define a characteristic for an ancillary pricing rule type, you should have:

- Characteristic types defined in the application (where the characteristic entity is set to **Pricing Rule Type**)

Procedure

To define a characteristic for an ancillary pricing rule type:

1. Ensure that the **Characteristics** section is expanded when you are defining an ancillary pricing rule type.

The **Characteristics** section contains the following fields in a grid:

Field Name	Field Description	Mandatory (Yes or No)
Characteristic Type	Used to indicate the characteristic type.	Yes (Conditional)
	Note: The list includes only those characteristic types where the characteristic entity is set to Pricing Rule Type .	Note: This field is required when you are defining a characteristic for an ancillary pricing rule type.
Characteristic Value	Used to specify the value for the characteristic type.	Yes (Conditional)
	Note: If you select a predefined characteristic type, the Search (🔍) icon appears corresponding to the Characteristic Value field. On clicking the Search icon, the Predefined Characteristic Search window appears. On specifying the value for a predefined characteristic type, the description of the characteristic value appears corresponding to the Characteristic Value field.	Note: This field is required when you are defining a characteristic for an ancillary pricing rule type.

2. Enter the required details in the **Characteristics** section.
3. If you want to define more than one characteristic for an ancillary pricing rule type, click the **Add** (+) icon and then repeat step 2.

Note: However, if you want to remove a characteristic from an ancillary pricing rule type, click the **Delete** (🗑️) icon corresponding to the characteristic.

4. Click **Save**.

The characteristic is defined for an ancillary pricing rule type.

Related Topics

For more information on...	See...
How to define an ancillary pricing rule type	Defining an Ancillary Pricing Rule Type on page 2774
How to edit an ancillary pricing rule type	Editing an Ancillary Pricing Rule Type on page 2799

Editing an Ancillary Pricing Rule Type**Prerequisites**

To edit an ancillary pricing rule type, you should have:

- Ancillary pricing rule type business object defined in the application.
- Ancillary pricing rule business object defined in the application.

Procedure

To edit an ancillary pricing rule type:

1. Click the **Admin** link in the **Application** toolbar.
A list appears.
2. From the **Admin** menu, select **P** and then click **Pricing Rule Type**.
A sub-menu appears.
3. Click the **Search** option from the **Pricing Rule Type** sub-menu.
The **Pricing Rule Type** screen appears.
4. In the **Pricing Rule Type List** zone, click the **Edit** (✎) icon in the **Edit** column corresponding to an ancillary pricing rule type whose details you want to edit.

The **Ancillary Pricing Rule Type** screen appears. It contains the following sections:

- **Main** – Used to specify basic details about the ancillary pricing rule type.
- **Related Pricing Rule Types** – Used to indicate the non-primary pricing rule types which should inherit the transaction field mapping details from the ancillary pricing rule type. You can add a pricing rule type which belongs to the following category:
 1. Retention Type Claim Based
 2. Discount Arrangement
 3. Specific Stop-Loss
 4. Aggregate Stop-Loss
 5. Level Funding

Note: We recommend you to add the required related pricing rule types in the above specified sequence. Otherwise, erroneous results might occur.

- **Transaction Field Mapping** – Used to map the transaction fields in a claim transaction to the appropriate fields in the claim pricing rule type. This helps the system to determine the field where the data from the transaction field must be stored. This data is then used in the system for various reasons, such as for deriving a bill group and pricing, deriving an effective related pricing rule, and so on.

Note: The **Billing Eligibility Identifier** field is required when you are defining the **Transaction Field Mapping** for the ancillary pricing rule type.

- **Algorithms** – Used to associate the algorithms with the ancillary pricing rule type.
- **Additional Data** – Used to specify the additional information about the ancillary pricing rule type.
- **Price Items** – Used to add the price items for which you can define the ancillary pricing rules using the ancillary pricing rule type.
- **Price Item Parameters** – Used to add the price item parameters based on which you want to define the price item pricing.

Note: There are two price item parameters that are mandatory in the ancillary pricing rule type:

- A price item which stores the billable charge line type from the ancillary transaction.
- A price item which stores the pricing arrangement from the ancillary transaction.

- **Characteristics** – Used to define the characteristics for the ancillary pricing rule type.
- **Ancillary-Specific Additional Data** – Used to define ancillary-specific additional data.

Note: Following fields are required when you are defining the **Ancillary-Specific Additional Data** for the ancillary pricing rule type.

- **Billing Eligibility Identifier Value**
- **Billing Non-Eligibility Identifier Value**

- **Pricing Arrangements** – Used to define the pricing arrangements for the ancillary pricing rule type.
 - **Pass Through (Markup or Markdown Optional)**
 - **Pass Through Without Markup or Markdown**
 - **Rate Based (Markup or Markdown Optional)**

The **Main** section contains the following fields:

Field Name	Field Description	Mandatory (Yes or No)
Pricing Rule Type	Displays the ancillary pricing rule type.	Not applicable
Description	Used to specify the description for an ancillary pricing rule type.	Yes
Detailed Description	Used to specify additional information about the ancillary pricing rule type.	No

Field Name	Field Description	Mandatory (Yes or No)
Pricing Rule Business Object	<p>Used to indicate the business object using which you want to create an ancillary pricing rule. The valid value is:</p> <ul style="list-style-type: none"> • Aggregate Stop-Loss (ASL) Pricing Rule • Ancillary Pricing Rule • Claim Pricing Rule • Discount Arrangement Pricing Rule • Flat Fee Pricing Rule • Level Funded (LF) Pricing Rule • Retention Type Claim Based Pricing Rule • Retention Type Enrollment Based Pricing Rule • Specific Stop-Loss (SSL) Pricing Rule <p>Note: You must select the Ancillary Pricing Rule option from the Pricing Rule Business Object list while defining an ancillary pricing rule type.</p>	Yes
Business Object	Indicates the ancillary pricing rule type business object using which you are defining the ancillary pricing rule type.	Not applicable
Status	<p>Used to indicate the status of the ancillary pricing rule type. The valid values are:</p> <ul style="list-style-type: none"> • Active • Inactive 	Yes
Primary	<p>Used to indicate whether the ancillary pricing rule type is a primary pricing rule type.</p> <p>Note: This field is disabled when you select the Flat Fees option from the Pricing Rule Type Category list.</p>	No

Field Name	Field Description	Mandatory (Yes or No)
Pricing Rule Type Category	<p>Indicates the category to which the ancillary pricing rule type belongs. The valid values are:</p> <ul style="list-style-type: none"> • Aggregate Stop-Loss • Ancillary • Claim • Discount Arrangement • Flat Fees • Level Funded • Retention Type Claim Based • Retention Type Enrollment Based • Specific Stop-Loss 	No
	<p>Note: You must select the Ancillary option from the Pricing Rule Type Category list while defining an ancillary pricing rule type.</p>	

Tip: Alternatively, you can edit the details of an ancillary pricing rule type by clicking the **Edit** button in the **Pricing Rule Type** zone to edit the pricing rule type for ancillary.

5. Modify the required details in the **Main** section, if required.
6. Ensure that the **Ancillary Pricing Rule** option is selected from the **Pricing Rule Business Object** list.
7. Ensure that the **Primary** option is selected in the **Main** section.
8. Add, edit, or remove the related pricing rule types in the ancillary pricing rule type, if required.

Note: The **Related Pricing Rule Types** section appears when the **Primary** option is selected from the **Main** section.

9. Modify the transaction field mapping in the ancillary pricing rule type, if required.

Note: The **Transaction Field Mapping** section appears when the **Primary** option is selected from the **Main** section.

10. Add, edit, or remove algorithms from the ancillary pricing rule type, if required.

System Event	Algorithm	Algorithm Type	Description
Account and Price Item Derivation	C1_ACCPRIDIS	C1_ACCPRIDIS	Account and Priceitem Derivation For Discount Arrangement

11. Edit generic additional data for the ancillary pricing rule type, if required.
12. Add, edit, or remove price items in an ancillary pricing rule type, if required.
13. Add, edit, or remove price item parameters in an ancillary pricing rule type, if required.
14. Add, edit, or remove characteristics in an ancillary pricing rule type, if required.
15. Modify the ancillary-specific data in an ancillary pricing rule type, if required.
16. Modify the pricing arrangements in an ancillary pricing rule type, if required.
17. Click **Save**.

The changes made to the ancillary pricing rule type are saved.

Related Topics

For more information on...	See...
How to add related pricing rule type in an ancillary pricing rule type	Adding a Related Pricing Rule Type in an Ancillary Pricing Rule Type on page 2779
How to map the transaction fields in an ancillary pricing rule type	Mapping the Transaction Field in an Ancillary Pricing Rule Type on page 2781
How to associate an algorithm with an ancillary pricing rule type	Associating an Algorithm with an Ancillary Pricing Rule Type on page 2785
How to defining additional data in an ancillary pricing rule type	Defining Additional Data in an Ancillary Pricing Rule Type on page 2788
How to adding a price item in an ancillary pricing rule type	Adding a Price Item in an Ancillary Pricing Rule Type on page 2791
How to add a price item parameter in an ancillary pricing rule type	Adding a Price Item Parameter in an Ancillary Pricing Rule Type on page 2794
How to define the ancillary-specific data in an ancillary pricing rule type	Defining the Ancillary-Specific Data in an Ancillary Pricing Rule Type on page 2795
How to define pricing arrangements in an ancillary pricing rule type	Defining Pricing Arrangements in an Ancillary Pricing Rule Type on page 2797

Deleting an Ancillary Pricing Rule Type

Procedure

To delete an ancillary pricing rule type:

1. Click the **Admin** link in the **Application** toolbar.
A list appears.
2. From the **Admin** menu, select **P** and then click **Pricing Rule Type**.
A sub-menu appears.
3. Click the **Search** option from the **Pricing Rule Type** sub-menu.
The **Pricing Rule Type** screen appears.
4. In the **Pricing Rule Type List** zone, click the **Delete** () icon in the **Delete** column corresponding to the ancillary pricing rule type that you want to delete.
A message appears confirming whether you want to delete the ancillary pricing rule type.

Note: You can delete an ancillary pricing rule type when it is not yet used in the system.

Tip: Alternatively, you can delete an ancillary pricing rule type by clicking the **Delete** button in the **Pricing Rule Type** zone.

5. Click **OK**.

The ancillary pricing rule type is deleted.

Related Topics

For more information on...	See...
Pricing Rule Type screen	Pricing Rule Type on page 2532
Pricing Rule Type List zone	Pricing Rule Type List on page 2533
Pricing Rule Type zone	Pricing Rule Type on page 2536

Viewing the Ancillary Pricing Rule Type Details

Procedure

To view the details of an ancillary pricing rule type:

1. Click the **Admin** link in the **Application** toolbar.
A list appears.
2. From the **Admin** menu, select **P** and then click **Pricing Rule Type**.
A sub-menu appears.
3. Click the **Search** option from the **Pricing Rule Type** sub-menu.
The **Pricing Rule Type** screen appears.
4. In the **Pricing Rule Type List** zone, click the **Broadcast** () icon corresponding to the ancillary pricing rule type whose details you want to view.
The **Pricing Rule Type** zone appears.
5. View the details of the ancillary pricing rule type in the **Pricing Rule Type** zone.

Related Topics

For more information on...	See...
Pricing Rule Type screen	Pricing Rule Type on page 2532
Pricing Rule Type List zone	Pricing Rule Type List on page 2533
Pricing Rule Type zone	Pricing Rule Type on page 2536

Defining an Ancillary Pricing Rule for a Parent Customer

Prerequisites

To define an ancillary pricing rule for a parent customer, you should have:

- Pricing rule type where the category is set to **Ancillary**.
- Price items associated with the ancillary pricing rule type.
- Pricing arrangements defined in the ancillary pricing rule type.

Procedure

To define an ancillary pricing rule for a parent customer:

1. Search for a parent customer in the **Customer 360° View** screen.
2. In the **Search Results** section, click the **View** () icon corresponding to the parent customer whose pricing details you want to view.

The **Person** tab appears in the **Customer 360° Information** screen.

3. Click the **Pricing** tab.

The **Pricing** tab appears.

4. Click the **Add** link in the upper right corner of the **Parent Customer Pricing Rules** zone.

The **Pricing Rule** screen appears. It contains the following fields:

Field Name	Field Description	Mandatory (Yes or No)
Person Name	Indicates the parent customer for whom you want to create an ancillary pricing rule type.	Not applicable
Person Type	Indicates the type of the parent customer. The valid value is: <ul style="list-style-type: none"> • Parent Customer 	Not applicable
	Note: If you are defining the pricing rule type for the parent customer, then the person type will be Parent Customer .	
Pricing Rule Type	Used to indicate the pricing rule type using which you want to create an ancillary pricing rule.	Yes

5. Select the required pricing rule type in the respective field.
6. Click **OK**.

The **Ancillary Pricing Rule** screen appears. It contains the following sections:

- **Customer Information** – Displays the information about the parent customer. It contains the following fields:

Field Name	Field Description
Parent Customer Information	Indicates the parent customer for whom you are defining an ancillary pricing rule.
Pricing Rule Type	Indicates the pricing rule type using which you are defining an ancillary pricing rule.

- **Main** – Used to specify basic details about the ancillary pricing rule. In addition it allows you to define pricing for different types of ancillary charges. It contains the following fields:

Field Name	Field Description	Mandatory (Yes or No)
Price Item	Used to indicate the price item for which you want to define an ancillary pricing rule.	Yes
Pricing Start Date	Used to specify the date from when the ancillary pricing rule is effective.	Yes
	Note: The pricing start date cannot be later than the pricing end date.	

Field Name	Field Description	Mandatory (Yes or No)
Pricing End Date	Used to specify the date till when the ancillary pricing rule is effective.	No
	Note: The pricing end date cannot be earlier than the pricing start date.	
Rate Option	Used to indicate the rate option that you want to use while defining pricing for the price item.	Yes
Pass Through without Markup or Markdown	Used when markup or markdown should not be calculated for the ancillary charge.	Yes (Conditional)
	Note: This field is enabled when the Rate Option field is selected.	
		Note: This field is required when you want to calculate the ancillary pricing without the pass through charge while defining the ancillary pricing rule.

The following fields appear when the **Pass Through without Markup or Markdown** option is not selected. It contains the following fields:

Field Name	Field Description	Mandatory (Yes or No)
Billable Charge Line Type	Used to indicate the billable charge line type using which you want to create the ancillary pricing rule.	Yes (Conditional)
	Note: The Search (🔍) icon appears corresponding to this field. On clicking the Search icon, the Billable Line Type Search window appears. On specifying the billable charge line type, the description of the billable charge line type appears corresponding to the Billable Charge Line Type field.	
Billable	Used to indicate whether the ancillary charge is eligible for billing or not.	Yes (Conditional)
		Note: This field is required while creating a pricing arrangement with or without the Markup or Markdown Type field and the Rate Based option.
Rate Based	Used to indicate whether the ancillary charge is calculated using a particular rate.	Yes (Conditional)
		Note: This field is required while creating a pricing arrangement with the Rate Based option.

Field Name	Field Description	Mandatory (Yes or No)
Rate	Used to indicate the rate for calculating the ancillary charge.	Yes (Conditional)
	Note: This field is enabled when the Rate Based option is selected.	Note: This field is required when Rate Based option is selected.
Pricing Strategy	Used to indicate the price calculation strategy which should be applied while defining the ancillary pricing rule. The valid values are: <ul style="list-style-type: none"> • Markup • Markdown • None 	No
Markup or Markdown Type	Used to indicate the type of charge which should be applied while defining the ancillary pricing rule. The valid values are: <ul style="list-style-type: none"> • Flat Amount • Percentage 	Yes (Conditional)
	Note: This field is enabled when the Pricing Strategy field is selected.	Note: This field is required when the Pricing Strategy field is selected.
Amount / Percentage	Used to specify the actual proportion of the charge that should be applied while defining the ancillary pricing rule.	Yes (Conditional)
		Note: This field is required when the Markup or Markdown Type field is selected.

- **Characteristics** – Used to define the characteristics for an ancillary pricing rule.

7. Enter the required details in the **Main** section.
8. Define the characteristics for an ancillary pricing rule, if required.
9. Click **Save**.

The ancillary pricing rule is defined for a parent customer.

Related Topics

For more information on...	See...
How to search for a parent customer	Searching for a Person on page 648
Parent Customer Pricing Rules zone	Parent Customer Pricing Rules on page 696
How to define a characteristic for an ancillary pricing rule	Defining a Characteristic for an Ancillary Pricing Rule on page 2807

Defining a Characteristic for an Ancillary Pricing Rule

Prerequisites

To define a characteristic for an ancillary pricing rule, you should have:

- Characteristic types defined in the application (where the characteristic entity is set to **Pricing Rule**).

Procedure

To define a characteristic for an ancillary pricing rule:

1. Ensure that the **Characteristics** section is expanded when you are defining or editing an ancillary pricing rule.

The **Characteristics** section contains the following fields:

Column Name	Column Description	Mandatory (Yes or No)
Effective Date	Used to specify the date from when the characteristic is effective for the ancillary pricing rule.	Yes (Conditional) Note: This field is required when you are defining a characteristic for the ancillary pricing rule.
Characteristic Type	Used to indicate the characteristic type. Note: The list includes only those characteristic types where the characteristic entity is set to Pricing Rule .	Yes (Conditional) Note: This field is required when you are defining a characteristic for the ancillary pricing rule.
Characteristic Value	Used to specify the value for the characteristic type. Note: If you select a predefined characteristic type, the Search (🔍) icon appears corresponding to the Characteristic Value field. On clicking the Search icon, the Predefined Characteristic Search window appears. On specifying the value for a predefined characteristic type, the description of the characteristic value appears corresponding to the Characteristic Value field.	Yes (Conditional) Note: This field is required when you are defining a characteristic for the ancillary pricing rule.

2. Enter the required details in the **Characteristics** section.
3. If you want to define more than one characteristic for the ancillary pricing rule, click the **Add** (+) icon and then repeat step 2.

Note: However, if you want to remove a characteristic from the ancillary pricing rule, click the **Delete** (🗑️) icon corresponding to the characteristic.

4. Click **Save**.

The characteristics are defined for an ancillary pricing rule.

Related Topics

For more information on...	See...
How to define an ancillary pricing rule for a parent customer	Defining an Ancillary Pricing Rule for a Parent Customer on page 2804
How to edit an ancillary pricing rule for a parent customer	Editing an Ancillary Pricing Rule of a Parent Customer on page 2809

For more information on...	See...
How to define an ancillary pricing rule for a bill group	Defining an Ancillary Pricing Rule for a Bill Group on page 2812
How to edit an ancillary pricing rule for a bill group	Editing an Ancillary Pricing Rule of a Bill Group on page 2817

Editing an Ancillary Pricing Rule of a Parent Customer



Prerequisites

To edit an ancillary pricing rule of a parent customer, you should have:

- Business Object **C1-PricingRuleAncillary** defined for ancillary pricing rule.

Procedure

To edit a ancillary pricing rule of a parent customer:

1. Search for a parent customer in the **Customer 360° View** screen.
2. In the **Search Results** section, click the **View** () icon corresponding to the parent customer whose pricing details you want to view.
The **Person** tab appears in the **Customer 360° Information** screen.
3. Click the **Pricing** tab.
The **Pricing** screen appears.
4. In the **Parent Customer Pricing Rules** zone, click the **Edit** () icon in the **Parent Customer Pricing Rules** zone, corresponding to the ancillary pricing rule whose details you want to edit.

The **Ancillary Pricing Rule** screen appears. It contains the following sections:

- **Customer Information** – Displays the customer information.

Field Name	Field Description
Parent Customer Information	Displays the parent customer for whom the ancillary pricing rule is created.
Pricing Rule Type	Indicates the pricing rule type for whom the ancillary pricing rule is created.

- **Main** – Used to specify basic details about the ancillary pricing rule. In addition it allows you to define pricing for different types of ancillary charges. It contains the following fields:

Field Name	Field Description	Mandatory (Yes or No)
Price Item	Displays the price item that is used to create ancillary pricing rule.	Not applicable
Pricing Start Date	Displays the date from when the ancillary pricing rule is effective.	Not applicable
Pricing End Date	Used to specify the date till when the ancillary pricing rule is effective.	Not applicable
Rate Option	Displays the rate option that you want to use while defining the price item.	Not applicable

Field Name	Field Description	Mandatory (Yes or No)
Pass Through without Markup or Markdown	Indicates that markup or markdown should not be calculated for the ancillary charge.	Yes (Conditional)
	Note: This field is enabled when the Rate Option field is selected.	Note: This field is required when you want to calculate the ancillary pricing without the pass through charge while defining the ancillary pricing rule.

The following fields appear when the **Pass Through without Markup or Markdown** option is not selected. It contains the following fields:

Field Name	Field Description	Mandatory (Yes or No)
Billable Charge Line Type	Used to indicate the billable charge line type using which you want to create the ancillary pricing rule.	Yes (Conditional)
	Note: The Search (🔍) icon appears corresponding to this field. On clicking the Search icon, the Billable Line Type Search window appears. On specifying the billable charge line type, the description of the billable charge line type appears corresponding to the Billable Charge Line Type field.	Note: This field is required while creating a pricing arrangement with or without rate based billable charge line type.
Billable	Used to indicate whether the ancillary charge is eligible for billing or not.	Yes (Conditional)
		Note: This field is required while creating a pricing arrangement with or without the Rate Based option.
Rate Based	Used to indicate whether the ancillary charge is calculated using a particular rate.	Yes (Conditional)
		Note: This field is required while creating a pricing arrangement with the Rate Based option.
Rate	Used to indicate the rate for calculating the ancillary charge.	Yes (Conditional)
	Note: This field is enabled when the Rate Based option is selected.	Note: This field is required when Rate Based option is selected.

Field Name	Field Description	Mandatory (Yes or No)
Pricing Strategy	Used to indicate the price calculation strategy which should be applied while defining the ancillary pricing rule. The valid values are: <ul style="list-style-type: none"> • Markup • Markdown • None 	No
Markup or Markdown Type	Used to indicate the type of charge which should be applied while defining the ancillary pricing rule. The valid values are: <ul style="list-style-type: none"> • Flat Amount • Percentage 	Yes (Conditional)
		Note: This field is required when the Pricing Strategy field is selected.
Amount / Percentage	Used to specify the actual proportion of the charge that should be applied while defining the ancillary pricing rule.	Yes (Conditional)
		Note: This field is required when the Markup or Markdown Type field is selected.

- **Characteristics** – Used to define the characteristics for the ancillary pricing rule.

5. Modify the details in the **Main** section.
6. Define, edit, or remove characteristics for an ancillary pricing rule, if required.
7. Click **Save**.

The changes made to an ancillary pricing rule for a parent customer are saved.

Related Topics

For more information on...	See...
How to search for a parent customer	Searching for a Person on page 648
Parent Customer Pricing Rules zone	Parent Customer Pricing Rules on page 696
How to define the characteristics for an ancillary pricing rule	Defining a Characteristic for an Ancillary Pricing Rule on page 2807

Deleting an Ancillary Pricing Rule of a Parent Customer

Procedure

To delete an ancillary pricing rule of a parent customer:

1. Search for a parent customer in the **Customer 360° View** screen.
2. In the **Search Results** section, click the **View** (🔍) icon corresponding to the parent customer whose pricing details you want to view.

The **Person** tab appears in the **Customer 360° Information** screen.

- Click the **Pricing** tab.

The **Pricing** screen appears.

- In the **Parent Customer Pricing Rules** zone, click the **Delete** (🗑️) icon in the **Delete** column corresponding to the ancillary pricing rule that you want to delete.

A message appears confirming whether you want to delete the ancillary pricing rule of a parent customer.

Note: You can delete an ancillary pricing rule when it is not yet used in the system.

- Click **OK**.

The ancillary pricing rule of a parent customer is deleted.

Related Topics

For more information on...	See...
How to search for a parent customer	Searching for a Person on page 648
Parent Customer Pricing Rules zone	Parent Customer Pricing Rules on page 696

Defining an Ancillary Pricing Rule for a Bill Group

Prerequisites

To define an ancillary pricing rule for a bill group, you should have:

- Pricing rule type where the category is set to **Ancillary**.
- Price items associated with the ancillary pricing rule type.
- Pricing arrangements defined in the ancillary pricing rule type.

Procedure

To define an ancillary pricing rule for a bill group:

- Search for the Administrative Services Only (ASO) person, whose person type is set to **Bill Group**, in the **Customer 360° View** screen.
- In the **Search Results** section, click the **View** (🔍) icon corresponding to the bill group whose pricing details you want to view.

The **Person** tab appears in the **Customer 360° Information** screen.

- Click the **Pricing** tab.

The **Pricing** tab appears.

- Click the **Broadcast** (📢) icon in the **Bill Group ASO Policy Information** zone, corresponding to the **Bill Group Information** column, whose bill group details you want to view.

The **Bill Group ASO Policy Pricing Rules** zone appears.

- Click the **Add** link in the upper-right corner of the **Bill Group ASO Policy Pricing Rules** zone.

The **Pricing Rule** screen appears. It contains the following fields:

Field Name	Field Description	Mandatory (Yes or No)
Person Name	Indicates the name of the parent customer.	Not applicable

Field Name	Field Description	Mandatory (Yes or No)
Person Type	Indicates the type of the parent customer.	Not applicable
	Note: If you are defining the pricing rule type for the parent customer, then the person type will be Parent Customer .	
Pricing Rule Type	Used to indicate the pricing rule type using which you want to create an ancillary pricing rule.	Yes
	Note: Select the Ancillary Pricing Rule Type option, as the pricing rule.	Note: If the pricing rule type is not selected then the application displays an error message.
Pricing Group	Used to indicate the pricing group which is used while defining the pricing.	No
Policy Status	Used to indicate the policy status for the pricing rule. The valid values are: <ul style="list-style-type: none"> • In Force/Active • Post Runout • Runout 	Yes
	Note: An ancillary pricing rule cannot be created for Runout or Post Runout policy status where the policy run out end date is missing.	

6. Click **OK**.

The **Ancillary Pricing Rule** screen appears. It contains the following sections:

- **Customer Information** – Displays the information about the bill group. It contains the following fields:

Field Name	Field Description
Bill Group Information	Displays the bill group information.
Policy Start Date	Displays the date from when the policy is effective.
Policy End Date	Displays the date till when the policy is effective.
Policy Status	Indicates the policy status for the pricing rule.
Pricing Rule Type	Indicates the pricing rule type for whom the ancillary pricing rule is created.

- **Main** – Used to specify basic details about the ancillary pricing rule. In addition it allows you to define pricing for different types of ancillary charges.

Field Name	Field Description	Mandatory (Yes or No)
Price Item	Used to indicate the price item that is used to create ancillary pricing rule.	Yes
Pricing Start Date	Used to specify the date from when the ancillary pricing rule is effective.	Yes
Pricing End Date	Used to specify the date till when the ancillary pricing rule is effective.	No

Field Name	Field Description	Mandatory (Yes or No)
Rate Option	Used to indicate the rate option that you want to use while defining the price item.	Yes
Pass Through without Markup or Markdown	Used when markup or markdown should not be calculated for the ancillary charge.	Yes (Conditional)
	Note: This field is enabled when the Rate Option field is selected.	Note: This field is required when you want to calculate the ancillary pricing without the pass through charge while defining the ancillary pricing rule.

The following fields appear when the **Pass Through without Markup or Markdown** option is not selected. It contains the following fields:

Field Name	Field Description	Mandatory (Yes or No)
Billable Charge Line Type	Used to indicate the billable charge line type using which you want to create the ancillary pricing rule.	Yes (Conditional)
	Note: The Search (🔍) icon appears corresponding to this field. On clicking the Search icon, the Billable Line Type Search window appears. On specifying the billable charge line type, the description of the billable charge line type appears corresponding to the Billable Charge Line Type field.	Note: This field is required while creating a pricing arrangement with or without rate based billable charge line type.
Billable	Used to indicate whether the ancillary charge is eligible for billing or not.	Yes (Conditional)
		Note: This field is required while creating a pricing arrangement with or without the Markup or Markdown Type field and the Rate Based option.
Rate Based	Used to indicate whether the ancillary charge is calculated using a particular rate.	Yes (Conditional)
		Note: This field is required while creating a pricing arrangement with the Rate Based option.
Rate	Used to indicate the rate for calculating the ancillary charge.	Yes (Conditional)
	Note: This field is enabled when the Rate Based option is selected.	Note: This field is required when Rate Based option is selected.

Field Name	Field Description	Mandatory (Yes or No)
Pricing Strategy	Used to indicate the price calculation strategy which should be applied while defining the ancillary pricing rule. The valid values are: <ul style="list-style-type: none"> • Markup • Markdown • None 	No
Markup or Markdown Type	Used to indicate the type of charge which should be applied while defining the ancillary pricing rule. The valid values are: <ul style="list-style-type: none"> • Flat Amount • Percentage 	Yes (Conditional)
	Note: This field is enabled when the Pricing Strategy field is selected.	Note: This field is required when the Pricing Strategy field is selected.
Amount / Percentage	Used to specify the actual proportion of the charge that should be applied while defining the ancillary pricing rule.	Yes (Conditional)
		Note: This field is required when the Markup or Markdown Type field is selected.

- **Characteristics** – Used to define the characteristics for the ancillary pricing rule.

7. Enter the required details in the **Main** section.
8. Define the characteristics for an ancillary pricing rule, if required.
9. Click **Save**.

The ancillary pricing rule for a bill group is defined.

Note: A price list and price assignment is created, the price list created is assigned to the ancillary pricing rule.

Related Topics

For more information on...	See...
Customer 360° Information – Pricing tab	Customer 360° Information - Pricing Information on page 693
Parent Customer Pricing Rules zone	Parent Customer Pricing Rules on page 696
How to define the characteristics for an ancillary pricing rule	Defining a Characteristic for an Ancillary Pricing Rule on page 2807

Defining a Characteristic for an Ancillary Pricing Rule

Prerequisites

To define a characteristic for an ancillary pricing rule, you should have:

- Characteristic types defined in the application (where the characteristic entity is set to **Pricing Rule**).

Procedure

To define a characteristic for an ancillary pricing rule:

1. Ensure that the **Characteristics** section is expanded when you are defining or editing an ancillary pricing rule.

The **Characteristics** section contains the following fields:

Column Name	Column Description	Mandatory (Yes or No)
Effective Date	Used to specify the date from when the characteristic is effective for the ancillary pricing rule.	Yes (Conditional)
		Note: This field is required when you are defining a characteristic for the ancillary pricing rule.
Characteristic Type	Used to indicate the characteristic type.	Yes (Conditional)
	Note: The list includes only those characteristic types where the characteristic entity is set to Pricing Rule .	Note: This field is required when you are defining a characteristic for the ancillary pricing rule.
Characteristic Value	Used to specify the value for the characteristic type.	Yes (Conditional)
	<p>Note:</p> <p>If you select a predefined characteristic type, the Search (🔍) icon appears corresponding to the Characteristic Value field. On clicking the Search icon, the Predefined Characteristic Search window appears.</p> <p>On specifying the value for a predefined characteristic type, the description of the characteristic value appears corresponding to the Characteristic Value field.</p>	Note: This field is required when you are defining a characteristic for the ancillary pricing rule.

2. Enter the required details in the **Characteristics** section.
3. If you want to define more than one characteristic for the ancillary pricing rule, click the **Add** (+) icon and then repeat step 2.

Note: However, if you want to remove a characteristic from the ancillary pricing rule, click the **Delete** (🗑️) icon corresponding to the characteristic.

4. Click **Save**.

The characteristics are defined for an ancillary pricing rule.

Related Topics

For more information on...	See...
How to define an ancillary pricing rule for a parent customer	Defining an Ancillary Pricing Rule for a Parent Customer on page 2804
How to edit an ancillary pricing rule for a parent customer	Editing an Ancillary Pricing Rule of a Parent Customer on page 2809
How to define an ancillary pricing rule for a bill group	Defining an Ancillary Pricing Rule for a Bill Group on page 2812
How to edit an ancillary pricing rule for a bill group	Editing an Ancillary Pricing Rule of a Bill Group on page 2817

Editing an Ancillary Pricing Rule of a Bill Group

Prerequisites

To edit an ancillary pricing rule of a bill group, you should have:

- Business Object **C1-PricingRuleAncillary** defined for ancillary pricing rule.

Procedure

To edit an ancillary pricing rule of a bill group:

1. Search for a bill group in the **Customer 360° View** screen.
2. In the **Search Results** section, click the **View** (🔗) icon corresponding to the bill group whose pricing details you want to view.

The **Person** tab appears in the **Customer 360° Information** screen.

3. Click the **Pricing** tab.

The **Pricing** tab appears.

4. Click the **Broadcast** (📡) icon in the **Bill Group ASO Policy Information** zone, corresponding to the **Bill Group Information** column, whose bill group details you want to view.

The **Bill Group ASO Policy Pricing Rules** zone appears.

5. Click the **Edit** (✎) icon in the **Bill Group ASO Policy Pricing Rules** zone, corresponding to the **Pricing Group Information** column, whose pricing details you want to edit.

The **Ancillary Pricing Rule** screen appears. It contains the following sections:

- **Customer Information** – Displays the customer information for bill group.

Field Name	Field Description
Bill Group Information	Displays the bill group for whom the ancillary pricing rule is define.
Policy Start Date	Displays the date from when the policy is effective.
Policy End Date	Displays the date till when the policy is effective.
Policy Status	Indicates the policy status for the pricing rule.
Pricing Rule Type	Indicates the pricing rule type using which you want to define an ancillary pricing rule.
Status	Indicates the status of the bill group.

- **Main** – Used to specify basic details about the ancillary pricing rule. It contains the following fields:

Field Name	Field Description	Mandatory (Yes or No)
Price Item	Indicates the price item that is used to create ancillary pricing rule.	Yes
Pricing Start Date	Displays the date from when the ancillary pricing rule is effective.	Yes

Field Name	Field Description	Mandatory (Yes or No)
Pricing End Date	Used to specify the date till when the ancillary pricing rule is effective.	No
	Note: This field by default displays the Policy End Date .	
Rate Option	Indicates the rate option that you want to use while defining the price item.	Yes
Pass Through without Markup or Markdown	Used to indicate that markup and markdown prices must not be considered when the ancillary transaction is processed.	Yes (Conditional)
	Note: This field is enabled when the Rate Option field is selected.	
		Note: This field is required when you want to calculate the ancillary pricing without the pass through charge while defining the ancillary pricing rule.

The following fields appear when the **Pass Through without Markup or Markdown** option is not selected. It contains the following fields:

Field Name	Field Description	Mandatory (Yes or No)
Billable Charge Line Type	Used to indicate the billable charge line type using which you want to create the ancillary pricing rule.	Yes (Conditional)
	Note: The Search (🔍) icon appears corresponding to this field. On clicking the Search icon, the Billable Line Type Search window appears. On specifying the billable charge line type, the description of the billable charge line type appears corresponding to the Billable Charge Line Type field.	
Billable	Used to indicate whether the ancillary charge is eligible for billing or not.	Yes (Conditional)
		Note: This field is required while creating a pricing arrangement with or without the Markup or Markdown Type field and the Rate Based option.
Rate Based	Used to indicate whether the ancillary charge is calculated using a particular rate.	Yes (Conditional)
		Note: This field is required while creating a pricing arrangement with the Rate Based option.

Field Name	Field Description	Mandatory (Yes or No)
Rate	Used to indicate the rate for calculating the ancillary charge.	Yes (Conditional)
	Note: This field is enabled when the Rate Based option is selected.	Note: This field is required when Rate Based option is selected.
Pricing Strategy	Used to indicate the price calculation strategy which should be applied while defining the ancillary pricing rule. The valid values are: <ul style="list-style-type: none"> • Markup • Markdown • None 	No
Markup or Markdown Type	Used to indicate the type of charge which should be applied while defining the ancillary pricing rule. The valid values are: <ul style="list-style-type: none"> • Flat Amount • Percentage 	Yes (Conditional)
	Note: This field is enabled when the Pricing Strategy field is selected.	Note: This field is required when the Pricing Strategy field is selected.
Amount/Percentage	Used to specify the actual proportion of the charge that should be applied while defining the ancillary pricing rule.	Yes (Conditional)
		Note: This field is required when the Markup or Markdown Type field is selected.

- **Characteristics** – Used to define the characteristics for the ancillary pricing rule.

6. Modify the details in the **Main** section.
7. Define, edit, or remove characteristics for an ancillary pricing rule, if required.
8. Click **Save**.

The changes made to an ancillary pricing rule for a bill group are saved.

Related Topics

For more information on...	See...
How to search for a parent customer	Searching for a Person on page 648
Parent Customer Pricing Rules zone	Parent Customer Pricing Rules on page 696
How to define a characteristic for an ancillary pricing rule	Defining a Characteristic for an Ancillary Pricing Rule on page 2807

Deleting an Ancillary Pricing Rule of a Bill Group

Procedure

To delete an ancillary pricing rule of a bill group:

1. Search for a bill group in the **Customer 360° View** screen.
2. In the **Search Results** section, click the **View** (🔗) icon corresponding to the bill group whose pricing details you want to view.
The **Person** tab appears in the **Customer 360° Information** screen.
3. Click the **Pricing** tab.
The **Pricing** tab appears.
4. Click the **Broadcast** (📡) icon in the **Bill Group ASO Policy Information** zone, corresponding to the **Bill Group Information** column, whose bill group details you want to delete.
The **Bill Group ASO Policy Pricing Rules** zone appears.
5. Click the **Delete** (🗑️) icon in the **Delete** column corresponding to the **Pricing Group Information** column, whose bill group information you want to delete.
A message appears confirming whether you want to delete the ancillary pricing rule of a bill group.

Note: You can delete an ancillary pricing rule when it is not yet used in the system.

6. Click **OK**.
The ancillary pricing rule of a bill group is deleted.

Related Topics

For more information on...	See...
How to search for a parent customer	Searching for a Person on page 648
Parent Customer Pricing Rules zone	Parent Customer Pricing Rules on page 696

Discount Pricing

The Administrative Services Only (ASO) provider may offer some discounts to its network hospitals and providers. A portion of these discounts is then charged to the self-funded employer. Oracle Revenue Management and Billing enables you to calculate and bill the discount share or discount guarantee amount to the self-funded employer. The system enables you to calculate the discount using the following methods:

- [Discount Share](#) on page 2821
- [Discount Guarantee](#) on page 2821

The pricing for the share or guarantee discount can be defined using the respective discount pricing rules. You can define a share or guarantee discount pricing rule only at the parent customer level. You can define the share or guarantee discount pricing rules for parent customers from the **Customer 360° Information** screen. You can define a share or guarantee discount pricing rule using a discount arrangement pricing rule type.

Once a discount arrangement pricing rule type is defined, you can create discount pricing rules using the discount arrangement pricing rule type. Once a discount pricing rule is created, the system creates multiple price assignments in a price list and assigns the price list to the parent customer.

The following new batches are introduced in this release:

- **C1-ACDA** – Once the transaction legs and calculation lines are created for discount, this batch is used to accumulate the discount. It also calculates the required minimum or maximum limit on the contract. For more information about the batch refer to *Oracle Revenue Management and Billing Batch Guide*.

- **C1-BCDA** – Once the discount is accumulated, this batch is used to create the credit (if any) and discount billable charges. It is also used to calculate the bill after date. For more information about the batch refer to *Oracle Revenue Management and Billing Batch Guide*.

Types of Discount Arrangement

The Oracle Revenue Management and Billing enables you to calculate the discount using the following methods:

- [Discount Share](#) on page 2821
- [Discount Guarantee](#) on page 2821

Discount Share

In the discount share method, the discount is calculated while processing the claim transaction. It is calculated as follows:

Billable Discount Amount = Discount Savings Amount * Discount Percentage

Note that the discount share percentage varies depending on various parameters (such as health coverage class, In or Out Network, etc). Therefore, the system enables you to define different discount percentage for the claim transactions which are received from employees with different set of attributes. The system allows you to define maximum discount amount that can be charged per claim transaction. You can optionally configure the minimum and maximum discount limit on the contract. Note that the minimum limit is applicable during the settlement and maximum limit is applicable when you execute the **C1-ACDA** batch. The minimum and maximum limit can be a flat limit or enrollment based limit. Once the discount is accumulated, you can charge the customer at the pre-defined frequency. If the discount amount exceeds the maximum discount limit per claim or if the discount amount exceeds maximum discount limit defined on the contract, a credit billable charge is created for the customer.

Discount Guarantee

In the discount guarantee method, the discount is calculated while processing the claim transaction. It is calculated as follows:

Targeted Guaranteed Amount = Covered Charge Amount * Discount Guarantee Percentage

Billable Discount Amount = Discount Savings Amount - Targeted Guaranteed Amount

Note that the discount guarantee percentage varies depending on various parameters (such as health coverage class, In or Out Network, etc). Therefore, the system enables you to define different discount percentage for the claim transactions which are received from employees with different set of attributes. The system allows you to define maximum discount amount that can be charged per claim transaction. You can optionally configure the minimum and maximum discount limit on the contract. Note that the minimum limit is applicable during the settlement and maximum limit is applicable when you execute the **C1-ACDA** batch. The minimum and maximum limit can be a flat limit or enrollment based limit. Once the discount is accumulated, you can charge the customer at the pre-defined frequency. If the discount amount exceeds the maximum discount limit per claim or if the discount amount exceeds maximum discount limit defined on the contract, a credit billable charge is created for the customer.

Defining a Discount Arrangement Pricing Rule Type

Prerequisites

To define a discount arrangement pricing rule type, you should have:

- Discount Arrangement pricing rule type business object defined in the application
- Discount Arrangement pricing rule business object defined in the application

Procedure

To define a discount arrangement pricing rule type:

1. Click the **Admin** link in the **Application** toolbar.

A list appears.

- From the **Admin** menu, select **P** and then click **Pricing Rule Type**.

A sub-menu appears.

- Click the **Add** option from the **Pricing Rule Type** sub-menu.

The **Select Business Object** screen appears. It contains the following field:

Field Name	Field Description	Mandatory (Yes or No)
Pricing Rule Type Business Object	<p>Used to indicate the business object using which you want to create a discount arrangement pricing rule type. The valid values are:</p> <ul style="list-style-type: none"> Aggregate Stop-Loss (ASL) Pricing Rule Type Ancillary Pricing Rule Type Claim Pricing Rule Type Discount Arrangement Pricing Rule Type Flat Fee Pricing Rule Type Level Funded (LF) Pricing Rule Type Retention Type Claim Based Pricing Rule Type Retention Type Enrollment Based Pricing Rule Type Specific Stop-Loss (SSL) Pricing Rule Type <p>Note: You must select the Discount Arrangement Pricing Rule Type option from the Pricing Rule Type Business Object list while defining a discount arrangement pricing rule type.</p>	Yes

Tip: Alternatively, you can access this screen by clicking the **Add** button in the **Page Title** area of the **Pricing Rule Type** screen.

- Select the **Discount Arrangement Pricing Rule Type** option from the **Pricing Rule Type Business Object** list.
- Click **OK**.

The **Discount Arrangement Pricing Rule Type** screen appears. It contains the following sections:

- Main** – Used to specify basic details about the discount arrangement pricing rule type.
- Algorithms** – Used to associate the algorithms with the discount arrangement pricing rule type.
- Additional Data** – Used to specify additional information in the discount arrangement pricing rule type.
- Price Items** – Used to add the price items for which you can define the discount arrangement pricing rules using the discount arrangement pricing rule type.
- Price Item Parameters** – Used to add the price item parameters based on which you want to define the price item pricing.
- Characteristics** – Used to define the characteristics for the discount arrangement pricing rule type.
- DA – Specific Additional Data** – Used to specify discount arrangement-specific additional data in the discount arrangement pricing rule type.

The **Main** section contains the following fields:

Field Name	Field Description	Mandatory (Yes or No)
Pricing Rule Type	Used to specify the discount arrangement pricing rule type.	Yes
Description	Used to specify the description for the discount arrangement pricing rule type.	Yes
Detailed Description	Used to specify additional information about the discount arrangement pricing rule type.	No
Pricing Rule Business Object	<p>Used to indicate the business object using which you want to create the discount arrangement pricing rule. The valid value are:</p> <ul style="list-style-type: none"> • Aggregate Stop-Loss (ASL) Pricing Rule • Ancillary Pricing Rule • Claim Pricing Rule • Discount Arrangement Pricing Rule • Flat Fee Pricing Rule • Level Funded (LF) Pricing Rule • Retention Type Claim Based Pricing Rule • Retention Type Enrollment Based Pricing Rule • Specific Stop-Loss (SSL) Pricing Rule <p>Note: You must select the Discount Arrangement Pricing Rule option from the Pricing Rule Business Object list while defining a discount arrangement pricing rule type.</p>	Yes
Business Object	Indicates the business object using which you are defining the discount arrangement pricing rule type.	Not applicable
Status	<p>Used to indicate the status of the discount arrangement pricing rule type. The valid values are:</p> <ul style="list-style-type: none"> • Active • Inactive 	Yes
Primary	<p>Used to indicate whether the discount arrangement pricing rule type is a primary pricing rule type.</p> <p>Note: You must not select the Primary option while defining a discount arrangement pricing rule type.</p>	Not applicable

Field Name	Field Description	Mandatory (Yes or No)
Pricing Rule Type Category	Used to indicate the category to which the discount arrangement pricing rule type belongs. The valid value is: <ul style="list-style-type: none"> • Aggregate Stop-Loss • Ancillary • Claim • Discount Arrangement • Flat Fees • Level Funded • Retention Type Claim Based • Retention Type Enrollment Based • Specific Stop-Loss 	Yes
	Note: You must select the Discount Arrangement option from the Pricing Rule Type Category list while defining a discount arrangement pricing rule type.	

- Enter the required details in the **Main** section.
- Select the **Discount Arrangement Pricing Rule** option from the **Pricing Rule Business Object** list.
- Ensure that **Primary** option is not selected when you are defining a discount arrangement pricing rule type.
- Select the **Discount Arrangement** option from the **Pricing Rule Type Category** list.
- Associate the following algorithms with the discount arrangement pricing rule type:

System Event	Algorithm	Algorithm Type	Description
Account and Price Item Derivation	C1_ACCPRDIS	C1_ACCPRDIS	Account and Priceitem Derivation For Discount Arrangement

- Define additional data for a discount arrangement pricing rule type, if required.
- Add the required price items in the discount arrangement pricing rule type.
- Add the price item parameters in the discount arrangement pricing rule type, if required.
- Define characteristics for a discount arrangement pricing rule type, if required.
- Add discount arrangement-specific additional data in the discount arrangement pricing rule type.
- Click **Save**.

The discount arrangement pricing rule type is defined.

Related Topics

For more information on...	See...
Pricing Rule Type screen	Pricing Rule Type on page 2532
How to associate algorithms with the discount arrangement pricing rule type	Associating Algorithms with a Discount Arrangement Pricing Rule Type on page 2825

For more information on...	See...
How to define additional data for a discount arrangement pricing rule type	Defining Additional Data in a Discount Arrangement Pricing Rule Type on page 2828
How to add price items in the discount arrangement pricing rule type	Adding a Price Item in a Discount Arrangement Pricing Rule Type on page 2830
How to add price item parameters in the discount arrangement pricing rule type	Adding a Price Item Parameter in a Discount Arrangement Pricing Rule Type on page 2833
How to define a characteristic for a discount arrangement pricing rule type	Defining a Characteristic for a Discount Arrangement Pricing Rule Type on page 2834
How to add discount arrangement-specific data in the discount arrangement pricing rule type	Defining the Discount Specific Data in a Discount Arrangement Pricing Rule Type on page 2835

Associating Algorithms with a Discount Arrangement Pricing Rule Type

Prerequisites

To associate algorithms with a discount arrangement pricing rule type, you should have:

- An algorithm defined using the **C1_ACCPRIDIS** algorithm type.

Procedure

To associate algorithms with a discount arrangement pricing rule type:

1. Ensure that the **Algorithms** section is expanded when you are defining or editing a discount arrangement pricing rule type.

The **Algorithms** section contains the following fields in a grid:

Field Name	Field Description	Mandatory (Yes or No)
System Event	<p>Used to indicate the system event when you want to execute the algorithm. The valid values are:</p> <ul style="list-style-type: none"> • Account and Price Item Derivation - Used to derive the account and price item for the discount arrangement transaction. • Accumulation Billable Charge Post Proc - Used to introduce a custom logic after creating discount share or discount guarantee billable charges. This algorithm is invoked in the C1-BCDA (Create Billable Charge for Discount) batch. • Accumulation Billable Charge Pre Proc - Used to introduce a custom logic before creating discount share or discount guarantee billable charges. This algorithm is invoked in the C1-BCDA (Create Billable Charge for Discount) batch. • Accumulation Post Processing - Used to introduce a custom logic after accumulating the discount share or discount guarantee amount. This algorithm is invoked in the C1-ACDA (Accumulate Discount Arrangement) batch. • Accumulation Pre Processing - Used to introduce a custom logic before accumulating the discount share or discount guarantee amount. This algorithm is invoked in the C1-ACDA (Accumulate Discount Arrangement) batch. • Pricing Rule Post Processing - Used to introduce a custom logic once the effective discount arrangement pricing rule is derived for the discount arrangement transaction. • Transaction Validation - Used to introduce a custom validation for the discount arrangement transaction. 	<p>Yes (Conditional)</p> <p>Note: This field is required when you are associating an algorithm with the discount arrangement pricing rule type.</p>
Sequence	<p>Used to specify the order in which the algorithms with the same system event must be executed.</p>	<p>Yes (Conditional)</p> <p>Note: This field is required when you are associating an algorithm with the discount arrangement pricing rule type.</p>

Field Name	Field Description	Mandatory (Yes or No)
Algorithm	Used to specify the algorithm that you want to execute on the system event.	Yes (Conditional)
	<p>Note:</p> <p>Once you select the system event, the Search (🔍) icon appears corresponding to the Algorithm field. On clicking the Search (🔍) icon, the Algorithm Search window appears.</p> <p>On specifying the algorithm, the description of the algorithm appears corresponding to the Algorithm field.</p>	<p>Note: This field is required when you are associating an algorithm with the discount arrangement pricing rule type.</p>

2. Enter the following details in the **Algorithms** section:

System Event	Algorithm	Mandatory (Yes or No)	For more information, see...
Account and Price Item Derivation	C1_ACCPRIDIS	Yes	Information will be available soon...
Accumulation Billable Charge Post Proc	-	No	-
	<p>Note: An accumulation billable charge post processing algorithm type is not shipped with the product. You can create a custom algorithm type, if required.</p>		
Accumulation Billable Charge Pre Proc	-	No	-
	<p>Note: An accumulation billable charge pre processing algorithm type is not shipped with the product. You can create a custom algorithm type, if required.</p>		
Accumulation Post Processing	-	No	-
	<p>Note: An accumulation post processing algorithm type is not shipped with the product. You can create a custom algorithm type, if required.</p>		
Accumulation Pre Processing	-	No	-
	<p>Note: A accumulation pre processing algorithm type is not shipped with the product. You can create a custom algorithm type, if required.</p>		

System Event	Algorithm	Mandatory (Yes or No)	For more information, see...
Pricing Rule Post Processing	-	No	
	Note: A pricing rule post processing algorithm type is not shipped with the product. You can create a custom algorithm type, if required.		
Transaction Validation	-	No	
	Note: An algorithm type for validating a discount arrangement transaction is not shipped with the product. You can create a custom algorithm type, if required.		

- If you want to associate more than one algorithm with the discount arrangement pricing rule type, click the **Add (+)** icon and then specify the details. However, if you want to remove an algorithm from the discount arrangement pricing rule type, click the **Delete (🗑)** icon corresponding to the algorithm.
- Click **Save**.

The algorithms are associated with the discount arrangement pricing rule type.

Related Topics

For more information on...	See...
How to define the discount arrangement pricing rule type	Defining a Discount Arrangement Pricing Rule Type on page 2821
How to edit the discount arrangement pricing rule type	Editing a Discount Arrangement Pricing Rule Type on page 2838

Defining Additional Data in a Discount Arrangement Pricing Rule Type

Procedure

To define additional data in a discount arrangement pricing rule type:

- Ensure that the **Additional Data** section is expanded when you are defining or editing a discount arrangement pricing rule type.

The **Additional Data** section contains the following fields:

Field Name	Field Description	Mandatory (Yes or No)
Eligible for Specific Stop-Loss	Used to indicate whether price items included in the discount arrangement pricing rule type are eligible for specific stop-loss. The valid values are: <ul style="list-style-type: none"> Yes No 	No

Field Name	Field Description	Mandatory (Yes or No)
Eligible for Level Funding	Used to indicate whether price items included in the discount arrangement pricing rule type are eligible for level funding. The valid values are: <ul style="list-style-type: none"> • Yes • No 	No
	Note: If you do not specify the value for this field, by default, it is set to No .	
Run-in Identifier Value	Used to specify the identifier value to determine whether the discount arrangement transaction is received during the run-in period of the policy.	No
Third Party Identifier Value	Used to specify the identifier value to determine whether the discount arrangement transaction is received from an external source system.	Not applicable
	Note: At present, this field is not used in the system.	
Accumulation Only Identifier Value	Used to specify the identifier value to determine whether the discount arrangement transaction contains the accumulated information of ASL, SSL, and Level Funding pricing types.	No
Eligible for Write-Off in Post Runout	Used to indicate whether the discount charges should be written off when the bill is generated in the post runout period of the policy. The valid values are: <ul style="list-style-type: none"> • Yes • No For more information, refer to the Write-Off Charges during Post Runout section.	No
	Note: By default, the value is set to No .	
Post Runout Write-Off Adjustment Type	Used to specify the adjustment type using which you want to create post runout write-off adjustment.	Yes (Conditional)
	Note: This field appears when the Eligible for Write-Off in Post Runout field is set to Yes . The Search (🔍) icon appears corresponding to the Post Runout Write-Off Adjustment Type field. On clicking the Search icon, the Adjustment Type Search window appears. On specifying the adjustment type, the description of the adjustment type appears corresponding to the Post Runout Write-Off Adjustment Type field.	Note: This field is required when the Eligible for Write-Off in Post Runout field is set to Yes .

Field Name	Field Description	Mandatory (Yes or No)
Rule Based Price Item Eligibility Field	Used to indicate the transaction field which you want to use in the rules as the output parameter to determine whether the price item should be considered for billing.	No
	<p>Note:</p> <p>For more information, refer to the Price Item Eligibility on page 2950 section.</p> <p>The Search (🔍) icon appears corresponding to the Rule Based Price Item Eligibility Field field. On clicking the Search icon, the Field Search window appears.</p> <p>On specifying the field name, the description of the field name appears corresponding to the Rule Based Price Item Eligibility Field.</p>	
Rule Based Eligibility Value	Used to specify the value which the output parameter in the rule should return when the price item in the discount arrangement pricing rule type should be considered for processing.	Yes (Conditional)
		<p>Note: This field is required when a value is specified in the Rule Based Price Item Eligibility Field field.</p>

- Enter the required details in the **Additional Data** section.
- Click **Save**.

The additional data is defined in the discount arrangement pricing rule type.

Related Topics

For more information on...	See...
How to define a discount arrangement pricing rule type	Defining a Discount Arrangement Pricing Rule Type on page 2821
How to edit a discount arrangement pricing rule type	Editing a Discount Arrangement Pricing Rule Type on page 2838

Adding a Price Item in a Discount Arrangement Pricing Rule Type

Prerequisites

To add a price item in a discount arrangement pricing rule type, you should have:

- Price item defined in the application
- Rate options defined in the **Rate Option (C1-ExtLookRetTypeRateOpt)** extendable lookup
- Values defined for the **Invoice Type (C1INVTYP)** characteristic type
- The **C1INVTYP** characteristic type set in the **Invoice Type Characteristic Type** option type of the **C1-ASOBLNG** feature configuration
- Rule types defined in the application (where the rule type usage is set to **Price Item Eligibility**)

Procedure

To add a price item in a pricing rule type:

1. Ensure that the **Price Items** section is expanded when you are defining or editing a discount arrangement pricing rule type.

The **Price Items** section contains the following fields in a grid:

Field Name	Field Description	Mandatory (Yes or No)				
Price Item	Used to indicate the price item that you want to include in the discount arrangement pricing rule type.	Yes (Conditional)				
	<p>Note:</p> <p>The Search (🔍) icon appears corresponding to the Price Item field. On clicking the Search icon, the Price Item Search window appears. On specifying the price item, the description of the price item appears corresponding to the Price Item field.</p>	<p>Note: This field is required when you are adding a rate option and bill to account in the discount arrangement pricing rule type.</p>				
Rate Option	Used to indicate one or more rate options which are valid for a price item.	Not applicable				
	On clicking the Add (➕) icon, the following field appears in a grid:					
	<table border="1"> <thead> <tr> <th>Field Name</th> <th>Field Description</th> <th>Mandatory (Yes or No)</th> </tr> </thead> <tbody> <tr> <td>Rate Option</td> <td>Used to indicate the rate option that you want to use while defining pricing for the price item.</td> <td>Yes</td> </tr> </tbody> </table>		Field Name	Field Description	Mandatory (Yes or No)	Rate Option
Field Name	Field Description	Mandatory (Yes or No)				
Rate Option	Used to indicate the rate option that you want to use while defining pricing for the price item.	Yes				
<p>Note:</p> <p>If you want to define more than one rate option to the price item in the discount arrangement pricing rule type, click the Add (➕) icon. However, if you want to remove a price item from a discount arrangement pricing rule type, click the Delete (🗑️) icon corresponding to the Rate Option field.</p>						

Field Name	Field Description	Mandatory (Yes or No)									
Bill To Account	<p>Used to indicate a order in which the account should be considered while deriving a transaction leg.</p> <p>On clicking the Add (+) icon, the following fields appear in a grid:</p> <table border="1"> <thead> <tr> <th>Field Name</th> <th>Field Description</th> <th>Mandatory (Yes or No)</th> </tr> </thead> <tbody> <tr> <td>Priority</td> <td>Used to specify the order in which the invoice type is considered for a price item.</td> <td>Yes</td> </tr> <tr> <td>Invoice Type</td> <td>Used to indicate the type which is considered for billing. For more information, refer to the Bill Group's Account on page 65 section.</td> <td>Yes</td> </tr> </tbody> </table> <p>Note: The Search (🔍) icon appears corresponding to the Invoice Type field. On clicking the Search icon, the Invoice Type Search window appears.</p> <p>Note: If you want to define more than one invoice type to the price item in a discount arrangement pricing rule type, click the Add (+) icon. However, if you want to remove a invoice type from the price item in a discount arrangement pricing rule type, click the Delete (🗑️) icon corresponding to the Priority field.</p>	Field Name	Field Description	Mandatory (Yes or No)	Priority	Used to specify the order in which the invoice type is considered for a price item.	Yes	Invoice Type	Used to indicate the type which is considered for billing. For more information, refer to the Bill Group's Account on page 65 section.	Yes	Not applicable
Field Name	Field Description	Mandatory (Yes or No)									
Priority	Used to specify the order in which the invoice type is considered for a price item.	Yes									
Invoice Type	Used to indicate the type which is considered for billing. For more information, refer to the Bill Group's Account on page 65 section.	Yes									
Eligibility Rule Type	Used to indicate the rule type which indicates the rules that should be executed to determine whether the price item is eligible for billing.	No									

- Enter the required details in the **Price Items** section.
- If you want to define more than one price item in a discount arrangement pricing rule type, click the **Add** (+) icon and then repeat step 2.

Note: However, if you want to remove a price item from a discount arrangement pricing rule type, click the **Delete** (🗑️) icon corresponding to the **Price Item** field.

- Click **Save**.

The price items are added for a discount arrangement pricing rule type.

Related Topics

For more information on...	See...
How to define a discount arrangement pricing rule type	Defining a Discount Arrangement Pricing Rule Type on page 2821

For more information on...	See...
How to edit a discount arrangement pricing rule type	Editing a Discount Arrangement Pricing Rule Type on page 2838

Adding a Price Item Parameter in a Discount Arrangement Pricing Rule Type

Prerequisites

To add a price item parameter in a discount arrangement pricing rule type, you should have:

- Parameter defined in the application where parameter usage is set to **Price Item**.
- Parameter associated with the price item.
- Transaction fields defined in the application.

Procedure

To add a price item parameter in a discount arrangement pricing rule type:

1. Ensure that the **Price Item Parameters** section is expanded when you are defining or editing a discount arrangement pricing rule type.

The **Price Item Parameters** section contains the following fields in a grid:

Field Name	Field Description	Mandatory (Yes or No)
Price Item Parameter	Used to specify the parameter which you can use while defining a discount arrangement pricing for the price item. Note: The Search (🔍) icon appears corresponding to the Price Item Parameter field. On clicking the Search (🔍) icon corresponding to the Price Item Parameter field, the Parameter Search window appears. On specifying the parameter, the description of the price item parameter appears corresponding to the Price Item Parameter field.	Yes (Conditional) Note: This field is required while adding a price item parameter in a discount arrangement pricing rule type.
Transaction Field	Used to map to a transaction field which contains the parameter value. Note: The Search (🔍) icon appears corresponding to the Transaction Field field. On clicking the Search (🔍) icon corresponding to the Transaction Field field, the Transaction Field Search window appears. On specifying the transaction field, the description of the transaction field appears corresponding to the Transaction Field .	Yes (Conditional) Note: This field is required while adding a price item parameter in a discount arrangement pricing rule type.
Eligible for Specific Stop-Loss	Used to indicate whether the price item parameter can be used while defining the accumulation criteria in the specific stop-loss or aggregate stop-loss pricing rules at the bill group level.	No

Field Name	Field Description	Mandatory (Yes or No)
Eligible for Level Funding	Used to indicate whether the price item parameter can be used while defining the accumulation criteria in the level funding pricing rules at the bill group level.	No

- Enter the required details in the **Price Item Parameters** section.
- If you want to add more than one price item parameter in a discount arrangement pricing rule type, click the **Add (+)** icon and then repeat step 2.

Note: However, if you want to remove a price item parameter from a discount arrangement pricing rule type, click the **Delete (🗑)** icon corresponding to the price item parameter.

- Click **Save**.

The price item parameter is added in the discount arrangement pricing rule type.

Related Topics

For more information on...	See...
How to define a discount arrangement pricing rule type	Defining a Discount Arrangement Pricing Rule Type on page 2821
How to edit a discount arrangement pricing rule type	Editing a Discount Arrangement Pricing Rule Type on page 2838

Defining a Characteristic for a Discount Arrangement Pricing Rule Type

Prerequisites

To define a characteristic for a discount arrangement pricing rule type, you should have:

- Characteristic types defined in the application (where the characteristic entity is set to **Pricing Rule Type**)

Procedure

To define a characteristic for a discount arrangement pricing rule type:

- Ensure that the **Characteristics** section is expanded when you are defining or editing a discount arrangement pricing rule type.

The **Characteristics** section contains the following fields in a grid:

Field Name	Field Description	Mandatory (Yes or No)
Characteristic Type	Used to indicate the characteristic type.	Yes (Conditional)
	Note: The list includes only those characteristic types where the characteristic entity is set to Pricing Rule Type .	Note: This field is required when you are defining a characteristic for a discount arrangement pricing rule type.

Field Name	Field Description	Mandatory (Yes or No)
Characteristic Value	Used to specify the value for the characteristic type.	Yes (Conditional)
	<p>Note:</p> <p>If you select a predefined characteristic type, the Search (🔍) icon appears corresponding to the Characteristic Value field. On clicking the Search icon, the Predefined Characteristic Search window appears.</p> <p>On specifying the value for a predefined characteristic type, the description of the characteristic value appears corresponding to the Characteristic Value field.</p>	<p>Note: This field is required when you are defining a characteristic for a discount arrangement pricing rule type.</p>

- Enter the required details in the **Characteristics** section.
- If you want to define more than one characteristic for a discount arrangement pricing rule type, click the **Add** (+) icon and then repeat step 2.

Note: However, if you want to remove a characteristic from a discount arrangement pricing rule type, click the **Delete** (🗑️) icon corresponding to the characteristic.

- Click **Save**.

The characteristic is defined for a discount arrangement pricing rule type.

Related Topics

For more information on...	See...
How to define a discount arrangement pricing rule type	Defining a Discount Arrangement Pricing Rule Type on page 2821
How to edit a discount arrangement pricing rule type	Editing a Discount Arrangement Pricing Rule Type on page 2838

Defining the Discount Specific Data in a Discount Arrangement Pricing Rule Type

Procedure

To add the discount-specific data in a discount arrangement pricing rule type:

- Ensure that the **DA - Specific Additional Data** section is expanded when you are defining or editing a discount arrangement pricing rule type.

The **DA - Specific Additional Data** section contains the following fields:

Field Name	Field Description	Mandatory (Yes or No)
Guaranteed Discount	<p>Used to indicate whether the discount arrangement pricing rule type is defined for discount guarantee or discount share. The valid values are:</p> <ul style="list-style-type: none"> Yes - Used when you want to create a discount guarantee pricing rule type. No - Used when you want to create a discount share pricing rule type. 	Yes

Field Name	Field Description	Mandatory (Yes or No)
Discount Billable Charge Line Type	<p>Used to indicate a billable charge line type using which you want to create the charge line for discount.</p> <p>Note:</p> <p>The Search (🔍) icon appears corresponding to the Discount Billable Charge Line Type field. On clicking the Search icon, the Billable Charge Line Type Search window appears.</p> <p>On specifying the billable charge line type, the description of the billable charge line type appears corresponding to the Discount Billable Charge Line Type field.</p>	Yes
Credit Billable Charge Line Type	<p>Used to indicate a billable charge line type using which you want to create the charge line for any credit to the customer.</p> <p>Note:</p> <p>The Search (🔍) icon appears corresponding to the Credit Billable Charge Line Type field. On clicking the Search icon, the Billable Charge Line Type Search window appears.</p> <p>On specifying the billable charge line type, the description of the billable charge line type appears corresponding to the Credit Billable Charge Line Type field.</p>	Yes
Minimum Limit Pricing Rule Type	<p>Used to indicate the retention type enrollment based pricing rule type which you want to use while calculating the minimum limit for the discount.</p> <p>Note:</p> <p>The Search (🔍) icon appears corresponding to the Minimum Limit Pricing Rule Type field. On clicking the Search icon, the Pricing Rule Type Search window appears.</p> <p>On specifying the pricing rule type, the description of the pricing rule type appears corresponding to the Minimum Limit Pricing Rule Type field.</p>	<p>Yes (Conditional)</p> <p>Note: This field is required when you are defining enrollment based minimum discount limit on the contract in a discount share pricing rule.</p>

Field Name	Field Description	Mandatory (Yes or No)
Minimum Limit Price Item	Used to indicate the price item whose pricing you want to use while calculating the minimum limit for the discount.	Yes (Conditional)
	<p>Note:</p> <p>The Search (🔍) icon appears corresponding to the Minimum Limit Price Item field. On clicking the Search icon, the Price Item Details window appears.</p> <p>On specifying the price item, the description of the price item appears corresponding to the Minimum Limit Price Item field.</p>	<p>Note: This field is required when you are defining enrollment based minimum discount limit on the contract in a discount share pricing rule.</p>
Maximum Limit Pricing Rule Type	Used to indicate the retention type enrollment based pricing rule type which you want to use while calculating the maximum limit for the discount.	Yes (Conditional)
	<p>Note:</p> <p>The Search (🔍) icon appears corresponding to the Maximum Limit Pricing Rule Type field. On clicking the Search icon, the Pricing Rule Type Search window appears.</p> <p>On specifying the pricing rule type, the description of the pricing rule type appears corresponding to the Maximum Limit Pricing Rule Type field.</p>	<p>Note: This field is required when you are defining enrollment based maximum discount limit on the contract in a discount share or discount guarantee pricing rule.</p>
Maximum Limit Price Item	Used to indicate the price item whose pricing you want to use while calculating the maximum limit for the discount. Used to indicate the price item whose pricing you want to use while calculating the minimum limit for the discount.	Yes (Conditional)
	<p>Note:</p> <p>The Search (🔍) icon appears corresponding to the Maximum Limit Price Item field. On clicking the Search icon, the Price Item Details window appears.</p> <p>On specifying the price item, the description of the price item appears corresponding to the Maximum Limit Price Item field.</p>	<p>Note: This field is required when you are defining enrollment based maximum discount limit on the contract in a discount share or discount guarantee pricing rule.</p>

2. Enter the required details in the **DA - Specific Additional Data** section.
3. Click **Save**.

The discount-specific data is added in the discount arrangement pricing rule type.

Related Topics

For more information on...	See...
How to define a discount arrangement pricing rule type	Defining a Discount Arrangement Pricing Rule Type on page 2821

For more information on...	See...
How to edit a discount arrangement pricing rule type	Editing a Discount Arrangement Pricing Rule Type on page 2838

Editing a Discount Arrangement Pricing Rule Type

Prerequisites

To edit a discount arrangement pricing rule type, you should have:

- Discount arrangement pricing rule type business object defined in the application.
- Discount arrangement pricing rule business object defined in the application.

Procedure

To edit a discount arrangement pricing rule type:

1. Click the **Admin** link in the **Application** toolbar.
A list appears.
2. From the **Admin** menu, select **P** and then click **Pricing Rule Type**.
A sub-menu appears.
3. Click the **Search** option from the **Pricing Rule Type** sub-menu.
The **Pricing Rule Type** screen appears.
4. In the **Pricing Rule Type List** zone, click the **Edit** (✎) icon in the **Edit** column corresponding to the pricing rule type whose details you want to edit.

The **Discount Arrangement Pricing Rule Type** screen appears. It contains the following sections:

- **Main** – Used to specify basic details about the discount arrangement pricing rule type.
- **Algorithms** – Used to associate the algorithms with the discount arrangement pricing rule type.
- **Additional Data** – Used to specify additional information in the discount arrangement pricing rule type.
- **Price Items** – Used to add the price items for which you can define the discount arrangement pricing rules using the discount arrangement pricing rule type.
- **Price Item Parameters** – Used to add the price item parameters based on which you want to define the price item pricing.
- **Characteristics** – Used to define the characteristics for the discount arrangement pricing rule type.
- **DA-Specific Additional Data** – Used to specify discount arrangement-specific additional data in a discount arrangement pricing rule type.

The **Main** section contains the following fields:

Field Name	Field Description	Mandatory (Yes or No)
Pricing Rule Type	Displays the discount arrangement pricing rule type.	Not applicable
Description	Used to specify the description for the discount arrangement pricing rule type.	Yes
Detailed Description	Used to specify additional information about the discount arrangement pricing rule type.	No

Field Name	Field Description	Mandatory (Yes or No)
Pricing Rule Business Object	<p>Used to indicate the business object using which you want to create the discount arrangement pricing rule. The valid value is:</p> <ul style="list-style-type: none"> • Aggregate Stop-Loss (ASL) Pricing Rule • Ancillary Pricing Rule • Claim Pricing Rule • Discount Arrangement Pricing Rule • Flat Fee Pricing Rule • Level Funded (LF) Pricing Rule • Retention Type Claim Based Pricing Rule • Retention Type Enrollment Based Pricing Rule • Specific Stop-Loss (SSL) Pricing Rule <p>Note: You must select the Discount Arrangement Pricing Rule option from the Pricing Rule Business Object list while defining a discount arrangement pricing rule type.</p>	Yes
Business Object	Indicates the business object used while defining the discount arrangement pricing rule type.	Not applicable
Status	<p>Used to indicate the status of the discount arrangement pricing rule type. The valid values are:</p> <ul style="list-style-type: none"> • Active • Inactive 	Yes
Primary	<p>Used to indicate whether the discount arrangement pricing rule type is a primary pricing rule type.</p> <p>Note: You must not select the Primary option while defining the discount arrangement pricing rule type.</p>	Not applicable

Field Name	Field Description	Mandatory (Yes or No)
Pricing Rule Type Category	<p>Indicates the category to which the discount arrangement pricing rule type belongs. The valid values are:</p> <ul style="list-style-type: none"> Aggregate Stop-Loss Ancillary Claim Discount Arrangement Flat Fees Level Funded Retention Type Claim Based Retention Type Enrollment Based Specific Stop-Loss 	No
	<p>Note: You must select the Discount Arrangement option from the Pricing Rule Type Category list while defining a discount arrangement pricing rule type.</p>	

Tip: Alternatively, you can edit the details of a discount arrangement pricing rule type by clicking the **Edit** button in the **Pricing Rule Type** zone.

- Modify the required details in the **Main** section.
- Ensure that the **Discount Arrangement Pricing Rule** option is selected from the **Pricing Rule Business Object** list.
- Ensure that **Primary** option is not selected when you are editing a discount arrangement pricing rule type.
- Associate the following algorithms with the discount arrangement pricing rule type:

System Event	Algorithm	Algorithm Type	Description
Account and Price Item Derivation	C1_ACCPRIDIS	C1_ACCPRIDIS	Account and Priceitem Derivation For Discount Arrangement

- Modify the additional data for a discount arrangement pricing rule type, if required.
- Add, edit, or remove price items in the discount arrangement pricing rule type, if required.
- Add, edit, or remove price item parameters in the discount arrangement pricing rule type, if required.
- Add, edit, or remove characteristics in the discount arrangement pricing rule type, if required.
- Modify the discount arrangement-specific data in the discount arrangement pricing rule type, if required.
- Click **Save**.

The changes made to the discount arrangement pricing rule type are saved.

Related Topics

For more information on...	See...
How to associate a algorithm with the discount arrangement pricing rule type	Associating Algorithms with a Discount Arrangement Pricing Rule Type on page 2825

For more information on...	See...
How to define additional data for discount arrangement pricing rule type	Defining Additional Data in a Discount Arrangement Pricing Rule Type on page 2828
How to add pricing items in the discount arrangement pricing rule type	Adding a Price Item in a Discount Arrangement Pricing Rule Type on page 2830
How to add price item parameters in the discount arrangement pricing rule type	Adding a Price Item Parameter in a Discount Arrangement Pricing Rule Type on page 2833
How to define a characteristic for the discount arrangement pricing rule type	Defining a Characteristic for a Discount Arrangement Pricing Rule Type on page 2834
How to define discount arrangement-specific data in the pricing rule type	Defining the Discount Specific Data in a Discount Arrangement Pricing Rule Type on page 2835

Deleting a Discount Arrangement Pricing Rule Type

Procedure

To delete a discount arrangement pricing rule type:

1. Click the **Admin** link in the **Application** toolbar.
A list appears.
2. From the **Admin** menu, select **P** and then click **Pricing Rule Type**.
A sub-menu appears.
3. Click the **Search** option from the **Pricing Rule Type** sub-menu.
The **Pricing Rule Type** screen appears.
4. In the **Pricing Rule Type List** zone, click the **Delete** (🗑️) icon in the **Delete** column corresponding to the discount arrangement pricing rule type that you want to delete.
A message appears confirming whether you want to delete the discount arrangement pricing rule type.

Note: You can delete a discount arrangement pricing rule type when it is not yet used in the system.

Tip: Alternatively, you can delete a discount arrangement pricing rule type by clicking the **Delete** button in the **Pricing Rule Type** zone.

5. Click **OK**.
The discount arrangement pricing rule type is deleted.

Related Topics

For more information on...	See...
Pricing Rule Type screen	Pricing Rule Type on page 2532
Pricing Rule Type List zone	Pricing Rule Type List on page 2533
Pricing Rule Type zone	Pricing Rule Type on page 2536

Viewing the Discount Arrangement Pricing Rule Type Details

Procedure

To view the details of a discount arrangement pricing rule type:

1. Click the **Admin** link in the **Application** toolbar.
A list appears.
2. From the **Admin** menu, select **P** and then click **Pricing Rule Type**.
A sub-menu appears.
3. Click the **Search** option from the **Pricing Rule Type** sub-menu.
The **Pricing Rule Type** screen appears.
4. In the **Pricing Rule Type List** zone, click the **Broadcast** () icon corresponding to the discount arrangement pricing rule type whose details you want to view.
The **Pricing Rule Type** zone appears.
5. View the details of the discount arrangement pricing rule type in the **Pricing Rule Type** zone.

Related Topics

For more information on...	See...
Pricing Rule Type screen	Pricing Rule Type on page 2532
Pricing Rule Type List zone	Pricing Rule Type List on page 2533
Pricing Rule Type zone	Pricing Rule Type on page 2536

Defining a Discount Arrangement Pricing Rule for a Parent Customer

Prerequisites

To define a discount arrangement pricing rule for a parent customer, you should have:

- Pricing rule type where the category is set to **Discount Arrangement**.
- Price items associated with the discount arrangement pricing rule type.

Procedure

To define a discount arrangement pricing rule for a parent customer:

1. Search for a parent customer in the **Customer 360° View** screen.
2. In the **Search Results** section, click the **View** () icon corresponding to the parent customer whose pricing details you want to view.
The **Person** tab appears in the **Customer 360° Information** screen.
3. Click the **Pricing** tab.
The **Pricing** tab appears.
4. Click the **Add** link in the upper-right corner of the **Parent Customer Pricing Rules** zone.
The **Pricing Rule** screen appears. It contains the following fields:

Field Name	Field Description	Mandatory (Yes or No)
Person Name	Indicates the parent customer for whom you want to create a discount arrangement pricing rule type.	Not applicable
Person Type	Indicates the type of the parent customer. The valid value is: <ul style="list-style-type: none"> Parent Customer 	Not applicable
Pricing Rule Type	Used to indicate the pricing rule type using which you want to create a discount arrangement pricing rule.	Yes

- Select the required pricing rule type in the respective field.
- Click **OK**.

The **Discount Arrangement Pricing Rule** screen appears. It contains the following sections:

- Customer Information** – Displays information about the parent customer for whom you are defining the discount arrangement pricing rule. It contains the following fields:

Field Name	Field Description
Parent Customer Information	Indicates the parent customer for whom you are defining the discount arrangement pricing rule.
Pricing Rule Type	Indicates the pricing rule type using which you are defining the discount arrangement pricing rule.

- Main** – Used to specify basic details about the discount arrangement pricing rule.
- Discount Details** – Used to define eligibility criteria for a discount percentage and maximum discount amount which is allowed per claim.
- Discount Limits** – Used when you want to define minimum and maximum discount limit on the contract.
- Exclusion** – Used when you want to exclude certain network hospitals and providers during the discount share or discount guarantee calculation.
- Characteristics** – Used to define the characteristics for the discount arrangement pricing rule.

Note: The **Discount Details**, **Discount Limits**, and **Exclusion** sections appear when you specify a price item in the **Main** section.

The **Main** section contains the following fields:

Field Name	Field Description	Mandatory (Yes or No)
Price Item	Used to indicate the price item for which you want to define the discount arrangement pricing rule.	Yes
Pricing Start Date	Used to specify the date from when the discount arrangement pricing rule is effective.	Yes
	Note: The pricing start date cannot be later than the pricing end date.	

Field Name	Field Description	Mandatory (Yes or No)
Pricing End Date	Used to specify the date till when the discount arrangement pricing rule is effective.	No
	Note: The pricing end date cannot be earlier than the pricing start date.	
Rate Option	Used to indicate the rate option that you want to use while defining the pricing for the price item.	Yes
Settlement Frequency	Used to indicate the settlement frequency which helps to determine the bill after date. The valid values are: <ul style="list-style-type: none"> • Manually (At Regular Intervals) - If you select this option from the list, the bill after date which is specified in the Manual Settlement Bill After Date parameter while executing the C1-BCDA batch is stamped on the credit billable charge. • Yearly - If you select this option from the list, the bill after date in the credit billable charge is set to the pricing end date. 	Yes
	Note: The bill after date is stamped on the credit billable charges and not on the discount billable charges.	

7. Enter the required details in the **Main** section.
8. Add the required discount details in the discount arrangement pricing rule.
9. Define the minimum and maximum discount limits on the contract in the discount arrangement pricing rule, if required.
10. Add the exclusion details of a network or a provider in the discount arrangement pricing rule, if required.
11. Define characteristics for the discount arrangement pricing rule, if required.
12. Click **Save**.

The discount arrangement pricing rule is defined for the parent customer.

Related Topics

For more information on...	See...
How to search for a parent customer	Searching for a Person on page 648
Parent Customer Pricing Rules zone	Parent Customer Pricing Rules on page 696
How to add the discount details in a discount arrangement pricing rule	Adding the Discount Details in a Discount Arrangement Pricing Rule on page 2845
How to define the discount limits in a discount arrangement pricing rule	Defining the Discount Limits in a Discount Arrangement Pricing Rule on page 2846
How to exclude a network or provider in a discount arrangement pricing rule	Excluding a Network or Provider in a Discount Arrangement Pricing Rule on page 2848
How to define a characteristic for a discount arrangement pricing rule	Defining a Characteristic for a Discount Arrangement Pricing Rule on page 2849

Adding the Discount Details in a Discount Arrangement Pricing Rule

Prerequisites

To add the discount details in a discount arrangement pricing rule, you should have:

- Parameters defined in the application
- Parameters associated with the price item.

Procedure

To add the discount details in a discount arrangement pricing rule:

1. Ensure that the **Discount Details** section appears when you are defining or editing a discount arrangement pricing rule.

The **Discount Details** section contains the following fields in a grid:

Field Name	Field Description	Mandatory (Yes or No)
Price Item Parameter	<p>Used to indicate the parameter using which you want to define an eligibility criteria for a discount percentage and maximum discount amount which is allowed per claim.</p> <p>Note:</p> <p>The Search (🔍) icon appears corresponding to the Price Item Parameter field. On clicking the Search icon, the Price Item Parameter Search window appears.</p> <p>On specifying the parameter, the description of the parameter appears corresponding to the Price Item Parameter field.</p> <p>You can only select those price item parameters which are effective during the date range specified in the discount arrangement pricing rule.</p> <p>If a parameter associated with the price item is mandatory, then by default, the parameter appears in the Price Item Parameter field.</p>	No
Parameter Value	<p>Used to specify the value for the price item parameter.</p> <p>Note:</p> <p>If you select a predefined parameter, the Search (🔍) icon appears corresponding to the Parameter Value field. On clicking the Search icon, the Predefined Parameter Value Search window appears.</p> <p>On specifying the parameter value, the description of the parameter value appears corresponding to the Parameter Value field.</p>	<p>Yes (Conditional)</p> <p>Note: This field is required when the parameter associated with the price item is mandatory.</p>
Discount Percentage	Used to specify the discount share or discount guarantee percentage.	Yes

Field Name	Field Description	Mandatory (Yes or No)
Maximum Discount Per Claim	Used to specify the maximum discount amount which is allowed per claim. If the discount amount exceeds the maximum limit per claim, the additional amount is credited to the customer.	No

Note: The **Discount Details** section appears when you specify a price item in the **Main** section.

- Enter the required details in the **Discount Details** section.
- If you want to define a discount percentage for another price item parameter and parameter value combination, click the **Add (+)** icon and then repeat step 2.

Note: However, if you want to remove a discount percentage for a price item parameter and parameter value combination from the discount arrangement pricing rule, click the **Delete (🗑)** icon corresponding to the combination.

- Click **Save**.

The discount details are added in the discount arrangement pricing rule.

Related Topics

For more information on...	See...
How to define a discount arrangement pricing rule for a parent customer	Defining a Discount Arrangement Pricing Rule for a Parent Customer on page 2842
How to edit a discount arrangement pricing rule of a parent customer	Editing a Discount Arrangement Pricing Rule of a Parent Customer on page 2850

Defining the Discount Limits in a Discount Arrangement Pricing Rule

Prerequisites

To define the discount limits in a discount arrangement pricing rule, you should have:

- An account, to which you want to credit the discount, defined in the application
- Minimum limit pricing rule type and minimum limit price item defined in the respective discount arrangement pricing rule type when you want to define minimum discount limit on the contract
- Maximum limit pricing rule type and maximum limit price item defined in the respective discount arrangement pricing rule type when you want to define maximum discount limit on the contract

Procedure

To define the discount limits in a discount arrangement pricing rule:

- Ensure that the **Discount Limits** section appears when you are defining or editing a discount arrangement pricing rule.

The **Discount Limits** section contains the following fields:

Field Name	Field Description	Mandatory (Yes or No)
No Limit	Used to indicate whether you want to define minimum or maximum discount limit on the contract.	No

Field Name	Field Description	Mandatory (Yes or No)
Discount Credit Account	Used to indicate the account to which you want to credit the discount when the minimum or maximum discount limit is defined on the contract.	Yes (Conditional)
	Note: This field is enabled when the No Limit option is not selected.	Note: This field is required when the No Limit option is not selected.
Settlement Days	Used to specify the number of days which helps to calculate the final settlement date (which is pricing end date + the settlement days). The valid values: <ul style="list-style-type: none"> • 30 Days • 60 Days • 90 Days • 120 Days • 150 Days • 180 Days 	Yes

In addition, it contains the following fields in a grid:

Field Name	Field Description	Mandatory (Yes or No)
Type of Discount Limit	Displays the type of discount limit. The valid values are: <ul style="list-style-type: none"> • Minimum • Maximum 	Not applicable
Select	On clicking the check box corresponding to the type of discount limit, you can define minimum or maximum discount limit on the contract. <p>Note: This field is enabled when the No Limit option is not selected.</p>	Yes
Limit Type	Used to indicate whether you want to define a flat limit or an enrollment based limit. The valid values are: <ul style="list-style-type: none"> • Enrollment Based • Flat 	Yes (Conditional)
	Note: This field is enabled when the No Limit option is not selected. If you select the check box corresponding to the Minimum discount limit, the Limit Type field corresponding to the Minimum discount limit is enabled.	Note: This field is required when you are defining a minimum or maximum discount limit in the discount arrangement pricing rule.

Field Name	Field Description	Mandatory (Yes or No)
Amount Limit	Used to specify the flat minimum or maximum discount amount.	Yes (Conditional)
	<p>Note:</p> <p>This field is enabled when:</p> <ul style="list-style-type: none"> The No Limit option is not selected. The minimum or maximum limit type is set to Flat. 	<p>Note: This field is required when the minimum or maximum limit type is set to Flat.</p>

Note: The **Discount Limits** section appears when you specify a price item in the **Main** section.

- Enter the required details in the **Discount Limits** section.
- Click **Save**.

The discount limits are defined in the discount arrangement pricing rule.

Related Topics

For more information on...	See...
How to define a discount arrangement pricing rule for a parent customer	Defining a Discount Arrangement Pricing Rule for a Parent Customer on page 2842
How to edit a discount arrangement pricing rule of a parent customer	Editing a Discount Arrangement Pricing Rule of a Parent Customer on page 2850

Excluding a Network or Provider in a Discount Arrangement Pricing Rule

Procedure

To exclude a network or provider in a discount arrangement pricing rule:

- Ensure that the **Exclusion** section appears when you are defining or editing a discount arrangement pricing rule.

The **Exclusion** section contains the following fields in a grid:

Field Name	Field Description	Mandatory (Yes or No)
Exclusion Level	Used to indicate whether you want to exclude the discount offered to certain network hospitals and providers during the discount share or discount guarantee calculation. The valid values are: <ul style="list-style-type: none"> Network Provider 	Yes (Conditional)
	<p>Note: The system creates the transaction legs and calculation lines for such excluded network hospitals and providers, but does not accumulate the discount.</p>	<p>Note: This field is required while excluding a network or provider in the discount arrangement pricing rule.</p>

Field Name	Field Description	Mandatory (Yes or No)
Level Identifier	Used to specify the network or provider ID.	Yes (Conditional)
		Note: This field is required while excluding a network or provider in the discount arrangement pricing rule.

- Enter the required details in the **Exclusion** section.
- If you want to exclude more than one network or provider in the discount arrangement pricing rule, click the **Add (+)** icon and then repeat step 2.

Note: However, if you want to remove a network or provider from the exclusion list, click the **Delete** (🗑️) icon corresponding to the network or provider.

- Click **Save**.

The network or provider is excluded in the discount arrangement pricing rule.

Related Topics

For more information on...	See...
How to define a discount arrangement pricing rule for a parent customer	Defining a Discount Arrangement Pricing Rule for a Parent Customer on page 2842
How to edit a discount arrangement pricing rule of a parent customer	Editing a Discount Arrangement Pricing Rule of a Parent Customer on page 2850

Defining a Characteristic for a Discount Arrangement Pricing Rule

Prerequisites

To define a characteristic for a discount arrangement pricing rule, you should have:

- Characteristic types defined in the application (where the characteristic entity is set to **Pricing Rule**).

Procedure

To define a characteristic for a discount arrangement pricing rule:

- Ensure that the **Characteristics** section is expanded when you are defining or editing a discount arrangement pricing rule.

The **Characteristics** section contains the following fields in the grid:

Column Name	Column Description	Mandatory (Yes or No)
Effective Date	Used to specify the date from when the characteristic is effective for the discount arrangement pricing rule.	Yes (Conditional)
		Note: This field is required when you are defining a characteristic for the discount arrangement pricing rule.

Column Name	Column Description	Mandatory (Yes or No)
Characteristic Type	Used to indicate the characteristic type.	Yes (Conditional)
	Note: The list includes only those characteristic types where the characteristic entity is set to Pricing Rule .	Note: This field is required when you are defining a characteristic for the discount arrangement pricing rule.
Characteristic Value	Used to specify the value for the characteristic type.	Yes (Conditional)
	Note: If you select a predefined characteristic type, the Search (🔍) icon appears corresponding to the Characteristic Value field. On clicking the Search icon, the Predefined Characteristic Search window appears. On specifying the value for a predefined characteristic type, the description of the characteristic value appears corresponding to the Characteristic Value field.	Note: This field is required when you are defining a characteristic for the discount arrangement pricing rule.

- Enter the required details in the **Characteristics** section.
- If you want to define more than one characteristic for the discount arrangement pricing rule, click the **Add** (+) icon and then repeat step 2.

Note: However, if you want to remove a characteristic from the discount arrangement pricing rule, click the **Delete** (🗑️) icon corresponding to the characteristic.

- Click **Save**.

The characteristics are defined for the discount arrangement pricing rule.

Related Topics

For more information on...	See...
How to define a discount arrangement pricing rule for a parent customer	Defining a Discount Arrangement Pricing Rule for a Parent Customer on page 2842
How to edit a discount arrangement pricing rule of a parent customer	Editing a Discount Arrangement Pricing Rule of a Parent Customer on page 2850

Editing a Discount Arrangement Pricing Rule of a Parent Customer

Procedure

To edit a discount arrangement pricing rule of a parent customer:

- Search for a parent customer in the **Customer 360° View** screen.
- In the **Search Results** section, click the **View** (🔗) icon corresponding to the parent customer whose pricing details you want to view.

The **Person** tab appears in the **Customer 360° Information** screen.

- Click the **Pricing** tab.

The **Pricing** tab appears.

4. In the **Parent Customer Pricing Rules** zone, click the **Edit** (✎) icon in the **Edit** column corresponding to the discount arrangement pricing rule, whose details you want to edit.

The **Discount Arrangement Pricing Rule** screen appears. It contains the following sections:

- **Customer Information** – Displays information about the parent customer for whom the discount arrangement pricing rule is defined. It contains the following fields:

Field Name	Field Description
Parent Customer Information	Indicates the parent customer for whom the discount arrangement pricing rule is defined.
Pricing Rule Type	Indicates the discount arrangement pricing rule type using which the discount arrangement pricing rule is defined.

- **Main** – Used to specify basic details in the discount arrangement pricing rule.
- **Discount Details** – Used to define eligibility criteria for a discount percentage and maximum discount amount which is allowed per claim.
- **Discount Limits** – Used when you want to define minimum and maximum discount limit on the contract.
- **Exclusion** – Used when you want to exclude certain network hospitals and providers during the discount share or discount guarantee calculation.
- **Characteristics** – Used to define the characteristics for the discount arrangement pricing rule.

The **Main** section contains the following fields:

Field Name	Field Description	Mandatory (Yes or No)
Price Item	Used to indicate the price item for which you want to define the discount arrangement pricing rule.	Yes
Pricing Start Date	Used to specify the date from when the discount arrangement pricing rule is effective.	Yes
	Note: The pricing start date cannot be later than the pricing end date.	
Pricing End Date	Used to specify the date till when the discount arrangement pricing rule is effective.	No
	Note: The pricing end date cannot be earlier than the pricing start date.	
Rate Option	Used to indicate the rate option that you want to use while defining the pricing for the price item.	Yes

Field Name	Field Description	Mandatory (Yes or No)
Settlement Frequency	<p>Used to indicate the settlement frequency which helps to determine the bill after date. The valid values are:</p> <ul style="list-style-type: none"> • Manually (At Regular Intervals) - If you select this option from the list, the bill after date which is specified in the Manual Settlement Bill After Date parameter while executing the C1-BCDA batch is stamped on the credit billable charge. • Yearly - If you select this option from the list, the bill after date in the credit billable charge is set to the pricing end date. 	Yes
	<p>Note: The bill after date is stamped on the credit billable charges and not on the discount billable charges.</p>	

5. Modify the required details in the **Main** section.
6. Modify the required discount details in the discount arrangement pricing rule.
7. Modify the minimum or maximum discount limit on the contract in the discount arrangement pricing rule, if required.
8. Modify the exclusion list in the discount arrangement pricing rule, if required.
9. Define, edit, or remove characteristics of the discount arrangement pricing rule, if required.
10. Click **Save**.

The changes made to the discount arrangement pricing rule are saved.

Related Topics

For more information on...	See...
How to search for a parent customer	Searching for a Person on page 648
Parent Customer Pricing Rules zone	Parent Customer Pricing Rules on page 696
How to add the discount details in a discount arrangement pricing rule	Adding the Discount Details in a Discount Arrangement Pricing Rule on page 2845
How to define the discount limits in a discount arrangement pricing rule	Defining the Discount Limits in a Discount Arrangement Pricing Rule on page 2846
How to exclude a network or provider in a discount arrangement pricing rule	Excluding a Network or Provider in a Discount Arrangement Pricing Rule on page 2848
How to define a characteristic for a discount arrangement pricing rule	Defining a Characteristic for a Discount Arrangement Pricing Rule on page 2849

Deleting a Discount Arrangement Pricing Rule of a Parent Customer

Procedure

To delete a discount arrangement pricing rule of a parent customer:

1. Search for a parent customer in the **Customer 360° View** screen.

- In the **Search Results** section, click the **View** () icon corresponding to the parent customer whose pricing details you want to view.

The **Person** tab appears in the **Customer 360° Information** screen.

- Click the **Pricing** tab.

The **Pricing** tab appears.

- In the **Parent Customer Pricing Rules** zone, click the **Delete** () icon in the **Delete** column corresponding to the discount arrangement pricing rule that you want to delete.

A message appears confirming whether you want to delete the discount arrangement pricing rule.

Note: You can delete a discount arrangement pricing rule when it is not yet used in the system.

- Click **OK**.

The discount arrangement pricing rule of a parent customer is deleted.

Related Topics

For more information on...	See...
How to search for a parent customer	Searching for a Person on page 648
Parent Customer Pricing Rules zone	Parent Customer Pricing Rules on page 696

Write-Off Charges during Post Runout

Oracle Revenue Management and Billing enables you to write-off the claim, specific stop-loss, aggregate stop-loss, claim based fees, enrollment based fees, ancillary, discount, and funds charges when the bill is generated in the post runout period of the policy. In this case, a write-off adjustment is created against the respective bill segment during the post bill completion. The write-off adjustment is created using the post runout write-off adjustment type which is specified in the respective pricing rule type.

To enable this feature, you need to do the following:

- Set the **Eligible for Write-Off in Post Runout** field in the respective pricing rule type to **Yes**.
- Specify the post runout write-off adjustment type in the respective pricing rule type.
- Attach the **C1-PRCRLWOFF** algorithm to the **Post-Bill Completion** system event in the customer class of the accounts for which you want to write-off the charges in the post runout period of the policy.

Level Funding Pricing

Level funding is a type of self-funding. It offers all benefits of traditional self-funding. However, it provides one additional benefit which helps to stabilize monthly costs of the self-funded employer to pay off the claim, ancillary, claim based fee, enrollment based fee, and discount charges.

Oracle Revenue Management and Billing enables you to process and bill the funds charges to the self-funded employer in either of the following ways:

- Pay the fixed flat amount in every bill period
- Pay the amount based on the enrollment based limit in every bill period

The system enables you to define whether the price items included in the claim, retention type claim based, retention type enrollment based, ancillary, and discount pricing rule types are eligible for level funding. If the price items are eligible for level funding, you can then include them in the level funding pricing rule type indicating that the charges for these price items will not be included in the respective billable charge (for example, claim billable charge), but it would be settled against the funds billable charge. While adjusting such charges against the funds billable charge, there might be some surplus or deficit in funds at the time of settlement which is ideally at the end of year. In such case, the

system enables you configure whether a flat amount or percentage of surplus should be retained by the ASO provider or whether a flat amount or percentage of deficit is offered as a discount to the self-funded employer.

The pricing for the level funding can be defined using the level funding pricing rules. You can define a level funding pricing rule at the parent customer and bill group levels. The level funding pricing rule at the bill group level takes precedence over the level funding pricing rule at the parent customer level. You can define the level funding pricing rules for parent customers and bill groups from the **Customer 360° Information** screen. You can define a level funding pricing rule using a level funding pricing rule type. It is the level funding pricing rule type which helps the system to determine:

- Business object using which the level funding pricing rule should be created in the system.

Note: You must not select the **Primary** option while defining a level funding pricing rule type.

- Algorithm which should be triggered for deriving the account and price item while creating the funds transaction legs.

Note: You must create an algorithm using the **C1_ACCPRISL** algorithm type and attach it to the **Account and Price Item Derivation** system event.

- Pricing rule post-processing algorithm which should be triggered once the effective level funding pricing rule is derived.

Note: A pricing rule post-processing algorithm type is not shipped with the product. You can create a custom algorithm type, if required.

- Additional generic information, such as:
 - Whether the funds charge should be written off when the bill is generated in the post runout period of the policy. In this case, a write-off adjustment is created against the respective bill segment during the post bill completion. The write-off adjustment is created using the post runout write-off adjustment type which is specified in the level funding pricing rule type.
 - Transaction field which you want to use in the rules as the output parameter to determine whether the price item should be considered for billing.
 - Value which the output parameter in the rule should return when the price item in the level funding pricing rule type should be considered for processing.
- Price items for which you can define level funding pricing rules using the level funding pricing rule type.
- Rate options that you can use while defining the pricing for the level funded price items.
- Different type of account to which a price item should be billed based on the specified priority.
- Rule type which indicates the rules that should be executed to determine whether the price item is eligible for billing.
- Additional level funding specific information, such as:
 - Whether the level funding premium (i.e. funds) should be calculated using the bill period based recurring flat fee pricing rule or using the retention type enrollment based pricing rule.
 - Bill period based recurring flat fee pricing rule type or retention type enrollment based pricing rule type which you want to use for calculating the level funded premium.
 - Price item whose pricing you want to use for calculating the level-funded premium.
 - LF billable charge line type using which you want to create billable charges for level funded premium.
 - GL only contract type which indicates the contract against which the claim, ancillary, claim based fees, enrollment based fees, and discount charges that are settled against the funds must be debited. The distribution code on the GL only contract type will indicate the GL account against which charges settled against the funds must be debited.

- Liability distribution code will indicate the GL account against which charges settled against the funds must be credited.
- Number of days before which you want to create a To Do for reminding the self-funded employer to renew the level funded agreement.
- Surplus billable charge line type using which you want to create the billable charge when the surplus funds are left with the ASO provider at the time of settlement.
- Deficit billable charge line type using which you want to create the billable charge when the funds are in deficit at the time of settlement.
- Domestic provider billable charge line type using which you want to create billable charges for the claim, claim based fees, enrollment based fees, ancillary, and discount charges which are settled against the funds for a domestic provider.
- Markup or markdown billable charge line type using which you want to create billable charges for markup or markdown which are settled against the funds.
- Rule type which indicates the rules that should be executed to determine whether the markup or markdown calculation line is eligible for billing.
- Transaction field which you want to use in the rules as the output parameter to determine whether the markup or markdown calculation line is eligible for billing.
- Rule type which indicates the rules that should be executed to determine whether the level funded premium is for a domestic provider.
- Transaction field which you want to use in the rules as the output parameter to determine whether the level funded premium is for a domestic provider.

Once a level funding pricing rule type is defined, you can create level funding pricing rules using the level funding pricing rule type. While defining a level funding pricing rule for a parent customer, you need to specify the following:

- Price item for which you want to define the pricing.
- Specific stop-loss pricing rule of the parent customer whose accumulation parameters you want to inherit for the level funding. On selecting a specific stop-loss pricing rule, the level funding pricing date range is set automatically. The level funding pricing date range is same as the specific stop-loss pricing rule.
- Rate option which you want to use while defining the level funding pricing.
- Settlement frequency which helps to determine the bill after date. The valid values are:
 - **Immediately** – If you select this option from the list, the bill after date is not calculated. The funds billable charge is billed immediately in the next bill cycle.
 - **Manually (At Required Intervals)** - If you select this option from the list, the bill after date which is specified in the **Manual Settlement Bill After Date** parameter while executing the **C1-BCLF** batch is stamped on the funds billable charge.
 - **Never** - If you select this option from the list, the bill after date which is specified in the **Manual Settlement Bill After Date** parameter while executing the **C1-BCLF** batch is stamped on the funds billable charge.
 - **Yearly** – If you select this option from the list, the bill after date is set to the pricing end date in the funds billable charge.
 - **On Settlement** - If you select this option from the list, the bill after date is set to the settlement date in the funds billable charge.

Note: The accumulation parameters, such as incurred start date, incurred end date, paid start date, paid end date, and settlement days are automatically inherited from the parent customer's specific stop-loss pricing rule. You cannot change any accumulation parameter except the settlement days.

- Settlement days which helps to calculate the settlement date (which is pricing end date, incurred end date, or paid end date whichever is later + the settlement days)
- Whether the customer would like to renew or cancel the level funded agreement.
- Whether a flat amount or percentage of surplus should be retained by the ASO provider at the time of settlement.
- Whether a flat amount or percentage of deficit should be offered as discount to the self-funded employer at the time of settlement.

However, while defining a level funding pricing rule for a bill group, you need to specify the following:

- The policy status in which the level funding pricing rule is applicable.
- Price item for which you want to define the pricing.
- Parent customer's level funding pricing rule from which you want to inherit the accumulation parameters.

Note:

The pricing date range is derived from the parent customer's level funding pricing rule because the level funding pricing rules for parent customer and bill group should have the same date range.

The settlement fund price item is derived from the level funding pricing rule type using which the level funding pricing rule is created.

- Rate option which you want to use while defining the level funding pricing.
- Price items whose charges should be accumulated against the level funded price items so that it can be settled against the funds.
- Whether the line items and markup or markdown in a particular claim pricing rule should be accumulated.

OR

Whether the line items which are associated with the **Level Funded** pricing rule type category should be accumulated.

- Whether the charges created using the billable charge line types in a particular ancillary pricing rule should be accumulated.

OR

Whether the charges created using the billable charge line types where the **Pricing Rule Type Category** characteristic is set to **Ancillary** should be accumulated.

- Whether the discount calculated using a particular discount arrangement pricing rule should be accumulated.
- Whether the charges calculated using the retention type claim based or retention type enrollment based pricing for a price item should be accumulated.

You can also specify a pricing group while defining a level funding pricing rule for a bill group. Once a level funding pricing rule is defined for a bill group, the system creates a price assignment in a price list and assigns the price list to the bill group.

The following new batches are introduced in this release:

- **C1-ACLF** – This batch is used to accumulate the charges which are to be settled against the funds. During the accumulation post-processing, the level funded billable charges (which are created through the TFM process) are posted against the GL accounts which are derived using the GL only contract type and liability distribution code information in the level funding pricing rule type. For more information about the batch, refer to *Oracle Revenue Management and Billing Batch Guide*.
- **C1-BCLF** – Once the level funded billable charges are accumulated, this batch is used to create the accumulated level funded billable charges. It is also used to calculate the bill after date. For more information about the batch, refer to *Oracle Revenue Management and Billing Batch Guide*.

Defining a Level Funded Pricing Rule Type

Prerequisites

To define a level funded pricing rule type, you should have:

- Level Funded Pricing Rule Type business object defined in the application.
- Level Funded Pricing Rule business object defined in the application.

Procedure

To define a level funded pricing rule type:

1. Click the **Admin** link in the **Application** toolbar.

A list appears.

2. From the **Admin** menu, select **P** and then click **Pricing Rule Type**.

A sub-menu appears.

3. Click the **Add** option from the **Pricing Rule Type** sub-menu.

The **Select Business Object** screen appears. It contains the following field:

Field Name	Field Description	Mandatory (Yes or No)
Pricing Rule Type Business Object	Used to indicate the business object using which you want to create a level funded pricing rule type.	Yes
	Note: You can create a discount arrangement pricing rule type using the Level Funded Pricing Rule Type (C1-PricingRuleTypeDA) business object.	

Tip: Alternatively, you can access this screen by clicking the **Add** button in the **Page Title** area of the **Pricing Rule Type** screen.

4. Select the **Level Funded (LF) Pricing Rule Type** option from the **Pricing Rule Type Business Object** list.
5. Click **OK**.

The **Level Funded Pricing Rule Type** screen appears. It contains the following sections:

- **Main** – Used to specify the basic details about the level funded pricing rule type.
- **Algorithms** – Used to associate the algorithms with a level funded pricing rule type.
- **Additional Data** – Used to specify the additional information about the level funded pricing rule type.
- **Price Items** – Used to add the price items for which you can define the level funded pricing rules using the level funded pricing rule type.
- **Price Item Parameters** – Used to add the price item parameters based on which you want to define the price item pricing.
- **Characteristics** – Used to define the characteristics for a level funded pricing rule type.
- **DA – Specific Additional Data** – Used to define the level funded - specific additional data in a discount arrangement pricing rule type.

The **Main** section contains the following fields:

Field Name	Field Description	Mandatory (Yes or No)
Pricing Rule Type	Used to specify the level funded pricing rule type.	Yes
Description	Used to specify the description for the level funded pricing rule type.	Yes
Detailed Description	Used to specify additional information about the level funded pricing rule type.	No
Pricing Rule Business Object	Used to indicate the business object using which you want to create the level funded pricing rule. The valid value is: <ul style="list-style-type: none"> Level Funded (LF) Pricing Rule 	Yes
Business Object	Indicates the business object using which you are defining the level funded pricing rule type.	Not applicable
Status	Used to indicate the status of the level funded pricing rule type. The valid values are: <ul style="list-style-type: none"> Active Inactive 	Yes
Primary	Used to indicate whether the pricing rule type is a primary pricing rule type.	Not applicable
	Note: You must not select the Primary option while defining a level funded pricing rule type.	
Pricing Rule Type Category	Used to indicate the category to which the pricing rule type belongs. The valid value is: <ul style="list-style-type: none"> Level Funded 	Yes

- Enter the required details in the **Main** section.
- Ensure that **Primary** option is not selected when you are defining a level funded pricing rule type.
- Associate the following algorithms with the discount arrangement pricing rule type:

System Event	Algorithm	Algorithm Type	Description
Account and Price Item Derivation	C1_ACCPRISL	C1_ACCPRISL	Account and Priceitem Derivation For Level Funded
Accumulation Post Processing	C1-LFACPOST	C1-LFACPOST	Level Funded Accumulation Post Processing

- Define additional data for a level funded pricing rule type, if required.
- Add the required price items in the level funded pricing rule type.
- Add the price item parameters in the level funded pricing rule type, if required.
- Define characteristics for a level funded pricing rule type, if required.
- Add level funded-specific additional data in the level funded pricing rule type.
- Click **Save**.

The level funded pricing rule type is defined.

Related Topics

For more information on...	See...
How to associate algorithms with the level funded pricing rule type	Associating an Algorithm with a Level Funded Pricing Rule Type on page 2859
How to define additional data for a level funded pricing rule type	Defining Additional Data in a Level Funded Pricing Rule Type on page 2860
How to add price items in the level funded pricing rule type	Adding a Price Item in a Level Funded Pricing Rule Type on page 2862
How to add price item parameters in the level funded pricing rule type	Adding a Price Item Parameter in a Level Funded Pricing Rule Type on page 2865
How to define a characteristic for a level funded pricing rule type	Defining a Characteristic for a Level Funded Pricing Rule Type on page 2866
How to add level funded - specific data in the discount arrangement pricing rule type	Defining the Level Funded Specific Additional Data in a Level Funded Pricing Rule Type on page 2867

Associating an Algorithm with a Level Funded Pricing Rule Type

Prerequisites

To associate algorithms with a level funding pricing rule type, you should have:

- An algorithm defined using the **C1_ACCPRIDIS** algorithm type.

Procedure

To associate algorithms with a discount arrangement pricing rule type:

1. Ensure that the **Algorithms** section is expanded when you are defining or editing the discount arrangement pricing rule type.

The **Algorithms** section contains the following columns in a grid:

Column Name	Column Description	Mandatory (Yes or No)
System Event	Used to indicate the system event when you want to invoke the algorithm. The valid values are: <ul style="list-style-type: none"> • Account and Price Item Derivation • Accumulation Billable Charge Post Proc • Accumulation Billable Charge Pre Proc • Accumulation Post Processing • Accumulation Pre Processing • Pricing Rule Post Processing • Transaction Validation 	Yes Note: This field is required when you are associating an algorithm with the discount arrangement pricing rule type.

Column Name	Column Description	Mandatory (Yes or No)
Sequence	Used to specify the order in which the algorithms for each system event must be executed.	Yes (Conditional) Note: This field is required when you are associating an algorithm with the discount arrangement pricing rule type.
Algorithm	Used to specify the algorithm. Note: Once you select the system event, the Search (🔍) icon appears corresponding to the Algorithm field. On clicking the Search (🔍) icon, the Algorithm Search window appears. On specifying the algorithm, the description of the algorithm appears corresponding to the Algorithm field.	Yes (Conditional) Note: This field is required when you are associating an algorithm with the discount arrangement pricing rule type.

2. Enter the following details in the **Algorithms** section:

System Event	Sequence	Algorithm
Account and Price Item Derivation	10	C1_ACCPRIDIS

3. If you want to associate more than one algorithm with the discount arrangement pricing rule type, click the **Add** (+) icon and then repeat step 2.

Note: However, if you want to disassociate an algorithm from the discount arrangement pricing rule type, click the **Delete** (🗑️) icon corresponding to the algorithm.

4. Click **Save**.

The algorithms are associated with the discount arrangement pricing rule type.

Related Topics

For more information on...	See...
How to define the discount arrangement pricing rule type	Defining a Discount Arrangement Pricing Rule Type on page 2821
How to edit the discount arrangement pricing rule type	Editing a Discount Arrangement Pricing Rule Type on page 2838

Defining Additional Data in a Level Funded Pricing Rule Type

Procedure

To define additional data in a level funded pricing rule type:

1. Ensure that the **Additional Data** section is expanded when you are defining or editing a level funded pricing rule type.

The **Additional Data** section contains the following fields:

Field Name	Field Description	Mandatory (Yes or No)
Eligible for Specific Stop-Loss	Used to indicate whether price items included in the level funded pricing rule type are eligible for specific stop-loss. The valid values are: <ul style="list-style-type: none"> • Yes • No 	No
Eligible for Level Funding	Used to indicate whether price items included in the level funded pricing rule type are eligible for level funding. The valid values are: <ul style="list-style-type: none"> • Yes • No 	No
Run-in Identifier Value	Used to specify the identifier value to determine whether the level funded transaction is received during the run-in period of the policy.	No
Third Party Identifier Value	Used to specify the identifier value to determine whether the level funded transaction is received from an external source system.	No
Accumulation Only Identifier Value	Used to specify the identifier value to determine whether the level funded transaction contains the accumulated information of ASL, SSL, and Level Funding pricing types.	No
Eligible for Write-Off in Post Runout	Used to indicate whether the level funded charges should be written off when the bill is generated in the post runout period of the policy. The valid values are: <ul style="list-style-type: none"> • Yes • No 	No
	Note: For more information, refer to the Write-Off Charges during Post Runout section.	
Post Runout Write-Off Adjustment Type	Used to specify the adjustment type using which you want to create post runout write-off adjustment.	Yes (Conditional)
	<p>Note:</p> <p>This field appears when the Eligible for Write-Off in Post Runout field is set to Yes.</p> <p>The Search (🔍) icon appears corresponding to the Post Runout Write-Off Adjustment Type field. On clicking the Search icon, the Adjustment Type Search window appears.</p> <p>On specifying the adjustment type, the description of the adjustment type appears corresponding to the Eligible for Write-Off in Post Runout field.</p>	

Field Name	Field Description	Mandatory (Yes or No)
Rule Based Price Item Eligibility Field	<p>Used to indicate the transaction field which you want to use in the rules as the output parameter to determine whether the price item should be considered for billing.</p> <p>Note:</p> <p>For more information, refer to the Price Item Eligibility on page 2950 section.</p> <p>This field appears when the Eligible for Write-Off in Post Runout field is set to Yes.</p> <p>The Search (🔍) icon appears corresponding to the Rule Based Price Item Eligibility Field field. On clicking the Search icon, the Field Search window appears.</p> <p>On specifying the field name, the description of the field name appears corresponding to the Rule Based Price Item Eligibility Field.</p>	No
Rule Based Eligibility Value	Used to specify the value which the output parameter in the rule should return when the price item in the discount arrangement pricing rule type should be considered for processing.	Yes (Conditional)
		Note: This field is required when a value is specified in the Rule Based Price Item Eligibility Field field.

- Enter the required details in the **Additional Data** section.
- Click **Save**.

The additional data is defined for the pricing rule type.

Related Topics

For more information on...	See...
How to define a level funded pricing rule type	Defining a Level Funded Pricing Rule Type on page 2857
How to edit a level funded pricing rule type	Editing a Level Funded Pricing Rule Type on page 2871

Adding a Price Item in a Level Funded Pricing Rule Type

Prerequisites

To add a price item in a level funded pricing rule type, you should have:

- Price item defined in the application
- Rate options defined in the **Rate Option (C1-ExtLookRetTypeRateOpt)** extendable lookup
- Values defined for the **Invoice Type (C1INVTYP)** characteristic type
- The **C1INVTYP** characteristic type set in the **Invoice Type Characteristic Type** option type of the **C1-ASOBLNG** feature configuration

- Rule types defined in the application (where the rule type usage is set to **Price Item Eligibility**)

Procedure

To add a price item in a level funded pricing rule type:

1. Ensure that the **Price Items** section is expanded when you are defining or editing a level funded pricing rule type.

The **Price Items** section contains the following fields in a grid:

Field Name	Field Description	Mandatory (Yes or No)						
Price Item	<p>Used to indicate the price item that you want to include in the level funded pricing rule type.</p> <p>Note:</p> <p>The Search (🔍) icon appears corresponding to the Price Item field. On clicking the Search icon, the Price Item Search window appears.</p> <p>On specifying the price item, the description of the price item appears corresponding to the Price Item field.</p>	<p>Yes (Conditional)</p> <p>Note: This field is required when you are adding a rate option and bill to account in the level funded pricing rule type.</p>						
Rate Option	<p>Used to indicate one or more rate options which are valid for a price item.</p> <p>On clicking the Add (➕) icon, the following field appears in a grid:</p> <table border="1"> <thead> <tr> <th>Field Name</th> <th>Field Description</th> <th>Mandatory (Yes or No)</th> </tr> </thead> <tbody> <tr> <td>Rate Option</td> <td>Used to indicate the rate option that you want to use while defining pricing for the price item.</td> <td>Yes</td> </tr> </tbody> </table> <p>Note:</p> <p>If you want to define more than one rate option to the price item in the level funded pricing rule type, click the Add (➕) icon.</p> <p>However, if you want to remove a price item from a level funded pricing rule type, click the Delete (🗑️) icon corresponding to the Rate Option field.</p>	Field Name	Field Description	Mandatory (Yes or No)	Rate Option	Used to indicate the rate option that you want to use while defining pricing for the price item.	Yes	Not applicable
Field Name	Field Description	Mandatory (Yes or No)						
Rate Option	Used to indicate the rate option that you want to use while defining pricing for the price item.	Yes						

Field Name	Field Description	Mandatory (Yes or No)									
Bill To Account	<p>Used to indicate a order in which the account should be considered while deriving a transaction leg.</p> <p>On clicking the Add (+) icon, the following fields appear in a grid:</p> <table border="1"> <thead> <tr> <th>Field Name</th> <th>Field Description</th> <th>Mandatory (Yes or No)</th> </tr> </thead> <tbody> <tr> <td>Priority</td> <td>Used to specify the order in which the invoice type is considered for a price item.</td> <td>Yes</td> </tr> <tr> <td>Invoice Type</td> <td>Used to indicate the type which is considered for billing. For more information, refer to the Bill Group's Account on page 65 section.</td> <td>Yes</td> </tr> </tbody> </table> <p>Note: The Search (🔍) icon appears corresponding to the Invoice Type field. On clicking the Search icon, the Invoice Type Search window appears.</p>	Field Name	Field Description	Mandatory (Yes or No)	Priority	Used to specify the order in which the invoice type is considered for a price item.	Yes	Invoice Type	Used to indicate the type which is considered for billing. For more information, refer to the Bill Group's Account on page 65 section.	Yes	Not applicable
Field Name	Field Description	Mandatory (Yes or No)									
Priority	Used to specify the order in which the invoice type is considered for a price item.	Yes									
Invoice Type	Used to indicate the type which is considered for billing. For more information, refer to the Bill Group's Account on page 65 section.	Yes									
	<p>Note:</p> <p>If you want to define more than one invoice type to the price item in a level funded pricing rule type, click the Add (+) icon.</p> <p>However, if you want to remove a invoice type from the price item in a level funded pricing rule type, click the Delete (🗑️) icon corresponding to the Priority field.</p>										
Eligibility Rule Type	Used to indicate the rule type which indicates the rules that should be executed to determine whether the price item is eligible for billing.	No									

- Enter the required details in the **Price Items** section.
- If you want to define more than one price item in a level funded pricing rule type, click the **Add** (+) icon and then repeat step 2.

Note: However, if you want to remove a price item from a level funded pricing rule type, click the **Delete** (🗑️) icon corresponding to the **Price Item** field.

- Click **Save**.

The price items are added for a level funded pricing rule type.

Related Topics

For more information on...	See...
How to define a level funded pricing rule type	Defining a Level Funded Pricing Rule Type on page 2857

For more information on...	See...
How to edit a level funded pricing rule type	Editing a Level Funded Pricing Rule Type on page 2871

Adding a Price Item Parameter in a Level Funded Pricing Rule Type

Prerequisites

To add a price item parameter in a level funded pricing rule type, you should have:

- Parameter defined in the application where parameter usage is set to **Price Item**.
- Parameter associated with the price item.
- Transaction fields defined in the application.

Procedure

To add a price item parameter in a level funded pricing rule type:

1. Ensure that the **Price Item Parameters** section is expanded when you are defining or editing a level funded pricing rule type.

The **Price Item Parameters** section contains the following fields in a grid:

Field Name	Field Description	Mandatory (Yes or No)
Price Item Parameter	<p>Used to specify the parameter which you can use while defining a level funded pricing for the price item.</p> <p>Note:</p> <p>The Search (🔍) icon appears corresponding to the Price Item Parameter field. On clicking the Search (🔍) icon corresponding to the Price Item Parameter field, the Parameter Search window appears.</p> <p>On specifying the parameter, the description of the price item parameter appears corresponding to the Price Item Parameter field.</p>	<p>Yes (Conditional)</p> <p>Note: This field is required when you are adding a price item parameter in a level funded pricing rule type.</p>
Transaction Field	<p>Used to specify the transaction field from where the data should be retrieved.</p> <p>Note:</p> <p>The Search (🔍) icon appears corresponding to the Transaction Field field. On clicking the Search (🔍) icon corresponding to the Transaction Field field, the Transaction Field Search window appears.</p> <p>On specifying the transaction field, the description of the transaction field appears corresponding to the Transaction Field.</p>	<p>Yes (Conditional)</p> <p>Note: This field is required when you are adding a price item parameter in a level funded pricing rule type.</p>
Eligible for Specific Stop-Loss	Used to indicate whether the price item parameter can be used while defining the accumulation criteria in the specific stop-loss or aggregate stop-loss pricing rule.	No

Field Name	Field Description	Mandatory (Yes or No)
Eligible for Level Funding	Used to specify whether the price item parameter can be used in level funding.	No

- Enter the required details in the **Price Item Parameters** section.
- If you want to add more than one price item parameter in a level funded pricing rule type, click the **Add (+)** icon and then repeat step 2.

Note: However, if you want to remove a price item parameter from a level funded pricing rule type, click the **Delete (🗑)** icon corresponding to the price item parameter.

- Click **Save**.

The price item parameter is added for a level funded pricing rule type.

Related Topics

For more information on...	See...
How to define a level funded pricing rule type	Defining a Level Funded Pricing Rule Type on page 2857
How to edit a level funded pricing rule type	Editing a Level Funded Pricing Rule Type on page 2871

Defining a Characteristic for a Level Funded Pricing Rule Type

Prerequisites

To define a characteristic for a level funded pricing rule type, you should have:

- Characteristic types defined in the application (where the characteristic entity is set to **Pricing Rule Type**)

Procedure

To define a characteristic for a level funded pricing rule type:

- Ensure that the **Characteristics** section is expanded when you are defining or editing a discount arrangement pricing rule type.

The **Characteristics** section contains the following columns in a grid:

Field Name	Field Description	Mandatory (Yes or No)
Characteristic Type	Used to indicate the characteristic type.	Yes (Conditional)
	Note: The list includes only those characteristic types where the characteristic entity is set to Pricing Rule Type .	Note: This field is required when you are defining a characteristic for a level funded pricing rule type.
Characteristic Value	Used to specify the value for the characteristic type.	Yes (Conditional)
	Note: On specifying the value for a predefined characteristic type, the description of the characteristic value appears corresponding to the Characteristic Value field.	Note: This field is required when you are defining a characteristic for a level funded pricing rule type.

- Enter the required details in the **Characteristics** section.

Note: If you select a predefined characteristic type, the **Search** (🔍) icon appears corresponding to the **Characteristic Value** field. On clicking the **Search** icon, you can search for a predefined characteristic value.

- If you want to define more than one characteristic for a level funded pricing rule type, click the **Add** (+) icon and then repeat step 2.

Note: However, if you want to remove a characteristic from a level funded pricing rule type, click the **Delete** (🗑️) icon corresponding to the characteristic.

- Click **Save**.

The characteristics are defined for a level funded pricing rule type.

Related Topics

For more information on...	See...
How to define a level funded pricing rule type	Defining a Level Funded Pricing Rule Type on page 2857
How to edit a level funded pricing rule type	Editing a Level Funded Pricing Rule Type on page 2871

Defining the Level Funded Specific Additional Data in a Level Funded Pricing Rule Type

Prerequisites

To define level funded specific additional data in a level funded pricing rule type, you should have:

- A rule type defined for **Markup or Markdown Eligibility Rule Type** and **Domestic Provider Eligibility Rule Type** field.

Procedure

To add the level-funded data in a level funded pricing rule type:

- Ensure that the **Level Funded - Specific Additional Data** section is expanded when you are defining or editing a level funded pricing rule type.

The **Level Funded - Specific Additional Data** section contains the following fields:

Field Name	Field Description	Mandatory (Yes or No)
Funding Arrangement	Used to indicate whether the level-funded premium (i.e. funds) should be calculated using the bill period based recurring flat fee pricing rule or using the retention type enrollment based pricing rule. The valid values are: <ul style="list-style-type: none"> Enrollment Based Premium Flat Rate Based Premium 	Yes

Field Name	Field Description	Mandatory (Yes or No)
Settlement Fund Pricing Rule Type	<p>Used to indicate the bill period based recurring flat fee pricing rule type or the retention type enrollment based pricing rule type which you want to use for calculating the level-funded premium.</p> <p>Note:</p> <p>The Search (🔍) icon appears corresponding to the Settlement Fund Pricing Rule Type field. On clicking the Search (🔍) icon corresponding to the Settlement Fund Pricing Rule Type field, the Contract Type Search window appears.</p> <p>On specifying the contract type, the description of the contact type appears corresponding to the Settlement Fund Pricing Rule Type field.</p>	Yes
Settlement Fund Price Item	<p>Used to indicate the price item that you want to use for calculating the level-funded premium.</p> <p>Note:</p> <p>The Search (🔍) icon appears corresponding to the Settlement Fund Price Item field. On clicking the Search (🔍) icon corresponding to the Settlement Fund Price Item field, the Price Item Details window appears.</p> <p>On specifying the price item details, the description of the price item details appears corresponding to the Settlement Fund Price Item field.</p>	Yes
LF Billable Charge Line Type	<p>Used to indicate the level funded billable charge line type using which you want to create the billable charges for level-funded settlement purposes.</p> <p>Note:</p> <p>The Search (🔍) icon appears corresponding to the LF Billable Charge Line Type field. On clicking the Search (🔍) icon corresponding to the LF Billable Charge Line Type field, the Billable Charge Line Type Search window appears.</p> <p>On specifying the billable charge line type, the description of the billable charge line type appears corresponding to the Billable Charge Line Type Search field.</p>	Yes

Field Name	Field Description	Mandatory (Yes or No)
GL Only Contract Type	<p>Used to indicate the contract against which the level-funded billable charges for claim, ancillary, claim based fees, enrollment based fees, discount, specific stop-loss, and aggregate stop-loss must be debited.</p> <p>Note:</p> <p>The Search (🔍) icon appears corresponding to the GL Only Contract Type field. On clicking the Search (🔍) icon corresponding to the GL Only Contract Type field, the Contract Type Search window appears.</p>	Yes
Liability Distribution Code	<p>Used to indicate the GL account against which the level-funded billable charges (that are settled against the level-funded premium billable charge) must be credited.</p> <p>Note:</p> <p>The Search (🔍) icon appears corresponding to the Liability Distribution Code field. On clicking the Search (🔍) icon corresponding to the Liability Distribution Code field, the Distribution Code Search window appears.</p> <p>On specifying the distribution code, the description of the distribution code appears corresponding to the Liability Distribution Code field.</p>	Yes
Renewal Decision Lead Time	Used to specify the number of days before which you want to create a To Do for reminding the self-funded employer to renew the level-funded agreement.	Yes
Surplus Billable Charge Line Type	<p>Used to indicate the surplus billable charge line type using which you want to create the billable charge when the surplus funds are left with the ASO provider at the time of settlement.</p> <p>Note:</p> <p>The Search (🔍) icon appears corresponding to the Surplus Billable Charge Line Type field. On clicking the Search (🔍) icon corresponding to the Surplus Billable Charge Line Type field, the Billable Charge Line Type Search window appears.</p> <p>On specifying the billable charge line type, the description of the billable charge line type appears corresponding to the Surplus Billable Charge Line Type field.</p>	Yes

Field Name	Field Description	Mandatory (Yes or No)
Deficit Billable Charge Line Type	<p>Used to indicate the deficit billable charge line type using which you want to create the billable charge when the funds are in deficit at the time of settlement.</p> <p>Note:</p> <p>The Search (🔍) icon appears corresponding to the Deficit Billable Charge Line Type field. On clicking the Search (🔍) icon corresponding to the Deficit Billable Charge Line Type field, the Billable Charge Line Type Search window appears.</p> <p>On specifying the billable charge line type, the description of the billable charge line type appears corresponding to the Deficit Billable Charge Line Type field.</p>	Yes
Domestic Provider Billable Charge Line Type	<p>Used to indicate the domestic provider billable charge line type using which you want to create level-funded settlement billable charge for a domestic provider.</p> <p>Note:</p> <p>The Search (🔍) icon appears corresponding to the Domestic Provider Billable Charge Line Type field. On clicking the Search (🔍) icon corresponding to the Domestic Provider Billable Charge Line Type field, the Billable Charge Line Type Search window appears.</p> <p>On specifying the billable charge line type, the description of the billable charge line type appears corresponding to the Domestic Provider Billable Charge Line Type field.</p>	No
Markup or Markdown Billable Charge Line Type	<p>Used to indicate the markup or markdown billable charge line type using which you want to create the billable charges for markup or markdown which are settled against the level-funded premium.</p> <p>Note:</p> <p>The Search (🔍) icon appears corresponding to the Markup or Markdown Billable Charge Line Type field. On clicking the Search (🔍) icon corresponding to the Markup or Markdown Billable Charge Line Type field, the Billable Charge Line Type Search window appears.</p> <p>On specifying the billable charge line type, the description of the billable charge line type appears corresponding to the Markup or Markdown Billable Charge Line Type field.</p>	No
Markup or Markdown Eligibility Rule Type	Used to indicate the rules that should be executed to determine whether the markup or markdown calculation line is eligible for billing.	No

Field Name	Field Description	Mandatory (Yes or No)
Rule Based Markup or Markdown Eligibility Field	Used to indicate the transaction field which you want to use in the rules as the output parameter to determine whether the markup or markdown calculation line is eligible for billing.	Yes (Conditional) Note: This field is required when you are specifying a markup or markdown eligibility rule type in a level funded pricing rule type.
	<p>Note:</p> <p>The Search (🔍) icon appears corresponding to the Rule Based Markup or Markdown Eligibility Field field. On clicking the Search (🔍) icon corresponding to the Rule Based Markup or Markdown Eligibility Field Type field, the Field Search window appears.</p> <p>On specifying the eligibility field, the description of the field appears corresponding to the Rule Based Markup or Markdown Eligibility Field field.</p>	
Domestic Provider Eligibility Rule Type	Used to indicate the rules that should be executed to determine whether the level-funded premium is for a domestic provider.	No
Rule Based Domestic Provider Claim Eligibility Field	Used to indicate the transaction field which you want to use in the rules as the output parameter to determine whether the level-funded premium is for a domestic provider.	Yes (Conditional) Note: This field is required when you are specifying a domestic provider eligibility rule type in a level funded pricing rule type.
	<p>Note:</p> <p>The Search (🔍) icon appears corresponding to the Rule Based Domestic Provider Claim Eligibility Field field. On clicking the Search (🔍) icon corresponding to the Rule Based Domestic Provider Claim Eligibility Field field, the Field Search window appears.</p> <p>On specifying the eligibility field, the description of the field appears corresponding to the Rule Based Domestic Provider Claim Eligibility Field field.</p>	

2. Enter the required details in the **Level Funded - Specific Additional Data** section.
3. Click **Save**.

The level funded-specific data is added in the level funded pricing rule type.

Related Topics

For more information on...	See...
How to define a level funded pricing rule type	Defining a Level Funded Pricing Rule Type on page 2857
How to edit a level funded pricing rule type	Editing a Level Funded Pricing Rule Type on page 2871

Editing a Level Funded Pricing Rule Type

Prerequisites

To edit a level funded pricing rule type, you should have:

- Level funded pricing rule type business object defined in the application.
- Level funded pricing rule business object defined in the application.

Procedure

To edit a level funded pricing rule type:

1. Click the **Admin** link in the **Application** toolbar.
A list appears.
2. From the **Admin** menu, select **P** and then click **Pricing Rule Type**.
A sub-menu appears.
3. Click the **Search** option from the **Pricing Rule Type** sub-menu.
The **Pricing Rule Type** screen appears.
4. In the **Pricing Rule Type List** zone, click the **Edit**  icon in the **Edit** column corresponding to the pricing rule type whose details you want to edit.

The **Level Funded Pricing Rule Type** screen appears. It contains the following sections:

- **Main** – Used to specify basic details about the discount arrangement pricing rule type.
- **Algorithms** – Used to associate the algorithms with a discount arrangement pricing rule type.
- **Additional Data** – Used to specify the additional information about the discount arrangement pricing rule type.
- **Price Items** – Used to add the price items for which you can define the discount arrangement pricing rules using the discount arrangement pricing rule type.
- **Price Item Parameters** – Used to add the price item parameters based on which you want to define the price item pricing.
- **Characteristics** – Used to define the characteristics for a discount arrangement pricing rule type.
- **Level Funded - Specific Additional Data** – Used to define the discount arrangement - specific additional data in a discount arrangement pricing rule type.

The **Main** section contains the following fields:

Field Name	Field Description	Mandatory (Yes or No)
Pricing Rule Type	Displays the level funded pricing rule type.	Not applicable
Description	Used to specify the description for the level funded pricing rule type.	Yes
Detailed Description	Used to specify additional information about the level funded pricing rule type.	No
Pricing Rule Business Object	Used to indicate the business object using which you want to create the level funded pricing rule. The valid value is: <ul style="list-style-type: none"> • Level Funded (LF) Pricing Rule 	Yes
Business Object	Indicates the business object used while defining the level funded pricing rule type.	Not applicable

Field Name	Field Description	Mandatory (Yes or No)
Status	Used to indicate the status of the level funded pricing rule type. The valid values are: <ul style="list-style-type: none"> Active Inactive 	Yes
Primary	Used to indicate whether the pricing rule type is primary.	Not applicable
	Note: You must not select the Primary option while defining the level funded pricing rule type.	
Pricing Rule Type Category	Indicates the pricing rule type category for the level funded pricing rule type. The valid values are: <ul style="list-style-type: none"> Level Funded 	No

Tip: Alternatively, you can edit the details of a level funded pricing rule type by clicking the **Edit** button in the **Pricing Rule Type** zone.

- Modify the details in the **Main** section.
- Associate the following algorithms with the level funded pricing rule type:

System Event	Algorithm	Algorithm Type	Description
Account and Price Item Derivation	C1_ACCPRIS	C1_ACCPRID	Account and Priceitem Derivation For Level Funded
Accumulation Post Processing	C1-LFACPOST	C1-LFACPOST	Level Funded Accumulation Post Processing

- Modify the additional data for a level funded pricing rule type, if required.
- Add, edit, or remove the required price items in the level funded pricing rule type.
- Add, edit, or remove the price item parameters in the level funded pricing rule type, if required.
- Add, edit, or remove characteristics for a level funded pricing rule type, if required.
- Modify the level funded-specific additional data in the level funded pricing rule type, if required.
- Click **Save**.

The changes made to the level funded pricing rule type are saved.

Related Topics

For more information on...	See...
How to associate algorithms with the level funded pricing rule type	Associating an Algorithm with a Level Funded Pricing Rule Type on page 2859
How to define additional data for a level funded pricing rule type	Defining Additional Data in a Level Funded Pricing Rule Type on page 2860
How to add price items in the level funded pricing rule type	Adding a Price Item in a Level Funded Pricing Rule Type on page 2862

For more information on...	See...
How to add price item parameters in the level funded pricing rule type	Adding a Price Item Parameter in a Level Funded Pricing Rule Type on page 2865
How to define a characteristic for a level funded pricing rule type	Defining a Characteristic for a Level Funded Pricing Rule Type on page 2866
How to define level funded-specific data in the level funded pricing rule type	Defining the Level Funded Specific Additional Data in a Level Funded Pricing Rule Type on page 2867

Deleting a Level Funded Pricing Rule Type

Procedure

To delete a level funded pricing rule type:

1. Click the **Admin** link in the **Application** toolbar.
A list appears.
2. From the **Admin** menu, select **P** and then click **Pricing Rule Type**.
A sub-menu appears.
3. Click the **Search** option from the **Pricing Rule Type** sub-menu.
The **Pricing Rule Type** screen appears.
4. In the **Pricing Rule Type List** zone, click the **Delete** (🗑️) icon in the **Delete** column corresponding to the level funded pricing rule type that you want to delete.
A message appears confirming whether you want to delete the level funded pricing rule type.

Note: You can delete a level funded pricing rule type when it is not yet used in the system.

Tip: Alternatively, you can delete a level funded pricing rule type by clicking the **Delete** button in the **Pricing Rule Type** zone.

5. Click **OK**.
The level funded pricing rule type is deleted.

Related Topics

For more information on...	See...
Pricing Rule Type screen	Pricing Rule Type on page 2532
Pricing Rule Type List zone	Pricing Rule Type List on page 2533
Pricing Rule Type zone	Pricing Rule Type on page 2536

Viewing the Level Funded Pricing Rule Type Details

Procedure

To view the details of a level funded pricing rule type:

1. Click the **Admin** link in the **Application** toolbar.
A list appears.
2. From the **Admin** menu, select **P** and then click **Pricing Rule Type**.
A sub-menu appears.

3. Click the **Search** option from the **Pricing Rule Type** sub-menu.
The **Pricing Rule Type** screen appears.
4. In the **Pricing Rule Type List** zone, click the **Broadcast** () icon corresponding to the level funded pricing rule type whose details you want to view.
The **Pricing Rule Type** zone appears.
5. View the details of the level funded pricing rule type in the **Pricing Rule Type** zone.

Related Topics

For more information on...	See...
Pricing Rule Type screen	Pricing Rule Type on page 2532
Pricing Rule Type List zone	Pricing Rule Type List on page 2533
Pricing Rule Type zone	Pricing Rule Type on page 2536

Defining a Level Funded Pricing Rule for a Parent Customer

Prerequisites

To define a level funded pricing rule for a parent customer, you should have:

- Pricing rule type where the category is set to **Level Funded**.
- Price items associated with the level funded pricing rule type.
- Specific stop-loss pricing rule of the parent customer, whose accumulation parameters you want to inherit for level funding.

Procedure

To define a level funded pricing rule for a parent customer:

1. Search for a parent customer in the **Customer 360° View** screen.
2. In the **Search Results** section, click the **View** () icon corresponding to the parent customer whose pricing details you want to view.
The **Person** tab appears in the **Customer 360° Information** screen.
3. Click the **Pricing** tab.
The **Pricing** tab appears.
4. Click the **Add** link in the upper-right corner of the **Parent Customer Pricing Rules** zone.
The **Pricing Rule** screen appears. It contains the following fields:

Field Name	Field Description	Mandatory (Yes or No)
Person Name	Indicates the parent customer for whom you want to create a level funded pricing rule type.	Not applicable
Person Type	Indicates the type of the parent customer. The valid value is: <ul style="list-style-type: none"> • Parent Customer 	Not applicable
Pricing Rule Type	Used to indicate the pricing rule type using which you want to create a level funded pricing rule.	Yes

5. Select the required pricing rule type in the respective field.
6. Click **OK**.

The **Level Funded (LF) Pricing Rule** screen appears. It contains the following sections:

- **Customer Information** – Displays the information about the parent customer for whom you are defining the level funded pricing rule. It contains the following fields:

Field Name	Field Description
Parent Customer Information	Indicates the parent customer for whom you are defining the level funded pricing rule.
Pricing Rule Type	Indicates the pricing rule type using which you are defining the level funded pricing rule.

- **Main** – Used to specify basic details in the level funding pricing rule.
- **Accumulation Parameters** – Used to define the accumulation parameters in a level funded pricing rule.
- **Final Settlement Rules** – Used to define the final settlement rules when the customer decides to renew or cancel the level-funded agreement.
- **Characteristics** – Used to define the characteristics for the level funded pricing rule.

Note:

The **Accumulation Parameters** and **Final Settlement Rules** section appear when you specify a price item in the **Main** section.

The **Main** section contains the following fields:

Field Name	Field Description	Mandatory (Yes or No)
Price Item	Used to indicate the price item for which you want to define the level funded pricing rule.	Yes
Parent Customer's Pricing Rule	Used to indicate the date range of each specific stop-loss pricing rule, defined for the parent customer. Note: On selecting the specific stop-loss pricing rule of the parent customer, the level funded Pricing Start Date and Pricing End Date field is set automatically.	Yes
Pricing Start Date	Used to specify the date from when the level funded pricing rule is effective. Note: The pricing start date cannot be later than the pricing end date.	Yes
Pricing End Date	Used to specify the date till when the level funded pricing rule is effective. Note: The pricing end date cannot be earlier than the pricing start date.	No
Rate Option	Used to indicate the rate option that you want to use while defining the pricing for the price item.	Yes

Field Name	Field Description	Mandatory (Yes or No)
Settlement Frequency	Used to indicate the settlement frequency which helps to determine the bill after date. The valid values are: <ul style="list-style-type: none"> • Immediately - If you select this option from the list, the bill after date is not calculated. The level-funded settlement billable charge is billed immediately in the next bill cycle. • Manually (At Regular Intervals) - If you select this option from the list, the bill after date which is specified in the Manual Settlement Bill After Date parameter while executing the C1-BCLF batch is stamped on the level-funded settlement billable charge. • Monthly - If you select this option from the list, the bill after date is set to the last day of the month. • On Settlement - If you select this option from the list, the bill after date is set to the settlement date in the level-funded settlement billable charge. • Yearly - If you select this option from the list, the bill after date in the credit billable charge is set to the pricing end date in the level-funded settlement billable charge. 	Yes
Underwriter Review	Used to indicate whether the underwriter settlement review flag is on or off. The valid values are: <ul style="list-style-type: none"> • Yes • No <p>Note: By default the value of this option type is set to Yes.</p>	No

7. Enter the required details in the **Main** section.
8. Define the accumulation parameters in the level funded pricing rule.
9. Define the final settlement rules in the level funded pricing rule.
10. Define characteristics for the level funded pricing rule, if required.
11. Click **Save**.

The level funded pricing rule is defined for the parent customer.

Related Topics

For more information on...	See...
How to search for a parent customer	Searching for a Person on page 648
Parent Customer Pricing Rules zone	Parent Customer Pricing Rules on page 696
How to define the accumulation parameters in a level funded pricing rule	Defining Accumulation Parameters in a Level Funded Pricing Rule on page 2878
How to define the final settlement rules in a level funded pricing rule	Defining the Final Settlement Rules in a Level Funded Pricing Rule on page 2879

For more information on...	See...
How to define the characteristics for a level funded pricing rule	Defining a Characteristic for a Level Funded Pricing Rule on page 2884

Defining Accumulation Parameters in a Level Funded Pricing Rule

Procedure

To define accumulation parameters in a level funding pricing rule:

1. Ensure that the **Accumulation Parameters** section is expanded when you have selected an option from the **Price Item** field of the **Main** section while defining a level funded pricing rule.

The **Accumulation Parameters** section contains the following fields:

Field Name	Field Description	Mandatory (Yes or No)
Accumulation Group ID	Displays a blank field. An accumulation group ID is generated when accumulation parameter values are defined for a level funded pricing rule.	Not applicable
	Note: It is a read-only field.	
Settlement Account ID	Used to indicate the account ID to whom the settlement amount is credited.	Yes
Incurred Start Date	Displays the incurred start date (inherited from parent customer's specific stop-loss pricing rule) based on which you want to accumulate the level funded pricing.	Not applicable
	Note: It is a read-only field.	
Incurred End Date	Displays the incurred end date (inherited from parent customer's specific stop-loss pricing rule) based on which you want to accumulate the level funded pricing.	Not applicable
	Note: It is a read-only field.	
Paid Start Date	Displays the paid start date (inherited from parent customer's specific stop-loss pricing rule) based on which you want to accumulate the level funded pricing.	Not applicable
	Note: It is a read-only field.	
Paid End Date	Displays the paid end date (inherited from parent customer's specific stop-loss pricing rule) based on which you want to accumulate the level funded pricing.	Not applicable
	Note: It is a read-only field.	

Field Name	Field Description	Mandatory (Yes or No)
Settlement Days	Used to indicate the number of days as the settlement days which help in calculating the settlement date. The valid values are: <ul style="list-style-type: none"> • 30 Days • 60 Days • 90 Days • 120 Days • 150 Days • 180 Days 	Not applicable
	Note: Settlement date is calculated as the pricing end date, incurred end date, or paid end date whichever is later plus the settlement days.	

2. Enter the required details in the **Accumulation Parameters** section.
3. Click **Save**.

The accumulation parameters are defined in the level funded pricing rule.

Related Topics

For more information on...	See...
How to define a level funded pricing rule for a parent customer	Defining a Level Funded Pricing Rule for a Parent Customer on page 2875
How to edit a level funded pricing rule of a parent customer	Editing a Level Funded Pricing Rule of a Parent Customer

Defining the Final Settlement Rules in a Level Funded Pricing Rule

Procedure

To define the final settlement rules in a level funded pricing rule:

1. Ensure that the **Final Settlement Rules** section is expanded when you are defining or editing a level funded pricing rule type.

The **Final Settlement Rules** section contains the following sub-sections:

- **Customer Renews** - Used to define the final settlement rules when the customer renews the contract.
- **Customer Cancels** - Used to define the final settlement rules when the customer cancels the contract.
- **Renewal Decision** - Used to indicate the status for the upcoming level funded contract.

The **Customer Renews** sub-section contains the following fields:

Field Name	Field Description	Mandatory (Yes or No)									
Final Settlement Mode	Displays the final settlement mode when the customer renews the level funded agreement. The valid values are: <ul style="list-style-type: none"> Final Settlement Surplus Final Settlement Deficit 	Not applicable									
Final Settlement Option	Used to indicate the final settlement option when the customer renews the level funded agreement. <table border="1" data-bbox="483 512 1260 823"> <thead> <tr> <th>Field Name</th> <th>Field Description</th> <th>Mandatory (Yes or No)</th> </tr> </thead> <tbody> <tr> <td>Final Settlement Surplus</td> <td>Used to indicate the final settlement option in case of surplus.</td> <td>Yes</td> </tr> <tr> <td>Final Settlement Deficit</td> <td>Used to indicate the final settlement option in case of deficit.</td> <td>Yes</td> </tr> </tbody> </table>	Field Name	Field Description	Mandatory (Yes or No)	Final Settlement Surplus	Used to indicate the final settlement option in case of surplus.	Yes	Final Settlement Deficit	Used to indicate the final settlement option in case of deficit.	Yes	Not applicable
Field Name	Field Description	Mandatory (Yes or No)									
Final Settlement Surplus	Used to indicate the final settlement option in case of surplus.	Yes									
Final Settlement Deficit	Used to indicate the final settlement option in case of deficit.	Yes									
Flat/ Percentage	Used to indicate the final settlement payment type when the customer renews the level funded agreement. <table border="1" data-bbox="483 940 1260 1461"> <thead> <tr> <th>Field Name</th> <th>Field Description</th> <th>Mandatory (Yes or No)</th> </tr> </thead> <tbody> <tr> <td>Final Settlement Surplus</td> <td>Used to indicate the payment type in case of surplus. The valid values are: <ul style="list-style-type: none"> Flat Dollar Percentage </td> <td>Yes</td> </tr> <tr> <td>Final Settlement Deficit</td> <td>Used to indicate the payment type in case of deficit. The valid values are: <ul style="list-style-type: none"> Flat Dollar Percentage </td> <td>Yes</td> </tr> </tbody> </table>	Field Name	Field Description	Mandatory (Yes or No)	Final Settlement Surplus	Used to indicate the payment type in case of surplus. The valid values are: <ul style="list-style-type: none"> Flat Dollar Percentage 	Yes	Final Settlement Deficit	Used to indicate the payment type in case of deficit. The valid values are: <ul style="list-style-type: none"> Flat Dollar Percentage 	Yes	Not applicable
Field Name	Field Description	Mandatory (Yes or No)									
Final Settlement Surplus	Used to indicate the payment type in case of surplus. The valid values are: <ul style="list-style-type: none"> Flat Dollar Percentage 	Yes									
Final Settlement Deficit	Used to indicate the payment type in case of deficit. The valid values are: <ul style="list-style-type: none"> Flat Dollar Percentage 	Yes									

Field Name	Field Description	Mandatory (Yes or No)			
Percentage Retained	Used to specify the percentage retained by the ASO provider when the customer renews the level funded agreement.	Not applicable			
	<table border="1"> <thead> <tr> <th data-bbox="475 329 683 407">Field Name</th> <th data-bbox="683 329 1057 407">Field Description</th> <th data-bbox="1057 329 1260 407">Mandatory (Yes or No)</th> </tr> </thead> </table>		Field Name	Field Description	Mandatory (Yes or No)
	Field Name		Field Description	Mandatory (Yes or No)	
	Final Settlement Surplus		Used to specify the percentage of surplus that should be retained by the ASO provider. <div data-bbox="691 533 1049 646" style="border: 1px solid black; padding: 2px;"> Note: This field appears when the Flat/Percentage field is Percentage. </div>	Yes (Conditional)	
Final Settlement Deficit	Used to specify the percentage of deficit that should be offered as a discount by the ASO provider. <div data-bbox="691 827 1049 940" style="border: 1px solid black; padding: 2px;"> Note: This field appears when the Flat/Percentage field is Percentage. </div>	Yes (Conditional)			
Flat Effective Payout	Used to specify the actual amount which should be retained by the ASO provider or offered as a discount, when the customer renews the level funded agreement.	Not applicable			
	<table border="1"> <thead> <tr> <th data-bbox="475 1100 683 1178">Field Name</th> <th data-bbox="683 1100 1057 1178">Field Description</th> <th data-bbox="1057 1100 1260 1178">Mandatory (Yes or No)</th> </tr> </thead> </table>		Field Name	Field Description	Mandatory (Yes or No)
	Field Name		Field Description	Mandatory (Yes or No)	
	Final Settlement Surplus		Used to specify the actual amount of surplus that should be retained by the ASO provider. <div data-bbox="691 1308 1049 1421" style="border: 1px solid black; padding: 2px;"> Note: This field appears when the Flat/Percentage field is Flat Dollar. </div>	Yes (Conditional)	
Final Settlement Deficit	Used to specify the actual amount of deficit that should be offered as a discount by the ASO provider. <div data-bbox="691 1602 1049 1715" style="border: 1px solid black; padding: 2px;"> Note: This field appears when the Flat/Percentage field is Flat Dollar. </div>	Yes (Conditional)			

The **Customer Cancels** sub-section contains the following fields:

Field Name	Field Description	Mandatory (Yes or No)									
Final Settlement Mode	Displays final settlement mode when the customer cancels the level funded agreement. The valid values are: <ul style="list-style-type: none"> Final Settlement Surplus Final Settlement Deficit 	Not applicable									
Final Settlement Option	Used to indicate the final settlement option when the customer cancels the level funded agreement. <table border="1" data-bbox="483 512 1260 823"> <thead> <tr> <th>Field Name</th> <th>Field Description</th> <th>Mandatory (Yes or No)</th> </tr> </thead> <tbody> <tr> <td>Final Settlement Surplus</td> <td>Used to indicate the final settlement option in case of surplus.</td> <td>Yes</td> </tr> <tr> <td>Final Settlement Deficit</td> <td>Used to indicate the final settlement option in case of deficit.</td> <td>Yes</td> </tr> </tbody> </table>	Field Name	Field Description	Mandatory (Yes or No)	Final Settlement Surplus	Used to indicate the final settlement option in case of surplus.	Yes	Final Settlement Deficit	Used to indicate the final settlement option in case of deficit.	Yes	Not applicable
Field Name	Field Description	Mandatory (Yes or No)									
Final Settlement Surplus	Used to indicate the final settlement option in case of surplus.	Yes									
Final Settlement Deficit	Used to indicate the final settlement option in case of deficit.	Yes									
Flat/ Percentage	Used to indicate the final settlement payment type when the customer cancels the level funded agreement. <table border="1" data-bbox="483 940 1260 1457"> <thead> <tr> <th>Field Name</th> <th>Field Description</th> <th>Mandatory (Yes or No)</th> </tr> </thead> <tbody> <tr> <td>Final Settlement Surplus</td> <td>Used to indicate the payment type in case of surplus. The valid values are: <ul style="list-style-type: none"> Flat Dollar Percentage </td> <td>Yes</td> </tr> <tr> <td>Final Settlement Deficit</td> <td>Used to indicate the payment type in case of deficit. The valid values are: <ul style="list-style-type: none"> Flat Dollar Percentage </td> <td>Yes</td> </tr> </tbody> </table>	Field Name	Field Description	Mandatory (Yes or No)	Final Settlement Surplus	Used to indicate the payment type in case of surplus. The valid values are: <ul style="list-style-type: none"> Flat Dollar Percentage 	Yes	Final Settlement Deficit	Used to indicate the payment type in case of deficit. The valid values are: <ul style="list-style-type: none"> Flat Dollar Percentage 	Yes	Not applicable
Field Name	Field Description	Mandatory (Yes or No)									
Final Settlement Surplus	Used to indicate the payment type in case of surplus. The valid values are: <ul style="list-style-type: none"> Flat Dollar Percentage 	Yes									
Final Settlement Deficit	Used to indicate the payment type in case of deficit. The valid values are: <ul style="list-style-type: none"> Flat Dollar Percentage 	Yes									

Field Name	Field Description	Mandatory (Yes or No)									
Percentage Retained	Used to specify the percentage retained by the ASO provider when the customer cancels the level funded agreement.	Not applicable									
	<table border="1"> <thead> <tr> <th data-bbox="475 323 678 407">Field Name</th> <th data-bbox="678 323 1052 407">Field Description</th> <th data-bbox="1052 323 1260 407">Mandatory (Yes or No)</th> </tr> </thead> <tbody> <tr> <td data-bbox="475 407 678 663">Final Settlement Surplus</td> <td data-bbox="678 407 1052 663">Used to specify the percentage of surplus that should be retained by the ASO provider. Note: This field appears when the Flat/Percentage field is Percentage.</td> <td data-bbox="1052 407 1260 663">Yes</td> </tr> <tr> <td data-bbox="475 663 678 947">Final Settlement Deficit</td> <td data-bbox="678 663 1052 947">Used to specify the percentage of deficit that should be offered as a discount by the ASO provider. Note: This field appears when the Flat/Percentage field is Percentage.</td> <td data-bbox="1052 663 1260 947">Yes</td> </tr> </tbody> </table>		Field Name	Field Description	Mandatory (Yes or No)	Final Settlement Surplus	Used to specify the percentage of surplus that should be retained by the ASO provider. Note: This field appears when the Flat/Percentage field is Percentage .	Yes	Final Settlement Deficit	Used to specify the percentage of deficit that should be offered as a discount by the ASO provider. Note: This field appears when the Flat/Percentage field is Percentage .	Yes
	Field Name		Field Description	Mandatory (Yes or No)							
	Final Settlement Surplus		Used to specify the percentage of surplus that should be retained by the ASO provider. Note: This field appears when the Flat/Percentage field is Percentage .	Yes							
Final Settlement Deficit	Used to specify the percentage of deficit that should be offered as a discount by the ASO provider. Note: This field appears when the Flat/Percentage field is Percentage .	Yes									
Final Settlement Surplus	Used to specify the percentage of surplus that should be retained by the ASO provider. Note: This field appears when the Flat/Percentage field is Percentage .	Yes									
Final Settlement Deficit	Used to specify the percentage of deficit that should be offered as a discount by the ASO provider. Note: This field appears when the Flat/Percentage field is Percentage .	Yes									
Flat Effective Payout	Used to specify the actual amount which should be retained by the ASO provider or offered as a discount, when the customer cancels the level funded agreement.	Not applicable									
	<table border="1"> <thead> <tr> <th data-bbox="475 1094 678 1178">Field Name</th> <th data-bbox="678 1094 1052 1178">Field Description</th> <th data-bbox="1052 1094 1260 1178">Mandatory (Yes or No)</th> </tr> </thead> <tbody> <tr> <td data-bbox="475 1178 678 1434">Final Settlement Surplus</td> <td data-bbox="678 1178 1052 1434">Used to specify the actual amount of surplus that should be retained by the ASO provider. Note: This field appears when the Flat/Percentage field is Flat Dollar.</td> <td data-bbox="1052 1178 1260 1434">Yes</td> </tr> <tr> <td data-bbox="475 1434 678 1713">Final Settlement Deficit</td> <td data-bbox="678 1434 1052 1713">Used to specify the actual amount of deficit that should be offered as a discount by the ASO provider. Note: This field appears when the Flat/Percentage field is Flat Dollar.</td> <td data-bbox="1052 1434 1260 1713">Yes</td> </tr> </tbody> </table>		Field Name	Field Description	Mandatory (Yes or No)	Final Settlement Surplus	Used to specify the actual amount of surplus that should be retained by the ASO provider. Note: This field appears when the Flat/Percentage field is Flat Dollar .	Yes	Final Settlement Deficit	Used to specify the actual amount of deficit that should be offered as a discount by the ASO provider. Note: This field appears when the Flat/Percentage field is Flat Dollar .	Yes
	Field Name		Field Description	Mandatory (Yes or No)							
	Final Settlement Surplus		Used to specify the actual amount of surplus that should be retained by the ASO provider. Note: This field appears when the Flat/Percentage field is Flat Dollar .	Yes							
Final Settlement Deficit	Used to specify the actual amount of deficit that should be offered as a discount by the ASO provider. Note: This field appears when the Flat/Percentage field is Flat Dollar .	Yes									
Final Settlement Surplus	Used to specify the actual amount of surplus that should be retained by the ASO provider. Note: This field appears when the Flat/Percentage field is Flat Dollar .	Yes									
Final Settlement Deficit	Used to specify the actual amount of deficit that should be offered as a discount by the ASO provider. Note: This field appears when the Flat/Percentage field is Flat Dollar .	Yes									

The **Renewal Decision** sub-section contains the following fields:

Field Name	Field Description	Mandatory (Yes or No)
Renewal Decision	Used to indicate the upcoming status of the level funded contract. The valid values are: <ul style="list-style-type: none"> Cancelled Renewed 	No
	Note: This field appears when the level funded current contract date is exceeded.	

2. Enter the required details in the **Final Settlement Rules** section.

3. Click **Save**.

The final settlement rules are added in the level funded pricing rule.

Related Topics

For more information on...	See...
How to define a level funded pricing rule for a parent customer	Defining a Level Funded Pricing Rule for a Parent Customer on page 2875
How to edit a level funded pricing rule of a parent customer	Editing a Level Funded Pricing Rule of a Parent Customer

Defining a Characteristic for a Level Funded Pricing Rule

Prerequisites

To define a characteristic for a level funded pricing rule, you should have:

- Characteristic types defined in the application (where the characteristic entity is set to **Pricing Rule**).

Procedure

To define a characteristic for a level funded pricing rule:

- Ensure that the **Characteristics** section is expanded when you are defining or editing a level funded pricing rule.

The **Characteristics** section contains the following fields in the grid:

Column Name	Column Description	Mandatory (Yes or No)
Effective Date	Used to specify the date from when the characteristic is effective for a level funded pricing rule.	Yes (Conditional)
		Note: This field is required when you are defining a characteristic for a level funded pricing rule.

Column Name	Column Description	Mandatory (Yes or No)
Characteristic Type	Used to indicate the characteristic type.	Yes (Conditional)
	Note: The list includes only those characteristic types where the characteristic entity is set to Pricing Rule .	Note: This field is required when you are defining a characteristic for a level funded pricing rule.
Characteristic Value	Used to specify the value for the characteristic type.	Yes (Conditional)
	Note: If you select a predefined characteristic type, the Search (🔍) icon appears corresponding to the Characteristic Value field. On clicking the Search icon, the Predefined Characteristic Search window appears. On specifying the value for a predefined characteristic type, the description of the characteristic value appears corresponding to the Characteristic Value field.	Note: This field is required when you are defining a characteristic for a level funded pricing rule.

- Enter the required details in the **Characteristics** section.
- If you want to define more than one characteristic for the level funded pricing rule, click the **Add (+)** icon and then repeat step 2.

Note: However, if you want to remove a characteristic from the level funded pricing rule, click the **Delete** (🗑️) icon corresponding to the characteristic.

- Click **Save**.

The characteristics are defined for the level funded pricing rule.

Related Topics

For more information on...	See...
How to define a level funded pricing rule for a parent customer	Defining a Level Funded Pricing Rule for a Parent Customer on page 2875
How to edit a level funded pricing rule of a parent customer	Editing a Level Funded Pricing Rule of a Parent Customer
How to define a level funded pricing rule for a bill group	Defining a Level Funded Pricing Rule for a Bill Group on page 2885
How to edit a level funded pricing rule for a bill group	Editing a Level Funded Pricing Rule of a Bill Group

Defining a Level Funded Pricing Rule for a Bill Group

Prerequisites

To define a level funded pricing rule for a bill group, you should have:

- Pricing rule type where the category is set to **Level Funded**.

- Price items associated with the level funded pricing rule type.
- Specific stop-loss pricing rule of the parent customer, whose accumulation parameters you want to inherit for level funding.
- Policy status defined in the application.

Procedure

To define a level funded pricing rule for a bill group:

1. Search for the Administrative Services Only (ASO) person, whose person type is set to **Bill Group**, in the **Customer 360° View** screen.
2. In the **Search Results** section, click the **View** () icon corresponding to the person whose pricing details you want to view.

The **Person** tab appears in the **Customer 360° Information** screen.

3. Click the **Pricing** tab.

The **Pricing** tab appears.

4. Click the **Broadcast** () icon in the **Bill Group ASO Policy Information** zone, corresponding to the **Bill Group Information** column, whose bill group details you want to view.

The **Bill Group ASO Policy Pricing Rules** zone is displayed.

5. Click the **Add** link in the upper right corner of the **Bill Group ASO Policy Pricing Rules** zone.

The **Pricing Rule** screen appears. It contains the following fields:

Field Name	Field Description	Mandatory (Yes or No)
Person Name	Indicates the name of the parent customer.	Not applicable
Person Type	Indicates the type of the parent customer. Note: If you are defining the pricing rule type for the parent customer, then the person type will be Parent Customer .	Not applicable
Pricing Rule Type	Used to indicate the pricing rule type using which you want to create a level funded pricing rule. Note: Select the Level Funded Pricing Rule Type option, as the pricing rule.	Yes Note: If the pricing rule type is not selected then the application displays an error message.
Pricing Group	Used to indicate the pricing group which is used while defining the pricing.	No
Policy Status	Used to indicate the policy status for the pricing rule. The valid values are: <ul style="list-style-type: none"> • In Force/Active • Runout 	Yes (Conditional) Note: Policy Status is required once the Pricing Rule Type is selected.

6. Click **OK**.

The **Level Funded (LF) Pricing Rule** screen appears. It contains the following sections:

- **Customer Information** – Displays the information about the bill group. It contains the following columns:

Column Name	Column Description
Bill Group Information	Displays the bill group information.
Policy Start Date	Displays the date from when the policy is effective.
Policy End Date	Displays the date till when the policy is effective.
Policy Status	Indicates the policy status for the pricing rule.
Pricing Rule Type	Indicates the pricing rule type for whom the level funded pricing rule is created.

- **Main** – Used to specify basic details in the level funding pricing rule.
- **Accumulation Criteria** – Used to define the accumulation criteria in a level funded pricing rule.
- **Pricing Information for rule type category : Claim** – Used to define the line items in a particular claim pricing rule or those which are associated with the level funded rule type category.
- **Pricing Information for rule type category : Ancillary** – Used to define the line items in a particular ancillary pricing rule or those which are associated with the level funded rule type category.
- **Pricing Information for rule type category : Discount** – Used to define the discount arrangement pricing rule which is effective for level funding calculations.
- **Pricing Information for rule type category : Retention** – Used to define the retention pricing rule which is effective for level funding calculations.
- **Characteristics** – Used to define the characteristics for the level funded pricing rule.

Note:
The **Accumulation Criteria, Pricing Information for rule type category: Claim, Pricing Information for rule type category: Ancillary, Pricing Information for rule type category: Discount, and Pricing Information for rule type category: Retention** section appear when you specify a price item in the **Main** section.

The **Main** section contains the following fields:

Field Name	Field Description	Mandatory (Yes or No)
Price Item	Used to indicate the price item for which you want to define the level funded pricing rule.	Yes
Parent Customer's Pricing Rule	Used to indicate the date range of each specific stop-loss pricing rule, defined for the parent customer. Note: On selecting the specific stop-loss pricing rule of the parent customer, the level funded Pricing Start Date and Pricing End Date field is set automatically.	Yes
Pricing Start Date	Used to specify the date from when the level funded pricing rule is effective. Note: The pricing start date cannot be later than the pricing end date.	Not applicable

Field Name	Field Description	Mandatory (Yes or No)
Pricing End Date	Used to specify the date till when the level funded pricing rule is effective.	Not applicable
	Note: The pricing end date cannot be earlier than the pricing start date.	
Rate Option	Used to indicate the rate option that you want to use while defining the pricing for the price item.	Yes
Settlement Fund Price Item	Used to indicate the price item derived from the level funded pricing rule type, used to create the level funded pricing rule type.	Not applicable

7. Enter the required details in the **Main** section.
8. Define the accumulation criteria in the level funded pricing rule for a bill group.
9. Define the pricing information for the claim rule type category for a bill group.
10. Define the pricing information for the ancillary rule type category for a bill group, if required.
11. Define the pricing information for the discount rule type category for a bill group, if required.
12. Define the pricing information for the retention rule type category for a bill group, if required.
13. Define characteristics for the level funded pricing rule for a bill group, if required, if required.
14. Click **Save**.

The level funded pricing rule is defined for a bill group.

Related Topics

For more information on...	See...
How to search for a parent customer	Searching for a Person on page 648
Parent Customer Pricing Rules zone	Parent Customer Pricing Rules on page 696
How to define accumulation criteria in a level funded rule for a bill group	Defining Accumulation Criteria in a Level Funded Pricing Rule on page 2888
How to define claim pricing information in a level funded pricing rule	Defining Claim Pricing Information in a Level Funded Pricing Rule on page 2891
How to define ancillary pricing information in a level funded pricing rule	Defining Ancillary Pricing Information in a Level Funded Pricing Rule on page 2894
How to define discount pricing information in a level funded pricing rule	Defining Discount Arrangement Pricing Information in a Level Funded Pricing Rule on page 2897
How to define retention type claim based and/or retention type enrollment based pricing information in a level funded pricing rule	Defining Retention Type Claim Based and/or Retention Type Enrollment Based Pricing Rule Information in a Level Funded Pricing Rule on page 2899
How to define a characteristic for the level funded pricing rule for a bill group	Defining a Characteristic for a Level Funded Pricing Rule on page 2884

Defining Accumulation Criteria in a Level Funded Pricing Rule

Procedure

To define accumulation criteria in a level funding pricing rule:

1. Ensure that the **Accumulation Criteria** section is expanded when you have selected an option from the **Price Item** field of the **Main** section while defining a level funded pricing rule.

The **Accumulation Criteria** section contains the following fields:

Field Name	Field Description	Mandatory (Yes or No)						
Accumulation Group ID	Displays a blank field. An accumulation group ID is generated when accumulation parameter values are defined for a level funded pricing rule. Note: It is a read-only field.	Not applicable						
Price Items	Used to indicate the price item that you want to include in the accumulation criteria for a bill group. <table border="1"> <thead> <tr> <th>Field Name</th> <th>Field Description</th> <th>Mandatory (Yes or No)</th> </tr> </thead> <tbody> <tr> <td>Price Item</td> <td>Used to indicate the price item which is eligible for level funding. Note: The Search (🔍) icon appears corresponding to the Price Item field. On clicking the Search icon, the Price Item Search window appears. On specifying the price item, the description of the price item appears corresponding to the Price Item field.</td> <td>Not applicable</td> </tr> </tbody> </table> Note: If you want to add more than one price item in a level funded pricing rule, click the Add (+) icon. However, if you want to remove a price item from a level funded pricing rule, click the Delete (🗑️) icon corresponding to the price item.	Field Name	Field Description	Mandatory (Yes or No)	Price Item	Used to indicate the price item which is eligible for level funding. Note: The Search (🔍) icon appears corresponding to the Price Item field. On clicking the Search icon, the Price Item Search window appears. On specifying the price item, the description of the price item appears corresponding to the Price Item field.	Not applicable	Not applicable
Field Name	Field Description	Mandatory (Yes or No)						
Price Item	Used to indicate the price item which is eligible for level funding. Note: The Search (🔍) icon appears corresponding to the Price Item field. On clicking the Search icon, the Price Item Search window appears. On specifying the price item, the description of the price item appears corresponding to the Price Item field.	Not applicable						

Field Name	Field Description	Mandatory (Yes or No)									
Price Item Parameters	Used to indicate the price item parameters that you want to include in the accumulation criteria for a bill group.	Not applicable									
	<table border="1"> <thead> <tr> <th>Field Name</th> <th>Field Description</th> <th>Mandatory (Yes or No)</th> </tr> </thead> <tbody> <tr> <td>Price Item Parameter</td> <td>Used to indicate the price item parameter which is eligible for level funding. Note: The Search (🔍) icon appears corresponding to the Price Item Parameter field. On clicking the Search icon, the Price Item Parameter Search window appears. On specifying the price item parameter, the description of the price item parameter appears corresponding to the Parameter Value field.</td> <td>Not applicable</td> </tr> <tr> <td>Parameter Value</td> <td>Used to indicate the parameter values which is eligible for level funding.</td> <td>Not applicable</td> </tr> </tbody> </table>		Field Name	Field Description	Mandatory (Yes or No)	Price Item Parameter	Used to indicate the price item parameter which is eligible for level funding. Note: The Search (🔍) icon appears corresponding to the Price Item Parameter field. On clicking the Search icon, the Price Item Parameter Search window appears. On specifying the price item parameter, the description of the price item parameter appears corresponding to the Parameter Value field.	Not applicable	Parameter Value	Used to indicate the parameter values which is eligible for level funding.	Not applicable
	Field Name		Field Description	Mandatory (Yes or No)							
	Price Item Parameter		Used to indicate the price item parameter which is eligible for level funding. Note: The Search (🔍) icon appears corresponding to the Price Item Parameter field. On clicking the Search icon, the Price Item Parameter Search window appears. On specifying the price item parameter, the description of the price item parameter appears corresponding to the Parameter Value field.	Not applicable							
Parameter Value	Used to indicate the parameter values which is eligible for level funding.	Not applicable									
Note: If you want to add more than one price item parameter in the accumulation criteria, click the Add (+) icon. However, if you want to remove a price item parameter from the accumulation criteria, click the Delete (🗑️) icon corresponding to the price item parameter.											

2. Enter the required details in the **Accumulation Criteria** section.
3. Click **Save**.

The accumulation criteria is defined in the level funded pricing rule.

Related Topics

For more information on...	See...
How to define a level funded pricing rule for a bill group	Defining a Level Funded Pricing Rule for a Bill Group on page 2885
How to edit a level funded pricing rule of a parent customer	Editing a Level Funded Pricing Rule of a Parent Customer

Defining Claim Pricing Information in a Level Funded Pricing Rule

Procedure

To define the claim pricing information in the level funded pricing rule:

1. Ensure that the **Pricing Information for rule type category : Claim** zone is expanded when you have selected an option from the **Price Item** field of the **Main** section while defining or editing a level funded pricing rule for a bill group.

The **Pricing Information for rule type category : Claim** zone contains the following fields:

Field Name	Field Description	Mandatory (Yes or No)
Pricing Rule Type	Used to indicate the claim pricing rule type effective for level funded pricing.	Yes
Derive Using	Used to indicate the method through which the claim pricing rule information is derived. The valid values are: <ul style="list-style-type: none"> • LF Line Items • Pricing Rules 	Yes

If **LF Line Items** option is selected from the **Derive Using** field, the following sub-sections appear:

- **Domestic Provider Claims** – Used to specify the domestic provider claims while calculating the level funding line items.
- **Markup or Markdown Values** – Used to define the markup or markdown values for level funding line items.
- **Line Items** – Used to associate the line items which are eligible for billing.

The **Domestic Provider Claims** section contains the following field:

Field Name	Field Description	Mandatory (Yes or No)
Exclude LF (Percentage)	Used to specify the billable charge line excluding the level funding charge in the percentage to create the domestic provider claim calculation lines.	No

The **Markup or Markdown Values** section contains the following fields:

Field Name	Field Description	Mandatory (Yes or No)
Pricing Strategy	Used to indicate the pricing strategy for the claim line items. The valid values are: <ul style="list-style-type: none"> • Markdown • Markup • None 	Not applicable
Markup or Markdown Type	Used to indicate the markup or markdown value type for the claim line items. The valid values are: <ul style="list-style-type: none"> • Flat Amount • Percentage 	Not applicable

Field Name	Field Description	Mandatory (Yes or No)
Markup or Markdown Amount	Used to specify the markup or markdown amount for the claim line items.	Not applicable
	Note: This field displays amount when Markup or Markdown Type field is set as Flat Amount .	
Markup / Markdown Included in Settlement?	Used to specify whether markup or markdown amount should be included in the level funding settlement. The valid values are:	Yes (Conditional)
	<ul style="list-style-type: none"> • Yes • No 	Note: This field is required when Flat Amount option is selected from the Markup or Markdown Type field.
	Note: This field is required when Flat Amount option is selected from the Markup or Markdown Type field.	

The **Line Items** section contains the following field:

Field Name	Field Description	Mandatory (Yes or No)
Line Item	Used to indicate the line item which is eligible for level funded pricing.	No
	<p>Note:</p> <p>The Search (🔍) icon appears corresponding to the Line Item field. On clicking the Search (🔍) icon corresponding to the Line Item field, the Pricing Rule Line Item Search window appears.</p> <p>On specifying the pricing rule line item, the description of the pricing rule line item appears corresponding to the Line Item field.</p>	

If **Pricing Rule Type** option is selected from the **Derive Using** field, following sub-sections appear:

- **Claim Pricing Rule** – Used to indicate the claim pricing rule. It contains the following sub-sections:
 - **Domestic Provider Claims** – Used to specify the domestic provider claims while calculating the level funded pricing.
 - **Markup or Markdown Values** – Used to define the markup or markdown values for the billable charge line items.
 - **Line Items** – Used to associate the line items which are eligible for billing.

The **Claim Pricing Rule** section contains the following field:

Field Name	Field Description	Mandatory (Yes or No)
Effective Claim Pricing Rule	Used to indicate the claim pricing rule effective for level funded pricing.	No

Note: If you are editing a bill group's level funded pricing rule for the **Claim** rule type category (where the bill group's pricing has ended), a **Reapply** button appears corresponding to the **Effective Claim Pricing Rule** field. You can select an effective claim pricing rule and click the **Reapply** button to set a new pricing for the claim rule type that is eligible for level funding.

The **Domestic Provider Claims** section contains the following field:

Field Name	Field Description	Mandatory (Yes or No)
Exclude (Percentage) LF	Used to specify the billable charge line excluding the level funding charge in the percentage to create the domestic provider claim calculation lines.	No

The **Markup or Markdown Values** section contains the following fields:

Field Name	Field Description	Mandatory (Yes or No)
Pricing Strategy	Used to indicate the pricing strategy for the claim line items. The valid values are: <ul style="list-style-type: none"> • Markdown • Markup • None 	Not applicable
Markup or Markdown Type	Used to indicate the markup or markdown value type for the claim line items. The valid values are: <ul style="list-style-type: none"> • Flat Amount • Percentage 	Not applicable
Markup or Markdown Amount	Used to specify the markup or markdown amount for the claim line items. Note: This field displays amount when Markup or Markdown Type field is set as Flat Amount .	Not applicable
Markup / Markdown Included in Settlement?	Used to specify whether markup or markdown amount should be included in the level funding settlement. The valid values are: <ul style="list-style-type: none"> • Yes • No Note: This field is required when Flat Amount option is selected from the Markup or Markdown Type field.	Yes (Conditional) Note: This field is required when Flat Amount option is selected from the Markup or Markdown Type field.

The **Line Items** section contains the following fields:

Field Name	Field Description	Mandatory (Yes or No)
Sequence	Displays the sequence number for the line items.	Not applicable
Line Item	Displays the billing line items.	Not applicable

Field Name	Field Description	Mandatory (Yes or No)
Include in Settlement	Used to indicate whether the line item should be included in the level funded claim pricing settlement.	No
Markup or Markdown Included in Settlement	Used to indicate whether markup or markdown should be included in the level funded claim settlement.	No
Markup or Markdown Percentage Eligibility	Used to indicate whether the line item is eligible or not eligible for markup or markdown percentage. The valid values are: <ul style="list-style-type: none"> • Eligible • Not Eligible 	Not applicable
Markup or Markdown Percentage	Used to indicate the percentage for markup or markdown value.	Not applicable

- Enter the required details in the appropriate sections, based on the option that is selected from the **Derive Using** field.
- If you want to add information for more than one claim pricing rule type to the level funded pricing rule, click the **Add (+)** icon and then repeat step 2.

Note: However, if you want to remove information of more than one claim pricing rule type from the level funded pricing rule, click the **Delete (🗑)** icon corresponding to the pricing rule type field.

- Click **Save**.

The claim line items are defined in the level funded pricing rule.

Related Topics

For more information on...	See...
How to define level funded pricing rule for a bill group	Defining a Level Funded Pricing Rule for a Bill Group on page 2885
How to edit level funded pricing rule for a bill group	Editing a Level Funded Pricing Rule of a Bill Group

Defining Ancillary Pricing Information in a Level Funded Pricing Rule

Procedure

To define the ancillary pricing information in the level funded pricing rule:

- Ensure that the **Pricing Information for rule type category : Ancillary** zone is expanded only when you have selected an option from the **Price Item** field of the **Main** section while defining or editing a level funded pricing rule for a bill group.

The **Pricing Information for rule type category : Ancillary** zone contains the following fields:

Field Name	Field Description	Mandatory (Yes or No)
Pricing Rule Type	Used to indicate the ancillary pricing rule type effective for level funded pricing.	Yes

Field Name	Field Description	Mandatory (Yes or No)
Derive Using	Used to indicate the method through which the ancillary pricing rule information is derived. The valid values are: <ul style="list-style-type: none"> Ancillary Billable Charge Line Type Pricing Rules 	Yes

If **Ancillary Billable Charge Line Type** option is selected from the **Derive Using** field, the following subsections appear:

- Billable Charge Line Types** – Used to associate the billable charge line items which are eligible for billing.

The **Billable Charge Line Types** section contains the following field:

Field Name	Field Description	Mandatory (Yes or No)
Billable Charge Line Type	Used to indicate the billable charge line type using which you want to create the calculation line for the charge (i.e. line item). Note: The Search (🔍) icon appears corresponding to the Billable Charge Line Type field. On clicking the Search icon, the Billable Charge Line Type Search window appears. On specifying the billable charge line type, the description of the billable charge line type appears corresponding to the Billable Charge Line Type field.	Yes
Rate Based	Used to indicate that the billable charge line type is rate based.	No
Rate	Used to specify the rate for the billable charge line type. Note: This field is enabled when the Rate Based option is selected.	Yes (Conditional) Note: This field is required when the Rate Based option is selected.
Markup / Markdown Included in Settlement?	Used to indicate that markup or markdown amount must be included in the level funding settlement.	No
Pricing Strategy	Used to indicate the pricing strategy for the billable charge line items. The valid values are: <ul style="list-style-type: none"> Markdown Markup None 	Yes

Field Name	Field Description	Mandatory (Yes or No)
Markup or Markdown Type	Used to indicate the markup or markdown type for the billable line items. The valid values are: <ul style="list-style-type: none"> Flat Amount Percentage 	Yes (Conditional)
	Note: This field is enabled when the Pricing Strategy option is selected either as Markup or Markdown .	Note: This field is required when the Rate Based option is selected either as Markup or Markdown .
Amount/Percentage	Used to specify the amount or percentage for markup or markdown value.	Yes (Conditional)
	Note: This field appears when the Markup or Markdown Type option is selected.	Note: This field is required when the Markup or Markdown Type option is selected.

If **Pricing Rule Type** option is selected from the **Derive Using** field, the following zone appears:

- Ancillary Pricing Rule** - Used to indicate the ancillary pricing rule. It contains the following sub-section:
 - The **Billable Charge Line Types** - Used to define the billable charge line types for an ancillary pricing rule, eligible for level funding.

The **Ancillary Pricing Rule** section contains the following field:

Field Name	Field Description	Mandatory (Yes or No)
Effective Ancillary Pricing Rule	Used to indicate the ancillary pricing rule effective for level funded pricing.	No

Note: If you are editing a bill group's level funded pricing rule for the **Ancillary** rule type category (where the bill group's pricing has ended), a **Reapply** button appears corresponding to the **Effective Ancillary Pricing Rule** field. You can select an effective ancillary pricing rule and click the **Reapply** button to set a new pricing for the ancillary rule type that is eligible for level funding.

The **Billable Charge Line Types** section contains the following fields:

Field Name	Field Description	Mandatory (Yes or No)
Sequence	Displays the sequence number for the line items.	Not applicable
Billable Charge Line Type	Used to indicate the billable charge line type using which you want to create the calculation line for the charge (i.e. line item). <p>Note:</p> <p>The Search (🔍) icon appears corresponding to the Billable Charge Line Type field. On clicking the Search icon, the Billable Charge Line Type Search window appears.</p> <p>On specifying the billable charge line type, the description of the billable charge line type appears corresponding to the Billable Charge Line Type field.</p>	Not applicable

Field Name	Field Description	Mandatory (Yes or No)
Include in Settlement	Used to indicate whether the billable charge line item should be included in the level funded ancillary pricing settlement.	Not applicable
Rate Based	Indicates that the billable charge line type is rate based.	Not applicable
Rate	Displays the rate for the billable charge line type.	Not applicable
Markup / Markdown Included in Settlement?	Used to indicate that markup or markdown amount must be included in the level funding settlement.	Not applicable
Pricing Strategy	Displays the pricing strategy for the billable charge line items. The valid values are: <ul style="list-style-type: none"> • Markdown • Markup • None 	Not applicable
Markup or Markdown Type	Indicates the markup or markdown type for the billable charge line items. The valid values are: <ul style="list-style-type: none"> • Flat Amount • Percentage <p>Note: This field is enabled when the Pricing Strategy option is selected either as Markup or Markdown.</p>	Not applicable
Amount/ Percentage	Displays the amount or percentage which is specified as the markup or markdown value.	Not applicable

- Enter the required details in the appropriate sections, based on the option selected from the **Derive Using** field.
- If you want to add information for more than one ancillary pricing rule type to the level funded pricing rule, click the **Add (+)** icon and then repeat step 2.

Note: However, if you want to remove information of more than one ancillary pricing rule type from the level funded pricing rule, click the **Delete (🗑)** icon corresponding to the pricing rule type field.

- Click **Save**.

The ancillary line items are defined in the level funded pricing rule.

Related Topics

For more information on...	See...
How to define level funded pricing rule for a bill group	Defining a Level Funded Pricing Rule for a Bill Group on page 2885
How to edit level funded pricing rule for a bill group	Editing a Level Funded Pricing Rule of a Bill Group

Defining Discount Arrangement Pricing Information in a Level Funded Pricing Rule

Procedure

To define the discount arrangement pricing information in the level funded pricing rule:

1. Ensure that the **Pricing Information for rule type category : Discount** zone is expanded only when you have selected an option from the **Price Item** field of the **Main** section while defining or editing a level funded pricing rule for a bill group.

The **Pricing Information for rule type category : Discount** zone contains the following fields:

Field Name	Field Description	Mandatory (Yes or No)
Pricing Rule Type	Used to indicate the discount arrangement pricing rule type which is effective for level funding.	Yes
Derive Using	Used to indicate the method through which the discount arrangement pricing rule information is derived. The valid values are: <ul style="list-style-type: none"> • Pricing Rules 	Yes

On selecting the **Pricing Rule Type** option from the **Derive Using** field, the following sub-section appears:

- **Discount Pricing Rule** - Used to indicate the discount arrangement pricing rule. It contains the following field:

Field Name	Field Description	Mandatory (Yes or No)
Discount Pricing Rule	Used to indicate the discount arrangement pricing rule which is effective for level funding.	Yes

2. Select the appropriate discount arrangement pricing rule from the **Discount Pricing Rule** section.

Note:

On selecting the discount arrangement pricing rule, the system does not generate any line items for the discount arrangement pricing information. This discount arrangement pricing rule is used at the time of level funding calculations in the TFM module.

3. If you want to add information for more than one discount pricing rule type to the level funded pricing rule, click the **Add (+)** icon and then repeat step 2.

Note: However, if you want to remove information of more than one discount pricing rule type from the level funded pricing rule, click the **Delete (🗑)** icon corresponding to the pricing rule type field.

4. Click **Save**.

The discount arrangement pricing information is defined in the level funded pricing rule.

Related Topics

For more information on...	See...
How to define level funded pricing rule for a bill group	Defining a Level Funded Pricing Rule for a Bill Group on page 2885
How to edit level funded pricing rule for a bill group	Editing a Level Funded Pricing Rule of a Bill Group

Defining Retention Type Claim Based and/or Retention Type Enrollment Based Pricing Rule Information in a Level Funded Pricing Rule

Procedure

To define the retention type claim based and/or retention type enrollment based pricing rule information in a level funded pricing rule:

1. Ensure that the **Pricing Information for rule type category : Retention** zone is expanded when you have selected an option from the **Price Item** field of the **Main** section while defining or editing a level funded pricing rule for a bill group.

The **Pricing Information for rule type category : Retention** zone contains the following fields:

Field Name	Field Description	Mandatory (Yes or No)
Retention Rule Type	Used to indicate the retention type claim based and/or retention type enrollment based pricing rule type for the level funded pricing rule.	Yes
Price Item	Used to indicate the price item for the level funded pricing rule. Note: The Search (🔍) icon appears corresponding to the Price Item field. On clicking the Search (🔍) icon corresponding to the Price Item field, the Get Retention Type Pricing Rules window appears. On specifying the retention type pricing rule, the description of the retention type pricing rule appears corresponding to the Price Item field.	Yes

2. Select the appropriate **Retention Rule Type** and **Price Item** from the **Pricing Information for rule type category : Retention** zone.

Note:

Once the retention type claim based and/or retention type enrollment based pricing rule type is selected along with the price item, the system does not generate line items for the retention type claim/enrollment based pricing rule. This retention type claim/enrollment based pricing rule is used at the time of level funding calculations in the TFM module.

3. If you want to add more than one retention type claim based and/or retention type enrollment based pricing rule type to the level funded pricing rule, click the **Add** (+) icon and then repeat step 2.

Note: However, if you want to remove more than one retention type claim based and/or retention type enrollment based pricing rule type from the level funded pricing rule, click the **Delete** (🗑️) icon corresponding to the pricing rule type field.

4. Click **Save**.

The retention type claim based and/or retention type enrollment based pricing rules eligible for level funding are defined in the level funded pricing rule.

Related Topics

For more information on...	See...
How to define level funded pricing rule for a bill group	Defining a Level Funded Pricing Rule for a Bill Group on page 2885
How to edit level funded pricing rule for a bill group	Editing a Level Funded Pricing Rule of a Bill Group

Defining a Characteristic for a Level Funded Pricing Rule

Prerequisites

To define a characteristic for a level funded pricing rule, you should have:

- Characteristic types defined in the application (where the characteristic entity is set to **Pricing Rule**).

Procedure

To define a characteristic for a level funded pricing rule:

1. Ensure that the **Characteristics** section is expanded when you are defining or editing a level funded pricing rule.

The **Characteristics** section contains the following fields in the grid:

Column Name	Column Description	Mandatory (Yes or No)
Effective Date	Used to specify the date from when the characteristic is effective for a level funded pricing rule.	Yes (Conditional)
		Note: This field is required when you are defining a characteristic for a level funded pricing rule.
Characteristic Type	Used to indicate the characteristic type.	Yes (Conditional)
	Note: The list includes only those characteristic types where the characteristic entity is set to Pricing Rule .	Note: This field is required when you are defining a characteristic for a level funded pricing rule.
Characteristic Value	Used to specify the value for the characteristic type.	Yes (Conditional)
	Note: If you select a predefined characteristic type, the Search (🔍) icon appears corresponding to the Characteristic Value field. On clicking the Search icon, the Predefined Characteristic Search window appears. On specifying the value for a predefined characteristic type, the description of the characteristic value appears corresponding to the Characteristic Value field.	Note: This field is required when you are defining a characteristic for a level funded pricing rule.

2. Enter the required details in the **Characteristics** section.
3. If you want to define more than one characteristic for the level funded pricing rule, click the **Add** (+) icon and then repeat step 2.

Note: However, if you want to remove a characteristic from the level funded pricing rule, click the **Delete** (🗑️) icon corresponding to the characteristic.

4. Click **Save**.

The characteristics are defined for the level funded pricing rule.

Related Topics

For more information on...	See...
How to define a level funded pricing rule for a parent customer	Defining a Level Funded Pricing Rule for a Parent Customer on page 2875
How to edit a level funded pricing rule of a parent customer	Editing a Level Funded Pricing Rule of a Parent Customer
How to define a level funded pricing rule for a bill group	Defining a Level Funded Pricing Rule for a Bill Group on page 2885
How to edit a level funded pricing rule for a bill group	Editing a Level Funded Pricing Rule of a Bill Group

Terminal Liability Reserve (Run Out) Level Funding Pricing

Oracle Revenue Management and Billing provides a mechanism to maintain terminal liability reserve for a self-funded policy through level funding. Now, the system supports the following types of level funding:

- Regular Enrollment Based Level Funding Without Terminal Liability Reserve (TLR)
- Flat Rate Based Level Funding Without TLR
- Regular Enrollment Based Level Funding With TLR
- Flat Rate Based Level Funding With TLR

The **C1-PricingRuleTypeLF** and **C1-PricingRuleLevelFunded** business objects are extended to support the TLR feature. Therefore, you can now define pricing rule types for the above listed types of level funding. While creating a level funding pricing rule type with TLR feature, you need to specify the following:

- **Terminal Liability Reserve (Run Out) Funding Required** - Used to indicate whether you want to define a level funding pricing rule type with TLR.
- **Claim Fund Off-Process Request Type** - Used to indicate the off-process request type using which the off-process request should be created in the **C1-BCLF** batch. Through this off-process request, the system creates billable charge when the customer decides to roll forward the claim fund.
- **Run Out Fund Off-Process Request Type** - Used to indicate the off-process request type using which the off-process request should be created in the **C1-BCLF** batch. Through this off-process request, the system creates billable charge when the customer decides to roll forward the run out fund.
- **Run Out Fund Pricing Rule Type** - Used to specify a bill period based recurring flat fee pricing rule type or retention type enrollment based pricing rule type which you want to use for calculating the run out fund.
- **Run Out Fund Price Item** - Used to specify the price item which you want to use for calculating the run out fund.
- **Run Out Billable Charge Line Type** - Used to specify the billable charge line type using which you want to create calculation line while settling charges, stop-loss, or discount through run out fund in the runout period.

- **Run Out Surplus Billable Charge Line Type** - Used to specify the billable charge line type using which you want to create the calculation line when the surplus run out funds are left with the ASO provider at the time of settlement.
- **Run Out Deficit Billable Charge Line Type** - Used to specify the billable charge line type using which you want to create the calculation line when the run out funds are in deficit at the time of settlement.

Now, the system enables you to specify the settlement rules while creating a level funding pricing rule type with or without TLR feature. While defining settlement rules, you need to specify the following:

- The policy status for which the settlement rules are applicable
- The fund type (i.e. claim or run out fund) for which you want to define the settlement rules
- The customer action (i.e. cancel or renew the self-funded policy) based on which you want to either close or roll forward the surplus or deficit claim or run out fund

The system provides an option to indicate whether the settlement rules specified for a claim or run out fund are editable. Accordingly, you can change the settlement rules when you create a pricing rule using the pricing rule type for a parent customer.

Now, the system enables you to create a different level funded pricing rule for each policy status at the parent customer level.

Pricing Rule (Used for Viewing)

The **Pricing Rule** screen allows you to:

- View the details of a claim pricing rule of a parent customer
- View the details of a claim pricing rule of a bill group
- View the details of an aggregate stop-loss pricing rule of a parent customer
- View the details of an aggregate stop-loss pricing rule of a bill group
- View the details of a specific stop-loss pricing rule of a parent customer
- View the details of a specific stop-loss pricing rule of a bill group
- View the details of a retention type claim based pricing rule of a parent customer
- View the details of a retention type claim based pricing rule of a bill group
- View the details of a retention type enrollment based pricing rule of a parent customer
- View the details of a retention type enrollment based pricing rule of a bill group
- View the details of a one-time flat fee pricing rule of a bill group
- View the details of a bill period based recurring flat fee pricing rule of a bill group
- View the details of a frequency based recurring flat fee pricing rule of a bill group
- View the details of an ancillary pricing rule of a parent customer
- View the details of an ancillary pricing rule of a bill group
- View the details of a discount arrangement pricing rule of a parent customer
- View the details of a level funded pricing rule of a parent customer
- View the details of a level funded pricing rule of a bill group
- View the details of an age based pricing rule of a parent customer
- View the details of an age based pricing rule of a bill group
- View the details of a tier based pricing rule of a parent customer

- View the details of a tier based pricing rule of a bill group
- View the details of an additional charge pricing rule of a parent customer
- View the details of an additional charge pricing rule of a bill group

This screen consists of the following zones:

- [Claim](#) on page 2903
- [Aggregate Stop-Loss](#) on page 2906
- [Specific Stop-Loss](#) on page 2912
- [Retention Type Claim Based](#) on page 2917
- [Retention Type Enrollment Based](#) on page 2919
- [Flat Fee](#) on page 2920
- [Ancillary](#) on page 2922
- [Discount Arrangement](#) on page 2924
- [Level Funded](#) on page 2926
- [Age Based Pricing Rule](#) on page 2932
- [Tier Based Pricing Rule](#) on page 2933
- [Additional Charge Pricing Rule](#) on page 2935

Claim

The **Claim** zone displays the details of the claim pricing rule for respective parent customer, bill group or a bill group using a pricing group. It contains the following sections:

- **Main** – Displays basic details of the claim pricing rule. It contains the following fields:

Field Name	Field Description
Parent Customer Information	<p>Displays the parent customer information. In addition, a context menu appears corresponding to this field which helps in navigating to other screens in the application.</p> <p>Note: It has a link. On clicking the link, the Person, Account or Policy screen appears where you can view the details of the parent customer. This field appears only when the claim pricing rule is viewed for parent customer.</p>
Bill Group Information	<p>Displays the bill group information. In addition, a context menu appears corresponding to this field which helps in navigating to other screens in the application.</p> <p>Note: It has a link. On clicking the link, the Person, Account or Policy screen appears where you can view the details of the bill group. This field appears when the claim pricing rule is viewed for bill group.</p>

Field Name	Field Description
Policy Information	Displays the policy information.
	Note: It has a link. On clicking the link, the Policy screen appears where you can view the details of the policy.
Pricing Rule Type	Indicates the pricing rule type.
Price Item Information	Indicates the price item information.
	Note: It has a link. On clicking the link, the Price Item screen appears where you can view the details of the price item.
Pricing Start Date	Displays the claim pricing rule start date.
Pricing End Date	Displays the claim pricing rule end date.
Rate Option	Indicates the rate option of the claim pricing rule for the price item.
Claim Template	Indicates the claim template of the claim pricing rule.
Pricing Group	Displays the pricing group of the claim pricing rule.
	Note: This field appears when the claim pricing rule is viewed for pricing group.

- **Claim Handling Fees** – Lists the claim handling fees for line items in a claim pricing rule. It contains the following columns:

Column Name	Column Description						
Fee Type	Indicates the type of charge applicable on the line items.						
Fee	Indicates the fee for the line items.						
Fee Significance	Indicates the purpose of the imposing the additional fees on the line items.						
Fee Applicability	Displays the fee applicability on which the claim handling fees are defined.						
	<table border="1"> <thead> <tr> <th>Column Name</th> <th>Column Description</th> </tr> </thead> <tbody> <tr> <td>Line Item</td> <td>Indicates the line item that you want to use while defining additional fees for the claim pricing rule.</td> </tr> </tbody> </table>	Column Name	Column Description	Line Item	Indicates the line item that you want to use while defining additional fees for the claim pricing rule.		
	Column Name	Column Description					
Line Item	Indicates the line item that you want to use while defining additional fees for the claim pricing rule.						
Rating Information	Displays the rating information that you want to use while defining the rate for the line items.						
	<table border="1"> <thead> <tr> <th>Column Name</th> <th>Column Description</th> </tr> </thead> <tbody> <tr> <td>Rate Type</td> <td>Indicates the rate type that you want to use while defining the additional fees for the line items.</td> </tr> <tr> <td>Rate</td> <td>Used to specify the rate that you want to use while defining the additional fees for the line items.</td> </tr> </tbody> </table>	Column Name	Column Description	Rate Type	Indicates the rate type that you want to use while defining the additional fees for the line items.	Rate	Used to specify the rate that you want to use while defining the additional fees for the line items.
	Column Name	Column Description					
	Rate Type	Indicates the rate type that you want to use while defining the additional fees for the line items.					
Rate	Used to specify the rate that you want to use while defining the additional fees for the line items.						
	Note: This field is editable when the Editable checkbox is selected in the Rate column of the Additional Fees section while defining or editing the C1-ExtLookClaimTemplate extendable lookup.						

- **Markup or Markdown Values** – Lists the markup or markdown values for line items in a claim pricing rule. It contains the following columns:

Column Name	Column Description
Pricing Strategy	Indicates the pricing strategy. The valid values are: <ul style="list-style-type: none"> • Markdown • Markup • None
Markup or Markdown Type	Indicates the markup or markdown value type for claim pricing rule. The valid values are: <ul style="list-style-type: none"> • Flat Amount • Percentage
Markup or Markdown Amount	Displays the markup or markdown amount.
Rate Type	Displays minimum and maximum markup or markdown defined using the rate type.
Rate	Displays the value for minimum and maximum markup or markdown defined using the rate type.

- **Line Items** – This section contains the following fields:

Field Name	Field Description
Sequence	Displays the sequence number for the line items.
Line Item	Displays the billing line items.
Billing Eligibility	Displays whether the line item is user defined, eligible or not eligible for billing. The valid values are: <ul style="list-style-type: none"> • Eligible • Not Eligible • User Defined (Default Yes) • User Defined (Default No)
User Defined Billing Option	Displays whether the billing option is user defined, eligible or not eligible.
Markup or Markdown Percentage Eligibility	Displays whether the line item is eligible or not eligible for markup or markdown percentage. The valid values are: <ul style="list-style-type: none"> • Eligible • Not Eligible
Markup or Markdown Percentage	Displays the percentage for markup or markdown value.

Field Name	Field Description								
Rating Information	Displays the rating information that you want to use while defining the rate for the line items.								
	<table border="1"> <thead> <tr> <th>Column Name</th> <th>Column Description</th> </tr> </thead> <tbody> <tr> <td>Rate Type</td> <td>Indicates the rate type that you want to use while defining the rate for the line items.</td> </tr> <tr> <td>Rate</td> <td>Used to specify the rate that you want to use while defining the rate for the line items.</td> </tr> <tr> <td colspan="2"> <p>Note: This field is editable when the Editable checkbox is selected in the Rate column of the Additional Fees section while defining or editing the C1-ExtLookClaimTemplate extendable lookup.</p> </td> </tr> </tbody> </table>	Column Name	Column Description	Rate Type	Indicates the rate type that you want to use while defining the rate for the line items.	Rate	Used to specify the rate that you want to use while defining the rate for the line items.	<p>Note: This field is editable when the Editable checkbox is selected in the Rate column of the Additional Fees section while defining or editing the C1-ExtLookClaimTemplate extendable lookup.</p>	
Column Name	Column Description								
Rate Type	Indicates the rate type that you want to use while defining the rate for the line items.								
Rate	Used to specify the rate that you want to use while defining the rate for the line items.								
<p>Note: This field is editable when the Editable checkbox is selected in the Rate column of the Additional Fees section while defining or editing the C1-ExtLookClaimTemplate extendable lookup.</p>									

- **Characteristics** – Lists the characteristics defined for the claim pricing rule. It contains the following columns:

Column Name	Column Description
Effective Date	Displays the date from when the characteristic is effective for the claim pricing rule.
Characteristic Type	Indicates the characteristic type.
Characteristic Value	Displays the value of the characteristic type.

Related Topics

For more information on...	See...
How to view a claim pricing rule of a parent customer	Viewing a Claim Pricing Rule of a Parent Customer on page 2584
How to view a claim pricing rule of a bill group	Viewing a Claim Pricing Rule of a Bill Group on page 2594

Aggregate Stop-Loss

The **Aggregate Stop-Loss** zone displays the details of the aggregate stop-loss pricing rule for respective parent customer, bill group or a bill group using a pricing group. It contains the following sections:

- **Main** – Displays basic details of the aggregate stop-loss pricing rule. It contains the following fields:

Field Name	Field Description
Parent Customer Information	Displays the parent customer information. In addition, a context menu appears corresponding to this field which helps in navigating to other screens in the application.
	<p>Note:</p> <p>It has a link. On clicking the link, the Person, Account or Policy screen appears where you can view the details of the parent customer.</p> <p>This field appears only when the aggregate stop-loss pricing rule is viewed for parent customer.</p>

Field Name	Field Description
Bill Group Information	Displays the bill group information. In addition, a context menu appears corresponding to this field which helps in navigating to other screens in the application.
	<p>Note:</p> <p>It has a link. On clicking the link, the Person, Account or Policy screen appears where you can view the details of the bill group.</p> <p>This field appears when the aggregate stop-loss pricing rule is viewed for bill group.</p>
Policy Information	Displays the policy information.
	<p>Note:</p> <p>It has a link. On clicking the link, the Policy screen appears where you can view the details of the policy.</p> <p>This field appears when the aggregate stop-loss pricing rule is viewed for bill group.</p>
Pricing Rule Type	Indicates the pricing rule type.
Price Item Information	Indicates the price item information.
	<p>Note: It has a link. On clicking the link, the Price Item screen appears where you can view the details of the price item.</p>
Parent Customer's SSL or ASL Pricing Rules	Displays the pricing date range derived from the parent customer's specific stop-loss or aggregate stop-loss pricing rule.
Pricing Start Date	Displays the pricing rule start date.
Pricing End Date	Displays the pricing rule end date.
Rate Option	Indicates the rate option of the aggregate stop-loss pricing rule for the price item.
Settlement Frequency	<p>Indicates the settlement frequency that helps to determine the bill after date. The valid values are:</p> <ul style="list-style-type: none"> • Immediately • Manually (At Required Intervals) • Monthly • Yearly
	<p>Note: This field appears when the aggregate stop-loss pricing rule is viewed for parent customer.</p>

Field Name	Field Description
Underwriter Review	Indicates whether the underwriter settlement review flag is on or off. The valid values are: <ul style="list-style-type: none"> • Yes • No
	Note: This field appears when the aggregate stop-loss pricing rule is viewed for parent customer.
Pricing Group	Displays the pricing group of the aggregate stop-loss pricing rule.
	Note: This field appears when the aggregate stop-loss pricing rule is viewed for pricing group.

- **Accumulation Parameters** – Lists the accumulation parameters in an aggregate stop-loss pricing rule. It contains the following fields:

Field Name	Field Description
Accumulation Group ID	Displays the accumulation group ID generated when accumulation parameters are defined for a specific stop-loss..
ASL Credit Account	Indicates the account in which the aggregate stop-loss amount is credited.

This section also lists the following columns:

Column Name	Column Description
Incurred Start Date	Displays the incurred start date based on the accumulated specific stop-loss.
Incurred End Date	Displays the incurred end date based on the accumulated specific stop-loss.
ASL Payout Limit	Displays the maximum limit for the specific stop-loss at member or main subscriber level.
Paid Start Date	Displays the paid start date based on the accumulated specific stop-loss.
Paid End Date	Displays the paid end date based on the accumulated specific stop-loss.
Settlement Days	Indicates the settlement days used in calculating the settlement date.
ASL Limit (During Policy Period)	Indicates the aggregate stop-loss limit that was set during the policy period. The valid values are: <ul style="list-style-type: none"> • Policy Based Limit • Enrollment Based Limit • Percentage of Enrollment Based Limit • Enrollment Based or Minimum ASL Limit (Whichever is Greater)
ASL Limit (During Settlement Period)	Indicates the aggregate stop-loss limit that was set during the settlement period. The valid values are: <ul style="list-style-type: none"> • Policy Based Limit • Enrollment Based Limit • Enrollment Based or Minimum ASL Limit (Whichever is Greater)

Column Name	Column Description
Minimum ASL Limit	Displays the minimum ASL limit.
	Note: This field displays value when the Enrollment Based or Minimum ASL Limit (Whichever is Greater) option appears for the ASL Limit (During Policy Period) or ASL Limit (During Settlement Period) field.
Percentage of Enrollment Based Limit	Displays the percentage of enrollment based limit.
	Note: This field displays value when the Percentage of Enrollment Based Limit option appears for the ASL Limit (During Policy Period) field.
Policy Based Limit	Displays the policy based limit.
	Note: This field displays value when the Policy Based Limit option appears for the ASL Limit (During Policy Period) or ASL Limit (During Settlement Period) field.

Note: This section appears when the aggregate stop loss is created for parent customer.

- **Accumulation Criteria** – This section contains the following columns:

Column Name	Column Description						
Accumulation Group ID	Displays the accumulation group ID generated when the accumulation criteria values were defined for a aggregate stop-loss.						
Price Item Information	Displays the price item information.						
	Note: It has a link. On clicking the link, the Price Item screen appears where you can view the details of the price item.						
Price Item Parameters	This field contains the following columns:						
	<table border="1"> <thead> <tr> <th>Column Name</th> <th>Column Description</th> </tr> </thead> <tbody> <tr> <td>Price Item Parameter</td> <td>Displays the multiple parameters based on which you have determined the price item utilization. Note: It has a link. On clicking the link, the Parameter screen appears where you can view the details of the parameter.</td> </tr> <tr> <td>Parameter Value</td> <td>Displays the value of the parameter.</td> </tr> </tbody> </table>	Column Name	Column Description	Price Item Parameter	Displays the multiple parameters based on which you have determined the price item utilization. Note: It has a link. On clicking the link, the Parameter screen appears where you can view the details of the parameter.	Parameter Value	Displays the value of the parameter.
	Column Name	Column Description					
Price Item Parameter	Displays the multiple parameters based on which you have determined the price item utilization. Note: It has a link. On clicking the link, the Parameter screen appears where you can view the details of the parameter.						
Parameter Value	Displays the value of the parameter.						

Note:

This section appears when the aggregate stop-loss is created for a bill group.

Accumulation criteria for each rule appears when the aggregate stop-loss is created for a bill group using a pricing group.

- **Pricing Information** – This section contains the following sub-section:
 - **Claim Pricing Rule** – This sub-section contains the following field:

Field Name	Field Description
Effective Claim Pricing Rule	Indicates the claim pricing rule effective for pricing.

This sub-section contains the following sections:

- **Domestic Provider Claims** – Displays the domestic provider claim while calculating aggregate stop-loss. This section contains the following field:

Field Name	Field Description
Exclude ASL (Percentage)	Displays the domestic provider claim billable charge line excluding the aggregate stop-loss in percentage created for domestic provider claim calculation lines.

- **Markup or Markdown Values** – Displays the markup or markdown values for billable charge line. This section contains the following fields:

Field Name	Field Description	
Pricing Strategy	Indicates the pricing strategy. The valid values are: <ul style="list-style-type: none"> • Markdown • Markup • None 	
Markup or Markdown Type	Indicates the markup or markdown value type for claim line items. The valid values are: <ul style="list-style-type: none"> • Flat Amount • Percentage 	
Markup or Markdown Amount	Displays the markup or markdown amount. <table border="1" data-bbox="743 1266 1474 1350"> <tr> <td>Note: This field displays amount when Markup or Markdown Type field is Flat Amount.</td> </tr> </table>	Note: This field displays amount when Markup or Markdown Type field is Flat Amount .
Note: This field displays amount when Markup or Markdown Type field is Flat Amount .		

- **Line Items** – Displays the associated line items eligible for billing. This section contains the following fields:

Field Name	Field Description
Sequence	Displays the sequence number for the line items.
Line Item	Displays the billing line items.
Eligible for Aggregate Stop-Loss	Displays whether the line item is eligible or not eligible for aggregate stop-loss.
Markup or Markdown Percentage Eligibility	Displays whether the line item is eligible or not eligible for markup or markdown percentage. The valid values are: <ul style="list-style-type: none"> • Eligible • Not Eligible

Field Name	Field Description
Markup or Markdown Percentage	Displays the percentage for markup or markdown value.

Note:

This section appears when the aggregate stop-loss is created for a bill group.

Claim line items for each rule appears when the aggregate stop-loss is created for a bill group using a pricing group.

- **Run-In Parameters** – This section contains the following columns:

Column Name	Column Description
Run-In	Displays whether the run-in parameters of the run-in period of policy are to be considered or not in an aggregate stop-loss pricing
Accumulation Group ID	Displays the accumulation group ID that is generated when the accumulation parameter values were defined for an aggregate stop-loss.
Incurred Start Date	Displays the incurred start date based on the run-in period of the policy in the aggregate stop-loss. Note: This field displays value when the checkbox for the Run-In field is selected.
Incurred End Date	Displays the incurred end date based on the run-in period of the policy in the aggregate stop-loss. Note: This field displays value when the checkbox for the Run-In field is selected.
Paid Start Date	Displays the paid start date based on the run-in period of the policy in the aggregate stop-loss. Note: This field displays value when the checkbox for the Run-In field is selected.
Paid End Date	Displays the paid end date based on the run-in period of the policy in the aggregate stop-loss. Note: This field displays value when the checkbox for the Run-In field is selected.
Run-In Maximum Limit	Displays the maximum limit of the run-in parameters. Note: This field displays value when the checkbox for the Run-In field is selected.

Note: This section appears when the specific stop loss is created for parent customer.

- **Characteristics** – Lists the characteristics defined for the aggregate stop-loss pricing rule. It contains the following columns:

Column Name	Column Description
Effective Date	Displays the date from when the characteristic is effective for the aggregate stop-loss pricing rule.
Characteristic Type	Indicates the characteristic type.
Characteristic Value	Displays the value of the characteristic type.

Related Topics

For more information on...	See...
How to view an aggregate stop-loss pricing rule of a parent customer	Viewing an Aggregate Stop-Loss Pricing Rule of a Parent Customer on page 2654
How to view an aggregate stop-loss pricing rule of a bill group	Viewing an Aggregate Stop-Loss Pricing Rule of a Bill Group on page 2666

Specific Stop-Loss

The **Specific Stop-Loss** zone displays the details of the specific stop-loss pricing rule for respective parent customer, bill group or a bill group using a pricing group. It contains the following sections:

- **Main** – Displays basic details of the specific stop-loss pricing rule. It contains the following fields:

Field Name	Field Description
Parent Customer Information	Displays the parent customer information. In addition, a context menu appears corresponding to this field which helps in navigating to other screens in the application.
	<p>Note:</p> <p>It has a link. On clicking the link, the Person, Account or Policy screen appears where you can view the details of the parent customer.</p> <p>This field appears only when the specific stop-loss pricing rule is viewed for parent customer.</p>
Bill Group Information	Displays the bill group information. In addition, a context menu appears corresponding to this field which helps in navigating to other screens in the application.
	<p>Note:</p> <p>It has a link. On clicking the link, the Person, Account or Policy screen appears where you can view the details of the bill group.</p> <p>This field appears when the specific stop-loss pricing rule is viewed for bill group.</p>
Policy Information	Displays the policy information.
	<p>Note:</p> <p>It has a link. On clicking the link, the Policy screen appears where you can view the details of the policy.</p> <p>This field appears when the specific stop-loss pricing rule is viewed for parent customer.</p>
Pricing Rule Type	Indicates the pricing rule type.
Price Item Information	Indicates the price item information.
	<p>Note: It has a link. On clicking the link, the Price Item screen appears where you can view the details of the price item.</p>

Field Name	Field Description
Parent Customer's SSL Pricing Rule	Displays the pricing date range derived from the parent customer's specific stop-loss pricing rule.
	Note: This field appears when the specific stop-loss pricing rule is viewed for bill group.
Pricing Start Date	Displays the specific stop-loss pricing rule start date.
Pricing End Date	Displays the specific stop-loss pricing rule end date.
Rate Option	Indicates the rate option of the specific stop-loss pricing rule for the price item.
Pricing Rule Usage	Indicates whether the pricing rule is used only for pricing or for pricing and billing. The valid values are: <ul style="list-style-type: none"> • Pricing • Pricing and Billing
	Note: This field appears when the specific stop-loss pricing rule is viewed for parent customer.
Accumulation Level	Indicate whether the specific stop-loss is accumulated at the member or main subscriber level. The valid values are: <ul style="list-style-type: none"> • Member • Main Subscriber
	Note: This field appears when the specific stop-loss pricing rule is viewed for parent customer.
Settlement Frequency	Indicates the settlement frequency that helps to determine the bill after date. The valid values are: <ul style="list-style-type: none"> • Immediately • Manually (At Required Intervals) • Never • Yearly
	Note: This field appears when the specific stop-loss pricing rule is viewed for parent customer.
Underwriter Review	Indicates whether the underwriter settlement review flag is on or off. The valid values are: <ul style="list-style-type: none"> • Yes • No
	Note: This field appears when the specific stop-loss pricing rule is viewed for parent customer.
Pricing Group	Displays the pricing group of the specific stop-loss pricing rule.
	Note: This field appears when the specific stop-loss pricing rule is viewed for pricing group.

- **Accumulation Parameters** – Lists the accumulation parameters in a specific stop-loss pricing rule. It contains the following field:

Field Name	Field Description
Accumulation Group ID	Displays the accumulation group ID generated when accumulation parameters are defined for a specific stop-loss..

This section also lists the following columns:

Column Name	Column Description
Incurred Start Date	Displays the incurred start date based on the accumulated specific stop-loss.
Incurred End Date	Displays the incurred end date based on the accumulated specific stop-loss.
SSL Payout Limit	Displays the maximum limit for the specific stop-loss at member or main subscriber level.
Paid Start Date	Displays the paid start date based on the accumulated specific stop-loss.
Paid End Date	Displays the paid end date based on the accumulated specific stop-loss.
Settlement Days	Indicates the settlement days used in calculating the settlement date.
Compute Aggregate SSL (ASL)	Indicates whether the aggregate specific stop-loss (ASSL) is calculated or not during the C1-BCSSL batch run for each bill group. The valid values are: <ul style="list-style-type: none"> • Yes • No
ASSL Credit Account	Indicates that the aggregate specific stop-loss amount beyond the ASL limit paid by the insurance company to the ASL credit account.
ASSL Limit	

Note: This section appears when the specific stop loss is created for parent customer.

- **Accumulation Criteria** – This section contains the following columns:

Column Name	Column Description
Accumulation Group ID	Displays the accumulation group ID generated when the accumulation criteria values were defined for a specific stop-loss.
Run-In Maximum Limit	Displays the maximum specific stop-loss limit defined for the member when the claim transactions were received in the run-in period of the policy.
SSL Limit	Displays whether the SSL limit indicating the specific stop-loss amount beyond this limit is paid by the insurance company.
Price Item Information	Displays the price item information. <p>Note: It has a link. On clicking the link, the Price Item screen appears where you can view the details of the price item.</p>

Column Name	Column Description						
Price Item Parameters	This field contains the following columns:						
	<table border="1"> <thead> <tr> <th>Column Name</th> <th>Column Description</th> </tr> </thead> <tbody> <tr> <td>Price Item Parameter</td> <td>Displays the multiple parameters based on which you have determined the price item utilization. Note: It has a link. On clicking the link, the Parameter screen appears where you can view the details of the parameter.</td> </tr> <tr> <td>Parameter Value</td> <td>Displays the value of the parameter.</td> </tr> </tbody> </table>	Column Name	Column Description	Price Item Parameter	Displays the multiple parameters based on which you have determined the price item utilization. Note: It has a link. On clicking the link, the Parameter screen appears where you can view the details of the parameter.	Parameter Value	Displays the value of the parameter.
	Column Name	Column Description					
Price Item Parameter	Displays the multiple parameters based on which you have determined the price item utilization. Note: It has a link. On clicking the link, the Parameter screen appears where you can view the details of the parameter.						
Parameter Value	Displays the value of the parameter.						
Parameter Value	Displays the value of the parameter.						

Note:

This section appears when the specific stop-loss is created for a bill group.

Accumulation criteria for each rule appears when the specific stop-loss is created for a bill group using a pricing group.

- **Pricing Information** – This section contains the following sub-section:
 - **Claim Pricing Rule** – This sub-section contains the following field:

Field Name	Field Description
Effective Claim Pricing Rule	Indicates the claim pricing rule effective for pricing.

This sub-section contains the following sections:

- **Domestic Provider Claims** – Displays the domestic provider claim while calculating specific stop-loss. This section contains the following field:

Field Name	Field Description
Exclude SSL (Percentage)	Displays the domestic provider claim billable charge line excluding the specific stop-loss in percentage created for domestic provider claim calculation lines.

- **Markup or Markdown Values** – Displays the markup or markdown values for billable charge line. This section contains the following fields:

Field Name	Field Description
Pricing Strategy	Indicates the pricing strategy. The valid values are: <ul style="list-style-type: none"> • Markdown • Markup • None
Markup or Markdown Type	Indicates the markup or markdown value type for claim line items. The valid values are: <ul style="list-style-type: none"> • Flat Amount • Percentage

Field Name	Field Description
Markup or Markdown Amount	Displays the markup or markdown amount.
	Note: This field displays amount when Markup or Markdown Type field is Flat Amount .

- **Line Items** – Displays the associated line items eligible for billing. This section contains the following fields:

Field Name	Field Description
Sequence	Displays the sequence number for the line items.
Line Item	Displays the billing line items.
Eligible for Specific Stop-Loss	Displays whether the line item is eligible or not eligible for specific stop-loss.
Markup or Markdown Percentage Eligibility	Displays whether the line item is eligible or not eligible for markup or markdown percentage. The valid values are: <ul style="list-style-type: none"> • Eligible • Not Eligible
Markup or Markdown Percentage	Displays the percentage for markup or markdown value.

Note:

This section appears when the specific stop-loss is created for a bill group.

Claim line items for each rule appears when the specific stop-loss is created for a bill group using a pricing group.

- **Run-In Parameters** – This section contains the following columns:

Column Name	Column Description
Run-In	Displays whether the run-in parameters of the run-in period of policy are to be considered or not in a specific stop-loss pricing
Incurred Start Date	Displays the incurred start date based on the run-in period of the policy in the specific stop-loss.
Incurred End Date	Displays the incurred end date based on the run-in period of the policy in the specific stop-loss.
Paid Start Date	Displays the paid start date based on the run-in period of the policy in the specific stop-loss.
Paid End Date	Displays the paid end date based on the run-in period of the policy in the specific stop-loss.

Note: This section appears when the specific stop loss is created for parent customer.

- **Lasering and Exclusion** – Lists the lasering and exclusion information in a specific stop-loss pricing rule. It contains the following columns:

Column Name	Column Description
Accumulation Group ID	Displays the accumulation group ID generated when the accumulation parameter values were defined for the specific stop-loss.
Level Identifier	Displays the lasering or exclusion level identifier.
Lasering or Exclusion Level	Indicates the lasering or exclusion level of the specific stop-loss. The valid values are: <ul style="list-style-type: none"> • Main Subscriber • Member • Provider
Exception Type	Indicates the exception type. The valid values are: <ul style="list-style-type: none"> • Lasering • Exclusion
Comments	Displays the comments.
Lasered Amount	Displays the lasered amount.

Note: This section appears when the specific stop loss is created for parent customer.

- **Characteristics** – Lists the characteristics defined for the specific stop-loss pricing rule. It contains the following columns:

Column Name	Column Description
Effective Date	Displays the date from when the characteristic is effective for the specific stop-loss pricing rule.
Characteristic Type	Indicates the characteristic type.
Characteristic Value	Displays the value of the characteristic type.

Related Topics

For more information on...	See...
How to view a specific stop-loss pricing rule of a parent customer	Viewing a Specific Stop-Loss Pricing Rule of a Parent Customer on page 2618
How to view a specific stop-loss pricing rule of a bill group	Viewing a Specific Stop-Loss Pricing Rule of a Bill Group on page 2630

Retention Type Claim Based

The **Retention Type Claim Based** zone displays the details of the Retention Type Claim Based Pricing Rule. This zone contains the following sections:

- **Main** – This section provides basic information about the retention type claim based pricing rule type. It contains the following fields:

Field Name	Field Description
Parent Customer Information	<p>Displays the parent customer information. In addition, a context menu appears corresponding to this field which helps in navigating to other screens in the application.</p> <p>Note:</p> <p>It has a link. On clicking the link, the Person screen appears where you can view the details of the parent customer.</p> <p>This field appears when the retention type claim based pricing rule is viewed for parent customer.</p>
Pricing Rule Type	Displays the pricing rule type.
Price Item Information	<p>Displays the price item.</p> <p>Note: It has a link. On clicking the link, the Price Item screen appears where you can view the details of the price item.</p>
Rate Option	Displays the rate option of the retention type claim based pricing rule.
Pricing Start Date	Displays the date from when the pricing is effective for retention type claim based pricing rule.
Pricing End Date	Displays the date till when the pricing is effective for retention type claim based pricing rule.

- **Parameters** – This section lists the parameters which are defined for retention type claim based pricing rule. It contains the following columns:

Column Name	Column Description										
Price Item Parameters	<p>Displays the parameter item information for retention type claim based pricing rule.</p> <table border="1"> <thead> <tr> <th>Column Name</th> <th>Column Description</th> </tr> </thead> <tbody> <tr> <td>Price Item Parameters</td> <td>Displays multiple parameters based on which you have determined the price item utilization.</td> </tr> <tr> <td>Parameter Description</td> <td>Displays the description of the parameter.</td> </tr> <tr> <td>Parameter Value</td> <td>Displays the value of the parameter.</td> </tr> <tr> <td>Parameter Value Description</td> <td>Displays the description of the value, defined as a parameter.</td> </tr> </tbody> </table>	Column Name	Column Description	Price Item Parameters	Displays multiple parameters based on which you have determined the price item utilization.	Parameter Description	Displays the description of the parameter.	Parameter Value	Displays the value of the parameter.	Parameter Value Description	Displays the description of the value, defined as a parameter.
Column Name	Column Description										
Price Item Parameters	Displays multiple parameters based on which you have determined the price item utilization.										
Parameter Description	Displays the description of the parameter.										
Parameter Value	Displays the value of the parameter.										
Parameter Value Description	Displays the description of the value, defined as a parameter.										
Fee	Displays the fee that is applicable for which price item parameters are defined.										

- **Characteristics** – This section displays the pricing rule type characteristics. It contains the following columns:

Column Name	Column Description
Effective Date	Displays the date from when the characteristics are effective.
Characteristic Type	Displays the characteristic type.
Characteristic Value	Displays the value for the characteristic type.

Related Topics

For more information on...	See...
Pricing Rule Type screen	Pricing Rule Type on page 2532
Pricing Rule Type zone	Pricing Rule Type on page 2536

Retention Type Enrollment Based

The **Retention Type Enrollment Based** zone displays the details of the Retention Type Enrollment Based Pricing Rule. This zone contains the following sections:

- **Main** – This section provides basic information about the retention type claim based pricing rule type. It contains the following fields:

Field Name	Field Description
Parent Customer Information	<p>Displays the parent customer information. In addition, a context menu appears corresponding to this field which helps in navigating to other screens in the application.</p> <p>Note: It has a link. On clicking the link, the Person screen appears where you can view the details of the parent customer. This field appears when the retention type enrollment based pricing rule is viewed for parent customer.</p>
Pricing Rule Type	Displays the pricing rule type.
Price Item Information	<p>Displays the price item.</p> <p>Note: It has a link. On clicking the link, the Price Item screen appears where you can view the details of the price item.</p>
Rate Option	Displays the rate option of the retention type enrollment based pricing rule.
Pricing Start Date	Displays the date from when the pricing is effective for retention type enrollment based pricing rule.
Pricing End Date	Displays the date till when the pricing is effective for retention type enrollment based pricing rule.
Exempt Retro Transactions	Indicates whether retro transactions should be a part of retention type enrollment based pricing rule.

- **Parameters** – This section lists the parameters which are defined for retention type enrollment based pricing rule. It contains the following columns:

Column Name	Column Description										
Price Item Parameters	Displays the parameter item information for retention type enrollment based pricing rule.										
	<table border="1"> <thead> <tr> <th>Column Name</th> <th>Column Description</th> </tr> </thead> <tbody> <tr> <td>Price Item Parameters</td> <td>Displays multiple parameters based on which you have determined the price item utilization.</td> </tr> <tr> <td>Parameter Description</td> <td>Displays the description of the parameter.</td> </tr> <tr> <td>Parameter Value</td> <td>Displays the value of the parameter.</td> </tr> <tr> <td>Parameter Value Description</td> <td>Displays the description of the value, defined as a parameter.</td> </tr> </tbody> </table>	Column Name	Column Description	Price Item Parameters	Displays multiple parameters based on which you have determined the price item utilization.	Parameter Description	Displays the description of the parameter.	Parameter Value	Displays the value of the parameter.	Parameter Value Description	Displays the description of the value, defined as a parameter.
	Column Name	Column Description									
	Price Item Parameters	Displays multiple parameters based on which you have determined the price item utilization.									
	Parameter Description	Displays the description of the parameter.									
Parameter Value	Displays the value of the parameter.										
Parameter Value Description	Displays the description of the value, defined as a parameter.										
Fee	Displays the fee that is applicable for which price item parameters are defined.										

- **Characteristics** – This section displays the pricing rule type characteristics. It contains the following columns:

Column Name	Column Description
Effective Date	Displays the date from when the characteristics are effective.
Characteristic Type	Displays the characteristic type.
Characteristic Value	Displays the value for the characteristic type.

Related Topics

For more information on...	See...
Pricing Rule Type screen	Pricing Rule Type on page 2532
Pricing Rule Type zone	Pricing Rule Type on page 2536

Flat Fee

The **Flat Fee** zone displays the details of the one-time, bill period, and frequency based recurring flat fee pricing rule for bill group. It contains the following sections:

- **Main** – Displays basic details of the one-time, bill period, and frequency based recurring flat fee pricing rule. It contains the following fields:

Field Name	Field Description
Bill Group Information	Displays the bill group information. In addition, a context menu appears corresponding to this field which helps in navigating to other screens in the application.
	Note: It has a link. On clicking the link, the Person, Account or Policy screen appears where you can view the details of the bill group.
Policy Information	Displays the policy information.
	Note: It has a link. On clicking the link, the Policy screen appears where you can view the details of the policy.

Field Name	Field Description
Price Item Information	Indicates the price item information.
	Note: It has a link. On clicking the link, the Price Item screen appears where you can view the details of the price item.
Charge Date	Displays the flat fee charge date.
	Note: This field appears only for the one-time flat fee pricing rule for bill group.
Charge Start Date	Displays the flat fee charge start date.
	Note: This field appears only for both bill period and frequency based recurring flat fee pricing rule for bill group.
Charge End Date	Displays the flat fee charge end date.
	Note: This field appears only for both bill period and frequency based recurring flat fee pricing rule for bill group.
Bill To Account Override	Displays the account to which the bill is override. In addition, a context menu appears corresponding to this field which helps in navigating to other screens in the application.
	Note: It has a link. On clicking the link, the Account screen appears where you can view the details of the account.
Billable Charge Line Type	Displays the billable charge line type.
Fee	Displays the amount of flat fee.
	Note: This field appears when a value is displayed in the Billable Charge Line Type field.
Bill Period	Indicates the bill period for flat fee.
	Note: This field appears only for the bill period based recurring flat fee pricing rule for bill group.
Frequency	Indicates the frequency for flat fee.
	Note: This field appears only for the frequency based recurring flat fee pricing rule for bill group.
Billable Charge Information	Displays the billable charge information.
	Note: It has a link. On clicking the link, the Bill Charge ID screen appears where you can view the details of the billable charge.

- **Characteristics** – Lists the characteristics defined for the one-time, bill period, and frequency based recurring flat fee pricing rule. It contains the following columns:

Column Name	Column Description
Effective Date	Displays the date from when the characteristic is effective for the one-time, bill period, and frequency based recurring flat fee pricing rule.
Characteristic Type	Indicates the characteristic type.
Characteristic Value	Displays the value of the characteristic type.

Related Topics

For more information on...	See...
How to view a one-time flat fee pricing rule of a bill group	Viewing a One-Time Flat Fee Pricing Rule of a Bill Group on page 2740
How to view a bill period based recurring flat fee pricing rule of a bill group	Viewing a Bill Period Based Recurring Flat Fee Pricing Rule of a Bill Group on page 2755
How to view a frequency based recurring flat fee pricing rule of a bill group	Viewing a Frequency Based Recurring Flat Fee Pricing Rule of a Bill Group on page 2770

Ancillary

The **Ancillary** zone displays the details of the ancillary pricing rule for the respective parent customer, bill group, or a bill group using a pricing group. It contains the following sections:

- **Main** – Displays basic details of the ancillary pricing rule. It contains the following fields:

Field Name	Field Description	Mandatory (Yes or No)
Parent Customer Information	<p>Displays the parent customer information. In addition, a context menu appears corresponding to this field which helps in navigating to other screens in the application.</p> <p>Note: It has a link. On clicking the link, the Person, Account or Policy screen appears where you can view the details of the parent customer.</p>	Not applicable
Bill Group Information	<p>Displays the bill group information. In addition, a context menu appears corresponding to this field which helps in navigating to other screens in the application.</p> <p>Note: It has a link. On clicking the link, the Person, Account or Policy screen appears where you can view the details of the bill group.</p>	Not applicable
Policy Information	<p>Displays the policy information.</p> <p>Note: It has a link. On clicking the link, the Policy screen appears where you can view the details of the policy.</p>	Not applicable

Field Name	Field Description	Mandatory (Yes or No)
Pricing Rule Type	Indicates the type of the pricing rule.	Not applicable
Status	Indicates the status of the pricing rule.	Not applicable
Price Item Information	Indicates the price item information.	Not applicable
	Note: It has a link. On clicking the link, the Price Item screen appears where you can view the details of the price item.	
Pricing Start Date	Displays the date from when the pricing rule is effective.	Not applicable
Pricing End Date	Displays the date till when the pricing rule is effective.	Not applicable
Rate Option	Indicates the rate option of the ancillary pricing rule for the price item.	Not applicable
Pass Through without Markup or Markdown	Indicates that markup or markdown should not be calculated for the ancillary charge.	Not applicable

- **Ancillary Charges** – Lists the accumulation parameters in an aggregate stop-loss pricing rule. It contains the following fields:

Field Name	Field Description	Mandatory (Yes or No)
Billable Charge Line Type	Indicates the billable charge line type using which the ancillary pricing rule type is created.	Not applicable
	Note: It has a link. On clicking the link, the Billable Charge Line Type screen appears where you can view the details of the billable charge line type.	
Billable	Indicates whether the ancillary billable charge is eligible for billing or not.	Not applicable
Rate Based	Indicates whether the ancillary charge is calculated using a particular rate or not.	Not applicable
Rate	Indicates the rate for calculating the ancillary charge.	Not applicable
Pricing Strategy	Indicates the price calculation strategy that is applied while defining the ancillary pricing rule.	Not applicable
Markup or Markdown Type	Indicates the type of charge that is applied while defining the ancillary pricing rule.	Not applicable
Amount / Percentage	Displays the actual proportion of the charge that is applied while defining the ancillary pricing rule.	Not applicable

- **Characteristics** – Lists the characteristics defined for the aggregate stop-loss pricing rule. It contains the following columns:

Column Name	Column Description
Effective Date	Displays the date from when the characteristic is effective for the ancillary pricing rule.
Characteristic Type	Indicates the characteristic type.

Column Name	Column Description
Characteristic Value	Displays the value of the characteristic type.

Related Topics

For more information on...	See...
How to view an ancillary pricing rule of a parent customer	Viewing an Ancillary Pricing Rule of a Parent Customer
How to view an ancillary pricing rule of a bill group	Viewing an Ancillary Pricing Rule of a Bill Group

Discount Arrangement

The **Discount Arrangement** zone displays the details of the discount arrangement pricing rule for the respective parent customer, bill group, or a bill group using a pricing group. It contains the following sections:

- **Main** – Displays basic details of the discount arrangement pricing rule. It contains the following fields:

Field Name	Field Description	Mandatory (Yes or No)
Parent Customer Information	<p>Displays the parent customer information. In addition, a context menu appears corresponding to this field which helps in navigating to other screens in the application.</p> <p>Note: It has a link. On clicking the link, the Person, Account or Policy screen appears where you can view the details of the parent customer.</p>	Not applicable
Bill Group Information	<p>Displays the bill group information. In addition, a context menu appears corresponding to this field which helps in navigating to other screens in the application.</p> <p>Note: It has a link. On clicking the link, the Person, Account or Policy screen appears where you can view the details of the bill group.</p>	Not applicable
Policy Information	<p>Displays the policy information.</p> <p>Note: It has a link. On clicking the link, the Policy screen appears where you can view the details of the policy.</p>	Not applicable
Pricing Rule Type	Indicates the type of the pricing rule.	Not applicable
Status	Indicates the status of the pricing rule.	Not applicable

Field Name	Field Description	Mandatory (Yes or No)
Price Item Information	Indicates the price item for which the pricing rule is created.	Not applicable
	Note: It has a link. On clicking the link, the Price Item screen appears where you can view the details of the price item.	
Rate Option	Indicates the rate option of the discount arrangement pricing rule for the price item.	Not applicable
Pricing Start Date	Displays the date from when the pricing rule is effective.	Not applicable
Pricing End Date	Displays the date till when the pricing rule is effective.	Not applicable
Settlement Frequency	Indicates the settlement frequency which helps to determine the bill after date.	Not applicable

- **Discount Details** – Displays the eligibility criteria for a discount percentage and maximum discount amount that is allowed per claim. It contains the following fields:

Field Name	Field Description	Mandatory (Yes or No)
Price Item Parameter	Displays the parameter using which an eligibility criteria is defined for a discount percentage and maximum amount that is allowed per claim.	Not applicable
Parameter Information	Indicates the order in which the parameter and its value should be displayed in the price item parameter information string across the application.	Not applicable
Parameter Value	Indicates the value of the parameter.	Not applicable
Parameter Value Description	Displays the description of the value, defined as a parameter.	Not applicable
Discount Percentage	Displays the discount share or discount guarantee percentage.	Not applicable
Maximum Discount Per Claim	Displays maximum discount amount which is allowed per claim. If the discount amount exceeds the maximum limit per claim, the additional amount is credited to the customer.	Not applicable

- **Discount Limits** – Displays the minimum and maximum discount limit defined on the contract. It contains the following fields:

Field Name	Field Description	Mandatory (Yes or No)
No Limit	Indicates the type of discount limit (minimum or maximum) on the contract.	Not applicable
Discount Credit Account	Indicates the account to which the discount is credited, when the minimum or maximum discount limit is defined on the contract.	Not applicable
Settlement Days	Indicates the number of days which help in calculating the final settlement date.	Not applicable

In addition, it contains the following fields in a grid:

Field Name	Field Description	Mandatory (Yes or No)
Type of Discount	Displays the type of discount.	Not applicable
Select	Indicates the type of discount that is applied on the contract.	Not applicable
Limit Type	Indicates the type of limit defined in the discount arrangement pricing rule.	Not applicable
Amount Limit	Indicates the amount limit (flat minimum or maximum discount) on the contract.	Not applicable

- **Exclusion** – Displays the entity (network or provider) which is excluded in the discount arrangement pricing rule. It contains the following fields:

Field Name	Field Description	Mandatory (Yes or No)
Exclusion Level	Indicates the entity (network hospitals or providers) that are excluded during the discount share or discount guarantee calculation.	Not applicable
Level Identifier	Displays the network or provider ID.	Not applicable

- **Characteristics** – Displays the characteristics defined for the discount arrangement pricing rule. It contains the following columns:

Column Name	Column Description	Mandatory (Yes or No)
Effective Date	Displays the date from when the characteristic is effective for the discount arrangement pricing rule.	Not applicable
Characteristic Type	Indicates the characteristic type.	Not applicable
Characteristic Value	Displays the value of the characteristic type.	Not applicable

Related Topics

For more information on...	See...
How to define a discount arrangement pricing rule for a parent customer	Defining a Discount Arrangement Pricing Rule for a Parent Customer on page 2842

Level Funded

The **Level Funded** zone displays the details of the level funded pricing rule for the respective parent customer, bill group, or a bill group using a pricing group. It contains the following sections:

- **Main** – Displays basic details of the level funded pricing rule. It contains the following columns:

Column Name	Column Description
Parent Customer Information	Displays the parent customer information. In addition, a context menu appears corresponding to this field which helps in navigating to other screens in the application.
	<p>Note:</p> <p>It has a link. On clicking the link, the Person, Account or Policy screen appears where you can view the details of the parent customer.</p>
Bill Group Information	Displays the bill group information. In addition, a context menu appears corresponding to this field which helps in navigating to other screens in the application.
	<p>Note:</p> <p>It has a link. On clicking the link, the Person, Account or Policy screen appears where you can view the details of the bill group.</p>
Policy Information	Displays the policy information.
	<p>Note:</p> <p>It has a link. On clicking the link, the Policy screen appears where you can view the details of the policy.</p>
Pricing Rule Type	Indicates the type of the pricing rule.
Status	Indicates the status of the pricing rule.
Price Item Information	Indicates the price item for which the pricing rule is created.
	<p>Note: It has a link. On clicking the link, the Price Item screen appears where you can view the details of the price item.</p>
Parent Customer's Pricing Rule	Displays the pricing rule of the parent customer.
Pricing Start Date	Displays the date from when the pricing rule is effective.
Pricing End Date	Displays the date till when the pricing rule is effective.
Rate Option	Indicates the rate option of the level funded pricing rule for the price item.
Settlement Frequency	Indicates the settlement frequency which helps to determine the bill after date.
Settlement Fund Price Item	Indicates the price item derived from the level funded pricing rule type, used to create the level funded pricing rule type.
	<p>Note: The settlement fund price item appears when the level funded pricing rule is created for a bill group.</p>
Underwriter Review	Indicates whether the underwriter settlement review flag is on or off.

- **Accumulation Parameters** – Displays the accumulation parameters for a parent customer in the level funded pricing rule. It contains the following fields:

Column Name	Column Description
Accumulation Group ID	Displays an accumulation group ID which is generated when accumulation parameter values are defined for a level funded pricing rule.
Settlement Account ID	Indicates the account ID to whom the settlement amount is credited.
Incurred Start Date	Displays the incurred start date (inherited from parent customer's specific stop-loss pricing rule) based on which you want to accumulate the level funded pricing.
Incurred End Date	Displays the incurred end date (inherited from parent customer's specific stop-loss pricing rule) based on which you want to accumulate the level funded pricing.
Paid Start Date	Displays the paid start date (inherited from parent customer's specific stop-loss pricing rule) based on which you want to accumulate the level funded pricing.
Paid End Date	Displays the paid end date (inherited from parent customer's specific stop-loss pricing rule) based on which you want to accumulate the level funded pricing.
Settlement Days	Indicates the number of days as the settlement days which help in calculating the settlement date.

Note:

The above section appears when the level funded pricing rule is created for a parent customer.

- **Accumulation Criteria** – Displays the accumulation criteria for a bill group in the level funded pricing rule. It contains the following columns:

Column Name	Column Description						
Accumulation Group ID	Displays the accumulation group ID generated when the accumulation criteria values were defined for a level funding pricing rule type.						
Price Item Information	Displays the price item information. Note: It has a link. On clicking the link, the Price Item screen appears where you can view the details of the price item.						
Price Item Parameters	This field contains the following columns: <table border="1" data-bbox="592 1333 1461 1659"> <thead> <tr> <th>Column Name</th> <th>Column Description</th> </tr> </thead> <tbody> <tr> <td>Price Item Parameter</td> <td>Displays the multiple parameters based on which you have determined the price item utilization. Note: It has a link. On clicking the link, the Parameter screen appears where you can view the details of the parameter.</td> </tr> <tr> <td>Parameter Value</td> <td>Displays the value of the parameter.</td> </tr> </tbody> </table>	Column Name	Column Description	Price Item Parameter	Displays the multiple parameters based on which you have determined the price item utilization. Note: It has a link. On clicking the link, the Parameter screen appears where you can view the details of the parameter.	Parameter Value	Displays the value of the parameter.
Column Name	Column Description						
Price Item Parameter	Displays the multiple parameters based on which you have determined the price item utilization. Note: It has a link. On clicking the link, the Parameter screen appears where you can view the details of the parameter.						
Parameter Value	Displays the value of the parameter.						

Note:

The above section appears when the level funded pricing rule is created for a bill group.

The accumulation criteria for each rule appears when the level funded pricing rule is created for a bill group using a pricing group.

- The **Pricing Information for rule type category : Claim** zone contains the following sections:
 - The **Claim Pricing Rule** section contains the following columns:

Column Name	Column Description
Pricing Rule Type	Indicates the claim pricing rule type effective for the level funded pricing.
Derive Using	Indicates the method through which the claim pricing rule information is derived.
Effective Claim Pricing Rule	Displays the claim pricing rule effective for pricing.

- The **Domestic Provider Claims** section contains the following columns:

Column Name	Column Description
Exclude LF (Percentage)	Displays the billable charge line excluding the level funding charge in the percentage to create the domestic provider claim calculation lines.

- The **Markup or Markdown Values** section contains the following columns:

Column Name	Column Description
Pricing Strategy	Indicates the pricing strategy for the claim line items.
Markup or Markdown Type	Indicates the markup or markdown value type for the claim line items.
Markup or Markdown Amount	Displays the markup or markdown amount for the claim line items.
	Note: This field displays amount when Markup or Markdown Type field is set as Flat Amount .
Markup / Markdown Included in Settlement?	Displays whether the markup or markdown amount should be included in the level funding settlement. The valid values are:

- The **Line Items** section contains the following columns:

Column Name	Column Description
Sequence	Displays the sequence number for the line items.
Line Item	Displays the billing line items.
Include in Settlement	Indicates whether the line item should be included in the level funded claim pricing settlement.
Markup or Markdown Included in Settlement	Indicates whether markup or markdown should be included in the level funded claim settlement.
Markup or Markdown Percentage Eligibility	Indicates whether the line item is eligible or not eligible for markup or markdown percentage.
Markup or Markdown Percentage	Indicates the percentage for markup or markdown value.

Note:

The above section appears when the level funded pricing rule is created for a bill group.

- The **Pricing Information for rule type category : Ancillary** zone contains the following sections:

- The **Ancillary Pricing Rule** section contains the following columns:

Column Name	Column Description
Pricing Rule Type	Indicates the ancillary pricing rule type effective for level funded pricing.
Derive Using	Indicates the method through which the ancillary pricing rule information is derived.
Effective Ancillary Pricing Rule	Displays the ancillary pricing rule effective for pricing.

- The **Billable Charge Line Types** section contains the following columns:

Column Name	Column Description
Sequence	Displays the sequence number for the line items.
Billable Charge Line Type	Indicates the billable charge line type using which you want to create the calculation line for the charge (i.e. line item)
Include in Settlement	Indicates whether the billable charge line item should be included in the level funded ancillary pricing settlement.
Rate Based	Indicates that the billable charge line type is rate based.
Rate	Displays the rate for the billable charge line type.
Markup / Markdown Included in Settlement?	Indicates that markup or markdown amount must be included in the level funding settlement.
Pricing Strategy	Displays the pricing strategy for the billable charge line items.
Markup or Markdown Type	Indicates the markup or markdown type for the billable charge line items.
Amount/Percentage	Displays the amount or percentage which is specified as the markup or markdown value.

Note:

The above section appears when the level funded pricing rule is created for a bill group.

- The **Pricing Information for rule type category : Discount** zone contains the following section:

Column Name	Column Description
Pricing Rule Type	Indicates the discount arrangement pricing rule type which is effective for level funding.
Derive Using	Indicates the method through which the discount arrangement pricing rule information is derived.

- Discount Pricing Rule** - Indicates the discount arrangement pricing rule. It contains the following columns:

Column Name	Column Description
Discount Pricing Rule	Indicates the discount arrangement pricing rule which is effective for level funding.

Note:

The above section appears when the level funded pricing rule is created for a bill group.

- The **Pricing Information for rule type category : Retention** zone contains the following section:

Column Name	Column Description
Retention Rule Type	Indicates the retention type claim based and/or retention type enrollment based pricing rule type for the level funded pricing rule. Note: It has a link. On clicking the link, Pricing Rule Type screen appears where you can view the details of the rule type.
Price Item	Indicates the price item for the level funded pricing rule. Note: It has a link. On clicking the link, Price Item screen appears where you can view the details of the price item.

Note:

The above section appears when the level funded pricing rule is created for a bill group.

- Final Settlement Rules** – Displays the final settlement rules when the customer renews or cancels the contract. It contains the following columns:

Column Name	Column Description
Final Settlement Mode	Displays the final settlement mode when the customer renews the level funded agreement
Final Settlement Option	Indicates the final settlement option when the customer renews the level funded agreement.
Flat/Percentage	Indicates the final settlement payment type when the customer renews the level funded agreement.
Percentage Retained	Displays the percentage retained by the ASO provider when the customer renews the level funded agreement.
Flat Effective Payout	Displays the actual amount which should be retained by the ASO provider or offered as a discount, when the customer renews the level funded agreement.

The **Renewal Decision** sub-section contains the following columns:

Column Name	Column Description
Renewal Decision	Indicates the upcoming status of the level funded contract.

- Characteristics** – Displays the characteristics defined for the level funded pricing rule. It contains the following columns:

Column Name	Column Description
Effective Date	Displays the date from when the characteristic is effective for the level funded pricing rule.
Characteristic Type	Indicates the characteristic type.

Column Name	Column Description
Characteristic Value	Displays the value of the characteristic type.

Related Topics

For more information on...	See...
How to define a level funded pricing rule for a parent customer	Defining a Level Funded Pricing Rule for a Parent Customer on page 2875

Age Based Pricing Rule

The **Age Based Pricing Rule** zone displays the details of the age based pricing rule for the fully-insured group customer (who is a parent customer, bill group, or a bill group's account) using a pricing group. It contains the following sections:

- **Pricing Information** – Displays basic details about the fully-insured age based pricing rule. It contains the following fields:

Column Name	Column Description
Plan Number	Displays the plan number.
Plan Name	Displays the plan name.
Plan Start Date	Displays the date from when the plan is effective.
Plan End Date	Displays the date till when the plan rule is effective.
Policy Information	Displays the policy information. Note: It has a link. On clicking the link, the Policy screen appears where you can view the details of the policy.
Pricing Rule Type	Indicates the type of the pricing rule.
Price Item Information	Indicates the price item for which the pricing rule is created. Note: It has a link. On clicking the link, the Price Item screen appears where you can view the details of the price item.
Pricing Start Date	Displays the date from when the pricing rule is effective.
Pricing End Date	Displays the date till when the pricing rule is effective.
Rate Option	Indicates the rate option which is used while defining the pricing for the price item.
Modifier Applicability	Indicates modifier based on which additional charge or discount is offered to an eligible member.
Modifier Method	Indicates the method used when modifier applicability option is selected.

- **Pricing Parameters** – Displays the pricing parameter information for a fully-insured age based pricing rule. It contains the following fields:

Column Name	Column Description											
Pricing Parameters	Displays the pricing and parameter details for a fully-insured age based pricing rule. It contains the following columns: <table border="1" data-bbox="578 296 1463 642"> <thead> <tr> <th>Column Name</th> <th>Column Description</th> </tr> </thead> <tbody> <tr> <td>Price Item Parameter</td> <td>Displays the parameter using which an age based eligibility criteria is defined.</td> </tr> <tr> <td>Parameter Description</td> <td>Displays the description of the price item parameter.</td> </tr> <tr> <td>Parameter Value</td> <td>Displays the value of the parameter.</td> </tr> <tr> <td>Parameter Description</td> <td>Value</td> <td>Displays the description of the value, defined as a parameter.</td> </tr> </tbody> </table>	Column Name	Column Description	Price Item Parameter	Displays the parameter using which an age based eligibility criteria is defined.	Parameter Description	Displays the description of the price item parameter.	Parameter Value	Displays the value of the parameter.	Parameter Description	Value	Displays the description of the value, defined as a parameter.
Column Name	Column Description											
Price Item Parameter	Displays the parameter using which an age based eligibility criteria is defined.											
Parameter Description	Displays the description of the price item parameter.											
Parameter Value	Displays the value of the parameter.											
Parameter Description	Value	Displays the description of the value, defined as a parameter.										
Base Fee	Displays the fee applicable on the age limit and attributes of an eligible member.											

- **Modifier Information** – Displays the modifiers based on which additional charges or discount is offered to an eligible member in a fully-insured age based pricing rule. It contains the following fields:

Column Name	Column Description	
Modifier Type	Displays the type of modifier based on which you want to charge additional or offer discount to an eligible member.	
Modifier Description	Type	Displays the description of the modifier.
Modifier Value	Displays the value of the modifier.	
Modifier Description	Value	Displays the description of the modifier value.
Modifier Fee	Displays the amount charged or discount offered to an eligible member.	

- **Characteristics** – Lists the characteristics defined for the fully-insured age based pricing rule. It contains the following columns:

Column Name	Column Description
Effective Date	Displays the date from when the characteristic is effective for a fully-insured age based pricing rule.
Characteristic Type	Indicates the characteristic type.
Characteristic Value	Displays the value of the characteristic type.

Tier Based Pricing Rule

The **Tier Based Pricing Rule** zone displays the details of the tier based pricing rule for the fully-insured group customer (who is a parent customer, bill group, or a bill group's account) using a pricing group. It contains the following sections:

- **Pricing Information** – Displays basic details about the fully-insured tier based pricing rule. It contains the following fields:

Column Name	Column Description
Plan Number	Displays the plan number.

Column Name	Column Description
Plan Name	Displays the plan name.
Plan Start Date	Displays the date from when the plan is effective.
Plan End Date	Displays the date till when the plan rule is effective.
Policy Information	Displays the policy information. Note: It has a link. On clicking the link, the Policy screen appears where you can view the details of the policy.
Pricing Rule Type	Indicates the type of the pricing rule.
Price Item Information	Indicates the price item for which the pricing rule is created. Note: It has a link. On clicking the link, the Price Item screen appears where you can view the details of the price item.
Pricing Start Date	Displays the date from when the pricing rule is effective.
Pricing End Date	Displays the date till when the pricing rule is effective.
Rate Option	Indicates the rate option which is used while defining the pricing for the price item.

- **Pricing Parameters** – Displays the pricing information defined for the fully-insured tier based pricing rule. It contains the following fields:

Column Name	Column Description										
Pricing Parameters	Displays the pricing parameter details for the fully-insured tier based pricing rule. It contains the following columns: <table border="1" data-bbox="565 1178 1463 1497"> <thead> <tr> <th>Column Name</th> <th>Column Description</th> </tr> </thead> <tbody> <tr> <td>Price Item Parameter</td> <td>Displays the parameter using which the membership tier level based criteria is defined.</td> </tr> <tr> <td>Parameter Description</td> <td>Displays the description of the price item parameter.</td> </tr> <tr> <td>Parameter Value</td> <td>Displays the value of the parameter.</td> </tr> <tr> <td>Parameter Value Description</td> <td>Displays the description of the value, defined as a parameter.</td> </tr> </tbody> </table>	Column Name	Column Description	Price Item Parameter	Displays the parameter using which the membership tier level based criteria is defined.	Parameter Description	Displays the description of the price item parameter.	Parameter Value	Displays the value of the parameter.	Parameter Value Description	Displays the description of the value, defined as a parameter.
Column Name	Column Description										
Price Item Parameter	Displays the parameter using which the membership tier level based criteria is defined.										
Parameter Description	Displays the description of the price item parameter.										
Parameter Value	Displays the value of the parameter.										
Parameter Value Description	Displays the description of the value, defined as a parameter.										
Fee	Displays the fee applicable on the membership tier level and employee attributes of an eligible member.										

- **Characteristics** – Lists the characteristics defined for the fully-insured tier based pricing rule. It contains the following columns:

Column Name	Column Description
Effective Date	Displays the date from when the characteristic is effective.
Characteristic Type	Indicates the characteristic type.
Characteristic Value	Displays the value of the characteristic type.

Additional Charge Pricing Rule

The **Additional Charge Pricing Rule** zone displays the details of the additional charge pricing rule for the fully-insured group customer (who is a parent customer, bill group, or a bill group's account) using a pricing group. It contains the following sections:

- **Pricing Information** – Displays basic details about the additional charge pricing rule. It contains the following fields:

Column Name	Column Description
Plan Number	Displays the plan number.
Plan Name	Displays the plan name.
Plan Start Date	Displays the date from when the plan is effective for the additional charge pricing rule.
Plan End Date	Displays the date till when the plan rule is effective for the additional charge pricing rule.
Policy Information	Displays information about the policy. Note: It has a link. On clicking the link, the Policy screen appears where you can view the details of the policy.
Pricing Rule Type	Indicates the type of the pricing rule.
Price Item Information	Indicates the price item for which the additional charge pricing rule is created. Note: It has a link. On clicking the link, the Price Item screen appears where you can view the details of the price item.
Pricing Start Date	Displays the date from when the pricing rule is effective.
Pricing End Date	Displays the date till when the pricing rule is effective.
Rate Option	Indicates the rate option which is used while defining the pricing for the price item.
Modifier Applicability	Indicates modifier based on which additional charge or discount is offered to an eligible member.
Modifier Method	Indicates the method used when modifier applicability option is selected.
Pricing Type	Indicates the type of pricing defined for the additional charge pricing rule. The valid values are: <ul style="list-style-type: none"> • Flat • Percentage Note: This field appears when the Pricing Type option is selected.

- **Pricing Parameters** – Displays the pricing parameter information for an additional charge pricing rule. It contains the following fields:

Column Name	Column Description										
Pricing Parameters	Displays the pricing and parameter details for an additional charge pricing rule. It contains the following columns: <table border="1" data-bbox="613 296 1463 642"> <thead> <tr> <th>Column Name</th> <th>Column Description</th> </tr> </thead> <tbody> <tr> <td>Price Item Parameter</td> <td>Displays the parameter using which an age based eligibility criteria is defined.</td> </tr> <tr> <td>Parameter Description</td> <td>Displays the description of the price item parameter.</td> </tr> <tr> <td>Parameter Value</td> <td>Displays the value of the parameter.</td> </tr> <tr> <td>Parameter Value Description</td> <td>Displays the description of the value, defined as a parameter.</td> </tr> </tbody> </table>	Column Name	Column Description	Price Item Parameter	Displays the parameter using which an age based eligibility criteria is defined.	Parameter Description	Displays the description of the price item parameter.	Parameter Value	Displays the value of the parameter.	Parameter Value Description	Displays the description of the value, defined as a parameter.
Column Name	Column Description										
Price Item Parameter	Displays the parameter using which an age based eligibility criteria is defined.										
Parameter Description	Displays the description of the price item parameter.										
Parameter Value	Displays the value of the parameter.										
Parameter Value Description	Displays the description of the value, defined as a parameter.										
Base Fee	Displays the fee applicable on the age limit and attributes of an eligible member.										

- **Modifier Information** – Displays the modifiers based on which additional charges or discount is offered to an eligible member in an additional charge pricing rule. It contains the following fields:

Column Name	Column Description
Modifier Type	Displays the type of modifier based on which you want to charge additional or offer discount to an eligible member.
Modifier Type Description	Displays the description of the modifier.
Modifier Value	Displays the value of the modifier.
Modifier Value Description	Displays the description of the modifier value.
Modifier Fee	Displays the amount charged or discount offered to an eligible member.

- **Characteristics** – Lists the characteristics defined for the an additional charge pricing rule. It contains the following columns:

Column Name	Column Description
Effective Date	Displays the date from when the characteristic is effective for a fully-insured age based pricing rule.
Characteristic Type	Indicates the characteristic type.
Characteristic Value	Displays the value of the characteristic type.

Self-Funded Pricing Rule Versioning

Until now, the system enabled you to edit a self-funded pricing rule when it is not referred for any transaction in the system. If you wanted to edit a referred pricing rule, you had to manually cancel bill segments of the accounts and create the disaggregation and/or reseed requests for the accounts. Once the transactions are disaggregated, the system allowed you to edit the self-funded pricing rule.

Now, the system enables you to edit a self-funded pricing rule even when it is referred for a transaction in the system. On editing a referred self-funded pricing rule, the system will do the following:

- Automatically cancel the bill segments of the accounts and create the disaggregation and/or reseed requests for the accounts

- Increment the version of the referred self-funded pricing rule in the system

Now, the system maintains version numbers for a self-funded pricing rule. On creating a self-funded pricing rule, the version number of the self-funded pricing rule is set to 1. Also, when a self-funded policy is renewed, the version number of each self-funded pricing rule is set to 1.

If a self-funded pricing rule is referred for a transaction, the system creates a new version of the self-funded pricing rule when you edit it. The system does versioning of a self-funded pricing rule when a set of pre-defined fields are edited. For more information about the fields for which versioning is configured, refer to *Oracle Revenue Management and Billing Insurance User Guide*. The system will automatically cancel the bill segments and create the disaggregation and/or reseeding requests for the accounts when you implement the **Entity Audit** feature for the self-funded pricing rules. The entity audit framework is configured for the following business objects in this release:

- C1-PricingRuleAncillary
- C1-PricingRuleClaim
- C1-PricingRuleRetEnroll
- C1-PricingRuleRetTypeClaim
- C1-PricingRuleASL
- C1-PricingRuleSSL
- C1-PricingRuleLevelFunded
- C1-PricingRuleDiscArrangement

The **Eligible for Audit Event** option type in all the above listed business objects is set to **Y** and the **C1-PRVERSION** algorithm is attached to the **Audit** system event of the above listed business objects.

To implement the **Entity Audit** feature, you need to create an active audit event type for the above listed business objects where the audit usage is set to **Disaggregation/Reseeding**. Here, you need to specify a list of fields from the respective business object which you want to audit or monitor. The following audit event types are shipped for the respective pricing rule business object:

Business Object	Audit Event Type
C1-PricingRuleAncillary	ANCIL_DISAGG_AUD
C1-PricingRuleClaim	CLAIM_DISAGG_AUD
C1-PricingRuleRetEnroll	ENROL_RETEN_DISAGG_AUD
C1-PricingRuleRetTypeClaim	CLAIM_RETEN_DISAGG_AUD
C1-PricingRuleASL	ASL_DISAGG_AUD
C1-PricingRuleSSL	SSL_DISAGG_AUD
C1-PricingRuleLevelFunded	LF_DISAGG_AUD
C1-PricingRuleDiscArrangement	DISC_DISAGG_AUD

You can use the above audit event types or create a custom audit event type for the required business object. On editing a referred self-funded pricing rule, the system does the following:

If...	Then...
<p>The approval workflow process is configured for the respective pricing rule and you edit a field which is:</p> <ul style="list-style-type: none"> Listed in the active audit event type of the respective business object Configured for versioning 	<p>The system creates an approval transaction for the self-funded pricing rule. On approving the approval transaction, the system creates a new version of the self-funded pricing rule where the version number is incremented by 1. The status of the new version of the self-funded pricing rule is set to Disaggregation Initiated. In addition, the system creates an audit event using the active audit event type for the new version of the self-funded pricing rule. The status of the audit event is set to Pending.</p>
<p>The approval workflow process is not configured for the respective pricing rule and you edit a field which is:</p> <ul style="list-style-type: none"> Listed in the active audit event type of the respective business object Configured for versioning 	<p>The system creates a new version of the self-funded pricing rule where the version number is incremented by 1. The status of the new version of the self-funded pricing rule is set to Disaggregation Initiated. In addition, the system creates an audit event using the active audit event type for the new version of the self-funded pricing rule. The status of the audit event is set to Pending.</p>
<p>The approval workflow process is configured for the respective pricing rule and you edit a field which is:</p> <ul style="list-style-type: none"> Not listed in the active audit event type of the respective business object Configured for versioning 	<p>The system creates an approval transaction for the self-funded pricing rule. On approving the approval transaction, the system creates a new version of the self-funded pricing rule where the version number is incremented by 1. The status of the new version of the self-funded pricing rule is set to Active and the status of the old version of the self-funded pricing rule is changed to Inactive.</p>
<p>The approval workflow process is not configured for the respective pricing rule and you edit a field which is:</p> <ul style="list-style-type: none"> Not listed in the active audit event type of the respective business object Configured for versioning 	<p>The system creates a new version of the self-funded pricing rule where the version number is incremented by 1. The status of the new version of the self-funded pricing rule is set to Active and the status of the old version of the self-funded pricing rule is changed to Inactive.</p>
<p>The approval workflow process is configured for the respective pricing rule and you edit the end date of a self-funded pricing rule which is referred for a transaction after the pricing rule end date</p>	<p>The system creates an approval transaction for the self-funded pricing rule. On approving the approval transaction, the changes are reflected in the existing version of the self-funded pricing rule. Note that the system does not create a new version of the self-funded pricing rule. The system creates an audit event using the active audit event type for the existing version of the self-funded pricing rule. The status of the audit event is set to Pending.</p>
<p>The approval workflow process is not configured for the respective pricing rule and you edit the end date of a self-funded pricing rule which is referred for a transaction after the pricing rule end date</p>	<p>The system does not create a new version of the self-funded pricing rule. The changes are reflected in the existing version of the self-funded pricing rule. The system creates an audit event using the active audit event type for the existing version of the self-funded pricing rule. The status of the audit event is set to Pending.</p>

Note that the new version of the self-funded pricing rule will have the same pricing rule ID. However, on editing a self-funded pricing rule which is not referred for a transaction, the system edits the existing version of the self-funded pricing rule and does not create a new version of the self-funded pricing rule with incremental version number.

A new batch named **C1-DISTA** is introduced in this release. The **C1-DISTA** batch checks whether there are any audit events for the self-funded pricing rules in the **Pending** status. If an audit event for a self-funded pricing rule is in the

Pending status, the system checks whether the self-funded pricing rule is created using a primary pricing rule type. If so, the system derives the person for whom the self-funded pricing rule is created. If the person type of the derived person is **Parent Customer**, the system fetches all accounts of the parent customer and its bill groups. However, if the person type of the derived person is **Bill Group**, the system fetches all accounts of the bill group. Once the accounts are derived, the system cancels the bill segments of the accounts and creates a disaggregation request for these accounts. The system then confirms whether you want to create reseeding requests for the related pricing rule types (if any). If you click the **OK** button, the system creates the reseeding requests. While creating a reseeding request for a related pricing rule type, the system derives all accounts from the accumulation group and then creates a reseeding request for each such account. Finally, the batch changes the status of the audit event to **Complete**.

Once the disaggregation and reseeding requests are created for the accounts, you need to disaggregate the transactions using the disaggregation batches. On executing the **C1-DRSUA** batch, the system changes the status of the disaggregation or reseeding request to **Complete** and then executes the **C1-UPDAUDEV** algorithm attached to the **Post-Processing** system event of the batch control. This algorithm changes the status of the new version of the self-funded pricing rule (for which disaggregation is completed) to **Active** and changes the status of the old version of the self-funded pricing rule to **Inactive**.

Note that you cannot edit a self-funded pricing rule in the **Active** status when an audit event for the self-funded pricing rule is in the **Pending** status. You cannot edit or delete a self-funded pricing rule which is in the **Disaggregation Initiated** status. Also, you cannot edit the related self-funded pricing rule in the **Active** status when the new version of the primary self-funded pricing rule is in the **Disaggregation Initiated** status.

Chapter 35

Stop-Loss

Topics:

- [Accumulation Data](#)

Oracle Revenue Management and Billing enables you to accumulate the specific stop-loss and aggregate stop-loss and create billable charges for them. Once the transaction calculation lines for specific stop-loss and aggregate stop-loss are created using the transaction aggregation process, you need to execute the following batches in the specified sequence:

1. Stamp Accumulate After Date (C1-STAAD)
2. Accumulate Specific Stop-Loss (C1-ACSSL)
3. Create Billable Charge for Specific Stop Loss (C1-BCSSL)
4. Accumulate Aggregate Stop-Loss (C1-ACASL)
5. Create Billable Charge for Aggregate Stop Loss (C1-BCASL)

For more information about these batches, see *Oracle Revenue Management and Billing Batch Guide*.

Accumulation Data

The **Accumulation Data** screen enables you to view the specific stop-loss, aggregate stop-loss, discount, and level funded accumulation details. It contains the following zones:

- **Search Parent Accumulation Group** - Enables you to search for a parent accumulation group whose accumulation details you want to view. You can search a parent accumulation group which is created for either of the following accumulation category:
 - Specific Stop-Loss
 - Aggregate Stop-Loss
 - Discount Arrangement
 - Level Funded
- **Specific Stop-Loss Accumulation Amount** - Enables you to view how the specific stop-loss is calculated in each accumulation run. In addition, you can view the specific stop-loss billable charge which is created in each accumulation run.
- **Aggregate Stop-Loss Accumulation Amount** - Enables you to view how the aggregate stop-loss is calculated in each accumulation run. In addition, you can view the aggregate stop-loss billable charge which is created in each accumulation run.
- **Discount Arrangement Accumulation Amount** - Enables you to view how the discount is calculated in each accumulation run. In addition, you can view the discount billable charge which is created in each accumulation run.
- **Level Funded Accumulation Amount** - Enables you to view how the charges eligible for level funding are calculated in each accumulation run. In addition, you can view the level funded billable charge which is created in each accumulation run.
- **Off-Process Adjustment/Billable Charges** - Enables you to view the adjustments or billable charges created through an off-process request which are used in the accumulation run.
- **Transaction Information** - Enables you to view the claim transactions for which the specific stop-loss, aggregate stop-loss, discount, or charges eligible for level funding are accumulated.
- **Transaction Leg Calculation Lines** - Enables you to view calculation lines of all legs of the transaction which are rated before billing.
- **Transaction Leg Calculation Line Characteristics** - Enables you to view the characteristics of a calculation line.

You can navigate to the **Accumulation Data** screen from the **Transaction and Audit Event Management** menu.

Chapter 36

Self-Funded Billing

Topics:

- [Pre-requisites](#)
- [Bill Group Derivation and Pricing Parameters](#)
- [Related Pricing Rule Type Eligibility](#)
- [Price Item Eligibility](#)
- [Self-Funded Billing Process](#)
- [Bill Group Derivation](#)
- [Account and Price Item Derivation \(for the Claim Pricing Rule Type Category\)](#)
- [Account and Price Item Derivation \(for the Specific Stop-Loss and Aggregate Stop-Loss Pricing Rule Type Categories\)](#)
- [Account and Price Item Derivation \(for the Retention Type Claim Based Pricing Rule Type Category\)](#)
- [Account and Price Item Derivation \(for the Retention Type Enrollment Based Pricing Rule Type Category\)](#)
- [Account and Price Item Derivation \(for the Ancillary Pricing Rule Type Category\)](#)
- [Bill After Date Determination](#)
- [Advance Billing for Claim Fund Charge](#)
- [SSL Accumulation across Bill Groups](#)

Administrative Services Only (ASO) is an arrangement in which an organization funds its own employee benefit plan such as a health plan but hires an outside firm to perform specific administrative services. For example, an organization may hire an insurance company to evaluate and process claims under its employee health plan, while maintaining the responsibility to pay the claims itself.

Self-Funded plan specifics vary depending on the agreement a company establishes with insurance companies and third-party administrators (TPA). In the self-funded plan, the insurance company may provide little to no degree of insurance protection. ASO services are gaining popularity because many employers, particularly larger ones, explore that the self-funded plan provides the potential financial advantages at an acceptable cost.

Oracle Revenue Management and Billing (ORMB) provides a complete solution in terms of pricing, billing, and revenue management to support the self-funded plans. It also provides risk coverage for offering self-funded plans through the stop-loss services, such as specific stop-loss and aggregate stop-loss. The specific stop-loss solution in ORMB helps the employer in mitigating high-cost claims for individual members. And, the aggregate stop-loss helps the employer in mitigating risk against high-volume claims.

The **Transaction Feed Management (TFM)** module is enhanced to support the self-funded billing. You can upload the claim, enrollment, and ancillary transactions in the system using the **File Upload Interface** feature. You can use the **File Upload Interface** feature to upload transaction data files in the following formats:

- Comma Separated Values
- JavaScript Object Notation
- Fixed Position
- Pipe Separated Values
- Tilde Separated Values
- Extensible Markup Language

Once the claim, enrollment, and ancillary transaction data files are uploaded in the system, you need to:

- Validate Header Details
- Validate Transaction Details and Determine Initial Price Item
- Verify Price Item Pricing
- Rate Transactions Before Billing (if required)
- Create and Update Billable Charge with the SQI values

- Clean-up Unwanted Data

The system provides the flexibility to rate the claim, enrollment, and ancillary transactions either prior to billing or during billing. Based on the business requirements, you can configure the system such that transactions mapped to a price item can be rated at a frequency which is different from the account's billing frequency. For example, daily, weekly, etc.

A new pricing model is introduced for the self-funded health insurance business which enables you to create pricing rules for:

- Claim
- Specific Stop-Loss
- Aggregate Stop-Loss
- Claim Based Fees
- Enrollment Based Fees
- One-time and Recurring Flat Fees
- Ancillary Charges

Once you create the required pricing structure, you can bill for the claim, enrollment, and ancillary transactions. Once the billable charges for claims, claim based fees, enrollment based fees, and ancillary are created through the transaction aggregation process, you can accumulate the specific stop-loss and aggregate stop-loss and create billable charges for them. Once the required billable charges are created, you can bill them using the charge-based billing batches.

Pre-requisites

To setup the Self-Funded Billing feature, you need to do the following:

- Define the parent customers and bill groups in the system.
- Define the required pricing rule types for different pricing rule type categories, such as **Claim**, **Specific Stop-Loss**, **Aggregate Stop-Loss**, **Retention Type Claim Based**, **Retention Type Enrollment Based**, **Flat Fees**, and **Ancillary**.
- Map the transaction fields appropriately in the primary pricing rule types.
- Attach an algorithm created using the **C1_TXNBGDRV** algorithm type to the **Bill Group Derivation** system event of the pricing rule type where the pricing rule type category is set to **Claim** or **Retention Type Enrollment Based**.
- Attach an algorithm created using the **C1_ACCPRIDRV** algorithm type to the **Account and Price Item Derivation** system event of the pricing rule type where the pricing rule type category is set to **Claim**, **Retention Type Claim Based**, **Retention Type Enrollment Based**, or **Ancillary**.
- Attach an algorithm created using the **C1_ACCPRISL** algorithm type to the **Account and Price Item Derivation** system event of the pricing rule type where the pricing rule type category is set to **Specific Stop-Loss** or **Aggregate Stop-Loss**.
- Attach an algorithm created using the **C1_BAFTDRV** algorithm type to the **Bill After Date Determination** system event of the pricing rule type where the pricing rule type category is set to **Claim**, **Retention Type Claim Based**, **Retention Type Enrollment Based**, or **Ancillary**.
- Attach an algorithm created using the **SA_DERV_POPC** algorithm type to the **TFM - Contract Derivation** algorithm spot of the required divisions.
- Attach an algorithm created using the **C1-VRPR_POPC** algorithm type to the **TFM - Verify Pricing Post-Processing** algorithm spot of the required divisions.
- Attach an algorithm created using the **C1_BCHG_POPC** algorithm type to the **TFM - Billable Charge Post-Processing** algorithm spot of the required divisions.
- Map each transaction record type to either the required rule type or primary pricing rule type.
- Define the pricing groups for the required bill groups.
- Define the required pricing rules for the parent customer and bill groups.
- Define the rate schedules with the following calculation algorithms for different price items:

Price item related to....	Calculation Algorithm
Claim	C1-CLAIMCALC
Specific Stop-Loss	C1-SSLRTCALC
Aggregate Stop-Loss	C1-ASLRTCALC
Retention Type Enrollment Based	None
Flat Fees	None
Ancillary	C1-ANCICALC

- Attach an algorithm created using the **C1-RETFLAT** algorithm type to the **TFM – Rate Pre-Processing** algorithm spot of the required divisions.
- Define the TFM information in the rating option for different price items in the following manner:

Price item related to....	Rate Option			
	Aggregate Transaction	Aggregation Schedule	Ignore Transaction	Rating Criteria
Claim	Yes	As Required	No	RITA
Specific Stop-Loss	No	-	Yes	RITX
Aggregate Stop-Loss	No	-	Yes	RITX
Retention Type Claim Based	Yes	As Required	No	RITA
Retention Type Enrollment Based	Yes	As Required	No	RITA
Ancillary	Yes	As Required	No	RITA

- Define the derivation and pricing parameters for each bill group.
- Set the following option types in the **C1-ASOBLNG** feature configuration:
 - Person Relationship Type
 - Bill Group Policy Person Role
 - Invoice Type Characteristic Type
 - Pricing Group Rule Parameter
 - Billable Charge Line Type Parameter
 - Pricing Arrangement Parameter

Related Topics

For more information on...	See...
How to set up the C1-ASOBLNG feature configuration	Setting the C1-ASOBLNG Feature Configuration on page 3421

Bill Group Derivation and Pricing Parameters

An employer may have different bill groups. Each bill group will handle the claim, enrollment, and ancillary transactions of employees based on the employee attributes, such as location, employment status, employment department, and so on.

Oracle Revenue Management and Billing allows you to define the derivation and pricing parameters, such as source system, parameter 1, parameter 2, parameter 3, and parameter 4 for the bill group. These parameters are used to derive the bill group against which the billable charges created for the claim, enrollment, and ancillary transactions should be billed in the system. The derived bill group is also used for billing the claim based fees, one-time or recurring fees, specific stop-loss credits, and aggregate stop-loss credits. You can define multiple derivation and pricing parameters for a bill group, but the derivation and pricing parameter combination must be unique for a particular duration.

For example, if you want bill group 1 to handle the claim, enrollment, and ancillary transactions of employees:

- Who reside in the Western location of the city
- Who belong to Grade A
- Whose transactions are received from the X system

Then, you need to define the following derivation and pricing parameters for bill group 1:

Bill Group Name	Sort ID	Source System	Parameter 1	Parameter 2	Parameter 3	Parameter 4
Bill Group 1	111	X	Western	Grade A	-	-

Example 1: Derivation and Pricing Parameters for Bill Group 1

Similarly, if you want bill group 2 to handle the claim, enrollment, and ancillary transactions of employees:

- Who reside in the Eastern location of Mumbai
- Who are the person of Indian origin
- Who belong to Grade A
- Whose transactions are received from the X system

Then, you need to define the following derivation and pricing parameters for bill group 2:

Bill Group Name	Sort ID	Source System	Parameter 1	Parameter 2	Parameter 3	Parameter 4
Bill Group 2	123	X	Eastern	Grade A	Mumbai	India

Example 2: Derivation and Pricing Parameters for Bill Group 2

In the example 1 and 2, the bill group is derived based on the specified employee attributes when the source system, parameter 1, parameter 2, parameter 3, and parameter 4 are mapped to the appropriate transaction fields in the primary pricing rule type using which the pricing rules are defined for the bill group. For example,

Pricing Rule Type	Source System	Parameter 1	Parameter 2	Parameter 3	Parameter 4
PR1	External System	Location	Designation	City	Country

Example 3: Transaction Field Mapping in Primary Pricing Rule Type

You can also define criteria for a rule in a pricing group using the parameters, such as source system, parameter 1, parameter 2, parameter 3, and parameter 4. For example,

Pricing Group	Rule	Source System	Parameter 1	Parameter 2	Parameter 3	Parameter 4
PG1	R1	X	Eastern	Grade A	Mumbai	India
	R2	X	Western	Grade A	-	-

Example 4: Rules Defined in a Pricing Group

If a pricing rule is defined for a bill group using a pricing group, you can define more than one price in the pricing rule which is offered based on the attributes of the employees. For example,

Pricing Rule	Pricing Group	Rule	Rule Criteria	Pricing Strategy	Markup or Markdown Type	Markup or Markdown Amount
PRRR1	PG1	R1	Source System = X, Parameter 1 = Eastern, Parameter 2 = Grade A, Parameter 3 = Mumbai, Parameter 4 = India	Markup	Flat Amount	\$20
		R2	Source System = X, Parameter 1 = Western, Parameter 2 = Grade A	Markdown	Flat Amount	\$10

Example 5: Defining a Pricing Rule Using a Pricing Group

In the example 5, the system will use the markup strategy on the claim line items for the employees who satisfy the criteria specified in R1. On the other hand, the system will use the markdown strategy on the claim line items for the employees who satisfy the criteria specified in R2.

The derivation and pricing parameters for the bill group and sort ID combination are effective from a particular date. However, the effective date must fall within the date range defined for the sort ID of the bill group. The source system and parameter 1 are mandatory while defining the derivation and pricing parameters for a bill group.

You can define and edit the derivation and pricing parameters for the bill group and sort ID combination from the **Customer 360° Information** screen. You can also upload the derivation and pricing parameters for one or more bill group and sort ID combinations at the same time using the **Upload Request** feature. You can upload the derivation and pricing parameters for the bill group and sort ID combinations from the **Customer 360° Information** or **Upload Request** screen. Note that you can upload the derivation and pricing parameters for the bill group and sort ID only using the CSV file format.

Related Topics

For more information on...	See...
Bill Group Derivation and Pricing Parameters zone	Bill Group Derivation and Pricing Parameters on page 671
How to define the derivation and pricing parameters for a bill group and sort ID combination	Defining the Derivation and Pricing Parameters for a Bill Group and Sort ID Combination on page 717
How to edit the derivation and pricing parameters of a bill group and sort ID combination	Editing the Derivation and Pricing Parameters of a Bill Group and Sort ID Combination on page 719
How to create an upload request for the derivation and pricing parameters from the Bill Group Derivation and Pricing Parameters zone	Creating a Bill Group Derivation and Pricing Parameters Upload Request on page 721
How to create an upload request for the derivation and pricing parameters from the Upload Request screen	Creating an Upload Request on page 1982

Related Pricing Rule Type Eligibility

Oracle Revenue Management and Billing enables you to define eligibility rule type for a related pricing rule type in a primary pricing rule type. If the eligibility rule type is defined of a related pricing rule type, the system checks whether the related pricing rule type is eligible for deriving the transaction legs when it is called during the **Validate Transaction and Derive Price Item (C1-TXNIP)** batch execution. The system searches for all rules which are created using the respective rule type and then executes them one by one in the specified priority until the following conditions are met in a rule:

- The eligibility criteria defined in the rule is satisfied.
- The satisfied rule returns the output parameter and its value as specified in the **Rule Based Related Pricing Rule Type Eligibility Field** and **Rule Based Eligibility Value** fields, respectively, of the primary pricing rule type.
- The **Rule True Action** field in the satisfied rule returns **Success**.

Note: At present, the system considers all rules created using the respective rule type irrespective of whether it is effective on the transaction date or not.

If all the above conditions are met in a rule, the system calls the respective related pricing rule type for deriving the transaction legs. If none of the rules created using the rule type are satisfied, the system does not call the respective related pricing rule type for deriving the transaction legs. Let us understand this with the help of an example. If the claim transaction is received with the following details:

- UDF_CHAR_1 is set to Western
- UDF_CHAR_15 is set Employee

- UDF_DATE_1 is set to 11-05-2018
- Transaction Record Type is set to TR1

Transaction Record Type	Primary Pricing Rule Type	Related Pricing Rule Type	Eligibility Rule Type	Rule	Rule's Effective Start Date	Rule's Effective End Date	Priority	Rule Criteria	Output Parameter	Output Parameter Value
TR1	CLAIM	CLAIM BASED FEES	RT1	R1	01-01-2018	31-03-2018	1	UDF_CHAR_1 = Western	UDF_CHAR_15	Director
				R2	01-01-2018	31-03-2018	2	UDF_CHAR_1 = Western	UDF_CHAR_15	Employee
				R3	01-04-2018	30-06-2018	3	UDF_CHAR_1 = Western	UDF_CHAR_15	Employee
				R4	01-07-2018	31-12-2018	4	UDF_CHAR_1 = Western	UDF_CHAR_15	Director
		SPECIFIC STOP-LOSS	RT2	R5	01-01-2018	31-03-2018	1	UDF_CHAR_1 = Western	UDF_CHAR_15	Director
				R6	01-01-2018	31-03-2018	2	UDF_CHAR_1 = Eastern	UDF_CHAR_15	Employee
				R7	01-04-2018	31-12-2018	3	UDF_CHAR_1 = Western	UDF_CHAR_15	Employee
		AGGREGATE STOP-LOSS	RT3	R8	01-04-2018	31-12-2018	1	UDF_CHAR_1 = Eastern	UDF_CHAR_15	Employee
				R9	01-04-2018	31-12-2018	2	UDF_CHAR_1 = Western	UDF_CHAR_15	Director

Note: Here, the paid date is mapped to the UDF_DATE_1 field in the CLAIM pricing rule type. In addition, the **Rule Based Related Pricing Rule Type Eligibility Field** field is set to UDF_CHAR_15 and the **Rule Based Eligibility Value** field is set to **Employee** in the CLAIM pricing rule type.

Example 1: Related Pricing Rule Type Eligibility Rules

In the example 1, the rules which are created using the RT1 rule type are invoked for the CLAIM BASED FEES pricing rule type in the specified priority. The claim transaction meets the eligibility criteria defined in the R1 rule. But, the output parameter's value specified in the R1 rule does not match the value specified in the **Rule Based Eligibility Value** field. Therefore, the system executes the rule with the next priority (i.e. R2). The claim transaction meets the eligibility criteria defined in the R2 rule. In addition, the output parameter and its value specified in the R2 rule match the values specified in the **Rule Based Related Pricing Rule Type Eligibility Field** and **Rule Based Eligibility Value** fields, respectively. Therefore, the system considers the CLAIM BASED FEES pricing rule type for deriving the transaction legs.

The rules which are created using the RT2 rule type are invoked for the SPECIFIC STOP-LOSS pricing rule type in the specified priority. The claim transaction meets the eligibility criteria defined in the R5 rule. But, the output parameter's value specified in the R5 rule does not match the value specified in the **Rule Based Eligibility Value** field. Therefore, the system executes the rule with the next priority (i.e. R6). Here, the claim transaction does not meet the eligibility criteria defined in the R6 rule. The system then executes the rule with the next priority (i.e. R7). The claim transaction meets the eligibility criteria defined in the R7 rule. In addition, the output parameter and its value specified in the R7 rule match the values specified in the **Rule Based Related Pricing Rule Type Eligibility Field** and **Rule Based Eligibility Value** fields, respectively. Therefore, the system considers the SPECIFIC STOP-LOSS pricing rule type for deriving the transaction legs.

Similarly, the rules which are created using the RT3 rule type are invoked for the AGGREGATE STOP-LOSS pricing rule type in the specified priority. The claim transaction does not meet the eligibility criteria defined in the R8 rule. Therefore, the system executes the rule with the next priority (i.e. R9). The claim transaction meets the eligibility criteria defined in the R9 rule. But, the output parameter's value specified in the R9 rule does not match the value specified in

the **Rule Based Eligibility Value** field. As none of the rules created using the rule type met the criteria, the system does not consider the AGGREGATE STOP-LOSS pricing rule type for deriving the transaction legs.

Price Item Eligibility

Oracle Revenue Management and Billing enables you to define eligibility rule type for a price item in a pricing rule type. If the eligibility rule type is defined of a price item, the system checks whether the price item is eligible for billing when the pricing rule type is called during the **Validate Transaction and Derive Price Item (C1-TXNIP)** batch execution. The system searches for all rules which are created using the respective rule type and then executes them one by one in the specified priority until the following conditions are met in a rule:

- The eligibility criteria defined in the rule is satisfied.
- The satisfied rule returns the output parameter and its value as specified in the **Rule Based Price Item Eligibility Field** and **Rule Based Eligibility Value** fields, respectively, of the pricing rule type.
- The **Rule True Action** field in the satisfied rule returns **Success**.

Note: At present, the system considers all rules created using the respective rule type irrespective of whether it is effective on the transaction date or not.

If all the above conditions are met, the system searches for an effective pricing rule for the respective price item. If none of the rules created using the rule type are satisfied, the system does not map the transaction to the price item. Let us understand this with the help of an example. If the claim transaction is received with the following details:

- UDF_CHAR_1 is set to Western
- UDF_CHAR_20 is set to Employee
- UDF_DATE_1 is set to 05-03-2018
- Transaction Record Type is set to TR1

Transaction Record Type	Primary Pricing Rule Type	Price Item	Eligibility Rule Type	Rule	Rule's Effective Start Date	Rule's Effective End Date	Priority	Rule Criteria	Output Parameter	Output Parameter Value
TR1	CLAIM	P1	RT1	R1	01-01-2018	31-03-2018	1	UDF_CHAR_1 = Western	UDF_CHAR_20	Director
				R2	01-01-2018	31-03-2018	2	UDF_CHAR_1 = Western	UDF_CHAR_20	Employee
				R3	01-04-2018	30-06-2018	3	UDF_CHAR_1 = Western	UDF_CHAR_20	Employee
				R4	01-07-2018	31-12-2018	4	UDF_CHAR_1 = Western	UDF_CHAR_20	Director
	P2	RT2	R5	01-01-2018	31-03-2018	1	UDF_CHAR_1 = Western	UDF_CHAR_20	Director	
			R6	01-01-2018	31-03-2018	2	UDF_CHAR_1 = Eastern	UDF_CHAR_20	Employee	
			R7	01-04-2018	31-12-2018	3	UDF_CHAR_1 = Western	UDF_CHAR_20	Employee	

Note: Here, the paid date is mapped to the **UDF_DATE_1** field in the CLAIM pricing rule type. In addition, the **Rule Based Related Pricing Rule Type Eligibility Field** field is set to **UDF_CHAR_20** and the **Rule Based Eligibility Value** field is set to **Employee** in the CLAIM pricing rule type.

Example 1: Price Item Eligibility Rules

In the example 1, the rules which are created using the RT1 rule type are invoked for P1 in the specified priority. The claim transaction meets the eligibility criteria defined in the R1 rule. But, the output parameter's value specified in the R1 rule does not match the value specified in the **Rule Based Eligibility Value** field. Therefore, the system executes the rule with the next priority (i.e. R2). The claim transaction meets the eligibility criteria defined in the R2 rule. In addition, the output parameter and its value specified in the R2 rule match the values specified in the **Rule Based Price Item Eligibility Field** and **Rule Based Eligibility Value** fields, respectively. Therefore, the system considers P1 for billing and maps the claim transaction to P1 if an effective pricing rule, account, and active contract are available for P1.

Similarly, the rules which are created using the RT2 rule type are invoked for P2 in the specified priority. The claim transaction meets the eligibility criteria defined in the R5 rule. But, the output parameter's value specified in the R5 rule does not match the value specified in the **Rule Based Eligibility Value** field. Therefore, the system executes the rule with the next priority (i.e. R6). Here, the claim transaction does not meet the eligibility criteria defined in the R6 rule. The system then executes the rule with the next priority (i.e. R7). The claim transaction meets the eligibility criteria defined in the R7 rule. In addition, the output parameter and its value specified in the R7 rule match the values specified in the **Rule Based Price Item Eligibility Field** and **Rule Based Eligibility Value** fields, respectively. Therefore, the system considers P2 for billing and maps the claim transaction to P2 if an effective pricing rule, account, and active contract are available for P2.

Self-Funded Billing Process

The **Self-Funded Billing** process consists of the following sub-processes:

- [Transaction Aggregation](#) on page 2951
- [Stop Loss Calculation](#) on page 2956
- [Bill Generation](#) on page 2956

Transaction Aggregation

Once the claim, enrollment, and ancillary transactions are uploaded, you can create billable charges for the following using the **Transaction Aggregation** process in the **Transaction Feed Management (TFM)** module:

- Claim
- Claim Based Fees
- Retroactive Enrollment Fees
- Non-retroactive Enrollment Fees
- Ancillary

The transaction calculation lines for specific stop-loss and aggregate stop-loss are created during the **Transaction Aggregation** process. Earlier, the **Transaction Aggregation** process was designed to meet the requirements of the **Payments** and **Financial Services** industries. Now, in addition, it is tuned slightly to meet the requirements of the self-funded health insurance business. The changes are made in the following batches which are executed in the **Transaction Aggregation** process:

- **Validate Transaction and Derive Price Item (C1-TXNIP)** - During this batch execution, the system validates the transaction. If the transaction validation fails due to any reason, the status of the transaction is changed to **Error**. If the transaction validation is successful, the system checks whether a primary pricing rule type is specified in the respective transaction record type. If a primary pricing rule type is not specified in the transaction record type, the system maps the transaction to one or more price item, price item parameters, and account combinations using the rules which are invoked through the rule type. However, if a primary pricing rule type is specified in the transaction record type, the system calls the primary pricing rule type and invokes the algorithms which are attached to the following system events of the primary pricing rule type in the specified sequence:
 1. **Transaction Validation** - At present, the product has not shipped an algorithm type for the **Transaction Validation** system event. If required, you can create a custom algorithm type which validates the transaction before deriving the transaction legs.

2. **Bill Group Derivation** - For more information, refer to the *Bill Group Derivation* on page 2957 section.
3. **Account and Price Item Derivation** - Depending on the category to which the pricing rule type belongs, you need to attach different algorithm to the **Account and Price Item Derivation** system event. The following table lists the algorithms that you can attach to a primary pricing rule types with different category:

Pricing Rule Type Category	Algorithm	For more information on how the system derives the transaction legs, refer to...
Claim	C1_ACCPRIDRV	<i>Account and Price Item Derivation (for the Claim Pricing Rule Type Category)</i> on page 2960
Retention Type Enrollment Based	C1_ACCPRIDRV	<i>Account and Price Item Derivation (for the Retention Type Enrollment Based Pricing Rule Type Category)</i> on page 2990
Ancillary	C1_ACCPRIDRV	<i>Account and Price Item Derivation (for the Ancillary Pricing Rule Type Category)</i> on page 3000

This batch then calls the eligible related pricing rule types (if any) defined in the primary pricing rule type. Note that the related pricing rule types are called one by one in the specified sequence. The system invokes the algorithms which are attached to the following system events of the related pricing rule type in the specified sequence:

1. **Transaction Validation** - At present, the product has not shipped an algorithm type for the **Transaction Validation** system event. If required, you can create a custom algorithm type which validates the transaction before deriving the transaction legs.
2. **Account and Price Item Derivation** - Depending on the category to which the pricing rule type belongs, you need to attach different algorithm to the **Account and Price Item Derivation** system event. The following table lists the algorithms that you can attach to a related pricing rule type with different category:

Pricing Rule Type Category	Algorithm	For more information on how the system derives the transaction legs, refer to...
Specific Stop-Loss	C1_ACCPRISL	<i>Account and Price Item Derivation (for the Specific Stop-Loss and Aggregate Stop-Loss Pricing Rule Type Categories)</i> on page 2965
Aggregate Stop-Loss	C1_ACCPRISL	<i>Account and Price Item Derivation (for the Specific Stop-Loss and Aggregate Stop-Loss Pricing Rule Type Categories)</i> on page 2965
Retention Type Claim Based	C1_ACCPRIDRV	<i>Account and Price Item Derivation (for the Retention Type Claim Based Pricing Rule Type Category)</i> on page 2978

The following figure graphically explains the execution process of the **Validate Transaction and Derive Price Item (C1-TXNIP)** batch:

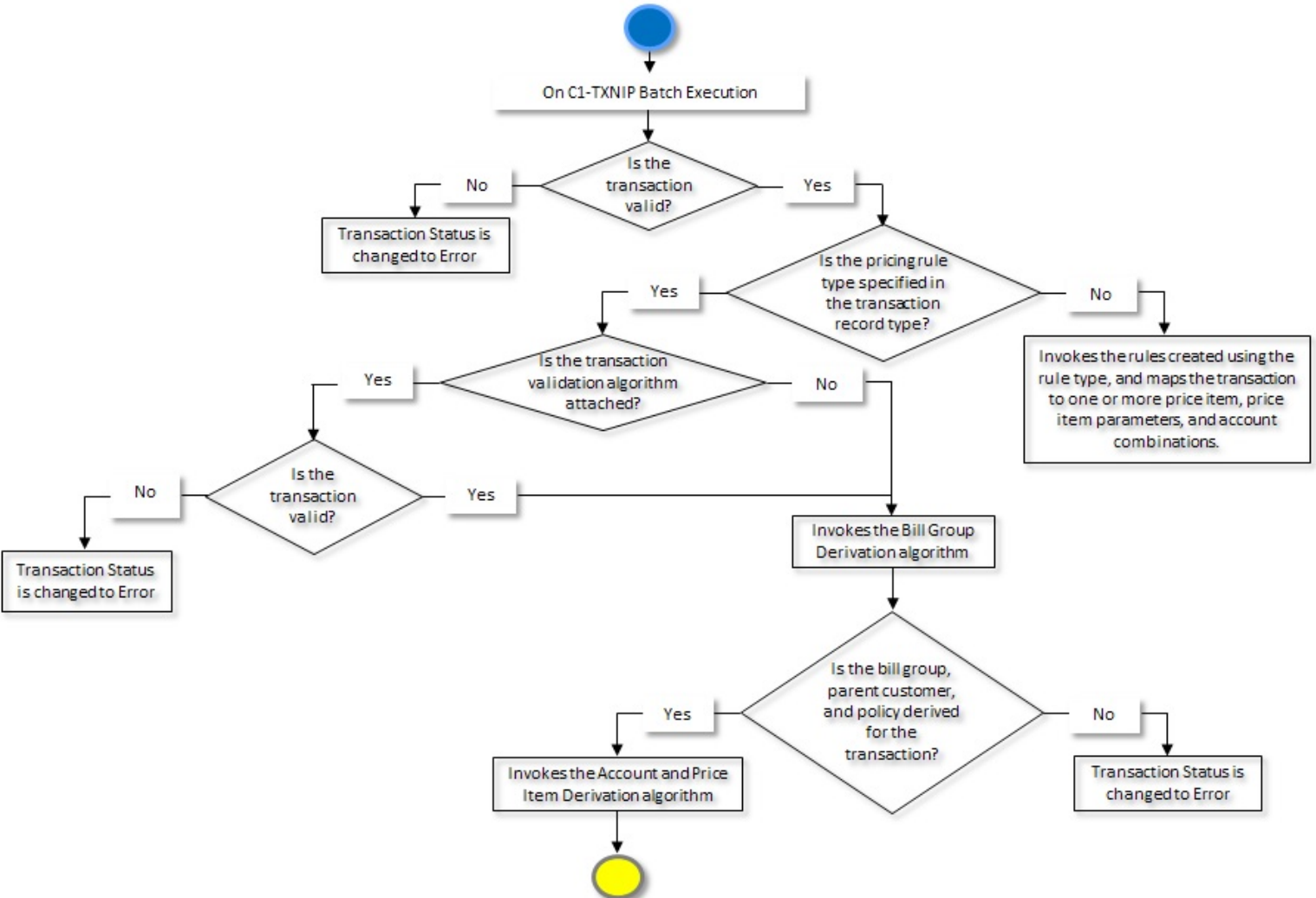

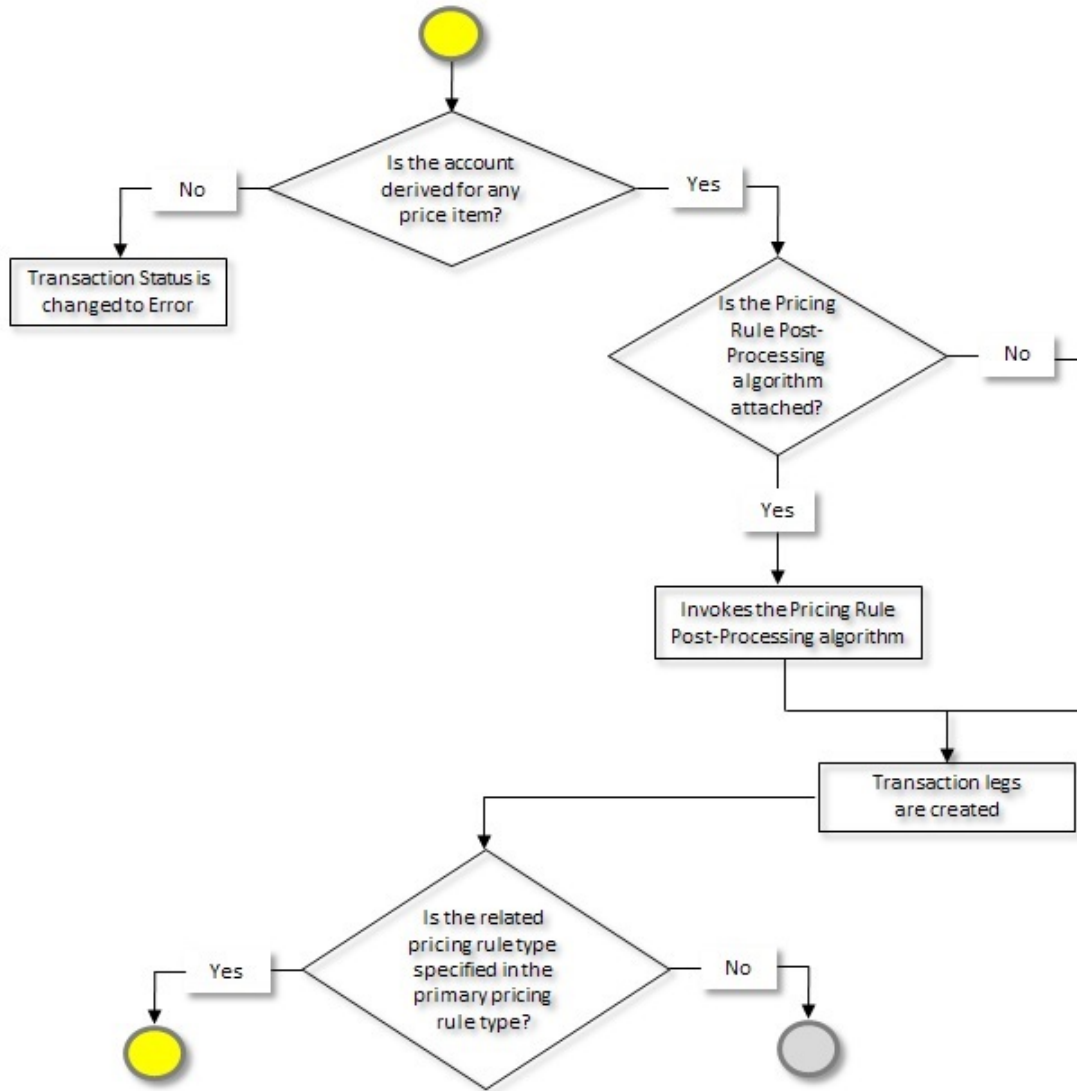

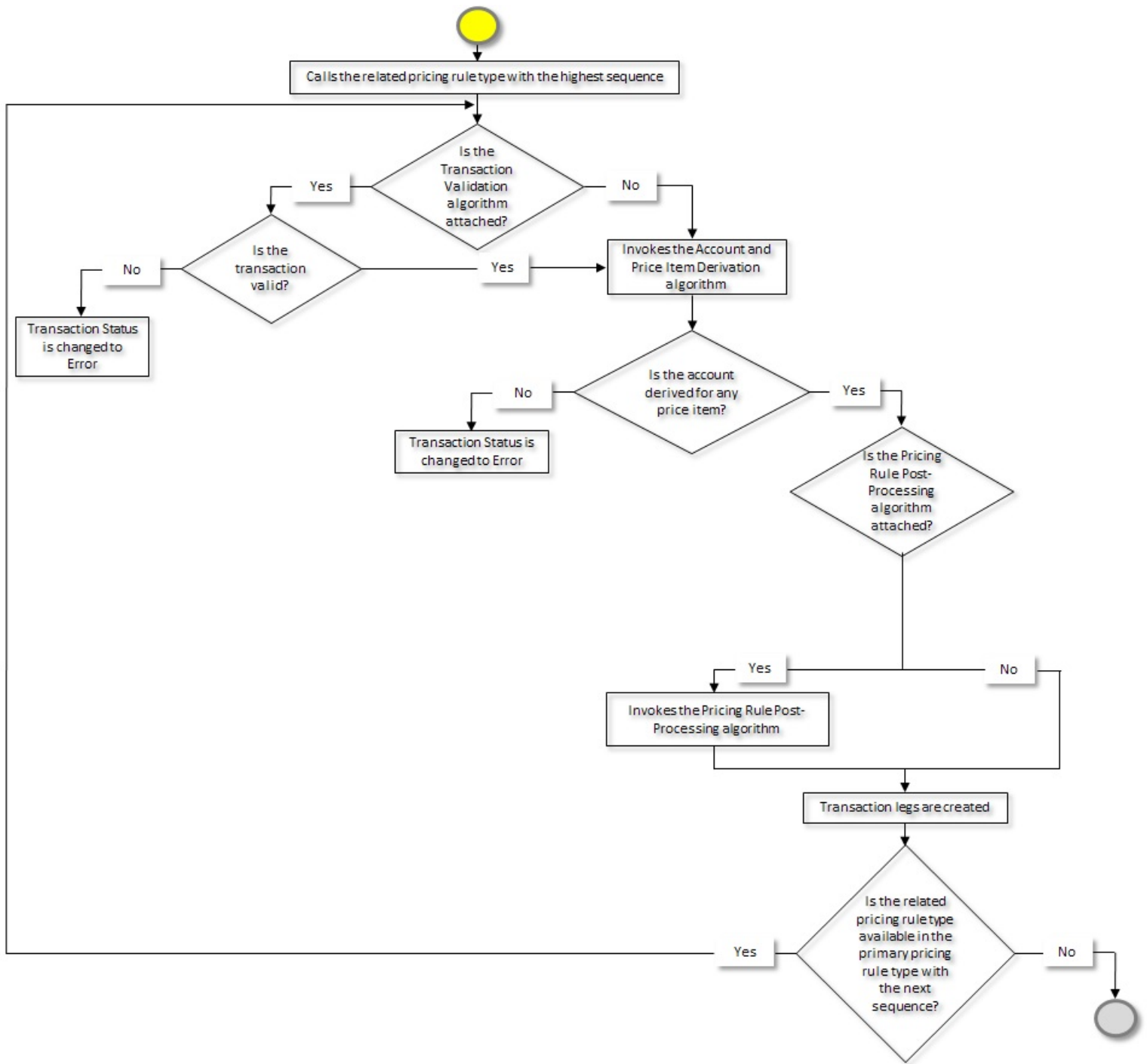

- **Price Item Pricing Verification (C1-TXNVP)** - During this batch execution, the system derives an effective pricing for each transaction leg on the processing date. For more information, refer to the [Price Item Pricing Verification](#) on page 1163 section. In addition, the system invokes the algorithms attached to the following algorithm spots of the derived account's division in the specified sequence for the self-funded health insurance business:

1. **TFM - Contract Derivation** - You can attach an algorithm created using the SA_DERV_POPC algorithm type to this algorithm spot. If the account has multiple active contracts of the contract type which is associated with the price item, this algorithm derives the contract which is associated with the policy and

maps it to the transaction leg. The manner in which the system derives the active contract for the account differs in the following scenarios:

If the effective pricing rule stamped against the transaction leg is defined at ...	Then...
The bill group level	The system first fetches the policy derived for the transaction and then derives the active contract which is associated with the policy.
The parent customer level	The system first fetches the bill group to which the account belongs and then the policy where the bill group is associated with the policy using the policy person role which is specified in the Bill Group Policy Person Role option type of the C1-ASOBLNG feature configuration. Once the policy is derived, the system derives the active contract which is associated with the policy.

2. **TFM - Verify Pricing Post-Processing** - You can attach an algorithm created using the **C1-VRPR_POPC** algorithm type to this algorithm spot. This algorithm removes the price assignment ID and price item parameter group ID from the summary ID column of each transaction leg.
- **Service Quantity Calculation (C1-TXNSQ)** - During this batch execution, the system aggregates the transaction legs, creates a billable charge, and updates the SQI values in the billable charge. For more information, refer to the [Aggregation](#) on page 1168 section. In addition, the system invokes the algorithm attached to the following algorithm spot of the derived account's division for the self-funded health insurance business:
 - **TFM - Billable Charge Post Processing** - You can attach an algorithm created using the **C1_BCHG_POPC** algorithm type to this algorithm spot. This algorithm invokes the algorithm which is attached to the **Bill After Date Determination** system event of the respective pricing rule type. For more information, refer to the [Bill After Date Determination](#) on page 3008 section.

Stop Loss Calculation

Oracle Revenue Management and Billing enables you to accumulate the specific stop-loss and aggregate stop-loss and create billable charges for them. Once the transaction calculation lines for specific stop-loss and aggregate stop-loss are created using the transaction aggregation process, you need to execute the following batches in the specified sequence:

1. Stamp Accumulate After Date Batch (C1-STAAD)
2. Accumulate Specific Stop Loss (C1-ACSSL)
3. Create Specific Stop-Loss Billable Charge (C1-BCSSL)
4. Accumulate Aggregate Stop Loss (C1-ACASL)
5. Create Aggregate Stop-Loss Billable Charge (C1-BCASL)

For more information about these batches, see *Oracle Revenue Management and Billing Batch Guide*.

Bill Generation

Once the billable charges are created for claim, claim based fees, specific stop-loss credits, aggregate stop-loss credits, enrollment based fees, and ancillary, you need to execute the following charge-based billing batches in the specified sequence to generate bills for the self-funded employer:

1. Pending Bill Generation (C1-PNDBL)
2. Bill Segment Generation (C1-BLGEN)

3. Bill Completion (C1-BLPPR)

For more information about these batches, see *Oracle Revenue Management and Billing Batch Guide*.

Bill Group Derivation

The **Validate Transaction and Derive Price Item (C1-TXNIP)** batch derives the bill group, parent customer, and policy for the claim, enrollment, and ancillary transactions. This is possible only when an algorithm created using the **C1_TXNBGDRV** algorithm type is attached to the **Bill Group Derivation** system event of the primary pricing rule type. The derived bill group is used for billing the following (if any):

- Claim Charges
- Claim Based Fees
- Specific Stop-Loss (SSL) Credits
- Aggregate Stop-Loss (ASL) Credits
- Retroactive Enrollment Fees
- Non-retroactive Enrollment Fees
- One-time or Recurring Fees
- Ancillary Charges

To derive a bill group, the system first determines the derivation date. The paid date is considered as the derivation date while processing the claim transactions. The coverage end date is considered as the derivation date while processing the retroactive enrollment transactions. And, the coverage start date is considered as the derivation date while processing the non-retroactive enrollment transactions. If the system cannot determine the derivation date, the status of the transaction is changed to **Error**.

Depending on the transaction fields which are mapped to source system, parameter 1, parameter 2, parameter 3, and parameter 4 in the primary pricing rule type, the system derives the data from the transaction. For example, if the source system is mapped to the **External System** field, parameter 1 is mapped to the **Location** field, parameter 2 is mapped to the **Designation** field, parameter 3 is mapped to the **Employee Group** field, and parameter 4 is mapped to the **Nationality** field, the system derives these details from the transaction. Based on the data available in the transaction, the system derives a bill group using the derivation and pricing parameters which are defined for the bill group. Note that the system considers the derivation and pricing parameters which are effective on the derivation date. For example, if the following derivation and pricing parameters are defined for the Bill Group 1 and Bill Group 2:

Bill Group Name	Sort ID	Effective Date	Source System	Parameter 1	Parameter 2	Parameter 3	Parameter 4
Bill Group 1	123	01-01-2018	X	Eastern	Senior Manager	BG1	Indian
Bill Group 1	132	01-04-2018	X	Western	Senior Manager	-	-
Bill Group 1	156	01-07-2018	Y	Eastern	Senior Manager	BG1	Indian
Bill Group 1	163	01-10-2018	Y	Western	Senior Manager	-	-
Bill Group 2	172	01-01-2018	Y	Eastern	-	-	-
Bill Group 2	181	01-04-2018	Y	Western	-	-	-
Bill Group 2	122	01-07-2018	X	Eastern	-	-	-
Bill Group 2	112	01-10-2018	X	Western	-	-	-

Now, if the system receives a claim transaction with the following details:

- External System is set to X
- Location is set to Western
- Designation is set to Senior Manager
- Paid Date is set to 12-05-2018

In this example, the derivation and pricing parameters defined for the Bill Group 1 and 132 (sort ID) combination are effective on the paid date, and therefore the system derives Bill Group 1 for billing the claim transaction. Let us take another example where the system receives a retroactive enrollment transaction with the following details:

- External System is set to X
- Location is set to Eastern
- Designation is set to Senior Manager
- Employee Group is set to BG1
- Nationality is set to Indian
- Coverage Start Date is set to 01-01-2018
- Coverage End Date is set to 31-03-2018

In this example, the derivation and pricing parameters defined for the Bill Group 1 and 123 (sort ID) combination are effective on the coverage end date, and therefore the system derives Bill Group 1 for billing the retroactive enrollment transaction.

In the above two examples, the system could find the exact match for the bill group in the system. However, if the exact match is not available, the system finds the bill group using the best fit match. For example, if the system receives a claim transaction with the following details:

- External System is set to Y
- Location is set to Western
- Designation is set to Senior Manager
- Employee Group is set to BG2
- Nationality is set to Indian
- Paid Date is set to 01-06-2018

In this example, the system could not find the effective derivation and pricing parameters with exact match (i.e. Source System = Y, Location = Western, Designation = Senior Manager, Employee Group = BG2, and Nationality = Indian) on the paid date. Therefore, it searches for the best fit match.

While searching for the best fit match, the system first rules out the optional parameter 4 (i.e. Nationality = Indian) and then checks whether the effective derivation and pricing parameters, where Source System = Y, Location = Western, Designation = Senior Manager, and Employee Group = BG2, are available on the paid date. If so, it considers the derivation and pricing parameters and accordingly derives the bill group. If not, the system then rules out the optional parameter 3 (i.e. Employee Group = BG2) and then checks whether the effective derivation and pricing parameters, where Source System = Y, Location = Western, and Designation = Senior Manager, are available on the paid date. If so, it considers the derivation and pricing parameters and accordingly derives the bill group. If not, the system then rules out the optional parameter 2 (i.e. Designation = Senior Manager) and then checks whether the effective derivation and pricing parameters, where Source System = Y and Location = Western, are available on the paid date. If so, it considers the derivation and pricing parameters and accordingly derives the bill group. If not, the status of the transaction is changed to **Error**.

In this example, the derivation and pricing parameters, where Source System = Y and Location = Western, defined for the Bill Group 2 and 181 (sort ID) combination are considered as the best fit match. Therefore, the system derives Bill Group 2 for billing the claim transaction. Let us take another example where the system receives a non-retroactive enrollment transaction with the following details:

- External System is set to Y
- Location is set to Eastern
- Designation is set to Senior Manager
- Employee Group is set to BG1
- Nationality is set to Indian
- Coverage Start Date is set to 01-01-2018
- Coverage End Date is set to 31-03-2018

In this example, the system could not find the effective derivation and pricing parameters with exact match (i.e. Source System = Y, Location = Eastern, Designation = Senior Manager, Employee Group = BG1, and Nationality = Indian) on the coverage start date. Therefore, it searches for the best fit match. The derivation and pricing parameters, where Source System = Y and Location = Eastern, defined for the Bill Group 2 and 172 (sort ID) combination are considered as the best fit match. Therefore, the system derives Bill Group 2 for billing the non-retroactive enrollment transaction.

Once the bill group is derived, the system derives the parent customer of the bill group. Once the parent customer is derived, the system derives the policy for the transaction in the following manner:

If the transaction is a...	Then...
Claim Transaction	<p>The system checks whether the paid date of the claim transaction falls within the policy start date and runout end date of any policy where:</p> <ul style="list-style-type: none"> • The bill group is associated with the policy using the policy person role which is specified in the Bill Group Policy Person Role option type of the C1-ASOBLNG feature configuration. • The status of the policy is set to either of the following: <ul style="list-style-type: none"> • In Force/Active • Runout • Post Runout
Retroactive Enrollment Transaction	<p>The system checks whether the coverage end date falls within the policy start date and policy end date of any policy where:</p> <ul style="list-style-type: none"> • The bill group is associated with the policy using the policy person role which is specified in the Bill Group Policy Person Role option type of the C1-ASOBLNG feature configuration. • The status of the policy is set to In Force/Active.
Non-retroactive Enrollment Transaction	<p>The system checks whether the coverage start date falls within the policy start date and policy end date of any policy where:</p> <ul style="list-style-type: none"> • The bill group is associated with the policy using the policy person role which is specified in the Bill Group Policy Person Role option type of the C1-ASOBLNG feature configuration. • The status of the policy is set to In Force/Active.

If the system cannot derive the policy for the transaction, the status of the transaction is changed to **Error**.

Account and Price Item Derivation (for the Claim Pricing Rule Type Category)

The **Validate Transaction and Derive Price Item (C1-TXNIP)** batch maps a claim transaction to one or more price item and price item parameters which are defined in the respective primary pricing rule type. This is possible when an algorithm created using the **C1_ACCPRIDRV** algorithm type is attached to the **Account and Price Item Derivation** system event of the primary pricing rule type.

Note: If you have specified the price item parameters (for which the parameter usage is set to **Pricing**) in the pricing rule types where the pricing rule type category is set to **Claim**, the system does not use these price item parameters while searching for an effective pricing rule for the respective price items. However, you can use these price item parameters while defining the accumulation criteria in the related pricing rule types where the pricing rule type category is set to **Specific Stop-Loss** or **Aggregate Stop-Loss**.

This algorithm fetches the effective pricing rule for each price item specified in the primary pricing rule type on the derivation date. The system considers the paid date as the derivation date while fetching the effective pricing rules for the claim transactions. This algorithm first searches for the effective pricing rule for a price item which is defined for the policy at the bill group level. If the system does not find any effective pricing rule for a price item which is defined for the policy at the bill group level, it inherits the effective pricing rule for a price item from the parent customer level.

For example, if the system receives a claim transaction with the following details:

- UDF_DATE_1 is set to 15-01-2018
- Transaction Record Type is set to TR1

Let us assume that the following pricing structure is defined in the system:

Transaction Record Type	Primary Pricing Rule Type	Price Item	Pricing Rule	Pricing Start Date	Pricing End Date	Assignment Level
TR1	CLAIM	P1	C1P1	01-01-2018	31-12-2018	Parent Customer
			C2P1	01-01-2018	31-12-2018	Bill Group
			C3P1	01-01-2019	30-06-2019	Bill Group
		P2	C1P2	01-06-2017	31-12-2017	Bill Group
			C2P2	01-01-2018	31-12-2018	Parent Customer
			C3P2	01-01-2019	30-06-2019	Bill Group

Note: Here, the paid date is mapped to the **UDF_DATE_1** field in the CLAIM pricing rule type.

Example 1: Effective Pricing Rule Derivation

In the example 1, the system fetches C2P1 and C2P2 pricing rules for P1 and P2, respectively, which are effective on the paid date. Note that the effective pricing rule for P1 is derived at the bill group level, whereas the effective pricing rule for P2 is derived from the parent customer level.

The system then derives the account with a particular invoice type (to which a price item must be billed) based on the priority which is defined for the respective price item in the pricing rule type. For example,

Price Item	Priority	Invoice Type	Account
P1	10	Standard	A1
	20	Retention	A2
P2	10	Retention	A2
	20	Standard	A1

Example 2: Priority Based Account Derivation

In the example 2, while mapping the claim transaction to P1, the system checks whether an account where the **Invoice Type (C1INVTYP)** characteristic is set to **Standard** exists for the bill group. If so, it considers the standard account (A1) of the bill group for billing. However, if an account where the **Invoice Type (C1INVTYP)** characteristic is set to **Standard** does not exist for the bill group, the system checks whether an account where the **Invoice Type (C1INVTYP)** characteristic is set to **Retention** exists for the bill group. If so, it considers the retention account (A2) of the bill group for billing. If an account where the **Invoice Type (C1INVTYP)** characteristic is set to **Retention** does not exist for the bill group, the status of the transaction is changed to **Error**.

Similarly, while mapping the claim transaction to P2, the system considers the account of the bill group which is available based on the priority. The system derives the billing account for only those price items for which the effective pricing rule is derived.

Note: The characteristic type which indicates the type of account (for example, **C1INVTYP**) must be specified in the **Invoice Type Characteristic Type** option type of the **C1-ASOBLLNG** feature configuration. Otherwise, erroneous results might occur.

Once the account is derived, the system then checks whether the account has one active contract of the contract type which is associated with the price item. If so, it fetches the contract for further processing. Once the effective pricing rule, account, and active contract are derived, the transaction is mapped to the respective price item, price item parameters, and account. A transaction leg is created for each price item, price item parameters, and account combination. For example, if the claim transaction is mapped to the following price item and account combinations:

Price Item	Effective Pricing Rule	Account	Active Contract	Transaction Leg
P1	PR1	A1	C1	TL1
P2	PR2	A2	C2	TL2
P3	PR3	A3	C3	TL3

Example 3: Transaction Leg Derivation

In the example 3, the system creates three transaction legs — TL1, TL2, and TL3 for the transaction. Once a transaction leg is created, the respective effective pricing rule is stamped against the transaction leg. Usually, once a transaction leg is created in the **Validate Transaction and Derive Price Item (C1-TXNIP)** batch, the price item parameters (for which the parameter usage is set to **Pricing**) of the transaction leg are grouped. The system does not support multiple parameter based pricing for the pricing rule types where the pricing rule type category is set to **Claim**. Therefore, when the price item parameters are not specified, the price item parameter group ID is set to 1 corresponding to each transaction leg — TL1, TL2, and TL3.

Note: A price item parameter group is used to determine the price item pricing. A unique group ID is generated for each group. If a group with a set of price item parameters already exists in the system, a new group is not created. Instead, the existing group is used for determining the price item pricing.

If a pricing group is used while defining a pricing rule for a bill group, the system fetches the pricing rule for a claim transaction when the following conditions are met:

- The paid date of the claim transaction falls within the pricing rule's date range.

- The employee attributes specified in the claim transaction match the criteria defined in any one of the pricing group rule.

Let us understand this with the help of an example. A claim transaction is received with the following details:

- UDF_CHAR_1 is set to X
- UDF_CHAR_2 is set to Western
- UDF_CHAR_3 is set to Indian
- UDF_CHAR_4 is set to HR
- UDF_CHAR_5 is set to Permanent
- UDF_DATE_1 is set to 04-06-2018
- Transaction Record Type is set to TR1

Let us assume that the following pricing structure is defined in the system:

Transaction Record Type	Primary Pricing Rule Type	Price Item	Pricing Rule	Pricing Start Date	Pricing End Date	Pricing Group	Rule 1	Rule 2
TR1	CLAIM	PP1	PR1	01-01-2018	31-12-2018	PG1	Source System = X, Parameter 1 = Western, Parameter 2 = Indian, Parameter 3 = HR, and Parameter 4 = Permanent	Source System = X, Parameter 1 = Eastern, and Parameter 2 = Indian, Parameter 3 = HR, and Parameter 4 = Permanent

Note: Here, the source system is mapped to the **UDF_CHAR_1** field, the parameter 1 is mapped to the **UDF_CHAR_2** field, the parameter 2 is mapped to the **UDF_CHAR_3** field, the parameter 3 is mapped to the **UDF_CHAR_4** field, the parameter 4 is mapped to the **UDF_CHAR_5** field, and the paid date is mapped to the **UDF_DATE_1** field in the CLAIM pricing rule type.

Example 4: Effective Pricing Rule is Defined Using a Pricing Group

In the example 4, the system considers the PR1 pricing rule for PP1 because of the following reasons:

- The paid date (i.e. 04-06-2018) of the claim transaction falls within the PR1 pricing rule's date range (i.e. 01-01-2018 to 31-12-2018).
- The employee attributes specified in the claim transaction match the criteria defined in the Rule 1 (i.e. Source System = X, Location = Western, Nationality = Indian, Employee Department = HR, and Employee Status = Permanent)

The system then stores the pricing group rule which is satisfied against a parameter which is defined in the **Pricing Group Rule Parameter** option type of the **C1-ASOBLLNG** feature configuration. In the example 4, the price item parameter group is created and it contains the pricing group rule parameter. For example, Group A contains Pricing Group Rule Parameter = Rule 1.

In the example 4, the system could find the exact match for pricing parameters defined in the pricing group rule. However, if the exact match is not available, the system finds the effective pricing rule using the best fit match for the pricing parameters defined in the pricing group rule. Note that the system searches for the exact match in the effective pricing rules at both the bill group and parent customer levels. If the exact match is not available at both the levels, the system finds the effective pricing rule using the best fit match for the pricing parameters (defined in the pricing group rule) first at the bill group level and then at the parent customer level.

Let us understand this with the help of an example. A claim transaction is received with the following details:

- UDF_CHAR_1 is set to X
- UDF_CHAR_2 is set to Western
- UDF_CHAR_3 is set to Indian
- UDF_CHAR_4 is set to HR
- UDF_CHAR_5 is set to Permanent
- UDF_DATE_1 is set to 04-06-2018
- Transaction Record Type is set to TR2

Let us assume that the following pricing structure is defined in the system:

Transaction Record Type	Primary Pricing Rule Type	Price Item	Pricing Rule	Pricing Start Date	Pricing End Date	Pricing Group	Rule 1	Rule 2
TR2	CLM	PP1	PR1	01-01-2018	31-12-2018	PG1	Source System = X and Parameter 1 = Western	Source System = X and Parameter 1 = Eastern
		PP2	PR2	01-01-2018	31-12-2018	PG2	Source System = X, Parameter 1 = Eastern, Parameter 2 = Indian, Parameter 3 = HR, and Parameter 4 = Permanent	Source System = X, Parameter 1 = Western, Parameter 2 = Indian, Parameter 3 = HR, and Parameter 4 = Permanent

Note: Here, the source system is mapped to the **UDF_CHAR_1** field, the parameter 1 is mapped to the **UDF_CHAR_2** field, the parameter 2 is mapped to the **UDF_CHAR_3** field, the parameter 3 is mapped to the **UDF_CHAR_4** field, the parameter 4 is mapped to the **UDF_CHAR_5** field, and the paid date is mapped to the **UDF_DATE_1** field in the CLM pricing rule type.

Example 5: Effective Pricing Rule Derivation Using Best Fit Match for Pricing Parameters

In the example 5, the system could not find the exact match for the pricing parameters (i.e. Source System = X, Parameter 1 = Western, Parameter 2 = Indian, Parameter 3 = HR, and Parameter 4 = Permanent) in the effective pricing rule for PP1. Therefore, the system searches for the best fit match. While searching for the best fit match, the system rules out the optional parameter 4 (i.e. Parameter 4 = Permanent) and then checks whether the pricing group rule where Source System = X, Parameter 1 = Western, Parameter 2 = Indian, and Parameter 3 = HR exists in the effective pricing rule. If so, it considers PR1 as the effective pricing rule for PP1. If not, the system then rules out the optional parameter 3 (i.e. Parameter 3 = HR) and then checks whether the pricing group rule where Source System = X, Parameter 1 = Western, and Parameter 2 = Indian exists in the effective pricing rule. If so, it considers PR1 as the effective pricing rule for PP1. If not, the system then rules out the optional parameter 2 (i.e. Parameter 2 = Indian) and then checks whether the pricing group rule where Source System = X and Parameter 1 = Western exists in the effective pricing rule. If so, it considers PR1 as the effective pricing rule for PP1. If not, the status of the transaction is changed to **Error**.

In the example 5, the system considers Rule 1 where Source System = X and Parameter 1 = Western as the best fit match, and therefore fetches PR1 as the effective pricing rule for PP1. In addition, the system fetches PR2 as the effective pricing rule for PP2. The system creates two price item parameter groups — One contains Pricing Group Rule Parameter = Rule 1 and another contains Pricing Group Rule Parameter = Rule 2. Once the price item parameter group is created, the system creates the aggregation parameter group. An aggregation parameter group contains all price item parameters included in the pricing rule type for which the parameter usage is set to **Aggregation**.

Note: We recommend that you should only include the optional aggregation price item parameters in the pricing rule types where the pricing rule type category is set to **Claim**. Otherwise, erroneous results might occur.

If the effective pricing rule is not derived for a price item or if the account or active contract for the account is not derived, the system does not create a transaction leg for the respective price item. Let us understand this with the help of an example:

Price Item	Effective Pricing Rule	Account	Active Contract	Transaction Leg
PP1	-	-	-	-
PP2	PR2	-	-	-
PP3	PR3	A3	C3	TL1
PP4	-	-	-	-
PP5	PR5	A2	C1	TL2
PP6	PR6	A1	-	-

Example 6: No. of Transaction Legs Derived

In the example 6, the system could not find the effective pricing rule for PP1 and PP4, the required account for PP2, and the active contract for PP6 on A1. Therefore, in this case, the system creates two transaction legs — TL1 and TL2 for the claim transaction.

If the eligibility rule type is defined of a price item, the system maps the claim transaction to the price item when the eligibility rule is satisfied. If the eligibility rule is not satisfied, the system does not consider the price item for billing. For example,

Price Item	Eligibility Criteria Met	Effective Pricing Rule	Account	Active Contract	Transaction Leg
PE1	Yes	PR1	A1	C1	TL1
PE2	-	PR2	-	-	-
PE3	No	-	-	-	-
PE4	Yes	-	-	-	-
PE5	Yes	PR3	A2	-	-
PE6	Yes	PR4	-	-	-

Example 7: Price Item Eligibility for Transaction Leg Derivation

In the example 7, the eligibility criteria was defined for PE1, PE3, PE4, PE5, and PE6. The eligibility criteria was satisfied for PE1, PE4, PE5, and PE6, but not for PE3. Further, the system could not find the effective pricing rule for PE4, the required account for PE2 and PE6, and the active contract for PE5 on A2. Therefore, in this case, the system creates one transaction leg (i.e. TL1) for the claim transaction. For more information, refer to the [Price Item Eligibility](#) on page 2950 section.

Once a transaction leg is created, the derivation date is set as the processing date corresponding to the transaction leg.

Account and Price Item Derivation (for the Specific Stop-Loss and Aggregate Stop-Loss Pricing Rule Type Categories)

Once the **Validate Transaction and Derive Price Item (C1-TXNIP)** batch calls the primary pricing rule type specified in the transaction record type, it calls the related pricing rule types (if any) defined in the primary pricing rule type. Note that the related pricing rule types are called one by one in the specified sequence. Let us understand this with the help of an example.

Primary Pricing Rule Type	Sequence	Related Pricing Rule Type
CLAIM	10	SPECIFIC STOP-LOSS
	20	AGGREGATE STOP-LOSS

Example 1: Related Pricing Rule Type Sequence

In the example 1, the system first calls the related pricing rule type with the highest sequence (i.e. 10) once the CLAIM pricing rule type is called. The system calls the related pricing rule type irrespective of whether the transaction legs are derived using the primary pricing rule type. Once the SPECIFIC STOP-LOSS pricing rule type is called, the system calls the related pricing rule type with the next sequence (i.e. 20). This process continues until all related pricing rule types defined in the primary pricing rule type are called one by one in the specified sequence.

If the eligibility rule type is defined for a related pricing rule type, the system considers the related pricing rule type for deriving the transaction legs when the eligibility rule is satisfied. If the eligibility rule is not satisfied, the system does not consider the related pricing rule type for deriving the transaction legs. Let us understand this with the help of an example.

Primary Pricing Rule Type	Sequence	Related Pricing Rule Type	Eligibility Criteria Met
CLAIM	10	SPECIFIC STOP-LOSS	Yes
	20	AGGREGATE STOP-LOSS	No

Example 2: Related Pricing Rule Type Eligibility Criteria

In the example 2, the eligibility criteria is defined for the SPECIFIC STOP-LOSS and AGGREGATE STOP-LOSS pricing rule types. However, the eligibility criteria for the AGGREGATE STOP-LOSS pricing rule type was not satisfied, and therefore it is not used for deriving the transaction legs.

The **Validate Transaction and Derive Price Item (C1-TXNIP)** batch maps a claim transaction to one or more price item and price item parameters which are defined in the eligible related pricing rule type. This is possible when you attach an algorithm created using the **C1_ACCPRISL** algorithm type to the **Account and Price Item Derivation** system event of the related pricing rule type.

Note: Ideally, the pricing rule types where the pricing rule type category is set to **Specific Stop-Loss** or **Aggregate Stop-Loss** should not have price item parameters for which the parameter usage is set to **Pricing**. This is because the system will not use these price item parameters while searching for an effective pricing rule for the respective price items.

This algorithm fetches an effective pricing rule for each price item specified in the related pricing rule type. It searches for an effective pricing rule for a price item at the bill group level. It derives an effective pricing rule for each price item using the incurred and paid dates specified in the claim transaction. It fetches an effective pricing rule where the following conditions are met:

- The incurred and paid dates of the claim transaction fall within the incurred and paid date ranges defined in the parent accumulation group (which is derived through the parent customer's pricing rule).
- A transaction leg is already created for at least one price item and price item parameters combination which is specified in the accumulation criteria.

For run-in claim transactions, this algorithm fetches an effective pricing rule where the following conditions are met:

- The run-in incurred and paid dates of the claim transaction fall within the run-in incurred and paid date ranges defined in the run-in accumulation group (which is derived through the parent customer's pricing rule).
- The effective pricing rule exists for at least one price item and price item parameters combination which is specified in the accumulation criteria.

For example, if the system receives a claim transaction with the following details:

- UDF_CHAR_1 is set to Western
- UDF_CHAR_2 is set to BG1
- UDF_DATE_1 is set to 18-02-2018
- UDF_DATE_2 is set to 28-02-2018
- Transaction Record Type is set to TR1

Let us assume that the following pricing structure is defined in the system:

Transaction Record Type	Primary Pricing Rule Type	Related Pricing Rule Type	Price Item in Related Pricing Rule Type	Pricing Rule	Incurred Date Range in Associated Parent Customer's Pricing Rule	Paid Date Range in Associated Parent Customer's Pricing Rule	Accumulation Criteria
					(i.e. in Parent Accumulation Group)		
TR1	CLAIM	SPECIFIC STOP-LOSS	S1	C1S1	01-01-2017 - 31-12-2017	01-01-2017 - 28-02-2018	Price Item: CLAIM, Price Item Parameters: Location = Western, Employee Group = BG1
				C2S1	01-01-2018 - 31-12-2018	01-01-2018 - 28-02-2019	Price Item: CLAIM, Price Item Parameters: Location = Western, Employee Group = BG1
							Price Item: CLM, Price Item Parameters: Location = Western, Employee Group = BG1
				S2	C1S2	01-01-2017 - 31-12-2017	01-01-2017 - 28-02-2018

Transaction Record Type	Primary Pricing Rule Type	Related Pricing Rule Type	Price Item in Related Pricing Rule Type	Pricing Rule	Incurred Date Range in Associated Parent Customer's Pricing Rule	Paid Date Range in Associated Parent Customer's Pricing Rule	Accumulation Criteria
					(i.e. in Parent Accumulation Group)		
				C2S2	01-01-2018 - 31-12-2018	01-01-2018 - 28-02-2019	Price Item: CLM, Price Item Parameters: Location = Western, Employee Group = BG1

Note:

Price Item in Primary Pricing Rule Type: CLM; Price Item Parameters in Primary Pricing Rule Type where the Eligible for Stop-Loss option is selected: Location = UDF_CHAR_1 and Employee Group = UDF_CHAR_2.

Here, the incurred date is mapped to the **UDF_DATE_1** field and the paid date is mapped to the **UDF_DATE_2** field in the CLAIM pricing rule type.

Example 3: SSL and ASL Effective Pricing Rule Derivation for Claim Transaction

In the example 3, the system fetches the C2S1 and C2S2 pricing rules for S1 and S2, respectively, because of the following reasons:

- Incurred date mentioned in the claim transaction falls within the incurred date range (i.e. 01-01-2018 - 31-12-2018) defined in the parent accumulation group.
- Paid date mentioned in the claim transaction falls within the paid date range (i.e. 01-01-2018 - 28-02-2019) defined in the parent accumulation group.
- A transaction leg already exists for the following price item and price item parameters combination which is specified in the accumulation criteria of the C2S1 and C2S2 pricing rules:
 - Price Item: CLM, Price Item Parameters: Location = Western and Employee Group = BG1

Let us take another example where the system receives a run-in claim transaction with the following details:

- UDF_CHAR_1 is set to Eastern
- UDF_CHAR_3 is set to Active
- UDF_DATE_3 is set to 18-06-2017
- UDF_DATE_4 is set to 01-07-2017
- Transaction Record Type is set to TR2

Let us assume that the following pricing structure is defined in the system:

Transaction Record Type	Primary Pricing Rule Type	Related Pricing Rule Type	Price Item in Related Pricing Rule Type	Pricing Rule	Run-in Incurred Date Range in Associated Parent Customer's Pricing Rule	Run-in Paid Date Range in Associated Parent Customer's Pricing Rule	Accumulation Criteria
					(i.e. in Run-in Accumulation Group)		
TR2	CLAIM	AGGREGATE STOP-LOSS	AS1	C1AS1	01-01-2017 - 31-12-2017	01-01-2017 - 28-02-2018	Price Item: CLAIM, Price Item Parameters: Location = Eastern, Employee Status = Active
				C2AS1	01-01-2018 - 31-12-2018	01-01-2018 - 28-02-2019	Price Item: CLAIM, Price Item Parameters: Location = Eastern, Employee Status = Active
			AS2	C1AS2	01-01-2017 - 31-12-2017	01-01-2017 - 28-02-2018	Price Item: CLM, Price Item Parameters: Location = Eastern, Employee Status = Active
				C2AS2	01-01-2018 - 31-12-2018	01-01-2018 - 28-02-2019	Price Item: CLM, Price Item Parameters: Location = Eastern, Employee Status = Active
				C1AS1	01-01-2017 - 31-12-2017	01-01-2017 - 28-02-2018	Price Item: CLM, Price Item Parameters: Location = Eastern, Employee Status = Active
				C2AS1	01-01-2018 - 31-12-2018	01-01-2018 - 28-02-2019	Price Item: CLM, Price Item Parameters: Location = Eastern, Employee Status = Active

Note:
 Price Items in Primary Pricing Rule Type: CLAIM and CLM; Price Item Parameters in Primary Pricing Rule Type where the Eligible for Stop-Loss option is selected: Location = UDF_CHAR_1 and Employee Status = UDF_CHAR_3. Here, the run-in incurred date is mapped to the UDF_DATE_3 field and the run-in paid date is mapped to the UDF_DATE_4 field in the CLAIM pricing rule type.

Example 4: SSL and ASL Effective Pricing Rule Derivation for Run-in Claim Transaction

In the example 4, the system fetches the C1AS1 and C1AS2 pricing rules for AS1 and AS2, respectively, because of the following reasons:

- Run-in incurred date mentioned in the claim transaction falls within the run-in incurred date range (i.e. 01-01-2017 - 31-12-2017) defined in the run-in accumulation group.
- Run-in paid date mentioned in the claim transaction falls within the run-in paid date range (i.e. 01-01-2017 - 28-02-2018) defined in the run-in accumulation group.
- An effective pricing rule exists for the following price item and price item parameters combination which is specified in the accumulation criteria of the C1AS1 and C1AS2 pricing rules:
 - Price Item: CLAIM, Price Item Parameters: Location = Eastern, Employee Status = Active
 - Price Item: CLM, Price Item Parameters: Location = Eastern, Employee Status = Active

The system then checks whether the ASSL Credit Account (in case of specific stop-loss pricing rule) and ASL Credit Account (in case of aggregate stop-loss pricing rule) is specified in the associated parent customer's pricing rule. If so, the system considers the respective account for billing. Otherwise, the system derives the account with a particular invoice type (to which a price item must be billed) based on the priority which is defined for the respective price item in the related pricing rule type. For example,

Related Pricing Rule Type	Price Item	Priority	Invoice Type	Account
SPECIFIC STOP-LOSS	S1	10	Standard	A1
		20	Retention	A2
	S2	10	Retention	A2
		20	Standard	A1

Example 5: Priority Based Account Derivation

In the example 5, while mapping the claim transaction to S1, the system checks whether an account where the **Invoice Type (C1INVTYP)** characteristic is set to **Standard** exists for the bill group. If so, it considers the standard account (A1) of the bill group for billing. However, if an account where the **Invoice Type (C1INVTYP)** characteristic is set to **Standard** does not exist for the bill group, the system checks whether an account where the **Invoice Type (C1INVTYP)** characteristic is set to **Retention** exists for the bill group. If so, it considers the retention account (A2) of the bill group for billing. If an account where the **Invoice Type (C1INVTYP)** characteristic is set to **Retention** does not exist for the bill group, the status of the transaction is changed to **Error**.

Similarly, while mapping the claim transaction to S2, the system considers the account of the bill group which is available based on the priority. The system derives the billing account for only those price items for which the effective pricing rule is derived.

Note: The characteristic type which indicates the type of account (for example, **C1INVTYP**) must be specified in the **Invoice Type Characteristic Type** option type of the **C1-ASOBLLNG** feature configuration. Otherwise, erroneous results might occur.

Once the account is derived, the system then checks whether the account has one active contract of the contract type which is associated with the price item. If so, it fetches the contract for further processing. Once the effective pricing rule, account, and active contract are derived, the transaction is mapped to the respective price item, price item parameters, and account. A transaction leg is created for each price item, price item parameters, and account combination. For example, if the claim transaction is mapped to the following price item and account combinations:

Transaction Record Type	Primary Pricing Rule Type	Related Pricing Rule Type	Price Item in Related Pricing Rule Type	Effective Pricing Rule	Account	Active Contract	Transaction Leg
TR1	CLAIM	SPECIFIC STOP-LOSS	S3	PRS3	A1	C3	TL3
			S4	PRS4	A2	C4	TL4

Example 6: Transaction Leg Derivation

In the example 6, the system creates two transaction legs — TL3 and TL4 for the claim transaction. Once a transaction leg is created, the respective effective pricing rule is stamped against the transaction leg. Usually, once a transaction leg is created in the **Validate Transaction and Derive Price Item (C1-TXNIP)** batch, the price item parameters (for which the parameter usage is set to **Pricing**) of the transaction leg are grouped. The system does not support multiple parameter based pricing for the pricing rule types where the pricing rule type category is set to **Specific Stop-Loss** and **Aggregate Stop-Loss**. Therefore, when the price item parameters are not specified, the price item parameter group ID is set to 1 corresponding to each transaction leg — TL3 and TL4.

Note: A price item parameter group is used to determine the price item pricing. A unique group ID is generated for each group. If a group with a set of price item parameters already exists in the system, a new group is not created. Instead, the existing group is used for determining the price item pricing.

If a pricing group is used while defining a pricing rule for a bill group, the system fetches the pricing rule for a claim transaction when the following conditions are met:

- The incurred and paid dates of the claim transaction fall within the incurred and paid date ranges defined in the parent accumulation group (which is derived through the parent customer's pricing rule).
- A transaction leg is already created for at least one price item and price item parameters combination which is specified in the accumulation criteria.
- The employee attributes specified in the claim transaction match the criteria defined in any one of the pricing group rule.

Similarly, the system will fetch the pricing rule for a run-in claim transaction when the following conditions are met:

- The run-in incurred and paid dates of the claim transaction fall within the run-in incurred and paid date ranges defined in the run-in accumulation group (which is derived through the parent customer's pricing rule).
- The effective pricing rule exists for at least one price item and price item parameters combination which is specified in the accumulation criteria.
- The employee attributes specified in the run-in claim transaction match the criteria defined in any one of the pricing group rule.

Let us understand this with the help of an example. A claim transaction is received with the following details:

- UDF_CHAR_1 is set to X
- UDF_CHAR_2 is set to Western
- UDF_CHAR_3 is set to Indian
- UDF_CHAR_4 is set to HR
- UDF_CHAR_5 is set to Permanent
- UDF_CHAR_6 is set to Senior Manager
- UDF_CHAR_7 is set to BG1
- UDF_DATE_1 is set to 31-12-2018

- UDF_DATE_2 is set to 28-02-2019
- Transaction Record Type is set to TR1

Transaction Record Type	Primary Pricing Rule Type	Related Pricing Rule Type	Price Item in Related Pricing Rule Type	Pricing Rule	Incurred Date Range in Associated Parent Customer's Pricing Rule	Paid Date Range in Associated Parent Customer's Pricing Rule	Pricing Group	Pricing Group Rule	Accumulation Criteria
					(i.e. in Parent Accumulation Group)				
TR1	CLAIM	SPECIFIC STOP-LOSS	S1	PR1	01-01-2018 - 31-12-2018	01-01-2018 - 28-02-2019	PG1	Rule 1 (where Source System = X, Parameter 1 = Western, Parameter 2 = Indian, Parameter 3 = HR, and Parameter 4 = Permanent)	Price Item: CLM; Price Item Parameters: Designation = Senior Manager and Employee Group = BG1
								Rule 1 (where Source System = X, Parameter 1 = Western, Parameter 2 = Indian, Parameter 3 = HR, and Parameter 4 = Permanent)	Price Item: CLM; Price Item Parameters: Designation = Senior Manager and Employee Group = BG2

Transaction Record Type	Primary Pricing Rule Type	Related Pricing Rule Type	Price Item in Related Pricing Rule Type	Pricing Rule	Incurred Date Range in Associated Parent Customer's Pricing Rule	Paid Date Range in Associated Parent Customer's Pricing Rule	Pricing Group	Pricing Group Rule	Accumulation Criteria
					(i.e. in Parent Accumulation Group)				
								Rule 2 (where Source System = X, Parameter 1 = Eastern, and Parameter 2 = Indian, Parameter 3 = HR, and Parameter 4 = Permanent)	Price Item: CLM; Price Item Parameters: Designation = Senior Manager and Employee Group = BG1
								Rule 2 (where Source System = X, Parameter 1 = Eastern, and Parameter 2 = Indian, Parameter 3 = HR, and Parameter 4 = Permanent)	Price Item: CLM; Price Item Parameters: Designation = Senior Manager and Employee Group = BG2

Note:

Price Item in Primary Pricing Rule Type: CLM; Price Item Parameters in Primary Pricing Rule Type where the Eligible for Stop-Loss option is selected: Designation = UDF_CHAR_6 and Employee Group = UDF_CHAR_7.

Here, the source system is mapped to the **UDF_CHAR_1** field, the parameter 1 is mapped to the **UDF_CHAR_2** field, the parameter 2 is mapped to the **UDF_CHAR_3** field, the parameter 3 is mapped to the **UDF_CHAR_4** field, the parameter 4 is mapped to the **UDF_CHAR_5** field, the incurred date is mapped to the **UDF_DATE_1** field, and the paid date is mapped to the **UDF_DATE_2** field in the CLAIM pricing rule type.

Example 7: Effective Pricing Rule is Defined Using a Pricing Group

In the example 7, the system considers the PR1 pricing rule for S1 because of the following reasons:

- Incurred date mentioned in the claim transaction falls within the incurred date range (i.e. 01-01-2018 - 31-12-2018) defined in the parent accumulation group.
- Paid date mentioned in the claim transaction falls within the paid date range (i.e. 01-01-2018 - 28-02-2019) defined in the parent accumulation group.
- The employee attributes specified in the claim transaction match the criteria defined in the Rule 1 (i.e. Source System = X, Parameter 1 = Western, Parameter 2 = Indian, Parameter 3 = HR, and Parameter 4 = Permanent).
- A transaction leg already exists for the following price item and price item parameters combination which is specified in the accumulation criteria of the PR1 pricing rule:
 - Price Item: CLM; Price Item Parameters: Designation = Senior Manager and Employee Group = BG1

The system then stores the pricing group rule which is satisfied against a parameter which is defined in the **Pricing Group Rule Parameter** option type of the **C1-ASOBLLNG** feature configuration. In the example 7, the price item parameter group is created and it contains the pricing group rule parameter. For example, Group A contains Pricing Group Rule Parameter = Rule 1.

In the example 7, the system could find the exact match for pricing parameters defined in the pricing group rule. However, if the exact match is not available, the system finds the effective pricing rule using the best fit match for the pricing parameters defined in the pricing group rule. Let us understand this with the help of an example. A claim transaction is received with the following details:

- UDF_CHAR_1 is set to X
- UDF_CHAR_2 is set to Western
- UDF_CHAR_3 is set to Indian
- UDF_CHAR_4 is set to HR
- UDF_CHAR_5 is set to Permanent
- UDF_CHAR_6 is set to Senior Manager
- UDF_CHAR_7 is set to BG1
- UDF_DATE_1 is set to 06-06-2018
- UDF_DATE_2 is set to 27-06-2018
- Transaction Record Type is set to TR2

Let us assume that the following pricing structure is defined in the system:

Transaction Record Type	Primary Pricing Rule Type	Related Pricing Rule Type	Price Item in Related Pricing Rule Type	Pricing Rule	Incurred Date Range in Associated Parent Customer's Pricing Rule	Paid Date Range in Associated Parent Customer's Pricing Rule	Pricing Group	Pricing Group Rule	Accumulation Criteria
					(i.e. in Parent Accumulation Group)				
TR2	CLAIM	SPECIFIC STOP-LOSS	S1	PR1	01-01-2018 - 31-12-2018	01-01-2018 - 28-02-2019	PG1	Rule 1 (where Source System = X and Parameter 1 = Western)	Price Item: CLAIM; Price Item Parameters: Designation = Senior Manager; Employee Group = BG1
								Rule 1 (where Source System = X and Parameter 1 = Western)	Price Item: CLAIM; Price Item Parameters: Designation = Senior Manager; Employee Group = BG2
								Rule 2 (where Source System = X and Parameter 1 = Eastern)	Price Item: CLAIM; Price Item Parameters: Designation = Senior Manager; Employee Group = BG1
								Rule 2 (where Source System = X and Parameter 1 = Eastern)	Price Item: CLAIM; Price Item Parameters: Designation = Senior Manager; Employee Group = BG2

Transaction Record Type	Primary Pricing Rule Type	Related Pricing Rule Type	Price Item in Related Pricing Rule Type	Pricing Rule	Incurred Date Range in Associated Parent Customer's Pricing Rule	Paid Date Range in Associated Parent Customer's Pricing Rule	Pricing Group	Pricing Group Rule	Accumulation Criteria
					(i.e. in Parent Accumulation Group)				
			S2	PR2	01-01-2018 - 31-12-2018	01-01-2018 - 28-02-2019	PG2	<p>Rule 1 (where Source System = X, Parameter 1 = Eastern, Parameter 2 = Indian, Parameter 3 = HR, and Parameter 4 = Permanent)</p> <p>Rule 1 (where Source System = X, Parameter 1 = Eastern, Parameter 2 = Indian, Parameter 3 = HR, and Parameter 4 = Permanent)</p> <p>Rule 2 (where Source System = X, Parameter 1 = Western, Parameter 2 = Indian, Parameter 3 = HR, and Parameter 4 = Permanent)</p>	<p>Price Item: CLAIM; Price Item Parameters: Designation = Senior Manager; Employee Group = BG2</p> <p>Price Item: CLAIM; Price Item Parameters: Designation = Senior Manager; Employee Group = BG1</p> <p>Price Item: CLAIM; Price Item Parameters: Designation = Senior Manager; Employee Group = BG2</p>

Transaction Record Type	Primary Pricing Rule Type	Related Pricing Rule Type	Price Item in Related Pricing Rule Type	Pricing Rule	Incurred Date Range in Associated Parent Customer's Pricing Rule	Paid Date Range in Associated Parent Customer's Pricing Rule	Pricing Group	Pricing Group Rule	Accumulation Criteria
					(i.e. in Parent Accumulation Group)				
								Rule 2 (where Source System = X, Parameter 1 = Western, Parameter 2 = Indian, Parameter 3 = HR, and Parameter 4 = Permanent)	Price Item: CLAIM; Price Item Parameters: Designation = Senior Manager; Employee Group = BG1

Note:

Price Item in Primary Pricing Rule Type: CLAIM; Price Item Parameters in Primary Pricing Rule Type where the Eligible for Stop-Loss option is selected: Designation = UDF_CHAR_6 and Employee Group = UDF_CHAR_7.

Here, the source system is mapped to the **UDF_CHAR_1** field, the parameter 1 is mapped to the **UDF_CHAR_2** field, the parameter 2 is mapped to the **UDF_CHAR_3** field, the parameter 3 is mapped to the **UDF_CHAR_4** field, the parameter 4 is mapped to the **UDF_CHAR_5** field, the incurred date is mapped to the **UDF_DATE_1** field, and the paid date is mapped to the **UDF_DATE_2** field in the CLAIM pricing rule type.

Example 8: Effective Pricing Rule Derivation Using Best Fit Match for Pricing Parameters

In the example 8, the system could not find the exact match for the pricing parameters (i.e. Source System = X, Parameter 1 = Western, Parameter 2 = Indian, Parameter 3 = HR, and Parameter 4 = Permanent) in the effective pricing rule for S1. Therefore, the system searches for the best fit match. While searching for the best fit match, the system rules out the optional parameter 4 (i.e. Parameter 4 = Permanent) and then checks whether the pricing group rule where Source System = X, Parameter 1 = Western, Parameter 2 = Indian, and Parameter 3 = HR exists in the effective pricing rule. If so, it considers the pricing group rule for further processing. If not, the system then rules out the optional parameter 3 (i.e. Parameter 3 = HR) and then checks whether the pricing group rule where Source System = X, Parameter 1 = Western, and Parameter 2 = Indian exists in the effective pricing rule. If so, it considers the pricing group rule for further processing. If not, the system then rules out the optional parameter 2 (i.e. Parameter 2 = Indian) and then checks whether the pricing group rule where Source System = X and Parameter 1 = Western exists in the effective pricing rule. If so, it considers the pricing group rule for further processing. If not, the status of the transaction is changed to **Error**.

In the example 8, the system considers Rule 1 where Source System = X and Parameter 1 = Western as the best fit match in the PR1 pricing rule for S1. In addition, a transaction leg already exists for the following price item and price item parameters combination which is specified in the accumulation criteria of the PR1 pricing rule:

- Price Item: CLAIM; Price Item Parameters: Designation = Senior Manager; Employee Group = BG1

Therefore, the system fetches PR1 as the effective pricing rule for S1. In addition, the system fetches PR2 as the effective pricing rule for S2. The system creates two price item parameter groups — One contains Pricing Group Rule Parameter = Rule 1 and another contains Pricing Group Rule Parameter = Rule 2. Once the price item parameter group is created,

the system creates the aggregation parameter group. An aggregation parameter group contains all price item parameters included in the related pricing rule type for which the parameter usage is set to **Aggregation**.

If the effective pricing rule is not derived for a price item or if the account or active contract for the account is not derived, the system does not create a transaction leg for the respective price item. Let us understand this with the help of an example:

Related Pricing Rule Type	Price Item	Effective Pricing Rule	Account	Active Contract	Transaction Leg
AGGREGATE STOP-LOSS	AS11	-	-	-	-
	AS12	PR12	A1	C1	TL11
	AS13	PR13	-	-	-
	AS14	PR14	A2	-	-
	AS15	PR15	-	-	-
	AS16	-	-	-	-
	AS17	PR17	A2	C2	TL12

Example 9: No. of Transaction Legs Derived

In the example 9, the system could not find the effective pricing rule for AS11 and AS16, the required account for AS13 and AS15, and the active contract for AS14 on A2. Therefore, in this case, the system creates two transaction legs — TL11 and TL12 for the transaction.

If the eligibility rule type is defined for a price item, the system maps the transaction to the price item when the eligibility rule is satisfied. If the eligibility rule is not satisfied, the system does not consider the price item for billing. For example,

Sequence	Related Pricing Rule Type	Rule Type Eligibility Criteria Met	Price Item	Price Item Eligibility Criteria Met	Effective Pricing Rule	Account	Active Contract	Transaction Leg
10	SPECIFIC STOP-LOSS	Yes	SS1	Yes	PR1	A1	C1	TL1
			SS2	-	PR2	A2	C2	TL2
			SS3	No	-	-	-	-
20	AGGREGATE STOP-LOSS	No	AS4	-	-	-	-	-
			AS5	-	-	-	-	-
			AS6	-	-	-	-	-

Example 10: Price Item Eligibility for Transaction Leg Derivation

In the example 10, the eligibility criteria is defined for the SPECIFIC STOP-LOSS and AGGREGATE STOP-LOSS pricing rule types. However, the eligibility criteria for the AGGREGATE STOP-LOSS pricing rule type was not satisfied, and therefore it is not used for deriving the transaction legs. The eligibility criteria for SS1 was satisfied, but the eligibility criteria for SS3 was not satisfied. Therefore, in this case, the system creates two transaction legs (i.e. TL1 and TL2) for the claim transaction. For more information about the related pricing rule type eligibility and price item eligibility features, refer to the [Related Pricing Rule Type Eligibility](#) on page 2948 and [Price Item Eligibility](#) on page 2950 sections, respectively.

Once a transaction leg is created, the effective pricing rule's start date is set as the processing date corresponding to the transaction leg.

Account and Price Item Derivation (for the Retention Type Claim Based Pricing Rule Type Category)

Once the **Validate Transaction and Derive Price Item (C1-TXNIP)** batch calls the primary pricing rule type specified in the transaction record type, it calls the related pricing rule types (if any) defined in the primary pricing rule type. Note that the related pricing rule types are called one by one in the specified sequence. Let us understand this with the help of an example.

Primary Pricing Rule Type	Sequence	Related Pricing Rule Type
CLAIM	10	RETENTION TYPE CLAIM BASED
	20	SPECIFIC STOP-LOSS
	30	AGGREGATE STOP-LOSS

Example 1: Related Pricing Rule Type Sequence

In the example 1, the system first calls the related pricing rule type with the highest sequence (i.e. 10) once the CLAIM pricing rule type is called. The system calls the related pricing rule type irrespective of whether the transaction legs are derived using the primary pricing rule type. Once the RETENTION TYPE CLAIM BASED pricing rule type is called, the system calls the related pricing rule type with the next sequence (i.e. 20). This process continues until all related pricing rule types defined in the primary pricing rule type are called one by one in the specified sequence.

If the eligibility rule type is defined for a related pricing rule type, the system considers the related pricing rule type for deriving the transaction legs when the eligibility rule is satisfied. If the eligibility rule is not satisfied, the system does not consider the related pricing rule type for deriving the transaction legs. Let us understand this with the help of an example.

Primary Pricing Rule Type	Sequence	Related Pricing Rule Type	Eligibility Criteria Met
CLAIM	10	RETENTION TYPE CLAIM BASED	Yes
	20	CLAIM BASED FEES	-
	30	CLAIM FEE CHARGES	No

Example 2: Related Pricing Rule Type Eligibility Criteria

In the example 2, the eligibility criteria is defined for the RETENTION TYPE CLAIM BASED and CLAIM FEE CHARGES pricing rule types. However, the eligibility criteria for the CLAIM FEE CHARGES pricing rule type was not satisfied, and therefore it is not used for deriving the transaction legs.

The **Validate Transaction and Derive Price Item (C1-TXNIP)** batch maps a claim transaction to one or more price item and price item parameters which are defined in the eligible related pricing rule type. This is possible when you attach an algorithm created using the **C1_ACCPRIDRV** algorithm type to the **Account and Price Item Derivation** system event of the related pricing rule type.

This algorithm fetches the effective pricing rule for each price item and price item parameters combination specified in the related pricing rule type on the derivation date. The system considers the paid date as the derivation date. This algorithm first searches for the effective pricing rule for a price item and price item parameters combination which is defined for the policy at the bill group level. If the system does not find any effective pricing rule for a price item and price item parameters combination which is defined for the policy at the bill group level, it inherits the effective pricing rule for a price item and price item parameters combination from the parent customer level.

For example, if the system receives a claim transaction with the following details:

- UDF_DATE_1 is set to 15-01-2018
- Transaction Record Type is set to TR1

Let us assume that the following pricing structure is defined in the system:

Transaction Record Type	Primary Pricing Rule Type	Related Pricing Rule Type	Price Item in Related Pricing Rule Type	Pricing Rule	Pricing Start Date	Pricing End Date	Assignment Level
TR1	CLAIM	RETENTION TYPE CLAIM BASED	P3	C1P3	01-01-2018	31-12-2018	Parent Customer
				C2P3	01-01-2018	31-12-2018	Bill Group
			P4	C1P4	01-01-2018	31-12-2018	Parent Customer
				C2P4	01-01-2019	30-06-2019	Bill Group

Note: Here, the paid date is mapped to the UDF_DATE_1 field in the CLAIM pricing rule type.

Example 3: Effective Pricing Rule Derivation

In the example 3, the system fetches C2P3 and C1P4 pricing rules for P3 and P4 respectively, which are effective on the paid date. Note that the effective pricing rule for P3 is derived at the bill group level, whereas the effective pricing rule for P4 is derived from the parent customer level.

While fetching the effective pricing rule, the system first searches for the exact match for the price item parameters at both the levels. For example, if the system receives a claim transaction with the following details:

- UDF_CHAR_1 is set to Western
- UDF_CHAR_2 is set to Active
- UDF_DATE_1 is set to 20-03-2018
- Transaction Record Type is set to TR4

Let us assume that the following pricing structure is defined in the system:

Transaction Record Type	Primary Pricing Rule Type	Related Pricing Rule Type	Price Item in Related Pricing Rule Type	Price Item Parameters in Related Pricing Rule Type	Pricing Rule	Pricing Start Date	Pricing End Date	Price Item Parameters in Pricing Rule	Fees	Assignment Level
TR4	CLAIM	CLAIM BASED CHARGES	P1	Location = UDF_CHAR_1 and Employee Status = UDF_CHAR_2	C1P1	01-01-2018	31-12-2018	Location = Western and Employee Status = Active	\$10	Parent Customer
								Location = Eastern and Employee Status = Active	\$12	

Transaction Record Type	Primary Pricing Rule Type	Related Pricing Rule Type	Price Item in Related Pricing Rule Type	Price Item Parameters in Related Pricing Rule Type	Pricing Rule	Pricing Start Date	Pricing End Date	Price Item Parameters in Pricing Rule	Fees	Assignment Level
								Location = Eastern and Employee Status = Retired	\$11	
								Location = Western and Employee Status = Retired	\$9	
					C2P1	01-01-2018	31-12-2018	Location = Western and Employee Status = Active	\$8	Bill Group
								Location = Eastern and Employee Status = Active	\$9	
								Location = Eastern and Employee Status = Retired	\$10	
								Location = Western and Employee Status = Retired	\$9	

Note: Here, the paid date is mapped to the UDF_DATE_1 field in the CLAIM pricing rule type.

Example 4: Exact Match for Price Item Parameters

In the example 4, the system fetches the C2P1 pricing rule for P1 because of the following reasons:

- The paid date (i.e. 20-03-2018) of the claim transaction falls within the date range (i.e. 01-01-2018 to 31-12-2018) of the C2P1 pricing rule which is defined at the bill group level.
- It contains the exact match for the price item parameters which are received in the transaction.

If the system cannot find the exact match for the price item parameters at both the levels, it searches for the best fit match for the price item parameters first at the bill group level and then at the parent customer level. For example, if the system receives a claim transaction with the following details:

- UDF_CHAR_1 is set to Western
- UDF_CHAR_2 is set to Active
- UDF_CHAR_3 is set to HR
- UDF_CHAR_4 is set to Indian
- UDF_DATE_1 is set to 07-06-2018
- Transaction Record Type is set to TR5

Let us assume that the following pricing structure is defined in the system:

Transaction Record Type	Primary Pricing Rule Type	Related Pricing Rule Type	Price Item in Related Pricing Rule Type	Price Item Parameters in Related Pricing Rule Type	Pricing Rule	Pricing Start Date	Pricing End Date	Price Item Parameters in Pricing Rule	Fees	Assignment Level
TR5	CLAIM	RETENTION CLAIM BASED FEES	P3	Location = UDF_CHAR_1, Employee Status = UDF_CHAR_2, Employee Department = UDF_CHAR_3, and Nationality = UDF_CHAR_4	C1P3	01-01-2018	31-12-2018	Location = Western and Employee Status = Active	\$10	Bill Group
								Location = Eastern and Employee Status = Active	\$12	
								Location = Eastern and Employee Status = Retired	\$11	
								Location = Western and Employee Status = Retired	\$9	

Note: Here, the paid date is mapped to the **UDF_DATE_1** field in the CLAIM pricing rule type.

Example 5: Best Fit Match for Price Item Parameters

Note: The **Location** and **Employee Status** parameters are mandatory for P3. However, the **Employee Department** and **Nationality** parameters are optional with the priority set to 1 and 2, respectively.

In the example 5, the system could not find the exact match for the price item parameters (i.e. Location = Western, Employee Status = Active, Employee Department = HR, and Nationality = Indian) in the effective pricing rule for P3. Therefore, the system searches for the best fit match. While searching for the best fit match, the system rules out the optional parameter with lowest priority (i.e. Nationality = Indian) and checks whether pricing is defined for the price item parameters (i.e. Location = Western, Employee Status = Active, and Employee Department = HR) in the effective pricing rule. If so, it considers C1P3 as the effective pricing rule for P3. If not, the system rules out the optional parameter with the next lowest priority (i.e. Employee Department = HR) and checks whether pricing is defined for the price item parameters (i.e. Location = Western and Employee Status = Active) in the effective pricing rule. If so, it considers C1P3 as the effective pricing rule for P3. If not, the status of the transaction is changed to **Error**.

In the example 5, the system considers pricing defined for the price item parameters (i.e. Location = Western and Employee Status = Active) as the best fit match, and therefore fetches C1P3 as the effective pricing rule for P3. While fetching the effective pricing rule, the system considers only those price item parameters specified in the related pricing rule type for which the parameter usage is set to **Pricing**.

The system then derives the account with a particular invoice type (to which a price item must be billed) based on the priority which is defined for the respective price item in the related pricing rule type. For example,

Related Pricing Rule Type	Price Item	Priority	Invoice Type	Account
RETENTION TYPE CLAIM BASED	P3	10	Standard	A1
	P4	10	Retention	A2
		20	Standard	A1

Example 6: Priority Based Account Derivation

In the example 6, while mapping the claim transaction to P3, the system checks whether an account where the **Invoice Type (C1INVTYP)** characteristic is set to **Standard** exists for the bill group. If so, it considers the standard account (A1) of the bill group for billing. However, if an account where the **Invoice Type (C1INVTYP)** characteristic is set to **Standard** does not exist for the bill group, the status of the transaction is changed to **Error**.

Similarly, while mapping the claim transaction to P4, the system checks whether an account where the **Invoice Type (C1INVTYP)** characteristic is set to **Retention** exists for the bill group. If so, it considers the retention account (A2) of the bill group for billing. However, if an account where the **Invoice Type (C1INVTYP)** characteristic is set to **Retention** does not exist for the bill group, the system checks whether an account where the **Invoice Type (C1INVTYP)** characteristic is set to **Standard** exists for the bill group. If so, it considers the standard account (A1) of the bill group for billing. If an account where the **Invoice Type (C1INVTYP)** characteristic is set to **Standard** does not exist for the bill group, the status of the transaction is changed to **Error**.

Note: The characteristic type which indicates the type of account (for example, **C1INVTYP**) must be specified in the **Invoice Type Characteristic Type** option type of the **C1-ASOBLLNG** feature configuration. Otherwise, erroneous results might occur.

Once the account is derived, the system then checks whether the account has one active contract of the contract type which is associated with the price item. If so, it fetches the contract for further processing. Once the effective pricing rule, account, and active contract are derived, the transaction is mapped to the respective price item, price item parameters, and account. A transaction leg is created for each price item, price item parameters, and account combination. For example, if the system receives a claim transaction with the following details:

- UDF_CHAR_1 is set to Western
- UDF_CHAR_2 is set to Active
- UDF_CHAR_3 is set to HR
- UDF_DATE_1 is set to 03-01-2018
- Transaction Record Type is set to TR5

Let us assume that the claim transaction is mapped to the following price item, price item parameters, and account combinations:

Transaction Record Type	Primary Pricing Rule Type	Related Pricing Rule Type	Price Item in Related Pricing Rule Type	Price Item Parameters in Related Pricing Rule Type	Effective Pricing Rule	Best Fit Match for Price Item Parameters in Effective Pricing Rule	Account	Active Contract	Transaction Leg
TR5	CLAIM	CLAIM BASED FEES	P1	Location = UDF_CHAR_1, Employee Status = UDF_CHAR_2, Employee Department = UDF_CHAR_3, and Nationality = UDF_CHAR_4	PR1	Location = Western and Employee Status = Active	A1	C1	TL1

Transaction Record Type	Primary Pricing Rule Type	Related Pricing Rule Type	Price Item in Related Pricing Rule Type	Price Item Parameters in Related Pricing Rule Type	Effective Pricing Rule	Best Fit Match for Price Item Parameters in Effective Pricing Rule	Account	Active Contract	Transaction Leg
			P2		PR2	Location = Western and Employee Status = Active	A2	C2	TL2
			P3		PR3	Location = Western and Employee Status = Active	A3	C3	TL3

Note: Here, the paid date is mapped to the **UDF_DATE_1** field in the CLAIM pricing rule type.

Example 7: Transaction Leg Derivation

In the example 7, the system maps the claim transaction to the following price item, price item parameters, and account combinations:

- Price Item: P1; Price Item Parameter: Location = Western, Employee Status = Active, and Employee Department = HR; and Account: A1
- Price Item: P2; Price Item Parameter: Location = Western, Employee Status = Active, and Employee Department = HR; and Account: A2
- Price Item: P3; Price Item Parameter: Location = Western, Employee Status = Active, and Employee Department = HR; and Account: A3

Note: The nationality information of an employee is not received in the **UDF_CHAR_4** field, and therefore the claim transaction is not mapped to the **Nationality** price item parameter.

In the example 7, the system creates three transaction legs — TL1, TL2, and TL3 for the claim transaction. Once a transaction leg is created, the respective effective pricing rule is stamped against the transaction leg. In addition, the price item parameters of the transaction leg are grouped. In the example 7, the system creates one price item parameter group which contains the following price item parameters:

- Location = Western
- Employee Status = Active
- Employee Department = HR

A group is used to determine the price item pricing. A unique group ID is generated for each group. If a group with a set of price item parameters already exists in the system, a new group is not created. Instead, the existing group is used for determining the price item pricing.

Note: The price item parameter group contains only those price item parameters included in the related pricing rule type for which the parameter usage is set to **Pricing**.

If a pricing group is used while defining a pricing rule for a bill group, the system fetches the pricing rule for a claim transaction when the following conditions are met:

- The paid date of the claim transaction falls within the pricing rule's date range.
- The employee attributes specified in the claim transaction match the criteria defined in any one of the pricing group rule.

- The employee attributes specified in the claim transaction match the price item parameters defined within the satisfied rule.

Let us understand this with the help of an example. A claim transaction is received with the following details:

- UDF_CHAR_1 is set to X
- UDF_CHAR_2 is set to Western
- UDF_CHAR_3 is set to Indian
- UDF_CHAR_4 is set to HR
- UDF_CHAR_5 is set to Permanent
- UDF_CHAR_6 is set to Senior Manager
- UDF_CHAR_7 s set to BG1
- UDF_DATE_1 03-01-2018
- Transaction Record Type is set to TR6

Let us assume that the following pricing structure is defined in the system:

Transaction Record Type	Primary Pricing Rule Type	Related Pricing Rule Type	Price Item in Related Pricing Rule Type	Price Item Parameters in Related Pricing Rule Type	Pricing Rule	Pricing Start Date	Pricing End Date	Pricing Group	Pricing Group Rule	Price Item Parameters	Fees
TR6	CLAIM	CLAIM BASED FEES	PP1	Designation = UDF_CHAR_6; Employee Group = UDF_CHAR_7	PR1	01-01-2018	31-12-2018	PG1	Rule 1 (where Source System = X, Parameter 1 = Western, Parameter 2 = Indian, Parameter 3 = HR, and Parameter 4 = Permanent)	Designation = Senior Manager and Employee Group = BG1	\$10
									Rule 1 (where Source System = X, Parameter 1 = Western, Parameter 2 = Indian, Parameter 3 = HR, and Parameter 4 = Permanent)	Designation = Senior Manager and Employee Group = BG2	\$12

Transaction Record Type	Primary Pricing Rule Type	Related Pricing Rule Type	Price Item in Related Pricing Rule Type	Price Item Parameters in Related Pricing Rule Type	Pricing Rule	Pricing Start Date	Pricing End Date	Pricing Group	Pricing Group Rule	Price Item Parameters	Fees
									Rule 2 (where Source System = X, Parameter 1 = Eastern, and Parameter 2 = Indian, Parameter 3 = HR, and Parameter 4 = Permanent)	Designation = Senior Manager and Employee Group = BG1	\$8
									Rule 2 (where Source System = X, Parameter 1 = Eastern, and Parameter 2 = Indian, Parameter 3 = HR, and Parameter 4 = Permanent)	Designation = Senior Manager and Employee Group = BG2	\$9

Note: Here, the source system is mapped to the **UDF_CHAR_1** field, the parameter 1 is mapped to the **UDF_CHAR_2** field, the parameter 2 is mapped to the **UDF_CHAR_3** field, the parameter 3 is mapped to the **UDF_CHAR_4** field, the parameter 4 is mapped to the **UDF_CHAR_5** field, and the paid date is mapped to the **UDF_DATE_1** field in the CLAIM pricing rule type.

Example 8: Effective Pricing Rule is Defined Using a Pricing Group

In the example 8, the system considers the PR1 pricing rule for PP1 because of the following reasons:

- The paid date (i.e. 03-01-2018) of the claim transaction falls within the PR1 pricing rule's date range (i.e. 01-01-2018 to 31-12-2018).
- The employee attributes specified in the claim transaction match the criteria defined in the Rule 1 (i.e. Source System = X, Parameter 1 = Western, Parameter 2 = Indian, Parameter 3 = HR, and Parameter 4 = Permanent).
- The employee attributes specified in the claim transaction match the price item parameters defined within the Rule 1.

The system then stores the pricing group rule which is satisfied against a parameter which is defined in the **Pricing Group Rule Parameter** option type of the **C1-ASOBLNG** feature configuration. In such case, the price item parameter group contains the price item parameters and the pricing group rule parameter. For example, Group A contains Designation = Senior Manager, Employee Group = BG1, and Pricing Group Rule Parameter = Rule 1.

In the example 8, the system could find the exact match for pricing parameters defined in the pricing group rule. However, if the exact match is not available, the system finds the effective pricing rule using the best fit match for the pricing parameters defined in the pricing group rule. Note that the system searches for the exact match in the effective

pricing rules at both the bill group and parent customer levels. If the exact match is not available at both the levels, the system finds the effective pricing rule using the best fit match for the pricing parameters (defined in the pricing group rule) first at the bill group level and then at the parent customer level.

Let us understand this with the help of an example. A claim transaction is received with the following details:

- UDF_CHAR_1 is set to X
- UDF_CHAR_2 is set to Western
- UDF_CHAR_3 is set to Indian
- UDF_CHAR_4 is set to HR
- UDF_CHAR_5 is set to Permanent
- UDF_CHAR_6 is set to Senior Manager
- UDF_CHAR_7 is set to BG1
- UDF_DATE_1 is set to 31-05-2018
- Transaction Record Type is set to TR6

Let us assume that the following pricing structure is defined in the system:

Transaction Record Type	Primary Pricing Rule Type	Related Pricing Rule Type	Price Item in Related Pricing Rule Type	Price Item Parameters in Related Pricing Rule Type	Pricing Rule	Pricing Start Date	Pricing End Date	Pricing Group	Pricing Group Rule	Price Item Parameters in Pricing Rule	Fees
TR6	CLAIM	CLAIM BASED FEES	PP1	Designation = UDF_CHAR_6, Employee Group = UDF_CHAR_7	PR1	01-01-2018	31-12-2018	PG1	Rule 1 (where Source System = X and Parameter 1 = Western)	Designation = Senior Manager; Employee Group = BG1	\$20
									Rule 1 (where Source System = X and Parameter 1 = Western)	Designation = Senior Manager; Employee Group = BG2	\$21
									Rule 2 (where Source System = X and Parameter 1 = Eastern)	Designation = Senior Manager; Employee Group = BG1	\$18

Transaction Record Type	Primary Pricing Rule Type	Related Pricing Rule Type	Price Item in Related Pricing Rule Type	Price Item Parameters in Related Pricing Rule Type	Pricing Rule	Pricing Start Date	Pricing End Date	Pricing Group	Pricing Group Rule	Price Item Parameters in Pricing Rule	Fees
									Rule 2 (where Source System = X and Parameter 1 = Eastern)	Designation = Senior Manager; Employee Group = BG2	\$19
			PP2		PR2	01-01-2018	31-12-2018	PG2	Rule 1 (where Source System = X, Parameter 1 = Eastern, Parameter 2 = Indian, Parameter 3 = HR, and Parameter 4 = Permanent)	Designation = Senior Manager; Employee Group = BG2	\$5
									Rule 1 (where Source System = X, Parameter 1 = Eastern, Parameter 2 = Indian, Parameter 3 = HR, and Parameter 4 = Permanent)	Designation = Senior Manager; Employee Group = BG1	\$5
									Rule 2 (where Source System = X, Parameter 1 = Western, Parameter 2 = Indian, Parameter 3 = HR, and Parameter 4 = Permanent)	Designation = Senior Manager; Employee Group = BG2	\$6

Transaction Record Type	Primary Pricing Rule Type	Related Pricing Rule Type	Price Item in Related Pricing Rule Type	Price Item Parameters in Related Pricing Rule Type	Pricing Rule	Pricing Start Date	Pricing End Date	Pricing Group	Pricing Group Rule	Price Item Parameters in Pricing Rule	Fees
									Rule 2 (where Source System = X, Parameter 1 = Western, Parameter 2 = Indian, Parameter 3 = HR, and Parameter 4 = Permanent)	Designation = Senior Manager; Employee Group = BG1	\$9

Note: Here, the source system is mapped to the **UDF_CHAR_1** field, the parameter 1 is mapped to the **UDF_CHAR_2** field, the parameter 2 is mapped to the **UDF_CHAR_3** field, the parameter 3 is mapped to the **UDF_CHAR_4** field, the parameter 4 is mapped to the **UDF_CHAR_5** field, and the paid date is mapped to the **UDF_DATE_1** field in the CLAIM pricing rule type.

Example 9: Effective Pricing Rule Derivation Using Best Fit Match for Pricing Parameters

In the example 9, the system could not find the exact match for the pricing parameters (i.e. Source System = X, Parameter 1 = Western, Parameter 2 = Indian, Parameter 3 = HR, and Parameter 4 = Permanent) in the effective pricing rule for PP1. Therefore, the system searches for the best fit match. While searching for the best fit match, the system rules out the optional parameter 4 (i.e. Parameter 4 = Permanent) and then checks whether the pricing group rule where Source System = X, Parameter 1 = Western, Parameter 2 = Indian, and Parameter 3 = HR exists in the effective pricing rule. If so, it considers the pricing group rule for further processing. If not, the system then rules out the optional parameter 3 (i.e. Parameter 3 = HR) and then checks whether the pricing group rule where Source System = X, Parameter 1 = Western, and Parameter 2 = Indian exists in the effective pricing rule. If so, it considers the pricing group rule for further processing. If not, the system then rules out the optional parameter 2 (i.e. Parameter 2 = Indian) and then checks whether the pricing group rule where Source System = X and Parameter 1 = Western exists in the effective pricing rule. If so, it considers the pricing group rule for further processing. If not, the status of the transaction is changed to **Error**.

In the example 9, the system considers Rule 1 where Source System = X and Parameter 1 = Western as the best fit match in the PR1 pricing rule for PP1. In addition, the employee attributes in the claim transaction satisfy the price item parameters (i.e. Designation = Senior Manager and Employee Group = BG1) defined within the Rule 1. Therefore, the system fetches PR1 as the effective pricing rule for PP1. In addition, the system fetches PR2 as the effective pricing rule for PP2. The system creates two price item parameter groups — One contains Designation = Senior Manager, Employee Group = BG1, and Pricing Group Rule Parameter = Rule 1 and another contains Designation = Senior Manager, Employee Group = BG1, and Pricing Group Rule Parameter = Rule 2. Once the price item parameter group is created, the system creates the aggregation parameter group. An aggregation parameter group contains all price item parameters included in the related pricing rule type for which the parameter usage is set to **Aggregation**.

If the effective pricing rule is not derived for a price item and price item parameters combination or if the account or active contract for the account is not derived, the system does not create a transaction leg for the respective price item. Let us understand this with the help of an example:

Related Pricing Rule Type	Price Item	Price Item Parameters	Effective Pricing Rule	Account	Active Contract	Transaction Leg
RETENTION TYPE CLAIM BASED	PP11	Designation = UDF_CHAR_6, Employee Status = UDF_CHAR_7	-	-	-	-
	PP12		PR12	A1	C1	TL11
	PP13		PR13	-	-	-
	PP14		PR14	A2	-	-
	PP15		PR15	-	-	-
	PP16		-	-	-	-
	PP17		PR17	A2	C2	TL12

Example 10: No. of Transaction Legs Derived

In the example 10, the system could not find the effective pricing rule for PP11 and PP16, the required account for PP13 and PP15, and the active contract for PP14 on A2. Therefore, in this case, the system creates two transaction legs — TL11 and TL12 for the transaction.

If the eligibility rule type is defined for a price item, the system maps the transaction to the price item when the eligibility rule is satisfied. If the eligibility rule is not satisfied, the system does not consider the price item for billing. For example,

Sequence	Related Pricing Rule Type	Rule Type Eligibility Criteria Met	Price Item	Price Item Eligibility Criteria Met	Effective Pricing Rule	Account	Active Contract	Transaction Leg
10	RETENTION TYPE CLAIM BASED	Yes	PE1	Yes	PR1	A1	C1	TL1
			PE2	-	PR2	A2	-	-
			PE3	No	-	-	-	-
20	CLAIM BASED FEES	-	PE4	-	PR3	A1	C2	TL2
			PE5	Yes	PR4	-	-	-
			PE6	No	-	-	-	-
30	CLAIM FEE CHARGES	No	PE7	-	-	-	-	-
			PE8	-	-	-	-	-
			PE9	-	-	-	-	-

Example 11: Price Item Eligibility for Transaction Leg Derivation

In the example 11, the eligibility criteria is defined for the RETENTION TYPE CLAIM BASED and CLAIM FEE CHARGES pricing rule types. However, the eligibility criteria for the CLAIM FEE CHARGES pricing rule type was not satisfied, and therefore it is not used for deriving the transaction legs. The eligibility criteria for PE1 and PE5 was satisfied, but the eligibility criteria for PE3 and PE6 was not satisfied. Further, the system could not find the required account for PE5 and the active contract for PE2 on A2. Therefore, in this case, the system creates two transaction legs (i.e. TL1 and TL2) for the claim transaction. For more information about the related pricing rule type eligibility and price item eligibility features, refer to the [Related Pricing Rule Type Eligibility](#) on page 2948 and [Price Item Eligibility](#) on page 2950 sections, respectively.

Once a transaction leg is created, the derivation date is set as the processing date corresponding to the transaction leg.

Account and Price Item Derivation (for the Retention Type Enrollment Based Pricing Rule Type Category)

The **Validate Transaction and Derive Price Item (C1-TXNIP)** batch maps the retroactive and non-retroactive enrollment transactions to one or more price item and price item parameters which are defined in the respective primary pricing rule type. This is possible only when an algorithm created using the **C1_ACCPRIDRV** algorithm type is attached to the **Account and Price Item Derivation** system event of the primary pricing rule type.

This algorithm fetches the effective pricing rule for each price item and price item parameters combination specified in the primary pricing rule type on the derivation date. The system considers the coverage end date and coverage start date as the derivation date while fetching the effective pricing rules for the retroactive and non-retroactive enrollment transactions, respectively. This algorithm first searches for the effective pricing rule for a price item and price item parameters combination which is defined for the policy at the bill group level. If the system does not find any effective pricing rule for a price item and price item parameters combination which is defined for the policy at the bill group level, it inherits the effective pricing rule for a price item and price item parameters combination from the parent customer level.

For example, if the system receives a non-retroactive enrollment transaction with the following details:

- UDF_DATE_1 is set to 01-02-2018
- UDF_DATE_2 is set to 28-02-2018
- Transaction Record Type is set to TR3

Let us assume that the following pricing structure is defined in the system:

Transaction Record Type	Primary Pricing Rule Type	Price Item	Pricing Rule	Pricing Start Date	Pricing End Date	Assignment Level
TR3	RETENTION TYPE ENROLLMENT BASED	P1	C1P1	01-01-2018	31-12-2018	Parent Customer
			C2P1	01-01-2018	31-12-2018	Bill Group
			C3P1	01-01-2019	30-06-2019	Bill Group
		P2	C1P2	01-06-2017	31-12-2017	Bill Group
			C2P2	01-01-2018	31-12-2018	Parent Customer
			C3P2	01-01-2019	30-06-2019	Bill Group

Note: Here, the coverage start date is mapped to the **UDF_DATE_1** field and the coverage end date is mapped to the **UDF_DATE_2** field in the RETENTION TYPE ENROLLMENT BASED pricing rule type.

Example 1: Effective Pricing Rule Derivation

In the example 1, the system fetches C2P1 and C2P2 pricing rules for P1 and P2, respectively, which are effective on the coverage start date. Note that the effective pricing rule for P1 is derived at the bill group level, whereas the effective pricing rule for P2 is derived from the parent customer level.

While fetching the effective pricing rule, the system first searches for exact match for the price item parameters at both the levels. For example, if the system receives a retroactive enrollment transaction with the following details:

- UDF_CHAR_1 is set to Western
- UDF_CHAR_2 is set to Active

- UDF_DATE_1 is set to 01-03-2018
- UDF_DATE_2 is set to 31-03-2018
- Transaction Record Type is set to TR4

Let us assume that the following pricing structure is defined in the system:

Transaction Record Type	Primary Pricing Rule Type	Price Item	Price Item Parameters	Pricing Rule	Pricing Start Date	Pricing End Date	Price Item Parameters in Pricing Rule	Fees	Assignment Level	
TR4	ENROLLMENT BASED FEES	P1	Location = UDF_CHAR_1 and Employee Status = UDF_CHAR_2	C1P1	01-01-2018	31-12-2018	Location = Western and Employee Status = Active	\$10	Parent Customer	
							Location = Eastern and Employee Status = Active	\$12		
							Location = Eastern and Employee Status = Retired	\$11		
							Location = Western and Employee Status = Retired	\$9		
				C2P1	01-01-2018	31-12-2018	Location = Western and Employee Status = Active	\$8		Bill Group
							Location = Eastern and Employee Status = Active	\$9		
							Location = Eastern and Employee Status = Retired	\$10		
							Location = Western and Employee Status = Retired	\$9		

Note: Here, the coverage start date is mapped to the **UDF_DATE_1** field and the coverage end date is mapped to the **UDF_DATE_2** field in the ENROLLMENT BASED FEES pricing rule type.

Example 2: Exact Match for Price Item Parameters

In the example 2, the system fetches the C2P1 pricing rule for P1 because of the following reasons:

- The coverage end date (i.e. 31-03-2018) of the retroactive enrollment transaction falls within the date range (i.e. 01-01-2018 to 31-12-2018) of the C2P1 pricing rule which is defined at the bill group level.
- It contains the exact match for the price item parameters which are received in the transaction.

If the system cannot find the exact match for the price item parameters at both the levels, the system searches for the best fit match for the price item parameters first at the bill group level and then at the parent customer level. For example, if the system receives a retroactive enrollment transaction with the following details:

- UDF_CHAR_1 is set to Western
- UDF_CHAR_2 is set to Active
- UDF_CHAR_3 is set to HR
- UDF_CHAR_4 is set to Indian
- UDF_DATE_1 is set to 01-03-2018
- UDF_DATE_2 is set to 31-03-2018
- Transaction Record Type is set to TR5

Let us assume that the following pricing structure is defined in the system:

Transaction Record Type	Primary Pricing Rule Type	Price Item	Price Item Parameters	Pricing Rule	Pricing Start Date	Pricing End Date	Price Item Parameters in Pricing Rule	Fees	Assignment Level
TR5	ENROLLMENT BASED CHARGES	P3	Location = UDF_CHAR_1, Employee Status = UDF_CHAR_2, Employee Department = UDF_CHAR_3, and Nationality = UDF_CHAR_4	C1P3	01-01-2018	31-12-2018	Location = Western and Employee Status = Active	\$10	Bill Group
							Location = Eastern and Employee Status = Active	\$12	
							Location = Eastern and Employee Status = Retired	\$11	
							Location = Western and Employee Status = Retired	\$9	

Note:

Here, the coverage start date is mapped to the **UDF_DATE_1** field and the coverage end date is mapped to the **UDF_DATE_2** field in the ENROLLMENT BASED CHARGES pricing rule type.

Here, the **Location** and **Employee Status** parameters are mandatory for P3. However, the **Employee Department** and **Nationality** parameters are optional with the priority set to 1 and 2, respectively.

Example 3: Best Fit Match for Price Item Parameters

In the example 3, the system could not find the exact match for the price item parameters (i.e. Location = Western, Employee Status = Active, Employee Department = HR, and Nationality = Indian) in the effective pricing rule for P3. Therefore, the system searches for the best fit match. While searching for the best fit match, the system rules out the optional parameter with lowest priority (i.e. Nationality = Indian) and checks whether pricing is defined for the price item parameters (i.e. Location = Western, Employee Status = Active, and Employee Department = HR) in the effective pricing rule. If so, it considers C1P3 as the effective pricing rule for P3. If not, the system rules out the optional parameter with the next lowest priority (i.e. Employee Department = HR) and checks whether pricing is defined for the price item

parameters (i.e. Location = Western and Employee Status = Active) in the effective pricing rule. If so, it considers C1P3 as the effective pricing rule for P3. If not, the status of the transaction is changed to **Error**.

In the example 3, the system considers pricing defined for the price item parameters (i.e. Location = Western and Employee Status = Active) as the best fit match, and therefore fetches C1P3 as the effective pricing rule for P3. While fetching the effective pricing rule, the system considers only those price item parameters specified in the primary pricing rule type for which the parameter usage is set to **Pricing**. For retroactive enrollment transactions, the system considers only those effective pricing rules where the **Exempt Retro Transactions** option is not selected.

The system then derives the account with a particular invoice type (to which a price item must be billed) based on the priority which is defined for the respective price item in the pricing rule type. For example,

Price Item	Priority	Invoice Type	Account
P1	10	Standard	A1
	20	Retention	A2
P2	10	Retention	A2
	20	Standard	A1

Example 4: Priority Based Account Derivation

In the example 4, while mapping the enrollment transaction to P1, the system checks whether an account where the **Invoice Type (C1INVTYP)** characteristic is set to **Standard** exists for the bill group. If so, it considers the standard account (A1) of the bill group for billing. However, if an account where the **Invoice Type (C1INVTYP)** characteristic is set to **Standard** does not exist for the bill group, the system checks whether an account where the **Invoice Type (C1INVTYP)** characteristic is set to **Retention** exists for the bill group. If so, it considers the retention account (A2) of the bill group for billing. If an account where the **Invoice Type (C1INVTYP)** characteristic is set to **Retention** does not exist for the bill group, the status of the transaction is changed to **Error**.

Similarly, while mapping the enrollment transaction to P2, the system considers the account of the bill group which is available based on the priority. The system derives the billing account for only those price items for which the effective pricing rule is derived.

Note: The characteristic type which indicates the type of account (for example, **C1INVTYP**) must be specified in the **Invoice Type Characteristic Type** option type of the **C1-ASOBLLNG** feature configuration. Otherwise, erroneous results might occur.

Once the account is derived, the system then checks whether the account has one active contract of the contract type which is associated with the price item. If so, it fetches the contract for further processing. Once the effective pricing rule, account, and active contract are derived, the transaction is mapped to the respective price item, price item parameters, and account. A transaction leg is created for each price item, price item parameters, and account combination. For example, if the system receives a non-retroactive enrollment transaction with the following details:

- UDF_CHAR_1 is set to Western
- UDF_CHAR_2 is set to Active
- UDF_CHAR_3 is set to HR
- UDF_DATE_1 is set to 01-03-2018
- UDF_DATE_2 is set to 31-03-2018
- Transaction Record Type is set to TR5

Let us assume that the non-retroactive enrollment transaction is mapped to the following price item, price item parameters, and account combinations:

Transaction Record Type	Primary Pricing Rule Type	Price Item	Price Item Parameters	Effective Pricing Rule	Best Fit Match for Price Item Parameters in Effective Pricing Rule	Account	Active Contract	Transaction Leg
TR5	ENROLLMENT BASED FEES	P1	Location = UDF_CHAR_1, Employee Status = UDF_CHAR_2, Employee Department =	PR1	Location = Western and Employee Status = Active	A1	C1	TL1
		P2	UDF_CHAR_3, and Nationality = UDF_CHAR_4	PR2	Location = Western and Employee Status = Active	A2	C2	TL2
		P3		PR3	Location = Western and Employee Status = Active	A3	C3	TL3

Note: Here, the coverage start date is mapped to the **UDF_DATE_1** field and the coverage end date is mapped to the **UDF_DATE_2** field in the ENROLLMENT BASED FEES pricing rule type.

Example 5: Transaction Leg Derivation

In the example 5, the system maps the non-retroactive enrollment transaction to the following price item, price item parameters, and account combinations:

- Price Item: P1; Price Item Parameter: Location = Western, Employee Status = Active, and Employee Department = HR; and Account: A1
- Price Item: P2; Price Item Parameter: Location = Western, Employee Status = Active, and Employee Department = HR; and Account: A2
- Price Item: P3; Price Item Parameter: Location = Western, Employee Status = Active, and Employee Department = HR; and Account: A3

Note: The nationality information of an employee is not received in the **UDF_CHAR_4** field, and therefore the non-retroactive enrollment transaction is not mapped to the **Nationality** price item parameter.

In the example 5, the system creates three transaction legs — TL1, TL2, and TL3 for the non-retroactive enrollment transaction. Once a transaction leg is created, the respective effective pricing rule is stamped against the transaction leg. In addition, the price item parameters of the transaction leg are grouped. In the example 5, the system creates one price item parameter group which contains the following price item parameters:

- Location = Western
- Employee Status = Active
- Employee Department = HR

A group is used to determine the price item pricing. A unique group ID is generated for each group. If a group with a set of price item parameters already exists in the system, a new group is not created. Instead, the existing group is used for determining the price item pricing.

Note: The price item parameter group contains only those price item parameters included in the pricing rule type for which the parameter usage is set to **Pricing**.

The following table describes how the system fetches a pricing rule when a pricing group is used while defining the pricing rule for a bill group:

If the transaction is a...	Then the system fetches the pricing rule when the following conditions are met...
Retroactive enrollment transaction	<ul style="list-style-type: none"> The coverage end date of the retroactive enrollment transaction falls within the pricing rule's date range. The exact or best fit match is available for the price item parameters in the effective pricing rule. The retroactive enrollment transaction satisfies the criteria defined in any one of the pricing group rule.
Non-retroactive enrollment transaction	<ul style="list-style-type: none"> The coverage start date of the non-retroactive enrollment transaction falls within the pricing rule's date range. The exact or best fit match is available for the price item parameters in the effective pricing rule. The non-retroactive enrollment transaction satisfies the criteria defined in any one of the pricing group rule.

Let us understand this with the help of an example. A retroactive enrollment transaction is received with the following details:

- UDF_CHAR_1 is set to X
- UDF_CHAR_2 is set to Western
- UDF_CHAR_3 is set to Indian
- UDF_CHAR_4 is set to HR
- UDF_CHAR_5 is set to Permanent
- UDF_CHAR_6 is set to Senior Manager
- UDF_CHAR_7 is set to BG1
- UDF_DATE_1 is set to 01-03-2018
- UDF_DATE_2 is set to 31-03-2018
- Transaction Record Type is set to TR6

Let us assume that the following pricing structure is defined in the system:

Transaction Record Type	Primary Pricing Rule Type	Price Item	Price Item Parameters	Pricing Rule	Pricing Start Date	Pricing End Date	Pricing Group	Pricing Group Rule	Price Item Parameters	Fees
TR6	ENROLLMENT BASED FEES	PP1	Designation = UDF_CHAR_6; Employee Group = UDF_CHAR_7	PR1	01-01-2018	31-12-2018	PG1	Rule 1 (where Source System = X, Parameter 1 = Western, Parameter 2 = Indian, Parameter 3 = HR, and Parameter 4 = Permanent)	Designation = Senior Manager and Employee Group = BG1	\$10

Transaction Record Type	Primary Pricing Rule Type	Price Item	Price Item Parameters	Pricing Rule	Pricing Start Date	Pricing End Date	Pricing Group	Pricing Group Rule	Price Item Parameters	Fees
								Rule 1 (where Source System = X, Parameter 1 = Western, Parameter 2 = Indian, Parameter 3 = HR, and Parameter 4 = Permanent)	Designation = Senior Manager and Employee Group = BG2	\$12
								Rule 2 (where Source System = X, Parameter 1 = Eastern, and Parameter 2 = Indian, Parameter 3 = HR, and Parameter 4 = Permanent)	Designation = Senior Manager and Employee Group = BG1	\$8
								Rule 2 (where Source System = X, Parameter 1 = Eastern, and Parameter 2 = Indian, Parameter 3 = HR, and Parameter 4 = Permanent)	Designation = Senior Manager and Employee Group = BG2	\$9

Note: Here, the source system is mapped to the **UDF_CHAR_1** field, the parameter 1 is mapped to the **UDF_CHAR_2** field, the parameter 2 is mapped to the **UDF_CHAR_3** field, the parameter 3 is mapped to the **UDF_CHAR_4** field, the parameter 4 is mapped to the **UDF_CHAR_5** field, the coverage start date is mapped to the **UDF_DATE_1** field, and the coverage end date is mapped to the **UDF_DATE_2** field in the ENROLLMENT BASED FEES pricing rule type.

Example 6: Effective Pricing Rule is Defined Using a Pricing Group

In the example 6, the system considers the PR1 pricing rule for PP1 because of the following reasons:

- The coverage end date (i.e. 31-03-2018) of the retroactive enrollment transaction falls within the PR1 pricing rule’s date range (i.e. 01-01-2018 to 31-12-2018).
- The employee attributes specified in the retroactive enrollment transaction match the criteria defined in the Rule 1 (i.e. Source System = X, Parameter 1 = Western, Parameter 2 = Indian, Parameter 3 = HR, and Parameter 4 = Permanent)

- The employee attributes specified in the retroactive enrollment transaction match the price item parameters defined within the Rule 1.

The system then stores the pricing group rule which is satisfied against a parameter which is defined in the **Pricing Group Rule Parameter** option type of the **C1-ASOBLNG** feature configuration. In such case, the price item parameter group contains the price item parameters and the pricing group rule parameter. For example, Group A contains Designation = Senior Manager, Employee Group = BG1, and Pricing Group Rule Parameter = Rule 1.

In the example 6, the system could find the exact match for pricing parameters defined in the pricing group rule. However, if the exact match is not available, the system finds the effective pricing rule using the best fit match for the pricing parameters defined in the pricing group rule. Note that the system searches for the exact match in the effective pricing rules at both the bill group and parent customer levels. If the exact match is not available at both the levels, the system finds the effective pricing rule using the best fit match for the pricing parameters (defined in the pricing group rule) first at the bill group level and then at the parent customer level.

Let us understand this with the help of an example. A non-retroactive enrollment transaction is received with the following details:

- UDF_CHAR_1 is set to X
- UDF_CHAR_2 is set to Western
- UDF_CHAR_3 is set to Indian
- UDF_CHAR_4 is set to HR
- UDF_CHAR_5 is set to Permanent
- UDF_CHAR_6 is set to Senior Manager
- UDF_CHAR_7 is set to BG1
- UDF_DATE_1 is set to 01-05-2018
- UDF_DATE_2 is set to 31-05-2018
- Transaction Record Type is set to TR6

Let us assume that the following pricing structure is defined in the system:

Transaction Record Type	Primary Pricing Rule Type	Price Item	Price Item Parameters	Pricing Rule	Pricing Start Date	Pricing End Date	Pricing Group	Pricing Group Rule	Price Item Parameters in Pricing Rule	Fees
TR6	ENROLLMENT BASED FEES	PP1	Designation = UDF_CHAR_6, Employee Group = UDF_CHAR_7	PR1	01-01-2018	31-12-2018	PG1	Rule 1 (where Source System = X and Parameter 1 = Western)	Designation = Senior Manager; Employee Group = BG1	\$20
								Rule 1 (where Source System = X and Parameter 1 = Western)	Designation = Senior Manager; Employee Group = BG2	\$21
								Rule 2 (where Source System = X and Parameter 1 = Eastern)	Designation = Senior Manager; Employee Group = BG1	\$18

Transaction Record Type	Primary Pricing Rule Type	Price Item	Price Item Parameters	Pricing Rule	Pricing Start Date	Pricing End Date	Pricing Group	Pricing Group Rule	Price Item Parameters in Pricing Rule	Fees
								Rule 2 (where Source System = X and Parameter 1 = Eastern)	Designation = Senior Manager; Employee Group = BG2	\$19
		PP2		PR2	01-01-2018	31-12-2018	PG2	Rule 1 (where Source System = X, Parameter 1 = Eastern, Parameter 2 = Indian, Parameter 3 = HR, and Parameter 4 = Permanent)	Designation = Senior Manager; Employee Group = BG2	\$5
								Rule 1 (where Source System = X, Parameter 1 = Eastern, Parameter 2 = Indian, Parameter 3 = HR, and Parameter 4 = Permanent)	Designation = Senior Manager; Employee Group = BG1	\$5
								Rule 2 (where Source System = X, Parameter 1 = Western, Parameter 2 = Indian, Parameter 3 = HR, and Parameter 4 = Permanent)	Designation = Senior Manager; Employee Group = BG2	\$6

Transaction Record Type	Primary Pricing Rule Type	Price Item	Price Item Parameters	Pricing Rule	Pricing Start Date	Pricing End Date	Pricing Group	Pricing Group Rule	Price Item Parameters in Pricing Rule	Fees
								Rule 2 (where Source System = X, Parameter 1 = Western, Parameter 2 = Indian, Parameter 3 = HR, and Parameter 4 = Permanent)	Designation = Senior Manager; Employee Group = BG1	\$9

Note: Here, the source system is mapped to the **UDF_CHAR_1** field, the parameter 1 is mapped to the **UDF_CHAR_2** field, the parameter 2 is mapped to the **UDF_CHAR_3** field, the parameter 3 is mapped to the **UDF_CHAR_4** field, the parameter 4 is mapped to the **UDF_CHAR_5** field, the coverage start date is mapped to the **UDF_DATE_1** field, and the coverage end date is mapped to the **UDF_DATE_2** field in the ENROLLMENT BASED FEES pricing rule type.

Example 7: Effective Pricing Rule Derivation Using Best Fit Match for Pricing Parameters

In the example 7, the system could not find exact match for the pricing parameters (i.e. Source System = X, Parameter 1 = Western, Parameter 2 = Indian, Parameter 3 = HR, and Parameter 4 = Permanent) in the effective pricing rule for PP1. Therefore, the system searches for the best fit match. While searching for the best fit match, the system rules out the optional parameter 4 (i.e. Parameter 4 = Permanent) and then checks whether the pricing group rule where Source System = X, Parameter 1 = Western, Parameter 2 = Indian, and Parameter 3 = HR exists in the effective pricing rule. If so, it considers the pricing group rule for further processing. If not, the system then rules out the optional parameter 3 (i.e. Parameter 3 = HR) and then checks whether the pricing group rule where Source System = X, Parameter 1 = Western, and Parameter 2 = Indian exists in the effective pricing rule. If so, it considers the pricing group rule for further processing. If not, the system then rules out the optional parameter 2 (i.e. Parameter 2 = Indian) and then checks whether the pricing group rule where Source System = X and Parameter 1 = Western exists in the effective pricing rule. If so, it considers the pricing group rule for further processing. If not, the status of the transaction is changed to **Error**.

In the example 7, the system considers Rule 1 where Source System = X and Parameter 1 = Western as the best fit match in the PR1 pricing rule for PP1. In addition, the employee attributes in the non-retroactive enrollment transaction satisfy the price item parameters (i.e. Designation = Senior Manager and Employee Group = BG1) defined within Rule 1. Therefore, the system fetches PR1 as the effective pricing rule for PP1. In addition, the system fetches PR2 as the effective pricing rule for PP2. The system creates two price item parameter groups — One contains Designation = Senior Manager, Employee Group = BG1, and Pricing Group Rule Parameter = Rule 1 and another contains Designation = Senior Manager, Employee Group = BG1, and Pricing Group Rule Parameter = Rule 2. Once the price item parameter group is created, the system creates the aggregation parameter group. An aggregation parameter group contains all price item parameters included in the pricing rule type for which the parameter usage is set to **Aggregation**.

If the effective pricing rule is not derived for a price item and price item parameters combination or if the account or active contract for the account is not derived, the system does not create a transaction leg for the respective price item. Let us understand this with the help of an example:

Primary Pricing Rule Type	Price Item	Price Item Parameters	Effective Pricing Rule	Account	Active Contract	Transaction Leg
ENROLLMENT BASED FEES	PP1	Designation = UDF_CHAR_6,	-	-	-	-
	PP2	Employee Status = UDF_CHAR_7	PR2	-	-	-
	PP3		PR3	A3	C3	TL1

Primary Pricing Rule Type	Price Item	Price Item Parameters	Effective Pricing Rule	Account	Active Contract	Transaction Leg
	PP4		-	-	-	-
	PP5		PR5	A2	C1	TL2
	PP6		PR6	A1	-	-

Example 8: No. of Transaction Legs Derived

In the example 8, the system could not find the effective pricing rule for PP1 and PP4, the required account for PP2, and the active contract for PP6 on A1. Therefore, in this case, the system creates two transaction legs — TL1 and TL2 for the enrollment transaction.

If the eligibility rule type is defined of a price item, the system maps the enrollment transaction to the price item when the eligibility rule is satisfied. If the eligibility rule is not satisfied, the system does not consider the price item for billing. For example,

Price Item	Eligibility Criteria Met	Effective Pricing Rule	Account	Active Contract	Transaction Leg
PE1	Yes	PR1	A1	C1	TL1
PE2	-	PR2	-	-	-
PE3	No	-	-	-	-
PE4	Yes	-	-	-	-
PE5	Yes	PR3	A2	-	-
PE6	Yes	PR4	-	-	-

Example 9: Price Item Eligibility for Transaction Leg Derivation

In the example 9, the eligibility criteria was defined for PE1, PE3, PE4, PE5, and PE6. The eligibility criteria was satisfied for PE1, PE4, PE5, and PE6, but not for PE3. Further, the system could not find the effective pricing rule for PE4, the required account for PE2 and PE6, and the active contract for PE5 on A2. Therefore, in this case, the system creates one transaction leg (i.e. TL1) for the enrollment transaction. For more information, refer to the [Price Item Eligibility](#) on page 2950 section.

Once a transaction leg is created, the derivation date is set as the processing date corresponding to the transaction leg.

Account and Price Item Derivation (for the Ancillary Pricing Rule Type Category)

The **Validate Transaction and Derive Price Item (C1-TXNIP)** batch maps an ancillary transaction to one or more price item and price item parameters which are defined in the respective primary pricing rule type. This is possible when an algorithm created using the **C1_ACCPRIDRV** algorithm type is attached to the **Account and Price Item Derivation** system event of the primary pricing rule type.

This algorithm fetches the effective pricing rule for each price item and price item parameters combination specified in the primary pricing rule type on the derivation date. The system considers the paid date as the derivation date. This algorithm first searches for the effective pricing rule for a price item and price item parameters combination which is defined for the policy at the bill group level. If the system does not find any effective pricing rule for a price item and price item parameters combination which is defined for the policy at the bill group level, it inherits the effective pricing rule for a price item and price item parameters combination from the parent customer level.

For example, if the system receives an ancillary transaction with the following details:

- UDF_CHAR_6 is set to BC1

- UDF_CHAR_7 is set to PASS
- UDF_DATE_1 is set to 15-03-2018
- Transaction Record Type is set to TR1

Let us assume that the following pricing structure is defined in the system:

Transaction Record Type	Primary Pricing Rule Type	Price Item	Price Item Parameters	Pricing Rule	Pricing Start Date	Pricing End Date	Pricing Arrangement	Assignment Level
TR1	ANCILLARY	P1	BCHGLINETYPE = UDF_CHAR_6 and PRICINGARRANGEMENT = UDF_CHAR_7	C1P1	01-01-2018	31-12-2018	Pass Through without Markup or Markdown	Parent Customer
				C2P1	01-01-2018	31-12-2018	Pass Through without Markup or Markdown	Bill Group
				C3P1	01-01-2018	31-12-2018	Pass Through without Markup or Markdown	Bill Group
		P2		C1P2	01-06-2017	31-12-2017	Pass Through without Markup or Markdown	Bill Group
				C2P2	01-01-2018	31-12-2018	Pass Through without Markup or Markdown	Parent Customer
				C3P2	01-01-2019	30-06-2019	Pass Through without Markup or Markdown	Bill Group

Note:

Here, the **Pass Through without Markup or Markdown** pricing arrangement identifier is set to **PASS** in the ANCILLARY pricing rule type. This means that the system will consider only effective pricing rules where the pricing arrangement is set to **Pass Through without Markup or Markdown** when the ancillary transaction is received where **UDF_CHAR_7** is set to **PASS**.

Here, the paid date is mapped to the **UDF_DATE_1** field in the ANCILLARY pricing rule type.

Example 1: Effective Pricing Rule Derivation

In the example 1, the system fetches C2P1 and C2P2 pricing rules for P1 and P2, respectively, because of the following reasons:

- The paid date (i.e. 15-03-2018) of the ancillary transaction falls within the C2P1 and C2P2 pricing rules' date range (i.e. 01-01-2018 to 31-12-2018).

- The pricing arrangement is set to **Pass Through without Markup or Markdown** in the C2P1 and C2P2 pricing rules.

Note that the effective pricing rule for P1 is derived at the bill group level, whereas the effective pricing rule for P2 is derived from the parent customer level.

Note: The price item parameters (i.e. BCHGLINETYPE and PRICINGARRANGEMENT) must be defined in the **Billable Charge Line Type Parameter** and **Pricing Arrangement Parameter** option types of the **C1-ASOBLNG** feature configuration, respectively. Otherwise, erroneous results might occur.

The system then derives the account with a particular invoice type (to which a price item must be billed) based on the priority which is defined for the respective price item in the pricing rule type. For example,

Price Item	Priority	Invoice Type	Account
P1	10	Standard	A1
	20	Retention	A2
P2	10	Retention	A2
	20	Standard	A1

Example 2: Priority Based Account Derivation

In the example 2, while mapping the claim transaction to P1, the system checks whether an account where the **Invoice Type (C1INVTYP)** characteristic is set to **Standard** exists for the bill group. If so, it considers the standard account (A1) of the bill group for billing. However, if an account where the **Invoice Type (C1INVTYP)** characteristic is set to **Standard** does not exist for the bill group, the system checks whether an account where the **Invoice Type (C1INVTYP)** characteristic is set to **Retention** exists for the bill group. If so, it considers the retention account (A2) of the bill group for billing. If an account where the **Invoice Type (C1INVTYP)** characteristic is set to **Retention** does not exist for the bill group, the status of the transaction is changed to **Error**.

Similarly, while mapping the claim transaction to P2, the system considers the account of the bill group which is available based on the priority. The system derives the billing account for only those price items for which the effective pricing rule is derived.

Note: The characteristic type which indicates the type of account (for example, **C1INVTYP**) must be specified in the **Invoice Type Characteristic Type** option type of the **C1-ASOBLNG** feature configuration. Otherwise, erroneous results might occur.

Once the account is derived, the system then checks whether the account has one active contract of the contract type which is associated with the price item. If so, it fetches the contract for further processing. Once the effective pricing rule, account, and active contract are derived, the transaction is mapped to the respective price item, price item parameters, and account. A transaction leg is created for each price item, price item parameters, and account combination. For example, if the system receives an ancillary transaction with the following details:

- UDF_CHAR_6 is set to BC1
- UDF_CHAR_7 is set to PASS
- UDF_DATE_1 is set to 15-03-2018
- Transaction Record Type is set to TR1

Let us assume that the ancillary transaction is mapped to the following price item, price item parameters, and account combinations:

Transaction Record Type	Primary Pricing Rule Type	Price Item	Price Item Parameters	Effective Pricing Rule	Pricing Arrangement	Account	Active Contract	Transaction Leg
TR1	ANCILLARY	P1	BCHGLINETYPE = UDF_CHAR_6 and PRICINGARRANGEMENT = UDF_CHAR_7	PR1	Pass Through without Markup or Markdown	A1	C1	TL1
		P2		PR2	Pass Through without Markup or Markdown	A2	C2	TL2
		P3		PR3	Pass Through without Markup or Markdown	A3	C3	TL3

Note: Here, the paid date is mapped to the **UDF_DATE_1** field and the **Pass Through without Markup or Markdown** pricing arrangement identifier is set to **PASS** in the ANCILLARY pricing rule type.

Example 3: Transaction Leg Derivation

In the example 3, the system maps the ancillary transaction to the following price item, price item parameters, and account combinations:

- Price Item: P1; Price Item Parameter: BCHGLINETYPE = BC1 and PRICINGARRANGEMENT = Pass Through without Markup or Markdown; and Account: A1
- Price Item: P2; Price Item Parameter: BCHGLINETYPE = BC1 and PRICINGARRANGEMENT = Pass Through without Markup or Markdown; and Account: A2
- Price Item: P3; Price Item Parameter: BCHGLINETYPE = BC1 and PRICINGARRANGEMENT = Pass Through without Markup or Markdown; and Account: A3

In the example 3, the system creates three transaction legs — TL1, TL2, and TL3 for the ancillary transaction. Once a transaction leg is created, the respective effective pricing rule is stamped against the transaction leg. In addition, the price item parameters of the transaction leg are grouped. In the example 3, the system creates one price item parameter group which contains the following price item parameters:

- BCHGLINETYPE = BC1
- PRICINGARRANGEMENT = PASS

A group is used to determine the price item pricing. A unique group ID is generated for each group. If a group with a set of price item parameters already exists in the system, a new group is not created. Instead, the existing group is used for determining the price item pricing.

Note: The price item parameter group contains only those price item parameters included in the primary pricing rule type for which the parameter usage is set to **Pricing**.

If a pricing group is used while defining a pricing rule for a bill group, the system fetches the pricing rule for an ancillary transaction when the following conditions are met:

- The paid date of the ancillary transaction falls within the pricing rule's date range.
- The employee attributes specified in the ancillary transaction match the criteria defined in any one of the pricing group rule.
- The pricing arrangement specified in the ancillary transaction matches the pricing arrangement specified in the pricing rule.

Let us understand this with the help of an example. An ancillary transaction is received with the following details:

- UDF_CHAR_1 is set to X
- UDF_CHAR_2 is set to Western
- UDF_CHAR_3 is set to Indian
- UDF_CHAR_4 is set to HR
- UDF_CHAR_5 is set to Permanent
- UDF_CHAR_6 is set to BC1
- UDF_CHAR_7 is set to PASS
- UDF_DATE_1 is set to 26-01-2018
- Transaction Record Type is set to TR6

Let us assume that the following pricing structure is defined in the system:

Transaction Record Type	Primary Pricing Rule Type	Price Item	Price Item Parameters	Pricing Rule	Pricing Start Date	Pricing End Date	Pricing Group	Pricing Group Rule	Pricing Arrangement
TR6	ANCILLARY	P1	BCHGLINETYPE = UDF_CHAR_6 and PRICINGARRANGEMENT = UDF_CHAR_7	PR1	01-01-2018	31-12-2018	PG1	Rule 1 (where Source System = X, Parameter 1 = Western, Parameter 2 = Indian, Parameter 3 = HR, and Parameter 4 = Permanent)	Pass Through without Markup or Markdown
								Rule 2 (where Source System = X, Parameter 1 = Eastern, and Parameter 2 = Indian, Parameter 3 = HR, and Parameter 4 = Permanent)	Pass Through without Markup or Markdown

Note: Here, the source system is mapped to the **UDF_CHAR_1** field, the parameter 1 is mapped to the **UDF_CHAR_2** field, the parameter 2 is mapped to the **UDF_CHAR_3** field, the parameter 3 is mapped to the **UDF_CHAR_4** field, the parameter 4 is mapped to the **UDF_CHAR_5** field, the paid date is mapped to the **UDF_DATE_1** field, and the **Pass Through without Markup or Markdown** pricing arrangement identifier is set to **PASS** in the **ANCILLARY** pricing rule type.

Example 4: Effective Pricing Rule is Defined Using a Pricing Group

In the example 4, the system considers the PR1 pricing rule for P1 because of the following reasons:

- The paid date (i.e. 26-01-2018) of the ancillary transaction falls within the PR1 pricing rule's date range (i.e. 01-01-2018 to 31-12-2018).
- The employee attributes specified in the ancillary transaction match the criteria defined in the Rule 1 (i.e. Source System = X, Parameter 1 = Western, Parameter 2 = Indian, Parameter 3 = HR, and Parameter 4 = Permanent).
- The pricing arrangement is set to **Pass Through without Markup or Markdown** within Rule 1 of the PR1 pricing rule.

The system then stores the pricing group rule which is satisfied against a parameter which is defined in the **Pricing Group Rule Parameter** option type of the **C1-ASOBLLNG** feature configuration. In such case, the price item parameter group contains the price item parameters and the pricing group rule parameter. For example, Group A contains BCHGLINETYPE = BC1, PRICINGARRANGEMENT = PASS, and Pricing Group Rule Parameter = Rule 1.

In the example 4, the system could find the exact match for pricing parameters defined in the pricing group rule. However, if the exact match is not available, the system finds the effective pricing rule using the best fit match for the pricing parameters defined in the pricing group rule. Note that the system searches for the exact match in the effective pricing rules at both the bill group and parent customer levels. If the exact match is not available at both the levels, the system finds the effective pricing rule using the best fit match for the pricing parameters (defined in the pricing group rule) first at the bill group level and then at the parent customer level.

Let us understand this with the help of an example. An ancillary transaction is received with the following details:

- UDF_CHAR_1 is set to X
- UDF_CHAR_2 is set to Western
- UDF_CHAR_3 is set to Indian
- UDF_CHAR_4 is set to HR
- UDF_CHAR_5 is set to Permanent
- UDF_CHAR_6 is set to BC1
- UDF_CHAR_7 is set to PASS
- UDF_DATE_1 is set to 31-05-2018
- Transaction Record Type is set to TR6

Let us assume that the following pricing structure is defined in the system:

Transaction Record Type	Primary Pricing Rule Type	Price Item	Price Item Parameters	Pricing Rule	Pricing Start Date	Pricing End Date	Pricing Group	Pricing Group Rule	Pricing Arrangement
TR6	ANCILLARY	PP1	BCHGLINETYPE = UDF_CHAR_6 and PRICINGARRANGEMENT = UDF_CHAR_7	PR1	01-01-2018	31-12-2018	PG1	Rule 1 (where Source System = X and Parameter 1= Western)	Pass Through without Markup or Markdown
								Rule 1 (where Source System = X and Parameter 1 = Western)	Pass Through without Markup or Markdown

Transaction Record Type	Primary Pricing Rule Type	Price Item	Price Item Parameters	Pricing Rule	Pricing Start Date	Pricing End Date	Pricing Group	Pricing Group Rule	Pricing Arrangement
								Rule 2 (where Source System = X and Parameter 1 = Eastern)	Pass Through without Markup or Markdown
								Rule 2 (where Source System = X and Parameter 1 = Eastern)	Pass Through without Markup or Markdown
		PP2		PR2	01-01-2018	31-12-2018	PG2	Rule 1 (where Source System = X, Parameter 1 = Eastern, Parameter 2 = Indian, Parameter 3 = HR, and Parameter 4 = Permanent)	Pass Through without Markup or Markdown
								Rule 1 (where Source System = X, Parameter 1 = Eastern, Parameter 2 = Indian, Parameter 3 = HR, and Parameter 4 = Permanent)	Pass Through without Markup or Markdown
								Rule 2 (where Source System = X, Parameter 1 = Western, Parameter 2 = Indian, Parameter 3 = HR, and Parameter 4 = Permanent)	Pass Through without Markup or Markdown

Transaction Record Type	Primary Pricing Rule Type	Price Item	Price Item Parameters	Pricing Rule	Pricing Start Date	Pricing End Date	Pricing Group	Pricing Group Rule	Pricing Arrangement
								Rule 2 (where Source System = X, Parameter 1 = Western, Parameter 2 = Indian, Parameter 3 = HR, and Parameter 4 = Permanent)	Pass Through without Markup or Markdown

Note: Here, the source system is mapped to the **UDF_CHAR_1** field, the parameter 1 is mapped to the **UDF_CHAR_2** field, the parameter 2 is mapped to the **UDF_CHAR_3** field, the parameter 3 is mapped to the **UDF_CHAR_4** field, the parameter 4 is mapped to the **UDF_CHAR_5** field, the paid date is mapped to the **UDF_DATE_1** field, and the **Pass Through without Markup or Markdown** pricing arrangement identifier is set to **PASS** in the ANCILLARY pricing rule type.

Example 5: Effective Pricing Rule Derivation Using Best Fit Match for Pricing Parameters

In the example 5, the system could not find the exact match for the pricing parameters (i.e. Source System = X, Parameter 1 = Western, Parameter 2 = Indian, Parameter 3 = HR, and Parameter 4 = Permanent) in the effective pricing rule for PP1. Therefore, the system searches for the best fit match. While searching for the best fit match, the system rules out the optional parameter 4 (i.e. Parameter 4 = Permanent) and then checks whether the pricing group rule where Source System = X, Parameter 1 = Western, Parameter 2 = Indian, and Parameter 3 = HR exists in the effective pricing rule. If so, it considers the pricing group rule for further processing. If not, the system then rules out the optional parameter 3 (i.e. Parameter 3 = HR) and then checks whether the pricing group rule where Source System = X, Parameter 1 = Western, and Parameter 2 = Indian exists in the effective pricing rule. If so, it considers the pricing group rule for further processing. If not, the system then rules out the optional parameter 2 (i.e. Parameter 2 = Indian) and then checks whether the pricing group rule where Source System = X and Parameter 1 = Western exists in the effective pricing rule. If so, it considers the pricing group rule for further processing. If not, the status of the transaction is changed to **Error**.

In the example 5, the system considers Rule 1 where Source System = X and Parameter 1 = Western as the best fit match in the PR1 pricing rule for PP1. In addition, the pricing arrangement is set to **Pass Through without Markup or Markdown** within Rule 1 of the PR1 pricing rule. Therefore, the system fetches PR1 as the effective pricing rule for PP1. In addition, the system fetches PR2 as the effective pricing rule for PP2. The system creates two price item parameter groups — One contains BCHGLINETYPE = BC1, PRICINGARRANGEMENT = PASS, and Pricing Group Rule Parameter = Rule 1 and another contains BCHGLINETYPE = BC1, PRICINGARRANGEMENT = PASS, and Pricing Group Rule Parameter = Rule 2. Once the price item parameter group is created, the system creates the aggregation parameter group. An aggregation parameter group contains all price item parameters included in the related pricing rule type for which the parameter usage is set to **Aggregation**.

If the effective pricing rule is not derived for a price item and price item parameters combination or if the account or active contract for the account is not derived, the system does not create a transaction leg for the respective price item. Let us understand this with the help of an example:

Primary Pricing Rule Type	Price Item	Price Item Parameters	Effective Pricing Rule	Account	Active Contract	Transaction Leg
ANCILLARY	PP11	BCHGLINETYPE = UDF_CHAR_6 and	-	-	-	-
	PP12	PRICINGARRANGEMENT = UDF_CHAR_7	PR12	A1	C1	TL11

Primary Pricing Rule Type	Price Item	Price Item Parameters	Effective Pricing Rule	Account	Active Contract	Transaction Leg
	PP13		PR13	-	-	-
	PP14		PR14	A2	-	-
	PP15		PR15	-	-	-
	PP16		-	-	-	-
	PP17		PR17	A2	C2	TL12

Example 6: No. of Transaction Legs Derived

In the example 6, the system could not find the effective pricing rule for PP11 and PP16, the required account for PP13 and PP15, and the active contract for PP14 on A2. Therefore, in this case, the system creates two transaction legs — TL11 and TL12 for the transaction.

If the eligibility rule type is defined of a price item, the system maps the ancillary transaction to the price item when the eligibility rule is satisfied. If the eligibility rule is not satisfied, the system does not consider the price item for billing. For example,

Price Item	Eligibility Criteria Met	Effective Pricing Rule	Account	Active Contract	Transaction Leg
PE1	Yes	PR1	A1	C1	TL1
PE2	-	PR2	-	-	-
PE3	No	-	-	-	-
PE4	Yes	-	-	-	-
PE5	Yes	PR3	A2	-	-
PE6	Yes	PR4	-	-	-

Example 7: Price Item Eligibility for Transaction Leg Derivation

In the example 7, the eligibility criteria was defined for PE1, PE3, PE4, PE5, and PE6. The eligibility criteria was satisfied for PE1, PE4, PE5, and PE6, but not for PE3. Further, the system could not find the effective pricing rule for PE4, the required account for PE2 and PE6, and the active contract for PE5 on A2. Therefore, in this case, the system creates one transaction leg (i.e. TL1) for the ancillary transaction. For more information, refer to the [Price Item Eligibility](#) on page 2950 section.

Once a transaction leg is created, the derivation date is set as the processing date corresponding to the transaction leg.

Bill After Date Determination

Once the billable charges are created for claim, claim based fees, enrollment based fees, and ancillary, the system enables you to automatically stamp the bill after date in these billable charges. The system can automatically stamp the bill after date in these billable charges when an algorithm created using the **C1_BAFTDRV** algorithm type is attached to the **Bill After Date Determination** system event of the respective pricing rule type. This algorithm sets the bill after date to the end date of the aggregation schedule period in which the transaction date falls. Note that the system considers the aggregation schedule specified in the rate option which is defined for the respective price item. Let us understand this with the help of an example. If the claim transaction with the transaction date set to 25-06-2018 is mapped to the following price item and account combinations:

Pricing Rule Type	Price Item	Rate Option	Aggregate Transaction	Aggregation Schedule	Schedule Period	Account	Billable Charge
CLAIM	P1	R01	Yes	Monthly	01-01-2018 — 31-01-2018	A1	BC1
					01-02-2018 — 28-02-2018		
					01-03-2018 — 31-03-2018		
					01-04-2018 — 30-04-2018		
					01-05-2018 — 31-05-2018		
					01-06-2018 — 30-06-2018		
					01-07-2018 — 31-07-2018		
					01-08-2018 — 31-08-2018		
	P2	R01	Yes	Monthly	01-09-2018 — 30-09-2018	A2	BC2
					01-10-2018 — 31-10-2018		
					01-11-2018 — 30-11-2018		
					01-12-2018 — 31-12-2018		
	P3	R02	Yes	Yearly	01-01-2018 — 31-12-2018	A3	BC3

Example 1: Bill After Date Determination Using the Aggregation Schedule

In the example 1, the system stamps 30-06-2018 as the bill after date in the BC1 and BC2 billable charges. This is because the transaction date (i.e. 25-06-2018) falls in the 01-06-2018 — 30-06-2018 period of the R01 aggregation schedule.

However, the system stamps 31-12-2018 as the bill after date in the BC3 billable charge. This is because the transaction date (i.e. 25-06-2018) falls in the 01-01-2018 — 31-12-2018 period of the R02 aggregation schedule.

Note: The bill after date for the specific stop-loss and aggregate stop-loss billable charges is calculated using the settlement frequency in the **Create Specific Stop-Loss Billable Charge (C1-BCSSL)** and **Create Aggregate Stop-Loss Billable Charge (C1-BCASL)** batches, respectively.

Advance Billing for Claim Fund Charge

Until now, the system enabled you to configure the pricing for level funding and generate the claim fund charges for a self-funded employer using either of the following approach:

- Flat level funding
- Enrollment based level funding

Now, the system enables you to bill the claim fund charges to a self-funded employer in advance. In case of enrollment based level funding, the system can receive the enrollment transactions for the month of January in the month of December. Once the January enrollment transactions are received in December, the system can create claim fund charges based on the January enrollment in the month of December and accordingly bill the self-funded employer. However, the claim fund charges which are billed in the month of December will be adjusted against the claim, ancillary, or other charges which are eligible for level funding only in the month of January.

To enable this feature, you need to do the following:

- **Set the Advance Level Funding Eligibility Option** – A new field named **Advance Level Funding Eligibility** is available while defining a self-funded policy. You can set the value of the **Advance Level Funding Eligibility** field to either **Yes** or **No**. You can define the **Advance Level Funding Eligibility** field only through a health care inbound message and not from the user interface. When you create a self-funded policy from the user interface, the **Advance Level Funding Eligibility** field is non-editable. By default, the value is set to **No**. You can then change the value through a health care inbound message.
- **Set the Advance Billing Option** – A new field named **Advance Billing** is available while defining a retention type enrollment based pricing rule. You can set the value of the **Advance Billing** field to either **Yes** or **No**.
- **Create a Prospective Bill Period** – You need to create a prospective bill period wherein the bill date falls in a month prior to the month of bill segment end date. For example, if the bill segment end date is 01-31-2021, then you can set the bill date to 12-31-2020. You must use the prospective bill period in the recurring flat fee pricing rule using which you want to create the flat claim fund charge which should be billed in advance.

If the **Advance Level Funding Eligibility** field is set to **Y** through a health care inbound message, the system activates the self-funded policy even if the policy start date is later than the inbound processing date. Accordingly, a log is maintained for the self-funded policy.

On renewing a self-funded policy, the system provides the ability to copy the advance level funding eligibility value of the base policy to the renewed policy. A new field named **Copy Advance Level Funding Eligibility** is available while renewing a self-funded policy. If you select the **Copy Advance Level Funding Eligibility** option, the value is copied from the base policy to the renewed policy. If the **Advance Level Funding Eligibility** field is set to **Y** in the base policy, the system activates the renewed self-funded policy on the policy renewal even if the renewed policy's start date is later than the system date.

To implement this business requirement, the following changes are made in the system:

- While accumulating the charges which are eligible for level funding, the system behaves in the following manner:
 - In case of advance flat level funding, the system considers only those claim fund bill segments where the end date is earlier than or equal to the accumulation run date and then adjusts the accumulation amount against those claim fund charges which were billed in the previous bill period.
 - In case of advance enrollment based level funding, the system considers the enrollment transactions based on their coverage end date. Only those enrollment transactions where coverage end date is earlier than or equal to the accumulation run date are accumulated and then adjusted against the claim fund charges which were billed earlier.
- If the **Advance Level Funding Eligibility** field is set to **Y** for a self-funded policy and the inbound processing date is earlier than the policy start date, the system sets the contract start date to the first day of the month in which the inbound message is processed. Otherwise, the contract start date is set to policy start date.

- The system determines the bill after date depending on the value set for the **Advance Billing** field in the retention type enrollment based pricing rule. If the **Advance Billing** field is set to **Yes**, then the bill after date is set to accounting date – 1. Here, the accounting date is fetched from the schedule of the account's bill cycle where the transaction date falls. However, if the **Advance Billing** field is set to **No**, then the bill after date is set to accounting date – 1. Here, the accounting date is fetched from the schedule of the account's bill cycle where the transaction's coverage end date falls.

SSL Accumulation across Bill Groups

Specific Stop-Loss (SSL) protects the self-funded employers against the excess claims from a single individual who is a member in the self-funded policy. Oracle Revenue Management and Billing enables the customers to configure the SSL pricing rules wherein the SSL Limit and SSL Payout Limit are defined. For the excess claims from a member, arising on top of the SSL Limit defined for the bill group, the insurer will provide the SSL credits (capped with the SSL Payout Limit) to the self-funded employer.

There can be scenarios in which a member moves from one bill group to another. For example, an employee changes the department or work location. ORMB provides the ability to continue the accumulation of the transaction amount across the bill groups, if both bill groups have the same SSL limit and their accounts have same bill cycle. If the SSL Limits of the bill groups are different or if the bill groups' accounts have different bill cycles, the accumulation is calculated individually for each bill group based on the respective SSL Limit.

To enable the SSL Accumulation across Bill Groups feature, you need to set the **SSL Member Movement Configuration** option type in the **C1-ASOBLNG** feature configuration to either of the following:

- INDIVIDUAL
- PROPORTIONATE
- CURRENTBG

If you do not set the value for the **SSL Member Movement Configuration** option type in the **C1-ASOBLNG** feature configuration, by default, it is set to **INDIVIDUAL**.

While accumulating the SSL charges for a member, the system checks whether the member is associated with more than one bill group. If so, the system derives the value from the **SSL Member Movement Configuration** option type of the **C1-ASOBLNG** feature configuration to determine the manner in which the SSL credits should be given to the bill groups. If the value of the **SSL Member Movement Configuration** option type is set to **PROPORTIONATE**, the system does weighted distribution of the total SSL credits across the associated bill groups based on the cumulative aggregation amount of each bill group. If the value of the **SSL Member Movement Configuration** option type is set to **CURRENTBG**, the system gives the remaining SSL credits to the present bill group irrespective of the bill group for which the transaction is received. If the value of the **SSL Member Movement Configuration** option type is set to **INDIVIDUAL**, the system accumulates the charges which are eligible for SSL and calculates the SSL credits individually for each bill group based on the respective SSL Limit.

Note: In case of a member who has opted for lasering, the system considers the lasered amount instead of the SSL limit during SSL credit calculation.

Chapter 37

Fully-Insured Pricing

Topics:

- [Age Based Pricing](#)
- [Tier Based Pricing](#)
- [Pass-Through Billable Charge](#)
- [Administration Fee Pricing for COBRA Membership](#)
- [Medicare Part D LIS and LEP Pricing](#)
- [Discount Charge Pricing for Retiree Membership](#)
- [Pricing Rule Inactivation](#)

A new pricing model is introduced for the fully-insured group business. In this pricing model, you can define pricing rules using the pricing rule types. At present, you can define the following pricing rule types for the fully-insured group business:

- [Age Based Pricing Rule Type](#)
- [Tier Based Pricing Rule Type](#)
- [Pass-Through Billable Charge Pricing Rule Type](#)

Note: You cannot define pricing rules using the pass-through billable charge pricing rule types. However, you can directly create SQI based billable charges using a pass-through billable charge pricing rule type. For more information, refer to the [Pass-Through Billable Charge](#) on page 3052 section.

Related Topics

For more information on...	See...
Pricing Parameters	Pricing Parameters on page 99
Age Based Pricing	Age Based Pricing on page 3014
Tier Based Pricing	Tier Based Pricing on page 3035
Pass-Through Billable Charge	Pass-Through Billable Charge on page 3052
Administration Fee Pricing for COBRA Membership	Administration Fee Pricing for COBRA Membership on page 3065
Medicare Part D LIS and LEP Pricing	Medicare Part D LIS and LEP Pricing on page 3080
Discount Charge Pricing for Retiree Membership	Discount Charge Pricing for Retiree Membership on page 3093
Pricing Rule Inactivation	Pricing Rule Inactivation on page 3112

Age Based Pricing

In the Fully-Insured Pricing, the base rate for premium and fees depend upon the age, member attributes (such as employee type, employee status, etc.) and modifiers (such as tobacco usage, gender, alcohol usage, etc.). Oracle Revenue Management and Billing enables you to offer an age based pricing to a fully-insured group customer. In the Age Based pricing, the premium is calculated for each eligible member based on age, member attributes and modifiers, and then aggregated to derive the total premium for the membership. An age based pricing can be defined using the age based pricing rule. You can define an age based pricing rule for a price item on the policy plan. If the age based pricing rule is defined for a price item on a policy plan, all memberships which belong to the policy plan will inherit the age based pricing from the policy plan. If the system does not find any effective pricing rule for a price item on the policy plan, it inherits the effective pricing rule for the price item from the parent customer level.

You can define an age based pricing rule using an age based pricing rule type. It is the age based pricing rule type which helps the system to determine:

- **C1-PricingRuleAgeBased** Business object using which the age based pricing rule should be created in the system.
- Algorithm which should be triggered for deriving the account and price item for a membership.

Note: You must create an algorithm using the **C1_ACCPRIMEM** algorithm type and attach it to the **Account and Price Item Derivation** system event.

- Algorithm which should be triggered for deriving the bill period for a membership.

Note: You must create an algorithm using the **C1-BILLPDRV** algorithm type and attach it to the **Account and Price Item Derivation Post-Processing** system event.

- Algorithm which should be triggered for creating the bill period timeline (based on the derived bill period) for a membership.

Note: You must create an algorithm using the **C1-BILLRPCR** algorithm type and attach it to the **Account and Price Item Derivation Post-Processing** system event.

- Algorithm which should be triggered for deriving the bill group, parent customer, and policy for a membership.

Note: You must create an algorithm using the **C1_MEMBGDRV** algorithm type and attach it to the **Bill Group Derivation** system event.

- Algorithm which should be triggered for calculating the age based premium for a membership.

Note: You must create an algorithm using the **C1_AGEPREM** algorithm type and attach it to the **Premium Calculation** system event.

- Algorithm which should be triggered for identifying eligible member persons for premium calculation.

Note: You must create an algorithm using the **C1_AGEBDELG** algorithm type and attach it to the **Pricing Rule Pre-Processing** system event.

- Algorithm which should be triggered for calculating the premium for each eligible member person.

Note: You must create an algorithm using the **C1-FICRETBC** algorithm type and attach it to the **Billable Charge Creation Post Processing** system event.

- Algorithm which should be triggered for deriving the bill period for the account.

Note: You must create an algorithm using the **C1-AGEPRFC** algorithm type and attach it to the **Pricing Rule Proration Amount Calculation** system event.

- Algorithm which should be triggered to configure skip months for an account.

Note: You must create an algorithm using the **C1-SKPMNTHPC** algorithm type and attach it to the **Skip Month Premium Calculation (in case you want to use the 9/10 Billing feature)** system event.

- Price items for which you can define age based pricing rules using the age based pricing rule type.
- Rate options that you can use while defining the pricing for the respective price item.
- Type of account to which the respective price item should be billed based on the specified priority.
- Rule type which indicates the rules that should be executed to determine whether the price item is eligible for billing.
- Audit event types of the C1-Membership and C1-PERSON business objects using which the audit event should be created whenever a membership or member person is added, updated, or removed from the policy plan.
- Elements of the C1-Membership and C1-PERSON business objects for which audit event should be created.

Note: You must ensure that either the **Update All** option is selected or the elements listed in the age based pricing rule type are already present in the respective audit event type. Otherwise, erroneous results might occur.

- Members, such as main subscriber, spouse, or children in a membership are eligible for premium calculation.
- Following are the additional dependents attributes which can affect the premium calculation if they are considered as part of pricing rules. These additional attributes are defined as characteristics for the policy plan. You must specify the following characteristic types in the age based pricing rule type:
 - **Maximum Number of Dependents** – This characteristic type stores the maximum number of children which are eligible for premium calculation. You must specify a characteristic type where the characteristic entity is set to **Member Person, Membership, Policy Plan, Policy, and State**.
 - **Maximum Age Limit for Maximum Dependent Count** – This characteristic type stores the maximum age limit for children which are eligible for premium calculation. You must specify a characteristic type where the characteristic entity is set to **Member Person, Membership, Policy Plan, Policy, and State**.
 - **Maximum Number of Dependents Order Priority** – This characteristic type indicates whether the youngest or eldest children should be considered during premium calculation. Each plan may set a limit to consider the number of dependents, either the eldest or youngest one for premium calculation. You must specify a characteristic type where the characteristic entity is set to **Member Person, Membership, Policy Plan, Policy, and State**.
 - **Age Calculation Date Basis** – This characteristic type indicates whether the member person's age should be calculated using the member person's enrollment date or policy's start or renewal date. You must specify a characteristic type where the characteristic entity is set to **Member Person, Membership, Policy Plan, Policy, and State**.
 - **Newborn Gift Days** – This characteristic type stores the number of days you want to offer as gift days from the new born child's enrollment date. You must specify a characteristic type where the characteristic entity is set to **Member Person, Membership, Policy Plan, Policy, and State**.
 - **Newborn Gift Days Applicability** – This characteristic type indicates whether the gift days should be offered in case of a new born. You must specify a characteristic type where the characteristic entity is set to **Member Person, Membership, Policy Plan, Policy, and State**.
 - **Young Adult Max Age Limit** – This characteristic type stores the maximum age limit for young adults which are eligible for premium calculation. You must specify a characteristic type where the characteristic entity is set to **Member Person, Membership, Policy Plan, Policy, and State**.
 - **Young Adult Inclusion Applicability** – This characteristic type indicates whether the young adults should be considered during the premium calculation. You must specify a characteristic type where the characteristic entity is set to **Member Person, Membership, Policy Plan, Policy, and State**.

Once an age based pricing rule type is defined, you can define age based pricing rules using the age based pricing rule type. Note that, at present, you can define age based pricing rules only through a health care inbound message and not from the user interface. However, you can view the age based pricing rules defined for a policy plan from the **Customer 360° Information** screen. While creating an age based pricing rule through a health care inbound message, you need to specify the following information:

- Entity type (i.e. Policy Plan) and entity ID (i.e. policy plan ID) for which you want to define the age based pricing rule
- Start and end dates of the age based pricing rule
- Age based pricing rule type using which you want to create the age based pricing rule
- Price Item for which you want to define age based pricing
- Rate option using which the price assignment should be created for the age based pricing rule

Note: If the rate option is not given in the pricing rule data, by default, it is set to a value specified in the **Default Rate Option – Flat** or **Default Rate Option – Percentage** option type of the **C1-ASOBLLNG** feature configuration depending on whether the modifier method is set to **FLAT**, **EXPT** or **INPT**.

- Whether you want to increase or decrease the premium of an eligible member by a flat amount or in percentage based on some modifier attributes (such as tobacco usage, alcohol usage, and so on).
- Age limit and employee attributes for which the base fee is applicable

Note:

The system defines the lower age limit and upper age limit pricing eligibility criteria using the parameter which is specified in the **Age Based Parameter** option type of the **C1-ASOBLLNG** feature configuration.

The employee attributes can be defined as the parameters in the system. These parameters can then be used to define eligibility criteria in the age based pricing. Here, you can use only those parameters where the parameter usage is set to **Pricing Eligibility**.

- Modifiers based on which you want to charge additional or offer discount to an eligible member

Note: The modifiers can be defined as the parameters in the system. These parameters can then be used to define eligibility criteria in the age based pricing. Here, you can use only those parameters where the parameter usage is set to **Pricing Eligibility**.

Once the age based pricing rule is defined for a policy plan, the system creates a price item pricing and price list and then assigns the price item pricing to the price list.

Related Topics

For more information on...	See...
How to define an age based pricing rule type	Defining an Age Based Pricing Rule Type on page 3017
How to add the related pricing rule types in an age based pricing rule type	Adding the Related Pricing Rule Types in an Age Based Pricing Rule Type on page 3019
How to associating an algorithm with an age based pricing rule type	Associating an Algorithm with an Age Based Pricing Rule Type on page 3021
How to add a price item in an age based pricing rule type	Adding a Price Item in an Age Based Pricing Rule Type on page 3023
How to add a price item parameter in an age based pricing rule type	Adding a Price Item Parameter in an Age Based Pricing Rule Type on page 3026

For more information on...	See...
How to define the characteristics for an age based pricing rule type	Defining a Characteristic for an Age Based Pricing Rule Type on page 3027
How to add elements for an audit in an age based pricing rule type	Adding Elements for Audit in an Age Based Pricing Rule Type on page 3028
How to define age based specific additional data in an age based pricing rule type	Defining an Age Based Specific Additional Data in an Age Based Pricing Rule Type on page 3029
How to map characteristic attributes in an age based pricing rule type	Mapping Characteristic Attributes in an Age Based Pricing Rule Type on page 3030
How to edit an age based pricing rule type	Editing an Age Based Pricing Rule Type on page 3031
How to delete an age based pricing rule type	Deleting an Age Based Pricing Rule Type on page 3034
How to view the age based pricing rule type details	Viewing the Age Based Pricing Rule Type Details on page 3034

Defining an Age Based Pricing Rule Type

Prerequisites

To define an age based pricing rule type, you should have:

- Age based pricing rule type business object defined in the application.
- Age based pricing rule business object defined in the application.
- Pricing rule type category for the age based defined in the application.

Procedure

To define an age based pricing rule type:

1. Click the **Admin** link in the **Application** toolbar.
A list appears.
2. From the **Admin** menu, select **P** and then click **Pricing Rule Type**.
A sub-menu appears.
3. Click the **Add** option from the **Pricing Rule Type** sub-menu.

The **Select Business Object** screen appears. It contains the following field:

Field Name	Field Description	Mandatory (Yes or No)
Pricing Rule Type Business Object	Used to indicate the business object using which you want to create an age based pricing rule type. Note: You can create an age based pricing rule type using the Age Based Pricing Rule Type business object.	Yes

Tip: Alternatively, you can access this screen by clicking the **Add** button in the **Page Title** area of the **Pricing Rule Type** screen.

4. Select the **Age Based Pricing Rule Type** option from the **Pricing Rule Type Business Object** list.
5. Click **OK**.

The **Age Based Pricing Rule Type** screen appears. It contains the following sections:

- **Main** – Used to specify basic details about an age based pricing rule type.
- **Related Pricing Rule Type** – Used to define the pricing rule types which are related to the age based pricing rule type.

Note: The **Related Pricing Rule Type** section appears when the **Primary** check-box is selected.

- **Algorithms** – Used to associate the algorithms with an age based pricing rule type.
- **Price Items** – Used to add the price items for which you can define the age based pricing rules using the age based pricing rule type.
- **Price Item Parameters** – Used to add the price item parameters based on which you want to define the price item pricing.
- **Characteristics** – Used to define the characteristics for an age based pricing rule type.
- **Event Management** – Used to configure the audit in an age based pricing rule type.
- **Age Based Specific Additional Data** – Used to define the age based specific additional data in an age based pricing rule type.
- **Attribute Characteristic Mapping** – Used to map a characteristic attribute in an age based pricing rule type.

The **Main** section contains the following fields:

Field Name	Field Description	Mandatory (Yes or No)
Pricing Rule Type	Used to specify an age based pricing rule type.	Yes
Description	Used to specify the description for an age based pricing rule type.	Yes
Detailed Description	Used to specify additional information about an age based pricing rule type.	No
Pricing Rule Business Object	Used to indicate the business object using which you want to create an age based pricing rule type. The valid value is: <ul style="list-style-type: none"> • Age Based Pricing Rule 	Yes
Business Object	Indicates the business object using which you are defining an age based pricing rule type.	Not applicable
Status	Used to indicate the status of an age based pricing rule type. The valid values are: <ul style="list-style-type: none"> • Active • Inactive 	Yes
Primary	Used to select the checkbox if the pricing rule type is primary.	No
Skip Non-Members	Used to select the checkbox when you want the system to only consider the eligible members and not non-members of the active employee coverage membership during age based premium calculation.	No

Field Name	Field Description	Mandatory (Yes or No)
Pricing Rule Type Category	Used to indicate the category to which the pricing rule type belongs. The valid value is: <ul style="list-style-type: none"> Age Based 	Yes

- Enter the required details in the **Main** section.
- Add the related pricing rule types in the age based pricing rule type, if required.

Note: The **Related Pricing Rule Type** section appears when the **Primary** check-box is selected.

- Associate the required algorithms with the age based pricing rule type.
- Add the required price items in an age based pricing rule type.
- Add the price item parameters in an age based pricing rule type, if required.
- Define characteristics for an age based pricing rule type, if required.
- Configure the audit in an age based pricing rule type.
- Define an age based specific additional data in an age based pricing rule type.
- Map a characteristic attribute in an age based pricing rule type
- Click **Save**.

The age based pricing rule type is defined.

Related Topics

For more information on...	See...
How to add the related pricing rule types in an age based pricing rule type	Adding the Related Pricing Rule Types in an Age Based Pricing Rule Type on page 3019
How to associate algorithms with an age based pricing rule type	Associating an Algorithm with an Age Based Pricing Rule Type on page 3021
How to add price items in an age based pricing rule type	Adding a Price Item in an Age Based Pricing Rule Type on page 3023
How to add price item parameters in an age based pricing rule type	Adding a Price Item Parameter in an Age Based Pricing Rule Type on page 3026
How to define characteristics for an age based pricing rule type	Defining a Characteristic for an Age Based Pricing Rule Type on page 3027
How to add elements for audit in an age based pricing rule type	Adding Elements for Audit in an Age Based Pricing Rule Type on page 3028
How to define age based specific additional data in an age based pricing rule type	Defining an Age Based Specific Additional Data in an Age Based Pricing Rule Type on page 3029
How to map characteristic attributes in an age based pricing rule type	Mapping Characteristic Attributes in an Age Based Pricing Rule Type on page 3030

Adding the Related Pricing Rule Types in an Age Based Pricing Rule Type

Prerequisites

To add related pricing rule types in an age based pricing rule type, you should have:

- Additional charge pricing rule type defined in the application.
- Eligibility rule type defined in the application.

Procedure

To add related pricing rule types in an age based pricing rule type:

1. Ensure that the **Related Pricing Rule Types** section is expanded when you are defining or editing an age based pricing rule type.

Note: This section appears when the **Primary** option is selected in the **Main** section.

The **Related Pricing Rule Types** section contains the following columns in a grid:

Column Name	Column Description	Mandatory (Yes or No)
Sequence	Used to specify the order in which the related pricing rule type should be invoked.	Yes (Conditional) Note: This field is required when you are defining a pricing rule type for the related pricing rule type.
Pricing Rule Type	Used to specify the pricing rule type which should be executed to determine whether the related pricing rule type is eligible for deriving the transaction legs. Note: On clicking the Search (🔍) icon that appears corresponding to the Pricing Rule Type field, the Pricing Rule Type Search window appears. On specifying the related pricing rule type, the description of the pricing rule type appears corresponding to the Pricing Rule Type field.	Yes (Conditional) Note: This field is required when the corresponding Sequence and Eligibility Rule Type field is specified for the related pricing rule type.
Eligibility Rule Type	Used to indicate the rule type eligibility for the related pricing rule type. Note: The Eligibility Rule Type list includes only those rule-types where the rule type eligibility is Related Pricing Rule Type Eligibility .	No

2. Enter the required details in the **Related Pricing Rule Types** section.
3. If you want to define more than one related pricing rule type for the age based pricing rule type, click the **Add** (+) icon and then repeat step 2.

Note: However, if you want to remove a related pricing rule type from the age based pricing rule type, click the **Delete** (🗑️) icon corresponding to the related pricing rule type.

4. Click **Save**.

The related pricing rule types are added for the age based pricing rule type.

Related Topics

For more information on...	See...
How to define a fully-insured age based pricing rule type	Defining an Age Based Pricing Rule Type on page 3017
How to define a fully-insured tier based pricing rule type	Defining a Tier Based Pricing Rule Type on page 3037
How to edit a fully-insured age based pricing rule type	Editing an Age Based Pricing Rule Type on page 3031
How to edit a fully-insured tier based pricing rule type	Editing a Tier Based Pricing Rule Type on page 3049

Associating an Algorithm with an Age Based Pricing Rule Type

Prerequisites

To associate algorithm with an age based pricing rule type, you should have:

- An algorithm defined using the **C1_ACCPRIMEM** algorithm type.
- An algorithm defined using the **C1-BILLPDRV** algorithm type.
- An algorithm defined using the **C1-BILLRPCR** algorithm type.
- An algorithm defined using the **C1_MEMBGDRV** algorithm type.
- An algorithm defined using the **C1_AGEPREM** algorithm type.
- An algorithm defined using the **C1_AGEBDELG** algorithm type.
- An algorithm defined using the **C1-FICRETBC** algorithm type.
- An algorithm defined using the **C1-AGEPRFC** algorithm type.
- An algorithm defined using the **C1-SKPMNTHPC** algorithm type.

Procedure

To associate algorithms with an age based pricing rule type:

1. Ensure that the **Algorithms** section is expanded when you are defining or editing the age based pricing rule type.

The **Algorithms** section contains the following columns in a grid:

Column Name	Column Description	Mandatory (Yes or No)
System Event	<p>Used to indicate the system event when you want to invoke the algorithm. The valid values are:</p> <ul style="list-style-type: none"> • Account and Price Item Derivation - Used to derive the account and price item for a membership. • Account and Price Item Derivation Post-Processing - Used to derive the bill period for the account. • Account and Price Item Derivation Post-Processing - Used to create the bill period timeline for the account. • Bill Group Derivation - Used to derive the bill group, parent customer, and policy for a membership. • Premium Calculation - Used to calculate the premium for each eligible member person. • Pricing Rule Pre-Processing - Used to identify the eligible member persons for premium calculation. • Billable Charge Creation Post Processing - Used to create new billable charges for both pre-calculated and post-calculated charges. • Pricing Rule Proration Amount Calculation - Used to calculate proration factor and amount for age based pricing rule based on the policy plan configurations. • Skip Month Premium Calculation (in case you want to use the 9/10 Billing feature) - Used to distribute the total premium in the non-skip months of the coverage period. 	<p>Yes</p> <p>Note: This field is required when you are associating an algorithm with the age based pricing rule type.</p>
Sequence	<p>Used to specify the order in which the algorithms for each system event must be executed.</p>	<p>Yes (Conditional)</p> <p>Note: This field is required when you are associating an algorithm with the age based pricing rule type.</p>
Algorithm	<p>Used to specify the algorithm.</p> <p>Note:</p> <p>Once you select the system event, the Search (🔍) icon appears corresponding to the Algorithm field. On clicking the Search (🔍) icon, the Algorithm Search window appears.</p> <p>On specifying the algorithm, the description of the algorithm appears corresponding to the Algorithm field.</p>	<p>Yes (Conditional)</p> <p>Note: This field is required when you are associating an algorithm with the age based pricing rule type.</p>

2. Enter the following details in the **Algorithms** section:

System Event	Algorithm	Algorithm Type	Description
Account and Price Item Derivation	C1_ACCPRIMEM	C1_ACCPRIMEM	Account and Price Item Derivation for Membership
Account and Price Item Derivation Post-Processing	C1-BILLPDRV	C1-BILLPDRV	Bill Period Derivation
Account and Price Item Derivation Post-Processing	C1-BILLRPCR	C1-BILLRPCR	Bill Period Time Line Creation
Bill Group Derivation	C1_MEMBGDRV	C1_MEMBGDRV	Bill Group Derivation for Membership
Premium Calculation	C1_AGEPREM	C1_AGEPREM	Age Based Premium Calculation
Pricing Rule Pre-Processing	C1_AGEBDELG	C1_AGEBDELG	Get Eligible Member Details from Membership
Billable Charge Creation Post Processing	C1-FICRETBC	C1-FICRETBC	Fully Insured Pass through Billable Charge Creation
Pricing Rule Proration Amount Calculation	C1-AGEPRFC	C1-AGEPRFC	Calculate Proration Factor for Age Based Pricing Rule
Skip Month Premium Calculation (in case you want to use the 9/10 Billing feature)	C1-SKPMNTHPC	C1-SKPMNTHPC	Skip Month Premium Calculation

3. If you want to associate more than one algorithm with the age based pricing rule type, click the **Add (+)** icon and then repeat step 2.

Note: However, if you want to disassociate an algorithm from the age based pricing rule type, click the **Delete (🗑)** icon corresponding to the algorithm.

4. Click **Save**.

The algorithms are associated with the age based pricing rule type.

Related Topics

For more information on...	See...
How to define an age based pricing rule type	Defining an Age Based Pricing Rule Type on page 3017
How to edit an age based pricing rule type	Editing an Age Based Pricing Rule Type on page 3031

Adding a Price Item in an Age Based Pricing Rule Type

Prerequisites

To add a price item in an age based pricing rule type, you should have:

- Price item defined in the application
- Rate option defined in the **Rate Option (C1-ExtLookRefTypeRateOpt)** extendable lookup
- Values defined for the **Invoice Type (C1INVTYP)** characteristic type

- The **C1INVTYP** characteristic type set in the **Invoice Type Characteristic Type** option type of the **C1-ASOBLNG** feature configuration
- Rule types defined in the application (where the rule type usage is set to **Price Item Eligibility**)

Procedure

To add a price item in an age based pricing rule type:

1. Ensure that the **Price Items** section is expanded when you are defining or editing an age based pricing rule type.

The **Price Items** section contains the following fields in a grid:

Field Name	Field Description	Mandatory (Yes or No)						
Price Item	<p>Used to indicate the price item that you want to include in the age based pricing rule type.</p> <p>Note:</p> <p>The Search (🔍) icon appears corresponding to the Price Item field. On clicking the Search icon, the Price Item Search window appears.</p> <p>On specifying the price item, the description of the price item appears corresponding to the Price Item field.</p>	<p>Yes (Conditional)</p> <p>Note: This field is required when you are adding a rate option and bill to account in an age based pricing rule type.</p>						
Rate Option	<p>Used to indicate one or more rate options which are valid for a price item.</p> <p>On clicking the Add (+) icon, the following field appears in a grid:</p> <table border="1"> <thead> <tr> <th>Field Name</th> <th>Field Description</th> <th>Mandatory (Yes or No)</th> </tr> </thead> <tbody> <tr> <td>Rate Option</td> <td>Used to indicate the rate option that you want to use while defining pricing for the price item.</td> <td>Yes</td> </tr> </tbody> </table> <p>Note:</p> <p>If you want to define more than one rate option to the price item in an age based pricing rule type, click the Add (+) icon.</p> <p>However, if you want to remove a price item from an age based pricing rule type, click the Delete (🗑️) icon corresponding to the Rate Option field.</p>	Field Name	Field Description	Mandatory (Yes or No)	Rate Option	Used to indicate the rate option that you want to use while defining pricing for the price item.	Yes	Not applicable
Field Name	Field Description	Mandatory (Yes or No)						
Rate Option	Used to indicate the rate option that you want to use while defining pricing for the price item.	Yes						

Field Name	Field Description	Mandatory (Yes or No)									
Bill To Account	<p>Used to indicate a order in which the account should be considered while deriving a transaction leg.</p> <p>On clicking the Add (+) icon, the following fields appear in a grid:</p> <table border="1"> <thead> <tr> <th>Field Name</th> <th>Field Description</th> <th>Mandatory (Yes or No)</th> </tr> </thead> <tbody> <tr> <td>Priority</td> <td>Used to specify the order in which the invoice type is considered for a price item.</td> <td>Yes</td> </tr> <tr> <td>Invoice Type</td> <td>Used to indicate the type which is considered for billing. For more information, refer to the Bill Group's Account on page 65 section.</td> <td>Yes</td> </tr> </tbody> </table> <p>Note: The Search (🔍) icon appears corresponding to the Invoice Type field. On clicking the Search icon, the Invoice Type Search window appears.</p> <p>Note: If you want to define more than one invoice type to the price item in an age based pricing rule type, click the Add (+) icon. However, if you want to remove a invoice type from the price item in an age based pricing rule type, click the Delete (🗑️) icon corresponding to the Priority field.</p>	Field Name	Field Description	Mandatory (Yes or No)	Priority	Used to specify the order in which the invoice type is considered for a price item.	Yes	Invoice Type	Used to indicate the type which is considered for billing. For more information, refer to the Bill Group's Account on page 65 section.	Yes	Not applicable
Field Name	Field Description	Mandatory (Yes or No)									
Priority	Used to specify the order in which the invoice type is considered for a price item.	Yes									
Invoice Type	Used to indicate the type which is considered for billing. For more information, refer to the Bill Group's Account on page 65 section.	Yes									
Eligibility Rule Type	Used to indicate the rule type (which indicates the rules) that should be executed to determine whether the price item is eligible for billing.	No									

- Enter the required details in the **Price Items** section.
- If you want to define more than one price item in an age based pricing rule type, click the **Add** (+) icon and then repeat step 2.

Note: However, if you want to remove a price item from an age based pricing rule type, click the **Delete** (🗑️) icon corresponding to the **Price Item** field.

- Click **Save**.

The price items are added for an age based pricing rule type.

Related Topics

For more information on...	See...
How to define an age based pricing rule type	Defining an Age Based Pricing Rule Type on page 3017

For more information on...	See...
How to edit an age based pricing rule type	Editing an Age Based Pricing Rule Type on page 3031

Adding a Price Item Parameter in an Age Based Pricing Rule Type

Prerequisites

To add a price item parameter in an age based pricing rule type, you should have:

- Parameter defined in the application where parameter usage is set to **Price Item**.
- Parameter associated with the price item.

Procedure

To add a price item parameter in an age based pricing rule type:

1. Ensure that the **Price Item Parameters** section is expanded when you are defining or editing an age based pricing rule type.

The **Price Item Parameters** section contains the following fields in a grid:

Field Name	Field Description	Mandatory (Yes or No)
Price Item Parameter	Used to specify the parameter which you can use while defining an age based pricing for the price item.	Yes (Conditional)
	<p>Note:</p> <p>The Search (🔍) icon appears corresponding to the Price Item Parameter field. On clicking the Search (🔍) icon corresponding to the Price Item Parameter field, the Parameter Search window appears.</p> <p>On specifying the parameter, the description of the price item parameter appears corresponding to the Price Item Parameter field.</p>	<p>Note: This field is required when you are adding a price item parameter in an age based pricing rule type.</p>

2. Enter the required details in the **Price Item Parameters** section.
3. If you want to add more than one price item parameter in an age based pricing rule type, click the **Add** (+) icon and then repeat step 2.

Note: However, if you want to remove a price item parameter from an age based pricing rule type, click the **Delete** (🗑️) icon corresponding to the price item parameter.

4. Click **Save**.

The price item parameter is added for an age based pricing rule type.

Related Topics

For more information on...	See...
How to define an age based pricing rule type	Defining an Age Based Pricing Rule Type on page 3017
How to edit an age based pricing rule type	Editing an Age Based Pricing Rule Type on page 3031

Defining a Characteristic for an Age Based Pricing Rule Type

Prerequisites

To define a characteristic for an age based pricing rule type, you should have:

- Characteristic types defined in the application (where the characteristic entity is set to **Pricing Rule Type**)

Procedure

To define a characteristic for an age based pricing rule type:

1. Ensure that the **Characteristics** section is expanded when you are defining or editing an age based pricing rule type.

The **Characteristics** section contains the following columns in a grid:

Field Name	Field Description	Mandatory (Yes or No)
Characteristic Type	Used to indicate the characteristic type.	Yes (Conditional)
	Note: The list includes only those characteristic types where the characteristic entity is set to Pricing Rule Type .	Note: This field is required when you are defining a characteristic for an age based pricing rule type.
Characteristic Value	Used to specify the value for the characteristic type.	Yes (Conditional)
	Note: If you select a predefined characteristic type, the Search (🔍) icon appears corresponding to the Characteristic Value field. On clicking the Search icon, the Predefined Characteristic Search window appears. On specifying the value for a predefined characteristic type, the description of the characteristic value appears corresponding to the Characteristic Value field.	Note: This field is required when you are defining a characteristic for an age based pricing rule type.

2. Enter the required details in the **Characteristics** section.
3. If you want to define more than one characteristic for an age based pricing rule type, click the **Add** (+) icon and then repeat step 2.

Note: However, if you want to remove a characteristic from an age based pricing rule type, click the **Delete** (🗑️) icon corresponding to the characteristic.

4. Click **Save**.

The characteristics are defined for an age based pricing rule type.

Related Topics

For more information on...	See...
How to define a fully-insured age based pricing rule type	Defining an Age Based Pricing Rule Type on page 3017
How to edit a fully-insured age based pricing rule type	Editing an Age Based Pricing Rule Type on page 3031

Adding Elements for Audit in an Age Based Pricing Rule Type

Prerequisites

To add elements for audit in an age based pricing rule type, you should have:

- Business Object **C1-AuditEventType** defined for the pricing rule type.
- Audit Event Type defined in the application.

Procedure

To add elements for audit in an age based pricing rule type:

1. Ensure that the **Event Management** section is expanded when you are defining or editing an age based pricing rule type.

The **Event Management** section contains the following fields in a grid:

Field Name	Field Description	Mandatory (Yes or No)
Audit Event Type	Used to specify the audit event type which you can use while adding elements for audit in an age based pricing rule type. Note: The Search (🔍) icon appears corresponding to the Audit Event Type field. On clicking the Search (🔍) icon corresponding to the Audit Event Type field, the Audit Event Type Search window appears. On specifying the audit event type, the description of the audit event type appears corresponding to the Audit Event Type field.	Yes
Element Type	Used to indicate the type of audit element for an age based pricing rule type. The valid values are: <ul style="list-style-type: none"> • Business Object Status • Characteristic • Field 	Not applicable
Element Name	Used to specify the element name for an age based pricing rule type. Note: The Search (🔍) icon appears corresponding to the Element Name field. On clicking the Search (🔍) icon corresponding to the Element Name field, the Audit Event Type Element Name Search window appears.	Yes
Element Value	Used to specify the value for an element name.	Not applicable

2. Enter the required details in the **Price Item Parameters** section.
3. If you want to add more than one element for audit in an age based pricing rule type, click the **Add** (+) icon and then repeat step 2.

Note: However, if you want to remove an element for audit from an age based pricing rule type, click the **Delete** (🗑️) icon corresponding to the price item parameter.

4. Click **Save**.

The elements for audit are added for an age based pricing rule type.

Related Topics

For more information on...	See...
How to define an age based pricing rule type	Defining an Age Based Pricing Rule Type on page 3017
How to edit an age based pricing rule type	Editing an Age Based Pricing Rule Type on page 3031

Defining an Age Based Specific Additional Data in an Age Based Pricing Rule Type

Procedure

To define an age based specific additional data in an age based pricing rule type:

1. Ensure that the **Age Based Specific Additional Data** section is expanded when you are defining or editing an age based pricing rule type.

The **Age Based Specific Additional Data** section contains the following fields:

Field Name	Field Description	Mandatory (Yes or No)
Relation	Used to indicate the relation of the member in an age based pricing rule type. The valid values are: <ul style="list-style-type: none"> • Children • Main Subscriber • Spouse 	No
Relationship Type	Used to indicate the type of relationship for an age based pricing rule type.	No

2. Enter the required details in the **Age Based Specific Additional Data** section.
3. If you want to add more than one age based specific data in an age based pricing rule type, click the **Add** (+) icon and then repeat step 2.

Note: However, if you want to remove an age based specific data from an age based pricing rule type, click the **Delete** (🗑️) icon corresponding to the **Relation** field.

4. Click **Save**.

The age based specific additional data is defined for the age based pricing rule type.

Related Topics

For more information on...	See...
How to define an age based pricing rule type	Defining an Age Based Pricing Rule Type on page 3017

For more information on...	See...
How to edit an age based pricing rule type	Editing an Age Based Pricing Rule Type on page 3031

Mapping Characteristic Attributes in an Age Based Pricing Rule Type

Prerequisites

To map the characteristic attributes in an age based pricing rule type:

- Characteristic type defined in the application

Procedure

To map the characteristic attributes in an age based pricing rule type:

1. Ensure that the **Attribute Characteristic Mapping** section is expanded when you are defining an age based pricing rule type.

The **Attribute Characteristic Mapping** section contains the following fields:

Field Name	Field Description	Mandatory (Yes or No)
Maximum Number of Dependents	Used to indicate the maximum number of children which are eligible for premium calculation.	No
Maximum Age Limit for Maximum Dependent Count	Used to indicate the maximum age limit for children which are eligible for premium calculation.	No
Maximum Number of Dependents Order Priority	Used to indicate whether you want to consider the youngest or eldest children during premium calculation. The valid values are: <ul style="list-style-type: none"> • YOUNGEST • ELDEST 	No
Age Calculation Based On	Used to indicate whether the member person's age should be calculated using the member person's enrollment date or policy's renewal date.	No
Age Recalculation Based On	Used to indicate whether the member person's age should be re-calculated when you add a membership to a policy plan or a member person to a membership.	No
Newborn Gift Days	Used to indicate the number of days you want to offer as gift days from the new born child's enrollment date. As a result, no premium will be calculated for this period.	No
Newborn Gift Days Applicability	Used to indicate whether you want to offer gift days in case of a new born. The valid values are: <ul style="list-style-type: none"> • Y • N 	No
Young Adult Maximum Age Limit	Used to indicate the maximum age limit for young adults who are eligible for premium calculation.	No
Young Adult Inclusion Applicability	Used to indicate whether you want to consider the young adults during the premium calculation.	No

Note:

The **Search** (🔍) icon appears corresponding to each field. On clicking the **Search** icon, the **Characteristic Type Search** window appears.

On specifying the characteristic type, the description of the characteristic type appears corresponding to the respective field.

2. Enter the required details in the **Attributes Characteristic Mapping** section.
3. Click **Save**.

The characteristic types are mapped to the appropriate fields in the age based pricing rule type.

Related Topics

For more information on...	See...
How to define an age based pricing rule type	Defining an Age Based Pricing Rule Type on page 3017
How to edit an age based pricing rule type	Editing an Age Based Pricing Rule Type on page 3031

Editing an Age Based Pricing Rule Type**Prerequisites**

To edit an age based pricing rule type, you should have:

- Age based pricing rule type business object defined in the application.
- Age based pricing rule business object defined in the application.

Procedure

To edit an age based pricing rule type:

1. Click the **Admin** link in the **Application** toolbar.
A list appears.
2. From the **Admin** menu, select **P** and then click **Pricing Rule Type**.
A sub-menu appears.
3. Click the **Search** option from the **Pricing Rule Type** sub-menu.
The **Pricing Rule Type** screen appears.
4. In the **Pricing Rule Type List** zone, click the **Edit** (✎) icon in the **Edit** column corresponding to the age based pricing rule type whose details you want to edit.

The **Age Based Pricing Rule Type** screen appears. It contains the following sections:

- **Main** – Used to specify basic details about an age based pricing rule type.
- **Related Pricing Rule Type** – Used to specify the pricing rule types which are related to the age based pricing rule type.

Note: The **Related Pricing Rule Type** section appears when the **Primary** check-box is selected.

- **Algorithms** – Used to associate the algorithms with an age based pricing rule type.
- **Price Items** – Used to add the price items for which you can define the age based pricing rules using the age based pricing rule type.

- **Price Item Parameters** – Used to add the price item parameters based on which you want to define the price item pricing.
- **Characteristics** – Used to define the characteristics for an age based pricing rule type.
- **Event Management** – Used to configure the audit in an age based pricing rule type.
- **Age Based-Specific Additional Data** – Used to define an age based specific additional data in an age based pricing rule type.
- **Attributes Characteristic Mapping** – Used to map a characteristic attribute in an age based pricing rule type.

The **Main** section contains the following fields:

Field Name	Field Description	Mandatory (Yes or No)
Pricing Rule Type	Displays the age based pricing rule type.	Not applicable
Description	Used to specify the description for an age based pricing rule type.	Yes
Detailed Description	Used to specify additional information about an age based pricing rule type.	No
Pricing Rule Business Object	Used to indicate the business object using which you want to create an age based pricing rule type. The valid value is: <ul style="list-style-type: none"> • Age Based Pricing Rule 	Yes
Business Object	Indicates the business object using which you are defining an age based pricing rule type.	Not applicable
Status	Used to indicate the status of an age based pricing rule type. The valid values are: <ul style="list-style-type: none"> • Active • Inactive 	Yes
Primary	Used to select the checkbox if the pricing rule type is primary. Note: The checkbox appears selected, if you have already selected the Primary option while defining an age based pricing rule type.	No
Skip Non-Members	Used to select the checkbox when you want the system to only consider the eligible members and not non-members of the active employee coverage membership during the age based premium calculation. Note: The checkbox appears selected, if you have already selected the Non-Covered Subscriber Eligible option while defining an age based pricing rule type.	No

Field Name	Field Description	Mandatory (Yes or No)
Pricing Rule Type Category	Indicates the pricing rule type category for an age based pricing rule type. The valid values is: <ul style="list-style-type: none"> Age Based 	No
	Note: It is a read-only field.	

Tip: Alternatively, you can edit the details of an age based pricing rule type by clicking the **Edit** button in the **Pricing Rule Type** zone.

- Modify the details in the **Main** section.
- Add, edit, or remove the related pricing rule types in the age based pricing rule type, if required.

Note: The **Related Pricing Rule Type** section appears when the **Primary** check-box is selected.

- Associate the required algorithms in an age based pricing rule type.
- Add, edit, or remove the required price items in an age based pricing rule type.
- Add, edit, or remove the price item parameters in an age based pricing rule type, if required.
- Add, edit, or remove characteristics for an age based pricing rule type, if required.
- Add, edit, or remove the configuration details of the audit in an age based pricing rule type.
- Add, edit, or remove the age based specific additional data in an age based pricing rule type.
- Add, edit, or remove a characteristic attribute in an age based pricing rule type
- Click **Save**.

The changes made to the age based pricing rule type are saved.

Related Topics

For more information on...	See...
How to add the related pricing rule types in an age based pricing rule type	Adding the Related Pricing Rule Types in an Age Based Pricing Rule Type on page 3019
How to associate algorithms with an age based pricing rule type	Associating an Algorithm with an Age Based Pricing Rule Type on page 3021
How to add price items in an age based pricing rule type	Adding a Price Item in an Age Based Pricing Rule Type on page 3023
How to add price item parameters in an age based pricing rule type	Adding a Price Item Parameter in an Age Based Pricing Rule Type on page 3026
How to define a characteristic for an age based pricing rule type	Defining a Characteristic for an Age Based Pricing Rule Type on page 3027
How to add elements for audit in an age based pricing rule type	Adding Elements for Audit in an Age Based Pricing Rule Type on page 3028
How to define age based specific additional data in an age based pricing rule type	Defining an Age Based Specific Additional Data in an Age Based Pricing Rule Type on page 3029

For more information on...	See...
How to map characteristic attributes in an age based pricing rule type	Mapping Characteristic Attributes in an Age Based Pricing Rule Type on page 3030

Deleting an Age Based Pricing Rule Type

Procedure

To delete an age based pricing rule type:

1. Click the **Admin** link in the **Application** toolbar.
A list appears.
2. From the **Admin** menu, select **P** and then click **Pricing Rule Type**.
A sub-menu appears.
3. Click the **Search** option from the **Pricing Rule Type** sub-menu.
The **Pricing Rule Type** screen appears.
4. In the **Pricing Rule Type List** zone, click the **Delete** (🗑️) icon in the **Delete** column corresponding to the age based pricing rule type that you want to delete.
A message appears confirming whether you want to delete the age based pricing rule type.

Note: You can delete an age based pricing rule type when it is not yet used in the system.

Tip: Alternatively, you can delete an age based pricing rule type by clicking the **Delete** button in the **Pricing Rule Type** zone.

5. Click **OK**.
The age based pricing rule type is deleted.

Related Topics

For more information on...	See...
Pricing Rule Type screen	Pricing Rule Type on page 2532
Pricing Rule Type List zone	Pricing Rule Type List on page 2533
Pricing Rule Type zone	Pricing Rule Type on page 2536

Viewing the Age Based Pricing Rule Type Details

Procedure

To view the details of an age based pricing rule type:

1. Click the **Admin** link in the **Application** toolbar.
A list appears.
2. From the **Admin** menu, select **P** and then click **Pricing Rule Type**.
A sub-menu appears.
3. Click the **Search** option from the **Pricing Rule Type** sub-menu.
The **Pricing Rule Type** screen appears.

4. In the **Pricing Rule Type List** zone, click the **Broadcast** () icon corresponding to the age based pricing rule type whose details you want to view.
The **Pricing Rule Type** zone appears.
5. View the details of the age based pricing rule type in the **Pricing Rule Type** zone.

Related Topics

For more information on...	See...
Pricing Rule Type screen	Pricing Rule Type on page 2532
Pricing Rule Type List zone	Pricing Rule Type List on page 2533
Pricing Rule Type zone	Pricing Rule Type on page 2536

Tier Based Pricing

The standard tier based pricing structure contains different tiers, such as Employee Only (E), Employee + Spouse (ES), Family (F), Employee + Children (EC). A main subscriber can subscribe his/her dependents to a policy plan and may fall in one of the tier. The fee for a price item can vary based on the membership tier level and employee attributes (such as employee type, employee status, etc.). Oracle Revenue Management and Billing enables you to offer a tier based pricing to a fully-insured group customer. In the Tier Based pricing, the premium for the membership is derived based on tier level and employee attributes.

A tier based pricing can be defined using the tier based pricing rule. You can define a tier based pricing rule for a price item on the policy plan. If the tier based pricing rule is defined for a price item on a policy plan, all memberships which belong to the policy plan will inherit the tier based pricing from the policy plan. If the system does not find any effective pricing rule for a price item on the policy plan, it inherits the effective pricing rule for the price item from the parent customer level.

You can define a tier based pricing rule using a tier based pricing rule type. It is the tier based pricing rule type which helps the system to determine:

- Business object using which the tier based pricing rule should be created in the system.
- Algorithm which should be triggered for deriving the account and price item for a membership.

Note: You must create an algorithm using the **C1_ACCPRIMEM** algorithm type and attach it to the **Account and Price Item Derivation** system event.

- Algorithm which should be triggered for deriving the bill period for a membership.

Note: You must create an algorithm using the **C1-BILLPDRV** algorithm type and attach it to the **Account and Price Item Derivation Post-Processing** system event.

- Algorithm which should be triggered for creating the bill period timeline (based on the derived bill period) for a membership.

Note: You must create an algorithm using the **C1-BILLRPCR** algorithm type and attach it to the **Account and Price Item Derivation Post-Processing** system event.

- Algorithm which should be triggered for deriving the subscription tier for membership, based on the bill period configured on the account..

Note: You must create an algorithm using the **C1-DERSUBTR** algorithm type and attach it to the **Account and Price Item Derivation Post-Processing** system event.

- Algorithm which should be triggered for deriving the bill group, parent customer, and policy for a membership.

Note: You must create an algorithm using the **C1_MEMBGDRV** algorithm type and attach it to the **Bill Group Derivation** system event.

- Algorithm which should be triggered for calculating the premium for membership.

Note: You must create an algorithm using the **C1_TIERPREM** algorithm type and attach it to the **Pricing Rule Premium Calculation** system event.

- Algorithm which should be triggered for creating the SQI based billable charges for each membership and price item combination.

Note: You must create an algorithm using the **C1-FICRETBC** algorithm type and attach it to the **Pricing Rule Billable Charge Creation** system event.

- Algorithm which should be triggered for calculating the proration factor and amount for fully insured tier based pricing rule based on the policy plan configurations.

Note: You must create an algorithm using the **C1-TIERPRFC** algorithm type and attach it to the **Pricing Rule Proration Amount Calculation** system event.

- Algorithm which should be triggered for distributing the total premium in the non-skip months of the coverage period.

Note: You must create an algorithm using the **C1-SKPMNTHPC** algorithm type and attach it to the **Skip Month Premium Calculation (in case you want to use the 9/10 Billing feature)** system event.

- Price items for which you can define tier based pricing rules using the tier based pricing rule type.
- Rate options that you can use while defining the pricing for the respective price item.
- Type of account to which the respective price item should be billed based on the specified priority.
- Rule type which indicates the rules that should be executed to determine whether the price item is eligible for billing.
- Audit event types of the C1-Membership business object using which the audit event should be created whenever a membership is added, updated, or removed from the policy plan.
- Elements of the C1-Membership business object for which audit event should be created.

Note: You must ensure that either the **Update All** option is selected or the elements listed in the tier based pricing rule type are already present in the respective audit event type. Otherwise, erroneous results might occur.

Once a tier based pricing rule type is defined, you can define tier based pricing rules using the tier based pricing rule type. Note that, at present, you can define tier based pricing rules only through a health care inbound message and not from the user interface. However, you can view the tier based pricing rules defined for a policy plan from the **Customer 360° Information** screen. While creating a tier based pricing rule through a health care inbound message, you need to specify the following information:

- Entity type (i.e. Policy Plan) and entity ID (i.e. policy plan ID) for which you want to define the tier based pricing rule
- Start and end dates of the tier based pricing rule
- Tier based pricing rule type using which you want to create the tier based pricing rule
- Price Item for which you want to define tier based pricing
- Rate option using which the price assignment should be created for the tier based pricing rule

Note: If the rate option is not given in the pricing rule data, by default, it is set to a value specified in the **Default Rate Option – Flat** option type of the **C1-ASOBLNG** feature configuration when the modifier method is set to **FLAT** or **NULL**.

- Tier level and employee attributes for which the fee is applicable

Note: The tier level and employee attributes can be defined as the parameters in the system. These parameters can then be used to define eligibility criteria in the tier based pricing. Here, you can use only those parameters where the parameter usage is set to **Pricing Eligibility**.

Once the tier based pricing rule is defined for a policy plan, the system creates a price item pricing and price list and then assigns the price item pricing to the price list.

Related Topics

For more information on...	See...
How to define a tier based pricing rule type	Defining a Tier Based Pricing Rule Type on page 3037
How to add the related pricing rule types in a tier based pricing rule type	Adding the Related Pricing Rule Types in a Tier Based Pricing Rule Type on page 3040
How to associating an algorithm with a tier based pricing rule type	Associating an Algorithm with a Tier Based Pricing Rule Type on page 3041
How to add a price item in a tier based pricing rule type	Adding a Price Item in a Tier Based Pricing Rule Type on page 3043
How to add a price item parameter in tier based pricing rule type	Adding a Price Item Parameter in a Tier Based Pricing Rule Type on page 3046
How to define the characteristics for a tier based pricing rule type	Defining a Characteristic for a Tier Based Pricing Rule Type on page 3047
How to add elements for an audit in a tier based pricing rule type	Adding Elements for Audit in a Tier Based Pricing Rule Type on page 3048
How to edit a tier based pricing rule type	Editing a Tier Based Pricing Rule Type on page 3049
How to delete a age based pricing rule type	Deleting a Tier Based Pricing Rule Type on page 3051
How to view the age based pricing rule type details	Viewing the Tier Based Pricing Rule Type Details on page 3052

Defining a Tier Based Pricing Rule Type

Prerequisites

To define a tier based pricing rule type, you should have:

- Tier based pricing rule type business object defined in the application.
- Tier based pricing rule business object defined in the application.
- Pricing rule type category for the tier based defined in the application.

Procedure

To define a tier based pricing rule type:

1. Click the **Admin** link in the **Application** toolbar.
A list appears.
2. From the **Admin** menu, select **P** and then click **Pricing Rule Type**.

A sub-menu appears.

- Click the **Add** option from the **Pricing Rule Type** sub-menu.

The **Select Business Object** screen appears. It contains the following field:

Field Name	Field Description	Mandatory (Yes or No)
Pricing Rule Type Business Object	Used to indicate the business object using which you want to create a tier based pricing rule type.	Yes
	Note: You can create a tier based pricing rule type using the Tier Based Pricing Rule Type (C1-PricingRuleTierBased) business object.	

Tip: Alternatively, you can access this screen by clicking the **Add** button in the **Page Title** area of the **Pricing Rule Type** screen.

- Select the **Tier Based Pricing Rule Type** option from the **Pricing Rule Type Business Object** list.
- Click **OK**.

The **Tier Based Pricing Rule Type** screen appears. It contains the following sections:

- Main** – Used to specify basic details about a tier based pricing rule type.
- Related Pricing Rule Type** – Used to define the pricing rule types which are related to the tier based pricing rule type.

Note: The **Related Pricing Rule Type** section appears when the **Primary** check-box is selected.

- Algorithms** – Used to associate the algorithms with a tier based pricing rule type.
- Price Items** – Used to add the price items for which you can define the tier pricing rules using the tier based pricing rule type.
- Price Item Parameters** – Used to add the price item parameters based on which you want to define the price item pricing.
- Characteristics** – Used to define the characteristics for a tier based pricing rule type.
- Event Management** – Used to configure the audit in a tier based pricing rule type.

The **Main** section contains the following fields:

Field Name	Field Description	Mandatory (Yes or No)
Pricing Rule Type	Used to specify the tier based pricing rule type.	Yes
Description	Used to specify the description for the tier based pricing rule type.	Yes
Detailed Description	Used to specify additional information about the tier based pricing rule type.	No
Pricing Rule Business Object	Used to indicate the business object using which you want to create the tier based pricing rule type. The valid value is: <ul style="list-style-type: none"> Tier Based Pricing Rule 	Yes
Business Object	Indicates the business object using which you are defining the tier based pricing rule type.	Not applicable

Field Name	Field Description	Mandatory (Yes or No)
Status	Used to indicate the status of a tier based pricing rule type. The valid values are: <ul style="list-style-type: none"> Active Inactive 	Yes
Primary	Used to select the checkbox if the pricing rule type is primary.	No
Skip Non-Members	Used to select the checkbox when you want the system to only consider the eligible members and not non-members of the active employee coverage membership during tier based premium calculation.	No
Pricing Rule Type Category	Used to indicate the category to which the pricing rule type belongs. The valid value is: <ul style="list-style-type: none"> Tier Based 	Yes

- Enter the required details in the **Main** section.
- Add the related pricing rule types in the tier based pricing rule type, if required.

Note: The **Related Pricing Rule Type** section appears when the **Primary** check-box is selected.

- Associate the required algorithms with the tier based pricing rule type:
- Add the required price items in the tier based pricing rule type.
- Add the price item parameters in the tier based pricing rule type, if required.
- Define characteristics for the tier based pricing rule type, if required.
- Configure the audit in the tier based pricing rule type.
- Click **Save**.

The tier based pricing rule type is defined.

Related Topics

For more information on...	See...
How to add the related pricing rule types in a tier based pricing rule type	Adding the Related Pricing Rule Types in a Tier Based Pricing Rule Type on page 3040
How to associate algorithms with the tier based pricing rule type	Associating an Algorithm with a Tier Based Pricing Rule Type on page 3041
How to add price items in the tier based pricing rule type	Adding a Price Item in a Tier Based Pricing Rule Type on page 3043
How to add price item parameters in the tier based pricing rule type	Adding a Price Item Parameter in a Tier Based Pricing Rule Type on page 3046
How to define a characteristic for the tier based pricing rule type	Defining a Characteristic for a Tier Based Pricing Rule Type on page 3047
How to add elements for audit in the tier based pricing rule type	Adding Elements for Audit in a Tier Based Pricing Rule Type on page 3048

Adding the Related Pricing Rule Types in a Tier Based Pricing Rule Type

Prerequisites

To add related pricing rule types in a tier based pricing rule type, you should have:

- Additional charge pricing rule type defined in the application.
- Eligibility rule type defined in the application.

Procedure

To add related pricing rule types in a tier based pricing rule type:

1. Ensure that the **Related Pricing Rule Types** section is expanded when you are defining or editing a tier based pricing rule type.

Note: This section appears when the **Primary** option is selected in the **Main** section.

The **Related Pricing Rule Types** section contains the following columns in a grid:

Column Name	Column Description	Mandatory (Yes or No)
Sequence	Used to specify the order in which the related pricing rule type should be invoked.	Yes (Conditional)
		Note: This field is required when you are defining a pricing rule type for the related pricing rule type.
Pricing Rule Type	Used to specify the pricing rule type which should be executed to determine whether the related pricing rule type is eligible for deriving the transaction legs.	Yes (Conditional)
	Note: On clicking the Search (🔍) icon that appears corresponding to the Pricing Rule Type field, the Pricing Rule Type Search window appears. On specifying the related pricing rule type, the description of the pricing rule type appears corresponding to the Pricing Rule Type field.	Note: This field is required when the corresponding Sequence and Eligibility Rule Type field is specified for the related pricing rule type.
Eligibility Rule Type	Used to indicate the rule type eligibility for the related pricing rule type.	No
	Note: The Eligibility Rule Type list includes only those rule-types where the rule type eligibility is Related Pricing Rule Type Eligibility .	

2. Enter the required details in the **Related Pricing Rule Types** section.
3. If you want to define more than one related pricing rule type for the tier based pricing rule type, click the **Add** (+) icon and then repeat step 2.

Note: However, if you want to remove a related pricing rule type from the tier based pricing rule type, click the **Delete** (🗑️) icon corresponding to the related pricing rule type.

4. Click **Save**.

The related pricing rule types are added for the tier based pricing rule type.

Related Topics

For more information on...	See...
How to define a age based pricing rule type	Defining an Age Based Pricing Rule Type on page 3017
How to define a tier based pricing rule type	Defining a Tier Based Pricing Rule Type on page 3037
How to edit a age based pricing rule type	Editing an Age Based Pricing Rule Type on page 3031
How to edit a tier based pricing rule type	Editing a Tier Based Pricing Rule Type on page 3049

Associating an Algorithm with a Tier Based Pricing Rule Type

Prerequisites

To associate an algorithm with a tier based pricing rule type, you should have:

- An algorithm defined using the **C1_ACCPRIMEM** algorithm type.
- An algorithm defined using the **C1-BILLPDRV** algorithm type.
- An algorithm defined using the **C1-BILLRPCR** algorithm type.
- An algorithm defined using the **C1-DERSUBTR** algorithm type.
- An algorithm defined using the **C1_MEMBGDRV** algorithm type.
- An algorithm defined using the **C1_TIERPREM** algorithm type.
- An algorithm defined using the **C1-FICRETBC** algorithm type.
- An algorithm defined using the **C1-TIERPRFC** algorithm type.
- An algorithm defined using the **C1-SKPMNTHPC** algorithm type.

Procedure

To associate an algorithm with a tier based pricing rule type:

1. Ensure that the **Algorithms** section is expanded when you are defining or editing the tier based pricing rule type.

The **Algorithms** section contains the following columns in a grid:

Column Name	Column Description	Mandatory (Yes or No)
System Event	<p>Used to indicate the system event when you want to invoke the algorithm. The valid values are:</p> <ul style="list-style-type: none"> • Account and Price Item Derivation - Used to derive the account and price item for a membership. • Account and Price Item Derivation Post-Processing - Used to derive the bill period for the account. • Account and Price Item Derivation Post-Processing - Used to create the bill period timeline for the account. • Account and Price Item Derivation Post-Processing - Used to derive subscription tier for membership, based on the bill period configured on the account. • Bill Group Derivation - Used to derive the bill group, parent customer, and policy for a membership. • Premium Calculation - Used to calculate the premium for each eligible member person. • Billable Charge Creation Post Processing - Used to create new billable charges for both pre-calculated and post-calculated charges. • Pricing Rule Proration Amount Calculation - Used to calculate proration factor and amount for tier based pricing rule based on the policy plan configurations. • Skip Month Premium Calculation - Used to distribute the total premium in the non-skip months of the coverage period. 	<p>Yes</p> <p>Note: This field is required when you are associating an algorithm with the tier based pricing rule type.</p>
Sequence	Used to specify the order in which the algorithms for each system event must be executed.	<p>Yes (Conditional)</p> <p>Note: This field is required when you are associating an algorithm with the tier based pricing rule type.</p>
Algorithm	<p>Used to specify the algorithm.</p> <p>Note:</p> <p>Once you select the system event, the Search (🔍) icon appears corresponding to the Algorithm field. On clicking the Search (🔍) icon, the Algorithm Search window appears.</p> <p>On specifying the algorithm, the description of the algorithm appears corresponding to the Algorithm field.</p>	<p>Yes (Conditional)</p> <p>Note: This field is required when you are associating an algorithm with the tier based pricing rule type.</p>

2. Enter the following details in the **Algorithms** section:

System Event	Algorithm	Algorithm Type	Description
Account and Price Item Derivation	C1_ACCPRIMEM	C1_ACCPRIMEM	Account and PriceItem Derivation for Membership
Account and Price Item Derivation Post-Processing	C1-BILLPDRV	C1-BILLPDRV	Bill Period Derivation
Account and Price Item Derivation Post-Processing	C1-BILLRPCR	C1-BILLRPCR	Bill Period Time Line Creation
Account and Price Item Derivation Post-Processing	C1-DERSUBTR	C1-DERSUBTR	Derive Subscription Tier for Membership
Bill Group Derivation	C1_MEMBGDRV	C1_MEMBGDRV	Bill Group Derivation for Membership
Premium Calculation	C1_TIERPREM	C1_TIERPREM	Tier Based Premium Calculation
Billable Charge Creation Post Processing	C1-FICRETBC	C1-FICRETBC	Fully Insured Charge Creation for Memberships
Pricing Rule Proration Amount Calculation	C1-TIERPRFC	C1-TIERPRFC	Calculate Proration Factor for Tier Based Pricing Rule
Skip Month Premium Calculation	C1-SKPMNTHPC	C1-SKPMNTHPC	Skip Month Premium Calculation

3. If you want to associate more than one algorithm with the tier based pricing rule type, click the **Add (+)** icon and then repeat step 2.

Note: However, if you want to disassociate an algorithm from the tier based pricing rule type, click the **Delete (🗑)** icon corresponding to the algorithm.

4. Click **Save**.

The algorithms are associated with the tier based pricing rule type.

Related Topics

For more information on...	See...
How to define a tier based pricing rule type	Defining a Tier Based Pricing Rule Type on page 3037
How to edit a tier based pricing rule type	Editing a Tier Based Pricing Rule Type on page 3049

Adding a Price Item in a Tier Based Pricing Rule Type

Prerequisites

To add a price item in a tier based pricing rule type, you should have:

- Price item defined in the application
- Rate option defined in the **Rate Option (C1-ExtLookRetTypeRateOpt)** extendable lookup
- Values defined for the **Invoice Type (C1INVTYP)** characteristic type
- The **C1INVTYP** characteristic type set in the **Invoice Type Characteristic Type** option type of the **C1-ASOBLLNG** feature configuration
- Rule types defined in the application (where the rule type usage is set to **Price Item Eligibility**)

Procedure

To add a price item in a tier based pricing rule type:

1. Ensure that the **Price Items** section is expanded when you are defining or editing a tier based pricing rule type.

The **Price Items** section contains the following fields in a grid:

Field Name	Field Description	Mandatory (Yes or No)				
Price Item	Used to indicate the price item that you want to include in a tier based pricing rule type.	Yes (Conditional)				
	<p>Note:</p> <p>The Search (🔍) icon appears corresponding to the Price Item field. On clicking the Search icon, the Price Item Search window appears. On specifying the price item, the description of the price item appears corresponding to the Price Item field.</p>	<p>Note: This field is required when you are adding a rate option and bill to account in a tier based pricing rule type.</p>				
Rate Option	Used to indicate one or more rate options which are valid for a price item.	Not applicable				
	On clicking the Add (➕) icon, the following field appears in a grid:					
	<table border="1"> <thead> <tr> <th>Field Name</th> <th>Field Description</th> <th>Mandatory (Yes or No)</th> </tr> </thead> <tbody> <tr> <td>Rate Option</td> <td>Used to indicate the rate option that you want to use while defining pricing for the price item.</td> <td>Yes</td> </tr> </tbody> </table>		Field Name	Field Description	Mandatory (Yes or No)	Rate Option
Field Name	Field Description	Mandatory (Yes or No)				
Rate Option	Used to indicate the rate option that you want to use while defining pricing for the price item.	Yes				
<p>Note:</p> <p>If you want to define more than one rate option to the price item in a fully-insured tier based pricing rule type, click the Add (➕) icon.</p> <p>However, if you want to remove a price item from a fully-insured tier based pricing rule type, click the Delete (🗑️) icon corresponding to the Rate Option field.</p>						

Field Name	Field Description	Mandatory (Yes or No)									
Bill To Account	<p>Used to indicate a order in which the account should be considered while deriving a transaction leg.</p> <p>On clicking the Add (+) icon, the following fields appear in a grid:</p> <table border="1"> <thead> <tr> <th>Field Name</th> <th>Field Description</th> <th>Mandatory (Yes or No)</th> </tr> </thead> <tbody> <tr> <td>Priority</td> <td>Used to specify the order in which the invoice type is considered for a price item.</td> <td>Yes</td> </tr> <tr> <td>Invoice Type</td> <td>Used to indicate the type which is considered for billing. For more information, refer to the Bill Group's Account on page 65 section.</td> <td>Yes</td> </tr> </tbody> </table> <p>Note: The Search (🔍) icon appears corresponding to the Invoice Type field. On clicking the Search icon, the Invoice Type Search window appears.</p> <p>Note: If you want to define more than one invoice type to the price item in a tier based pricing rule type, click the Add (+) icon. However, if you want to remove a invoice type from the price item in a tier based pricing rule type, click the Delete (🗑️) icon corresponding to the Priority field.</p>	Field Name	Field Description	Mandatory (Yes or No)	Priority	Used to specify the order in which the invoice type is considered for a price item.	Yes	Invoice Type	Used to indicate the type which is considered for billing. For more information, refer to the Bill Group's Account on page 65 section.	Yes	Not applicable
Field Name	Field Description	Mandatory (Yes or No)									
Priority	Used to specify the order in which the invoice type is considered for a price item.	Yes									
Invoice Type	Used to indicate the type which is considered for billing. For more information, refer to the Bill Group's Account on page 65 section.	Yes									
Eligibility Rule Type	Used to indicate the rule type (which indicates the rules) that should be executed to determine whether the price item is eligible for billing.	No									

- Enter the required details in the **Price Items** section.
- If you want to define more than one price item in a tier based pricing rule type, click the **Add** (+) icon and then repeat step 2.

Note: However, if you want to remove a price item from a tier based pricing rule type, click the **Delete** (🗑️) icon corresponding to the **Price Item** field.

- Click **Save**.

The price items are added for a tier based pricing rule type.

Related Topics

For more information on...	See...
How to define a tier based pricing rule type	Defining a Tier Based Pricing Rule Type on page 3037

For more information on...	See...
How to edit a tier based pricing rule type	Editing a Tier Based Pricing Rule Type on page 3049

Adding a Price Item Parameter in a Tier Based Pricing Rule Type

Prerequisites

To add a price item parameter in a tier based pricing rule type, you should have:

- Parameter defined in the application where parameter usage is set to **Price Item**.
- Parameter associated with the price item.

Procedure

To add a price item parameter in a tier based pricing rule type:

1. Ensure that the **Price Item Parameters** section is expanded when you are defining or editing a tier based pricing rule type.

The **Price Item Parameters** section contains the following fields in a grid:

Field Name	Field Description	Mandatory (Yes or No)
Price Item Parameter	Used to specify the parameter which you can use while defining a tier based pricing for the price item.	Yes (Conditional)
	<p>Note:</p> <p>The Search (🔍) icon appears corresponding to the Price Item Parameter field. On clicking the Search (🔍) icon corresponding to the Price Item Parameter field, the Parameter Search window appears.</p> <p>On specifying the parameter, the description of the price item parameter appears corresponding to the Price Item Parameter field.</p>	<p>Note: This field is required when you are adding a price item parameter in a tier based pricing rule type.</p>

2. Enter the required details in the **Price Item Parameters** section.
3. If you want to add more than one price item parameter in a tier based pricing rule type, click the **Add** (+) icon and then repeat step 2.

Note: However, if you want to remove a price item parameter from a tier based pricing rule type, click the **Delete** (🗑️) icon corresponding to the price item parameter.

4. Click **Save**.

The price item parameter is added for a tier based pricing rule type.

Related Topics

For more information on...	See...
How to define a tier based pricing rule type	Defining a Tier Based Pricing Rule Type on page 3037
How to edit a tier based pricing rule type	Editing a Tier Based Pricing Rule Type on page 3049

Defining a Characteristic for a Tier Based Pricing Rule Type

Prerequisites

To define a characteristic for a tier based pricing rule type, you should have:

- Characteristic types defined in the application (where the characteristic entity is set to **Pricing Rule Type**)

Procedure

To define a characteristic for a tier based pricing rule type:

1. Ensure that the **Characteristics** section is expanded when you are defining or editing a tier based pricing rule type.

The **Characteristics** section contains the following columns in a grid:

Field Name	Field Description	Mandatory (Yes or No)
Characteristic Type	Used to indicate the characteristic type.	Yes (Conditional)
	Note: The list includes only those characteristic types where the characteristic entity is set to Pricing Rule Type .	Note: This field is required when you are defining a characteristic for a tier based pricing rule type.
Characteristic Value	Used to specify the value for the characteristic type.	Yes (Conditional)
	Note: On specifying the value for a predefined characteristic type, the description of the characteristic value appears corresponding to the Characteristic Value field.	Note: This field is required when you are defining a characteristic for a tier based pricing rule type.

2. Enter the required details in the **Characteristics** section.

Note: If you select a predefined characteristic type, the **Search** (🔍) icon appears corresponding to the **Characteristic Value** field. On clicking the **Search** icon, you can search for a predefined characteristic value.

3. If you want to define more than one characteristic for a tier based pricing rule type, click the **Add** (+) icon and then repeat step 2.

Note: However, if you want to remove a characteristic from a tier based pricing rule type, click the **Delete** (🗑️) icon corresponding to the characteristic.

4. Click **Save**.

The characteristics are defined for a tier based pricing rule type.

Related Topics

For more information on...	See...
How to define a tier based pricing rule type	Defining a Tier Based Pricing Rule Type on page 3037
How to edit a tier based pricing rule type	Editing a Tier Based Pricing Rule Type on page 3049

Adding Elements for Audit in a Tier Based Pricing Rule Type

Prerequisites

To add elements for audit in a tier based pricing rule type, you should have:

- Business Object **C1-AuditEventType** defined for the pricing rule type.
- Audit Event Type defined in the application.

Procedure

To add elements for audit in a tier based pricing rule type:

1. Ensure that the **Event Management** section is expanded when you are defining or editing a tier based pricing rule type.

The **Event Management** section contains the following fields in a grid:

Field Name	Field Description	Mandatory (Yes or No)
Audit Event Type	Used to specify the audit event type which you can use while adding elements for audit in tier based pricing rule type. Note: The Search (🔍) icon appears corresponding to the Audit Event Type field. On clicking the Search (🔍) icon corresponding to the Audit Event Type field, the Audit Event Type Search window appears. On specifying the audit event type, the description of the audit event type appears corresponding to the Audit Event Type field.	Yes
Element Type	Used to indicate the type of audit element for a tier based pricing rule type. The valid values are: <ul style="list-style-type: none"> • Business Object Status • Characteristic • Field 	Not applicable
Element Name	Used to specify the element name for a tier based pricing rule type. Note: The Search (🔍) icon appears corresponding to the Element Name field. On clicking the Search (🔍) icon corresponding to the Element Name field, the Audit Event Type Element Name Search window appears.	Yes
Element Value	Used to specify the value for an element name.	Not applicable

2. Enter the required details in the **Price Item Parameters** section.
3. If you want to add more than one element for audit in a tier based pricing rule type, click the **Add** (+) icon and then repeat step 2.

Note: However, if you want to remove an element for audit from a tier based pricing rule type, click the **Delete** (🗑️) icon corresponding to the price item parameter.

4. Click **Save**.

The elements for audit are added for a tier based pricing rule type.

Related Topics

For more information on...	See...
How to define a tier based pricing rule type	Defining a Tier Based Pricing Rule Type on page 3037
How to edit a tier based pricing rule type	Editing a Tier Based Pricing Rule Type on page 3049

Editing a Tier Based Pricing Rule Type

Prerequisites

To edit a tier based pricing rule type, you should have:

- Tier Based pricing rule type business object defined in the application.
- Tier Based pricing rule business object defined in the application.

Procedure

To edit a tier based pricing rule type:

1. Click the **Admin** link in the **Application** toolbar.
A list appears.
2. From the **Admin** menu, select **P** and then click **Pricing Rule Type**.
A sub-menu appears.
3. Click the **Search** option from the **Pricing Rule Type** sub-menu.
The **Pricing Rule Type** screen appears.
4. In the **Pricing Rule Type List** zone, click the **Edit** (✎) icon in the **Edit** column corresponding to the pricing rule type whose details you want to edit.

The **Tier Based Pricing Rule Type** screen appears. It contains the following sections:

- **Main** – Used to specify basic details about a tier based pricing rule type.
- **Related Pricing Rule Type** – Used to specify the pricing rule types which are related to the tier based pricing rule type.

Note: The **Related Pricing Rule Type** section appears when the **Primary** check-box is selected.

- **Algorithms** – Used to associate the algorithms with a tier based pricing rule type.
- **Price Items** – Used to add the price items for which you can define the tier based pricing rules using the tier based pricing rule type.
- **Price Item Parameters** – Used to add the price item parameters based on which you want to define the price item pricing.
- **Characteristics** – Used to define the characteristics for a tier based pricing rule type.
- **Event Management** – Used to configure the audit in a tier based pricing rule type.

The **Main** section contains the following fields:

Field Name	Field Description	Mandatory (Yes or No)
Pricing Rule Type	Displays the tier based pricing rule type.	Not applicable
Description	Used to specify the description for a tier based pricing rule type.	Yes
Detailed Description	Used to specify additional information about a tier based pricing rule type.	No
Pricing Rule Business Object	Used to indicate the business object using which you want to create a tier based pricing rule type. The valid value is: <ul style="list-style-type: none"> Tier Based Pricing Rule 	Yes
Business Object	Indicates the business object using which you are defining a tier based pricing rule type.	Not applicable
Status	Used to indicate the status of a tier based pricing rule type. The valid values are: <ul style="list-style-type: none"> Active Inactive 	Yes
Primary	Used to select the checkbox if the pricing rule type is primary. <p>Note: The checkbox appears selected, if you have already selected the Primary option while defining a tier based pricing rule type.</p>	No
Skip Non-Members	Used to select the checkbox when you want the system to only consider the eligible members and not non-members of the active employee coverage membership during tier based premium calculation. <p>Note: The checkbox appears selected, if you have already selected the Non-Covered Subscriber Eligible option while defining a tier based pricing rule type.</p>	No
Pricing Rule Type Category	Indicates the pricing rule type category for a tier based pricing rule type. The valid values is: <ul style="list-style-type: none"> Tier Based 	No

Tip: Alternatively, you can edit the details of a tier based pricing rule type by clicking the **Edit** button in the **Pricing Rule Type** zone.

- Modify the details in the **Main** section.
- Add, edit, or remove the related pricing rule types in the tier based pricing rule type, if required.

Note: The **Related Pricing Rule Type** section appears when the **Primary** check-box is selected.

- Associate the required algorithms in a tier based pricing rule type.
- Add, edit, or remove the required price items in a tier based pricing rule type.

9. Add, edit, or remove the price item parameters in a tier based pricing rule type, if required.
10. Add, edit, or remove characteristics for a tier based pricing rule type, if required.
11. Add, edit, or remove the configuration details of the audit in a tier based pricing rule type.
12. Click **Save**.

The changes made to the tier based pricing rule type are saved.

Related Topics

For more information on...	See...
How to add the related pricing rule types in a tier based pricing rule type	Adding the Related Pricing Rule Types in a Tier Based Pricing Rule Type on page 3040
How to associate algorithms with a tier based pricing rule type	Associating an Algorithm with a Tier Based Pricing Rule Type on page 3041
How to add price items in a tier based pricing rule type	Adding a Price Item in a Tier Based Pricing Rule Type on page 3043
How to add price item parameters in a tier based pricing rule type	Adding a Price Item Parameter in a Tier Based Pricing Rule Type on page 3046
How to define a characteristic for a tier based pricing rule type	Defining a Characteristic for a Tier Based Pricing Rule Type on page 3047
How to add elements for audit in a tier based pricing rule type	Adding Elements for Audit in a Tier Based Pricing Rule Type on page 3048

Deleting a Tier Based Pricing Rule Type

Procedure

To delete a tier based pricing rule type:

1. Click the **Admin** link in the **Application** toolbar.
A list appears.
2. From the **Admin** menu, select **P** and then click **Pricing Rule Type**.
A sub-menu appears.
3. Click the **Search** option from the **Pricing Rule Type** sub-menu.
The **Pricing Rule Type** screen appears.
4. In the **Pricing Rule Type List** zone, click the **Delete** (🗑️) icon in the **Delete** column corresponding to the tier based pricing rule type that you want to delete.
A message appears confirming whether you want to delete the tier based pricing rule type.

Note: You can delete a tier based pricing rule type when it is not yet used in the system.

Tip: Alternatively, you can delete a tier based pricing rule type by clicking the **Delete** button in the **Pricing Rule Type** zone.

5. Click **OK**.

The tier based pricing rule type is deleted.

Related Topics

For more information on...	See...
Pricing Rule Type screen	Pricing Rule Type on page 2532
Pricing Rule Type List zone	Pricing Rule Type List on page 2533
Pricing Rule Type zone	Pricing Rule Type on page 2536

Viewing the Tier Based Pricing Rule Type Details

Procedure

To view the details of a tier based pricing rule type:

1. Click the **Admin** link in the **Application** toolbar.
A list appears.
2. From the **Admin** menu, select **P** and then click **Pricing Rule Type**.
A sub-menu appears.
3. Click the **Search** option from the **Pricing Rule Type** sub-menu.
The **Pricing Rule Type** screen appears.
4. In the **Pricing Rule Type List** zone, click the **Broadcast** () icon corresponding to the tier based pricing rule type whose details you want to view.
The **Pricing Rule Type** zone appears.
5. View the details of the tier based pricing rule type in the **Pricing Rule Type** zone.

Related Topics

For more information on...	See...
Pricing Rule Type screen	Pricing Rule Type on page 2532
Pricing Rule Type List zone	Pricing Rule Type List on page 2533
Pricing Rule Type zone	Pricing Rule Type on page 2536

Pass-Through Billable Charge

At times, the system might receive pre-calculated premium for the membership through a health care inbound message. If the price item, account identifier type, and account identifier are given in the billable charge information of a health care inbound message, the system directly creates an SQI based billable charge when you process the health care inbound message. The pre-calculated premium amount is stored as a pass through line in the SQI based billable charge. But, if only the price item is given in the billable charge information, the system checks whether the price item is included in any pricing rule type where the pricing rule type category is set to **Pass-Through Billable Charge**. If so, the system checks whether the pass-through billable charge pricing rule type is associated with the policy plan to which the membership belongs (for which the billable charge information is received). It is the pass-through billable charge pricing rule type which helps the system to determine:

- Algorithm which should be triggered for deriving the bill group, parent customer, and policy for a membership.

Note: You must create an algorithm using the **C1_MEMBDRV** algorithm type and attach it to the **Bill Group Derivation** system event.

- Algorithm which should be triggered for deriving the account and price item for a membership.

Note: You must create an algorithm using the **C1_ACCPRIMEM** algorithm type and attach it to the **Account and Price Item Derivation** system event.

- Algorithm which should be triggered for deriving the bill period for the account.

Note:

You must create an algorithm using the **C1-FIBCBP** algorithm type and attach it to the **Pricing Rule BC Creation Pre Processing** system event.

If the bill period or frequency is given in the billable charge information of the health care inbound message, the system does not derive the bill period for the account.

- Algorithm which should be triggered for creating the SQI based billable charges for each membership and price item combination.

Note: You must create an algorithm using the **C1-FICRETBC** algorithm type and attach it to the **Pricing Rule Billable Charge Creation** system event.

- Price items for which you can create the SQI based billable charges using the pass-through billable charge pricing rule type.

Note: You can add multiple price items in a pass-through billable charge pricing rule type. But, you cannot add the same price item in multiple pass-through billable charge pricing rule types.

- Type of account to which the respective price item should be billed based on the specified priority.

Related Topics

For more information on...	See...
How to define a pass-through billable charge pricing rule type	Defining a Pass-Through Billable Charge Pricing Rule Type on page 3053
How to associating an algorithm with a pass-through billable charge pricing rule type	Associating an Algorithm with a Pass-Through Billable Charge Pricing Rule Type on page 3055
How to add a price item in a pass-through billable charge pricing rule type	Adding a Price Item in a Pass-Through Billable Charge Pricing Rule Type on page 3057
How to add a price item parameter in pass-through billable charge pricing rule type	Adding a Price Item Parameter in a Pass-Through Billable Charge Pricing Rule Type on page 3060
How to define the characteristics for a pass-through billable charge pricing rule type	Defining a Characteristic for a Pass-Through Billable Charge Pricing Rule Type on page 3060
How to edit a pass-through billable charge pricing rule type	Editing a Pass-Through Billable Charge Pricing Rule Type on page 3061
How to delete a pass-through billable charge pricing rule type	Deleting a Pass-Through Billable Charge Pricing Rule Type on page 3063
How to view the pass-through billable charge pricing rule type details	Viewing the Pass-Through Billable Charge Pricing Rule Type Details on page 3064

Defining a Pass-Through Billable Charge Pricing Rule Type

Prerequisites

To define a pass-through billable charge pricing rule type, you should have:

- Pass-through billable charge pricing rule type business object defined in the application.

- Pass-through billable charge pricing rule business object defined in the application.

Procedure

To define a pass-through billable charge pricing rule type:

1. Click the **Admin** link in the **Application** toolbar.
A list appears.
2. From the **Admin** menu, select **P** and then click **Pricing Rule Type**.
A sub-menu appears.
3. Click the **Add** option from the **Pricing Rule Type** sub-menu.

The **Select Business Object** screen appears. It contains the following field:

Field Name	Field Description	Mandatory (Yes or No)
Pricing Rule Type Business Object	Used to indicate the business object using which you want to create a pass-through billable charge pricing rule type. Note: You can create a pass-through billable charge pricing rule type using the Pass-Through Billable Charge Pricing Rule Type (C1-FIPassthroughBcRuleType) business object.	Yes

Tip: Alternatively, you can access this screen by clicking the **Add** button in the **Page Title** area of the **Pricing Rule Type** screen.

4. Select the **Pass-Through Billable Charge Pricing Rule Type** option from the **Pricing Rule Type Business Object** list.
5. Click **OK**.

The **Pass-Through Billable Charge Pricing Rule Type** screen appears. It contains the following sections:

- **Main** – Used to specify basic details about the pass-through billable charge pricing rule type.
- **Algorithms** – Used to associate the algorithms with the pass-through billable charge pricing rule type.
- **Price Items** – Used to add the price items for which you can define the pass-through billable charge pricing rules using the age based pricing rule type.
- **Price Item Parameters** – Used to add the price item parameters based on which you want to define the price item pricing.
- **Characteristics** – Used to define the characteristics for the pass-through billable charge pricing rule type.

The **Main** section contains the following fields:

Field Name	Field Description	Mandatory (Yes or No)
Pricing Rule Type	Used to specify the pass-through billable charge pricing rule type.	Yes
Description	Used to specify the description for the pass-through billable charge pricing rule type.	Yes
Detailed Description	Used to specify additional information about the pass-through billable charge pricing rule type.	No

Field Name	Field Description	Mandatory (Yes or No)
Pricing Rule Business Object	Used to indicate the business object using which you want to create the pass-through billable charge pricing rule type. The valid value is: <ul style="list-style-type: none"> Pass-Through Billable Charge Pricing Rule 	Yes
Business Object	Indicates the business object using which you are defining the pass-through billable charge pricing rule type.	Not applicable
Status	Used to indicate the status of the pass-through billable charge pricing rule type. The valid values are: <ul style="list-style-type: none"> Active Inactive 	Yes
Pricing Rule Type Category	Used to indicate the category to which the pricing rule type belongs. The valid value is: <ul style="list-style-type: none"> Pass-Through Billable Charge 	Yes

- Enter the required details in the **Main** section.
- Associate the required algorithms with the pass-through billable charge pricing rule type.
- Add the required price items in the pass-through billable charge pricing rule type.
- Add the price item parameters in the pass-through billable charge pricing rule type, if required.
- Define characteristics for the pass-through billable charge pricing rule type, if required.
- Click **Save**.

The pass-through billable charge pricing rule type is defined.

Related Topics

For more information on...	See...
How to associate algorithms with the pass-through billable charge pricing rule type	Associating an Algorithm with a Pass-Through Billable Charge Pricing Rule Type on page 3055
How to add price items in the pass-through billable charge pricing rule type	Adding a Price Item in a Pass-Through Billable Charge Pricing Rule Type on page 3057
How to add price item parameters in the pass-through billable charge pricing rule type	Adding a Price Item Parameter in a Pass-Through Billable Charge Pricing Rule Type on page 3060
How to define a characteristic for the pass-through billable charge pricing rule type	Defining a Pass-Through Billable Charge Pricing Rule Type on page 3053

Associating an Algorithm with a Pass-Through Billable Charge Pricing Rule Type

Prerequisites

To associate an algorithm with a pass-through billable charge pricing rule type, you should have:

- An algorithm defined using the **C1_MEMBGDRV** algorithm type.
- An algorithm defined using the **C1_ACCPRIMEM** algorithm type.
- An algorithm defined using the **C1-FIBCBP** algorithm type.

- An algorithm defined using the **C1-FICRETBC** algorithm type.

Procedure

To associate an algorithm with a pass-through billable charge pricing rule type:

1. Ensure that the **Algorithms** section is expanded when you are defining or editing the pass-through billable charge pricing rule type.

The **Algorithms** section contains the following columns in a grid:

Column Name	Column Description	Mandatory (Yes or No)
System Event	Used to indicate the system event when you want to invoke the algorithm. The valid values are: <ul style="list-style-type: none"> • Bill Group Derivation - Used to derive the bill group, parent customer, and policy for a membership. • Account and Price Item Derivation - Used to derive the account and price item for a membership. • Pricing Rule BC Creation Pre Processing - Used to derive the bill period for the account. • Pricing Rule Billable Charge Creation - Used to derive the price items for which you can create the SQI based billable charges using the pass-through billable charge pricing rule type. 	Yes Note: This field is required when you are associating an algorithm with a pass-through billable charge pricing rule type.
Sequence	Used to specify the order in which the algorithms for each system event must be executed.	Yes (Conditional) Note: This field is required when you are associating an algorithm with a pass-through billable charge pricing rule type.
Algorithm	Used to specify the algorithm. Note: Once you select the system event, the Search (🔍) icon appears corresponding to the Algorithm field. On clicking the Search (🔍) icon, the Algorithm Search window appears. On specifying the algorithm, the description of the algorithm appears corresponding to the Algorithm field.	Yes (Conditional) Note: This field is required when you are associating an algorithm with a pass-through billable charge pricing rule type.

2. Enter the following details in the **Algorithms** section:

System Event	Algorithm	Algorithm Type	Description
Bill Group Derivation	C1_MEMBGDRV	C1_MEMBGDRV	Bill Group Derivation for Membership
Account and Price Item Derivation	C1_ACCPRIMEM	C1_ACCPRIMEM	Account and PriceItem Derivation for Membership

System Event	Algorithm	Algorithm Type	Description
Pricing Rule BC Creation Pre Processing	C1-FIBCBP	C1-FIBCBP	Fetch Bill Period of Billable Charge of Membership
Pricing Rule Billable Charge Creation	C1-FICRETBC	C1-FICRETBC	Fully-Insured Charge creation for Memberships

- If you want to associate more than one algorithm with a pass-through billable charge pricing rule type, click the **Add (+)** icon and then repeat step 2.

Note: However, if you want to disassociate an algorithm from a pass-through billable charge pricing rule type, click the **Delete (🗑)** icon corresponding to the algorithm.

- Click **Save**.

The algorithms are associated with a pass-through billable charge pricing rule type.

Related Topics

For more information on...	See...
How to define pass-through billable charge pricing rule type	Defining a Pass-Through Billable Charge Pricing Rule Type on page 3053
How to edit pass-through billable charge pricing rule type	Editing a Pass-Through Billable Charge Pricing Rule Type on page 3061

Adding a Price Item in a Pass-Through Billable Charge Pricing Rule Type

Prerequisites

To add a price item in a pass-through billable charge pricing rule type, you should have:

- Price item defined in the application
- Rate option defined in the **Rate Option (C1-ExtLookRefTypeRateOpt)** extendable lookup
- Values defined for the **Invoice Type (C1INVTYP)** characteristic type
- The **C1INVTYP** characteristic type set in the **Invoice Type Characteristic Type** option type of the **C1-ASOBLNG** feature configuration
- Rule types defined in the application (where the rule type usage is set to **Price Item Eligibility**)

Procedure

To add a price item in a pass-through billable charge pricing rule type:

- Ensure that the **Price Items** section is expanded when you are defining or editing a pass-through billable charge pricing rule type.

The **Price Items** section contains the following fields in a grid:

Field Name	Field Description	Mandatory (Yes or No)				
Price Item	Used to indicate the price item that you want to include in a pass-through billable charge pricing rule type.	Yes (Conditional)				
	<p>Note:</p> <p>The Search (🔍) icon appears corresponding to the Price Item field. On clicking the Search icon, the Price Item Search window appears.</p> <p>On specifying the price item, the description of the price item appears corresponding to the Price Item field.</p>	<p>Note: This field is required when you are adding a rate option and bill to account in a pass-through billable charge pricing rule type.</p>				
Rate Option	<p>Used to indicate one or more rate options which are valid for a price item.</p> <p>On clicking the Add (+) icon, the following field appears in a grid:</p>	Not applicable				
	<table border="1" data-bbox="428 800 1276 968"> <thead> <tr> <th data-bbox="428 800 573 884">Field Name</th> <th data-bbox="573 800 1105 884">Field Description</th> <th data-bbox="1105 800 1276 884">Mandatory (Yes or No)</th> </tr> </thead> <tbody> <tr> <td data-bbox="428 884 573 968">Rate Option</td> <td data-bbox="573 884 1105 968">Used to indicate the rate option that you want to use while defining pricing for the price item.</td> <td data-bbox="1105 884 1276 968">Yes</td> </tr> </tbody> </table> <p>Note:</p> <p>If you want to define more than one rate option to the price item in a pass-through billable charge pricing rule type, click the Add (+) icon.</p> <p>However, if you want to remove a price item from a pass-through billable charge pricing rule type, click the Delete (🗑️) icon corresponding to the Rate Option field.</p>		Field Name	Field Description	Mandatory (Yes or No)	Rate Option
Field Name	Field Description	Mandatory (Yes or No)				
Rate Option	Used to indicate the rate option that you want to use while defining pricing for the price item.	Yes				

Field Name	Field Description	Mandatory (Yes or No)									
Bill To Account	<p>Used to indicate a order in which the account should be considered while deriving a transaction leg.</p> <p>On clicking the Add (⊕) icon, the following fields appear in a grid:</p> <table border="1"> <thead> <tr> <th>Field Name</th> <th>Field Description</th> <th>Mandatory (Yes or No)</th> </tr> </thead> <tbody> <tr> <td>Priority</td> <td>Used to specify the order in which the invoice type is considered for a price item.</td> <td>Yes</td> </tr> <tr> <td>Invoice Type</td> <td>Used to indicate the type which is considered for billing. For more information, refer to the Bill Group's Account on page 65 section.</td> <td>Yes</td> </tr> </tbody> </table> <p>Note: The Search (🔍) icon appears corresponding to the Invoice Type field. On clicking the Search icon, the Invoice Type Search window appears.</p>	Field Name	Field Description	Mandatory (Yes or No)	Priority	Used to specify the order in which the invoice type is considered for a price item.	Yes	Invoice Type	Used to indicate the type which is considered for billing. For more information, refer to the Bill Group's Account on page 65 section.	Yes	Not applicable
Field Name	Field Description	Mandatory (Yes or No)									
Priority	Used to specify the order in which the invoice type is considered for a price item.	Yes									
Invoice Type	Used to indicate the type which is considered for billing. For more information, refer to the Bill Group's Account on page 65 section.	Yes									
	<p>Note:</p> <p>If you want to define more than one invoice type to the price item in a pass-through billable charge pricing rule type, click the Add (⊕) icon.</p> <p>However, if you want to remove a invoice type from the price item in a pass-through billable charge pricing rule type, click the Delete (🗑) icon corresponding to the Priority field.</p>										
Eligibility Rule Type	Used to indicate the rule type (which indicates the rules) that should be executed to determine whether the price item is eligible for billing.	No									

- Enter the required details in the **Price Items** section.
- If you want to define more than one price item in a pass-through billable charge pricing rule type, click the **Add** (⊕) icon and then repeat step 2.

Note: However, if you want to remove a price item from a pass-through billable charge pricing rule type, click the **Delete** (🗑) icon corresponding to the **Price Item** field.

- Click **Save**.

The price items are added for a pass-through billable charge pricing rule type.

Related Topics

For more information on...	See...
How to define a pass-through billable charge pricing rule type	Defining a Pass-Through Billable Charge Pricing Rule Type on page 3053
How to edit a pass-through billable charge pricing rule type	Editing a Pass-Through Billable Charge Pricing Rule Type on page 3061

Adding a Price Item Parameter in a Pass-Through Billable Charge Pricing Rule Type

Prerequisites

To add a price item parameter in a pass-through billable charge pricing rule type, you should have:

- Parameter defined in the application where parameter usage is set to **Price Item**.
- Parameter associated with the price item.

Procedure

To add a price item parameter in a pass-through billable charge pricing rule type:

1. Ensure that the **Price Item Parameters** section is expanded when you are defining or editing a pass-through billable charge pricing rule type.

The **Price Item Parameters** section contains the following fields in a grid:

Field Name	Field Description	Mandatory (Yes or No)
Price Item Parameter	Used to specify the parameter which you can use while defining a pass-through billable charge pricing for the price item.	Yes (Conditional)
	<p>Note:</p> <p>The Search (🔍) icon appears corresponding to the Price Item Parameter field. On clicking the Search (🔍) icon corresponding to the Price Item Parameter field, the Parameter Search window appears.</p> <p>On specifying the parameter, the description of the price item parameter appears corresponding to the Price Item Parameter field.</p>	<p>Note: This field is required when you are adding a price item parameter in a pass-through billable charge pricing rule type.</p>

2. Enter the required details in the **Price Item Parameters** section.
3. If you want to add more than one price item parameter in a pass-through billable charge pricing rule type, click the **Add** (+) icon and then repeat step 2.

Note: However, if you want to remove a price item parameter from a pass-through billable charge pricing rule type, click the **Delete** (🗑️) icon corresponding to the price item parameter.

4. Click **Save**.

The price item parameter is added for a pass-through billable charge pricing rule type.

Related Topics

For more information on...	See...
How to define a pass-through billable charge pricing rule type	Defining a Pass-Through Billable Charge Pricing Rule Type on page 3053
How to edit a pass-through billable charge pricing rule type	Editing a Pass-Through Billable Charge Pricing Rule Type on page 3061

Defining a Characteristic for a Pass-Through Billable Charge Pricing Rule Type

Prerequisites

To define a characteristic for a pass-through billable charge pricing rule type, you should have:

- Characteristic types defined in the application (where the characteristic entity is set to **Pricing Rule Type**)

Procedure

To define a characteristic for a pass-through billable charge pricing rule type:

1. Ensure that the **Characteristics** section is expanded when you are defining or editing a pass-through billable charge pricing rule type.

The **Characteristics** section contains the following columns in a grid:

Field Name	Field Description	Mandatory (Yes or No)
Characteristic Type	Used to indicate the characteristic type.	Yes (Conditional)
	Note: The list includes only those characteristic types where the characteristic entity is set to Pricing Rule Type .	Note: This field is required when you are defining a characteristic for a pass-through billable charge pricing rule type.
Characteristic Value	Used to specify the value for the characteristic type.	Yes (Conditional)
	Note: If you select a predefined characteristic type, the Search (🔍) icon appears corresponding to the Characteristic Value field. On clicking the Search icon, the Predefined Characteristic Search window appears. On specifying the value for a predefined characteristic type, the description of the characteristic value appears corresponding to the Characteristic Value field.	Note: This field is required when you are defining a characteristic for a pass-through billable charge pricing rule type.

2. Enter the required details in the **Characteristics** section.
3. If you want to define more than one characteristic for a pass-through billable charge pricing rule type, click the **Add** (+) icon and then repeat step 2.

Note: However, if you want to remove a characteristic from a pass-through billable charge pricing rule type, click the **Delete** (🗑️) icon corresponding to the characteristic.

4. Click **Save**.

The characteristics are defined for a pass-through billable charge pricing rule type.

Related Topics

For more information on...	See...
How to define a pass-through billable charge pricing rule type	Defining a Pass-Through Billable Charge Pricing Rule Type on page 3053
How to edit a pass-through billable charge pricing rule type	Editing a Pass-Through Billable Charge Pricing Rule Type on page 3061

Editing a Pass-Through Billable Charge Pricing Rule Type

Prerequisites

To edit a pass-through billable charge pricing rule type, you should have:

- Pass-Through Billable Charge pricing rule type business object defined in the application.
- Pass-Through Billable Charge pricing rule business object defined in the application.

Procedure

To edit a pass-through Billable Charge pricing rule type:

1. Click the **Admin** link in the **Application** toolbar.

A list appears.

2. From the **Admin** menu, select **P** and then click **Pricing Rule Type**.

A sub-menu appears.

3. Click the **Search** option from the **Pricing Rule Type** sub-menu.

The **Pricing Rule Type** screen appears.

4. In the **Pricing Rule Type List** zone, click the **Edit** (✎) icon in the **Edit** column corresponding to the pricing rule type whose details you want to edit.

The **Pass-Through Billable Charge Age Based Pricing Rule Type** screen appears. It contains the following sections:

- **Main** – Used to specify basic details about a pass-through billable charge pricing rule type.
- **Algorithms** – Used to associate the algorithms with a pass-through billable charge pricing rule type.
- **Price Items** – Used to add the price items for which you can define the pass-through billable charge pricing rules using the pass-through billable charge pricing rule type.
- **Price Item Parameters** – Used to add the price item parameters based on which you want to define the price item pricing.
- **Characteristics** – Used to define the characteristics for a pass-through billable charge pricing rule type.

The **Main** section contains the following fields:

Field Name	Field Description	Mandatory (Yes or No)
Pricing Rule Type	Displays the pass-through billable charge pricing rule type.	Not applicable
Description	Used to specify the description for a pass-through billable charge pricing rule type.	Yes
Detailed Description	Used to specify additional information about a pass-through billable charge pricing rule type.	No
Pricing Rule Business Object	Used to indicate the business object using which you want to create a pass-through billable charge pricing rule type. The valid value is: <ul style="list-style-type: none"> • Pass-Through Billable Charge 	Yes
Business Object	Indicates the business object using which you are defining a pass-through billable charge pricing rule type.	Not applicable
Status	Used to indicate the status of a pass-through billable charge pricing rule type. The valid values are: <ul style="list-style-type: none"> • Active • Inactive 	Yes

Field Name	Field Description	Mandatory (Yes or No)
Pricing Rule Type Category	Indicates the pricing rule type category for a pass-through billable charge pricing rule type. The valid value is: <ul style="list-style-type: none"> Pass-Through Billable Charge 	No
	Note: It is a read-only field, and cannot be edited.	

Tip: Alternatively, you can edit the details of a pass-through billable charge pricing rule type by clicking the **Edit** button in the **Pricing Rule Type** zone.

- Modify the details in the **Main** section.
- Associate the following algorithms with the pass-through billable charge pricing rule type:

System Event	Algorithm	Algorithm Type	Description
Bill Group Derivation	C1_MEMBGDRV	C1_MEMBGDRV	Bill Group Derivation for Membership
Account and Price Item Derivation	C1_ACCPRIMEM	C1_ACCPRIMEM	Account and PriceItem Derivation for Membership
Pricing Rule BC Creation Pre Processing	C1-FIBCBP	C1-FIBCBP	Fetch Bill Period of Billable Charge of Membership
Pricing Rule Billable Charge Creation	C1-FICRETBC	C1-FICRETBC	Fully-Insured Charge creation for Memberships

- Add, edit, or remove the required price items in a pass-through billable charge pricing rule type.
- Add, edit, or remove the price item parameters in a pass-through billable charge pricing rule type, if required.
- Add, edit, or remove characteristics for a pass-through billable charge pricing rule type, if required.
- Click **Save**.

The changes made to the a pass-through billable charge pricing rule type are saved.

Related Topics

For more information on...	See...
How to associate algorithms with a pass-through billable charge pricing rule type	Associating an Algorithm with a Pass-Through Billable Charge Pricing Rule Type on page 3055
How to add price items in a pass-through billable charge pricing rule type	Adding a Price Item in a Pass-Through Billable Charge Pricing Rule Type on page 3057
How to add price item parameters in a pass-through billable charge pricing rule type	Adding a Price Item Parameter in a Pass-Through Billable Charge Pricing Rule Type on page 3060
How to define a characteristic for a pass-through billable charge pricing rule type	Defining a Characteristic for a Pass-Through Billable Charge Pricing Rule Type on page 3060

Deleting a Pass-Through Billable Charge Pricing Rule Type

Procedure

To delete a pass-through billable charge pricing rule type:

1. Click the **Admin** link in the **Application** toolbar.
A list appears.
2. From the **Admin** menu, select **P** and then click **Pricing Rule Type**.
A sub-menu appears.
3. Click the **Search** option from the **Pricing Rule Type** sub-menu.
The **Pricing Rule Type** screen appears.
4. In the **Pricing Rule Type List** zone, click the **Delete** (🗑️) icon in the **Delete** column corresponding to the pass-through billable charge pricing rule type that you want to delete.
A message appears confirming whether you want to delete the pass-through billable charge pricing rule type.

Note: You can delete a pass-through billable charge pricing rule type when it is not yet used in the system.

Tip: Alternatively, you can delete a pass-through billable charge pricing rule type by clicking the **Delete** button in the **Pricing Rule Type** zone.

5. Click **OK**.
The pass-through billable charge pricing rule type is deleted.

Related Topics

For more information on...	See...
Pricing Rule Type screen	Pricing Rule Type on page 2532
Pricing Rule Type List zone	Pricing Rule Type List on page 2533
Pricing Rule Type zone	Pricing Rule Type on page 2536

Viewing the Pass-Through Billable Charge Pricing Rule Type Details

Procedure

To view the details of a pass-through billable charge pricing rule type:

1. Click the **Admin** link in the **Application** toolbar.
A list appears.
2. From the **Admin** menu, select **P** and then click **Pricing Rule Type**.
A sub-menu appears.
3. Click the **Search** option from the **Pricing Rule Type** sub-menu.
The **Pricing Rule Type** screen appears.
4. In the **Pricing Rule Type List** zone, click the **Broadcast** (📡) icon corresponding to the pass-through billable charge pricing rule type whose details you want to view.
The **Pricing Rule Type** zone appears.
5. View the details of the pass-through billable charge pricing rule type in the **Pricing Rule Type** zone.

Related Topics

For more information on...	See...
Pricing Rule Type screen	Pricing Rule Type on page 2532

For more information on...	See...
Pricing Rule Type List zone	Pricing Rule Type List on page 2533
Pricing Rule Type zone	Pricing Rule Type on page 2536

Administration Fee Pricing for COBRA Membership

In the Fully-Insured Pricing, the base premium for COBRA memberships is calculated either using the **Age Based Pricing Rule Type** or **Tier Based Pricing Rule Type**. In addition to the premium, COBRA membership is also charged with administration fee which can be either defined as flat charges or premium percentage. You can configure the COBRA administration fee by creating an additional charge pricing rule using an additional charge pricing rule type. You must include an additional charge pricing rule type as a related pricing rule type (in the age based or tier based pricing rule type) of the premium pricing rule type defined for the plan with a conditional rule that additional charges are only applicable for those memberships where the membership type is defined as COBRA.

The COBRA administration fee rates are generally not customer specific but remain common across different states or regions. The system provides you with an ability to define the administration fees at a higher level and if required override them at a lower level. You can define the COBRA administration fee at plan, policy, parent customer, and state level. The system checks whether the COBRA administration fee pricing rule definition is defined at the policy plan level. If an effective dated pricing rule does not exist at the policy plan level, the system further checks the administration fee pricing rule definition at policy, parent customer, and state level.

You can define an additional charge pricing rule using an additional charge pricing rule type. It is the additional charge pricing rule type which helps the system to determine:

- **C1-PrcRuleTypeCapitationFee** Business object using which the additional charges pricing rule should be created in the system.
- Algorithm which should be triggered for deriving the bill group, parent customer, and policy for a membership.

Note: You must create an algorithm using the **C1_MEMBGDRV** algorithm type and attach it to the **Bill Group Derivation** system event.

- Algorithm which should be triggered for deriving the account and price item for a membership.

Note: You must create an algorithm using the **C1_ACCPRIMEM** algorithm type and attach it to the **Account and Price Item Derivation** system event.

- Algorithm which should be triggered for deriving the subscription tier.

Note: You must create an algorithm using the **C1-DERSUBTR** algorithm type and attach it to the **Derive Subscription Tier for Membership** system event.

- Algorithm which should be triggered for calculating the COBRA administration fees for each eligible member person.

Note: You must create an algorithm using the **C1_TIERPREM** algorithm type and attach it to the **Pricing rule Type Premium Calculation** system event.

- Algorithm which should be triggered for deriving the bill period for the account.

Note: You must create an algorithm using the **C1-FIBCBP** algorithm type and attach it to the **Pricing Rule BC Creation Pre Processing** system event.

- Algorithm which should be triggered for creating the SQI based billable charges for each membership and price item combination.

Note: You must create an algorithm using the **C1-BILLRPCR** algorithm type and attach it to the **Bill Period Time Line Creation** system event.

- Algorithm which should be triggered for prorating the calculated COBRA administration fees as per the proration factor.

Note: You must create an algorithm using the **C1-TIERPRFC** algorithm type and attach it to the **Calculate Proration Factor for Tier Based Pricing Rule** system event.

- Algorithm which should be triggered for creating the SQI based billable charges for each membership and price item combination.

Note: You must create an algorithm using the **C1-FICRETBC** algorithm type and attach it to the **Pricing Rule Billable Charge Creation** system event.

- Price items for which you can define pricing rules for COBRA administration fee using the additional charges pricing rule type.
- Rate options that you can use while defining the pricing for the respective price item.
- Type of account to which the respective price item should be billed based on the specified priority.
- Rule type which indicates the rules that should be executed to determine whether the price item is eligible for billing.
- Audit event types of the **C1-Membership** and **C1-PERSON** business objects using which the audit event should be created whenever a membership or member person is added, updated, or removed from the policy plan.
- Elements of the **C1-Membership** and **C1-PERSON** business objects for which audit event should be created.

Note: You must ensure that either the **Update All** option is selected or the elements listed in the age based pricing rule type are already present in the respective audit event type. Otherwise, erroneous results might occur.

- Members, such as main subscriber, spouse, or children in a membership which are eligible for premium calculation. The system will only consider the member with the specified relationship type during premium calculation.

Once an additional charge pricing rule type is defined, you can then define the additional charge pricing rule using the additional charge pricing rule type.

Note: At present, you can define the additional charge pricing rule type only through the healthcare inbound message and not from the user interface. However, you can view the additional charge pricing rule defined for a policy plan or policy, parent customer or state from the **Customer 360° Information** screen.

While creating COBRA Admin Fees Pricing rule through a healthcare inbound message, you need to specify the following information:

- Entity type and Entity ID (i.e. Policy Plan and Policy Plan ID, or Policy and Policy ID, or Parent Customer and Parent Customer ID, or State and State Level) for which you want to define the COBRA additional charge pricing rule.
- Pricing Type – Flat or Percentage
- Start and end dates of the COBRA additional charge pricing rule.
- Additional charge pricing rule type using which you want to create the age based pricing rule
- Price Item for which you want to define the COBRA additional charge pricing rule.
- Rate option using which the price assignment should be created for the COBRA administration fees.

Note: In case you want flat based COBRA administration fees, use the **HC_FRTSC** rate schedule. In case of percentage based pricing, use the **HC_CAPRS** rate schedule.

Defining an Additional Charge Pricing Rule Type

Prerequisites

To define an additional charge pricing rule type, you should have:

- Additional charge pricing rule type business object defined in the application.

Procedure

To define an additional charge pricing rule type:

1. Click the **Admin** link in the **Application** toolbar.
A list appears.
2. From the **Admin** menu, select **P** and then click **Pricing Rule Type**.
A sub-menu appears.
3. Click the **Add** option from the **Pricing Rule Type** sub-menu.

The **Select Business Object** screen appears. It contains the following field:

Field Name	Field Description	Mandatory (Yes or No)
Pricing Rule Type Business Object	Used to indicate the business object using which you want to create the additional charge pricing rule type. Note: You can create an additional charge pricing rule type using the Additional Charge Pricing Rule Type (C1-PrcRuleTypeCapitationFee) business object.	Yes

Tip: Alternatively, you can access this screen by clicking the **Add** button in the **Page Title** area of the **Pricing Rule Type** screen.

4. Select the **Additional Charge Pricing Rule Type** business object.
5. Click **OK**.

The **Additional Charge Pricing Rule Type** screen appears. It contains the following sections:

- **Main** - Used to specify basic details about the additional charge pricing rule type.
- **Algorithms** - Used to associate the algorithms with the additional charge pricing rule type.
- **Price Items** - Used to add the price items for which you can define the pricing rules using the additional charge pricing rule type.
- **Price Item Parameters** - Used to add the price item parameters based on which you want to define the price item pricing.
- **Characteristics** - Used to define the characteristics for an additional charge pricing rule type.
- **Event Management** - Used to define the audit event type details for an additional charge pricing rule type.

The **Main** section contains the following fields:

Field Name	Field Description	Mandatory (Yes or No)
Pricing Rule Type	Used to specify the additional charge pricing rule type.	Yes

Field Name	Field Description	Mandatory (Yes or No)
Description	Used to specify the description for the additional charge pricing rule type.	Yes
Detailed Description	Used to specify the additional information about the additional charge pricing rule type.	No
Pricing Rule Business Object	Used to indicate the business object using which you want to create the additional charge pricing rule type. The valid value is: <ul style="list-style-type: none"> Additional Charge Pricing Rule 	Yes
Business Object	Indicates the business object using which you are defining the additional charge pricing rule type.	Not applicable
Status	Used to indicate the status of the additional charge pricing rule type. The valid values are: <ul style="list-style-type: none"> Active Inactive 	Yes
Primary	Used to indicate whether the pricing rule type is a primary pricing rule type. Note: You must not select the Primary option while defining the additional charge pricing rule type.	Not applicable
Skip Non-Members	Used to indicate whether the non-member membership persons should be used for the age based calculations. Note: This field is not applicable for additional charge pricing rule type.	Not applicable
Pricing Rule Type Category	Used to indicate the category to which the additional charge pricing rule type belongs. The valid value is: <ul style="list-style-type: none"> Additional Charge 	Yes
Pricing Rule Type Sub Category	Used to indicate the pricing rule type sub category for the additional charge pricing rule type. The valid value is: <ul style="list-style-type: none"> Per Member Per Subscriber Note: You must select the Per Subscriber option while defining the additional charge pricing rule type.	Not applicable

6. Enter the required details in the **Main** section.
7. Associate the required algorithms with the additional charge pricing rule type:
8. Add the required price items for the additional charge pricing rule type.
9. Add price item parameters for the additional charge pricing rule type, if required.
10. Define characteristics for the additional charge pricing rule type, if required.
11. Configure the audit in the additional charge pricing rule type.

12. Click Save.

The additional charge pricing rule type is defined.

Related Topics

For more information on...	See...
Pricing Rule Type screen	Pricing Rule Type on page 2532
How to associate algorithms with an additional charge pricing rule type	Associating an Algorithm with an Additional Charge Pricing Rule Type on page 3069
How to add price items in the additional charge pricing rule type	Adding a Price Item in an Additional Charge Pricing Rule Type on page 3071
How to add price item parameters in the additional charge pricing rule type	Adding a Price Item Parameter in an Additional Charge Pricing Rule Type on page 3074
How to define a characteristic for an additional charge pricing rule type	Defining a Characteristic for an Additional Charge Pricing Rule Type on page 3075
How to define event management for the additional charge pricing rule type	Adding Elements for Audit in an Additional Charge Pricing Rule Type on page 3076

Associating an Algorithm with an Additional Charge Pricing Rule Type**Prerequisites**

To associate an algorithm with an additional charge pricing rule type, you should have:

- An algorithm defined using the **C1_ACCPRIMEM** algorithm type.
- An algorithm defined using the **C1_MEMBGDRV** algorithm type.
- An algorithm defined using the **C1-DERSUBTR** algorithm type.
- An algorithm defined using the **C1_TIERPREM** algorithm type.
- An algorithm defined using the **C1-FIBCBP** algorithm type.
- An algorithm defined using the **C1-BILLRPCR** algorithm type.
- An algorithm defined using the **C1-TIERPRFC** algorithm type.
- An algorithm defined using the **C1-FICRETBC** algorithm type.

Procedure

To associate an algorithm with an additional charge pricing rule type:

1. Ensure that the **Algorithms** section is expanded when you are defining or editing the additional charge pricing rule type.

The **Algorithms** section contains the following columns in a grid:

Column Name	Column Description	Mandatory (Yes or No)
System Event	<p>Used to indicate the system event when you want to invoke the algorithm. The valid values are:</p> <ul style="list-style-type: none"> • Account and Price Item Derivation - Used to derive the account and price item for a membership. • Bill Group Derivation - Used to derive the bill group, parent customer, and policy for a membership. • Create Subscription Tier - Used to derive the subscription tier for a membership • Tier Based Premium Calculation - Used to calculate the COBRA administrative fees for each eligible member person. • Fetch Bill Period of Billable Charge of Membership - Used to derive the bill period for an account. • Bill Period Time Line Creation - Used to create the SQI based billable charges for each membership and price item combination. • Calculate Proration Factor for Tier Based Pricing Rule - Used to prorate the calculated COBRA administrative fees as per the proration factor. • Fully Insured Charge Creation for Memberships - Used to create the SQI based billable charges for each membership and price item combination. 	<p>Yes</p> <p>Note: This field is required when you are associating an algorithm with the additional charge pricing rule type.</p>
Sequence	Used to specify the order in which the algorithms for each system event must be executed.	<p>Yes (Conditional)</p> <p>Note: This field is required when you are associating an algorithm with the additional charge pricing rule type.</p>
Algorithm	<p>Used to specify the algorithm.</p> <p>Note:</p> <p>Once you select the system event, the Search (🔍) icon appears corresponding to the Algorithm field. On clicking the Search (🔍) icon, the Algorithm Search window appears.</p> <p>On specifying the algorithm, the description of the algorithm appears corresponding to the Algorithm field.</p>	<p>Yes (Conditional)</p> <p>Note: This field is required when you are associating an algorithm with the additional charge pricing rule type.</p>

2. Enter the following details in the **Algorithms** section:

System Event	Algorithm	Algorithm Type	Description
Account and Price Item Derivation	C1_ACCPRIMEM	C1_ACCPRIMEM	Account and PriceItem Derivation for Membership

System Event	Algorithm	Algorithm Type	Description
Bill Group Derivation	C1_MEMBGDRV	C1_MEMBGDRV	Bill Group Derivation for Membership
Derive Subscription Tier for Membership	C1-DERSUBTR	C1-DERSUBTR	Create Subscription Tier
Pricing Rule Type Premium Calculation	C1_TIERPREM	C1_TIERPREM	Tier Based Premium Calculation
Pricing Rule BC Creation Pre Processing	C1-FIBCBP	C1-FIBCBP	Fetch Bill Period of Billable Charge of Membership
Account and Price Item Derivation Post-Processing	C1-BILLRPCR	C1-BILLRPCR	Bill Period Time Line Creation
Calculate Proration Factor for Tier Based Pricing Rule	C1-TIERPRFC	C1-TIERPRFC	Calculate Proration Factor for Tier Based Pricing Rule
Pricing Rule Billable Charge Creation	C1-FICRETBC	C1-FICRETBC	Pass Through Billable Charge Creation

3. If you want to associate more than one algorithm with the additional charge pricing rule type, click the **Add (+)** icon and then repeat step 2.

Note: However, if you want to disassociate an algorithm from the additional charge pricing rule type, click the **Delete (🗑)** icon corresponding to the algorithm.

4. Click **Save**.

The algorithms are associated with the additional charge pricing rule type.

Related Topics

For more information on...	See...
How to define an additional charge pricing rule type	Defining an Additional Charge Pricing Rule Type on page 3067
How to edit an additional charge pricing rule type	Editing an Additional Charge Pricing Rule Type on page 3077

Adding a Price Item in an Additional Charge Pricing Rule Type

Prerequisites

To add a price item in an additional charge pricing rule type, you should have:

- Price item defined in the application
- Rate option defined in the **Rate Option (C1-ExtLookRefTypeRateOpt)** extendable lookup
- Values defined for the **Invoice Type (C1INVTYP)** characteristic type
- The **C1INVTYP** characteristic type set in the **Invoice Type Characteristic Type** option type of the **C1-ASOBLNG** feature configuration
- Rule types defined in the application (where the rule type usage is set to **Price Item Eligibility**)

Procedure

To add a price item in an additional charge pricing rule type:

1. Ensure that the **Price Items** section is expanded when you are defining or editing an additional charge pricing rule type.

The **Price Items** section contains the following fields in a grid:

Field Name	Field Description	Mandatory (Yes or No)				
Price Item	Used to indicate the price item that you want to include in the additional charge pricing rule type.	Yes (Conditional)				
	<p>Note:</p> <p>The Search (🔍) icon appears corresponding to the Price Item field. On clicking the Search icon, the Price Item Search window appears.</p> <p>On specifying the price item, the description of the price item appears corresponding to the Price Item field.</p>	<p>Note: This field is required when you are adding a rate option and bill to account in an additional charge pricing rule type.</p>				
Rate Option	Used to indicate one or more rate options which are valid for a price item.	Not applicable				
	On clicking the Add (➕) icon, the following field appears in a grid:					
	<table border="1"> <thead> <tr> <th>Field Name</th> <th>Field Description</th> <th>Mandatory (Yes or No)</th> </tr> </thead> <tbody> <tr> <td>Rate Option</td> <td>Used to indicate the rate option that you want to use while defining pricing for the price item.</td> <td>Yes</td> </tr> </tbody> </table>		Field Name	Field Description	Mandatory (Yes or No)	Rate Option
Field Name	Field Description	Mandatory (Yes or No)				
Rate Option	Used to indicate the rate option that you want to use while defining pricing for the price item.	Yes				
<p>Note:</p> <p>If you want to define more than one rate option to the price item in an additional charge pricing rule type, click the Add (➕) icon.</p> <p>However, if you want to remove a price item from an additional charge pricing rule type, click the Delete (🗑️) icon corresponding to the Rate Option field.</p>						

Field Name	Field Description	Mandatory (Yes or No)									
Bill To Account	<p>Used to indicate a order in which the account should be considered while deriving a transaction leg.</p> <p>On clicking the Add (+) icon, the following fields appear in a grid:</p> <table border="1"> <thead> <tr> <th>Field Name</th> <th>Field Description</th> <th>Mandatory (Yes or No)</th> </tr> </thead> <tbody> <tr> <td>Priority</td> <td>Used to specify the order in which the invoice type is considered for a price item.</td> <td>Yes</td> </tr> <tr> <td>Invoice Type</td> <td>Used to indicate the type which is considered for billing. For more information, refer to the <i>Bill Group's Account</i> on page 65 section.</td> <td>Yes</td> </tr> </tbody> </table> <div style="border: 1px solid black; padding: 5px; margin-top: 5px;"> <p>Note: The Search (🔍) icon appears corresponding to the Invoice Type field. On clicking the Search icon, the Invoice Type Search window appears.</p> </div> <p>Note: If you want to define more than one invoice type to the price item in an additional charge pricing rule type, click the Add (+) icon. However, if you want to remove a invoice type from the price item in an additional charge pricing rule type, click the Delete (🗑️) icon corresponding to the Priority field.</p>	Field Name	Field Description	Mandatory (Yes or No)	Priority	Used to specify the order in which the invoice type is considered for a price item.	Yes	Invoice Type	Used to indicate the type which is considered for billing. For more information, refer to the <i>Bill Group's Account</i> on page 65 section.	Yes	Not applicable
Field Name	Field Description	Mandatory (Yes or No)									
Priority	Used to specify the order in which the invoice type is considered for a price item.	Yes									
Invoice Type	Used to indicate the type which is considered for billing. For more information, refer to the <i>Bill Group's Account</i> on page 65 section.	Yes									
Eligibility Rule Type	Used to indicate the rule type (which indicates the rules) that should be executed to determine whether the price item is eligible for billing.	No									

2. Enter the required details in the **Price Items** section.
3. If you want to define more than one price item in an additional charge pricing rule type, click the **Add** (+) icon and then repeat step 2.

Note: However, if you want to remove a price item from an additional charge pricing rule type, click the **Delete** (🗑️) icon corresponding to the **Price Item** field.

4. Click **Save**.

The price items are added for an additional charge pricing rule type.

Related Topics

For more information on...	See...
How to define an additional charge pricing rule type	Defining an Additional Charge Pricing Rule Type on page 3067
How to edit an additional charge pricing rule type	Editing an Additional Charge Pricing Rule Type on page 3077

Adding a Price Item Parameter in an Additional Charge Pricing Rule Type

Prerequisites

To add a price item parameter in an additional charge pricing rule type, you should have:

- Parameter defined in the application where parameter usage is set to **Price Item**.
- Parameter associated with the price item.

Procedure

To add a price item parameter in an additional charge pricing rule type:

1. Ensure that the **Price Item Parameters** section is expanded when you are defining or editing an additional charge pricing rule type.

The **Price Item Parameters** section contains the following fields in a grid:

Field Name	Field Description	Mandatory (Yes or No)
Price Item Parameter	Used to specify the parameter which you can use while defining an additional charge pricing for the price item.	Yes (Conditional)
	<p>Note:</p> <p>The Search (🔍) icon appears corresponding to the Price Item Parameter field. On clicking the Search (🔍) icon corresponding to the Price Item Parameter field, the Parameter Search window appears.</p> <p>On specifying the parameter, the description of the price item parameter appears corresponding to the Price Item Parameter field.</p>	<p>Note: This field is required when you are adding a price item parameter in an additional charge pricing rule type.</p>

2. Enter the required details in the **Price Item Parameters** section.
3. If you want to add more than one price item parameter in an additional charge pricing rule type, click the **Add** (+) icon and then repeat step 2.

Note: However, if you want to remove a price item parameter from an additional charge pricing rule type, click the **Delete** (🗑) icon corresponding to the price item parameter.

4. Click **Save**.

The price item parameter is added for an additional charge pricing rule type.

Related Topics

For more information on...	See...
How to define an additional charge pricing rule type	Defining an Additional Charge Pricing Rule Type on page 3067

For more information on...	See...
How to edit an additional charge pricing rule type	Editing an Additional Charge Pricing Rule Type on page 3077

Defining a Characteristic for an Additional Charge Pricing Rule Type

Prerequisites

To define a characteristic for an additional charge pricing rule type, you should have:

- Characteristic types defined in the application (where the characteristic entity is set to **Pricing Rule Type**)

Procedure

To define a characteristic for an additional charge pricing rule type:

1. Ensure that the **Characteristics** section is expanded when you are defining or editing an additional charge pricing rule type.

The **Characteristics** section contains the following columns in a grid:

Field Name	Field Description	Mandatory (Yes or No)
Characteristic Type	Used to indicate the characteristic type.	Yes (Conditional)
	Note: The list includes only those characteristic types where the characteristic entity is set to Pricing Rule Type .	Note: This field is required when you are defining a characteristic for an additional charge pricing rule type.
Characteristic Value	Used to specify the value for the characteristic type.	Yes (Conditional)
	Note: If you select a predefined characteristic type, the Search (🔍) icon appears corresponding to the Characteristic Value field. On clicking the Search icon, the Predefined Characteristic Search window appears. On specifying the value for a predefined characteristic type, the description of the characteristic value appears corresponding to the Characteristic Value field.	Note: This field is required when you are defining a characteristic for an additional charge pricing rule type.

2. Enter the required details in the **Characteristics** section.
3. If you want to define more than one characteristic for an additional charge pricing rule type, click the **Add** (+) icon and then repeat step 2.

Note: However, if you want to remove a characteristic from an additional charge pricing rule type, click the **Delete** (🗑️) icon corresponding to the characteristic.

4. Click **Save**.

The characteristics are defined for an additional charge pricing rule type.

Related Topics

For more information on...	See...
How to define an additional charge pricing rule type	Defining an Additional Charge Pricing Rule Type on page 3067
How to edit an additional charge pricing rule type	Editing an Additional Charge Pricing Rule Type on page 3077

Adding Elements for Audit in an Additional Charge Pricing Rule Type

Prerequisites

To add elements for audit in an additional charge pricing rule type, you should have:

- Business Object **C1-AuditEventType** defined for the pricing rule type.
- Audit event type defined in the application.

Procedure

To add elements for audit in an additional charge pricing rule type:

1. Ensure that the **Event Management** section is expanded when you are defining or editing an additional charge pricing rule type.

The **Event Management** section contains the following fields in a grid:

Field Name	Field Description	Mandatory (Yes or No)
Audit Event Type	Used to specify the audit event type which you can use while adding elements for audit in an additional charge pricing rule type. Note: The Search (🔍) icon appears corresponding to the Audit Event Type field. On clicking the Search (🔍) icon corresponding to the Audit Event Type field, the Audit Event Type Search window appears. On specifying the audit event type, the description of the audit event type appears corresponding to the Audit Event Type field.	Yes
Element Type	Used to indicate the type of audit element for an additional charge pricing rule type. The valid values are: <ul style="list-style-type: none"> • Business Object Status • Characteristic • Field 	Not applicable

Field Name	Field Description	Mandatory (Yes or No)
Element Name	Used to specify the element name for an additional charge pricing rule type.	Yes
	Note: The Search (🔍) icon appears corresponding to the Element Name field. On clicking the Search (🔍) icon corresponding to the Element Name field, the Audit Event Type Element Name Search window appears.	
Element Value	Used to specify the value for an element name.	Not applicable

- Enter the required details in the **Event Management** section.
- If you want to add more than one element for audit in an additional charge pricing rule type, click the **Add** (+) icon and then repeat step 2.

Note: However, if you want to remove an element for audit from an additional charge pricing rule type, click the **Delete** (🗑️) icon corresponding to the **Audit Event Type** field.

- Click **Save**.

The elements for audit are added for an additional charge pricing rule type.

Related Topics

For more information on...	See...
How to define an additional charge pricing rule type	Defining an Additional Charge Pricing Rule Type on page 3067
How to edit an additional charge pricing rule type	Editing an Additional Charge Pricing Rule Type on page 3077

Editing an Additional Charge Pricing Rule Type

Prerequisites

To edit an additional charge pricing rule type, you should have:

- Additional charge pricing rule type business object defined in the application.
- Additional charge pricing rule business object defined in the application.

Procedure

To edit an additional charge pricing rule type:

- Click the **Admin** link in the **Application** toolbar.
A list appears.
- From the **Admin** menu, select **P** and then click **Pricing Rule Type**.
A sub-menu appears.
- Click the **Search** option from the **Pricing Rule Type** sub-menu.
The **Pricing Rule Type** screen appears.

4. In the **Pricing Rule Type List** zone, click the **Edit**  icon in the **Edit** column corresponding to the pricing rule type whose details you want to edit.

The **Tier Based Pricing Rule Type** screen appears. It contains the following sections:

- **Main** – Used to specify basic details about an additional charge pricing rule type.
- **Algorithms** – Used to associate the algorithms with an additional charge pricing rule type.
- **Price Items** – Used to add the price items for which you can define the pricing rules using the additional charge pricing rule type.
- **Price Item Parameters** – Used to add the price item parameters based on which you want to define the price item pricing.
- **Characteristics** – Used to define the characteristics for an additional charge based pricing rule type.
- **Event Management** – Used to configure the audit in an additional charge based pricing rule type.

The **Main** section contains the following fields:

Field Name	Field Description	Mandatory (Yes or No)
Pricing Rule Type	Displays the additional charge pricing rule type.	Not applicable
Description	Used to specify the description for the additional charge pricing rule type.	Yes
Detailed Description	Used to specify the additional information about the additional charge pricing rule type.	No
Pricing Rule Business Object	Used to indicate the business object using which you want to create the additional charge pricing rule type. The valid value is: <ul style="list-style-type: none"> • Additional Charge Pricing Rule 	Yes
Business Object	Indicates the business object using which you are defining the additional charge pricing rule type.	Not applicable
Status	Used to indicate the status of additional charge pricing rule type. The valid values are: <ul style="list-style-type: none"> • Active • Inactive 	Yes
Primary	Used to select the checkbox if the pricing rule type is primary. <p>Note: The checkbox appears selected, if you have already selected the Primary option while defining an additional charge pricing rule type.</p>	No
Pricing Rule Type Category	Indicates the pricing rule type category for an additional charge pricing rule type. The valid values is: <ul style="list-style-type: none"> • Additional Charge 	No

Tip: Alternatively, you can edit the details of an additional charge pricing rule type by clicking the **Edit** button in the **Pricing Rule Type** zone.

5. Modify the details in the **Main** section.

6. Associate the required algorithms in an additional charge pricing rule type.
7. Add, edit, or remove the required price items in an additional charge pricing rule type.
8. Add, edit, or remove the price item parameters in an additional charge pricing rule type, if required.
9. Add, edit, or remove characteristics for an additional charge pricing rule type, if required.
10. Add, edit, or remove the configuration details of the audit in an additional charge pricing rule type.
11. Click **Save**.

The changes made to the an additional charge pricing rule type are saved.

Related Topics

For more information on...	See...
How to associate algorithms with an additional charge pricing rule type	Associating an Algorithm with an Additional Charge Pricing Rule Type on page 3069
How to add price items in an additional charge pricing rule type	Adding a Price Item in an Additional Charge Pricing Rule Type on page 3071
How to add price item parameters in an additional charge pricing rule type	Adding a Price Item Parameter in an Additional Charge Pricing Rule Type on page 3074
How to define a characteristic for an additional charge pricing rule type	Defining a Characteristic for an Additional Charge Pricing Rule Type on page 3075
How to add elements for audit in an additional charge pricing rule type	Adding Elements for Audit in an Additional Charge Pricing Rule Type on page 3076

Deleting an Additional Charge Pricing Rule Type

Procedure

To delete an additional charge based pricing rule type:

1. Click the **Admin** link in the **Application** toolbar.
A list appears.
2. From the **Admin** menu, select **P** and then click **Pricing Rule Type**.
A sub-menu appears.
3. Click the **Search** option from the **Pricing Rule Type** sub-menu.
The **Pricing Rule Type** screen appears.
4. In the **Pricing Rule Type List** zone, click the **Delete** (🗑️) icon in the **Delete** column corresponding to the additional charge pricing rule type that you want to delete.
A message appears confirming whether you want to delete the additional charge pricing rule type.

Note: You can delete an additional fee pricing rule type when it is not yet used in the system.

Tip: Alternatively, you can delete an additional charge pricing rule type by clicking the **Delete** button in the **Pricing Rule Type** zone.

5. Click **OK**.

The additional charge pricing rule type is deleted.

Related Topics

For more information on...	See...
Pricing Rule Type screen	Pricing Rule Type on page 2532
Pricing Rule Type List zone	Pricing Rule Type List on page 2533
Pricing Rule Type zone	Pricing Rule Type on page 2536

Viewing the Additional Charge Pricing Rule Type Details**Procedure**

To view the details of an additional charge pricing rule type:

1. Click the **Admin** link in the **Application** toolbar.

A list appears.

2. From the **Admin** menu, select **P** and then click **Pricing Rule Type**.

A sub-menu appears.

3. Click the **Search** option from the **Pricing Rule Type** sub-menu.

The **Pricing Rule Type** screen appears.

4. In the **Pricing Rule Type List** zone, click the

Broadcast () icon corresponding to the additional charge pricing rule type whose details you want to view.

The **Pricing Rule Type** zone appears.

5. View the details of the an additional charge pricing rule type in the **Pricing Rule Type** zone.**Related Topics**

For more information on...	See...
Pricing Rule Type screen	Pricing Rule Type on page 2532
Pricing Rule Type List zone	Pricing Rule Type List on page 2533
Pricing Rule Type zone	Pricing Rule Type on page 2536

Medicare Part D LIS and LEP Pricing

Oracle Revenue Management and Billing enables you to consider the low income subsidy (LIS) and late enrollment penalty (LEP) while calculating the Medicare Part D premium. A new pricing rule type category named **Benefit** and a new business object named **Benefit Pricing Rule Type (C1-PrcRuleTypeBenefit)** are introduced in this release.

The system refers the benefit pricing rule type associated with the Medicare affiliated policy plan to determine the price items which should be charged for LIS and LEP. While creating a benefit pricing rule type, you must the select the **Benefit Pricing Rule Type** business object and set the pricing rule type category to **Benefit**. Here, you must specify the algorithms for the following system events:

System Event	Algorithm
Account and Price Item Derivation	C1_ACCPRIMEM

System Event	Algorithm
Account and Price Item Derivation Post-Processing	C1-BILLPDRV
Billable Charge Creation Post-Processing	C1-FICRETBC
Bill Group Derivation	C1_MEMBGDRV
Premium Calculation	C1_MEDIPREM

In addition, you must specify the price items for which the charge should be created when the benefit sub type is **LIS** or **LEP**. Here, you must specify the parameter based eligibility rule type for the price item. The system then creates a charge for LIS or LEP when the rule is satisfied.

Defining a Benefit Pricing Rule Type

Prerequisites

To define a benefit pricing rule type, you should have:

- Business Object **C1-PrcRuleTypeBenefit** defined for benefit pricing rule type.
- Pricing rule type category for the benefit defined in the application.

Procedure

To define a benefit pricing rule type:

1. Click the **Admin** link in the **Application** toolbar.
A list appears.
2. From the **Admin** menu, select **P** and then click **Pricing Rule Type**.
A sub-menu appears.
3. Click the **Add** option from the **Pricing Rule Type** sub-menu.

The **Select Business Object** screen appears. It contains the following field:

Field Name	Field Description	Mandatory (Yes or No)
Pricing Rule Type Business Object	Used to indicate the business object using which you want to create the benefit pricing rule type. Note: You can create a benefit pricing rule type using the Benefit Pricing Rule Type business object.	Yes

Tip: Alternatively, you can access this screen by clicking the **Add** button in the **Page Title** area of the **Pricing Rule Type** screen.

4. Select the **Benefit Pricing Rule Type** business object.
5. Click **OK**.

The **Benefit Pricing Rule Type** screen appears. It contains the following sections:

- **Main** – Used to specify basic details about the benefit pricing rule type.
- **Algorithms** – Used to associate the algorithms with the benefit pricing rule type.
- **Price Items** – Used to add the price items for which you can define the benefit pricing rules using the benefit pricing rule type.

- **Price Item Parameters** – Used to add the price item parameters based on which you want to define the price item pricing.
- **Characteristics** – Used to define the characteristics for the benefit pricing rule type.
- **Event Management** – Used to define the audit event type details for the benefit pricing rule type.

The **Main** section contains the following fields:

Field Name	Field Description	Mandatory (Yes or No)
Pricing Rule Type	Used to specify the benefit pricing rule type.	Yes
Description	Used to specify the description for the benefit pricing rule type.	Yes
Detailed Description	Used to specify the additional information about the benefit pricing rule type.	No
Pricing Rule Business Object	Used to indicate the business object using which you want to create the benefit pricing rule type. The valid values are: <ul style="list-style-type: none"> • Age Based Pricing Rule • Tier Based Pricing Rule 	Yes
	Note: You can create a benefit pricing rule type using the age based or tier based pricing rule business object.	
Business Object	Indicates the business object using which you are defining the benefit charge pricing rule type.	Not applicable
Status	Used to indicate the status of the benefit pricing rule type. The valid values are: <ul style="list-style-type: none"> • Active • Inactive 	Yes
Primary	Used to indicate whether the pricing rule type is a primary pricing rule type.	Not applicable
	Note: You must not select the Primary option while defining the benefit pricing rule type.	
Skip Non-Members	Used to indicate whether the non-member membership persons should be used for the age based calculations.	Not applicable
	Note: This field is not applicable for benefit pricing rule type.	
Pricing Rule Type Category	Used to indicate the category to which the pricing rule type belongs. The valid value is: <ul style="list-style-type: none"> • Benefit 	Yes

6. Enter the required details in the **Main** section.
7. Ensure that **Primary** option is not selected when you are defining a benefit pricing rule type.
8. Associate the required algorithms with the benefit pricing rule type.
9. Add the required price items for the benefit pricing rule type.

10. Add price item parameters for the benefit pricing rule type.
11. Define characteristics for the benefit pricing rule type.
12. Configure the audit in the benefit pricing rule type.
13. Click **Save**.

The benefit pricing rule type is defined.

Related Topics

For more information on...	See...
Pricing Rule Type screen	Pricing Rule Type on page 2532
How to associate algorithms with the benefit pricing rule type	Associating Algorithms with a Benefit Pricing Rule Type on page 3083
How to add pricing items in the benefit pricing rule type	Adding a Price Item in a Benefit Pricing Rule Type on page 3085
How to add price item parameters in the benefit pricing rule type	Adding a Price Item Parameter in a Benefit Pricing Rule Type on page 3087
How to define a characteristic for the benefit pricing rule type	Defining a Characteristic for a Benefit Pricing Rule Type on page 3088
How to define event management for the benefit pricing rule type	Adding Elements for Audit in a Benefit Pricing Rule Type on page 3089

Associating Algorithms with a Benefit Pricing Rule Type

Prerequisites

To associate algorithms with a benefit pricing rule type, you should have:

- An Algorithm created using an algorithm type.

Procedure

To associate algorithms with a benefit pricing rule type:

1. Ensure that the **Algorithms** section is expanded when you are defining the benefit pricing rule type.

The **Algorithms** section contains the following columns in a grid:

Column Name	Column Description	Mandatory (Yes or No)
System Event	Used to indicate the system event when the algorithm is invoked. The valid values are: <ul style="list-style-type: none"> • Account and Price Item Derivation Post Processing • Account and Price Item Derivation • Billable Charge Creation Pre Processing • Bill Group Derivation • Billable Charge Creation Post Processing • Premium Calculation 	Yes
		Note: This field is required when you are associating an algorithm for the benefit pricing rule type.

Column Name	Column Description	Mandatory (Yes or No)
Sequence	Used to specify the order in which the algorithms for each system event must be executed.	Yes (Conditional) Note: This field is required when you are associating an algorithm for the benefit pricing rule type.
Algorithm	Used to specify the algorithm. Note: If you select the system event option, the Search (🔍) icon appears corresponding to the Algorithm field. On clicking the Search (🔍) icon, the Algorithm Search window appears. On specifying the algorithm, the description of the algorithm appears corresponding to the Algorithm field.	Yes (Conditional) Note: This field is required when you are associating an algorithm for the benefit pricing rule type.

2. Enter the required details in the **Algorithms** section:

System Event	Algorithm	Algorithm Type	Description
Account and Price Item Derivation Post Processing	C1-BILLPDRV	C1-BILLPDRV	Bill Period Derivation
Account and Price Item Derivation	C1_ACCPRIMEM	C1_ACCPRIMEM	Account and Price Item Derivation for Membership
Billable Charge Creation Pre Processing	C1-FIBCBP	C1-FIBCBP	Fetch Bill Period of Billable Charge of Membership
Bill Group Derivation	C1_MEMBGDRV	C1_MEMBGDRV	Bill Group Derivation for Membership
Billable Charge Creation Post Processing	C1-FICRETBC	C1-FICRETBC	Fully-Insured Charge creation for memberships
Premium Calculation	C1_MEDIPREM	C1_MEDIPREM	Medicare Premium Calculation

3. If you want to associate more than one algorithm for the benefit pricing rule type, click the **Add** (+) icon and then repeat step 2.

Note: However, if you want to disassociate an algorithm from the benefit pricing rule type, click the **Delete** (🗑️) icon corresponding to the algorithm.

4. Click **Save**.

The algorithms are associated with the benefit pricing rule type.

Related Topics

For more information on...	See...
How to define a benefit pricing rule type	Defining a Benefit Pricing Rule Type on page 3081

For more information on...	See...
How to edit the benefit pricing rule type	Editing a Benefit Pricing Rule Type on page 3090
How to delete the benefit pricing rule type	Deleting a Benefit Pricing Rule Type on page 3092

Adding a Price Item in a Benefit Pricing Rule Type

Prerequisites

To add a price item in a benefit pricing rule type, you should have:

- Price item defined in the application
- Values defined for the **Invoice Type (C1INVTYP)** characteristic type
- The **C1INVTYP** characteristic type set in the **Invoice Type Characteristic Type** option type of the **C1-ASOBLNG** feature configuration
- Rule types defined in the application (where the rule type usage is set to **Price Item Eligibility**)

Procedure

To add a price item in a benefit pricing rule type:

1. Ensure that the **Price Items** section is expanded when you are defining or editing a benefit based pricing rule type.

The **Price Items** section contains the following fields in a grid:

Field Name	Field Description	Mandatory (Yes or No)
Price Item	Used to indicate the price item that you want to include in a benefit pricing rule type.	Yes (Conditional)
	<p>Note:</p> <p>The Search (🔍) icon appears corresponding to the Price Item field. On clicking the Search icon, the Price Item Search window appears.</p> <p>On specifying the price item, the description of the price item appears corresponding to the Price Item field.</p>	<p>Note: This field is required when you are adding a bill to account in a benefit pricing rule type.</p>

Field Name	Field Description	Mandatory (Yes or No)									
Bill To Account	<p>Used to indicate a order in which the account should be considered while deriving a transaction leg.</p> <p>On clicking the Add (+) icon, the following fields appear in a grid:</p> <table border="1"> <thead> <tr> <th>Field Name</th> <th>Field Description</th> <th>Mandatory (Yes or No)</th> </tr> </thead> <tbody> <tr> <td>Priority</td> <td>Used to specify the order in which the invoice type is considered for a price item.</td> <td>Yes</td> </tr> <tr> <td>Invoice Type</td> <td>Used to indicate the type which is considered for billing. For more information, refer to the Bill Group's Account on page 65 section.</td> <td>Yes</td> </tr> </tbody> </table> <div style="border: 1px solid black; padding: 5px; margin-top: 5px;"> <p>Note: The Search (🔍) icon appears corresponding to the Invoice Type field. On clicking the Search icon, the Invoice Type Search window appears.</p> </div>	Field Name	Field Description	Mandatory (Yes or No)	Priority	Used to specify the order in which the invoice type is considered for a price item.	Yes	Invoice Type	Used to indicate the type which is considered for billing. For more information, refer to the Bill Group's Account on page 65 section.	Yes	Not applicable
Field Name	Field Description	Mandatory (Yes or No)									
Priority	Used to specify the order in which the invoice type is considered for a price item.	Yes									
Invoice Type	Used to indicate the type which is considered for billing. For more information, refer to the Bill Group's Account on page 65 section.	Yes									
	<p>Note:</p> <p>If you want to define more than one invoice type to the price item in a benefit pricing rule type, click the Add (+) icon.</p> <p>However, if you want to remove a invoice type from the price item in a benefit pricing rule type, click the Delete (🗑️) icon corresponding to the Priority field.</p>										
Eligibility Rule Type	Used to indicate the rule type (which indicates the rules) that should be executed to determine whether the price item is eligible for billing.	No									

2. Enter the required details in the **Price Items** section.
3. If you want to define more than one price item in a benefit pricing rule type, click the **Add** (+) icon and then repeat step 2.

Note: However, if you want to remove a price item from a benefit pricing rule type, click the **Delete** (🗑️) icon corresponding to the **Price Item** field.

4. Click **Save**.
- The price items are added for a benefit pricing rule type.

Related Topics

For more information on...	See...
How to define a benefit pricing rule type	Defining a Benefit Pricing Rule Type on page 3081
How to edit a benefit pricing rule type	Editing a Benefit Pricing Rule Type on page 3090

Adding a Price Item Parameter in a Benefit Pricing Rule Type

Prerequisites

To add a price item parameter in a benefit pricing rule type, you should have:

- Parameter defined in the application where parameter usage is set to **Price Item**.
- Parameter associated with the price item.

Procedure

To add a price item parameter in a benefit pricing rule type:

1. Ensure that the **Price Item Parameters** section is expanded when you are defining or editing a benefit pricing rule type.

The **Price Item Parameters** section contains the following fields in a grid:

Field Name	Field Description	Mandatory (Yes or No)
Price Item Parameter	Used to specify the parameter which you can use while defining a benefit pricing rule type for the price item.	Yes (Conditional)
	<p>Note:</p> <p>The Search (🔍) icon appears corresponding to the Price Item Parameter field. On clicking the Search (🔍) icon corresponding to the Price Item Parameter field, the Parameter Search window appears.</p> <p>On specifying the parameter, the description of the price item parameter appears corresponding to the Price Item Parameter field.</p>	<p>Note: This field is required when you are adding a price item parameter in a benefit pricing rule type.</p>

2. Enter the required details in the **Price Item Parameters** section.
3. If you want to add more than one price item parameter in a benefit pricing rule type, click the **Add** (+) icon and then repeat step 2.

Note: However, if you want to remove a price item parameter from a benefit pricing rule type, click the **Delete** (🗑️) icon corresponding to the price item parameter.

4. Click **Save**.

The price item parameter is added for a benefit pricing rule type.

Related Topics

For more information on...	See...
How to define a benefit pricing rule type	Defining a Benefit Pricing Rule Type on page 3081

For more information on...	See...
How to edit a benefit pricing rule type	Editing a Benefit Pricing Rule Type on page 3090

Defining a Characteristic for a Benefit Pricing Rule Type

Prerequisites

To define a characteristic for a benefit pricing rule type, you should have:

- Characteristic types defined in the application (where the characteristic entity is set to **Pricing Rule Type**)

Procedure

To define a characteristic for a benefit pricing rule type:

1. Ensure that the **Characteristics** section is expanded when you are defining or editing a benefit pricing rule type.

The **Characteristics** section contains the following columns in a grid:

Field Name	Field Description	Mandatory (Yes or No)
Characteristic Type	Used to indicate the characteristic type.	Yes (Conditional)
	Note: The list includes only those characteristic types where the characteristic entity is set to Pricing Rule Type .	Note: This field is required when you are defining a characteristic for a benefit pricing rule type.
Characteristic Value	Used to specify the value for the characteristic type.	Yes (Conditional)
	Note: On specifying the value for a predefined characteristic type, the description of the characteristic value appears corresponding to the Characteristic Value field.	Note: This field is required when you are defining a characteristic for a benefit pricing rule type.

2. Enter the required details in the **Characteristics** section.

Note: If you select a predefined characteristic type, the **Search** (🔍) icon appears corresponding to the **Characteristic Value** field. On clicking the **Search** icon, you can search for a predefined characteristic value.

3. If you want to define more than one characteristic for a benefit pricing rule type, click the **Add** (+) icon and then repeat step 2.

Note: However, if you want to remove a characteristic from a benefit pricing rule type, click the **Delete** (🗑️) icon corresponding to the characteristic.

4. Click **Save**.

The characteristics are defined for a benefit pricing rule type.

Related Topics

For more information on...	See...
How to define a benefit pricing rule type	Defining a Benefit Pricing Rule Type on page 3081

For more information on...	See...
How to edit a benefit pricing rule type	Editing a Benefit Pricing Rule Type on page 3090

Adding Elements for Audit in a Benefit Pricing Rule Type

Prerequisites

To add elements for audit in a benefit pricing rule type, you should have:

- Business Object **C1-AuditEventType** defined for the pricing rule type.
- Audit event type defined in the application.

Procedure

To add elements for audit in a benefit pricing rule type:

1. Ensure that the **Event Management** section is expanded when you are defining or editing a benefit pricing rule type.

The **Event Management** section contains the following fields in a grid:

Field Name	Field Description	Mandatory (Yes or No)
Audit Event Type	Used to specify the audit event type which you can use while adding elements for audit in a benefit pricing rule type. Note: The Search (🔍) icon appears corresponding to the Audit Event Type field. On clicking the Search (🔍) icon corresponding to the Audit Event Type field, the Audit Event Type Search window appears. On specifying the audit event type, the description of the audit event type appears corresponding to the Audit Event Type field.	Yes
Element Type	Used to indicate the type of audit element for a benefit pricing rule type. The valid values are: <ul style="list-style-type: none"> • Business Object Status • Characteristic • Field 	Not applicable
Element Name	Used to specify the element name for a benefit pricing rule type. Note: The Search (🔍) icon appears corresponding to the Element Name field. On clicking the Search (🔍) icon corresponding to the Element Name field, the Audit Event Type Element Name Search window appears.	Yes
Element Value	Used to specify the value for an element name.	Not applicable

2. Enter the required details in the **Event Management** section.

- If you want to add more than one element for audit in a benefit pricing rule type, click the **Add (+)** icon and then repeat step 2.

Note: However, if you want to remove an element for audit in a benefit pricing rule type, click the **Delete (🗑)** icon corresponding to the audit event type.

- Click **Save**.

The elements for audit are added for a benefit pricing rule type

Related Topics

For more information on...	See...
How to define a benefit pricing rule type	Defining a Benefit Pricing Rule Type on page 3081
How to edit a benefit pricing rule type	Editing a Benefit Pricing Rule Type on page 3090

Editing a Benefit Pricing Rule Type

Prerequisites

To edit a benefit pricing rule type, you should have:

- Benefit pricing rule type business object defined in the application.

Procedure

To define a benefit pricing rule type:

- Click the **Admin** link in the **Application** toolbar.
A list appears.
- From the **Admin** menu, select **P** and then click **Pricing Rule Type**.
A sub-menu appears.
- Click the **Search** option from the **Pricing Rule Type** sub-menu.
The **Pricing Rule Type** screen appears.
- In the **Pricing Rule Type List** zone, click the **Edit (✎)** icon in the **Edit** column corresponding to the pricing rule type whose details you want to edit.

The **Benefit Pricing Rule Type** screen appears. It contains the following sections:

- Main** – Used to specify basic details about the benefit pricing rule type.
- Algorithms** – Used to associate the algorithms with the benefit pricing rule type.
- Price Items** – Used to add the price items for which you can define the benefit pricing rules using the benefit pricing rule type.
- Price Item Parameters** – Used to add the price item parameters based on which you want to define the price item pricing.
- Characteristics** – Used to define the characteristics for the benefit pricing rule type.
- Event Management** – Used to define the audit event type details for the benefit pricing rule type.

The **Main** section contains the following fields:

Field Name	Field Description	Mandatory (Yes or No)
Pricing Rule Type	Displays the benefit pricing rule type.	Not applicable
Description	Used to specify the description for the benefit pricing rule type.	Yes
Detailed Description	Used to specify the additional information about the benefit pricing rule type.	No
Pricing Rule Business Object	Used to indicate the business object using which you want to create the benefit pricing rule type. The valid values are: <ul style="list-style-type: none"> Age Based Pricing Rule Tier Based Pricing Rule <p>Note: You can create a benefit pricing rule type using the age based or tier based pricing rule business object.</p>	Yes
Business Object	Indicates the business object using which you are defining the benefit charge pricing rule type.	Not applicable
Status	Used to indicate the status of the benefit pricing rule type. The valid values are: <ul style="list-style-type: none"> Active Inactive 	Yes
Primary	Used to indicate whether the pricing rule type is a primary pricing rule type. <p>Note: You must not select the Primary option while defining the benefit pricing rule type.</p>	Not applicable
Skip Non-Members	Used to indicate whether the non-member membership persons should be used for the age based calculations. <p>Note: This field is not applicable for benefit pricing rule type.</p>	Not applicable
Pricing Rule Type Category	Used to indicate the category to which the pricing rule type belongs. The valid value is: <ul style="list-style-type: none"> Benefit <p>Note: This is a read-only field.</p>	Not applicable

- Enter the required details in the **Main** section.
- Ensure that **Primary** option is not selected when you are editing a benefit pricing rule type.
- Associate the required algorithms with the benefit pricing rule type:
- Add, edit, or remove the required price items for the benefit pricing rule type.
- Add, edit, or remove the price item parameters for the benefit pricing rule type.
- Add, edit, or remove the characteristics for the benefit pricing rule type.
- Add, edit, or remove the event management details for the benefit pricing rule type.

12. Click Save.

The changes made to the benefit pricing rule type are saved.

Related Topics

For more information on...	See...
Pricing Rule Type screen	Pricing Rule Type on page 2532
How to associate algorithms with a benefit pricing rule type	Associating Algorithms with a Benefit Pricing Rule Type on page 3083
How to add pricing items in the benefit pricing rule type	Adding a Price Item in a Benefit Pricing Rule Type on page 3085
How to add price item parameters in the benefit pricing rule type	Adding a Price Item Parameter in a Benefit Pricing Rule Type on page 3087
How to define a characteristic for the benefit pricing rule type	Defining a Characteristic for a Benefit Pricing Rule Type on page 3088
How to define event management for the benefit pricing rule type	Adding Elements for Audit in a Benefit Pricing Rule Type on page 3089

Deleting a Benefit Pricing Rule Type**Procedure**

To delete a benefit pricing rule type:

1. Click the **Admin** link in the **Application** toolbar.
A list appears.
2. From the **Admin** menu, select **P** and then click **Pricing Rule Type**.
A sub-menu appears.
3. Click the **Search** option from the **Pricing Rule Type** sub-menu.
The **Pricing Rule Type** screen appears.
4. In the **Pricing Rule Type List** zone, click the **Delete** (🗑️) icon in the **Delete** column corresponding to the benefit pricing rule type that you want to delete.
A message appears confirming whether you want to delete the benefit pricing rule type.

Note: You can delete a benefit pricing rule type when it is not yet used in the system.

Tip: Alternatively, you can delete a benefit pricing rule type by clicking the **Delete** button in the **Pricing Rule Type** zone.

5. Click **OK**.

The benefit pricing rule type is deleted.

Related Topics

For more information on...	See...
Pricing Rule Type screen	Pricing Rule Type on page 2532
Pricing Rule Type List zone	Pricing Rule Type List on page 2533
Pricing Rule Type zone	Pricing Rule Type on page 2536

Viewing the Benefit Pricing Rule Type Details

Procedure

To view the details of a benefit pricing rule type:

1. Click the **Admin** link in the **Application** toolbar.
A list appears.
2. From the **Admin** menu, select **P** and then click **Pricing Rule Type**.
A sub-menu appears.
3. Click the **Search** option from the **Pricing Rule Type** sub-menu.
The **Pricing Rule Type** screen appears.
4. In the **Pricing Rule Type List** zone, click the **Broadcast** () icon corresponding to the benefit pricing rule type whose details you want to view.
The **Pricing Rule Type** zone appears.
5. View the details of the benefit pricing rule type in the **Pricing Rule Type** zone.

Related Topics

For more information on...	See...
Pricing Rule Type screen	Pricing Rule Type on page 2532
Pricing Rule Type List zone	Pricing Rule Type List on page 2533
Pricing Rule Type zone	Pricing Rule Type on page 2536

Discount Charge Pricing for Retiree Membership

Oracle Revenue Management and Billing enables you to maintain a flat or percentage based contribution of employer or sponsor for a retiree membership through a discount charge pricing rule. A new pricing rule type category named **Discount Charge** and the new business objects named **Discount Charge Pricing Rule Type (C1-PrcRuleTypeDisChg)** and **Discount Charge Pricing Rule (C1-PricingRuleDiscount)** are introduced in this release. This enables you to create the discount charge pricing rules where you can define different base and modifier fees based on the following pricing parameters:

- Membership attributes
- Member person attributes

For the fully-insured group business, you can create or edit a flat or percentage based discount charge pricing rule through a health care inbound message. You can define a discount charge pricing rule at the policy plan, policy, or parent customer level. The following table describes the information that you need to provide in a health care inbound message while defining or editing a discount charge pricing rule on a policy plan, policy, or parent customer:

Entity Type	Entity Identifiers
Policy Plan	Policy, Plan, and Source System
Policy	Policy and Source System
Parent Customer	Person Identifier Type and Person Identifier Value

For the fully-insured individual business, you can create or edit a flat or percentage based discount charge pricing rule through a health product and plan inbound message. You can define a discount charge pricing rule at the health plan

level. The following table describes the information that you need to provide in a health product and plan inbound message while defining or editing a discount charge pricing rule on a health plan:

Entity Type	Entity Identifiers
Health Plan	Health Plan

You can view a discount charge pricing rule defined for the fully-insured group business through the **Customer 360° View** screen. However, at present, you cannot view a discount charge pricing rule defined for the fully-insured individual business from the user interface.

You can create a discount charge pricing rule using a discount charge pricing rule type. You can create a discount charge pricing rule type from the user interface and not through an inbound message. While creating a discount charge pricing rule type, you must select the **Discount Charge Pricing Rule Type** business object and set the pricing rule type category to **Discount Charge**. The discount is always charged per subscriber and not per member, and therefore you must set the pricing rule type sub category to **Per Subscriber**. Here, you must specify the algorithms for the following system events:

System Event	Algorithm
Account and Price Item Derivation	C1_ACCPRIMEM
Account and Price Item Derivation Post-Processing	C1-BILLPDRV
Account and Price Item Derivation Post-Processing	C1-BILLRPCR
Billable Charge Creation Post-Processing	C1-FICRETBC
Bill Group Derivation	C1_MEMBGDRV
Premium Calculation	C1_TIERPREM

In addition, you must specify the price items for which you can create discount charge pricing rules using the discount charge pricing rule type. A discount charge pricing rule type is not a primary pricing rule type. You must include a discount charge pricing rule type as a related pricing rule type in the age-based or tier based pricing rule types which are used for calculating the retiree membership premium. This is because the discount is offered on the retiree membership premium.

If the pricing type in the discount charge pricing rule is set to **Flat**, the system offers a flat discount on the retiree membership. But, if pricing type in the discount charge pricing rule is set to **Percent**, the system calculates and offers the percentage based discount on the retiree membership premium.

Prerequisites

To setup the discount charge pricing for retiree membership, you need to do the following:

- Define the **Discount Charge Pricing Rule Type (C1-PrcRuleTypeDisChg)** business object in the system.
- Define the **Discount Charge Pricing Rule (C1-PricingRuleDiscount)** business object in the system.
- Define the **Discount Charge** pricing rule type category in the system.
- Define the required algorithms in the system.
- Define the required price items and price item parameters in the system.
- Define the required rate options in the **Rate Option (C1-ExtLookRetTypeRateOpt)** extendable lookup.
- Define the required rule types (where the rule type usage is set to **Price Item Eligibility**).
- Define the required policy, policy plan, and persons in the system.
- Define the **Healthcare Product (C1-HealthcareProduct)** business object in the system.
- Define the **Health Plan (C1-HealthPlan)** business object in the system.

- Define the **Audit Event Type (C1-AuditEventType)** business object in the system.
- Define the required audit event type in the system.
- Define the required characteristic types (where the characteristic entity is set to **Pricing Rule Type**) in the system.

Discount Charge Pricing Rule

The **Discount Charge Pricing Rule** zone displays the details of the discount charge pricing rule for the fully-insured individual or group customer (who is a parent customer, bill group, or a bill group's account) using a pricing group. It contains the following sections:

- **Pricing Information** – Displays basic details about the discount charge pricing rule. It contains the following fields:

Column Name	Column Description
Plan Number	Displays the plan number.
Plan Name	Displays the plan name.
Plan Start Date	Displays the date from when the plan is effective for the additional charge pricing rule.
Plan End Date	Displays the date till when the plan rule is effective for the additional charge pricing rule.
Policy Information	Displays information about the policy. Note: It has a link. On clicking the link, the Policy screen appears where you can view the details of the policy.
Health Plan	Displays the health plan. Note: This field appears only when you are viewing the discount charge pricing rule of a fully-insured individual.
Health Product	Displays the health product. Note: This field appears only when you are viewing the discount charge pricing rule of a fully-insured individual.
Pricing Rule Type	Indicates the type of the pricing rule.
Price Item Information	Indicates the price item for which the discount charge pricing rule is created. Note: It has a link. On clicking the link, the Price Item screen appears where you can view the details of the price item.
Pricing Start Date	Displays the date from when the pricing rule is effective.
Pricing End Date	Displays the date till when the pricing rule is effective.
Rate Option	Indicates the rate option which is used while defining the pricing for the price item.
Modifier Applicability	Indicates modifier based on which discount is offered to an eligible member.
Modifier Method	Indicates the method used when modifier applicability option is selected.

Column Name	Column Description
Pricing Type	Indicates the type of pricing defined for the discount charge pricing rule. The valid values are: <ul style="list-style-type: none"> • Flat • Percentage
	Note: This field appears when the Pricing Type option is selected.

- **Pricing Parameters** – Displays the pricing parameter information for a discount charge pricing rule. It contains the following fields:

Column Name	Column Description										
Pricing Parameters	Displays the pricing and parameter details for an additional charge pricing rule. It contains the following columns: <table border="1" data-bbox="578 699 1463 1050"> <thead> <tr> <th>Column Name</th> <th>Column Description</th> </tr> </thead> <tbody> <tr> <td>Price Item Parameter</td> <td>Displays the parameter using which an age based eligibility criteria is defined.</td> </tr> <tr> <td>Parameter Description</td> <td>Displays the description of the price item parameter.</td> </tr> <tr> <td>Parameter Value</td> <td>Displays the value of the parameter.</td> </tr> <tr> <td>Parameter Value Description</td> <td>Displays the description of the value, defined as a parameter.</td> </tr> </tbody> </table>	Column Name	Column Description	Price Item Parameter	Displays the parameter using which an age based eligibility criteria is defined.	Parameter Description	Displays the description of the price item parameter.	Parameter Value	Displays the value of the parameter.	Parameter Value Description	Displays the description of the value, defined as a parameter.
Column Name	Column Description										
Price Item Parameter	Displays the parameter using which an age based eligibility criteria is defined.										
Parameter Description	Displays the description of the price item parameter.										
Parameter Value	Displays the value of the parameter.										
Parameter Value Description	Displays the description of the value, defined as a parameter.										
Base Fee	Displays the fee applicable on the age limit and attributes of an eligible member.										

- **Modifier Information** – Displays the modifiers based on which discount is offered to an eligible member in an discount charge pricing rule. It contains the following fields:

Column Name	Column Description
Modifier Type	Displays the type of modifier based on which you want to offer discount to an eligible member.
Modifier Type Description	Displays the description of the modifier.
Modifier Value	Displays the value of the modifier.
Modifier Value Description	Displays the description of the modifier value.
Modifier Fee	Displays the discount offered to an eligible member.

- **Characteristics** – Lists the characteristics defined for the discount charge pricing rule. It contains the following columns:

Column Name	Column Description
Effective Date	Displays the date from when the characteristic is effective for the discount charge pricing rule.
Characteristic Type	Indicates the characteristic type.

Column Name	Column Description
Characteristic Value	Displays the value of the characteristic type.

Defining a Discount Charge Pricing Rule Type

Prerequisites

To define a discount charge pricing rule type, you should have:

- Discount charge pricing rule type business object defined in the application.
- Discount charge pricing rule business object defined in the application.
- Pricing rule type category for the discount charge defined in the application.

Procedure

To define a discount charge pricing rule type:

1. Click the **Admin** link in the **Application** toolbar.

A list appears.

2. From the **Admin** menu, select **P** and then click **Pricing Rule Type**.

A sub-menu appears.

3. Click the **Add** option from the **Pricing Rule Type** sub-menu.

The **Select Business Object** screen appears. It contains the following field:

Field Name	Field Description	Mandatory (Yes or No)
Pricing Rule Type Business Object	Used to indicate the business object using which you want to create a discount charge pricing rule type. Note: You can create a discount charge pricing rule type using the Discount Charge Pricing Rule Type business object.	Yes

Tip: Alternatively, you can access this screen by clicking the **Add** button in the **Page Title** area of the **Pricing Rule Type** screen.

4. Select the **Discount Charge Pricing Rule Type** option from the **Pricing Rule Type Business Object** list.
5. Click **OK**.

The **Discount Charge Pricing Rule Type** screen appears. It contains the following sections:

- **Main** – Used to specify basic details about the discount charge pricing rule type.
- **Algorithms** – Used to associate the algorithms with a discount charge pricing rule type.
- **Price Items** – Used to add the price items for which you can define the discount charge pricing rules using the discount charge pricing rule type.
- **Price Item Parameters** – Used to add the price item parameters based on which you want to define the price item pricing.
- **Characteristics** – Used to define the characteristics for a discount charge pricing rule type.
- **Event Management** – Used to configure the audit in a discount charge pricing rule type.

The **Main** section contains the following fields:

Field Name	Field Description	Mandatory (Yes or No)
Pricing Rule Type	Used to specify the discount charge pricing rule type.	Yes
Description	Used to specify the description for the discount charge pricing rule type.	Yes
Detailed Description	Used to specify additional information about the discount charge pricing rule type.	No
Pricing Rule Business Object	Used to indicate the business object using which you want to create the discount charge pricing rule type. The valid value is: <ul style="list-style-type: none"> Discount Charge Pricing Rule 	Yes
Business Object	Indicates the business object using which you are defining the discount charge pricing rule type.	Not applicable
Status	Used to indicate the status of the discount charge pricing rule type. The valid values are: <ul style="list-style-type: none"> Active Inactive 	Yes
Primary	Used to indicate whether the discount charge pricing rule type is a primary pricing rule type.	No
	Note: You must not select the Primary option while defining the discount charge pricing rule type.	
Pricing Rule Type Category	Used to indicate the category to which the discount charge pricing rule type belongs. The valid value is: <ul style="list-style-type: none"> Discount Charge 	Yes
Pricing Rule Type Sub Category	Used to indicate the pricing rule type sub category for the discount charge pricing rule type. The valid values are: <ul style="list-style-type: none"> Per Member Per Subscriber 	No
	Note: You must select the Per Subscriber option while defining the discount charge pricing rule type.	

6. Enter the required details in the **Main** section.
7. Associate the required algorithms with the discount charge pricing rule type.
8. Add the required price items in the discount charge pricing rule type.
9. Add the price item parameters in the discount charge pricing rule type, if required.
10. Define characteristics for the discount charge pricing rule type, if required.
11. Configure the audit in the discount charge pricing rule type.
12. Click **Save**.

The the discount charge pricing rule type is defined.

Related Topics

For more information on...	See...
How to associate algorithms with the discount charge pricing rule type	Associating an Algorithm with a Discount Charge Pricing Rule Type on page 3099
How to add price items in the discount charge pricing rule type	Adding a Price Item in a Discount Charge Pricing Rule Type on page 3101
How to add price item parameters in the discount charge pricing rule type	Adding a Price Item Parameter in a Discount Charge Pricing Rule Type on page 3104
How to define characteristics for the discount charge pricing rule type	Defining a Characteristic for a Discount Charge Pricing Rule Type on page 3105
How to add elements for audit in the discount charge pricing rule type	Adding Elements for Audit in a Discount Charge Pricing Rule Type on page 3106

Associating an Algorithm with a Discount Charge Pricing Rule Type**Prerequisites**

To associate an algorithm with a discount charge pricing rule type, you should have:

- An algorithm defined using the **C1_ACCPRIMEM** algorithm type.
- An algorithm defined using the **C1-BILLPDRV** algorithm type.
- An algorithm defined using the **C1-BILLRPCR** algorithm type.
- An algorithm defined using the **C1_MEMBGDRV** algorithm type.
- An algorithm defined using the **C1_TIERPREM** algorithm type.
- An algorithm defined using the **C1-FICRETBC** algorithm type.

Procedure

To associate an algorithm with a discount charge pricing rule type:

1. Ensure that the **Algorithms** section is expanded when you are defining or editing the discount charge pricing rule type.

The **Algorithms** section contains the following columns in a grid:

Column Name	Column Description	Mandatory (Yes or No)
System Event	<p>Used to indicate the system event when you want to invoke the algorithm. The valid values are:</p> <ul style="list-style-type: none"> • Account and Price Item Derivation - Used to derive the account and price item for a membership. • Account and Price Item Derivation Post-Processing - Used to derive the bill period for the account. • Account and Price Item Derivation Post-Processing - Used to create the bill period timeline for the account. • Account and Price Item Derivation Post-Processing - Used to derive subscription tier for membership, based on the bill period configured on the account. • Bill Group Derivation - Used to derive the bill group, parent customer, and policy for a membership. • Premium Calculation - Used to calculate the premium for each eligible member person. • Pricing Rule Billable Charge Creation - Used to derive the price items for which you can create the SQI based billable charges using the discount charge pricing rule type. 	Yes
		<p>Note: This field is required when you are associating an algorithm with the discount charge pricing rule type.</p>
Sequence	Used to specify the order in which the algorithms for each system event must be executed.	Yes (Conditional)
		<p>Note: This field is required when you are associating an algorithm with the discount charge pricing rule type.</p>
Algorithm	<p>Used to specify the algorithm.</p> <p>Note:</p> <p>Once you select the system event, the Search (🔍) icon appears corresponding to the Algorithm field. On clicking the Search (🔍) icon, the Algorithm Search window appears.</p> <p>On specifying the algorithm, the description of the algorithm appears corresponding to the Algorithm field.</p>	Yes (Conditional)
		<p>Note: This field is required when you are associating an algorithm with the discount charge pricing rule type.</p>

2. Enter the following details in the **Algorithms** section:

System Event	Algorithm	Algorithm Type	Description
Account and Price Item Derivation	C1_ACCPRIMEM	C1_ACCPRIMEM	Account and PriceItem Derivation for Membership
Account and Price Item Derivation Post-Processing	C1-BILLPDRV	C1-BILLPDRV	Bill Period Derivation

System Event	Algorithm	Algorithm Type	Description
Account and Price Item Derivation Post-Processing	C1-BILLRPCR	C1-BILLRPCR	Bill Period Time Line Creation
Account and Price Item Derivation Post-Processing	C1-DERSUBTR	C1-DERSUBTR	Derive Subscription Tier for Membership
Bill Group Derivation	C1_MEMBGDRV	C1_MEMBGDRV	Bill Group Derivation for Membership
Premium Calculation	C1_TIERPREM	C1_TIERPREM	Tier Based Premium Calculation
Pricing Rule Billable Charge Creation	C1-FICRETBC	C1-FICRETBC	Fully-Insured Charge creation for Memberships

- If you want to associate more than one algorithm with the discount charge pricing rule type, click the **Add (+)** icon and then repeat step 2.

Note: However, if you want to disassociate an algorithm from the discount charge pricing rule type, click the **Delete (🗑)** icon corresponding to the algorithm.

- Click **Save**.

The algorithms are associated with the discount charge pricing rule type.

Related Topics

For more information on...	See...
How to define an discount charge pricing rule type	Defining a Discount Charge Pricing Rule Type on page 3097
How to edit an discount charge pricing rule type	Editing a Discount Charge Pricing Rule Type on page 3107

Adding a Price Item in a Discount Charge Pricing Rule Type

Prerequisites

To add a price item in a discount charge pricing rule type, you should have:

- Price item defined in the application
- Rate option defined in the **Rate Option (C1-ExtLookRefTypeRateOpt)** extendable lookup
- Values defined for the **Invoice Type (C1INVTYP)** characteristic type
- The **C1INVTYP** characteristic type set in the **Invoice Type Characteristic Type** option type of the **C1-ASOBLLNG** feature configuration
- Rule types defined in the application (where the rule type usage is set to **Price Item Eligibility**)

Procedure

To add a price item in a discount charge pricing rule type:

1. Ensure that the **Price Items** section is expanded when you are defining or editing a discount charge pricing rule type.

The **Price Items** section contains the following fields in a grid:

Field Name	Field Description	Mandatory (Yes or No)						
Price Item	<p>Used to indicate the price item that you want to include in the discount charge pricing rule type.</p> <p>Note:</p> <p>The Search (🔍) icon appears corresponding to the Price Item field. On clicking the Search icon, the Price Item Search window appears.</p> <p>On specifying the price item, the description of the price item appears corresponding to the Price Item field.</p>	<p>Yes (Conditional)</p> <p>Note: This field is required when you are adding a rate option and bill to account in a discount charge pricing rule type.</p>						
Rate Option	<p>Used to indicate one or more rate options which are valid for a price item.</p> <p>On clicking the Add (➕) icon, the following field appears in a grid:</p> <table border="1" data-bbox="516 762 1219 991"> <thead> <tr> <th data-bbox="516 762 656 875">Field Name</th> <th data-bbox="656 762 1078 875">Field Description</th> <th data-bbox="1078 762 1219 875">Mandatory (Yes or No)</th> </tr> </thead> <tbody> <tr> <td data-bbox="516 875 656 991">Rate Option</td> <td data-bbox="656 875 1078 991">Used to indicate the rate option that you want to use while defining pricing for the price item.</td> <td data-bbox="1078 875 1219 991">Yes</td> </tr> </tbody> </table> <p>Note:</p> <p>If you want to define more than one rate option to the price item in a discount charge pricing rule type, click the Add (➕) icon.</p> <p>However, if you want to remove a price item from a discount charge pricing rule type, click the Delete (🗑️) icon corresponding to the Rate Option field.</p>	Field Name	Field Description	Mandatory (Yes or No)	Rate Option	Used to indicate the rate option that you want to use while defining pricing for the price item.	Yes	Not applicable
Field Name	Field Description	Mandatory (Yes or No)						
Rate Option	Used to indicate the rate option that you want to use while defining pricing for the price item.	Yes						

Field Name	Field Description	Mandatory (Yes or No)									
Bill To Account	<p>Used to indicate a order in which the account should be considered while deriving a transaction leg.</p> <p>On clicking the Add (+) icon, the following fields appear in a grid:</p> <table border="1"> <thead> <tr> <th>Field Name</th> <th>Field Description</th> <th>Mandatory (Yes or No)</th> </tr> </thead> <tbody> <tr> <td>Priority</td> <td>Used to specify the order in which the invoice type is considered for a price item.</td> <td>Yes</td> </tr> <tr> <td>Invoice Type</td> <td>Used to indicate the type which is considered for billing. For more information, refer to the <i>Bill Group's Account</i> on page 65 section.</td> <td>Yes</td> </tr> </tbody> </table> <p>Note: The Search (🔍) icon appears corresponding to the Invoice Type field. On clicking the Search icon, the Invoice Type Search window appears.</p> <p>Note: If you want to define more than one invoice type to the price item in a discount charge pricing rule type, click the Add (+) icon. However, if you want to remove a invoice type from the price item in a discount charge pricing rule type, click the Delete (🗑) icon corresponding to the Priority field.</p>	Field Name	Field Description	Mandatory (Yes or No)	Priority	Used to specify the order in which the invoice type is considered for a price item.	Yes	Invoice Type	Used to indicate the type which is considered for billing. For more information, refer to the <i>Bill Group's Account</i> on page 65 section.	Yes	Not applicable
Field Name	Field Description	Mandatory (Yes or No)									
Priority	Used to specify the order in which the invoice type is considered for a price item.	Yes									
Invoice Type	Used to indicate the type which is considered for billing. For more information, refer to the <i>Bill Group's Account</i> on page 65 section.	Yes									
Eligibility Rule Type	Used to indicate the rule type (which indicates the rules) that should be executed to determine whether the price item is eligible for billing.	No									
Sponsored	<p>Used to indicate that the system should consider the sponsor billing arrangement while creating and billing the charge for the price item.</p> <p>Note: If the Sponsored option is not selected, the system considers retiree billing arrangement while creating and billing the charge for the price item.</p>	No									

- Enter the required details in the **Price Items** section.
- If you want to define more than one price item in a discount charge pricing rule type, click the **Add** (+) icon and then repeat step 2.

Note: However, if you want to remove a price item from a discount charge pricing rule type, click the **Delete** (🗑) icon corresponding to the **Price Item** field.

- Click **Save**.

The price items are added for a discount charge pricing rule type.

Related Topics

For more information on...	See...
How to define a discount charge pricing rule type	Defining a Discount Charge Pricing Rule Type on page 3097
How to edit a discount charge pricing rule type	Editing a Discount Charge Pricing Rule Type on page 3107

Adding a Price Item Parameter in a Discount Charge Pricing Rule Type

Prerequisites

To add a price item parameter in a discount charge pricing rule type, you should have:

- Parameter defined in the application where parameter usage is set to **Price Item**.
- Parameter associated with the price item.

Procedure

To add a price item parameter in a discount charge pricing rule type:

1. Ensure that the **Price Item Parameters** section is expanded when you are defining or editing a discount charge pricing rule type.

The **Price Item Parameters** section contains the following fields in a grid:

Field Name	Field Description	Mandatory (Yes or No)
Price Item Parameter	Used to specify the parameter which you can use while defining a discount charge pricing for the price item.	Yes (Conditional)
	<p>Note:</p> <p>The Search (🔍) icon appears corresponding to the Price Item Parameter field. On clicking the Search (🔍) icon corresponding to the Price Item Parameter field, the Parameter Search window appears.</p> <p>On specifying the parameter, the description of the price item parameter appears corresponding to the Price Item Parameter field.</p>	<p>Note: This field is required when you are adding a price item parameter in a discount charge pricing rule type.</p>

2. Enter the required details in the **Price Item Parameters** section.
3. If you want to add more than one price item parameter in a discount charge pricing rule type, click the **Add** (+) icon and then repeat step 2.

Note: However, if you want to remove a price item parameter from a discount charge pricing rule type, click the **Delete** (🗑️) icon corresponding to the price item parameter.

4. Click **Save**.

The price item parameter is added for a discount charge pricing rule type.

Related Topics

For more information on...	See...
How to define a discount charge pricing rule type	Deleting a Discount Charge Pricing Rule Type on page 3109
How to edit a discount charge pricing rule type	Editing a Discount Charge Pricing Rule Type on page 3107

Defining a Characteristic for a Discount Charge Pricing Rule Type

Prerequisites

To define a characteristic for a discount charge pricing rule type, you should have:

- Characteristic types defined in the application (where the characteristic entity is set to **Pricing Rule Type**)

Procedure

To define a characteristic for a discount charge pricing rule type:

1. Ensure that the **Characteristics** section is expanded when you are defining or editing a discount charge pricing rule type.

The **Characteristics** section contains the following columns in a grid:

Field Name	Field Description	Mandatory (Yes or No)
Characteristic Type	Used to indicate the characteristic type.	Yes (Conditional)
	Note: The list includes only those characteristic types where the characteristic entity is set to Pricing Rule Type .	Note: This field is required when you are defining a characteristic for a discount charge pricing rule type.
Characteristic Value	Used to specify the value for the characteristic type.	Yes (Conditional)
	Note: If you select a predefined characteristic type, the Search (🔍) icon appears corresponding to the Characteristic Value field. On clicking the Search icon, the Predefined Characteristic Search window appears. On specifying the value for a predefined characteristic type, the description of the characteristic value appears corresponding to the Characteristic Value field.	Note: This field is required when you are defining a characteristic for a discount charge pricing rule type.

2. Enter the required details in the **Characteristics** section.
3. If you want to define more than one characteristic for a discount charge pricing rule type, click the **Add** (+) icon and then repeat step 2.

Note: However, if you want to remove a characteristic from a discount charge pricing rule type, click the **Delete** (🗑️) icon corresponding to the characteristic.

4. Click **Save**.

The characteristics are defined for a discount charge pricing rule type.

Related Topics

For more information on...	See...
How to define a discount charge pricing rule type	Defining a Discount Charge Pricing Rule Type on page 3097
How to edit a discount charge pricing rule type	Editing a Discount Charge Pricing Rule Type on page 3107

Adding Elements for Audit in a Discount Charge Pricing Rule Type

Prerequisites

To add elements for audit in a discount charge pricing rule type, you should have:

- Business Object **C1-AuditEventType** defined for the pricing rule type.
- Audit event type defined in the application.

Procedure

To add elements for audit in a discount charge pricing rule type:

1. Ensure that the **Event Management** section is expanded when you are defining or editing a discount charge pricing rule type.

The **Event Management** section contains the following fields in a grid:

Field Name	Field Description	Mandatory (Yes or No)
Audit Event Type	Used to specify the audit event type which you can use while adding elements for audit in a discount charge pricing rule type. Note: The Search (🔍) icon appears corresponding to the Audit Event Type field. On clicking the Search (🔍) icon corresponding to the Audit Event Type field, the Audit Event Type Search window appears. On specifying the audit event type, the description of the audit event type appears corresponding to the Audit Event Type field.	Yes
Element Type	Used to indicate the type of audit element for a discount charge pricing rule type. The valid values are: <ul style="list-style-type: none"> • Business Object Status • Characteristic • Field 	Not applicable

Field Name	Field Description	Mandatory (Yes or No)
Element Name	Used to specify the element name for a discount charge pricing rule type.	Yes
	Note: The Search (🔍) icon appears corresponding to the Element Name field. On clicking the Search (🔍) icon corresponding to the Element Name field, the Audit Event Type Element Name Search window appears.	
Element Value	Used to specify the value for an element name.	Yes
	Note: If you select either Business Object Status or Characteristic option from the Element Type list, the Search (🔍) icon appears corresponding to the Element Value field. On clicking the Search (🔍) icon corresponding to the Element Value field, the Audit Event Type Element Value Search window appears.	

- Enter the required details in the **Event Management** section.
- If you want to add more than one element for audit in a discount charge pricing rule type, click the **Add** (+) icon and then repeat step 2.

Note: However, if you want to remove an element for audit from a discount charge pricing rule type, click the **Delete** (🗑) icon corresponding to the **Audit Event Type** field.

- Click **Save**.

The elements for audit are added for a discount charge pricing rule type.

Related Topics

For more information on...	See...
How to define a discount charge pricing rule type	Defining a Discount Charge Pricing Rule Type on page 3097
How to edit a discount charge pricing rule type	Editing a Discount Charge Pricing Rule Type on page 3107

Editing a Discount Charge Pricing Rule Type

Prerequisites

To edit a discount charge pricing rule type, you should have:

- Discount charge pricing rule type business object defined in the application.
- Discount charge pricing rule business object defined in the application.

Procedure

To edit a discount charge pricing rule type:

- Click the **Admin** link in the **Application** toolbar.

A list appears.

- From the **Admin** menu, select **P** and then click **Pricing Rule Type**.

A sub-menu appears.

- Click the **Search** option from the **Pricing Rule Type** sub-menu.

The **Pricing Rule Type** screen appears.

- In the **Pricing Rule Type List** zone, click the **Edit**  icon in the **Edit** column corresponding to the pricing rule type whose details you want to edit.

The **Discount Charge Pricing Rule Type** screen appears. It contains the following sections:

- **Main** – Used to specify basic details about a discount charge pricing rule type.
- **Algorithms** – Used to associate the algorithms with a discount charge pricing rule type.
- **Price Items** – Used to add the price items for which you can define the pricing rules using the discount charge pricing rule type.
- **Price Item Parameters** – Used to add the price item parameters based on which you want to define the price item pricing.
- **Characteristics** – Used to define the characteristics for a discount charge based pricing rule type.
- **Event Management** – Used to configure the audit in a discount charge based pricing rule type.

The **Main** section contains the following fields:

Field Name	Field Description	Mandatory (Yes or No)
Pricing Rule Type	Displays the discount charge pricing rule type.	Not applicable
Description	Used to specify the description for the discount charge pricing rule type.	Yes
Detailed Description	Used to specify the additional information about the discount charge pricing rule type.	No
Pricing Rule Business Object	Used to indicate the business object using which you want to create the discount charge pricing rule type. The valid value is: <ul style="list-style-type: none"> • Discount Charge Pricing Rule 	Yes
Business Object	Indicates the business object using which you are defining the discount charge pricing rule type.	Not applicable
Status	Used to indicate the status of discount charge pricing rule type. The valid values are: <ul style="list-style-type: none"> • Active • Inactive 	Yes
Primary	Used to select whether the discount charge pricing rule type is a primary pricing rule type.	No
	Note: You must not select the Primary option while editing the discount charge pricing rule type.	

Field Name	Field Description	Mandatory (Yes or No)
Pricing Rule Type Category	Indicates the pricing rule type category for a discount charge pricing rule type. The valid value is: <ul style="list-style-type: none"> Discount Charge 	No
Pricing Rule Type Sub Category	Used to indicate the pricing rule type sub category for the discount charge pricing rule type. The valid values are: <ul style="list-style-type: none"> Per Member Per Subscriber 	No
	Note: You must select the Per Subscriber option while defining the discount charge pricing rule type.	

Tip: Alternatively, you can edit the details of a discount charge pricing rule type by clicking the **Edit** button in the **Pricing Rule Type** zone.

- Modify the details in the **Main** section.
- Associate the required algorithms in a discount charge pricing rule type.
- Add, edit, or remove the required price items in a discount charge pricing rule type.
- Add, edit, or remove the price item parameters in a discount charge pricing rule type, if required.
- Add, edit, or remove characteristics for a discount charge pricing rule type, if required.
- Add, edit, or remove the configuration details of the audit in a discount charge pricing rule type.
- Click **Save**.

The changes made to the discount charge pricing rule type are saved.

Related Topics

For more information on...	See...
How to associate algorithms with a discount charge pricing rule type	Associating an Algorithm with a Discount Charge Pricing Rule Type on page 3099
How to add price items in a discount charge pricing rule type	Adding a Price Item in a Discount Charge Pricing Rule Type on page 3101
How to add price item parameters in a discount charge pricing rule type	Adding a Price Item Parameter in a Discount Charge Pricing Rule Type on page 3104
How to define a characteristic for a discount charge pricing rule type	Defining a Characteristic for a Discount Charge Pricing Rule Type on page 3105
How to add elements for audit in a discount charge pricing rule type	Adding Elements for Audit in a Discount Charge Pricing Rule Type on page 3106

Deleting a Discount Charge Pricing Rule Type

Procedure

To delete a discount charge pricing rule type:

- Click the **Admin** link in the **Application** toolbar.

A list appears.

- From the **Admin** menu, select **P** and then click **Pricing Rule Type**.

A sub-menu appears.

- Click the **Search** option from the **Pricing Rule Type** sub-menu.

The **Pricing Rule Type** screen appears.

- In the **Pricing Rule Type List** zone, click the **Delete** (🗑️) icon in the **Delete** column corresponding to the discount charge pricing rule type that you want to delete.

A message appears confirming whether you want to delete the discount charge pricing rule type.

Note: You can delete a discount charge pricing rule type when it is not yet used in the system.

Tip: Alternatively, you can delete a discount charge pricing rule type by clicking the **Delete** button in the **Pricing Rule Type** zone.

- Click **OK**.

The discount charge pricing rule type is deleted.

Related Topics

For more information on...	See...
Pricing Rule Type screen	Pricing Rule Type on page 2532
Pricing Rule Type List zone	Pricing Rule Type List on page 2533
Pricing Rule Type zone	Pricing Rule Type on page 2536

Viewing the Discount Charge Pricing Rule Type Details

Procedure

To view the details of a discount charge pricing rule type:

- Click the **Admin** link in the **Application** toolbar.

A list appears.

- From the **Admin** menu, select **P** and then click **Pricing Rule Type**.

A sub-menu appears.

- Click the **Search** option from the **Pricing Rule Type** sub-menu.

The **Pricing Rule Type** screen appears.

- In the **Pricing Rule Type List** zone, click the

Broadcast (📡) icon corresponding to the discount charge pricing rule type whose details you want to view.

The **Pricing Rule Type** zone appears.

- View the details of the a discount charge pricing rule type in the **Pricing Rule Type** zone.

Related Topics

For more information on...	See...
Pricing Rule Type screen	Pricing Rule Type on page 2532
Pricing Rule Type List zone	Pricing Rule Type List on page 2533



For more information on...	See...
Pricing Rule Type zone	Pricing Rule Type on page 2536

Viewing the Discount Charge Pricing Rule Details

Procedure

To view the details of a discount charge pricing rule:

1. Do either of the following:

If you want to...	Then...
View the discount charge pricing rule for a Fully-Insured Individual Membership	<ol style="list-style-type: none"> 1. Search for the fully-insured individual membership in the Customer 360° View screen. 2. In the Search Results section, click the View () icon corresponding to the fully-insured individual whose pricing rule details you want to view. The Policy tab appears in the Customer 360° Information screen.
View the discount charge pricing rule for a Fully-Insured Group Membership	<ol style="list-style-type: none"> 1. Search for the fully-insured group membership in the Customer 360° View screen. 2. In the Search Results section, click the View () icon corresponding to the fully-insured group membership whose pricing rule details you want to view. The Policy tab appears in the Customer 360° Information screen.

2. Click the **Pricing Information** tab.

The **Pricing Information** tab appears.

3. In the **Fully-Insured Pricing Rules** zone, click the link in the **Pricing Rule Information** column corresponding to the fully-insured pricing rule type whose details you want to view.

The **Pricing Rule (Discount Charge)** screen appears. It contains the following zone:

- **Discount Charge Pricing Rule** – Displays the discount charge pricing rule details for an individual membership. It contains the following sections:
 - **Pricing Information** – Displays the basic details about the discount charge pricing rule.
 - **Pricing Parameters** – Displays the pricing parameters defined for the discount charge pricing rule.
 - **Characteristics** – Displays the characteristics defined for the discount charge pricing rule.

4. View the basic details of the discount charge pricing rule in the **Pricing Information** section.
5. View the pricing parameters defined for the discount charge pricing rule in the **Pricing Parameters** section.
6. View the characteristics of the discount charge pricing rule in the **Characteristics** section.

Related Topics

For more information on...	See...
Customer 360° View screen	Customer 360° View on page 639

For more information on...	See...
Person tab	Customer 360° Information - Person on page 663
Pricing Information tab	Customer 360° Information - Pricing Information on page 693
Fully-Insured Pricing Rules zone	Fully-Insured Pricing Rules on page 708
Discount Charge Pricing Rule zone	Discount Charge Pricing Rule on page 3095

Pricing Rule Inactivation

Earlier, you were not able to inactivate a pricing rule which is referred by a group or individual membership for the charge calculation. Now, the system enables you to change the status of the age based, tier based, additional charge, and discount charge pricing rules from **Active** to **Inactive** even when it is referred by a membership for the charge calculation. On inactivating a pricing rule, the system creates an audit event in the system.

A new batch named **Process Inactivated Fully-Insured Pricing Rule (C1-CBIPR)** is introduced in this release. You must execute the **Process Inactivated Fully-Insured Pricing Rule (C1-CBIPR)** batch in between the following batches - **Audit Event Process Monitor (C1-AUDEV)** and **Identify Entities for Repricing (C1-REPC1)**. The **Process Inactivated Fully-Insured Pricing Rule (C1-CBIPR)** batch considers the repricing entity details records from the **CI_REPRC_ENTITY_DTL** table which are in the **Discard** status due to pricing rule inactivation. It then cancels the billable charges and bill segments (if any) which are created using the pricing rule which you have inactivated. In addition, it changes the status of the records in the **CI_PRCE_CALC** table to **I** where the inactivated pricing rule is referred.

If you inactivate a primary pricing rule, the system will cancel the billable charges and bill segments (if any) which are created using the related pricing rules. If you inactivate a rate guarantee pricing rule, the system will cancel the billable charges and bill segments (if any) which are created using the rate guarantee pricing rule.

Chapter 38

Fully-Insured Group Billing

Topics:

- [Audit Framework for Fully-Insured Group Health Insurance Billing](#)
- [Premium Proration Rules](#)
- [Age Monitoring](#)
- [State of Issue](#)
- [Membership Premium Calculation](#)
- [Bill Group Derivation for Membership](#)
- [Account and Price Item Derivation for Membership](#)
- [Bill Cycle and Bill Period Derivation](#)
- [Bill Period Timeline](#)
- [9/10 Billing \(Skip Months\)](#)
- [Repricing](#)
- [Fully-Insured Group Billable Charge Creation](#)
- [Repricing Request](#)
- [Membership Premium Calculation Through Inbound Web Service](#)

This chapter explains how the billing is done for fully-insured group health insurance business in Oracle Revenue Management and Billing. It contains the following topics:

- Audit Framework for Fully-Insured Group Health Insurance Billing
- Premium Proration Rules
- Age Monitoring
- State of Issue
- Membership Premium Calculation
- Bill Group Derivation for Membership
- Account and Price Item Derivation for Membership
- Bill Cycle and Bill Period Derivation
- Bill Period Timeline
- 9/10 Billing (Skip Months)
- Repricing
- Fully-Insured Group Billable Charge Creation
- Repricing Request
- Membership Repricing through Inbound Web Service

Related Topics

For more information on...	See...
Audit Framework for Fully-Insured Group Health Insurance Billing	Audit Framework for Fully-Insured Group Health Insurance Billing on page 3115
Premium Proration Rules	Premium Proration Rules on page 3128
Age Monitoring	Age Monitoring on page 3130
State of Issue	State of Issue on page 3131
Membership Premium Calculation	Membership Premium Calculation on page 3132
Bill Group Derivation for Membership	Bill Group Derivation for Membership on page 3137

For more information on...	See...
Account and Price Item Derivation for Membership	<i>Account and Price Item Derivation for Membership</i> on page 3140
Bill Cycle and Bill Period Derivation	<i>Bill Cycle and Bill Period Derivation</i> on page 3140
Bill Period Timeline	<i>Bill Period Timeline</i> on page 3141
9/10 Billing (Skip Months)	<i>9/10 Billing (Skip Months)</i> on page 3141
Repricing	<i>Repricing</i> on page 3142
Fully-Insured Group Billable Charge Creation	<i>Fully-Insured Group Billable Charge Creation</i> on page 3143
Repricing Request	<i>Repricing Request</i> on page 3145
Membership Premium Calculation through Inbound Web Service	<i>Membership Premium Calculation Through Inbound Web Service</i> on page 3152

Audit Framework for Fully-Insured Group Health Insurance Billing

Oracle Revenue Management and Billing calculates the membership premium when you add a membership to a policy plan. It also enables you to recalculate the membership premium in the following scenarios:

- A member person is added or removed from the membership.
- The fields, characteristics, or statuses which are monitored for the auditing purposes are updated at the membership, member person, or pricing rule level.
- A pricing rule is added or updated for the policy plan.
- The derivation and pricing parameters are defined or updated for a bill group.

The membership premium calculation and recalculation (i.e. repricing) is implemented using the **Entity Audit** feature. The entity audit framework is already configured for the following business objects:

- C1-Membership
- C1_PERSON_BO
- C1-PricingRuleTierBased
- C1-PricingRuleAgeBased
- C1-BillLevel

To configure the entity audit framework for the above listed business objects, the following changes are made to these business objects:

- The **Eligible for Audit Event** option type is set to **Y** in
- An algorithm created using the **C1-READEVNT** algorithm type is already attached to the **Audit** system event of the **C1-PricingRuleTierBased**, **C1-PricingRuleAgeBased**, and **C1-BillLevel** business objects.
- An algorithm created using the **C1-FIAUDEV** algorithm type is already attached to the **Audit** system event of the **C1-Membership** and **C1_PERSON_BO** business objects.

But, the entity audit framework will work when you define an active audit event type for the above listed business objects. For more information on how to create an audit event type, see [Defining an Audit Event Type](#) on page 3308. While creating an audit event type for the **C1-PricingRuleTierBased** and **C1-PricingRuleAgeBased** business objects, you need to attach an algorithm created using the **C1-AUDEVMPR** algorithm type to the **Audit Event Processing** system event of the respective audit event type. And, while creating an audit event type for the **C1-BillLevel** business object, you need to attach an algorithm created using the **C1-AUDBILLVL** algorithm type to the **Audit Event Processing** system event of the audit event type.

In addition, you need to list the following in the pricing rule types where the category is set to **Age Based** and **Tier Based**:

- Audit event types of the **C1-Membership** and **C1_PERSON_BO** business objects using which the audit event should be created whenever a membership and member person is added, updated, or removed from the policy plan, respectively.
- Elements of the **C1-Membership** and **C1_PERSON_BO** business objects for which auditing is required.

Note:

At present, you cannot use an audit event type of the **C1-Membership** and **C1_PERSON_BO** business objects in the **Age Based** and **Tier Based** pricing rule types when the **Update All** option is selected in the audit event type. Therefore, we recommend you to select an audit event type of the **C1-Membership** and **C1_PERSON_BO** business objects where the **Update All** option is not selected.

The system creates an audit event whenever the membership start and end dates and member person's start and end dates are changed in the system irrespective of whether these fields are listed for auditing or not in the age based or tier based pricing rule types.

You can also configure the entity audit feature for any custom membership or person business objects.

The way in which the audit events are created and processed for a pricing rule, membership, and member person is different. While creating an audit event, the system checks whether an audit event for the entity with the same effective date already exists in the **Pending** status. If so, the system does not create a new audit event for the entity. Instead, the system adds a log in the existing audit event.

Related Topics

For more information on...	See...
How the audit events are created and processed for an age based or tier based pricing rule	Age Based and Tier Based Pricing Rules Audit Process on page 3116
How the audit events are created and processed for a membership	Membership Audit Process on page 3117
How the audit events are created and processed for a person	Person Audit Process on page 3123
How the audit events are created and processed for the derivation and pricing parameters of a bill group	Bill Group Derivation and Pricing Parameters Audit Process on page 3125

Age Based and Tier Based Pricing Rules Audit Process

If you add or edit an age based or tier based pricing rule, the system checks whether an active audit event type exists for the **C1-PricingRuleAgeBased** or **C1-PricingRuleTierBased** business object, respectively. If an active audit event type exists for the business object, the system creates an audit event for the pricing rule using the audit event type. The audit event is created in the **Pending** status. Note that the system creates one audit event for the pricing rule irrespective of the number of changes made to the pricing rule. In addition, an effective date is stamped corresponding to the audit event which later helps in deriving the timeline during premium calculation. Note that the effective date is set to the pricing rule's start date.

On executing the **Audit Event Process Monitor (C1-AUDEV)** batch, the system considers the audit events in the **Pending** or **Error** status. By default, it considers the audit events in the **Pending** status. The system checks whether the **C1-AUDEVMPR** algorithm is attached to the respective audit event type. If the **C1-AUDEVMPR** algorithm is attached to the audit event type, it identifies the policy plan where the pricing rule is defined. Once the policy plan is identified, it extracts a list of membership defined on the policy plan and the pricing rule type using which the pricing rule is created. Then, the system creates a repricing entity detail record for each membership, pricing rule type, and effective date combination in the **CI_REPRC_ENTITY_DTL** table. The status of the repricing entity detail record is set to **P**.

For example, an audit event is created while adding the following pricing rule:

Audit Event	AE1	AE2
Pricing Rule	PR1	PR2
Pricing Rule Type Using which the Pricing Rule is Created	PRT1	PRT3

Pricing Rule Start Date	01-01-2019	01-01-2019
Policy Plan for which the Pricing Rule is Defined	PP1	PP2
Pricing Rule Types Associated with the Policy Plan	PRT1, PRT2, PRT3	PRT3
Memberships which Belong to the Policy Plan	M1, M2, M3, and M4	M11 and M12

For the AE1 audit event, the system creates four repricing entity detail records with the following combinations in the **CI_REPRC_ENTITY_DTL** table:

- M1, PRT1, 01-01-2019
- M2, PRT1, 01-01-2019
- M3, PRT1, 01-01-2019
- M4, PRT1, 01-01-2019

And, for the AE2 audit event, the system creates two repricing entity detail records with the following combinations in the **CI_REPRC_ENTITY_DTL** table:

- M11, PRT3, 01-01-2019
- M12, PRT3, 01-01-2019

Once the repricing entity detail records are created successfully, the status of the audit event is set to **Complete**. However, if an error occurs while creating the repricing entity detail records for an audit event, the status of the audit event is set to **Error**.

Membership Audit Process

If you add or edit a membership, the system checks whether an active audit event type exists for the **C1-Membership** business object. If an active audit event type exists for the business object, the system creates the audit event using the audit event type. The system creates the audit event whenever a membership is added to a policy plan and dependent member person is added to a membership. It also creates the audit event whenever the membership and member person details are updated. However, note that the audit events are created in the update scenario when the element listed for auditing in the age based or tier based pricing rule types is updated. The system considers only those pricing rule types whose pricing rules are effective during the respective entity (i.e. membership or member person whichever is updated) date range.

The audit event is created in the **Pending** status. An effective date is stamped corresponding to the audit event which later helps in deriving the timeline during premium calculation. Note that the system creates distinct audit events in the following scenarios:

Scenario	System Behavior
A membership is added to a policy plan	<p>One audit event is created for the membership. Here, the effective date in the audit event is set to the membership's start date.</p> <p>For example, two memberships named M1 (with the start date as 01-01-2020) and M2 (with the start date as 01-15-2020) are added to a policy plan named PP1. In such case, the system will create two audit events — one for M1 with the effective date as 01-01-2020 and another for M2 with the effective date as 01-15-2020.</p>

Scenario	System Behavior
A dependent member person is added to a membership	<p>One audit event is created for the membership. Here, the effective date in the audit event is set to the dependent member person's start date.</p> <p>For example, one dependent member person named MP1 (with the start date as 06-05-2020) is added to the M1 membership and another dependent member person named MP2 (with the start date as 06-10-2020) is added to the M2 membership. In such case, the system will create two audit events — one for M1 with the effective date as 06-05-2020 and another for M2 with the effective date as 06-10-2020.</p>
A dependent member person is removed from a membership	<p>One audit event is created for the membership. Here, the effective date in the audit event is set to the dependent member person's start date.</p> <p>For example, one dependent member person named MP4 (with the start date as 9-15-2020) is removed from the M1 membership. In such case, the system will create one audit event for M1 with the effective date as 9-15-2020.</p>
A membership is added to a policy plan along with a dependent member person	<p>Multiple audit events are created for the membership – one where the effective date is set to membership's start date, another where the effective date is set to dependent member person's start date, and third where the effective date is set to dependent member person's end date +1 Day. Note that the second audit event is created when the dependent member person's start date is later than membership's start date. And, the third audit event is created when the dependent member person's end date is earlier than membership's end date.</p> <p>For example, one membership named M1 (with the start date as 01-01-2020 and end date as 12-31-2020) is added with two member persons — MP1 who is a main subscriber and MP2 (with the start date as 03-01-2020 and end date as 10-31-2020) who is a dependent member person. In such case, the system will create three audit events for M1 — one with the effective date as 01-01-2020, another with the effective date as 03-01-2020, and third with the effective date as 11-01-2020 (i.e. 10-31-2020 + 1 Day).</p>

Scenario	System Behavior																				
<p>Membership characteristics are added or updated in the system</p>	<p>Multiple audit events are created for the membership – one for each set of membership characteristics with the same effective date. Here, the effective date in the audit event is set to the date from when the membership’s characteristic is effective.</p> <p>For example, the following characteristics are added or updated for the M1 membership:</p> <table border="1" data-bbox="732 436 1463 848"> <thead> <tr> <th>Characteristic</th> <th>Effective Date</th> <th>Action</th> </tr> </thead> <tbody> <tr> <td>Maximum Number of Dependents</td> <td>9-15-2020</td> <td>Add</td> </tr> <tr> <td>Age Calculation Date Basis</td> <td>9-20-2020</td> <td>Edit</td> </tr> <tr> <td>Young Adult Max Age Limit</td> <td>9-15-2020</td> <td>Add</td> </tr> <tr> <td>Young Adult Inclusion Applicability</td> <td>9-20-2020</td> <td>Edit</td> </tr> </tbody> </table> <p>In such case, the system will create two audit events for M1 — one with the effective date as 9-15-2020 and another with the effective date as 9-20-2020.</p>	Characteristic	Effective Date	Action	Maximum Number of Dependents	9-15-2020	Add	Age Calculation Date Basis	9-20-2020	Edit	Young Adult Max Age Limit	9-15-2020	Add	Young Adult Inclusion Applicability	9-20-2020	Edit					
Characteristic	Effective Date	Action																			
Maximum Number of Dependents	9-15-2020	Add																			
Age Calculation Date Basis	9-20-2020	Edit																			
Young Adult Max Age Limit	9-15-2020	Add																			
Young Adult Inclusion Applicability	9-20-2020	Edit																			
<p>Member person characteristics are added or updated in the system</p>	<p>Multiple audit events are created for the membership – one for each set of member person’s characteristics with the same effective date. Here, the effective date in the audit event is set to the date from when the member person’s characteristic is effective.</p> <p>For example, the following characteristics are added or updated for the member persons in the M1 membership:</p> <table border="1" data-bbox="732 1220 1463 1757"> <thead> <tr> <th>Member Person</th> <th>Characteristic</th> <th>Effective Date</th> <th>Action</th> </tr> </thead> <tbody> <tr> <td>MP1</td> <td>Maximum Number of Dependents</td> <td>9-15-2020</td> <td>Add</td> </tr> <tr> <td>MP1</td> <td>Age Calculation Date Basis</td> <td>9-20-2020</td> <td>Edit</td> </tr> <tr> <td>MP2</td> <td>Young Adult Max Age Limit</td> <td>9-15-2020</td> <td>Add</td> </tr> <tr> <td>MP2</td> <td>Young Adult Inclusion Applicability</td> <td>9-20-2020</td> <td>Edit</td> </tr> </tbody> </table> <p>In such case, the system will create two audit events for M1 — one with the effective date as 9-15-2020 and another with the effective date as 9-20-2020.</p>	Member Person	Characteristic	Effective Date	Action	MP1	Maximum Number of Dependents	9-15-2020	Add	MP1	Age Calculation Date Basis	9-20-2020	Edit	MP2	Young Adult Max Age Limit	9-15-2020	Add	MP2	Young Adult Inclusion Applicability	9-20-2020	Edit
Member Person	Characteristic	Effective Date	Action																		
MP1	Maximum Number of Dependents	9-15-2020	Add																		
MP1	Age Calculation Date Basis	9-20-2020	Edit																		
MP2	Young Adult Max Age Limit	9-15-2020	Add																		
MP2	Young Adult Inclusion Applicability	9-20-2020	Edit																		

Scenario	System Behavior
A set of membership fields except membership start and end dates is updated in the system	<p>One audit event is created for the membership. Here, the effective date in the audit event is set to the membership's start date.</p> <p>For example, the external membership ID of the M1 membership (with the start date as 9-15-2020) is changed. In such case, the system will create one audit event for M1 with the effective date as 9-15-2020.</p>
The membership start date is updated in the system	<p>One audit event is created for the membership. Here, the effective date in the audit event is set to the membership's new start date.</p> <p>For example, the start date of the M1 membership is changed from 9-15-2020 to 9-20-2020. In such case, the system will create one audit event for M1 with the effective date as 9-20-2020.</p>
The membership end date is updated in the system	<p>One audit event is created for the membership. Here, the effective date in the audit event is set to membership's new end date.</p> <p>For example, the end date of the M1 membership is changed from 12-31-2020 to 11-30-2020. In such case, the system will create one audit event for M1 with the effective date as 11-30-2020.</p>
A set of member person's fields except member person start and end dates is updated in the system	<p>One audit event is created for the membership. Here, the effective date in the audit event is set to the member person's start date.</p> <p>For example, the relationship type and status of the MP1 member person (with the start date as 01-01-2020) in the M1 membership is changed. In such case, the system will create one audit event for M1 with the effective date as 01-01-2020.</p>
The dependent member person's start date is updated in the system	<p>Three audit events are created for the membership – one where the effective date is set to the dependent member person's previous start date, another where the effective date is set to the dependent member person's new start date, and third where the effective date is set to dependent member person's end date + 1 Day. However, if the derived effective date is later than the membership end date, the system does not create the third audit event for the membership. In such scenario, it simply creates first two audit events.</p> <p>For example, the Mike's effective date range is changed from 04-01-2019 – 09-30-2019 to 01-15-2019 – 09-30-2019 in the M1 membership which is effective from 01-01-2019 to 12-31-2019. In such case, the system will create three audit events for M1 – one with effective date as 04-01-2019, another with effective date as 01-15-2019, and third with effective date as 10-01-2019 (i.e. 09-30-2019 + 1 Day).</p> <p>In addition, if there is a characteristic for the person whose effective date falls with the new enrollment date range, the system creates an audit event for the person where the effective date is set to characteristic's effective date. Note that the system considers those effective characteristics where the characteristic entity is set to Person. Let us assume that in the above example a characteristic for Mike was effective from 02-01-2019. In such case, the system creates three audit events for the M1 membership (with the effective dates as mentioned above) and one audit event for the person (i.e. Mike) where the effective date is set to 02-01-2019.</p>

Scenario	System Behavior
<p>The dependent member person's end date is updated in the system</p>	<p>Two audit events are created for the membership – one where the effective date is set to dependent member person's previous end date + 1 Day and another where the effective date is set to dependent member person's new end date + 1 Day. However, if the derived effective date is later than the membership end date, the system does not create the second audit event for the membership. In such scenario, it simply creates the first audit event.</p> <p>For example, the Garry's effective date range is changed from 04-01-2019 – 09-30-2019 to 04-01-2019 – 12-31-2019 in the M1 membership which is effective from 01-01-2019 to 12-31-2019. In such case, the system will create one audit event for M1 with the effective date as 10-01-2019 (i.e. 09-30-2019 + 1 Day). It will not create another audit event for M1 because the derived effective date (i.e. 12-31-2019 + 1 Day = 01-01-2020) is later than membership end date (i.e. 12-31-2019).</p> <p>In addition, if there is a characteristic for the person whose effective date falls with the new enrollment date range, the system creates an audit event for the person where the effective date is set to characteristic's effective date. Note that the system considers those effective characteristics where the characteristic entity is set to Person. Let us assume that in the above example a characteristic for Garry was effective from 11-01-2019. In such case, the system creates one audit event for M1 membership (with the effective date as mentioned above) and another audit event for the person (i.e. Garry) where the effective date is set to 11-01-2019.</p>

Scenario	System Behavior
<p>The dependent member person's start and end dates are updated in the system</p>	<p>Four audit events are created for the membership – one where the effective date is set to the dependent member person's previous start date, another where the effective date is set to the dependent member person's new start date, third where the effective date is set to dependent member person's previous end date + 1 Day, and fourth where the effective date is set to dependent member person's new end date + 1 Day. However, if the derived effective date is later than the membership end date, the system does not create the fourth audit event for the membership. In such scenario, it simply creates the first three audit events.</p> <p>For example, the Juliet's effective date range is changed from 04-01-2019 – 09-30-2019 to 01-01-2019 – 11-30-2019 in the M1 membership which is effective from 01-01-2019 to 12-31-2019. In such case, the system will create four audit events for M1 – one with effective date as 04-01-2019, another with effective date as 01-01-2019, third with effective date as 10-01-2019 (i.e. 09-30-2019 + 1 Day), and fourth with effective date as 12-01-2019 (i.e. 11-30-2019 + 1 Day).</p> <p>In addition, if there is a characteristic for the person whose effective date falls with the new enrollment date range, the system creates an audit event for the person where the effective date is set to characteristic's effective date. Note that the system considers those effective characteristics where the characteristic entity is set to Person. Let us assume that in the above example two characteristics of Juliet were effective from 03-01-2019 and 10-01-2019, respectively. In such case, the system creates four audit events for M1 membership (with the effective dates as mentioned above), fifth audit event for the person (i.e. Juliet) where the effective date is set to 03-01-2019, and sixth audit event for the person (i.e. Juliet) where the effective date is set to 10-01-2019.</p>

For each audit event, the system identifies the policy plan to which the membership belongs and the active pricing rules defined on the policy plan. It then identifies the pricing rule types using which these active pricing rules are created in the system. A repricing entity detail record is created for each membership, pricing rule type, and effective date combination in the **CI_REPRC_ENTITY_DTL** table. The status of the repricing entity detail record is set to **P**.

For example, an audit event is created while adding the following memberships:

Audit Event	AE11	AE12
Membership	M1	M2
Membership Start Date	01-03-2019	01-02-2019
Policy Plan to which Membership Belongs	PP11	PP12
Pricing Rules Defined on the Policy Plan	PR1 (Using PRT1), PR2 (Using PRT2), PR3 (Using PRT3)	PR11 (Using PRT1), PR13 (Using PRT2)
Pricing Rule Types Associated with the Policy Plan	PRT1, PRT2, PRT3	PRT1, PRT2

For the AE11 audit event, the system creates three repricing entity detail records with the following combinations in the **CI_REPRC_ENTITY_DTL** table:

- M1, PRT1, 01-03-2019
- M1, PRT2, 01-03-2019
- M1, PRT3, 01-03-2019

And, for the AE12 audit event, the system creates two repricing entity detail records with the following combinations in the **CI_REPRC_ENTITY_DTL** table:

- M2, PRT1, 01-02-2019
- M2, PRT2, 01-02-2019

Note: If the audit event's effective date is earlier than the member person's start date, the system sets the effective date in the repricing entity detail record to the member person's start date. Therefore, in such scenarios, the effective date of the audit event and repricing entity detail records will be different.

Once the repricing entity detail records are created successfully, the status of the audit event is set to **Complete**. However, if an error occurs while creating the repricing entity detail records for an audit event, the status of the audit event is set to **Error**.

Person Audit Process

If you add or edit a person, the system checks whether an active audit event type exists for the **C1_PERSON_BO** business object. If an active audit event type exists for the business object, the system creates an audit event for the person using the audit event type. The audit event is created in the **Pending** status. An effective date is stamped corresponding to the audit event which later helps in deriving the timeline during premium calculation. Note that the system creates distinct audit events in the following scenarios:

Scenario	System Behavior																
Person fields are updated in the system.	<p>One audit event is created for the person. Here, the effective date in the audit event is set to the member person's start date.</p> <p>For example, the following person identifier type is defined for MP1, MP2, and MP3 who are members of the M1 membership:</p> <table border="1" style="width: 100%; border-collapse: collapse;"> <thead> <tr> <th>Member Person</th> <th>Member Person Start Date</th> <th>Person Identifier Type</th> <th>Person Identifier</th> </tr> </thead> <tbody> <tr> <td>MP1</td> <td>03-10-2020</td> <td>Social Security Number</td> <td>987-65-4320</td> </tr> <tr> <td>MP2</td> <td>03-15-2020</td> <td>Social Security Number</td> <td>987-65-4321</td> </tr> <tr> <td>MP3</td> <td>03-25-2020</td> <td>Social Security Number</td> <td>987-65-4322</td> </tr> </tbody> </table> <p>In such case, the system will create three audit events — one for MP1 with the effective date as 03-10-2020, another for MP2 with the effective date as 03-15-2020, and third for MP3 with the effective date as 03-25-2020.</p>	Member Person	Member Person Start Date	Person Identifier Type	Person Identifier	MP1	03-10-2020	Social Security Number	987-65-4320	MP2	03-15-2020	Social Security Number	987-65-4321	MP3	03-25-2020	Social Security Number	987-65-4322
Member Person	Member Person Start Date	Person Identifier Type	Person Identifier														
MP1	03-10-2020	Social Security Number	987-65-4320														
MP2	03-15-2020	Social Security Number	987-65-4321														
MP3	03-25-2020	Social Security Number	987-65-4322														

Scenario	System Behavior																				
Person characteristics are added or updated in the system.	<p>Multiple audit events are created for the person – one for each set of person characteristics with the same effective date. Here, the effective date in the audit event is set to the date from when the person’s characteristic is effective.</p> <p>For example, the following characteristics are added or updated for the persons who are members of the M1 membership:</p> <table border="1"> <thead> <tr> <th>Member Person</th> <th>Characteristic</th> <th>Effective Date</th> <th>Action</th> </tr> </thead> <tbody> <tr> <td>MP1</td> <td>Marital Status</td> <td>09-15-2020</td> <td>Add</td> </tr> <tr> <td>MP1</td> <td>Garble Data</td> <td>09-20-2020</td> <td>Edit</td> </tr> <tr> <td>MP2</td> <td>Marital Status</td> <td>09-15-2020</td> <td>Add</td> </tr> <tr> <td>MP2</td> <td>Garble Data</td> <td>09-20-2020</td> <td>Edit</td> </tr> </tbody> </table> <p>In such case, the system will create four audit events — one for MP1 with the effective date as 09-15-2020, another for MP1 with the effective date as 09-20-2020, third for MP2 with the effective date as 09-15-2020, and fourth for MP2 with the effective date as 09-20-2020.</p>	Member Person	Characteristic	Effective Date	Action	MP1	Marital Status	09-15-2020	Add	MP1	Garble Data	09-20-2020	Edit	MP2	Marital Status	09-15-2020	Add	MP2	Garble Data	09-20-2020	Edit
Member Person	Characteristic	Effective Date	Action																		
MP1	Marital Status	09-15-2020	Add																		
MP1	Garble Data	09-20-2020	Edit																		
MP2	Marital Status	09-15-2020	Add																		
MP2	Garble Data	09-20-2020	Edit																		

For each audit event, the system identifies the memberships in which the person is added as a member person. It identifies the policy plan to which each membership belongs and the active pricing rules defined on the policy plan. It then identifies the pricing rule types using which these active pricing rules are created in the system. A repricing entity detail record is created for each membership, pricing rule type, and effective date combination in the **CI_REPRC_ENTITY_DTL** table. The status of the repricing entity detail record is set to **P**.

For example, an audit event named AE1 is created while updating the MP1 person:

Audit Event	AE1		
Membership to which MP1 belongs	M1	M2	M3
Member Person’s Start Date	01-01-2019	01-01-2019	01-07-2019
Policy Plan to which Membership Belongs	PP1	PP2	PP3
Pricing Rules Defined on the Policy Plan	PR1 (Using PRT1), PR2 (Using PRT2)	PR3 (Using PRT3), PR4 (Using PRT3)	PR5 (Using PRT5), PR6 (Using PRT6)
Pricing Rule Types Associated with the Policy Plan	PRT1, PRT2	PRT3, PRT4	PRT5, PRT6

For the AE1 audit event, the system creates five repricing entity detail records with the following combinations in the **CI_REPRC_ENTITY_DTL** table:

- M1, PRT1, 01-01-2019
- M1, PRT2, 01-01-2019
- M2, PRT3, 01-01-2019
- M3, PRT5, 01-07-2019
- M3, PRT6, 01-07-2019

Note: If the audit event's effective date is earlier than the member person's start date, the system sets the effective date in the repricing entity detail record to the member person's start date. Therefore, in such scenarios, the effective date of the audit event and repricing entity detail records will be different.

Once the repricing entity detail records are created successfully, the status of the audit event is set to **Complete**. However, if an error occurs while creating the repricing entity detail records for an audit event, the status of the audit event is set to **Error**.

Bill Group Derivation and Pricing Parameters Audit Process

If you add or edit the derivation and pricing parameters for a bill group, the system checks whether an active audit event type exists for the **C1-BillLevel** business object. If an active audit event type exists for the business object, the system creates an audit event for the bill level ID (i.e. bill group and sort ID combination) using the audit event type. The audit event is created in the **Pending** status. Note that the system creates one audit event for a bill group and sort ID combination irrespective of the number of changes made to the bill group and sort ID combination. In addition, an effective date is stamped corresponding to the audit event which later helps in deriving the timeline during premium calculation. Note that the effective date is set to the date from when the derivation and pricing parameters are effective for the bill group and sort ID combination.

For example, a parent customer named PC1 has two bill groups — BG1 and BG2 and the derivation and pricing parameters are edited for the following combinations:

Bill Group	Sort ID	Effective Date	Action
BG1	10	01-01-2019	Edit
BG1	20	07-01-2019	Add
BG2	10	01-01-2019	Edit
BG2	20	05-01-2019	Add

In such case, the system will create four audit events — one for BG1 and 10 combination with the effective date as 01-01-2019, another for BG1 and 20 combination with the effective date as 07-01-2019, third for BG2 and 10 combination with the effective date as 01-01-2019, and fourth for BG2 and 20 combination with the effective date as 05-01-2019.

On executing the **Audit Event Process Monitor (C1-AUDEV)** batch, the system considers the audit events in the **Pending** or **Error** status. By default, it considers the audit events in the **Pending** status. The system checks whether the **C1-AUDBILLVL** algorithm is attached to the respective audit event type. If the **C1-AUDBILLVL** algorithm is attached to the audit event type, it identifies the parent customer of the bill group for whom the derivation and pricing parameters are defined or edited. It then considers all policies of the parent customer and its bill groups and extracts a list of memberships defined on the respective policy plans. It also identifies the active pricing rules on these policy plans and the pricing rule types using which these active pricing rules are created in the system. The system then checks whether the characteristic types specified in the bill group derivation algorithm on each pricing rule type are defined on any extracted list of membership. If so, the system then checks whether the characteristic values match the derivation and pricing parameters of the bill group. If one or more characteristic values do not match the derivation and pricing parameters of the bill group, the system creates a repricing entity detail record for each membership, pricing rule type, and effective date combination in the **CI_REPRC_ENTITY_DTL** table. The status of the repricing entity detail record is set to **P**.

For example, a parent customer named PC1 has two bill groups — BG1 and BG2. The

•

a parent customer named PC1 has a bill group named BG1 whose the derivation and pricing parameters are changed as mentioned below:

Bill Group	Sort ID	Effective Date	Derivation and Pricing Parameter	From	To
BG1	10	01-01-2019	Parameter 1	Western	Western
			Parameter 2	Active	Active
			Parameter 3	Grade A	IC01
			Parameter 4	-	-
			Source System	X	X
BG1	20	01-01-2019	Parameter 1	Western	Western
			Parameter 2	Active	Active
			Parameter 3	Grade B	IC02
			Parameter 4	-	-
			Source System	X	X
BG2	10	01-01-2019	Parameter 1	Western	Western
			Parameter 2	Active	Active
			Parameter 3	IC01	Grade A
			Parameter 4	-	-
			Source System	X	X
BG2	20	01-01-2019	Parameter 1	Western	Western
			Parameter 2	Active	Active
			Parameter 3	IC02	Grade B
			Parameter 4	-	-
			Source System	X	X

In such case, the system creates four audit events — AE1 for BG1 and 10 combination with the effective date as 01-01-2019, AE2 for BG1 and 20 combination with the effective date as 01-01-2019, AE3 for BG2 and 10 combination with the effective date as 01-01-2019, and AE4 for BG2 and 20 combination with the effective date as 01-01-2019.

Now, let us assume that...

- PC1 has two policies — P1 (where no bill group is associated) and P2 (where BG1 is associated)
- BG1 has one policy named P2 (where PC1 is the policy holder)
- P1 has one plan named PP1 and P2 has one plan named PP2

- PP1 has two memberships — M1 and M2,
- PP2 has three memberships — M3, M4, and M5
- PRT1 and PRT2 are associated with PP1
- PRT3 is associated with PP2
- PP1 has two active pricing rules — PR1 (which is created using PRT1) and PR2 (which is created using PRT2)
- PP2 has one active pricing rule — PR3 (which is created using PRT3)
- The following characteristics are defined for the above mentioned memberships:

Membership	Effective Date	Characteristic Type	Characteristic Value
M1	03-01-2019	Location	Western
		Employee Status	Active
		Job Code	Grade A
		Source System	X
M2	05-10-2019	Location	Western
		Employee Status	Active
		Job Code	IC01
		Source System	X
M3	05-20-2019	Location	Western
		Employee Status	Active
		Job Code	Grade B
		Source System	X
M4	07-20-2019	Location	Western
		Employee Status	Active
		Job Code	IC02
		Source System	X
M5	08-01-2019	Location	Western
		Employee Status	Active
		Job Code	Grade A
		Source System	X

In such case, the system will create the following repricing entity detail records for each audit event in the **CI_REPRC_ENTITY_DTL** table:

Audit Event	The system will create the repricing entity detail records with the following combinations...
AE1	<ul style="list-style-type: none"> • M2, PRT1, 01-01-2019 • M2, PRT2, 01-01-2019
AE2	<ul style="list-style-type: none"> • M4, PRT3, 01-01-2019
AE3	<ul style="list-style-type: none"> • M1, PRT1, 01-01-2019 • M1, PRT2, 01-01-2019 • M5, PRT3, 01-01-2019
AE4	<ul style="list-style-type: none"> • M3, PRT3, 01-01-201

Once the repricing entity detail records are created successfully, the status of the audit event is set to **Complete**. However, if an error occurs while creating the repricing entity detail records for an audit event, the status of the audit event is set to **Error**.

Premium Proration Rules

Until now, the system used the service quantity rule named **PR** attached to the **HCPREMP** rate schedule to calculate the proration factor for the membership premium. Now, Oracle Revenue Management and Billing enables you to prorate the membership premium using the proration rules defined on the fully-insured group policy plan. A proration rule indicates how you want to prorate the membership premium on various events, such as enrollment, termination, etc. In a proration rule, you need to specify the following:

- **Effective Date** – Used to specify the date from when the proration rule is effective. However, the system considers the latest proration rule and not the effective proration rule while prorating the membership premium.
- **Proration Event Type** – Used to indicate the event when the membership premium should be prorated. The valid values are:
 - **Enrollment** – Used to indicate that you want to prorate the membership premium on enrollment based on the specified proration type.
 - **Termination** – Used to indicate that you want to prorate the membership premium on termination based on the specified proration type.
 - **New Born** – Used to indicate that you want to prorate the membership premium on new born enrollment based on the specified proration type.
 - **Same Month Enrollment and Termination** – Used to indicate that you want to prorate the membership premium when the member person enrolls and terminates in the same month based on the specified proration type.
- **Proration Type** – Used to indicate how you want to prorate the membership premium. The valid values are:
 - **Daily** – Used to indicate that you want to prorate the membership premium from the day the proration event has occurred.
 - **Mid-Month** – Used to indicate that you want to prorate the membership premium based on the proration date. The system calculates the proration date using the following formula: Bill Period Start Date – Specified Number of Days. For example, if the bill period start date is 1st of every month and number of days is 15, then the proration date would be 15th of every month. If a member person is enrolled to the membership on or before the proration date, the system will charge the premium for the member person. However, if a member person is enrolled to the membership after the proration date, the system will not charge the premium for the member person. And, if a member person is terminated from the membership on or after the proration date, the system will charge the premium for the member person. However, if a member person

is terminated from the membership before the proration date, the system will not charge the premium for the member person.

- **Full Month** – Used to indicate that the premium for a member person should be charged when the member person is enrolled or terminated on the coverage start date or coverage end date, respectively. If a member person is enrolled or terminated within the coverage period, the system will not charge the premium for the member person.
- **Waiver** – Used to indicate that the premium for a member person should be waived off completely for the month when the member person is enrolled or terminated from the membership.
- **Coverage Days**– Used to indicate that you want to prorate the premium for a member person based on the coverage days. If a member person is covered in the membership for a period less than the specified number of days, the system will not charge the premium for the member person. However, if a member person is covered in the membership for a period equal to or more than the specified number of days, the system will charge the premium for the member person. You can use this proration type when the proration event is set to **Same Month Enrollment and Termination**.
- **Enrollment** – Used to indicate that you want to prorate the premium for a member person using the proration type of the enrollment event. You can use this proration type only when the proration event is set to **Same Month Enrollment and Termination**.
- **Termination** - Used to indicate that you want to prorate the premium for a member person using the proration type of the termination event. You can use this proration type only when the proration event is set to **Same Month Enrollment and Termination**.
- **Number of Days** – Used to specify the number of days to determine the cutoff date when the proration type is set to Mid-Month or Coverage Days.

The following table indicates the proration types which are applicable for a particular proration event:

Proration Event	Proration Type
Enrollment	Daily, Mid-Month, Full Month, Waiver
Termination	Daily, Mid-Month, Full Month, Waiver
New Born	Daily, Mid-Month, Full Month, Waiver
Same Month Enrollment and Termination	Coverage Days, Enrollment, Termination, Waiver

Note that if the proration rule is not defined for the **New Born** event, the system uses the proration rule of the **Enrollment** event. The system enables you to define and edit the proration rules for a policy plan from the user interface or through a health care inbound message.

Once the membership premium is calculated either using an age based or tier based pricing rule, the system checks whether the proration rules are defined for the respective policy plan. If so, the system sets the base amount of the corresponding record in the **CI_PRCE_CALC_LN** table to the calculated premium amount. However, if the proration rules are not defined for the respective policy plan, the system sets the base amount of the corresponding record in the **CI_PRCE_CALC_LN** table to the calculated premium amount and proration factor is set to 1.

The system then executes the **C1-AGEPRFC** or **C1-TIERPRFC** algorithm attached to the **Pricing Rule Proration Amount Calculation** system event in the respective age based or tier based pricing rule type. The system invokes these algorithms in the **C1-REPC2** batch. These algorithms derive the proration event for a bill period timeline and accordingly updates the proration factor of the bill period timeline to 1 or 0 for all proration types except Daily. The proration factor is set to 1 when the premium for eligible member person (in case of age based pricing) and the premium for the membership (in case of tier based pricing) should be charged for the bill period timeline. And, proration factor is set to 0 when the premium for eligible member person (in case of age based pricing) and the premium for the membership (in case of tier based pricing) should not be charged for the bill period timeline. In case of the Daily proration type, the proration factor is calculated using the following formula: Number of Days Covered in the Coverage Period/Coverage Period

In case of tier based pricing, the system uses the subscription tier characteristic of the membership to determine the proration event.

Age Monitoring

Age is one of the most critical factor in determining health insurance premium. Therefore, Oracle Revenue Management and Billing enables you to monitor age for premium calculation.

In the age based pricing, the premium is calculated for each eligible member person based on age, employee attributes and modifiers, and then aggregated to derive the total premium for the membership. Until now, the age of a member person was calculated using the member enrollment date, plan start date, or policy renewal or start date. Now, in addition, a new predefined value named **MEMNRAGE (Member Enrollment Nearest Age)** is added to the **Age Calculation Date Basis (C1-AGCAL)** characteristic type. If you set the **C1-AGCAL** characteristic type to **MEMNRAGE**, the system considers the number of days specified in the **C1-PPRAMAGE** algorithm to calculate the nearest age of a member person. The system then derives the rate using the nearest age of the member person and accordingly calculates the premium for the member person. For example, a member person with the date of birth as 02-15-1980 has enrolled to the HMO Med Bronze plan from 01-01-2020 to 12-31-2020. And, the **C1-AGCAL** characteristic type is set to **MEMNRAGE** on the HMO Med Bronze plan where the following age based pricing is defined:

Age Group	Rate Value
0-15	\$100.00
16-18	\$120.00
19-20	\$140.00
21-40	\$160.00
41-60	\$180.00
61-65	\$200.00
66-99	\$250.00

Let us assume that the **No. of Days** parameter in the **C1-PPRAMAGE** algorithm is set to **90**. The system will calculate the nearest age of the member person through a cutoff date which is calculated using the following formula: Member Enrollment Date + No. of Days. In this case, the cutoff date is 03-30-2020 (01-01-2020 + 90). If the birthday of the member person falls within the cutoff date, the system charges the premium based on the nearest age. However, if the birthday of the member person does not fall within the cutoff date, the system charges the premium based on the actual age. In this case, the birthday falls within the cutoff date, and therefore the premium will be charged using the rate defined for the 41-60 age group (i.e. \$180) and not using the rate defined for the 21-40 age group (i.e. \$160).

Oracle Revenue Management and Billing enables you to recalculate the age of a member person in a membership in the following scenarios:

- When the policy is renewed
- When the age changes
- From the next month when the age changes

A new characteristic type named **Age Recalculation Date Basis (C1-AGREC)** is introduced in this release. We support the following predefined list of values:

- AGECHNG (Age Changes)
- CHGAGNTMNT (Next Month)
- RENEWAL (Policy Renewal)

If you want to recalculate the membership premium for a plan based on the recalculated age of a member person, you need to do the following:

- Define the **Age Recalculation Date Basis (C1-AGREC)** characteristic for the policy plan or for the policy to which the plan belongs
- Set the **Age Re-Calculation Date Basis** attribute to **Age Recalculation Date Basis (C1-AGREC)** in the age based pricing rule type which is associated with the policy plan

The system does the following when you add a membership to a policy plan or a member person to a membership:

If the Age Recalculation Date Basis characteristic type is set to...	Then,
AGECHNG	The system creates an audit event for a member person when the birthday falls within the enrollment date range. Here, the effective date of the audit event is set to the birth date of the member person.
CHGAGNTMNT	The system creates an audit event for a member person when the birthday falls within the enrollment date range. Here, the effective date of the audit event is set to the billing date of the next month. For example, if the bill date in a bill period starts 1 st of every month and the date of birth of a member person is 05-10-2020, the effective date of the audit event is set to 01-11-2020.
RENEWAL	The system creates an audit event for a member person when the birthday falls within the new enrollment date range (i.e. from original policy end date+1 to new policy end date). Here, the effective date of the audit event is set to the birth date of the member person.

Apart from the membership premium recalculation, the **Age Recalculation Date Basis (C1-AGREC)** characteristic is used to evaluate the member relationship characteristic of each member person and subscription tier characteristic of the membership when the **Young Adult Applicability** characteristic is set to **Y** and the child or dependent enrolling to the membership becomes young adult in the enrollment period.

The **C1-FIAUDEV** algorithm is enhanced to support the age recalculation feature. It creates audit events in the C1_AUDIT_EVENT table and repricing entity detail records in the CI_REPRC_ENTITY_DTL table when the age of a member person changes within the enrollment period.

State of Issue

The State of Issue feature enables you to search for the following characteristics on a state:

- Maximum Number of Dependents
- Maximum Age Limit for Maximum Dependent Count
- Maximum Number of Dependents Order Priority
- Age Calculation Date Basis
- Newborn Gift Days
- Newborn Gift Days Applicability
- Young Adult Max Age Limit
- Young Adult Inclusion Applicability

It helps in identifying a list of eligible children in a membership. To enable the State of Issue feature, you need to do the following:

1. Define a predefined characteristic type named **State of Issue** where the characteristic entity is set to **Membership, Policy Plan** and **Policy**.
2. Define the required states as the predefined values for the **State of Issue** characteristic type.

- Set the **State of Issue** characteristic type in the **State of Issue Characteristic Type** option type of the **C1-ASOBLLNG** feature configuration.

If the State of Issue feature is enabled, the system checks whether the **State of Issue** characteristic is defined for the membership when any of the above required characteristic is not defined at the membership person and membership levels. If the **State of Issue** characteristic is defined for the membership, the system checks whether the above required characteristic is defined on the state where the membership is issued. For example, if the **State of Issue** characteristic on the M1 membership is set to **California**, then the system will search for any of the above required characteristic on the **California** state. If the required characteristic is defined for the state, the system considers it while identifying a list of eligible children in the membership.

If the required characteristic is not defined at the membership person, membership, state where the membership is issued and policy plan levels, the system checks whether the **State of Issue** characteristic is defined for the policy plan. If the **State of Issue** characteristic is defined for the policy plan, the system checks whether the above required characteristic is defined on the state where the policy plan is issued. If the required characteristic is defined for the state, the system considers it while identifying a list of eligible children in the membership.

However, if the required characteristic is not defined at the membership person, membership, state where membership is issued, policy plan, state where the policy plan is issued, and policy levels, the system checks whether the **State of Issue** characteristic is defined for the policy. If the **State of Issue** characteristic is defined for the policy, the system checks whether the above required characteristic is defined on the state where the policy is issued. If the required characteristic is defined for the state, the system considers it while identifying a list of eligible children in the membership.

Related Topics

For more information on...	See...
Audit Framework for Fully-Insured Group Health Insurance Billing	Audit Framework for Fully-Insured Group Health Insurance Billing on page 3115
Bill Group Derivation for Membership	Bill Group Derivation for Membership on page 3137
Account and Price Item Derivation for Membership	Account and Price Item Derivation for Membership on page 3140
Membership Premium Calculation	Membership Premium Calculation on page 3132
Repricing	Repricing on page 3142
Fully-Insured Group Billable Charge Creation	Fully-Insured Group Billable Charge Creation on page 3143

Membership Premium Calculation

The membership premium is calculated differently using the following pricing:

- Age-Based Pricing** – The system first identifies a list of members which are eligible for premium calculation in a membership. It derives the main subscriber and member persons (i.e. Spouse and Children) which are related to the main subscriber using the relationship type specified in the **Age Based** pricing rule type. To identify a list of eligible children for premium calculation, the system uses the following characteristics:
 - Maximum Number of Dependents** – Used to indicate the maximum number of children which are eligible for premium calculation.
 - Maximum Age Limit for Maximum Dependent Count** – Used to indicate the maximum age limit for children which are eligible for premium calculation.
 - Maximum Number of Dependents Order Priority** – Used to indicate whether you want to consider the youngest or eldest children during premium calculation. The valid values are - **YOUNGEST** and **ELDEST**.
 - Age Calculation Date Basis** – Used to indicate whether the member person’s age should be calculated using the member person’s enrollment date or policy’s start or renewal date.

- **Newborn Gift Days** – Used to indicate the number of days you want to offer as gift days from the new born child’s birth date. As a result, no premium will be calculated for this period.
- **Newborn Gift Days Applicability** – Used to indicate whether you want to offer gift days in case of a new born. The valid values are - **Y** and **N**.
- **Young Adult Max Age Limit** – Used to indicate the maximum age limit for young adults which are eligible for premium calculation.
- **Young Adult Inclusion Applicability** – Used to indicate whether you want to consider the young adults during the premium calculation. The valid values are - **Y** and **N**.

Note: Only the **Age Calculation Date Basis (C1-AGCAL)** characteristic type is shipped with the product. You need to create the remaining characteristic types in the system and set their characteristic entity to the following - **Membership Person, Membership, Policy Plan, Policy,** and/or **State**.

The system searches for these characteristics on the following entities in the specified sequence:

1. Membership Person
2. Membership
3. State where the Membership is issued
4. Policy Plan
5. State where the Policy Plan is Issued
6. Policy
7. State where the Policy is Issued

For example, if the **Maximum Number of Dependents** characteristic is defined for all entities, the system considers the characteristic which is defined at the Member Person level because it is the lowest level. However, if the **Newborn Gift Days Applicability** characteristic is defined at the Policy Plan and Policy levels, the system considers the characteristic which is defined at the Policy Plan level because it is the lowest level. In other words, the system crawls from the lowest to the highest level while searching for the above characteristics. You can also define the above characteristics on the state where the membership, policy plan and/or policy are issued. For more information, refer to the State of Issue section.

Once the eligible members for premium are identified, the system derives the base fee and applicable modifier fee which are defined in the pricing rules. The system then calculates the timeline for each membership and price item combination. The timeline is basically calculated to understand the period for which the premium is applicable. For example, if a policy plan named **P1** has the following membership:

Membership	M1
Member Persons	P1 and P2
Membership Start Date	01-01-2019
Membership End Date	31-12-2019
P0 Main Subscriber’s Start Date	01-01-2019
P0 Main Subscriber’s End Date	31-12-2019
P1 Member’s Start Date	01-01-2019
P1 Member’s End Date	30-06-2019
P2 Member’s Start Date	01-10-2019

P2 Member's End Date	31-12-2019
-----------------------------	------------

The **P1** policy plan is associated with an Age Based pricing rule type which contains the **Premium Fee** price item. The Age Based pricing rule for the **Premium Fee** price item is effective from 01-01-2019 to 31-12-2019.

In this case, the system will create the following timelines when you add **P2** member person in the **M1** membership:

Membership	Price Item	Timeline Start Date (Effective Date)	Timeline End Date
M1	Premium Fee	01-01-2019	30-06-2019 (i.e. P1 Member's End Date)
M1	Premium Fee	01-07-2019	30-09-2019
M1	Premium Fee	01-10-2019 (i.e. P2 Member's Start Date)	31-12-2019

It creates timelines using the membership's start and end dates, member person's start and end dates, and effective date. For each timeline, the system calculates the premium for all eligible member persons in the membership. Let us assume that the effective pricing rule is configured in the following manner:

Age Band	Fee
0-21	\$50
21-65	\$100
>65	\$150

P0 belongs to the 21-65 age band and P1 and P2 belongs to the 0-21 age band. Therefore, the premium is calculated using the following base fee:

Membership	Price Item	Timeline Start Date (Effective Date)	Timeline End Date	Base Fee
M1	Premium Fee	01-01-2019	30-06-2019 (i.e. P1 Member's End Date)	P0: \$100 P1: \$50
M1	Premium Fee	01-07-2019	30-09-2019	P0: \$100
M1	Premium Fee	01-10-2019 (i.e. P2 Member's Start Date)	31-12-2019	P0: \$100 P2: \$50

Now, let us assume the following characteristics are defined on the **P1** policy plan which offers gift days to a new born child:

Effective Date	Characteristic Type	Characteristic Value
01-01-2019	Newborn Gift Days Applicability	Y
01-01-2019	Newborn Gift Days	30

Now, if the main subscriber adds his child named **C1** who is born on 05-03-2019, the system will create the following timelines:

Membership	Price Item	Timeline Start Date (Effective Date)	Timeline End Date
M1	Premium Fee	01-01-2019	03-04-2019 (i.e. 05-03-2019 +30 Days)
M1	Premium Fee	04-04-2019 (New Born Considered for Premium Calculation)	30-06-2019 (i.e. P1 Member's End Date)
M1	Premium Fee	01-07-2019	30-09-2019
M1	Premium Fee	01-10-2019 (i.e. P2 Member's Start Date)	31-12-2019

It creates timelines using the membership's start and end dates, member person's start and end dates, and effective date. For each timeline, the system calculates the premium for all eligible member persons in the membership. In this case, the premium is calculated using the following base fee:

Membership	Price Item	Timeline Start Date (Effective Date)	Timeline End Date	Base Fee
M1	Premium Fee	01-01-2019	03-04-2019 (i.e. 05-03-2019 +30 Days)	P0: \$100 P1: \$50
M1	Premium Fee	04-04-2019 (New Born Considered for Premium Calculation)	30-06-2019 (i.e. P1 Member's End Date)	P0: \$100 P1: \$50 C1: \$50
M1	Premium Fee	01-07-2019	30-09-2019	P0: \$100 C1: \$50
M1	Premium Fee	01-10-2019 (i.e. P2 Member's Start Date)	31-12-2019	P0: \$100 P2: \$50 C1: \$50

- Tier Based Pricing** – The system first derives the base fee which is defined in the pricing rules. It then calculates the timeline for each membership and price item combination. The timeline is basically calculated to understand the period for which the premium is applicable. For example, if a policy plan named **P2** has the following membership:

Membership	M1
Member Persons	P1 and P2
Membership Start Date	01-01-2019
Membership End Date	31-12-2019
Membership Tier	ES (Employee + Spouse)

The **P2** policy plan is associated with a Tier Based pricing rule type which contains the **Premium Fee** price item. The Tier Based pricing rule for the **Premium Fee** price item is effective from 01-01-2019 to 31-12-2019.

The system will create the following timeline when the **M1** membership is added to the **P2** policy plan:

Membership	Price Item	Timeline Start Date (Effective date)	Timeline End Date
M1	Premium Fee	01-01-2019	31-12-2019

It creates timelines using the membership's start and end dates and effective date. For each timeline, the system calculates premium for the membership. Let us assume that the effective pricing rule is configured in the following manner:

Tier Level	Fee
E (Employee Only)	\$100
ES (Employee + Spouse)	\$200
F (Family)	\$350
EC (Employee+ Children)	\$150

The **M1** membership belongs to the **ES (Employee + Spouse)** tier. Therefore, the premium is calculated using the following base fee:

Membership	Price Item	Timeline Start Date (Effective Date)	Timeline End Date	Base Fee
M1	Premium Fee	01-01-2019	31-12-2019	\$200

Now, let us assume the following characteristics are defined on the **P2** policy plan which offers gift days to a new born child:

Effective date	Characteristic Type	Characteristic value
01-01-2019	Newborn Gift Days Applicability	Y
01-01-2019	Newborn Gift Days	30

Now, if the main subscriber adds his child named **C1** who is born on 05-03-2019, the system will create the following timelines:

Membership	Price Item	Timeline Start Date (Effective date)	Timeline End Date
M1	Premium Fee	01-01-2019	03-04-2019 (i.e. 05-03-2019 +30 Days)
M1	Premium Fee	04-04-2019 (New Born Considered for Premium Calculation)	31-12-2019

In this case, the premium is calculated using the following base fee considering the membership tier has changed from **ES (Employee + Spouse)** to **F (Family)**:

Membership	Price Item	Timeline Start Date (Effective Date)	Timeline End Date	Base Fee
M1	Premium Fee	01-01-2019	03-04-2019 (i.e. 05-03-2019 +30 Days)	200

Membership	Price Item	Timeline Start Date (Effective Date)	Timeline End Date	Base Fee
M1	Premium Fee	04-04-2019 (New Born Considered for Premium Calculation)	31-12-2019	350

The tasks performed through **Membership Repricing (C1-MEMBREPRICE)** inbound web service are described below:

- **Adding a Membership** - Whenever you are creating a membership for a fully-insured group health plan, you need to specify the plan for which you want to create the membership, a person who is the main subscriber of the membership, and the way in which the main subscriber is related to the membership. Once the membership is created, you can add more members (i.e.persons) to the membership.
- **Editing a Membership** - Once the membership is created for a fully-insured group health plan, you can edit the membership information such as start date, end date, and characteristics.
- **Viewing the Membership Details** - On the **Membership** page, you can view the membership details, member persons which are added to a membership, and the additional plans of the main subscriber.
- **Adding a Member Person to a Membership** - While adding a person to a membership, you need to specify whether the person is the main subscriber of the membership, whether the person is financially responsible for the membership, and how the person is related to the main subscriber. At a time, only one person can be the main subscriber of the membership.
- **Removing a Member Person from a Membership** - You cannot remove a member person, who is the main subscriber, from the membership. You can inactivate a member person whenever required. If you inactivate a member person who is the main subscriber of the membership, the system automatically inactivates the membership and all other member persons which are included in the membership.
- **Simulating Membership Premium Calculation**
 - You can simulate add and update operations carried-out for a membership, and can also calculate the premium derived from the simulation process. Any set of changes conducted as a part of the simulation process would not impact the actual membership and premium calculation process.

Bill Group Derivation for Membership

While deriving a bill group for a membership, the system first checks whether the characteristics specified in the following option types of the **C1-ASOBLLNG** feature configuration are defined for the membership:

- **Account Identifier Type Char Type** – Used to specify the characteristic type which stores the identifier type of the account to which the membership should be billed. Here, you must specify a characteristic type where the characteristic entity is set to **Membership**.
- **Account Identifier Value Char Type** - Used to specify the characteristic type which stores the corresponding identifier of the account to which the membership should be billed. Here, you must specify a characteristic type where the characteristic entity is set to **Membership**.

If the above two characteristics are defined for the membership, the system derives the account and then the person (i.e. bill group or parent customer) to which the account belongs. However, if the above two characteristics are not defined for the membership, the system then checks whether the characteristics specified in the following option types of the **C1-ASOBLLNG** feature configuration are defined for the membership:

- **Person Identifier Type Char Type** – Used to specify the characteristic type which stores the identifier type of the person to which the membership should be billed. Here, you must specify a characteristic type where the characteristic entity is set to **Membership**.

- **Person Identifier Value Char Type** - Used to specify the characteristic type which stores the corresponding identifier of the person to which the membership should be billed. Here, you must specify a characteristic type where the characteristic entity is set to **Membership**.

If the above two characteristics are defined for the membership, the system derives the person (i.e. bill group or parent customer) to which the membership should be billed. However, if the above two characteristics are not defined for the membership, the system checks whether the characteristics specified in the following parameters of the **C1_MEMBGDRV** algorithm are defined for the membership:

- **Characteristic Type for Bill level 1** – Used to specify the characteristic type which stores the bill group derivation and pricing parameter 1 for the membership. Here, you must specify a characteristic type where the characteristic entity is set to **Membership**.
- **Characteristic Type for Bill level 2** - Used to specify the characteristic type which stores the bill group derivation and pricing parameter 2 for the membership. Here, you must specify a characteristic type where the characteristic entity is set to **Membership**.
- **Characteristic Type for Bill level 3** - Used to specify the characteristic type which stores the bill group derivation and pricing parameter 3 for the membership. Here, you must specify a characteristic type where the characteristic entity is set to **Membership**.
- **Characteristic Type for Bill level 4** - Used to specify the characteristic type which stores the bill group derivation and pricing parameter 4 for the membership. Here, you must specify a characteristic type where the characteristic entity is set to **Membership**.
- **Characteristic Type for Source system** - Used to specify the characteristic type which stores the external system from where the fully-insured group policy is received for billing. Here, you must specify a characteristic type where the characteristic entity is set to **Membership, Policy Plan, or Policy**. The system searches for the characteristic on the following entity in the specified order:
 1. Membership
 2. Policy Plan
 3. Policy

If the characteristic is defined at first level (i.e. membership), the system will not search for the characteristic at the subsequent levels. However, if the characteristic is not defined at first level, the system will search for the characteristic at the second level (i.e. policy plan). If the characteristic is defined at second level, the system will not search for the characteristic at the subsequent level. However, if the characteristic is not defined at second level, the system will search for the characteristic at the third level (i.e. policy).

To derive the source system from the membership, policy plan, or policy, the system first derives the policy plan to which membership belongs and then the policy to which the policy plan belongs. The above characteristics indicate the Source System, Parameter 1, Parameter 2, Parameter 3, and Parameter 4. The system derives a bill group using the derivation and pricing parameters (i.e. Source System, Parameter 1, Parameter 2, Parameter 3, and Parameter 4) which are defined for the bill group. Note that the system considers the derivation and pricing parameters which are effective on the effective date (which is available corresponding to the record in the **CI_REPRC_ENTITY_DTL** table). It first searches for the bill group using the exact match. For example, a parent customer named PC1 has the following bill groups:

Bill Group	Derivation and Pricing Parameters				
	Source System	Parameter 1	Parameter 2	Parameter 3	Parameter 4
BG1	X	Western	Grade A	Active	-
BG2	X	Western	Grade A	Retiree	-

BG3	Y	Western	-	-	-
-----	---	---------	---	---	---

And, the following characteristics are defined for the M1 membership which belongs to the PP1 policy plan:

Entity	Characteristic Type	Characteristic Value
M1	Location	Western
M1	Grade	Grade A
PP1	External System	X

Now, if the **Location**, **Grade**, and **External System** characteristic types are specified in **Characteristic Type for Bill level 1**, **Characteristic Type for Bill level 2**, and **Characteristic Type for Source system** parameters of the **C1_MEMBGDRV** algorithm, the system searches for a bill group where the following derivation and

If the exact match is not available, the system finds the bill group using the best fit match.

Once the policy and policy plan is derived, the system

Based on the characteristic values on the membership for bill level 1 to bill level 4 and characteristic value of source system, the bill group and parent customer corresponding to the membership is derived. 2. Deriving policy : Policy is derived from the plan to which the membership is linked.

To derive the bill group for a membership to which its premium and other pass-through charges should be billed, you need to attach an algorithm created using the **C1_MEMBGDRV** algorithm type to the **Bill Group Derivation** system event in a pricing rule type where the category is set to **Age Based**, **Tier Based**, or **Pass-Through Billable Charge**.

Note that while searching for a bill group, the source system and Parameter 1 (i.e. Bill Level 1) are mandatory.

This algorithm contains the following parameters:

- **Characteristic Type for Bill Level 1** – Used to indicate the characteristic type. This characteristic type must be defined on the membership. It is used to store the derivation and pricing parameter 1 for the membership.
- **Characteristic Type for Bill Level 2** - Used to indicate the characteristic type. This characteristic type must be defined on the membership. It is used to store the derivation and pricing parameter 2 for the membership.
- **Characteristic Type for Bill Level 3** - Used to indicate the characteristic type. This characteristic type must be defined on the membership. It is used to store the derivation and pricing parameter 3 for the membership.
- **Characteristic Type for Bill Level 4** - Used to indicate the characteristic type. This characteristic type must be defined on the membership. It is used to store the derivation and pricing parameter 4 for the membership.

Once the bill group is derived, the system derives the parent customer of the bill group. If the system could not derive the policy, bill group, or parent customer, the status of the record is changed to **Error (E)** in the **CI_REPRC_ENTITY_DTL** table.

Related Topics

For more information on...	See...
Audit Framework for Fully-Insured Group Health Insurance Billing	Audit Framework for Fully-Insured Group Health Insurance Billing on page 3115
Account and Price Item Derivation for Membership	Account and Price Item Derivation for Membership on page 3140
State of Issue	State of Issue on page 3131
Membership Premium Calculation	Membership Premium Calculation on page 3132
Repricing	Repricing on page 3142

For more information on...	See...
Fully-Insured Group Billable Charge Creation	Fully-Insured Group Billable Charge Creation on page 3143

Account and Price Item Derivation for Membership

A new algorithm type named **C1_ACCPRIMEM** is added in this release. You need to attach an algorithm created using the **C1_ACCPRIMEM** algorithm type to the **Account and Price Item Derivation** system event in a pricing rule type where the category is set to **Age Based**, **Tier Based**, or **Pass-Through Billable Charge**.

This algorithm fetches the effective pricing rule for each price item specified in the pricing rule type on the effective date. It first searches for effective pricing rules on the policy plan to which the membership belongs. If the system does not find any effective pricing rule for a price item on the policy plan, it inherits the effective pricing rule for the price item from the parent customer level. The system then derives the account with a particular invoice type (to which a price item must be billed) based on the priority which is defined for the respective price item in the pricing rule type. Once the account is derived, the system then checks whether the account has one active contract of the contract type which is associated with the price item. If so, it fetches the contract for further processing. If the system could not derive the effective pricing rule for any price item or if the account or active contract for the account could not be derived, the status of the record is changed to **Error (E)** in the **CI_REPRC_ENTITY_DTL** table.

Related Topics

For more information on...	See...
Audit Framework for Fully-Insured Group Health Insurance Billing	Audit Framework for Fully-Insured Group Health Insurance Billing on page 3115
Bill Group Derivation for Membership	Bill Group Derivation for Membership on page 3137
State of Issue	State of Issue on page 3131
Membership Premium Calculation	Membership Premium Calculation on page 3132
Repricing	Repricing on page 3142
Fully-Insured Group Billable Charge Creation	Fully-Insured Group Billable Charge Creation on page 3143

Bill Cycle and Bill Period Derivation

Oracle Revenue Management and Billing uses the bill cycle of an account to generate the bills for the account and the bill period of an account to create the billable charges for the account. If the bill cycle and bill period used for an account are not in sync, the system will not give the desired output. Therefore, we have introduced a new feature wherein the bill cycle and bill period can be tightly coupled with each other.

You can define a billing preference wherein you pair the bill cycle and bill period. The system enables you to define, edit, delete, and copy a billing preference through the **Field Mapping** screen. The system derives the bill cycle and bill period for an account using the billing preference. You can set the billing preference for an account through a characteristic type which is specified in the **Bill Cycle Rule Code** option type of the **C1-ASOBLLNG** feature configuration. Note that you must specify a characteristic type where the characteristic entity is set to **Account** in the **Bill Cycle Rule Code** option type. You can define this characteristic for an account from the user interface or through a health care inbound message.

Whenever you create or edit an account through a health care inbound message, the system checks whether the characteristic type specified in the **Bill Cycle Rule Code** option type of the **C1-ASOBLLNG** feature configuration is available for the account in the inbound message. If so, the system checks whether the value specified for the billing preference characteristic type is already defined in the system. If so, the system derives the bill cycle from the billing preference when the account is created. In such case, the system ignores the bill cycle available in the inbound message.

In addition, when the billing preference characteristic is updated for an account, the system derives the new bill cycle from the respective billing preference in the system.

If the characteristic type specified in the **Bill Cycle Rule Code** option type of the **C1-ASOBLLNG** feature configuration is not available for the account in the inbound message, the system stores the bill cycle received in the inbound message for the account.

Until now, the system derived the bill period for an account using the **Invoice Day (C1OFFRST)** characteristic of the account. Now, you can derive the bill period for an account using the billing preference characteristic of the account. To derive the bill period from the billing preference, you need to attach the **Bill Period Derivation (C1-BILLPDRV)** algorithm to the **Account and Price Item Derivation Post-Processing** system event in the age based, tier based, additional charge, and benefit pricing rule types. The system invokes the **Bill Period Derivation (C1-BILLPDRV)** algorithm in the **C1-REPC1** batch. This algorithm derives the bill period from the billing preference of the account and accordingly updates the **RECURRING_FLG** and **RECURRING_VAL** columns of the corresponding records in the **CI_REPRC_REQ_DTL** table.

Bill Period Timeline

Now, you need to attach the **C1-BILLRPCR** algorithm to the **Account and Price Item Derivation Post-Processing** system event in the age based and tier based pricing rule types. It enables you to create an additional entry in the **CI_REPRC_REQ_DTL** table for the remaining months in the membership coverage period based on the bill period. For example, a record exists with the effective date as 01-01-2020 in the **CI_REPRC_REQ_DTL** table with a bill period where the bill dates start from 1st of every month and with a membership coverage period from 01-01-2020 to 12-31-2020. On executing the **C1-BILLRPCR** algorithm, the system will create the additional entries with the following effective dates in the **CI_REPRC_REQ_DTL** table:

Bill Period	Effective Date
02-01-2020 to 02-29-2020	02-01-2020
03-01-2020 to 03-31-2020	03-01-2020
04-01-2020 to 04-30-2020	04-01-2020
05-01-2020 to 05-31-2020	05-01-2020
06-01-2020 to 06-30-2020	06-01-2020
07-01-2020 to 07-31-2020	07-01-2020
08-01-2020 to 08-31-2020	08-01-2020
09-01-2020 to 09-30-2020	09-01-2020
10-01-2020 to 10-31-2020	10-01-2020
11-01-2020 to 11-30-2020	11-01-2020
12-01-2020 to 12-31-2020	12-01-2020

9/10 Billing (Skip Months)

In the health insurance domain, for a yearly coverage, the membership premium is calculated and billed every month. The fully-insured large groups such as school districts have two-three months of holiday every year. Usually, they prefer to distribute the off months' premium in the remaining months of the coverage period. Oracle Revenue Management and Billing enables you to handle this requirement through the **9/10 Billing (Skip Months)** feature. Note that, in this feature, only the recurring charges for membership premium and administration fees will be considered for distribution in the non-skip months of the coverage period.

You can set the skip months in a billing preference through the **Field Mapping** screen. You can specify one or more skip months in a billing preference which may be continuous or non-continuous. However, you cannot skip all 12 months in a billing preference. The system derives the skip months for an account using the billing preference. You can set the billing preference for an account through a characteristic type which is specified in the **Bill Cycle Rule Code** option type of the **C1-ASOBLNG** feature configuration. Note that you must specify a characteristic type where the characteristic entity is set to **Account** in the **Bill Cycle Rule Code** option type. You can define this characteristic for an account from the user interface or through a health care inbound message. You can view a list of accounts for which skip months are defined in the billing preference using the **Skip Months** field in the **360° Search** zone.

A new column named **DIS_AMT** is added to the **CI_PRCE_CALC** and **CI_PRCE_CALC_LN** tables. While calculating the membership premium using the age based or tier based pricing rule, the system checks whether the skip months are defined for the account. If the skip months are not defined for the account, the system stores the calculated premium in the **DIS_AMT** column.

A new algorithm type named **C1-SKPMNTHPC** is introduced in this release. To setup the **9/10 billing** feature, you need to create an algorithm using the **C1-SKPMNTHPC** algorithm type and attach it to the **Skip Month Premium Calculation** system event of the required age based and tier based pricing rule types. The system invokes this algorithm in the **C1-REPC3** batch. This algorithm distributes the total premium in the non-skip months of the coverage period. In case of an age based pricing, the system calculates the distributed amount for each eligible member in the membership. And, in case of a tier based pricing, the system calculates the distributed amount for the membership. When a billable charge is created for a non-skip month through the **C1-FIBCR** batch, the distributed amount is stored through an **SQI** on the billable charge.

Repricing

Oracle Revenue Management and Billing extends the Repricing feature for the insurance domain. To enable this feature for fully-insured line of business, you need to setup the audit framework for membership and age based and tier based pricing rules. For more information, refer to the Audit Framework for Membership and Fully-Insured Pricing Rules section.

To recalculate the membership premium, you need to execute the following batches in the specified order:

1. **Identify Entities for Repricing (C1-REPC1)** - Until now, this batch identified a set of accounts which were impacted due to change in a price list and then created a repricing request for such accounts. In this release, new parameters named **Repricing Mode** and **Membership ID** are added in this batch. If the **Repricing Mode** parameter is set to **ACCT**, this batch identifies a set of accounts which were impacted due to change in a price list and then creates a repricing request for such account. However, if the **Repricing Mode** parameter is set to **MEMB**, this batch considers the records in the **Pending (P)** and **Error (E)** status from the **CI_REPRC_ENTITY_DTL** table. For each record, the system invokes the algorithms attached to the following system events of the pricing rule type in the specified order:
 - a. **Bill Group Derivation** – Used to derives the policy, bill group, and parent customer of the bill group.
 - b. **Account and Price Item Derivation** – Used to derive the pricing rules for the price items (which are present in the pricing rule type) on the policy plan (to which the membership belongs).

Once the pricing rules are derived, the system creates a repricing request for the membership, pricing rule, and effective date combination. Finally, the status of the corresponding record is set to **Complete (C)** in the **CI_REPRC_ENTITY_DTL** table. If any error occurs while creating a repricing request, the status of the corresponding record is set to **Error (E)** in the **CI_REPRC_ENTITY_DTL** table.

This batch is a multi-threaded batch. For more information about the batch, refer to *Oracle Revenue Management and Billing Batch Guide*.

2. **Process Repricing Request (C1-REPC2)** - Until now, this batch calculated and persisted the rate for the account, price item, and effective date combination in the **CI_PRCE_CALC** table. In this release, new parameters named **Repricing Mode** and **Membership ID** are added in this batch. If the **Repricing Mode** parameter is set to **ACCT**, this batch calculates and persist the rate for the account, price item, and effective date combination in the

CI_PRCE_CALC table. However, if the **Repricing Mode** parameter is set to **MEMB**, this batch considers the records in the **Pending (P)** and **Error (E)** status from the CI_REPRC_REQ_DTL table. If the pricing rule in the record is **Age Based**, the system invokes the algorithms attached to the following system events of the pricing rule type in the specified order:

- a. **Pricing Rule Pre Processing** – Used to identify the eligible member persons for premium calculation.
- b. **Pricing Rule Premium Calculation** – Used to calculate the premium for the membership.

Once these algorithms are executed, the premium is calculated for each eligible member person and stored in the CI_PRCE_CALC_LN table and the total premium for the membership is stored in the CI_PRCE_CALC table. Finally, the status of the corresponding record is set to **Complete (C)** in the CI_REPRC_REQ_DTL table.

However, if the pricing rule in the record is **Tier Based**, the system invokes the algorithm attached to the following system event of the pricing rule type:

- **Pricing Rule Premium Calculation** – Used to calculate the premium for the membership.

Once the algorithm is executed, the premium is calculated for the membership and stored in the CI_PRCE_CALC table. Finally, the status of the corresponding record is set to **Complete (C)** in the CI_REPRC_REQ_DTL table.

This batch is a multi-threaded batch. For more information about the batch, refer to *Oracle Revenue Management and Billing Batch Guide*.

Related Topics

For more information on...	See...
Audit Framework for Fully-Insured Group Health Insurance Billing	Audit Framework for Fully-Insured Group Health Insurance Billing on page 3115
Bill Group Derivation for Membership	Bill Group Derivation for Membership on page 3137
Account and Price Item Derivation for Membership	Account and Price Item Derivation for Membership on page 3140
State of Issue	State of Issue on page 3131
Membership Premium Calculation	Membership Premium Calculation on page 3132
Fully-Insured Group Billable Charge Creation	Fully-Insured Group Billable Charge Creation on page 3143

Fully-Insured Group Billable Charge Creation

Oracle Revenue Management and Billing enables you to create billable charges for pre-calculated premium amount (which is received through a health care inbound message) and calculated premium amount (which is derived using a pricing rule defined at the policy plan level). Before creating an SQI based billable charge, the system derives the bill period for the account using the **Invoice Day (C1OFFRST)** characteristic defined on the account.

While creating a billable charge for the pre-calculated premium amount through a health care inbound message, the system creates an SQI based billable charge for the membership and price item combination. Note that if the bill period or frequency is given in the billable charge information in the health care inbound message, the system does not derive the bill period for the account.

However, for creating a billable charge for the calculated premium amount, you need to execute the **Fully-Insured Group Billable Charge Creation (C1-FIBCR)** batch. It creates an SQI based billable charge for calculated premium amount. It considers the timelines in the **Pending (P)** and **Error (E)** status from the CI_PRCE_CALC table. Note that it considers only those timelines where the entity type is set to **Membership**. For each timeline, membership and price item combination, the system does the following:

1. Derives the bill period for the account using the **Invoice Day (C1OFFRST)** characteristic defined on the account.

- Creates an SQI based billable charge. Here, the start and end dates on the billable charge are set to the timeline start and end dates.

If the premium amount of the two consecutive timelines of a membership and price item combination is same, this algorithm does not create a new billable charge. Instead, it extends the end date of the previous timeline's billable charge. If the membership end date is set to a date which is earlier than the previous date (for example, Old Membership End Date: 31-12-2019 and New Membership End Date: 31-10-2019) and a billable charge exists for the membership and price item combination with the same start date and amount, then the system behaves in the following manner:

If...	Then...
Bill segments for the 01-01-2019 to 31-12-2019 period are not yet generated in the system	The end date in the existing billable charge is updated to 31-10-2019.
Bill segments for the 01-01-2019 to 31-12-2019 period are in the Freezable status	The bill segments for the 01-11-2019 to 31-12-2019 period are deleted and the end date in the existing billable charge is updated to 31-10-2019.
Bill segments for the 01-01-2019 to 31-12-2019 period are in the Frozen or Pending Cancel status	The bill segments for the 01-11-2019 to 31-12-2019 period are canceled and the end date in the existing billable charge is updated to 31-10-2019.

However, if the membership end date is set to a date which is earlier than the previous date (for example, Old Membership End Date: 31-12-2019 and New Membership End Date: 31-10-2019) and a billable charge exists for the membership and price item combination with the same start date, but different amount, then the system behaves in the following manner:

If...	Then...
Bill segments for the 01-01-2019 to 31-12-2019 period are not yet generated in the system	The existing billable charge is canceled and a new billable charge is created for the 01-01-2019 to 31-10-2019 period.
Bill segments for the 01-01-2019 to 31-12-2019 period are in the Freezable status	The bill segments for the 01-01-2019 to 31-12-2019 period are deleted. The existing billable charge is canceled and a new billable charge is created for the 01-01-2019 to 31-10-2019 period.
Bill segments for the 01-01-2019 to 31-12-2019 period are in the Frozen or Pending Cancel status	The bill segments for the 01-01-2019 to 31-12-2019 period are canceled. The existing billable charge is canceled and a new billable charge is created for the 01-01-2019 to 31-10-2019 period.

And, if the membership end date is set to a date which is earlier than the previous date (for example, Old Membership End Date: 31-12-2019 and New Membership End Date: 31-10-2019) and a billable charge does not exist for the membership and price item combination with the same start date, then a billable charge is created for the 01-01-2019 to 31-10-2019 period. Note that if there are billable charges for the membership and price item combination whose date range is within the timeline, such billable charges are canceled and their corresponding bill segments (if any) are either deleted or canceled in the system.

The pre-calculated or calculated premium amount is stored as a pass through line in the SQI based billable charge. Note that these pass through lines are memo only and no general ledger entries will be created for these pass through lines. This algorithm fetches SQI from the **Proration SQI** option type of the **C1-ASOBLLNG** feature configuration. The SQI value is set to the total amount of the pass through lines in the billable charge. The system prorates the amount when the SQ rule specified in the rate schedule attached to the active contract contains the SQI which is specified in the **Proration SQI** option type of the **C1-ASOBLLNG** feature configuration.

Once the billable charge is created, the membership ID is stamped as characteristic on the billable charge. This indicates that the billable charge is created for the respective membership. This algorithm fetches the characteristic type, which must be defined on the billable charge, from the **Characteristic Type For Membership Id** option type of the **C1-ASOBLLNG** feature configuration.

Finally, the status of the corresponding timeline is set to **Complete (C)** in the **CI_PRCE_CALC** table. If any error occurs while creating a billable charge, the status of the corresponding timeline is set to **Error (E)** in the **CI_PRCE_CALC** table. In addition, if an error occurs, a To Do is created using the **C1-FIBCR** To Do type and assigned to all users with a To Do role which is specified as characteristic on the parent customer. The system considers the characteristic on the parent customer which is specified in the **To Do Role Characteristic Type** option type of the **C1-ASOBLLNG** feature configuration. Note that the system does not create a To Do for each error record. Instead, the system creates distinct To Do for each membership and pricing rule combination.

This batch is a multi-threaded batch. For more information about the batch, refer to *Oracle Revenue Management and Billing Batch Guide*.

Related Topics

For more information on...	See...
Audit Framework for Fully-Insured Group Health Insurance Billing	Audit Framework for Fully-Insured Group Health Insurance Billing on page 3115
Bill Group Derivation for Membership	Bill Group Derivation for Membership on page 3137
Account and Price Item Derivation for Membership	Account and Price Item Derivation for Membership on page 3140
State of Issue	State of Issue on page 3131
Membership Premium Calculation	Membership Premium Calculation on page 3132
Repricing	Repricing on page 3142

Repricing Request

The **Repricing Request** screen enables you to search for a repricing entity detail record using various search criteria. It contains the following zones:

- [Search Repricing Entity Detail Record](#) on page 3145
- [Repricing Requests](#) on page 3148
- [Timeline and Billable Charge Details](#) on page 3149
- [Pricing Calculation Details](#) on page 3149

There are two ways in which you can navigate to this screen:

- One from the **Audit Event** screen - In this case, the system automatically uses the audit event ID for searching and then lists the repricing entity detail records which are created for the respective audit event in the **Search Repricing Entity Detail Record** zone.
- Another from the **Pricing Management** menu - In this case, the system enables you to search for repricing entity detail records of a particular audit event or for all audit events of a particular membership.

Note: At present, the **Repricing Request** screen is only designed to meet the business requirements of the Fully-Insured Group Health Insurance domain.

Search Repricing Entity Detail Record

The **Search Repricing Entity Detail Record** zone enables you to search for repricing entity detail records which are:

- Created for a particular audit event
- Created for all audit events of a particular membership

It contains the following sections:

- **Search Criteria** - The **Search Criteria** section contains the following fields:

Field Name	Field Description	Mandatory (Yes or No)
Search By	Used to indicate whether you want to search for a repricing entity detail record using the membership details. The valid value is: <ul style="list-style-type: none"> • Membership 	Yes
	Note: By default, the Membership option is selected.	
Created From	Used to search repricing entity detail records which are created for a membership from a particular date.	No
From Effective Date	Used to search repricing entity detail records which are effective from a particular date onwards.	No
Created To	Used to search repricing entity detail records for a membership which are created till a particular date.	No
To Effective Date	Used to search repricing entity detail records which are effective till a particular date.	No
Audit Event ID	Used to search repricing entity detail records of a particular audit event.	Yes (Conditional)
		Note: This field is required when you want to search for a repricing entity detail records using the audit event details.
Status	Used to search repricing entity detail records with a particular status. The valid values are: <ul style="list-style-type: none"> • Completed • Error • Invalid • Pending 	No
Membership ID	Used to search repricing entity detail records of a particular membership.	Yes (Conditional)
	Note: The Search (🔍) icon appears corresponding to this field. On clicking the Search icon, the Membership Search window appears.	
Pricing Rule Type	Used to search repricing entity detail records which are created using a particular type of pricing rule.	No

Note: You must specify at least one search criterion while searching for a price list.

- **Search Results** – On clicking the **Search** button, a list of repricing request detail records appear based on the specified search criteria. The **Search Results** section contains the following columns:

Column Name	Column Description
Membership Information	Displays information about the membership.
	Note: It has a link. On clicking the link, the Membership screen appears where you can view the details of the respective membership.
Creation Date Time	Displays the date and time when the repricing entity detail record is created in the system.
Effective Date	Displays the date from when the repricing entity detail record is effective for the membership.
Pricing Rule Type	Displays the pricing rule type using which the pricing is defined for the entity.
	Note: It has a link. On clicking the link, the Pricing Rule Type screen appears where you can view the details of the respective pricing rule type.
Status	Displays the status of the repricing entity detail record. The valid values are: <ul style="list-style-type: none"> • Completed • Error • Invalid • Pending
Error Message	Displays the error message if any error occurs when the audit event is created for the membership.
	Note: The status of the corresponding membership is set to Error .
Pre processing Request ID	Displays the pre processing request Id.

Note: Pagination is used to display limited number of records in the **Search Results** section. You can use the navigation links, such as **Previous** and **Next** to navigate between pages.

By default, the **Filter** area is visible. You can hide the **Filter** area by clicking the **Filters** () icon in the upper right corner of this zone. You can also hide the **Filter** area by clicking the **Hide Filters** button in the lower left corner of this zone.

On clicking the **Broadcast** () icon corresponding to the **Membership Information** field, the **Repricing Requests** zone appears where you can view a list of repricing requests created for a specific repricing entity detail record.

Related Topics

For more information on...	See...
Repricing Request screen	Repricing Request on page 3145
Repricing Requests zone	Repricing Requests on page 3148

Repricing Requests

The **Repricing Requests** zone allows you to view the repricing requests which are created for a particular repricing entity detail record. It contains the following columns:

Column Name	Column Description
Pricing Rule Information	Displays information about the pricing rule using which the repricing request is created for the price item.
	Note: It has a link. On clicking the link, the Pricing Rule screen appears where you can view the details of the respective pricing rule.
Price Item Information	Displays information about the price item for which the repricing request is created in the system.
	Note: It has a link. On clicking the link, the Price Item screen appears where you can view the details of the respective price item.
Account Information	Displays the concatenated string consisting of account information which are separated by a comma (,).
	Note: It has a link. On clicking the link, the Account screen appears where you can view the details of the respective account.
Status	Displays the status of the repricing request. The valid values are: <ul style="list-style-type: none"> • Completed • Error • Invalid • Pending
Creation Date Time	Displays the date and time when the repricing request was created in the system.
Effective Date	Displays the date from when the repricing is effective for the price item.
Error Message	Displays the error message if any error occurs when the repricing entity detail record is created for the membership.
Request Reference Id	Displays the repricing request reference Id.

Note: Pagination is used to display limited number of records in this zone. You can use the navigation links, such as **Previous** and **Next** to navigate between pages.

By default, the **Repricing Requests** zone does not appear in the **Repricing Request** screen. It appears when you click the **Broadcast** (🔊) icon corresponding to a repricing entity detail record in the **Search Repricing Entity Detail Record** zone.

You can filter the list using various search criteria (such as, **Created From**, **From Effective Date**, **Created To**, **To Effective Date**, **Account ID**, **Status**, and **Pricing Rule**) available in the **Filter** area. By default, the **Filter** area is hidden. You can view the **Filter** area by clicking the **Filters** (🔍) icon in the upper right corner of this zone.

On clicking the **Broadcast** (🔊) icon corresponding to a particular repricing request, the **Timeline and Billable Charge Details** zone appears where you can view a list of timeline and billable charge details created for a specific repricing request.

Related Topics

For more information on...	See...
How to view the repricing requests created for a repricing entity detail record	Viewing the Repricing Requests Created for a Repricing Entity Detail Record on page 3151

Timeline and Billable Charge Details

The **Timeline and Billable Charge Details** zone enables you to view the timelines and billable charges generated for a repricing request. It contains the following columns:

Column Name	Column Description
Start Date	Displays the start date of the timeline.
End Date	Displays the end date of the timeline.
Amount	Displays the premium amount calculated for the timeline.
Billable Charge Information	Displays information about the billable charge for the timeline.
	Note: It has a link. On clicking the link, the Billable Charge ID screen appears where you can view the details of the respective billable charge.
Status	Displays the status of the timeline and billable charge details.
Error Message	Displays the error message if any error occurs when the repricing request is created for the price item in the system.

Note: Pagination is used to display limited number of records in this zone. You can use the navigation links, such as **Previous** and **Next** to navigate between pages.

By default, the **Timeline and Billable Charge Details** zone does not appear in the **Repricing Request** screen. It appears when you click the **Broadcast** (📡) icon corresponding to a repricing request in the **Repricing Requests** zone.

You can filter the list using various search criteria (such as, **Start Date**, **Billable Charge ID**, **End Date**, and **Status**) available in the **Filter** area. By default, the **Filter** area is hidden. You can view the **Filter** area by clicking the **Filters** (🔍) icon in the upper right corner of this zone.

On clicking the **Broadcast** (📡) icon corresponding to a timeline, the **Pricing Calculation Details** zone appears where you can view a list of pricing details of the entity.

Related Topics

For more information on...	See...
How to view the billable charge timeline details of a repricing request	Viewing the Billable Charge Timeline Details of a Repricing Request on page 3151

Pricing Calculation Details

The **Pricing Calculation Details** zone enables you to view how the premium is calculated for the membership (in case of tier-based pricing) and how the premium is calculated for each eligible member in the membership (in case of age-based pricing). It contains the following columns:

Column Name	Column Description
Entity Information	If the age based pricing is used during the membership premium calculation, this column indicates the eligible member for whom the premium amount is calculated. However, if the tier based pricing is used during the membership premium calculation, this column indicates the main subscriber of the membership.
Description on Bill	Displays the description of the rate component for which the price component is created in the age based or tier based pricing.
Pricing Parameter	Indicates the pricing eligibility criteria which is satisfied while deriving the base fee.
Amount	Displays the base fee or applicable modifier fee.
Total Amount	If the age based pricing is used during the membership premium calculation, this column displays the sum total of the base fee and modifier fee (if any) for the eligible member. However, if the tier based pricing is used during the membership premium calculation, this column displays the base fee applicable for the membership.

By default, the **Pricing Calculation Details** zone does not appear in the **Repricing Request** screen. It appears when you click the **Broadcast** (📡) icon corresponding to a **Billable Charge Information** field in the **Timeline and Billable Charge Details** zone.

Related Topics

For more information on...	See...
How to view the pricing calculation details of a timeline	Viewing the Pricing Calculation Details of a Timeline on page 3152

Searching for a Repricing Entity Detail Record

Prerequisites

To search for a repricing entity detail record, you should have:

- Repricing entity detail records created in the system.

Procedure

To search for a repricing entity detail record:

1. Click the **Menu** link in the **Application** toolbar.
A list appears.
2. From the **Main** menu, select **Pricing Management** and then click **Repricing Request**.
The **Repricing Request** screen appears.
3. Enter the search criteria in the **Search Repricing Entity Detail Record** zone.
4. Click **Search**.

A list of repricing entity detail records that meets the search criteria appears in the **Search Results** section.

Note: Pagination is used to display limited number of records in the **Search Results** section. You can use the navigation links, such as **Previous** and **Next** to navigate between pages.

Related Topics

For more information on...	See...
Repricing Request screen	Repricing Request on page 3145

For more information on...	See...
Search Repricing Entity Detail Record zone	Search Repricing Entity Detail Record on page 3145

Viewing the Repricing Requests Created for a Repricing Entity Detail Record

Procedure

To view the repricing requests created for a repricing entity detail record:

1. Search for the repricing entity detail record in the **Repricing Request** screen.
2. In the **Search Results** section, click the **Broadcast** () icon corresponding to the repricing entity detail record whose repricing request details you want to view. The **Repricing Requests** zone appears.
3. View the repricing requests created for the repricing entity detail record in the **Repricing Requests** zone.



Related Topics

For more information on...	See...
How to search for a repricing entity detail record	Searching for a Repricing Entity Detail Record on page 3150
Repricing Request screen	Repricing Request on page 3145
Repricing Requests zone	Repricing Requests on page 3148

Viewing the Billable Charge Timeline Details of a Repricing Request

Procedure

To view the billable charge timeline details of a repricing request:

1. Search for the repricing entity detail record in the **Repricing Request** screen.
2. In the **Search Results** section, click the **Broadcast** () icon corresponding to the repricing entity detail record whose repricing request details you want to view. The **Repricing Requests** zone appears.
3. In the **Repricing Requests** zone, click the **Broadcast** () icon corresponding to the repricing request whose billable charge timeline details you want to view. The **Timeline and Billable Charge Details** zone appears.
4. View the billable charge timeline details of a repricing request in the **Timeline and Billable Charge Details** zone.

Related Topics

For more information on...	See...
How to search for a repricing entity detail record	Searching for a Repricing Entity Detail Record on page 3150
Repricing Request screen	Repricing Request on page 3145
Repricing Requests zone	Repricing Requests on page 3148
Timeline and Billable Charge Details zone	Timeline and Billable Charge Details on page 3149

Viewing the Pricing Calculation Details of a Timeline

Procedure

To view the pricing calculation details of a timeline:

1. Search for the repricing entity detail record in the **Repricing Request** screen.
2. In the **Search Results** section, click the **Broadcast** (📡) icon corresponding to the repricing entity detail record whose repricing request details you want to view. The **Repricing Requests** zone appears.
3. In the **Repricing Requests** zone, click the **Broadcast** (📡) icon corresponding to the repricing request whose billable charge timeline details you want to view. The **Timeline and Billable Charge Details** zone appears.
4. In the **Timeline and Billable Charge Details** zone, click the **Broadcast** (📡) icon corresponding to the timeline whose pricing calculation details you want to view. The **Pricing Calculation Details** zone appears.
5. View the pricing calculation details of a timeline in the **Pricing Calculation Details** zone.

Related Topics

For more information on...	See...
How to search for a repricing entity detail record	Searching for a Repricing Entity Detail Record on page 3150
Repricing Request screen	Repricing Request on page 3145
Repricing Requests zone	Repricing Requests on page 3148
Timeline and Billable Charge Details zone	Timeline and Billable Charge Details on page 3149
Pricing Calculation Details zone	Pricing Calculation Details on page 3149

Membership Premium Calculation Through Inbound Web Service

Oracle Revenue Management and Billing enables you to calculate membership premium through an inbound web service. The following business service is shipped with the product to support the premium calculation operations:

Business Service	Description
C1-MembershipRepricing	Used to create, update, simulate, and trigger membership repricing. For more information, see C1-MembershipRepricing Business Service on page 3154

If you want to send the request in the XML format, you can create a SOAP based inbound web service. For more information on how to setup the **Membership Premium Calculation Through Inbound Web Service** feature, see [Prerequisites](#) on page 3152.

Prerequisites

The following table lists the prerequisites for membership premium calculation through an inbound web service:

If you want to...	Then...
Create adjustments through an inbound web service	<p>You need to do the following:</p> <ul style="list-style-type: none"> • Define a REST or SOAP based inbound web service to call the C1-CreateAdjustment business service. • Authorize the ORMB user to access the required application service. • Define the required account identifier types, divisions, contract types, and currencies in the system. • Define the required calculated or non-calculated adjustment types in the system. • Define the required characteristic types where the characteristic entity is set to Adjustment. • Associate the required characteristic types with the required adjustment types. • Include the adjustment type in the adjustment type profile which is associated with the respective contract type. • Define the required exchange rates in the system. • Define a currency conversion algorithm for adjustments using the C1_CURALGAD or C1_EXCRTAD algorithm type. • Attach a currency conversion algorithm to the Currency Conversion For Adjustments algorithm spot of the required divisions.
Cancel adjustments through an inbound web service	<p>You need to do the following:</p> <ul style="list-style-type: none"> • Define a REST or SOAP based inbound web service to call the C1-CancelAdjustment business service. • Authorize the ORMB user to access the required application service. • Define the required adjustment cancel reasons in the system.
View adjustments through an inbound web service	<p>You need to do the following:</p> <ul style="list-style-type: none"> • Define a REST or SOAP based inbound web service to call the C1-GetAdjustmentHistory business service. • Authorize the ORMB user to access the required application service. • Define the required account identifier types, divisions, contract types, and adjustment types in the system. • Set the Set Fetch Record Limit option type of the C1-RECLMT feature configuration.

If you want to...	Then...
Enable the Inbound Web Service History feature	<p>You need to do the following:</p> <ul style="list-style-type: none"> • Define an outbound message type with the following specifications: <ul style="list-style-type: none"> • Outbound Message Business Object - Web Service History (C1-WebServiceHistory) • Priority - Priority 10 -- Highest • Define an external system and associate the above outbound message type with the external system using the following specifications: <ul style="list-style-type: none"> • Processing Method - Batch • Batch Control - F1-FLUSH • Create an algorithm using the C1-IWSHIST algorithm type and attach it to the Web Service History system event in the installation options. <div style="border: 1px solid black; padding: 5px; margin-top: 10px;"> <p>Note: You need to specify the above outbound message type, using which the outbound message should be created, in the Outbound Message Type parameter of the C1-IWSHIST algorithm.</p> </div>

C1-MembershipRepricing Business Service

Oracle Revenue Management and Billing enables you to do the following through the **C1-MembershipRepricing** business service:

- Define and edit the following types of membership:
 - Active Employee Coverage Membership
 - Employer Sponsored Group Medicare Membership (800 Series Plans)
 - COBRA Membership
- Add a member person to the membership
- Edit the existing member person details of the membership
- Create a person whom you want to add to the membership
- Edit the details of a person who is added to the membership
- Define and edit a benefit of a member person in a medicare membership

Note: While editing a benefit of a member person, the system inactivates the old record and creates a new record in the system. The status of the old benefit record is set to **Inactive** and the status of the new benefit record is set to **Active**.

- Recalculate the membership premium (i.e. trigger repricing) in the following scenarios:
 - A membership is added or edited in the fully-insured group policy plan.
 - A member person is added to the membership.
 - The fields, characteristics, or statuses which are monitored for the auditing purposes are updated at the membership or member person level.
- Recalculate the membership premium in the simulation mode and not in real time

Note: You can use the simulation mode as the What-If Analysis tool. In the simulation mode, you can evaluate the membership premium when a new membership will be added or the existing membership will be updated. However, in the simulation mode, the system neither adds or edits the membership in the system nor creates the billable charge for the membership premium. It only recalculates the membership premium and sends the premium calculation details in the response. Note that membership premium recalculation happens only in the above three listed scenarios.

- View the information of the memberships whose start and end dates fall within the specified date range. The information includes:
 - Details of the membership
 - Details of each member person in the membership
 - Benefit details of a member person in a medicare membership
 - Details of the billable charges created for the membership premium for different price items
 - Pricing rule and price assignment used during the membership premium billable charge creation
 - Account for which the membership premium billable charge is created
 - How premium is calculated for each timeline of the billable charge

Note:

If the age based pricing is used during the membership premium calculation, the premium is calculated for each eligible member of the membership. Here, the premium amount is the sum of the base fee and modifier fee (if any) for the eligible member.

However, if the tier based pricing is used during the membership premium calculation, the premium is calculated at the membership level. Here, the premium amount is the base fee applicable for the membership.

You can also filter the list of membership premium billable charges by specifying price items whose billable charges you want to view.

- View the last billed amount and current balance of the account on which the membership premium is billed.

You can define or edit only one membership at a time through the **C1-MembershipRepricing** business service. You can only create or edit a member person and not a bill group or parent customer through the **C1-MembershipRepricing** business service.

We have shipped a SOAP based inbound web service named **C1-MembRepricing** with the product. You can send the membership repricing request from the external system in the XML format through the **C1-MembRepricing** inbound web service. If you want to send the request in the XML and/or JSON format, you need to create a REST based inbound web service.

C1-MembRepricing Business Service Schema

The following code snippet illustrates how the tags are nested in the membership repricing inbound web service schema:

```
<schema>
  <responseDetails>
    <membershipId></membershipId>
    <responseStatus></responseStatus>
    <message></message>
  </responseDetails>
  <simulationSw></simulationSw>
  <action></action>
  <readFilters>
    <dateFilter>
      <startDate></startDate>
      <endDate></endDate>
    </dateFilter>
  </readFilters>
</schema>
```

```

</dateFilter>
<priceItemFilter>
  <priceItemList>
    <priceItemCode></priceItemCode>
  </priceItemList>
</priceItemFilter>
<responseType></responseType>
</readFilters>
<person>
  <personData>
    <sequence></sequence>
    <personType></personType>
    <personName>
      <sequence></sequence>
      <entityName></entityName>
      <nameType></nameType>
    </personName>
    <identifiers>
      <idType></idType>
      <idValue></idValue>
      <isPrimary></isPrimary>
    </identifiers>
    <division></division>
    <birthDate></birthDate>
    <sinceDate></sinceDate>
    <address>
      <addressEffDate></addressEffDate>
      <addressType></addressType>
      <mailingName></mailingName>
      <address1></address1>
      <address2></address2>
      <address3></address3>
      <address4></address4>
      <city></city>
      <state></state>
      <zip></zip>
      <country></country>
      <houseType></houseType>
      <streetNumber1></streetNumber1>
      <streetNumber2></streetNumber2>
      <inCityLimit></inCityLimit>
      <taxVendorGeographicalCode></taxVendorGeographicalCode>
      <county></county>
    </address>
    <email></email>
    <overrideMailingName1></overrideMailingName1>
    <overrideMailingName2></overrideMailingName2>
    <overrideMailingName3></overrideMailingName3>
    <phones>
      <phoneType></phoneType>
      <phoneValue></phoneValue>
      <extension></extension>
    </phones>
    <relatedPersons>
      <idType></idType>
      <idValue></idValue>
      <personRelationshipType></personRelationshipType>
      <startDate></startDate>
      <endDate></endDate>
      <financialRelationshipSw></financialRelationshipSw>
      <parentOrChild></parentOrChild>
      <relatedPersonsCharacteristicsList>
        <characteristic>
          <characteristicType></characteristicType>

```



```

        <characteristicValue></characteristicValue>
        <effectiveDate></effectiveDate>
    </characteristic>
</relatedPersonsCharacteristicsList>
</relatedPersons>
<personCharacteristicList>
    <characteristic>
        <characteristicType></characteristicType>
        <characteristicValue></characteristicValue>
        <effectiveDate></effectiveDate>
    </characteristic>
</personCharacteristicList>
<accountData>
    <accountType></accountType>
    <customerClass></customerClass>
    <billCycle></billCycle>
    <billLeadDays></billLeadDays>
    <division></division>
    <currency></currency>
    <setUpDate></setUpDate>
    <acctUsageFlg></acctUsageFlg>
    <comments></comments>
    <deferAutoPayDt></deferAutoPayDt>
    <collectionClass></collectionClass>
    <billRouteType></billRouteType>
    <billAddressSource></billAddressSource>
    <accountIdentifiers>
        <idType></idType>
        <idValue></idValue>
        <isPrimary></isPrimary>
    </accountIdentifiers>
    <characteristics>
        <characteristicsList>
            <characteristicType></characteristicType>
            <characteristicValue></characteristicValue>
            <effectiveDate></effectiveDate>
        </characteristicsList>
    </characteristics>
</accountData>
</personData>
</person>
<membership>
    <sourceSystem></sourceSystem>
    <policyNumber></policyNumber>
    <planNumber></planNumber>
    <healthPlanCode></healthPlanCode>
    <startDate></startDate>
    <endDate></endDate>
    <boStatusCd></boStatusCd>
    <paidThroughDate></paidThroughDate>
    <membershipType></membershipType>
    <mainSubscriber>
        <mainSubsIdType></mainSubsIdType>
        <mainSubsIdValue></mainSubsIdValue>
        <membershipType></membershipType>
    </mainSubscriber>
    <autoRenew></autoRenew>
    <associatedMemberIdentifierType></associatedMemberIdentifierType>
    <associatedMemberIdentifier></associatedMemberIdentifier>
    <exchangeFlag></exchangeFlag>
    <exchangeId></exchangeId>
    <binderLiabilityAmount></binderLiabilityAmount>
    <binderPayApplicability></binderPayApplicability>
    <binderPayGraceDays></binderPayGraceDays>

```

```

<binderPayThreshold></binderPayThreshold>
<holdBilling></holdBilling>
<membershipRenewalDate></membershipRenewalDate>
<contractPeriod></contractPeriod>
<membershipIdentifierList>
  <membershipIdentifier>
    <membershipIdentifierType></membershipIdentifierType>
    <membershipIdentifierValue></membershipIdentifierValue>
  </membershipIdentifier>
</membershipIdentifierList>
<membershipCharacteristicList>
  <characteristic>
    <characteristicType></characteristicType>
    <characteristicValue></characteristicValue>
    <effectiveDate></effectiveDate>
  </characteristic>
</membershipCharacteristicList>
<membershipRateGuarantee>
  <membershipRateGuaranteeList>
    <rateGuaranteeStartDate></rateGuaranteeStartDate>
    <rateGuaranteeEndDate></rateGuaranteeEndDate>
    <rateGuaranteeStatus></rateGuaranteeStatus>
  </membershipRateGuaranteeList>
</membershipRateGuarantee>
<memberDataList>
  <memberData>
    <memberIdType></memberIdType>
    <memberIdValue></memberIdValue>
    <enrollmentStartDate></enrollmentStartDate>
    <enrollmentEndDate></enrollmentEndDate>
    <memberRelationship></memberRelationship>
    <membershipPersonStatus></membershipPersonStatus>
    <memberId></memberId>
    <financeRespFlag></financeRespFlag>
    <isMemberSw></isMemberSw>
    <externalMedicareBeneficiaryId></externalMedicareBeneficiaryId>
    <memberCharacteristicList>
      <characteristic>
        <characteristicType></characteristicType>
        <characteristicValue></characteristicValue>
        <effectiveDate></effectiveDate>
      </characteristic>
    </memberCharacteristicList>
    <benefitData>
      <benefitDataList>
        <sequence></sequence>
        <startDate></startDate>
        <endDate></endDate>
        <benefitStatus></benefitStatus>
        <benefitSourceFlag></benefitSourceFlag>
        <benefitSubTypeFlag></benefitSubTypeFlag>
        <planBenefitPackageId></planBenefitPackageId>
        <benefitAmount></benefitAmount>
        <benefitCharacteristicsList>
          <characteristic>
            <characteristicType></characteristicType>
            <characteristicValue></characteristicValue>
            <effectiveDate></effectiveDate>
          </characteristic>
        </benefitCharacteristicsList>
      </benefitDataList>
    </benefitData>
  </memberData>
</memberDataList>

```

```

    <premiumCalculationDetails>
      <premiumCalculation>
        <priceItemCd></priceItemCd>
        <startDt></startDt>
        <endDt></endDt>
        <calcAmt></calcAmt>
        <distAmt></distAmt>
        <currencyCd></currencyCd>
        <acctIdType></acctIdType>
        <acctIdVal></acctIdVal>
        <accountId></accountId>
        <billableChgId></billableChgId>
        <pricingRuleId></pricingRuleId>
        <priceAsgnId></priceAsgnId>
        <premiumCalcLineDetails>
          <premiumCalcLines>
            <proFactor></proFactor>
            <calcAmt></calcAmt>
            <distAmt></distAmt>
            <month></month>
            <totalCalcAmt></totalCalcAmt>
            <currencyCd></currencyCd>
            <entityTypeFlg></entityTypeFlg>
            <entityId></entityId>
            <referenceIdType></referenceIdType>
            <referenceIdValue></referenceIdValue>
            <pricingParameters></pricingParameters>
            <description></description>
          </premiumCalcLines>
        </premiumCalcLineDetails>
      </premiumCalculation>
    </premiumCalculationDetails>
  </membership>
  <accountBalance>
    <accountBalanceData>
      <accountIdentifierType></accountIdentifierType>
      <accountNumber></accountNumber>
      <accountId></accountId>
      <division></division>
      <sourceSystem></sourceSystem>
      <clExternalTransactionId></clExternalTransactionId>
      <externalSourceId></externalSourceId>
      <accountInfoDtls>
        <currentBalance></currentBalance>
        <lastBillAmount></lastBillAmount>
        <statusCd></statusCd>
        <messageText></messageText>
      </accountInfoDtls>
    </accountBalanceData>
  </accountBalance>
</schema>

```

Membership Premium Calculation Request and Response - Tags in XML Format

Note: We recommend you to refer the **C1-MembRepricing** inbound web service schema in parallel while understanding the below mentioned tags. This will help you to understand how the tags are nested in the schema.

Before calling the **C1-MembRepricing** inbound web service, you need to ensure that the membership repricing service contains the following tags:

Tag Name	Tag Description	Mandatory (Yes or No)						
schema	Used to specify the tags of a membership repricing inbound web service.	Yes						
simulationSw	<p>Used to specify whether the simulation switch should be set as enabled or disabled in the membership repricing web service.</p> <table border="1" data-bbox="485 407 1183 1150"> <thead> <tr> <th data-bbox="485 407 756 459">If</th> <th data-bbox="756 407 1183 459">Then</th> </tr> </thead> <tbody> <tr> <td data-bbox="485 459 756 890">The simulation switch is set as Y</td> <td data-bbox="756 459 1183 890"> <ul style="list-style-type: none"> Any changes made to the entities like membership, member-person, and billable-charges are not saved in the ORMB application. The billable charge event is not triggered in the ORMB application, and hence the Billable Charge tag is not displayed in the response received from the membership repricing inbound web service. </td> </tr> <tr> <td data-bbox="485 890 756 1150">The simulation switch is set as N</td> <td data-bbox="756 890 1183 1150"> <ul style="list-style-type: none"> The billable charge event is triggered in the ORMB application, and the Billable Charge tag is displayed in the response received from the membership repricing inbound web service. </td> </tr> </tbody> </table> <p>Note: If you do not specify the value for the simulation switch, by default, it is set to N.</p>	If	Then	The simulation switch is set as Y	<ul style="list-style-type: none"> Any changes made to the entities like membership, member-person, and billable-charges are not saved in the ORMB application. The billable charge event is not triggered in the ORMB application, and hence the Billable Charge tag is not displayed in the response received from the membership repricing inbound web service. 	The simulation switch is set as N	<ul style="list-style-type: none"> The billable charge event is triggered in the ORMB application, and the Billable Charge tag is displayed in the response received from the membership repricing inbound web service. 	Yes
If	Then							
The simulation switch is set as Y	<ul style="list-style-type: none"> Any changes made to the entities like membership, member-person, and billable-charges are not saved in the ORMB application. The billable charge event is not triggered in the ORMB application, and hence the Billable Charge tag is not displayed in the response received from the membership repricing inbound web service. 							
The simulation switch is set as N	<ul style="list-style-type: none"> The billable charge event is triggered in the ORMB application, and the Billable Charge tag is displayed in the response received from the membership repricing inbound web service. 							
action	<p>Used to indicate the execution mode of the membership repricing inbound web service when you want to receive the existing premium calculations in response.</p> <p>Note:</p> <p>If you specify the value for the action flag as READ the system retrieves the membership, pricing, and billable charge details for the membership.</p> <p>The membership information is not updated even if the simulation switch is set to N and the action flag is set as READ.</p>	<p>Yes (Conditional)</p> <p>Note: This data is required when you want to receive the existing premium calculations in the response from the membership repricing inbound web service.</p>						

Tag Name	Tag Description	Mandatory (Yes or No)
readFilters	Used to specify the filter when you want to view the premium calculations for a particular set of price-items or for a timeline.	Yes (Conditional)
	Note: The execution mode of the membership inbound web service should be set to read-only .	Note: This data is required while viewing the premium calculations for particular set of price-items or for a timeline.
dateFilter	Used to specify the filter when you want to view the premium calculations for a timeline.	Yes (Conditional)
	Note: The execution mode of the membership inbound web service should be set to read-only .	Note: This data is required while viewing the premium calculations for a particular timeline.
startDate	You can use this tag within the following tags:	
	If this tag is used within...	Then the purpose of the sequence tag is...
	dateFilter	Used to indicate the date from when the timeline is effective for premium calculations. Note: The start date cannot be later than the end date. The start date cannot be earlier than the membership start date or later than the membership end date.
	related persons	Used to specify the date from when the person is related to the parent customer.
	membership	Used to indicate the date from when the membership is effective.
	benefitDataList	Used to indicate the date from when the benefit is effective.
		Note: This data is required while viewing the premium calculations for a particular timeline.

Tag Name	Tag Description	Mandatory (Yes or No)										
endDate	You can use this tag within the following tags:	Yes (Conditional)										
	<table border="1"> <thead> <tr> <th>If this tag is used within...</th> <th>Then the purpose of the sequence tag is...</th> </tr> </thead> <tbody> <tr> <td>dateFilter</td> <td>Used to specify the date till when the timeline is effective for premium calculations. Note: The end date cannot be earlier than the start date. The end date cannot be earlier than the membership start date or later than the membership end date.</td> </tr> <tr> <td>related persons</td> <td>Used to specify the date till when the person is related to the parent customer.</td> </tr> <tr> <td>membership</td> <td>Used to indicate the date till when the membership is effective.</td> </tr> <tr> <td>benefitDataList</td> <td>Used to indicate the date till when the benefit is effective.</td> </tr> </tbody> </table>	If this tag is used within...	Then the purpose of the sequence tag is...	dateFilter	Used to specify the date till when the timeline is effective for premium calculations. Note: The end date cannot be earlier than the start date. The end date cannot be earlier than the membership start date or later than the membership end date.	related persons	Used to specify the date till when the person is related to the parent customer.	membership	Used to indicate the date till when the membership is effective.	benefitDataList	Used to indicate the date till when the benefit is effective.	Note: This data is required while viewing the premium calculations for a particular timeline.
	If this tag is used within...	Then the purpose of the sequence tag is...										
	dateFilter	Used to specify the date till when the timeline is effective for premium calculations. Note: The end date cannot be earlier than the start date. The end date cannot be earlier than the membership start date or later than the membership end date.										
	related persons	Used to specify the date till when the person is related to the parent customer.										
	membership	Used to indicate the date till when the membership is effective.										
benefitDataList	Used to indicate the date till when the benefit is effective.											
priceItemFilter	Used to specify the filter when you want to view the premium calculations for a particular set of timeline. Note: The execution mode of the membership inbound web service should be set to read-only .	Yes (Conditional) Note: This data is required while viewing the premium calculations for a particular set of price-items.										
priceItemList	Used to specify the price items in the pricing list.	No										
priceItemCode	Used to specify the price item code.	No										
person	Used to specify information about the person.	Yes										
personData	Used to specify the details of the parent customer, bill group, or member person.	Yes (Conditional) Note: This data is required while defining or editing a person.										

Tag Name	Tag Description	Mandatory (Yes or No)								
sequence	You can use this tag within the following tags:	Yes (Conditional)								
	<table border="1"> <thead> <tr> <th data-bbox="480 302 712 373">If this tag is used within...</th> <th data-bbox="721 302 1183 373">Then the purpose of the sequence tag is...</th> </tr> </thead> <tbody> <tr> <td data-bbox="480 380 721 491">personData</td> <td data-bbox="721 380 1183 491">Used to indicate the order in which the person information should be created in the system.</td> </tr> <tr> <td data-bbox="480 491 721 602">personName</td> <td data-bbox="721 491 1183 602">Used to indicate the order in which the person name should be created in the system.</td> </tr> <tr> <td data-bbox="480 602 721 714">benefitDataList</td> <td data-bbox="721 602 1183 714">Used to indicate the order in which the benefit information should be created in the system.</td> </tr> </tbody> </table>	If this tag is used within...	Then the purpose of the sequence tag is...	personData	Used to indicate the order in which the person information should be created in the system.	personName	Used to indicate the order in which the person name should be created in the system.	benefitDataList	Used to indicate the order in which the benefit information should be created in the system.	Note: This data is required while defining or editing a person.
	If this tag is used within...	Then the purpose of the sequence tag is...								
	personData	Used to indicate the order in which the person information should be created in the system.								
personName	Used to indicate the order in which the person name should be created in the system.									
benefitDataList	Used to indicate the order in which the benefit information should be created in the system.									
personType	Used to indicate the type of person. The valid values are: <ul style="list-style-type: none"> • B - Indicates that the person is a business owner. • BG - Indicates that the person is a bill group. • G - Indicates that the person is a group owner. • K - Indicates that the person is a broker. • P - Indicates that the person is an individual • PG - Indicates that the person is a parent customer. 	Yes (Conditional)								
	Note: You must specify a value which is already defined in the PER_OR_BUS_FLG lookup field. It must be in the Active status.	Note: This data is required while defining or editing a person.								
personName	Used to specify a list of names for the person.	Yes (Conditional)								
		Note: This data is required while defining or editing a person.								
entityName	Used to specify the name of the person.	Yes (Conditional)								
		Note: This data is required while defining or editing a person.								
nameType	Used to indicate the type of name.	Yes (Conditional)								
	Note: You must specify a value which is already defined in the NAME_TYPE_FLG lookup field. It must be in the Active status.	Note: This data is required while defining or editing a person.								

Tag Name	Tag Description	Mandatory (Yes or No)
identifiers	Used to specify the identification details for the person.	Yes (Conditional) Note: This data is required while defining or editing a person.
idType	You can use this tag within the following tags:	
	If this tag is used within...	Then the purpose of the sequence tag is...
	identifiers	Used to specify the person identifier type.
	related persons	Used to specify the related persons identifier type.
accountIdentifiers	Used to specify the account identifier type.	Note: This data is required while defining or editing a person, related persons, or account details.
idValue	You can use this tag within the following tags:	
	If this tag is used within...	Then the purpose of the sequence tag is...
	identifiers	Used to specify the person identifier type.
	related persons	Used to specify the person identifier type.
accountIdentifiers	Used to specify the account identifier type.	Note: This data is required while defining or editing a person, related persons or account details.
isPrimary	You can use this tag within the following tags:	
	If this tag is used within...	Then the purpose of the sequence tag is...
	identifiers	Used to indicate whether the person identifier is a primary identifier. The valid values are: <ul style="list-style-type: none"> • Y • N
accountIdentifiers	Used to indicate whether the account identifier is a primary identifier. The valid values are: <ul style="list-style-type: none"> • Y • N 	No

Tag Name	Tag Description	Mandatory (Yes or No)						
division	You can use this tag within the following tags:	No						
	<table border="1"> <thead> <tr> <th>If this tag is used within...</th> <th>Then the purpose of the sequence tag is...</th> </tr> </thead> <tbody> <tr> <td>personData</td> <td>Used to indicate the division to which the person belongs.</td> </tr> <tr> <td>accountBalanceData</td> <td>Used to indicate the division to which the account belongs.</td> </tr> </tbody> </table>		If this tag is used within...	Then the purpose of the sequence tag is...	personData	Used to indicate the division to which the person belongs.	accountBalanceData	Used to indicate the division to which the account belongs.
	If this tag is used within...		Then the purpose of the sequence tag is...					
	personData		Used to indicate the division to which the person belongs.					
accountBalanceData	Used to indicate the division to which the account belongs.							
birthDate	Used to specify the date when the person was born.	No						
	Note: You must specify the date in the YYYY-MM-DD format.							
sinceDate	Used to specify the date when the person's record is created in the system. This is purely informational.	No						
	Note: You must specify the date in the YYYY-MM-DD format.							
address	Used to specify the address of the person.	Yes (Conditional)						
		Note: This data is required while defining or editing the address of the person.						
addressEffDate	Used to specify the date from when the address is effective.	Yes (Conditional)						
	Note: You must specify the date in the YYYY-MM-DD format. If you do not specify the date, by default, the system sets the effective date to the date when the address is created in the system through the health care inbound message.	Note: This data is required while editing the address of a person.						

Tag Name	Tag Description	Mandatory (Yes or No)
addressType	Used to indicate the type of address. The valid values are: <ul style="list-style-type: none"> • MAIN - Indicates that the address is the person's mailing address. You can use this address type while specifying the address for the person and account. • SEAS - Indicates that the address is the person's seasonal address. You can use this address type while specifying the address for the person. • OVRD - Indicates that the address is the account's override address. You can use this address type while specifying the address for the account. 	Yes (Conditional)
	<p>Note: If you do not specify the address type, by default, it is set to MAIN. You must specify an address type which is already defined in the ADDRESS_TYPE_FLG lookup field. It must be in the Active status.</p>	<p>Note: This data is required while editing the address of a person or account.</p>
mailingName	Used to specify the name using which the person should be addressed in the mail communication. The system also uses the mailing name in the bills, letters, quotes, and statements.	No
address1	Used to specify the first line of the address. It may contain details, such as the house number.	Yes (Conditional)
		<p>Note: This data is required while defining and editing the address of a person.</p>
address2	Used to specify the second line of the address. It may contain details, such as the apartment name.	No
address3	Used to specify the third line of the address. It may contain details, such as the street name.	No
address4	Used to specify the fourth line of the address. It may contain the landmark details.	No
city	Used to specify the city name.	No
state	Used to indicate the state where the city is located.	No
zip	Used to specify the zip code of the address.	No
country	Used to indicate the country where the person or account is located.	No
houseType	Used to indicate the type of the house.	No
streetNumber1	Used to specify the numeric information, if any, related to the address.	No
streetNumber2	Used to specify the numeric information, if any, related to the address.	No

Tag Name	Tag Description	Mandatory (Yes or No)
inCityLimit	Used to indicate whether the address is within the city limit. The valid values are: <ul style="list-style-type: none"> • Y • N 	No
taxVendorGeographicalCode	Used to specify the geographic code of the address.	No
county	Used to specify the county name.	No
email	Used to specify the e-mail ID of the person.	No
overrideMailingName1	Used to specify the name using which you want to override the person's mailing name.	No
overrideMailingName2	Used to specify the name using which you want to override the person's override mailing name 1.	No
overrideMailingName3	Used to specify the name using which you want to override the person's override mailing name 2.	No
phones	Used to specify the phone details of the person.	Yes (Conditional) Note: This data is required while defining or editing the phone details of a person.
phoneType	Used to indicate the type of phone. Note: You must specify a phone type which is already defined in the system.	Yes (Conditional) Note: This data is required while defining or editing the phone details of a person.
phoneValue	Used to specify the phone number of the person.	Yes (Conditional) Note: This data is required while defining or editing the phone details of a person.
extension	Used to specify the extension value of the phone number.	Yes (Conditional) Note: This data is required while defining or editing the phone details of a person.
relatedPersons	Used to list other persons with whom you want to establish the person's relationship.	Yes (Conditional) Note: This data is required while defining or editing a person to person relationship.

Tag Name	Tag Description	Mandatory (Yes or No)
personRelationshipType	<p>Used to indicate how the other person is related to the person.</p> <p>Note:</p> <p>You must specify a person relationship type which is already defined in the system.</p> <p>If you have specified a parent customer as the related person for a bill group, the system, by default, uses the person relationship type which is specified in the Person Relationship Type option type of the C1-ASOBLNG feature configuration. It does not considers the value specified in this tag.</p>	<p>Yes (Conditional)</p> <p>Note: This data is required while creating relationship between a bill group and person whose the person type is not Parent Customer.</p>
financialRelationshipSw	<p>Used to indicate whether the other person is financially responsible for the person. The valid values are:</p> <ul style="list-style-type: none"> • True • False <p>Note: If you do not specify the value, by default, it is set to False.</p>	No
parentOrChild	<p>Used to indicate whether the other person is parent or child. The valid values are:</p> <ul style="list-style-type: none"> • P • C 	<p>Yes (Conditional)</p> <p>Note: This data is required while creating a person to person relationship.</p>
relatedPersonsCharacteristic	<p>Used to specify the characteristic details for the related person.</p>	<p>Yes (Conditional)</p> <p>Note: This data is required while defining or editing a characteristic of the respective entity.</p>

Tag Name	Tag Description	Mandatory (Yes or No)												
characteristic	<p>You can use this tag within the following tags:</p> <table border="1" data-bbox="488 296 1175 989"> <thead> <tr> <th data-bbox="488 296 743 373">If this tag is used within...</th> <th data-bbox="743 296 1175 373">Then the purpose of the sequence tag is...</th> </tr> </thead> <tbody> <tr> <td data-bbox="488 373 743 451">relatedPersonsCharacteristicList</td> <td data-bbox="743 373 1175 451">Used to specify the characteristic details for the related person.</td> </tr> <tr> <td data-bbox="488 451 743 529">personCharacteristicList</td> <td data-bbox="743 451 1175 529">Used to specify the characteristic details for the person.</td> </tr> <tr> <td data-bbox="488 529 743 821">membershipCharacteristicList</td> <td data-bbox="743 529 1175 821">Used to specify the characteristic for the membership. Note: The characteristic tag (along with its elements) can be used more than once within the schema when the Type attribute of the characteristic is set to List.</td> </tr> <tr> <td data-bbox="488 821 743 898">memberCharacteristicList</td> <td data-bbox="743 821 1175 898">Used to specify the characteristic details for the member person.</td> </tr> <tr> <td data-bbox="488 898 743 989">benefitCharacteristicsList</td> <td data-bbox="743 898 1175 989">Used to specify the characteristic details for the benefit.</td> </tr> </tbody> </table>	If this tag is used within...	Then the purpose of the sequence tag is...	relatedPersonsCharacteristicList	Used to specify the characteristic details for the related person.	personCharacteristicList	Used to specify the characteristic details for the person.	membershipCharacteristicList	Used to specify the characteristic for the membership. Note: The characteristic tag (along with its elements) can be used more than once within the schema when the Type attribute of the characteristic is set to List .	memberCharacteristicList	Used to specify the characteristic details for the member person.	benefitCharacteristicsList	Used to specify the characteristic details for the benefit.	<p>Yes (Conditional)</p> <p>Note: This data is required while defining or editing a characteristic of the respective entity.</p>
If this tag is used within...	Then the purpose of the sequence tag is...													
relatedPersonsCharacteristicList	Used to specify the characteristic details for the related person.													
personCharacteristicList	Used to specify the characteristic details for the person.													
membershipCharacteristicList	Used to specify the characteristic for the membership. Note: The characteristic tag (along with its elements) can be used more than once within the schema when the Type attribute of the characteristic is set to List .													
memberCharacteristicList	Used to specify the characteristic details for the member person.													
benefitCharacteristicsList	Used to specify the characteristic details for the benefit.													
characteristicType	<p>You can use this tag within the following tags:</p> <table border="1" data-bbox="488 1073 1175 1255"> <thead> <tr> <th data-bbox="488 1073 743 1150">If this tag is used within...</th> <th data-bbox="743 1073 1175 1150">Then the purpose of the sequence tag is...</th> </tr> </thead> <tbody> <tr> <td data-bbox="488 1150 743 1199">characteristic</td> <td data-bbox="743 1150 1175 1199">Used to specify the characteristic type.</td> </tr> <tr> <td data-bbox="488 1199 743 1255">characteristicList</td> <td data-bbox="743 1199 1175 1255">Used to specify the characteristic type.</td> </tr> </tbody> </table>	If this tag is used within...	Then the purpose of the sequence tag is...	characteristic	Used to specify the characteristic type.	characteristicList	Used to specify the characteristic type.	<p>Yes (Conditional)</p> <p>Note: This data is required while defining or editing a characteristic of the respective entity.</p>						
If this tag is used within...	Then the purpose of the sequence tag is...													
characteristic	Used to specify the characteristic type.													
characteristicList	Used to specify the characteristic type.													
characteristicValue	<p>You can use this tag within the following tags:</p> <table border="1" data-bbox="488 1339 1175 1587"> <thead> <tr> <th data-bbox="488 1339 743 1417">If this tag is used within...</th> <th data-bbox="743 1339 1175 1417">Then the purpose of the sequence tag is...</th> </tr> </thead> <tbody> <tr> <td data-bbox="488 1417 743 1495">characteristic</td> <td data-bbox="743 1417 1175 1495">Used to specify the value for the predefined characteristic type.</td> </tr> <tr> <td data-bbox="488 1495 743 1587">characteristicList</td> <td data-bbox="743 1495 1175 1587">Used to specify the value for the predefined characteristic type.</td> </tr> </tbody> </table>	If this tag is used within...	Then the purpose of the sequence tag is...	characteristic	Used to specify the value for the predefined characteristic type.	characteristicList	Used to specify the value for the predefined characteristic type.	<p>Yes (Conditional)</p> <p>Note: This data is required while defining or editing a characteristic of the respective entity.</p>						
If this tag is used within...	Then the purpose of the sequence tag is...													
characteristic	Used to specify the value for the predefined characteristic type.													
characteristicList	Used to specify the value for the predefined characteristic type.													

Tag Name	Tag Description	Mandatory (Yes or No)						
effectiveDate	You can use this tag within the following tags:	No						
	<table border="1"> <thead> <tr> <th>If this tag is used within...</th> <th>Then the purpose of the sequence tag is...</th> </tr> </thead> <tbody> <tr> <td>characteristic</td> <td>Used to specify the date from when the characteristic is effective.</td> </tr> <tr> <td>characteristicList</td> <td>Used to specify the date from when the characteristic details are effective for the account.</td> </tr> </tbody> </table>		If this tag is used within...	Then the purpose of the sequence tag is...	characteristic	Used to specify the date from when the characteristic is effective.	characteristicList	Used to specify the date from when the characteristic details are effective for the account.
	If this tag is used within...		Then the purpose of the sequence tag is...					
characteristic	Used to specify the date from when the characteristic is effective.							
characteristicList	Used to specify the date from when the characteristic details are effective for the account.							
personCharacteristicList	Used to specify the characteristic details for the related person.	Yes (Conditional)						
		Note: This data is required while defining or editing a characteristic of the respective entity.						
accountData	Used to specify the account details of a person.	Yes (Conditional)						
		Note: This data is required while defining or editing an account.						
accountType	Used to indicate the type of account. This information is stored as a characteristic for the account.	Yes (Conditional)						
	Note: The value is stored in the characteristic type which is specified in the Invoice Type Characteristic Type option type of the C1-ASOBLLNG feature configuration. You must specify a value which is already defined in the predefined characteristic type.	Note: This data is required while defining or editing an account.						
customerClass	Used to indicate the customer class to which the account belongs.	Yes (Conditional)						
		Note: This data is required while defining an account.						
billCycle	Used to indicate the bill cycle for the account.	No						
	Note: You must specify a bill cycle which is already defined in the system.							
billLeadDays	Used to indicate whether you want to bill the account in advance. Here, you need to specify the number of days which is used to derive the cut-off date for advance billing. If you do not want to bill the account in advance, you must specify the value as zero(0).	No						

Tag Name	Tag Description	Mandatory (Yes or No)
currency	Used to indicate the currency in which you want to bill the account.	Yes (Conditional)
	Note: You must specify a currency which is already defined in the system.	Note: This data is required while defining an account.
setUpDate	Used to specify the date when the account was first created. This is purely informational.	No
	Note: You must specify the date in the YYYY-MM-DD format. If you do not specify the value, by default, it is set to the current date.	
acctUsageFlg	Used to indicate the category to which the account belongs. The valid values are: <ul style="list-style-type: none"> • INVC- Indicates that the account will be used to bill charges of the usage accounts. • SETL- Indicates that the account will be used only for settlement purposes. • USAG- Indicates that the account will have its own charges. If the usage account is linked to any construct, the usage account's charges are billed through an invoice account. Otherwise, the usage account is billed individually. 	No
comments	Used to specify additional information about the account.	No
deferAutoPayDt	Used to specify the date till when you want to hold the automatic payment process for the account.	No
collectionClass	Used to specify the collection class using which you want to control the account's debt.	No
	Note: If you do not specify the value, by default, it is set to the collection class which is specified in the customer class of the account. You must specify a collection class which is already defined in the system.	
billRouteType	Used to indicate how the account's bill must be sent to the main customer.	Yes (Conditional)
		Note: This data is required while defining the respective information.

Tag Name	Tag Description	Mandatory (Yes or No)						
billAddressSource	Used to indicate whether the account's bill must be sent to the main customer's mailing address or to the main customer's account override address. The valid values are: <ul style="list-style-type: none"> • PER • ACOV 	Yes (Conditional) Note: This data is required while defining the respective information.						
accountIdentifiers	Used to specify the account identifiers for the account.	Yes						
characteristics	Used to specify the characteristics for the account.	No						
characteristicsList	Used to specify the characteristics information for the account.	No						
membership	Used to specify information about the membership.	Yes						
sourceSystem	Used to specify the external system from where the membership information is received for repricing. Note: You must specify a source system which is already defined in the C1-SourceSystemLookup extendable lookup. It must be in the Active status.	Yes						
policyNumber	Used to specify the policy number.	Yes (Conditional) Note: This data is required while defining or editing the respective information.						
planNumber	Used to specify the plan number.	Yes						
healthPlanCode	Used to specify the health plan code.	Yes						
boStatusCd	Used to indicate the status of the membership.	No						
membershipType	You can use this tag within the following tags: <table border="1" data-bbox="483 1312 1182 1843"> <thead> <tr> <th>If this tag is used within...</th> <th>Then the purpose of the sequence tag is...</th> </tr> </thead> <tbody> <tr> <td>membership</td> <td>Used to indicate the type of membership. The valid values are: <ul style="list-style-type: none"> • COBRA • Medicare • Retiree Note: If you want to define an active employee coverage membership, you must leave this field blank.</td> </tr> <tr> <td>mainSubscriber</td> <td>Used to indicate the type of membership for the main subscriber.</td> </tr> </tbody> </table>	If this tag is used within...	Then the purpose of the sequence tag is...	membership	Used to indicate the type of membership. The valid values are: <ul style="list-style-type: none"> • COBRA • Medicare • Retiree Note: If you want to define an active employee coverage membership, you must leave this field blank.	mainSubscriber	Used to indicate the type of membership for the main subscriber.	Yes
If this tag is used within...	Then the purpose of the sequence tag is...							
membership	Used to indicate the type of membership. The valid values are: <ul style="list-style-type: none"> • COBRA • Medicare • Retiree Note: If you want to define an active employee coverage membership, you must leave this field blank.							
mainSubscriber	Used to indicate the type of membership for the main subscriber.							

Tag Name	Tag Description	Mandatory (Yes or No)
mainSubscriber	Used to indicate whether the person is the main subscriber of the membership. The valid values are: <ul style="list-style-type: none"> • Yes • No 	Yes (Conditional) Note: This data is required only while defining the membership details of a person.
mainSubsIdType	Used to specify the type of main subscriber.	Yes (Conditional) Note: This data is required only while defining the membership details of a person.
mainSubsIdValue	Used to specify the value for the main subscriber.	Yes (Conditional) Note: This data is required only while defining the membership details of a person.
autoRenew	Used to indicate whether the individual membership should be automatically renewed.	No
associatedMemberIdentifierType	Used to specify the identifier type of the member who is associated with another individual membership.	No
associatedMemberIdentifier	Used to specify the identification of the member who is associated with another individual membership.	Yes (Conditional) Note: This data is required while defining or editing the individual membership.
exchangeFlag	Used to indicate whether the individual membership is purchased from the exchange. The valid values are: <ul style="list-style-type: none"> • ON • OFF 	Yes
exchangeId	Used to specify the identification number of the exchange from where the individual membership is purchased.	Yes (Conditional) Note: This data is required when the exchangeFlag is set to ON .

Tag Name	Tag Description	Mandatory (Yes or No)
binderLiabilityAmount	Used to specify the binder liability amount.	Yes (Conditional)
	Note: This data is required when the Consider Binder Liability Amount attribute is set to Y in the binder payment preference.	Note: This data is required while defining or editing the individual membership.
binderPayApplicability	Used to indicate that the system should monitor whether the binder payment is received before activating the individual membership. The valid values are: <ul style="list-style-type: none"> • Y • N 	No
binderPayGraceDays	Used to calculate the grace date for the individual membership.	Yes (Conditional)
		Note: This data is required when the binderPayApplicability is set to Y .
binderPayThreshold	Used to specify the threshold percentage using which the threshold amount should be calculated.	Yes (Conditional)
		Note: This data is required when the binderPayApplicability is set to Y .
holdBilling	Used to indicate whether you want to hold the bill generation process for the individual membership until the binder payment is received.	Yes (Conditional)
		Note: This data is required when you have selected the binderPayApplicability to Y .
membershipRenewalDate	Used to indicate the date when the individual membership should be renewed.	Yes (Conditional)
	Note: You must specify the renewal date when you are manually renewing the individual membership.	Note: This data is required while defining or editing the individual membership.
contractPeriod	Used to indicate the period (in months) for which the individual membership should be automatically renewed.	Yes (Conditional)
		Note: This data is required while defining or editing the individual membership.

Tag Name	Tag Description	Mandatory (Yes or No)
membershipIdentifierList	Used to specify the identification details for the membership.	Yes (Conditional) Note: This data is required while defining or editing the membership identifier details for the individual or group membership.
membershipIdentifier	Used to specify the identification for the membership.	Yes (Conditional) Note: This data is required while defining or editing the membership identifier details for the individual or group membership.
membershipIdentifierType	Used to specify the membership identifier type.	Yes (Conditional) Note: This data is required while defining or editing the membership identifier details for the individual or group membership.
membershipIdentifierValue	Used to specify the value for the predefined membership identifier type.	Yes (Conditional) Note: This data is required while defining or editing the membership identifier details for the individual or group membership.
membershipCharacteristicList	Used to specify the characteristic details for the membership.	Yes (Conditional) Note: This data is required only while defining the membership details of a person.
membershipRateGuarantee	Used to specify the rate guarantee information for each individual membership. Note: The rate guarantee information can be specified only while defining or editing the individual membership.	Yes (Conditional) Note: This data is required while defining or editing the respective information.

Tag Name	Tag Description	Mandatory (Yes or No)
membershipRateGuarantee	Used to specify the rate guarantee details for the individual membership. Note: The rate guarantee details can be specified only while defining or editing the individual membership.	Yes (Conditional) Note: This data is required while defining or editing the respective information.
rateGuaranteeStartDate	Used to specify the date from when the rate guarantee is available for the individual membership. Note: You can specify the rate guarantee start date only while defining or editing the individual membership. The rate guarantee start date cannot be later than rate guarantee end date. The rate guarantee start date cannot be earlier than the membership start date or later than membership end date.	Yes
rateGuaranteeEndDate	Used to specify the date till when the rate guarantee is available for the individual membership. Note: You can specify the rate guarantee start date only while defining or editing the individual membership. The rate guarantee end date cannot be earlier than rate guarantee start date. The rate guarantee start end cannot be earlier than the membership start date or later than membership end date.	Yes (Conditional) Note: This data is required if you have specified the rateGuaranteeStartDate while defining or editing the individual membership.
rateGuaranteeStatus	Used to indicate the status of the rate guarantee period. The valid values are: <ul style="list-style-type: none"> • Active • Inactive 	Yes
memberDataList	Used to specify basic information about the membership.	Yes (Conditional) Note: This data is required while defining or editing the membership details of a person.

Tag Name	Tag Description	Mandatory (Yes or No)
memberData	Used to specify the details of the main subscriber or dependent person.	Yes (Conditional)
	<p>Note:</p> <p>The member data information must be provided along with the enrollment dates whenever a new membership is created.</p> <p>The memberData tag (along with its elements) can only be used once within the schema, when the Type attribute of the memberData is set to Group.</p>	<p>Note: This data is required while defining the membership details of a person.</p>
memberIdType	Used to specify the external membership ID.	Yes
memberIdValue	Used to specify the value for the external membership ID.	Yes
enrollmentStartDate	Used to specify the date from when you want to add the member person to the membership.	Yes (Conditional)
	<p>Note:</p> <p>The enrollment start date cannot be later than the enrollment end date.</p> <p>The enrollment start date cannot be earlier than the membership start date or later than the membership end date.</p>	<p>Note: This data is required while defining the membership details of a person.</p>
enrollmentEndDate	Used to specify the date till when you want to add the member person to the membership.	Yes (Conditional)
	<p>Note:</p> <p>The enrollment end date cannot be earlier than the enrollment start date.</p> <p>The enrollment end date cannot be earlier than the membership start date or later than the membership end date.</p>	<p>Note: This data is required while defining the membership details of a person.</p>
memberRelationship	Used to indicate how the main subscriber is related to the membership.	Yes (Conditional)
		<p>Note: This data is required while defining or editing the membership details of a person.</p>
membershipPersonStatus	Used to indicate the status of the person in the membership. The valid values are: <ul style="list-style-type: none"> • Active • Inactive 	Yes

Tag Name	Tag Description	Mandatory (Yes or No)
memberId	Used to specify the external membership ID.	No
	Note: Here, you need to specify a membership ID which is maintained in the external source system.	
financeRespFlag	Used to indicate whether the person is financially responsible for the membership. The valid values are: <ul style="list-style-type: none"> • Yes • No 	No
isMemberSw	Used to indicate whether the person is a member or a non-member in the membership. The valid values are: <ul style="list-style-type: none"> • Yes • No 	No
externalMedicareBeneficiaryId	Used to specify the Medicare beneficiary identifier of the person who has availed the Medicare benefit.	No
benefitData	Used to specify information about the Medicare benefit.	Yes (Conditional)
		Note: This data is required while defining or editing a benefit.
benefitDataList	Used to indicate the order in which the benefit charge should be created for the membership.	Yes (Conditional)
		Note: This data is required while defining or editing a benefit.
benefitStatus	Used to search benefits with a particular status. The valid values are: <ul style="list-style-type: none"> • Active • Discarded • Inactive 	Yes (Conditional)
		Note: This data is required while defining or editing a benefit.
benefitSourceFlag	Used to indicate the source from where the Medicare benefit is received. The valid values are: <ul style="list-style-type: none"> • Centers for Medicare and Medicaid Services • State 	No

Tag Name	Tag Description	Mandatory (Yes or No)
benefitSubTypeFlag	Used to indicate the type of Medicare benefit. The valid values are: <ul style="list-style-type: none"> • Late Enrollment Penalty • Low Income Subsidy • Part A-Inpatient Hospital Coverage • Part B-Outpatient Hospital Coverage • Part D-Medicare Prescription Drug Coverage 	No
	Note: The list includes only those benefit sub types which are defined in the BENEFIT_SUB_TYPE_FLG lookup field.	
planBenefitPackageId	Used to indicate the medicare plan benefit package (i.e. 800 series plan) which is applicable for Medicare Part A, Part B, or Part D benefit.	Yes (Conditional)
	Note: You must specify a plan benefit package Id when the benefit sub type is set to Part A-Inpatient Hospital Coverage , Part B-Outpatient Medical Coverage , or Part D-Medicare Prescription Drug Coverage .	
benefitAmount	Used to specify the low income subsidy or late enrollment penalty amount for Medicare Part D.	No
	Note: You must specify a benefit amount when the benefit sub type is set to Late Enrollment Penalty or Low Income Subsidy .	

The following table provides information about the response tags in the membership repricing inbound web service:

Tag	Tag Description
responseDetails	Displays the information whether the membership repricing inbound web service was successfully processed or not.
membershipId	Indicates the membershipID for which the repricing should take place.

Tag	Tag Description								
responseStatus	<p>Indicates the status of the response received from the membership repricing inbound web service.</p> <table border="1"> <thead> <tr> <th>If</th> <th>Then</th> </tr> </thead> <tbody> <tr> <td>An error occurs while processing the membership repricing inbound web service</td> <td>The responseStatus tag contains ERROR as a response message received from the membership repricing inbound web service, and the error message is displayed in the message tag.</td> </tr> <tr> <td>The membership repricing inbound web service is correctly processed</td> <td>The responseStatus tag contains SUCCESS as a response message received from the membership repricing inbound web service.</td> </tr> <tr> <td>A transaction results in an error</td> <td>The changes requested as a part of the transaction are not processed and a rollback is performed.</td> </tr> </tbody> </table>	If	Then	An error occurs while processing the membership repricing inbound web service	The responseStatus tag contains ERROR as a response message received from the membership repricing inbound web service, and the error message is displayed in the message tag.	The membership repricing inbound web service is correctly processed	The responseStatus tag contains SUCCESS as a response message received from the membership repricing inbound web service.	A transaction results in an error	The changes requested as a part of the transaction are not processed and a rollback is performed.
If	Then								
An error occurs while processing the membership repricing inbound web service	The responseStatus tag contains ERROR as a response message received from the membership repricing inbound web service, and the error message is displayed in the message tag.								
The membership repricing inbound web service is correctly processed	The responseStatus tag contains SUCCESS as a response message received from the membership repricing inbound web service.								
A transaction results in an error	The changes requested as a part of the transaction are not processed and a rollback is performed.								
message	Indicates the reason why the membership repricing inbound web service failed.								
responseType	<p>Indicates the type of response received from the inbound web service. The valid values are:</p> <ul style="list-style-type: none"> • DT - Indicates that the response contains detailed information. • SMRY - Indicates that the response contains summary information. 								
paidThroughDate	Indicates the term end date of the last fully or partially paid term. For more information about the paid through date, refer to <i>Policy</i> on page 315.								
premiumCalculationDetails	<p>Displays the premium calculation details for the membership.</p> <p>Note: The premiumCalculationDetails tag (along with its elements) can be used only once within the schema when the Type attribute of the premiumCalculationDetails is set to Group.</p>								
premiumCalculation	<p>Displays the total premium of all the members for the timeline.</p> <p>Note: The premiumCalculation tag (along with its elements) can be used more than once within the schema when the Type attribute of the premiumCalculation is set to List.</p>								
priceItemCd	Indicates the price item for which the billable charge is created.								
startDt	<p>Displays the start date of the timeline.</p> <p>Note: The startDt cannot be later than the endDt. The startDt cannot be earlier than the membership start date or later than the membership end date.</p>								

Tag	Tag Description						
endDt	<p>Displays the end date of the timeline.</p> <p>Note:</p> <p>The endDt cannot be earlier than the startDt.</p> <p>The endDt cannot be earlier than the membership start date or later than the membership end date.</p>						
calcAmt	<p>You can use this tag within the following tags:</p> <table border="1"> <thead> <tr> <th>If this tag is used within...</th> <th>Then the purpose of the sequence tag is...</th> </tr> </thead> <tbody> <tr> <td>premiumCalculation</td> <td>Displays the premium amount calculated for the timeline.</td> </tr> <tr> <td>premiumCalcLines</td> <td>Displays the premium amount calculated for each eligible member in the membership.</td> </tr> </tbody> </table>	If this tag is used within...	Then the purpose of the sequence tag is...	premiumCalculation	Displays the premium amount calculated for the timeline.	premiumCalcLines	Displays the premium amount calculated for each eligible member in the membership.
If this tag is used within...	Then the purpose of the sequence tag is...						
premiumCalculation	Displays the premium amount calculated for the timeline.						
premiumCalcLines	Displays the premium amount calculated for each eligible member in the membership.						
distAmt	<p>You can use this tag within the following tags:</p> <table border="1"> <thead> <tr> <th>If this tag is used within...</th> <th>Then the purpose of the sequence tag is...</th> </tr> </thead> <tbody> <tr> <td>premiumCalculation</td> <td>Displays the discount amount calculated for the timeline.</td> </tr> <tr> <td>premiumCalcLines</td> <td>Displays the discount amount calculated for each eligible member in the membership.</td> </tr> </tbody> </table>	If this tag is used within...	Then the purpose of the sequence tag is...	premiumCalculation	Displays the discount amount calculated for the timeline.	premiumCalcLines	Displays the discount amount calculated for each eligible member in the membership.
If this tag is used within...	Then the purpose of the sequence tag is...						
premiumCalculation	Displays the discount amount calculated for the timeline.						
premiumCalcLines	Displays the discount amount calculated for each eligible member in the membership.						
currencyCd	<p>You can use this tag within the following tags:</p> <table border="1"> <thead> <tr> <th>If this tag is used within...</th> <th>Then the purpose of the sequence tag is...</th> </tr> </thead> <tbody> <tr> <td>premiumCalculation</td> <td>Indicates the currency in which the premium is calculated for the timeline.</td> </tr> <tr> <td>premiumCalcLines</td> <td>Indicates the currency in which the premium is calculated for each eligible member in the membership.</td> </tr> </tbody> </table> <p>Indicates the currency in which the premium is calculated.</p> <p>Note: Here, the system chooses those currencies in which the bills added to the membership are created.</p>	If this tag is used within...	Then the purpose of the sequence tag is...	premiumCalculation	Indicates the currency in which the premium is calculated for the timeline.	premiumCalcLines	Indicates the currency in which the premium is calculated for each eligible member in the membership.
If this tag is used within...	Then the purpose of the sequence tag is...						
premiumCalculation	Indicates the currency in which the premium is calculated for the timeline.						
premiumCalcLines	Indicates the currency in which the premium is calculated for each eligible member in the membership.						
acctIdType	Indicates the account identifier type.						
acctIdVal	Indicates the value of the account identifier type.						
accountId	Indicates the account to which the membership is billed.						
billableChgId	Indicates the billable charge ID.						
pricingRuleId	Indicates the pricing rule using which the premium amount is calculated.						
priceAsgnId	Indicates the price item pricing which is assigned to a membership.						
premiumCalcLineDetails	Displays the premium calculated line details for each eligible member in the membership.						

Tag	Tag Description						
premiumCalcLines	Displays the premium calculated line information for each eligible member in the membership.						
proFactor	Indicates the proration factor used to calculate the billable charges for the membership contract.						
month	Displays the month of the premium calculation.						
totalCalcAmt	Displays the total calculated amount for premium calculation.						
entityTypeFlg	Indicates the type of entity created for premium calculation.						
entityId	Indicates the entity ID.						
referenceIdType	Indicates the reference type used for premium calculation.						
referenceIdValue	Indicates the value of the reference identifier type.						
pricingParameters	Indicates the pricing eligibility criteria which is satisfied while deriving the premium for the membership.						
description	Displays the description of the rate component for which the price component is created in the age based or tier based pricing.						
accountBalance	Displays the amount balance in the account.						
accountBalanceData	Displays the account balance data information.						
accountIdentifierType	Indicates the account identifier type for the account.						
accountNumber	Indicates the bank account through which automatic payment is made.						
accountId	Indicates the account which made the payment.						
division	<p>You can use this tag within the following tags:</p> <table border="1"> <thead> <tr> <th>If this tag is used within...</th> <th>Then the purpose of the sequence tag is...</th> </tr> </thead> <tbody> <tr> <td>personData</td> <td>Displays the division to which the person belongs</td> </tr> <tr> <td>accountBalanceData</td> <td>Displays the division to which the account belongs</td> </tr> </tbody> </table>	If this tag is used within...	Then the purpose of the sequence tag is...	personData	Displays the division to which the person belongs	accountBalanceData	Displays the division to which the account belongs
If this tag is used within...	Then the purpose of the sequence tag is...						
personData	Displays the division to which the person belongs						
accountBalanceData	Displays the division to which the account belongs						
sourceSystem	Indicates the external system from where the membership information is received for repricing.						
c1ExternalTransactionId	Indicates the transaction in the external source system which resulted in the customer inbound message.						
externalSourceId	Displays the external source system ID.						
accountInfoDtls	Displays the account information details of an account.						
currentBalance	Displays the total amount of funds in the account.						
lastBillAmount	Indicates the last bill amount generated for the membership.						
statusCd	<p>Indicates whether the membership repricing incoming message is successfully processed or not. The valid values are:</p> <ul style="list-style-type: none"> • Success • Fail 						

Tag	Tag Description
messageText	Indicates the reason for an error occurrence.

Related Topics

For more information on...	See...
C1-MembRepricing Inbound Web Service	Membership Premium Calculation Through Inbound Web Service on page 3152

Sample Individual Membership Creation Request and Response in XML Format

Using the below example, you can do the following:

- Create an individual membership

Person Name	Person Type	Policy Number	Plan Number	Main Subscriber
TIER_BASED_MEMX4	PERSON	MEMX4_P2_SD001_IN1	MEMX4_P1	MEMX4_P1

```
<schema>
  <responseDetails>
    <membershipId></membershipId>
    <responseStatus></responseStatus>
    <message></message>
  </responseDetails>
  <simulationSw>N</simulationSw>
  <action></action>
  <readFilters>
    <dateFilter>
      <startDate></startDate>
      <endDate></endDate>
    </dateFilter>
    <priceItemFilter>
      <priceItemList>
        <priceItemCode></priceItemCode>
      </priceItemList>
    </priceItemFilter>
    <responseType></responseType>
  </readFilters>
  <person>
    <personData>
      <sequence>1</sequence>
      <personType>P</personType>
      <personName>
        <sequence>1</sequence>
        <entityName>TIER_BASED_MEMX4_P1,TIER_BASED_MEMX4_P2</entityName>
        <nameType>PRIM</nameType>
      </personName>
      <identifiers>
        <idType>WEB</idType>
        <idValue>TIER_BASED_MEMX4_P1</idValue>
        <isPrimary>Y</isPrimary>
      </identifiers>
      <division>HC</division>
      <birthDate>1990-01-01</birthDate>
      <sinceDate>2019-01-01</sinceDate>
      <address>
        <addressEffDate>2019-01-01</addressEffDate>
        <addressType>MAIN</addressType>
        <mailingName>MARTYN WALKER</mailingName>
      </address>
    </personData>
  </person>
</schema>
```

```

        <address1>MARWALK INFORMATION SYSTEMS</address1>
        <address2>7014-G WEST PARK</address2>
        <address3>SCOTTSDALE (NORTH)</address3>
        <address4>ARIZONA</address4>
        <city>SCOTTSDALE</city>
        <state>ARIZONA</state>
        <zip>80255</zip>
        <country>USA</country>
        <houseType>RANCH</houseType>
        <streetNumber1>270TH MAIN STREET</streetNumber1>
        <streetNumber2>CENTRAL ROAD</streetNumber2>
        <inCityLimit>Y</inCityLimit>
        <taxVendorGeographicalCode>2020</taxVendorGeographicalCode>
        <county>MARICOPA</county>
    </address>
    <email>tierbasedmem05_p2@sofs.com</email>
    <overrideMailingName1>tierbasedmem05_p2@sofs.com</
overrideMailingName1>
    <overrideMailingName2>tierbasedmem05_p2@sofs.com</
overrideMailingName2>
    <overrideMailingName3>tierbasedmem05_p2@sofs.com</
overrideMailingName3>
    <phones>
        <phoneType>BUSN</phoneType>
        <phoneValue>+1.450.212.0185</phoneValue>
        <extension>3234</extension>
    </phones>
    <phones>
        <phoneType>HOME</phoneType>
        <phoneValue>+1.300.312.4185</phoneValue>
        <extension></extension>
    </phones>
    <relatedPersons>
        <idType>WEB</idType>
        <idValue>FINS_COBRA_109</idValue>
        <personRelationshipType>CHILD</personRelationshipType>
        <startDate>2020-01-01</startDate>
        <endDate>2020-12-31</endDate>
        <financialRelationshipSw>FALSE</financialRelationshipSw>
        <parentOrChild>P</parentOrChild>
        <relatedPersonsCharacteristicsList>
            <characteristic>
                <characteristicType>RP-GAMBL</characteristicType>
                <characteristicValue>DRCT</characteristicValue>
                <effectiveDate>2020-01-01</effectiveDate>
            </characteristic>
        </relatedPersonsCharacteristicsList>
    </relatedPersons>
    <personCharacteristicList>
        <characteristic>
            <characteristicType>ZZ-BLAGM</characteristicType>
            <characteristicValue>DRCT</characteristicValue>
            <effectiveDate>2020-01-01</effectiveDate>
        </characteristic>
    </personCharacteristicList>
    <accountData>
        <accountType>ZXS</accountType>
        <customerClass>HC</customerClass>
        <billCycle>AUT</billCycle>
        <billLeadDays></billLeadDays>
        <division>HC</division>
        <currency>USD</currency>
        <setUpDate></setUpDate>
        <acctUsageFlg></acctUsageFlg>

```

```

    <comments></comments>
    <deferAutoPayDt></deferAutoPayDt>
    <collectionClass>HC</collectionClass>
    <billRouteType>EMAIL</billRouteType>
    <billAddressSource>ACCT</billAddressSource>
    <accountIdentifiers>
      <idType>ACCTNM</idType>
      <idValue>TIER_BASED_MEMX4_P1_ACC1</idValue>
      <isPrimary>TRUE</isPrimary>
    </accountIdentifiers>
    <characteristics>
      <characteristicsList>
        <characteristicType>C1OFFRST</characteristicType>
        <characteristicValue>1</characteristicValue>
        <effectiveDate>2021-01-01</effectiveDate>
      </characteristicsList>
      <characteristicsList>
        <characteristicType>ZZBLRULE</characteristicType>
        <characteristicValue>TESTMT5</characteristicValue>
        <effectiveDate>2021-01-01</effectiveDate>
      </characteristicsList>
    </characteristics>
  </accountData>
</personData>
</person>
<membership>
  <sourceSystem>ZZPRIME</sourceSystem>
  <policyNumber>REPRC_SD001_IN1_POL1</policyNumber>
  <planNumber>REPRC_SD001_IN1_POL01_P1</planNumber>
  <healthPlanCode>HLPNFBTEST145</healthPlanCode>
  <startDate>2021-01-01</startDate>
  <endDate>2021-12-31</endDate>
  <boStatusCd></boStatusCd>
  <paidThroughDate>2021-01-01</paidThroughDate>
  <membershipType>RETR</membershipType>
  <mainSubscriber>
    <mainSubsIdType>WEB</mainSubsIdType>
    <mainSubsIdValue>TIER_BASED_MEMX4_P1</mainSubsIdValue>
    <membershipType>RETR</membershipType>
  </mainSubscriber>
  <autoRenew>N</autoRenew>
  <associatedMemberIdentifierType>AADHR</associatedMemberIdentifierType>
  <associatedMemberIdentifier>HLPN022</associatedMemberIdentifier>
  <exchangeFlag>ON</exchangeFlag>
  <exchangeId>HLPNFBTEST145</exchangeId>
  <binderLiabilityAmount>5550.00</binderLiabilityAmount>
  <binderPayApplicability>Y</binderPayApplicability>
  <binderPayGraceDays>30</binderPayGraceDays>
  <binderPayThreshold>90</binderPayThreshold>
  <holdBilling>N</holdBilling>
  <membershipRenewalDate></membershipRenewalDate>
  <contractPeriod>0</contractPeriod>
  <membershipIdentifierList>
    <membershipIdentifier>
      <membershipIdentifierType>AADHR</membershipIdentifierType>
      <membershipIdentifierValue>HLPN022</membershipIdentifierValue>
    </membershipIdentifier>
  </membershipIdentifierList>
  <membershipCharacteristicList>
    <characteristic>
      <characteristicType>BILLLVL1</characteristicType>
      <characteristicValue>FINS_MDPSCR_AGR005_IN1_PARAM1</
characteristicValue>
      <effectiveDate>2021-01-01</effectiveDate>

```

```

    </characteristic>
  </membershipCharacteristicList>
  <membershipRateGuarantee>
    <membershipRateGuaranteeList>
      <rateGuaranteeStartDate>2021-01-01</rateGuaranteeStartDate>
      <rateGuaranteeEndDate>2021-01-01</rateGuaranteeEndDate>
      <rateGuaranteeStatus>ACTIVE</rateGuaranteeStatus>
    </membershipRateGuaranteeList>
  </membershipRateGuarantee>
  <memberDataList>
    <memberData>
      <memberIdType>WEB</memberIdType>
      <memberIdValue>TIER_BASED_MEMX4_P1</memberIdValue>
      <enrollmentStartDate>2021-01-01</enrollmentStartDate>
      <enrollmentEndDate>2021-01-01</enrollmentEndDate>
      <memberRelationship>OWNER</memberRelationship>
      <membershipPersonStatus>ACTV</membershipPersonStatus>
      <memberId>TIER_BASED_MEM05_M1</memberId>
      <financeRespFlag>Y</financeRespFlag>
      <isMemberSw>Y</isMemberSw>
      <externalMedicareBeneficiaryId>FINS__SD001_P2</
externalMedicareBeneficiaryId>
      <memberCharacteristicList>
        <characteristic>
          <characteristicType>C1SMOKER</characteristicType>
          <characteristicValue>Y</characteristicValue>
          <effectiveDate>2020-01-01</effectiveDate>
        </characteristic>
      </memberCharacteristicList>
      <benefitData>
        <benefitDataList>
          <sequence>1</sequence>
          <startDate>2020-01-01</startDate>
          <endDate>2020-12-31</endDate>
          <benefitStatus>ACTIVE</benefitStatus>
          <benefitSourceFlag>ST</benefitSourceFlag>
          <benefitSubTypeFlag>LEP</benefitSubTypeFlag>
          <planBenefitPackageId>MDCR078_P1</planBenefitPackageId>
          <benefitAmount>1200.25</benefitAmount>
          <benefitCharacteristicsList>
            <characteristic>
              <characteristicType>GENDER</characteristicType>
              <characteristicValue>MALE</characteristicValue>
              <effectiveDate>2020-01-01</effectiveDate>
            </characteristic>
          </benefitCharacteristicsList>
        </benefitDataList>
      </benefitData>
    </memberData>
  </memberDataList>
  <premiumCalculationDetails>
    <premiumCalculation>
      <priceItemCd></priceItemCd>
      <startDt></startDt>
      <endDt></endDt>
      <calcAmt></calcAmt>
      <distAmt></distAmt>
      <currencyCd></currencyCd>
      <acctIdType></acctIdType>
      <acctIdVal></acctIdVal>
      <accountId></accountId>
      <billableChgId></billableChgId>
      <pricingRuleId></pricingRuleId>
      <priceAsgnId></priceAsgnId>

```

```

        <premiumCalcLineDetails>
          <premiumCalcLines>
            <proFactor></proFactor>
            <calcAmt></calcAmt>
            <distAmt></distAmt>
            <month></month>
            <totalCalcAmt></totalCalcAmt>
            <currencyCd></currencyCd>
            <entityTypeFlg></entityTypeFlg>
            <entityId></entityId>
            <referenceIdType></referenceIdType>
            <referenceIdValue></referenceIdValue>
            <pricingParameters></pricingParameters>
            <description></description>
          </premiumCalcLines>
        </premiumCalcLineDetails>
      </premiumCalculation>
    </premiumCalculationDetails>
  </membership>
  <accountBalance>
    <accountBalanceData>
      <accountIdentifierType></accountIdentifierType>
      <accountNumber></accountNumber>
      <accountId></accountId>
      <division></division>
      <sourceSystem></sourceSystem>
      <clExternalTransactionId></clExternalTransactionId>
      <externalSourceId></externalSourceId>
      <accountInfoDtls>
        <currentBalance></currentBalance>
        <lastBillAmount></lastBillAmount>
        <statusCd></statusCd>
        <messageText></messageText>
      </accountInfoDtls>
    </accountBalanceData>
  </accountBalance>
</schema>

```

Sample Group Membership Creation Request and Response in XML Format

Using the below example, you can do the following:

- Create a group membership

Entity Name	Person Type	Policy Number	Plan Number	Main Subscriber
REPRC_SD001_001	Person	REPRC_SD001_BG1_P001	REPRC_SD001_BG1_P001	Me_P1

```

<schema>
  <responseDetails>
    <membershipId></membershipId>
    <responseStatus></responseStatus>
    <message></message>
  </responseDetails>
  <simulationSw>N</simulationSw>
  <action></action>
  <readFilters>
    <dateFilter>
      <startDate></startDate>
      <endDate></endDate>
    </dateFilter>
    <priceItemFilter>
      <priceItemList>

```

```

        <priceItemCode></priceItemCode>
      </priceItemList>
    </priceItemFilter>
  </responseType></responseType>
</readFilters>
<person>
  <personData>
    <sequence>1</sequence>
    <personType>P</personType>
    <personName>
      <sequence>1</sequence>
      <entityName>REPRC_SD001_001_P1,REPRC_SD001_001_P1</entityName>
      <nameType>PRIM</nameType>
    </personName>
    <identifiers>
      <idType>WEB</idType>
      <idValue>REPRC_SD001_001_P1</idValue>
      <isPrimary>Y</isPrimary>
    </identifiers>
    <division>HC</division>
    <birthDate>1982-07-07</birthDate>
    <sinceDate>2019-01-01</sinceDate>
    <address>
      <addressEffDate>2019-01-01</addressEffDate>
      <addressType>MAIN</addressType>
      <mailingName>MR.SEAN MILLER</mailingName>
      <address1>MILLER-CONWAY INC.</address1>
      <address2>7014-G SOUTH PARK</address2>
      <address3>SCOTTSDALE (WEST-SIDE)</address3>
      <address4>ARIZONA</address4>
      <city>SCOTTSDALE</city>
      <state>ARIZONA</state>
      <zip>85250</zip>
      <country>USA</country>
      <houseType>CAPE COD</houseType>
      <streetNumber1>270TH CENTRAL STREET</streetNumber1>
      <streetNumber2>MAIN CLIVE ROAD</streetNumber2>
      <inCityLimit>Y</inCityLimit>
      <taxVendorGeographicalCode></taxVendorGeographicalCode>
      <county>MARICOPA</county>
    </address>
    <email>reprc_sd001_001_pl@ssof.com</email>
    <overrideMailingName1>reprc_sd001_001_pl@ssof.com</
overrideMailingName1>
    <overrideMailingName2>reprc_sd001_001_pl@ssof.com</
overrideMailingName2>
    <overrideMailingName3>reprc_sd001_001_pl@ssof.com</
overrideMailingName3>
    <phones>
      <phoneType>BUSN</phoneType>
      <phoneValue>+1.650.555.0185</phoneValue>
      <extension>7104</extension>
    </phones>
    <relatedPersons>
      <idType>WEB</idType>
      <idValue>FINS_COBRA_109</idValue>
      <personRelationshipType>CHILD</personRelationshipType>
      <startDate>2020-01-01</startDate>
      <endDate>2020-12-31</endDate>
      <financialRelationshipSw>FALSE</financialRelationshipSw>
      <parentOrChild>P</parentOrChild>
      <relatedPersonsCharacteristicsList>
        <characteristic>
          <characteristicType>RP-GAMBL</characteristicType>

```



```

        <characteristicValue>DRCT</characteristicValue>
        <effectiveDate>2020-01-01</effectiveDate>
    </characteristic>
</relatedPersonsCharacteristicsList>
</relatedPersons>
<personCharacteristicList>
    <characteristic>
        <characteristicType>ZZ-BLAGM</characteristicType>
        <characteristicValue>DRCT</characteristicValue>
        <effectiveDate>2020-01-01</effectiveDate>
    </characteristic>
</personCharacteristicList>
<accountData>
    <accountType>ZXS</accountType>
    <customerClass>HC</customerClass>
    <billCycle>AUT</billCycle>
    <billLeadDays></billLeadDays>
    <division>HC</division>
    <currency>USD</currency>
    <setUpDate>2019-01-01</setUpDate>
    <acctUsageFlg></acctUsageFlg>
    <comments></comments>
    <deferAutoPayDt></deferAutoPayDt>
    <collectionClass>HC</collectionClass>
    <billRouteType>EMAIL</billRouteType>
    <billAddressSource>ACCT</billAddressSource>
    <accountIdentifiers>
        <idType>ACCTNM</idType>
        <idValue>FINS_MDCR_SD001_P1_ACCT</idValue>
        <isPrimary>TRUE</isPrimary>
    </accountIdentifiers>
    <characteristics>
        <characteristicsList>
            <characteristicType>C1OFFRST</characteristicType>
            <characteristicValue>1</characteristicValue>
            <effectiveDate>2019-01-01</effectiveDate>
        </characteristicsList>
    </characteristics>
</accountData>
</personData>
</person>
<membership>
    <sourceSystem>ZZPRIME</sourceSystem>
    <policyNumber>REPRC_SD001_BG1_POL1</policyNumber>
    <planNumber>REPRC_SD001_BG1_POL01_P1</planNumber>
    <healthPlanCode></healthPlanCode>
    <startDate>2020-01-01</startDate>
    <endDate>2020-12-31</endDate>
    <boStatusCd></boStatusCd>
    <paidThroughDate>2020-01-01</paidThroughDate>
    <membershipType></membershipType>
    <mainSubscriber>
        <mainSubsIdType>WEB</mainSubsIdType>
        <mainSubsIdValue>REPRC_SD001_001_P1</mainSubsIdValue>
        <membershipType></membershipType>
    </mainSubscriber>
    <autoRenew>N</autoRenew>
    <associatedMemberIdentifierType>AADHR</associatedMemberIdentifierType>
    <associatedMemberIdentifier>HLPN022</associatedMemberIdentifier>
    <exchangeFlag>ON</exchangeFlag>
    <exchangeId>HLPNFSTEST145</exchangeId>
    <binderLiabilityAmount></binderLiabilityAmount>
    <binderPayApplicability></binderPayApplicability>
    <binderPayGraceDays></binderPayGraceDays>

```

```

<binderPayThreshold></binderPayThreshold>
<holdBilling></holdBilling>
<membershipRenewalDate></membershipRenewalDate>
<contractPeriod>0</contractPeriod>
<membershipIdentifierList>
  <membershipIdentifier>
    <membershipIdentifierType>AADHR</membershipIdentifierType>
    <membershipIdentifierValue>HLPN022</membershipIdentifierValue>
  </membershipIdentifier>
</membershipIdentifierList>
<membershipCharacteristicList>
  <characteristic>
    <characteristicType>BILLLV1</characteristicType>
    <characteristicValue>REPRC_SD001_BG1_PARAM1</characteristicValue>
    <effectiveDate>2020-01-01</effectiveDate>
  </characteristic>
</membershipCharacteristicList>
<membershipRateGuarantee>
  <membershipRateGuaranteeList>
    <rateGuaranteeStartDate></rateGuaranteeStartDate>
    <rateGuaranteeEndDate></rateGuaranteeEndDate>
    <rateGuaranteeStatus></rateGuaranteeStatus>
  </membershipRateGuaranteeList>
</membershipRateGuarantee>
<memberDataList>
  <memberData>
    <memberIdType>WEB</memberIdType>
    <memberIdValue>REPRC_SD001_001_P1</memberIdValue>
    <enrollmentStartDate>2020-01-01</enrollmentStartDate>
    <enrollmentEndDate>2020-12-31</enrollmentEndDate>
    <memberRelationship>OWNER</memberRelationship>
    <membershipPersonStatus></membershipPersonStatus>
    <memberId>REPRC_SD001_001_M1</memberId>
    <financeRespFlag>Y</financeRespFlag>
    <isMemberSw>Y</isMemberSw>
    <externalMedicareBeneficiaryId></externalMedicareBeneficiaryId>
    <memberCharacteristicList>
      <characteristic>
        <characteristicType>C1SMOKER</characteristicType>
        <characteristicValue>Y</characteristicValue>
        <effectiveDate>2020-01-01</effectiveDate>
      </characteristic>
    </memberCharacteristicList>
    <benefitData>
      <benefitDataList>
        <sequence>1</sequence>
        <startDate>2020-01-01</startDate>
        <endDate>2020-12-31</endDate>
        <benefitStatus></benefitStatus>
        <benefitSourceFlag>CMS</benefitSourceFlag>
        <benefitSubTypeFlag>D</benefitSubTypeFlag>
        <planBenefitPackageId>801</planBenefitPackageId>
        <benefitAmount>1200.25</benefitAmount>
        <benefitCharacteristicsList>
          <characteristic>
            <characteristicType>C1SMOKER</characteristicType>
            <characteristicValue>Y</characteristicValue>
            <effectiveDate>2020-01-01</effectiveDate>
          </characteristic>
        </benefitCharacteristicsList>
      </benefitDataList>
    </benefitData>
  </memberData>
</memberDataList>

```

```

    <premiumCalculationDetails>
      <premiumCalculation>
        <priceItemCd></priceItemCd>
        <startDt></startDt>
        <endDt></endDt>
        <calcAmt></calcAmt>
        <distAmt></distAmt>
        <currencyCd></currencyCd>
        <acctIdType></acctIdType>
        <acctIdVal></acctIdVal>
        <accountId></accountId>
        <billableChgId></billableChgId>
        <pricingRuleId></pricingRuleId>
        <priceAsgnId></priceAsgnId>
        <premiumCalcLineDetails>
          <premiumCalcLines>
            <proFactor></proFactor>
            <calcAmt></calcAmt>
            <distAmt></distAmt>
            <month></month>
            <totalCalcAmt></totalCalcAmt>
            <currencyCd></currencyCd>
            <entityTypeFlg></entityTypeFlg>
            <entityId></entityId>
            <referenceIdType></referenceIdType>
            <referenceIdValue></referenceIdValue>
            <pricingParameters></pricingParameters>
            <description></description>
          </premiumCalcLines>
        </premiumCalcLineDetails>
      </premiumCalculation>
    </premiumCalculationDetails>
  </membership>
  <accountBalance>
    <accountBalanceData>
      <accountIdentifierType></accountIdentifierType>
      <accountNumber></accountNumber>
      <accountId></accountId>
      <division></division>
      <sourceSystem></sourceSystem>
      <clExternalTransactionId></clExternalTransactionId>
      <externalSourceId></externalSourceId>
      <accountInfoDtls>
        <currentBalance></currentBalance>
        <lastBillAmount></lastBillAmount>
        <statusCd></statusCd>
        <messageText></messageText>
      </accountInfoDtls>
    </accountBalanceData>
  </accountBalance>
</schema>

```

Sample Group Membership Read Request and Response in XML Format

Using the below example, you can do the following:

- View the details of the group membership with the membership Id as **147113405729021**

Person Name	Person Type	Membership ID	Policy Number	Main Subscriber
FINS_GRP013_SEAN, FINS_GRP013_BLIIGNAUT	PERSON	147113405729021	FINS_GRP013_POL1	Yes

```

<schema>
  <responseDetails>
    <membershipId>147113405729021</membershipId>
    <responseStatus>SUCCESS</responseStatus>
    <message></message>
  </responseDetails>
  <simulationSw>Y</simulationSw>
  <action></action>
  <readFilters>
    <dateFilter>
      <startDate>2021-01-01</startDate>
      <endDate>2021-12-31</endDate>
    </dateFilter>
    <priceItemFilter>
      <priceItemList>
        <priceItemCode>MEDPK1</priceItemCode>
      </priceItemList>
    </priceItemFilter>
    <responseType>DT</responseType>
  </readFilters>
  <person>
    <personData>
      <sequence>1</sequence>
      <personType>P</personType>
      <personName>
        <sequence>1</sequence>
        <entityName>FINS_GRP013_SEAN, FINS_GRP013_BLIIGNAUT</entityName>
        <nameType>PRIM</nameType>
      </personName>
      <identifiers>
        <idType>WEB</idType>
        <idValue>FINS_GRP013_P1</idValue>
        <isPrimary>Y</isPrimary>
      </identifiers>
      <division>HC</division>
      <birthDate>1991-01-01</birthDate>
      <sinceDate>2021-01-01</sinceDate>
      <address>
        <addressEffDate>2021-01-01</addressEffDate>
        <addressType>MAIN</addressType>
        <mailingName>MR. SEAN BLIIGNAUT</mailingName>
        <address1>OSPS FINANCIAL SOFTWARE SERVICES</address1>
        <address2>5555-L BLISS RESIDENCY</address2>
        <address3>STATE HIGHWAY 28</address3>
        <address4>NORTH-EAST MAYERS COUNTY</address4>
        <city>BROKEN ARROW</city>
        <state>OKLAHOMA</state>
        <zip>73101</zip>
        <country>USA</country>
        <houseType>COLONIAL</houseType>
        <streetNumber1>270TH CENTRAL STREET</streetNumber1>
        <streetNumber2></streetNumber2>
        <inCityLimit>Y</inCityLimit>
        <taxVendorGeographicalCode>48201</taxVendorGeographicalCode>
        <county>MAYERS</county>
      </address>
      <email>fins_grp013_pl@orafss.com</email>
    </personData>
  </person>

```

```

<overrideMailingName1>fins_grp013_p1@orafss.com</overrideMailingName1>
<overrideMailingName2>fins_grp013_p1@orafss.com</overrideMailingName2>
<overrideMailingName3>fins_grp013_p1@orafss.com</overrideMailingName3>
  <phones>
    <phoneType>HOME</phoneType>
    <phoneValue>+1.612.321.5110</phoneValue>
    <extension></extension>
  </phones>
  <relatedPersons>
    <idType>WEB</idType>
    <idValue>FINS_GRP013_C1</idValue>
    <personRelationshipType>CHILD</personRelationshipType>
    <startDate>2020-01-01</startDate>
    <endDate>2020-12-31</endDate>
    <financialRelationshipSw>FALSE</financialRelationshipSw>
    <parentOrChild>P</parentOrChild>
    <relatedPersonsCharacteristicsList>
      <characteristic>
        <characteristicType>RP-GAMBL</characteristicType>
        <characteristicValue>DRCT</characteristicValue>
        <effectiveDate>2020-01-01</effectiveDate>
      </characteristic>
    </relatedPersonsCharacteristicsList>
  </relatedPersons>
  <personCharacteristicList>
    <characteristic>
      <characteristicType>ZZ-BLAGM</characteristicType>
      <characteristicValue>DRCT</characteristicValue>
      <effectiveDate>2020-01-01</effectiveDate>
    </characteristic>
  </personCharacteristicList>
  <accountData>
    <accountType>ZZS</accountType>
    <customerClass>HC</customerClass>
    <billCycle>AUT</billCycle>
    <billLeadDays></billLeadDays>
    <division>HC</division>
    <currency>USD</currency>
    <setUpDate></setUpDate>
    <acctUsageFlg></acctUsageFlg>
    <comments></comments>
    <deferAutoPayDt></deferAutoPayDt>
    <collectionClass>HC</collectionClass>
    <billRouteType>EMAIL</billRouteType>
    <billAddressSource>ACCT</billAddressSource>
    <accountIdentifiers>
      <idType>ACCTNM</idType>
      <idValue>FINS_GRP013_ACCT1</idValue>
      <isPrimary>TRUE</isPrimary>
    </accountIdentifiers>
    <characteristics>
      <characteristicsList>
        <characteristicType>C1OFFRST</characteristicType>
        <characteristicValue>1</characteristicValue>
        <effectiveDate>2021-01-01</effectiveDate>
      </characteristicsList>
    </characteristics>
  </accountData>
</personData>
</person>
<membership>
  <sourceSystem>PRIME</sourceSystem>
  <policyNumber>FINS_GRP013_POL1</policyNumber>
  <planNumber>FINS_GRP013_POL1_P1</planNumber>

```

```

<healthPlanCode></healthPlanCode>
<startDate>2021-01-01</startDate>
<endDate>2021-12-31</endDate>
<boStatusCd></boStatusCd>
<paidThroughDate>2021-01-01</paidThroughDate>
<membershipType>MDCR</membershipType>
<mainSubscriber>
  <mainSubsIdType>WEB</mainSubsIdType>
  <mainSubsIdValue>FINS_GRP013_SEAN</mainSubsIdValue>
  <membershipType>MDCR</membershipType>
</mainSubscriber>
<autoRenew>N</autoRenew>
<associatedMemberIdentifierType>AADHR</associatedMemberIdentifierType>
<associatedMemberIdentifier>HLPN044</associatedMemberIdentifier>
<exchangeFlag></exchangeFlag>
<exchangeId></exchangeId>
<binderLiabilityAmount></binderLiabilityAmount>
<binderPayApplicability></binderPayApplicability>
<binderPayGraceDays></binderPayGraceDays>
<binderPayThreshold></binderPayThreshold>
<holdBilling></holdBilling>
<membershipRenewalDate>2022-01-01</membershipRenewalDate>
<contractPeriod></contractPeriod>
<membershipIdentifierList>
  <membershipIdentifier>
    <membershipIdentifierType>AADHR</membershipIdentifierType>
    <membershipIdentifierValue>HLPN044</membershipIdentifierValue>
  </membershipIdentifier>
</membershipIdentifierList>
<membershipCharacteristicList>
  <characteristic>
    <characteristicType>BILL_LVL1</characteristicType>
    <characteristicValue>FINS_MDPSCR_AGRT005_IN1_PARAM1</
characteristicValue>
    <effectiveDate>2021-01-01</effectiveDate>
  </characteristic>
</membershipCharacteristicList>
<membershipRateGuarantee>
  <membershipRateGuaranteeList>
    <rateGuaranteeStartDate></rateGuaranteeStartDate>
    <rateGuaranteeEndDate></rateGuaranteeEndDate>
    <rateGuaranteeStatus></rateGuaranteeStatus>
  </membershipRateGuaranteeList>
</membershipRateGuarantee>
<memberDataList>
  <memberData>
    <memberIdType>WEB</memberIdType>
    <memberIdValue>FINS_SEAN</memberIdValue>
    <enrollmentStartDate>2021-01-01</enrollmentStartDate>
    <enrollmentEndDate>2021-12-31</enrollmentEndDate>
    <memberRelationship>OWNER</memberRelationship>
    <membershipPersonStatus>ACTV</membershipPersonStatus>
    <memberId>FINS_SEAN_M1</memberId>
    <financeRespFlag>Y</financeRespFlag>
    <isMemberSw>Y</isMemberSw>
    <externalMedicareBeneficiaryId>FINS_SD001_P2</
externalMedicareBeneficiaryId>
    <memberCharacteristicList>
      <characteristic>
        <characteristicType>C1SMOKER</characteristicType>
        <characteristicValue>Y</characteristicValue>
        <effectiveDate>2020-01-01</effectiveDate>
      </characteristic>
    </memberCharacteristicList>
  </memberData>
</memberDataList>

```

```

    <benefitData>
      <benefitDataList>
        <sequence>1</sequence>
        <startDate>2020-01-01</startDate>
        <endDate>2020-12-31</endDate>
        <benefitStatus>ACTIVE</benefitStatus>
        <benefitSourceFlag>ST</benefitSourceFlag>
        <benefitSubTypeFlag>LIS</benefitSubTypeFlag>
        <planBenefitPackageId>MDCR078_P1</planBenefitPackageId>
        <benefitAmount>100.00</benefitAmount>
        <benefitCharacteristicsList>
          <characteristic>
            <characteristicType>GENDER</characteristicType>
            <characteristicValue>MALE</characteristicValue>
            <effectiveDate>2020-01-01</effectiveDate>
          </characteristic>
        </benefitCharacteristicsList>
      </benefitDataList>
    </memberData>
  </memberDataList>
  <premiumCalculationDetails>
    <premiumCalculation>
      <priceItemCd>LEP</priceItemCd>
      <startDt>01-01-2021</startDt>
      <endDt>12-31-2021</endDt>
      <calcAmt>1500.00</calcAmt>
      <distAmt>100.00</distAmt>
      <currencyCd>USD</currencyCd>
      <acctIdType>ACCT_NM</acctIdType>
      <acctIdVal>REPCBEN1011IN10519S1</acctIdVal>
      <accountId>6573747915</accountId>
      <billableChgId>753035850030</billableChgId>
      <pricingRuleId>181910202193698</pricingRuleId>
      <priceAsgnId>8220029141</priceAsgnId>
      <premiumCalcLineDetails>
        <premiumCalcLines>
          <proFactor>1</proFactor>
          <calcAmt>1500.00</calcAmt>
          <distAmt>100.00</distAmt>
          <month>6</month>
          <totalCalcAmt>1400.00</totalCalcAmt>
          <currencyCd>USD</currencyCd>
          <entityTypeFlg>PERS</entityTypeFlg>
          <entityId>5055198762</entityId>
          <referenceIdType>WEB</referenceIdType>
          <referenceIdValue>FINS_SEAN_MAINSUB</referenceIdValue>
          <pricingParameters>DRUGGIST</pricingParameters>
          <description></description>
        </premiumCalcLines>
      </premiumCalcLineDetails>
    </premiumCalculation>
  </premiumCalculationDetails>
</membership>
<accountBalance>
  <accountBalanceData>
    <accountIdentifierType>ACCT_NM</accountIdentifierType>
    <accountNumber>FINSSEAN1011IN10519S1</accountNumber>
    <accountId>6573747915</accountId>
    <division>HC</division>
    <sourceSystem>PRIME</sourceSystem>
    <clExternalTransactionId></clExternalTransactionId>
    <externalSourceId></externalSourceId>
    <accountInfoDtls>

```

```

        <currentBalance>5000.00</currentBalance>
        <lastBillAmount>1000.00</lastBillAmount>
        <statusCd>SUCCESS</statusCd>
        <messageText></messageText>
    </accountInfoDtls>
</accountBalanceData>
</accountBalance>
</schema>

```

Sample Individual Membership Read Request and Response in XML Format

Using the below example, you can do the following:

- View the details of an individual membership with the membership Id is **018627581362534**

Person Name	Person Type	Membership ID	Policy Number	Main Subscriber
REPC_BEN,REPC_WOAKES	PERSON	018627581362534	REPC_BEN_POL1	Yes

```

<schema>
  <responseDetails>
    <membershipId>018627581362534</membershipId>
    <responseStatus>SUCCESS</responseStatus>
    <message></message>
  </responseDetails>
  <simulationSw>Y</simulationSw>
  <action></action>
  <readFilters>
    <dateFilter>
      <startDate>2021-01-01</startDate>
      <endDate>2021-12-31</endDate>
    </dateFilter>
    <priceItemFilter>
      <priceItemList>
        <priceItemCode>LEP</priceItemCode>
      </priceItemList>
    </priceItemFilter>
    <responseType>DT</responseType>
  </readFilters>
  <person>
    <personData>
      <sequence>1</sequence>
      <personType>P</personType>
      <personName>
        <sequence>1</sequence>
        <entityName>REPC_BEN,REPC_WOAKES</entityName>
        <nameType>PRIM</nameType>
      </personName>
      <identifiers>
        <idType>WEB</idType>
        <idValue>REPC_BEN</idValue>
        <isPrimary>Y</isPrimary>
      </identifiers>
      <division>HC</division>
      <birthDate>1982-07-07</birthDate>
      <sinceDate>2020-01-01</sinceDate>
      <address>
        <addressEffDate>2020-01-01</addressEffDate>
        <addressType>MAIN</addressType>
        <mailingName>BENJAMIN WOAKES</mailingName>
        <address1>THE WOAKES FINS SYSTEMS</address1>
        <address2>7773-K SOUTH WEST PARK</address2>
        <address3>SCOTTSDALE (WEST)</address3>
      </address>
    </personData>
  </person>
</schema>

```



```

    <address4>ARIZONA</address4>
    <city>SCOTTSDALE</city>
    <state>ARIZONA</state>
    <zip>80255</zip>
    <country>USA</country>
    <houseType>RANCH</houseType>
    <streetNumber1>270TH MAIN STREET</streetNumber1>
    <streetNumber2>CENTRAL ROAD</streetNumber2>
    <inCityLimit>Y</inCityLimit>
    <taxVendorGeographicalCode>2020</taxVendorGeographicalCode>
    <county>MARICOPA</county>
</address>
    <email>repc_ben_woakes@osfs.com</email>
    <overrideMailingName1>repc_ben_woakes@osfs.com</overrideMailingName1>
    <overrideMailingName2>repc_ben_woakes@osfs.com</overrideMailingName2>
    <overrideMailingName3>repc_ben_woakes@osfs.com</overrideMailingName3>
    <phones>
        <phoneType>BUSN</phoneType>
        <phoneValue>+1.623.555.6100</phoneValue>
        <extension>1041</extension>
    </phones>
    <phones>
        <phoneType>HOME</phoneType>
        <phoneValue>+1.663.555.3457</phoneValue>
        <extension></extension>
    </phones>
    <relatedPersons>
        <idType>WEB</idType>
        <idValue>REPC_BEN_C1</idValue>
        <personRelationshipType>CHILD</personRelationshipType>
        <startDate>2020-01-01</startDate>
        <endDate>2020-12-31</endDate>
        <financialRelationshipSw>FALSE</financialRelationshipSw>
        <parentOrChild>P</parentOrChild>
        <relatedPersonsCharacteristicsList>
            <characteristic>
                <characteristicType>RP-GAMBL</characteristicType>
                <characteristicValue>DRCT</characteristicValue>
                <effectiveDate>2020-01-01</effectiveDate>
            </characteristic>
        </relatedPersonsCharacteristicsList>
    </relatedPersons>
    <personCharacteristicList>
        <characteristic>
            <characteristicType>ZZ-BLAGM</characteristicType>
            <characteristicValue>DRCT</characteristicValue>
            <effectiveDate>2020-01-01</effectiveDate>
        </characteristic>
    </personCharacteristicList>
    <accountData>
        <accountType>ZZS</accountType>
        <customerClass>HC</customerClass>
        <billCycle>AUT</billCycle>
        <billLeadDays></billLeadDays>
        <division>HC</division>
        <currency>USD</currency>
        <setUpDate></setUpDate>
        <acctUsageFlg></acctUsageFlg>
        <comments></comments>
        <deferAutoPayDt></deferAutoPayDt>
        <collectionClass>HC</collectionClass>
        <billRouteType>EMAIL</billRouteType>
        <billAddressSource>ACCT</billAddressSource>
        <accountIdentifiers>

```

```

        <idType>ACCTNM</idType>
        <idValue>REPC_BEN_ACCT1</idValue>
        <isPrimary>TRUE</isPrimary>
    </accountIdentifiers>
    <characteristics>
        <characteristicsList>
            <characteristicType>C1OFFRST</characteristicType>
            <characteristicValue>1</characteristicValue>
            <effectiveDate>2021-01-01</effectiveDate>
        </characteristicsList>
        <characteristicsList>
            <characteristicType>ZZBLRULE</characteristicType>
            <characteristicValue>TESTMT5</characteristicValue>
            <effectiveDate>2021-01-01</effectiveDate>
        </characteristicsList>
    </characteristics>
</accountData>
</personData>
</person>
<membership>
    <sourceSystem>ZZPRIME</sourceSystem>
    <policyNumber>REPC_BEN_POL1</policyNumber>
    <planNumber>REPC_BEN_POL1_P1</planNumber>
    <healthPlanCode>HLPNFBSTEST145</healthPlanCode>
    <startDate>2021-01-01</startDate>
    <endDate>2021-12-31</endDate>
    <boStatusCd></boStatusCd>
    <paidThroughDate>2021-01-01</paidThroughDate>
    <membershipType>MDCR</membershipType>
    <mainSubscriber>
        <mainSubsIdType>WEB</mainSubsIdType>
        <mainSubsIdValue>REPC_BEN</mainSubsIdValue>
        <membershipType>MDCR</membershipType>
    </mainSubscriber>
    <autoRenew>N</autoRenew>
    <associatedMemberIdentifierType>AADHR</associatedMemberIdentifierType>
    <associatedMemberIdentifier>HLPN022</associatedMemberIdentifier>
    <exchangeFlag>ON</exchangeFlag>
    <exchangeId>HLPNFBSTEST145</exchangeId>
    <binderLiabilityAmount>1500.00</binderLiabilityAmount>
    <binderPayApplicability>Y</binderPayApplicability>
    <binderPayGraceDays>30</binderPayGraceDays>
    <binderPayThreshold>1000</binderPayThreshold>
    <holdBilling>N</holdBilling>
    <membershipRenewalDate>2022-01-01</membershipRenewalDate>
    <contractPeriod>0</contractPeriod>
    <membershipIdentifierList>
        <membershipIdentifier>
            <membershipIdentifierType>AADHR</membershipIdentifierType>
            <membershipIdentifierValue>HLPN022</membershipIdentifierValue>
        </membershipIdentifier>
    </membershipIdentifierList>
    <membershipCharacteristicList>
        <characteristic>
            <characteristicType>BILL_LVL1</characteristicType>
            <characteristicValue>FINS_MDPSCR_AGR005_IN1_PARAM1</
characteristicValue>
            <effectiveDate>2021-01-01</effectiveDate>
        </characteristic>
    </membershipCharacteristicList>
    <membershipRateGuarantee>
        <membershipRateGuaranteeList>
            <rateGuaranteeStartDate>2021-01-01</rateGuaranteeStartDate>
            <rateGuaranteeEndDate>2021-12-31</rateGuaranteeEndDate>

```

```

        <rateGuaranteeStatus>ACTIVE</rateGuaranteeStatus>
      </membershipRateGuaranteeList>
    </membershipRateGuarantee>
  <memberDataList>
    <memberData>
      <memberIdType>WEB</memberIdType>
      <memberIdValue>REPC_BEN</memberIdValue>
      <enrollmentStartDate>2021-01-01</enrollmentStartDate>
      <enrollmentEndDate>2021-12-31</enrollmentEndDate>
      <memberRelationship>OWNER</memberRelationship>
      <membershipPersonStatus>ACTV</membershipPersonStatus>
      <memberId>REPC_BEN_M1</memberId>
      <financeRespFlag>Y</financeRespFlag>
      <isMemberSw>Y</isMemberSw>
      <externalMedicareBeneficiaryId>FINS_SD001_P2</
externalMedicareBeneficiaryId>
      <memberCharacteristicList>
        <characteristic>
          <characteristicType>CLSMOKER</characteristicType>
          <characteristicValue>Y</characteristicValue>
          <effectiveDate>2020-01-01</effectiveDate>
        </characteristic>
      </memberCharacteristicList>
      <benefitData>
        <benefitDataList>
          <sequence>1</sequence>
          <startDate>2020-01-01</startDate>
          <endDate>2020-12-31</endDate>
          <benefitStatus>ACTIVE</benefitStatus>
          <benefitSourceFlag>ST</benefitSourceFlag>
          <benefitSubTypeFlag>LEP</benefitSubTypeFlag>
          <planBenefitPackageId>MDCR078_P1</planBenefitPackageId>
          <benefitAmount>1500.00</benefitAmount>
          <benefitCharacteristicsList>
            <characteristic>
              <characteristicType>GENDER</characteristicType>
              <characteristicValue>MALE</characteristicValue>
              <effectiveDate>2020-01-01</effectiveDate>
            </characteristic>
          </benefitCharacteristicsList>
        </benefitDataList>
      </benefitData>
    </memberData>
  </memberDataList>
  <premiumCalculationDetails>
    <premiumCalculation>
      <priceItemCd>LEP</priceItemCd>
      <startDt>2021-01-01</startDt>
      <endDt>2021-12-31</endDt>
      <calcAmt>1500.00</calcAmt>
      <distAmt>0</distAmt>
      <currencyCd>USD</currencyCd>
      <acctIdType>ACCT_NM</acctIdType>
      <acctIdVal>REPCBEN1011IN10519S1</acctIdVal>
      <accountId>6573747915</accountId>
      <billableChgId>753035850030</billableChgId>
      <pricingRuleId>181910202193698</pricingRuleId>
      <priceAsgnId>8220029141</priceAsgnId>
      <premiumCalcLineDetails>
        <premiumCalcLines>
          <proFactor>1</proFactor>
          <calcAmt>1500.00</calcAmt>
          <distAmt>0</distAmt>
          <month>0</month>
        </premiumCalcLines>
      </premiumCalcLineDetails>
    </premiumCalculation>
  </premiumCalculationDetails>

```

```

        <totalCalcAmt>1500.00</totalCalcAmt>
        <currencyCd>USD</currencyCd>
        <entityTypeFlg>PERS</entityTypeFlg>
        <entityId>5055198762</entityId>
        <referenceIdType>WEB</referenceIdType>
        <referenceIdValue>REPC_BEN_MAINSUB</referenceIdValue>
        <pricingParameters>DRUGGIST</pricingParameters>
        <description></description>
    </premiumCalcLines>
</premiumCalcLineDetails>
</premiumCalculation>
</premiumCalculationDetails>
</membership>
<accountBalance>
    <accountBalanceData>
        <accountIdentifierType>ACCT_NM</accountIdentifierType>
        <accountNumber>REPCBEN1011IN10519S1</accountNumber>
        <accountId>6573747915</accountId>
        <division>HC</division>
        <sourceSystem>ZZPRIME</sourceSystem>
        <clExternalTransactionId></clExternalTransactionId>
        <externalSourceId></externalSourceId>
        <accountInfoDtls>
            <currentBalance>3000.00</currentBalance>
            <lastBillAmount>1500.00</lastBillAmount>
            <statusCd>SUCCESS</statusCd>
            <messageText></messageText>
        </accountInfoDtls>
    </accountBalanceData>
</accountBalance>
</schema>

```

Sample Member Person Creation Read Request and Response in XML Format

The following code snippet illustrates how the tags are nested in the membership repricing inbound web service schema:

```

<schema>
    <responseDetails>
        <membershipId>998162301690408</membershipId>
        <responseStatus>SUCCESS</responseStatus>
        <message></message>
    </responseDetails>
    <simulationSw>N</simulationSw>
    <action></action>
    <readFilters>
        <dateFilter>
            <startDate>01-01-2020</startDate>
            <endDate>12-31-2020</endDate>
        </dateFilter>
        <priceItemFilter>
            <priceItemList>
                <priceItemCode>AGEBASED_PROD2_INLOC</priceItemCode>
            </priceItemList>
        </priceItemFilter>
        <responseType>DT</responseType>
    </readFilters>
    <person>
        <personData>
            <sequence></sequence>
            <personType></personType>
            <personName>
                <sequence></sequence>
                <entityName></entityName>
                <nameType></nameType>
            </personName>
        </personData>
    </person>
</schema>

```

```

</personName>
<identifiers>
  <idType></idType>
  <idValue></idValue>
  <isPrimary></isPrimary>
</identifiers>
<division></division>
<birthDate></birthDate>
<sinceDate></sinceDate>
<address>
  <addressEffDate></addressEffDate>
  <addressType></addressType>
  <mailingName></mailingName>
  <address1></address1>
  <address2></address2>
  <address3></address3>
  <address4></address4>
  <city></city>
  <state></state>
  <zip></zip>
  <country></country>
  <houseType></houseType>
  <streetNumber1></streetNumber1>
  <streetNumber2></streetNumber2>
  <inCityLimit></inCityLimit>
  <taxVendorGeographicalCode></taxVendorGeographicalCode>
  <county></county>
</address>
<email></email>
<overrideMailingName1></overrideMailingName1>
<overrideMailingName2></overrideMailingName2>
<overrideMailingName3></overrideMailingName3>
<phones>
  <phoneType></phoneType>
  <phoneValue></phoneValue>
  <extension></extension>
</phones>
<relatedPersons>
  <idType></idType>
  <idValue></idValue>
  <personRelationshipType></personRelationshipType>
  <startDate></startDate>
  <endDate></endDate>
  <financialRelationshipSw></financialRelationshipSw>
  <parentOrChild></parentOrChild>
  <relatedPersonsCharacteristicsList>
    <characteristic>
      <characteristicType></characteristicType>
      <characteristicValue></characteristicValue>
      <effectiveDate></effectiveDate>
    </characteristic>
  </relatedPersonsCharacteristicsList>
</relatedPersons>
<personCharacteristicList>
  <characteristic>
    <characteristicType></characteristicType>
    <characteristicValue></characteristicValue>
    <effectiveDate></effectiveDate>
  </characteristic>
</personCharacteristicList>
<accountData>
  <accountType></accountType>
  <customerClass></customerClass>
  <billCycle></billCycle>

```

```

        <billLeadDays></billLeadDays>
        <division></division>
        <currency></currency>
        <setUpDate></setUpDate>
        <acctUsageFlg></acctUsageFlg>
        <comments></comments>
        <deferAutoPayDt></deferAutoPayDt>
        <collectionClass></collectionClass>
        <billRouteType></billRouteType>
        <billAddressSource></billAddressSource>
        <accountIdentifiers>
            <idType></idType>
            <idValue></idValue>
            <isPrimary></isPrimary>
        </accountIdentifiers>
        <characteristics>
            <characteristicsList>
                <characteristicType></characteristicType>
                <characteristicValue></characteristicValue>
                <effectiveDate></effectiveDate>
            </characteristicsList>
        </characteristics>
    </accountData>
</personData>
</person>
<membership>
    <sourceSystem>ZZLOCPRIME</sourceSystem>
    <policyNumber>FINS_COBRA_LOC_0099_BG1_POL1</policyNumber>
    <planNumber>FINS_COBRA_LOC_0099_BG1_POL1_P1</planNumber>
    <healthPlanCode></healthPlanCode>
    <startDate>01-01-2020</startDate>
    <endDate>12-31-2020</endDate>
    <boStatusCd></boStatusCd>
    <paidThroughDate></paidThroughDate>
    <membershipType>COBRA</membershipType>
    <mainSubscriber>
        <mainSubsIdType></mainSubsIdType>
        <mainSubsIdValue></mainSubsIdValue>
        <membershipType></membershipType>
    </mainSubscriber>
    <autoRenew></autoRenew>
    <associatedMemberIdentifierType></associatedMemberIdentifierType>
    <associatedMemberIdentifier></associatedMemberIdentifier>
    <exchangeFlag></exchangeFlag>
    <exchangeId></exchangeId>
    <binderLiabilityAmount></binderLiabilityAmount>
    <binderPayApplicability></binderPayApplicability>
    <binderPayGraceDays></binderPayGraceDays>
    <binderPayThreshold></binderPayThreshold>
    <holdBilling></holdBilling>
    <membershipRenewalDate></membershipRenewalDate>
    <contractPeriod></contractPeriod>
    <membershipIdentifierList>
        <membershipIdentifier>
            <membershipIdentifierType></membershipIdentifierType>
            <membershipIdentifierValue></membershipIdentifierValue>
        </membershipIdentifier>
    </membershipIdentifierList>
    <membershipCharacteristicList>
        <characteristic>
            <characteristicType>BL_1</characteristicType>
            <characteristicValue>FINS_COBRA_LOC_0099_BG1_PARAM1</
characteristicValue>
            <effectiveDate>01-01-2020</effectiveDate>

```

```

    </characteristic>
  </membershipCharacteristicList>
  <membershipRateGuarantee>
    <membershipRateGuaranteeList>
      <rateGuaranteeStartDate></rateGuaranteeStartDate>
      <rateGuaranteeEndDate></rateGuaranteeEndDate>
      <rateGuaranteeStatus></rateGuaranteeStatus>
    </membershipRateGuaranteeList>
  </membershipRateGuarantee>
  <memberDataList>
    <memberData>
      <memberIdType>WEB</memberIdType>
      <memberIdValue>FINS_COBRA_LOC_0098_P1</memberIdValue>
      <enrollmentStartDate>01-01-2020</enrollmentStartDate>
      <enrollmentEndDate>12-31-2020</enrollmentEndDate>
      <memberRelationship>OWNER</memberRelationship>
      <membershipPersonStatus>ACTIVE</membershipPersonStatus>
      <memberId>FINS_COBRA_LOC_0099_M1</memberId>
      <financeRespFlag>Y</financeRespFlag>
      <isMemberSw>Y</isMemberSw>
      <externalMedicareBeneficiaryId>FINS_COBRA_LOC_0098_P1</
externalMedicareBeneficiaryId>
      <memberCharacteristicList>
        <characteristic>
          <characteristicType>SMOKER</characteristicType>
          <characteristicValue>Y</characteristicValue>
          <effectiveDate>01-01-2020</effectiveDate>
        </characteristic>
      </memberCharacteristicList>
      <benefitData>
        <benefitDataList>
          <sequence>1</sequence>
          <startDate>01-01-2020</startDate>
          <endDate>12-31-2020</endDate>
          <benefitStatus>ACTIVE</benefitStatus>
          <benefitSourceFlag>CMS</benefitSourceFlag>
          <benefitSubTypeFlag>LEP</benefitSubTypeFlag>
          <planBenefitPackageId>MDCR078_P1</planBenefitPackageId>
          <benefitAmount>1100.25</benefitAmount>
          <benefitCharacteristicsList>
            <characteristic>
              <characteristicType>GENDER</characteristicType>
              <characteristicValue>MALE</characteristicValue>
              <effectiveDate>2020-01-01</effectiveDate>
            </characteristic>
          </benefitCharacteristicsList>
        </benefitDataList>
      </benefitData>
    </memberData>
  </memberDataList>
  <premiumCalculationDetails>
    <premiumCalculation>
      <priceItemCd></priceItemCd>
      <startDt></startDt>
      <endDt></endDt>
      <calcAmt></calcAmt>
      <distAmt></distAmt>
      <currencyCd></currencyCd>
      <acctIdType></acctIdType>
      <acctIdVal></acctIdVal>
      <accountId></accountId>
      <billableChgId></billableChgId>
      <pricingRuleId></pricingRuleId>
      <priceAsgnId></priceAsgnId>

```

```

        <premiumCalcLineDetails>
            <premiumCalcLines>
                <proFactor></proFactor>
                <calcAmt></calcAmt>
                <distAmt></distAmt>
                <month></month>
                <totalCalcAmt></totalCalcAmt>
                <currencyCd></currencyCd>
                <entityTypeFlg></entityTypeFlg>
                <entityId></entityId>
                <referenceIdType></referenceIdType>
                <referenceIdValue></referenceIdValue>
                <pricingParameters></pricingParameters>
                <description></description>
            </premiumCalcLines>
        </premiumCalcLineDetails>
    </premiumCalculation>
</premiumCalculationDetails>
</membership>
<accountBalance>
    <accountBalanceData>
        <accountIdentifierType></accountIdentifierType>
        <accountNumber></accountNumber>
        <accountId></accountId>
        <division></division>
        <sourceSystem></sourceSystem>
        <clExternalTransactionId></clExternalTransactionId>
        <externalSourceId></externalSourceId>
        <accountInfoDtls>
            <currentBalance></currentBalance>
            <lastBillAmount></lastBillAmount>
            <statusCd></statusCd>
            <messageText></messageText>
        </accountInfoDtls>
    </accountBalanceData>
</accountBalance>
</schema>

```

Sample Individual Membership Premium Simulation Request and Response in XML Format

Using the below example, you can do the following:

- Simulate the premium calculation process for an individual membership

Person Name	Person Type	Policy Number	Plan Number	Main Subscriber
REPRC1011_MAINSUB	PERSON	REPRC1011_POLICY	REPRC1011_DENTAL_PLAN	PLAN

```

<schema>
    <responseDetails>
        <membershipId>229160661076798</membershipId>
        <responseStatus>SUCCESS</responseStatus>
        <message></message>
    </responseDetails>
    <simulationSw>Y</simulationSw>
    <action></action>
    <readFilters>
        <dateFilter>
            <startDate></startDate>
            <endDate></endDate>
        </dateFilter>
        <priceItemFilter>

```



```

        <priceItemList>
            <priceItemCode></priceItemCode>
        </priceItemList>
    </priceItemFilter>
    <responseType></responseType>
</readFilters>
<person>
    <personData>
        <sequence>1</sequence>
        <personType>P</personType>
        <personName>
            <sequence>1</sequence>
            <entityName>REPRC1011_MAINSUB</entityName>
            <nameType>P</nameType>
        </personName>
        <identifiers>
            <idType>WEB</idType>
            <idValue>REPRC1011_MAINSUB</idValue>
            <isPrimary>Y</isPrimary>
        </identifiers>
        <division>HC</division>
        <birthDate>1982-07-07</birthDate>
        <sinceDate>2019-01-01</sinceDate>
        <address>
            <addressEffDate>2019-01-01</addressEffDate>
            <addressType>MAIN</addressType>
            <mailingName>MR.JAMES BENNETT</mailingName>
            <address1>FINS COBRA SOFTWARE SERVICES</address1>
            <address2>BESIDES HUB MALL</address2>
            <address3>OPPOSITE TO WEH</address3>
            <address4>THANES CITY</address4>
            <city>DALLAS</city>
            <state>TX</state>
            <zip>400081</zip>
            <country>USA</country>
            <houseType>RANCH</houseType>
            <streetNumber1></streetNumber1>
            <streetNumber2></streetNumber2>
            <inCityLimit></inCityLimit>
            <taxVendorGeographicalCode></taxVendorGeographicalCode>
            <county></county>
        </address>
        <email>reprc_sd001_001_pl@sofs.com</email>
        <overrideMailingName1>reprc_sd001_001_pl@sofs.com</
overrideMailingName1>
        <overrideMailingName2>reprc_sd001_001_pl@sofs.com</
overrideMailingName2>
        <overrideMailingName3>reprc_sd001_001_pl@sofs.com</
overrideMailingName3>
        <phones>
            <phoneType>BUSN</phoneType>
            <phoneValue>+1.610.415.7111</phoneValue>
            <extension>250</extension>
        </phones>
        <relatedPersons>
            <idType></idType>
            <idValue></idValue>
            <personRelationshipType></personRelationshipType>
            <startDate></startDate>
            <endDate></endDate>
            <financialRelationshipSw></financialRelationshipSw>
            <parentOrChild></parentOrChild>
            <relatedPersonsCharacteristicsList>
                <characteristic>

```

```

        <characteristicType></characteristicType>
        <characteristicValue></characteristicValue>
        <effectiveDate></effectiveDate>
    </characteristic>
</relatedPersonsCharacteristicsList>
</relatedPersons>
<personCharacteristicList>
    <characteristic>
        <characteristicType></characteristicType>
        <characteristicValue></characteristicValue>
        <effectiveDate></effectiveDate>
    </characteristic>
</personCharacteristicList>
<accountData>
    <accountType></accountType>
    <customerClass></customerClass>
    <billCycle></billCycle>
    <billLeadDays></billLeadDays>
    <division></division>
    <currency></currency>
    <setUpDate></setUpDate>
    <acctUsageFlg></acctUsageFlg>
    <comments></comments>
    <deferAutoPayDt></deferAutoPayDt>
    <collectionClass></collectionClass>
    <billRouteType></billRouteType>
    <billAddressSource></billAddressSource>
    <accountIdentifiers>
        <idType></idType>
        <idValue></idValue>
        <isPrimary></isPrimary>
    </accountIdentifiers>
    <characteristics>
        <characteristicsList>
            <characteristicType></characteristicType>
            <characteristicValue></characteristicValue>
            <effectiveDate></effectiveDate>
        </characteristicsList>
    </characteristics>
</accountData>
</personData>
</person>
<membership>
    <sourceSystem>UHG</sourceSystem>
    <policyNumber>REPRC1011_POLICY</policyNumber>
    <planNumber></planNumber>
    <healthPlanCode>REPRC1011_DENTAL_PLAN</healthPlanCode>
    <startDate>2019-01-01</startDate>
    <endDate>2019-12-31</endDate>
    <boStatusCd></boStatusCd>
    <paidThroughDate>2019-01-01</paidThroughDate>
    <membershipType></membershipType>
    <mainSubscriber>
        <mainSubsIdType>WEB</mainSubsIdType>
        <mainSubsIdValue>REPRC1011_MAINSUB</mainSubsIdValue>
        <membershipType></membershipType>
    </mainSubscriber>
    <autoRenew>N</autoRenew>
    <associatedMemberIdentifierType></associatedMemberIdentifierType>
    <associatedMemberIdentifier></associatedMemberIdentifier>
    <exchangeFlag>ON</exchangeFlag>
    <exchangeId>HPLN027</exchangeId>
    <binderLiabilityAmount>600</binderLiabilityAmount>
    <binderPayApplicability>y</binderPayApplicability>

```

```

<binderPayGraceDays>10</binderPayGraceDays>
<binderPayThreshold>400</binderPayThreshold>
<holdBilling>N</holdBilling>
<membershipRenewalDate></membershipRenewalDate>
<contractPeriod>0</contractPeriod>
<membershipIdentifierList>
  <membershipIdentifier>
    <membershipIdentifierType>AADHAR</membershipIdentifierType>
    <membershipIdentifierValue>HLPN022</membershipIdentifierValue>
  </membershipIdentifier>
</membershipIdentifierList>
<membershipCharacteristicList>
  <characteristic>
    <characteristicType>BL_1</characteristicType>
    <characteristicValue>REPRC1011</characteristicValue>
    <effectiveDate>2019-01-01</effectiveDate>
  </characteristic>
</membershipCharacteristicList>
<membershipRateGuarantee>
  <membershipRateGuaranteeList>
    <rateGuaranteeStartDate>2019-01-01</rateGuaranteeStartDate>
    <rateGuaranteeEndDate>2019-12-31</rateGuaranteeEndDate>
    <rateGuaranteeStatus>ACTIVE</rateGuaranteeStatus>
  </membershipRateGuaranteeList>
</membershipRateGuarantee>
<memberDataList>
  <memberData>
    <memberIdType>WEB</memberIdType>
    <memberIdValue>REPRC1011_MAINSUB</memberIdValue>
    <enrollmentStartDate>2019-01-01</enrollmentStartDate>
    <enrollmentEndDate>2019-12-31</enrollmentEndDate>
    <memberRelationship>OWNER</memberRelationship>
    <membershipPersonStatus>ACTIVE</membershipPersonStatus>
    <memberId>REPRC_SD001_001_M1</memberId>
    <financeRespFlag>Y</financeRespFlag>
    <isMemberSw>Y</isMemberSw>
    <externalMedicareBeneficiaryId></externalMedicareBeneficiaryId>
    <memberCharacteristicList>
      <characteristic>
        <characteristicType>DRUGGIST</characteristicType>
        <characteristicValue>Y</characteristicValue>
        <effectiveDate>2019-01-01</effectiveDate>
      </characteristic>
    </memberCharacteristicList>
    <benefitData>
      <benefitDataList>
        <sequence></sequence>
        <startDate></startDate>
        <endDate></endDate>
        <benefitStatus></benefitStatus>
        <benefitSourceFlag></benefitSourceFlag>
        <benefitSubTypeFlag></benefitSubTypeFlag>
        <planBenefitPackageId></planBenefitPackageId>
        <benefitAmount></benefitAmount>
        <benefitCharacteristicsList>
          <characteristic>
            <characteristicType></characteristicType>
            <characteristicValue></characteristicValue>
            <effectiveDate></effectiveDate>
          </characteristic>
        </benefitCharacteristicsList>
      </benefitDataList>
    </benefitData>
  </memberData>
</memberDataList>

```

```

</memberDataList>
<premiumCalculationDetails>
  <premiumCalculation>
    <priceItemCd>DENTAL</priceItemCd>
    <startDt>2019-01-01</startDt>
    <endDt>2019-02-31</endDt>
    <calcAmt>200.00</calcAmt>
    <distAmt>0</distAmt>
    <currencyCd>USD</currencyCd>
    <acctIdType>ACCT_NM</acctIdType>
    <acctIdVal>REPRC1011BG10519S1</acctIdVal>
    <accountId>6573747915</accountId>
    <billableChgId>094032550028</billableChgId>
    <pricingRuleId>181910202193698</pricingRuleId>
    <priceAsgnId>8220029141</priceAsgnId>
    <premiumCalcLineDetails>
      <premiumCalcLines>
        <proFactor>1</proFactor>
        <calcAmt>200.000000000000000000</calcAmt>
        <distAmt>0</distAmt>
        <month>0</month>
        <totalCalcAmt>0</totalCalcAmt>
        <currencyCd>USD</currencyCd>
        <entityTypeFlg>PERS</entityTypeFlg>
        <entityId>5055198762</entityId>
        <referenceIdType>WEB</referenceIdType>
        <referenceIdValue>REPRC1011_MAINSUB</referenceIdValue>
        <pricingParameters>AGEBASED</pricingParameters>
        <description>AGE BASED PARAMETER</description>
      </premiumCalcLines>
    </premiumCalcLineDetails>
  </premiumCalculation>
</premiumCalculationDetails>
</membership>
<accountBalance>
  <accountBalanceData>
    <accountIdentifierType></accountIdentifierType>
    <accountNumber></accountNumber>
    <accountId></accountId>
    <division></division>
    <sourceSystem></sourceSystem>
    <clExternalTransactionId></clExternalTransactionId>
    <externalSourceId></externalSourceId>
    <accountInfoDtls>
      <currentBalance></currentBalance>
      <lastBillAmount></lastBillAmount>
      <statusCd></statusCd>
      <messageText></messageText>
    </accountInfoDtls>
  </accountBalanceData>
</accountBalance>
</schema>

```

Sample Group Membership Premium Simulation Request and Response in XML Format

Using the below example, you can do the following:

- Simulate the premium calculation process for a group membership.

Person Name	Person Type	Policy Number	Plan Number	Main Subscriber
FINS_COBRA_LOC0098_P1	PERSON	FINS_COBRA_LOC0098_P1	FINS_COBRA_LOC0098_P1	YESPOL1_P1

```

<schema>
  <responseDetails>
    <membershipId>998162301690408</membershipId>
    <responseStatus>SUCCESS</responseStatus>
    <message></message>
  </responseDetails>
  <simulationSw>Y</simulationSw>
  <action></action>
  <readFilters>
    <dateFilter>
      <startDate></startDate>
      <endDate></endDate>
    </dateFilter>
    <priceItemFilter>
      <priceItemList>
        <priceItemCode></priceItemCode>
      </priceItemList>
    </priceItemFilter>
    <responseType></responseType>
  </readFilters>
  <person>
    <personData>
      <sequence>1</sequence>
      <personType>P</personType>
      <personName>
        <sequence>1</sequence>
        <entityName>FINS_COBRA_LOC0098_P1</entityName>
        <nameType>P</nameType>
      </personName>
      <identifiers>
        <idType>WEB</idType>
        <idValue>FINS_COBRA_LOC0098_P1</idValue>
        <isPrimary>Y</isPrimary>
      </identifiers>
      <division>HC</division>
      <birthDate>01-01-1991</birthDate>
      <sinceDate>2019-01-01</sinceDate>
      <address>
        <addressEffDate>2019-01-01</addressEffDate>
        <addressType>MAIN</addressType>
        <mailingName>MR.SETH JAMIESON</mailingName>
        <address1>FINS COBRA SOFTWARE SERVICES</address1>
        <address2>BESIDES HUB MALL</address2>
        <address3>OPPOSITE TO WEH</address3>
        <address4>THANE VALLEY</address4>
        <city>TULSA</city>
        <state>OKLAHOMA</state>
        <zip>74014</zip>
        <country>USA</country>
        <houseType>RANCH</houseType>
        <streetNumber1></streetNumber1>
        <streetNumber2></streetNumber2>
        <inCityLimit>Y</inCityLimit>
        <taxVendorGeographicalCode></taxVendorGeographicalCode>
        <county></county>
      </address>
      <email>fins_cobra_LOC0098_pl@finscobra.com</email>
      <overrideMailingName1>fins_cobra_LOC0098_pl@finscobra.com</
overrideMailingName1>

```

```

        <overrideMailingName2>fins_cobra_LOC0098_p1@finscobra.com</
overrideMailingName2>
        <overrideMailingName3>fins_cobra_LOC0098_p1@finscobra.com</
overrideMailingName3>
        <phones>
            <phoneType>BUSN</phoneType>
            <phoneValue>+1.503.444.5100</phoneValue>
            <extension>523</extension>
        </phones>
        <relatedPersons>
            <idType></idType>
            <idValue></idValue>
            <personRelationshipType></personRelationshipType>
            <startDate></startDate>
            <endDate></endDate>
            <financialRelationshipSw></financialRelationshipSw>
            <parentOrChild></parentOrChild>
            <relatedPersonsCharacteristicsList>
                <characteristic>
                    <characteristicType></characteristicType>
                    <characteristicValue></characteristicValue>
                    <effectiveDate></effectiveDate>
                </characteristic>
            </relatedPersonsCharacteristicsList>
        </relatedPersons>
        <personCharacteristicList>
            <characteristic>
                <characteristicType>COBRA BILLING ARRANGEMENT</characteristicType>
                <characteristicValue>DRCT</characteristicValue>
                <effectiveDate>01-01-2020</effectiveDate>
            </characteristic>
        </personCharacteristicList>
        <accountData>
            <accountType>CMS</accountType>
            <customerClass>HC</customerClass>
            <billCycle>AUT</billCycle>
            <billLeadDays>0</billLeadDays>
            <division>HC</division>
            <currency>USD</currency>
            <setUpDate>12-14-2020</setUpDate>
            <acctUsageFlg></acctUsageFlg>
            <comments></comments>
            <deferAutoPayDt></deferAutoPayDt>
            <collectionClass>FINANCIAL SERVICES</collectionClass>
            <billRouteType>EMAIL</billRouteType>
            <billAddressSource>MAO</billAddressSource>
            <accountIdentifiers>
                <idType>ACCOUNT NAME</idType>
                <idValue>FINS_COBRA_LOC0098_P1_ACCL</idValue>
                <isPrimary>TRUE</isPrimary>
            </accountIdentifiers>
            <characteristics>
                <characteristicsList>
                    <characteristicType>INVOICE TYPE</characteristicType>
                    <characteristicValue>CMS</characteristicValue>
                    <effectiveDate>01-01-2020</effectiveDate>
                </characteristicsList>
            </characteristics>
        </accountData>
    </personData>
</person>
<membership>
    <sourceSystem>ZZLOCPRIME</sourceSystem>
    <policyNumber>FINS_COBRALOC0099_BG1_POL1</policyNumber>

```

```

<planNumber>FINS_COBRALOC0099_BG1_POL1_P1</planNumber>
<healthPlanCode></healthPlanCode>
<startDate>01-01-2020</startDate>
<endDate>12-31-2020</endDate>
<boStatusCd></boStatusCd>
<paidThroughDate></paidThroughDate>
<membershipType>COBRA</membershipType>
<mainSubscriber>
  <mainSubsIdType>WEB</mainSubsIdType>
  <mainSubsIdValue>FINS_COBRA_LOC0098_P1</mainSubsIdValue>
  <membershipType>COBRA</membershipType>
</mainSubscriber>
<autoRenew></autoRenew>
<associatedMemberIdentifierType></associatedMemberIdentifierType>
<associatedMemberIdentifier></associatedMemberIdentifier>
<exchangeFlag></exchangeFlag>
<exchangeId></exchangeId>
<binderLiabilityAmount></binderLiabilityAmount>
<binderPayApplicability></binderPayApplicability>
<binderPayGraceDays></binderPayGraceDays>
<binderPayThreshold></binderPayThreshold>
<holdBilling></holdBilling>
<membershipRenewalDate></membershipRenewalDate>
<contractPeriod></contractPeriod>
<membershipIdentifierList>
  <membershipIdentifier>
    <membershipIdentifierType></membershipIdentifierType>
    <membershipIdentifierValue></membershipIdentifierValue>
  </membershipIdentifier>
</membershipIdentifierList>
<membershipCharacteristicList>
  <characteristic>
    <characteristicType>BL_1</characteristicType>
    <characteristicValue>FINS_COBRA_LOC0098_BG1_PARAM1</
characteristicValue>
    <effectiveDate>01-01-2020</effectiveDate>
  </characteristic>
</membershipCharacteristicList>
<membershipRateGuarantee>
  <membershipRateGuaranteeList>
    <rateGuaranteeStartDate></rateGuaranteeStartDate>
    <rateGuaranteeEndDate></rateGuaranteeEndDate>
    <rateGuaranteeStatus></rateGuaranteeStatus>
  </membershipRateGuaranteeList>
</membershipRateGuarantee>
<memberDataList>
  <memberData>
    <memberIdType>WEB</memberIdType>
    <memberIdValue>FINS_COBRA_LOC0098_P1</memberIdValue>
    <enrollmentStartDate>2019-01-01</enrollmentStartDate>
    <enrollmentEndDate>2019-12-31</enrollmentEndDate>
    <memberRelationship>OWNER</memberRelationship>
    <membershipPersonStatus>ACTIVE</membershipPersonStatus>
    <memberId>FINS_COBRA_LOC0090_M1</memberId>
    <financeRespFlag>Y</financeRespFlag>
    <isMemberSw>Y</isMemberSw>
    <externalMedicareBeneficiaryId>FINS_COBRA_LOC0099_P1</
externalMedicareBeneficiaryId>
    <memberCharacteristicList>
      <characteristic>
        <characteristicType>DRUGGIST</characteristicType>
        <characteristicValue>Y</characteristicValue>
        <effectiveDate>2019-01-01</effectiveDate>
      </characteristic>

```

```

    </memberCharacteristicList>
    <benefitData>
      <benefitDataList>
        <sequence>01</sequence>
        <startDate>01-01-2020</startDate>
        <endDate>12-31-2020</endDate>
        <benefitStatus>ACTIVE</benefitStatus>
        <benefitSourceFlag>CMS</benefitSourceFlag>
        <benefitSubTypeFlag>D</benefitSubTypeFlag>
        <planBenefitPackageId>801</planBenefitPackageId>
        <benefitAmount>1200.25</benefitAmount>
        <benefitCharacteristicsList>
          <characteristic>
            <characteristicType>C1-GENDR</characteristicType>
            <characteristicValue>MALE</characteristicValue>
            <effectiveDate>2019-01-01</effectiveDate>
          </characteristic>
        </benefitCharacteristicsList>
      </benefitDataList>
    </benefitData>
  </memberData>
</memberDataList>
<premiumCalculationDetails>
  <premiumCalculation>
    <priceItemCd>LIS</priceItemCd>
    <startDt>2019-12-01</startDt>
    <endDt>2019-12-31</endDt>
    <calcAmt>100.00</calcAmt>
    <distAmt>0</distAmt>
    <currencyCd>USD</currencyCd>
    <acctIdType>ACCT_NM</acctIdType>
    <acctIdVal>FINS_COBRA_LOC0099_BG1_ACC1</acctIdVal>
    <accountId>1344089342</accountId>
    <billableChgId>658034050591</billableChgId>
    <pricingRuleId>262212202052080</pricingRuleId>
    <priceAsgnId>8220029141</priceAsgnId>
    <premiumCalcLineDetails>
      <premiumCalcLines>
        <proFactor>1</proFactor>
        <calcAmt>100.00</calcAmt>
        <distAmt>0</distAmt>
        <month>0</month>
        <totalCalcAmt>0</totalCalcAmt>
        <currencyCd>USD</currencyCd>
        <entityTypeFlg>PERS</entityTypeFlg>
        <entityId>5055198762</entityId>
        <referenceIdType>WEB</referenceIdType>
        <referenceIdValue>FINS_COBRA_LOC0098_P1</referenceIdValue>
        <pricingParameters>AGEBASED</pricingParameters>
        <description>AGE BASED PARAMETER</description>
      </premiumCalcLines>
    </premiumCalcLineDetails>
  </premiumCalculation>
</premiumCalculationDetails>
</membership>
<accountBalance>
  <accountBalanceData>
    <accountIdentifierType></accountIdentifierType>
    <accountNumber></accountNumber>
    <accountId></accountId>
    <division></division>
    <sourceSystem></sourceSystem>
    <clExternalTransactionId></clExternalTransactionId>
    <externalSourceId></externalSourceId>
  </accountBalanceData>
</accountBalance>

```



```

    <accountInfoDtls>
      <currentBalance></currentBalance>
      <lastBillAmount></lastBillAmount>
      <statusCd></statusCd>
      <messageText></messageText>
    </accountInfoDtls>
  </accountBalanceData>
</accountBalance>
</schema>

```

Sample Account Balance Read Request and Response in XML Format

Using the below example, you can do the following:

- View the account balance for the membership.

Entity Name	Membership Id	Policy Number	Plan Number	Main Subscriber
REPRC1000,MAIN_SUB	B229160661076798	REPRC1000_Policy	REPRC1000_DENTAL	MeAN

```

<schema>
  <responseDetails>
    <membershipId>229160661076798</membershipId>
    <responseStatus>SUCCESS</responseStatus>
    <message></message>
  </responseDetails>
  <simulationSw>Y</simulationSw>
  <action></action>
  <readFilters>
    <dateFilter>
      <startDate>2019-01-01</startDate>
      <endDate>2019-12-31</endDate>
    </dateFilter>
    <priceItemFilter>
      <priceItemList>
        <priceItemCode></priceItemCode>
      </priceItemList>
    </priceItemFilter>
    <responseType></responseType>
  </readFilters>
  <person>
    <personData>
      <sequence>1</sequence>
      <personType>P</personType>
      <personName>
        <sequence>1</sequence>
        <entityName>REPRC1000,MAIN_SUB</entityName>
        <nameType>PRIM</nameType>
      </personName>
      <identifiers>
        <idType>WEB</idType>
        <idValue>REPRC1000_MAIN_SUB</idValue>
        <isPrimary>Y</isPrimary>
      </identifiers>
      <division>HC</division>
      <birthDate>1982-07-07</birthDate>
      <sinceDate>2019-01-01</sinceDate>
      <address>
        <addressEffDate>2019-01-01</addressEffDate>
        <addressType>MAIN</addressType>
        <mailingName>MR. ROGER HARVEY</mailingName>
        <address1>ONL SOFTWARE INC.</address1>
        <address2>401 BLACKWOOD ISLAND PARKWAY</address2>
      </address>
    </personData>
  </person>

```

```

        <address3>NEXT TO HUB SHOPPING ARENA</address3>
        <address4>CENTRAL ROAD</address4>
        <city>FLORIDA</city>
        <state>MIAMI</state>
        <zip>94065</zip>
        <country>USA</country>
        <houseType>COLONIAL</houseType>
        <streetNumber1></streetNumber1>
        <streetNumber2></streetNumber2>
        <inCityLimit>Y</inCityLimit>
        <taxVendorGeographicalCode>22310</taxVendorGeographicalCode>
        <county>MIAMI-DADE</county>
    </address>
    <email>reprc_sd001_001_pl@onlsinc.com</email>
    <overrideMailingName1>reprc_sd001_001_pl@onlsinc.com</
overrideMailingName1>
    <overrideMailingName2>reprc_sd001_001_pl@onlsinc.com</
overrideMailingName2>
    <overrideMailingName3>reprc_sd001_001_pl@onlsinc.com</
overrideMailingName3>
    <phones>
        <phoneType>BUSN</phoneType>
        <phoneValue>+1.603.555.0100</phoneValue>
        <extension>713</extension>
    </phones>
    <relatedPersons>
        <idType></idType>
        <idValue></idValue>
        <personRelationshipType></personRelationshipType>
        <startDate></startDate>
        <endDate></endDate>
        <financialRelationshipSw></financialRelationshipSw>
        <parentOrChild></parentOrChild>
        <relatedPersonsCharacteristicsList>
            <characteristic>
                <characteristicType></characteristicType>
                <characteristicValue></characteristicValue>
                <effectiveDate></effectiveDate>
            </characteristic>
        </relatedPersonsCharacteristicsList>
    </relatedPersons>
    <personCharacteristicList>
        <characteristic>
            <characteristicType></characteristicType>
            <characteristicValue></characteristicValue>
            <effectiveDate></effectiveDate>
        </characteristic>
    </personCharacteristicList>
    <accountData>
        <accountType></accountType>
        <customerClass></customerClass>
        <billCycle></billCycle>
        <billLeadDays></billLeadDays>
        <division></division>
        <currency></currency>
        <setUpDate></setUpDate>
        <acctUsageFlg></acctUsageFlg>
        <comments></comments>
        <deferAutoPayDt></deferAutoPayDt>
        <collectionClass></collectionClass>
        <billRouteType></billRouteType>
        <billAddressSource></billAddressSource>
        <accountIdentifiers>
            <idType></idType>

```

```

        <idValue></idValue>
        <isPrimary></isPrimary>
    </accountIdentifiers>
    <characteristics>
        <characteristicsList>
            <characteristicType></characteristicType>
            <characteristicValue></characteristicValue>
            <effectiveDate></effectiveDate>
        </characteristicsList>
    </characteristics>
</accountData>
</personData>
</person>
<membership>
    <sourceSystem>ZZ_PRIME</sourceSystem>
    <policyNumber>REPRC1000_POLICY</policyNumber>
    <planNumber>REPRC1000_DENTAL_PLAN</planNumber>
    <healthPlanCode></healthPlanCode>
    <startDate>2019-01-01</startDate>
    <endDate>2019-12-31</endDate>
    <boStatusCd></boStatusCd>
    <paidThroughDate>2019-01-01</paidThroughDate>
    <membershipType></membershipType>
    <mainSubscriber>
        <mainSubsIdType>WEB</mainSubsIdType>
        <mainSubsIdValue>Reprc1011_MAINSUB</mainSubsIdValue>
        <membershipType></membershipType>
    </mainSubscriber>
    <autoRenew>N</autoRenew>
    <associatedMemberIdentifierType>AADHR</associatedMemberIdentifierType>
    <associatedMemberIdentifier>HLPN022</associatedMemberIdentifier>
    <exchangeFlag>ON</exchangeFlag>
    <exchangeId>HLPNPFSTEST145</exchangeId>
    <binderLiabilityAmount></binderLiabilityAmount>
    <binderPayApplicability></binderPayApplicability>
    <binderPayGraceDays></binderPayGraceDays>
    <binderPayThreshold></binderPayThreshold>
    <holdBilling></holdBilling>
    <membershipRenewalDate></membershipRenewalDate>
    <contractPeriod></contractPeriod>
    <membershipIdentifierList>
        <membershipIdentifier>
            <membershipIdentifierType></membershipIdentifierType>
            <membershipIdentifierValue></membershipIdentifierValue>
        </membershipIdentifier>
    </membershipIdentifierList>
    <membershipCharacteristicList>
        <characteristic>
            <characteristicType>BL 1</characteristicType>
            <characteristicValue>REPRC1000</characteristicValue>
            <effectiveDate>2019-01-01</effectiveDate>
        </characteristic>
    </membershipCharacteristicList>
    <membershipRateGuarantee>
        <membershipRateGuaranteeList>
            <rateGuaranteeStartDate></rateGuaranteeStartDate>
            <rateGuaranteeEndDate></rateGuaranteeEndDate>
            <rateGuaranteeStatus></rateGuaranteeStatus>
        </membershipRateGuaranteeList>
    </membershipRateGuarantee>
    <memberDataList>
        <memberData>
            <memberIdType>WEB</memberIdType>
            <memberIdValue>REPRC1011_SPOUSE</memberIdValue>

```

```

<enrollmentStartDate>2019-01-01</enrollmentStartDate>
<enrollmentEndDate>2019-12-31</enrollmentEndDate>
<memberRelationship>SPO</memberRelationship>
<membershipPersonStatus>ACTV</membershipPersonStatus>
<memberId>REPRC1000</memberId>
<financeRespFlag>N</financeRespFlag>
<isMemberSw>Y</isMemberSw>
<externalMedicareBeneficiaryId></externalMedicareBeneficiaryId>
<memberCharacteristicList>
  <characteristic>
    <characteristicType>C1SMOKER</characteristicType>
    <characteristicValue>Y</characteristicValue>
    <effectiveDate>2019-01-01</effectiveDate>
  </characteristic>
</memberCharacteristicList>
<benefitData>
  <benefitDataList>
    <sequence></sequence>
    <startDate></startDate>
    <endDate></endDate>
    <benefitStatus></benefitStatus>
    <benefitSourceFlag></benefitSourceFlag>
    <benefitSubTypeFlag></benefitSubTypeFlag>
    <planBenefitPackageId></planBenefitPackageId>
    <benefitAmount></benefitAmount>
    <benefitCharacteristicsList>
      <characteristic>
        <characteristicType></characteristicType>
        <characteristicValue></characteristicValue>
        <effectiveDate></effectiveDate>
      </characteristic>
    </benefitCharacteristicsList>
  </benefitDataList>
</benefitData>
</memberData>
</memberDataList>
<premiumCalculationDetails>
  <premiumCalculation>
    <priceItemCd></priceItemCd>
    <startDt></startDt>
    <endDt></endDt>
    <calcAmt></calcAmt>
    <distAmt></distAmt>
    <currencyCd></currencyCd>
    <acctIdType></acctIdType>
    <acctIdVal></acctIdVal>
    <accountId></accountId>
    <billableChgId></billableChgId>
    <pricingRuleId></pricingRuleId>
    <priceAsgnId></priceAsgnId>
    <premiumCalcLineDetails>
      <premiumCalcLines>
        <proFactor></proFactor>
        <calcAmt></calcAmt>
        <distAmt></distAmt>
        <month></month>
        <totalCalcAmt></totalCalcAmt>
        <currencyCd></currencyCd>
        <entityTypeFlg></entityTypeFlg>
        <entityId></entityId>
        <referenceIdType></referenceIdType>
        <referenceIdValue></referenceIdValue>
        <pricingParameters></pricingParameters>
        <description></description>
      </premiumCalcLines>
    </premiumCalcLineDetails>
  </premiumCalculation>
</premiumCalculationDetails>

```

```
        </premiumCalcLines>
      </premiumCalcLineDetails>
    </premiumCalculation>
  </premiumCalculationDetails>
</membership>
<accountBalance>
  <accountBalanceData>
    <accountIdentifierType>ACCT_NM</accountIdentifierType>
    <accountNumber>REPRC1011BG10519S1</accountNumber>
    <accountId>6573747915</accountId>
    <division>HC</division>
    <sourceSystem></sourceSystem>
    <clExternalTransactionId></clExternalTransactionId>
    <externalSourceId></externalSourceId>
    <accountInfoDtls>
      <currentBalance>6600.00</currentBalance>
      <lastBillAmount>1000.00</lastBillAmount>
      <statusCd>SUCCESS</statusCd>
      <messageText></messageText>
    </accountInfoDtls>
  </accountBalanceData>
</accountBalance>
</schema>
```

Chapter 39

Off-Process Request

Topics:

- [Prerequisites](#)
- [Off-Process Request \(Without Approval\) Status Transition](#)
- [Off-Process Request \(With Approval\) Status Transition](#)
- [Algorithms Used in C1-OffProcessRequest](#)
- [Off-Process Request Type](#)
- [Off-Process Request \(Used for Searching\)](#)
- [Off-Process Request \(Used for Viewing\)](#)

There might be situations in the Administrative Services Only (ASO) business wherein the insurance company or health insurance customer (i.e. Employer) would like to change agreed limits or funds within the policy period. For example, a need may arise to change the ASL limit, minimum or maximum discount limit, or settlement or runout funds. This will impact the stop-loss, discount arrangement, and level funding calculation, respectively. In addition, there might be situations wherein the aggregated amount might require a change due to corrections in the claim transactions or due to migration of customers for whom the stop-loss is pre-accumulated and billed in the legacy system.

Oracle Revenue Management and Billing provides a mechanism through which the following agreed limits, funds, or calculated amounts can be amended within the policy period:

Accumulation Category	Field Value
Specific Stop-Loss (SSL)	Aggregated Amount
Aggregate Stop-Loss (ASL)	Aggregated Amount
	ASL Limit
	SSL Cumulative Credits
Level Funded	Aggregated Amount
	Settlement Fund
	SSL Cumulative Credits
	ASL Cumulative Credits
	Runout Fund
Discount Arrangement	Aggregated Amount
	Minimum Discount Limit
	Maximum Discount Limit

The system enables you to amend the above mentioned accumulation field values through an off-process request. As its name suggests, an off-process request is an adhoc request to create an adjustment or billable charge through which the system can amend the above mentioned accumulation field values.

While creating an off-process request, you need to specify an off-process request type using which you want to create the off-process request. It is the off-process request type which helps the system to determine:

- The business object using which the off-process request should be created in the system
- Whether the system should create an adjustment or billable charge to amend the above mentioned accumulation field values
- Whether the approval is required for the off-process request
- The accumulation categories whose field values can be amended through the respective off-process requests
- The accumulation fields whose values can be amended through the respective off-process requests
- The default adjustment type using which the adjustment should be created when the amendment mode is set to **Adjustment**
- The default billable charge line type using which the billable charge should be created when the amendment mode is set to **Billable Charge**
- The type of contract against which the adjustment or billable charge should be created for the account

Once you specify the off-process request type, you need to specify the following:

- The parent customer (i.e. person whose person type is set to **Parent Customer**) for which you want to create an off-process request
- The accumulation category whose field value you want to amend through the off-process request
- The accumulation field whose value you want to amend through the off-process request

Note: Here, you can select only those accumulation categories and fields for which the contract type and adjustment type or billable charge line type information is available in the respective off-process request type.

- The accumulation group for which the changes should be reflected in the system

Note: If the accumulation category is set to **Specific Stop-Loss**, you can only select the accumulation group defined at the bill group level. However, if the accumulation category is set to **Aggregate Stop-Loss**, **Discount Arrangement**, or **Level Funded**, you can only select the accumulation group defined at the parent customer level.

- The account for which the adjustment or billable charge should be created in the system
- The amount which you want amend through the off-process request
- The adjustment type using which the adjustment should be created when the amendment mode is set to **Adjustment** in the respective off-process request type
- The billable charge line type using which the billable charge should be created when the amendment mode is set to **Billable Charge** in the respective off-process request type

- The member or main subscriber for whom the field value should be amended in the system

Note: You need to specify the member or main subscriber when the accumulation category is set to **Specific Stop-Loss**.

- The date (i.e. effective date) when the field value should be amended in the system

Note: If the amendment mode is set to **Adjustment**, the above date is stamped as the accounting date. However, if the amendment mode is set to **Billable Charge**, the above date is stamped as the billable charge start and end dates.

- The coverage period for which the amendment is applicable

Note: The coverage period is stored for the informational purposes only and is not considered during accumulation.

Once an off-process request is created in the **Draft** status, you can edit, delete, or submit the off-process request. On submitting an off-process request, the system creates the adjustments or billable charges to amend the accumulation field values. Finally, the status of the off-process request is changed to **Processed**.

Note: The off-process request through which the adjustment is created is stored in the **Comments** field. And, the off-process request through which the billable charge is created is stored in the **GRP_REF_VAL** column.

You can optionally configure the approval process for the off-process request. If the **Approval Required** flag is set to **Yes** in the off-process request type, the status of the off-process request is changed to **Approval In Progress** when you submit the off-process request. Once the approver approves the off-process request, the status of the off-process request is changed to **Approved**. The system then creates the adjustments or billable charges to amend the accumulation field values. Finally, the status of the off-process request is changed to **Processed**. However, if the approver rejects an off-process request, the status of the off-process request is changed to **Rejected**.

These adjustments or billable charges are then considered in the accumulation run when the adjustment date or billable charge start and end dates fall within the accumulation cycle. Depending on the accumulation category, the adjustment or billable charge is considered when the **C1-ACSSL**, **C1-ACASL**, **C1-ACDA**, or **C1-ACLF** batch is executed.

For more information on how to setup the off-process request feature, see [Prerequisites](#) on page 3222.

Prerequisites

Information will be available soon...

Off-Process Request (Without Approval) Status Transition

The following figure graphically indicates how an off-process request moves from one status to another when the approval process is not configured in the off-process request type:

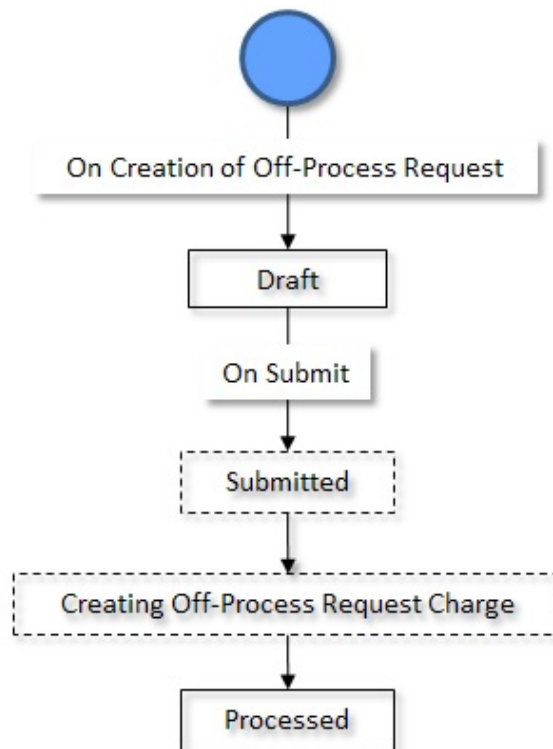

Off-Process Request (With Approval) Status Transition

The following figure graphically indicates how an off-process request moves from one status to another when the approval process is configured in the off-process request type:

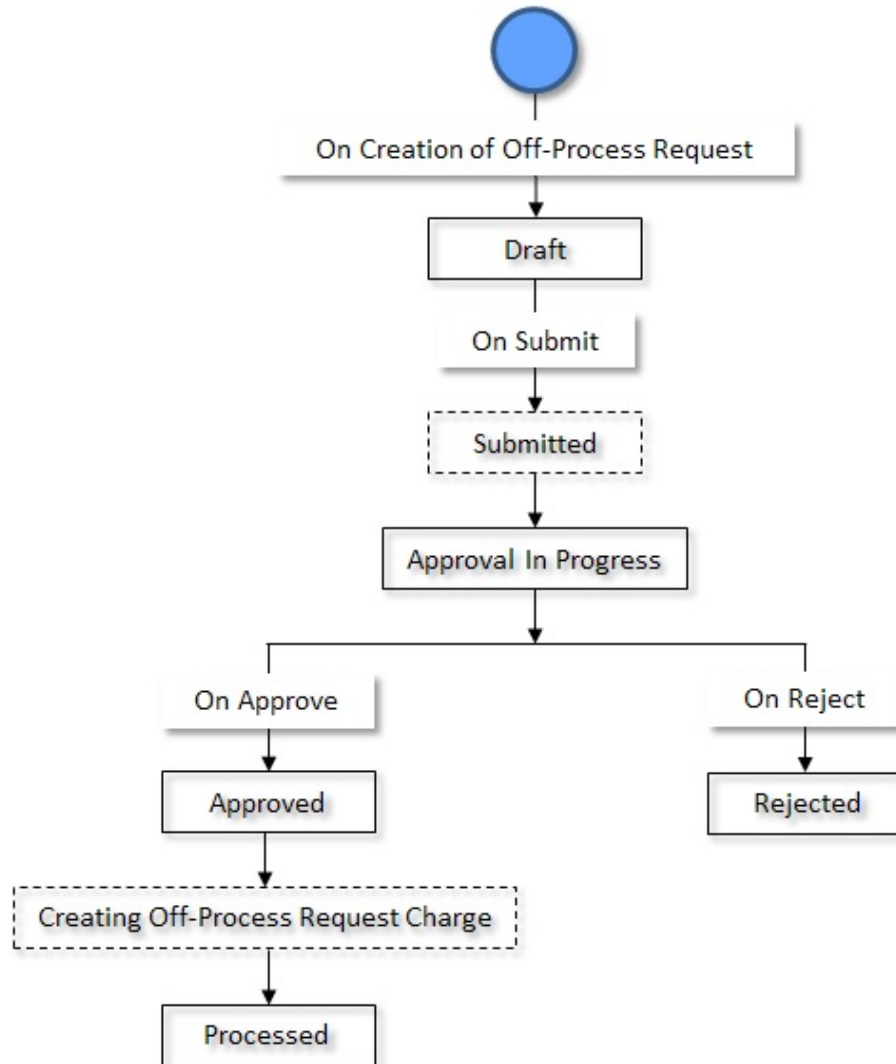

Algorithms Used in C1-OffProcessRequest

Information will be available soon...

Off-Process Request Type

Oracle Revenue Management and Billing allows you to define an off-process request type using which you can create an off-process request. It is the off-process request type which helps the system to determine the following:

- The business object using which the off-process request should be created in the system.
- Whether the system should create the adjustment or billable charge to amend the accumulation field values.
- Whether approval is required for an off-process request.
- The accumulation categories and their respective amendment fields whose field values can be amended through the off-process requests.

- The default adjustment type or the billable charge line type using which the adjustment should be created in the system.
- The type of contract against which the adjustment or billable charge should be created for the account.

The **Off-Process Request Type** screen allows you to define, edit, delete, and copy an off-process request type. It contains the following zones:

- [Off-Process Request Type List](#) on page 3224
- [Off-Process Request Type](#) on page 3224

Off-Process Request Type List

The **Off-Process Request Type List** zone lists the off-process request types that are already defined in the system. It contains the following columns:

Column Name	Column Description
Off-Process Request Type	Displays the off-process request type.
Description	Displays the description of the off-process request type.
Edit	On clicking the Edit (✎) icon, the Off-Process Request Type screen appears where you can edit the details of the off-process request type.
Duplicate	On clicking the Duplicate (📄) icon, the Off-Process Request Type screen appears where you can define a new off-process request type using an existing off-process request type.
Delete	On clicking the Delete (🗑) icon, you can delete the off-process request type.
	Note: You can delete an off-process request type when you have not created an off-process request using the off-process request type.

On clicking the **Broadcast** (📡) icon corresponding to an off-process request type, the **Off-Process Request Type** zone appears with the details of the respective off-process request type.

Related Topics

For more information on...	See...
How to edit an off-process request type	Editing an Off-Process Request Type on page 3232
How to copy an off-process request type	Copying an Off-Process Request Type on page 3235
How to delete an off-process request type	Deleting an Off-Process Request Type on page 3234
How to view the details of an off-process request type	Viewing the Off-Process Request Type Details on page 3238

Off-Process Request Type

The **Off-Process Request Type** zone displays the details of the off-process request type. It contains of the following sections:

- **Main** - Displays the basic information about the off-process request type. It contains the following fields:

Column Name	Column Description
Off-Process Request Type	Displays the off-process request type.

Column Name	Column Description
Business Object	Indicates the business object using which the off-process request type is created. In addition, a context menu appears corresponding to this field which helps in navigating to other screens in the application.
	Note: It has a link. On clicking the link, the Business Object screen appears where you can view the details of the respective business object.
Description	Displays the description of the off-process request type.
Detailed Description	Displays additional information about the off-process request type.
Off-Process Request Business Object	Indicates the business object using which an off-process request should be created. In addition, a context menu appears corresponding to this field which helps in navigating to other screens in the application.
	Note: It has a link. On clicking the link, the Business Object screen appears where you can view the details of the respective business object.
Status	Indicates the status of the off-process request type. The valid values are: <ul style="list-style-type: none"> • Active • Inactive
Amendment Mode	Indicates whether adjustments or billable charges should be created using the off-process request type.
Approval Required	Indicates whether approval is required while creating the adjustments or billable charges using the off-process request type.
Approval Profile	Indicates the approval profile which must be used to define approval hierarchy for the off-process request type.
	Note: The Approval Profile field appears when the Approval Required check box is selected. It has a link. On clicking the link, the Approval Profile screen appears where you can view the details of the respective approval profile.
Approval To Do Type	Indicates that the To Do entry of the specified To Do type must be created when an off-process request is submit for approval.
	Note: It has a link. On clicking the link, the To Do Type screen appears where you can view the details of the respective To Do type. This field appears when the Approval Required option is selected.

Column Name	Column Description
Approval To Do Role	Indicates that users with the specified To Do role can only approve an off-process request which is submitted for approval.
	<p>Note:</p> <p>It has a link. On clicking the link, the To Do Role screen appears where you can view the details of the respective To Do role.</p> <p>This field appears when the Approval Required option is selected.</p>

- **Accumulation Amendment Details** - Lists the types of accumulation defined for the off-process type. It contains the following columns:

Column Name	Column Description
Accumulation Category	Indicates the category for which the adjustment or billable charge is created.
Amendment Field	Indicates the field for which the adjustment or billable charge is created.
Contract Type	Indicates the contract type which is associated while defining the off-process request type.
Adjustment Type/Billable Charge Line Type	Indicates the adjustment or billable charge line type using which the adjustment or billable charge should be created through the off-process request.

- **Characteristics** - The **Characteristics** section lists the characteristics of the off-process request type. It contains the following columns:

Column Name	Column Description
Characteristic Type	Indicates the characteristic type.
Characteristic Value	Displays the value of the characteristic type.

- **Record Actions** - The **Record Actions** section contains the following buttons:

Button Name	Button Description
Edit	Used to edit the details of the off-process request type.
Delete	Used to delete the off-process request type.
	<p>Note: You can delete a off-process request type when you have not created a off-process request using the off-process request type.</p>
Duplicate	Used to create a new off-process request type using an existing off-process request type.

- **Record Information** - The **Record Information** section contains the following fields:

Field Name	Field Description
Business Object	Indicates the business object using which the off-process request type is created. In addition, a context menu appears corresponding to this field which helps in navigating to other screens in the application.
	Note: It has a link. On clicking the link, the Business Object screen appears where you can view the details of the respective business object.

By default, the **Off-Process Request Type** zone does not appear in the **Off-Process Request Type** screen. It appears when you click the **Broadcast** (📡) icon corresponding to the off-process request type in the **Off-Process Request Type List** zone.

Related Topics

For more information on...	See...
How to edit an off-process request type	Editing an Off-Process Request Type on page 3232
How to copy an off-process request type	Copying an Off-Process Request Type on page 3235
How to delete an off-process request type	Deleting an Off-Process Request Type on page 3234
How to view the details of an off-process request type	Viewing the Off-Process Request Type Details on page 3238

Defining an Off-Process Request Type

Prerequisites

To define an off-process request type, you should have:

- Off-process request type business objects defined in the application
- Off-process request business objects defined in the application
- Required approval profiles defined in the application
- Required To Do role assigned to the **C1-OF PAP** To Do type in the application
- Accumulation category defined in the application
- Amendment field and amendment mode defined in the application
- Contract type defined in the application
- Adjustment type and billable charge line type defined in the application
- Off-process request type status defined in the application

Procedure

To define an off-process request type:

1. Click the **Admin** link in the **Application** toolbar.
A list appears.
2. From the **Admin** menu, select **O** and then click **Off-Process Request Type**.
A sub-menu appears.
3. Click the **Add** option from the **Off-Process Request Type** sub-menu.

The **Off-Process Request Type** screen appears. It contains the following sections:

- **Main** - Used to specify basic details about the off-process request type.
- **Accumulation Amendment Details** - Used to specify the accumulation amendment details for the off-process request type.
- **Characteristics** - Used to define the characteristics for the off-process request type.

The **Main** section contains the following fields:

Field Name	Field Description	Mandatory (Yes or No)
Off-Process Request Type	Used to specify the off-process request type.	Yes
Business Object	Indicates the business object using which you are defining the off-process request type.	Not applicable
Description	Used to specify the description for the off-process request type.	Yes
Detailed Description	Used to specify additional information about the off-process request type.	No
Off-Process Request Business Object	Used to indicate the business object using which you want to create the off-process request.	Yes
Status	Used to indicate the status of the off-process request type. The valid values are: <ul style="list-style-type: none"> • Active • Inactive <div style="border: 1px solid black; padding: 5px; margin-top: 10px;"> <p>Note:</p> <p>You cannot change the status of an off-process request type to Inactive when the corresponding off-process request is in a status other than Processed or Rejected.</p> <p>By default, the Active option is selected.</p> </div>	Not applicable
Amendment Mode	Used to indicate the amendment mode selected for the off-process request type. The valid values are: <ul style="list-style-type: none"> • Adjustment • Billable Charge 	Yes
Approval Required	Used to indicate whether the approval is required before generating adjustments or billable charges through an off-process request.	No

Field Name	Field Description	Mandatory (Yes or No)
Approval To Do Type	Used to indicate that To Do entry of the specified To Do type must be created when an off-process request is submitted for approval.	Yes (Conditional) Note: This field is required when the Approval Required option is selected.
	Note: The Search  icon appears corresponding to the Approval To Do Type field. On clicking the Search icon, the To Do Type Search window appears. On specifying the To Do type, the description of the To Do type appears corresponding to the Approval To Do Type field. This field appears when the Approval Required option is selected.	
Approval To Do Role	Used to indicate that users with the specified To Do role can only approve an off-process request submitted for approval.	Yes (Conditional) Note: This field is required when the Approval Required option is selected.
	Note: The list includes only those To Do roles which are associated to the specified approval To Do type. This field appears only when the Approval Required option is selected.	

4. Enter the required details in the **Main** section.
5. Define the accumulation amendment details for the off-process request type, if required.
6. Define characteristics for the off-process request type, if required.
7. Click **Save**.

The off-process request type is defined.

Related Topics

For more information on...	See...
Off-Process Request Type screen	Off-Process Request Type on page 3223
How to add accumulation details for an off-process request type	Adding the Accumulation Amendment Details in an Off-Process Request Type on page 3229
How to define a characteristic for an off-process request type	Defining a Characteristic for an Off-Process Request Type on page 3231

Adding the Accumulation Amendment Details in an Off-Process Request Type

Prerequisites

To add accumulation amendment details in an off-process request type, you should have:

- Accumulation categories defined in the application
- Amendment fields defined in the application

- Contract types defined in the application
- Adjustment type and billable charge line type defined in the application



Procedure

To add accumulation amendment details in an off-process request types:

1. Ensure that the

Accumulation Amendment Details section is expanded when you are adding the accumulation amendment details in an off-p

The **Accumulation Amendment Details** section contains the following fields in a grid:

Field Name	Field Description	Mandatory (Yes or No)
Accumulation Category	Used to indicate the category that you want to use for accumulation. The valid values are: <ul style="list-style-type: none"> • Aggregate Stop Loss • Discount Arrangement • Level Funded • Specific Stop-Loss 	Yes
Amendment Field	Used to indicate the field that you want to use for accumulation purposes. The valid values are: <ul style="list-style-type: none"> • ASL Limit • Aggregated Amount • Cumulative ASL Credit • Cumulative SSL Credit • Maximum Limit • Minimum Limit • Run Out Fund • Settlement Fund 	Yes
Contract Type	Used to indicate the contract that you want to use for accumulation and amendment purposes. <div style="border: 1px solid black; padding: 5px; margin-top: 10px;"> <p>Note:</p> <p>The Search  icon appears corresponding to the Contract Type field. On clicking the Search icon, the Contract Type Search window appears.</p> </div>	Yes (Conditional) <div style="border: 1px solid black; padding: 5px; margin-top: 10px;"> <p>Note: This field is required when you are defining accumulation amendment details in an off-process request type.</p> </div>
Adjustment Type/Billable Charge Line Type	Used to indicate the type of charge using which you want to create adjustments or billable charges. <div style="border: 1px solid black; padding: 5px; margin-top: 10px;"> <p>The Search  icon appears corresponding to the Adjustment Type/Billable Charge Line Type field. On clicking the Search icon, the Adjustment Type/Billable Charge Line Type Search window appears.</p> </div>	Yes (Conditional) <div style="border: 1px solid black; padding: 5px; margin-top: 10px;"> <p>Note: This field is required when you are defining accumulation amendment details in an off-process request type.</p> </div>

2. Enter the required details in the **Accumulation Amendment Details** section.

- If you want to define more than one accumulation amendment details for the off-process request type, click the **Add (+)** icon and then repeat step 2.

Note: However, if you want to remove an accumulation amendment detail(s) from the off-process request type, click the **Delete (🗑)** icon corresponding to the accumulation amendment details.

Related Topics

For more information on...	See...
How to add an off-process request type	Defining an Off-Process Request Type on page 3227
How to edit an off-process request type	Editing an Off-Process Request Type on page 3232
How to copy an off-process request type	Copying an Off-Process Request Type on page 3235

Defining a Characteristic for an Off-Process Request Type

Prerequisites

To define a characteristic for an off-process request type, you should have:

- Characteristic types defined in the application (where the characteristic entity is set to **Off-Process Request**)

Procedure

To define a characteristic for an off-process request type:

- Ensure that the **Characteristics** section is expanded when you are defining, editing, or copying an off-process request type.

The **Characteristics** section contains the following fields in a grid:

Field Name	Field Description	Mandatory (Yes or No)
Characteristic Type	Used to indicate the characteristic type.	Yes (Conditional)
	Note: The list includes only those characteristic types where the characteristic entity is set to Off-Process Request .	Note: This field is required when you are defining a characteristic for the off-process request type.
Characteristic Value	Used to specify the value for the characteristic type.	Yes (Conditional)
	Note: If you select a predefined characteristic type, the Search (🔍) icon appears corresponding to the Characteristic Value field. On clicking the Search icon, the Predefined Characteristic Search window appears. On specifying the value for a predefined characteristic type, the description of the characteristic value appears corresponding to the Characteristic Value field.	Note: This field is required when you are defining a characteristic for the off-process request type.

2. Enter the required details in the **Characteristics** section.
3. If you want to define more than one characteristic for the off-process request type, click the **Add (+)** icon and then repeat step 2.

Note: However, if you want to remove a characteristic from the off-process request type, click the **Delete** (🗑️) icon corresponding to the characteristic.

Related Topics

For more information on...	See...
How to define an off-process request type	Defining an Off-Process Request Type on page 3227
How to edit an off-process request type	Editing an Off-Process Request Type on page 3232
How to copy an off-process request type	Copying an Off-Process Request Type on page 3235

Editing an Off-Process Request Type

Prerequisites

To edit an off-process request type, you should have:

- Off-process request business objects defined in the application
- Adjustment type and billable charge line type defined in the application
- Required approval profiles defined in the application
- A To Do role assigned to the **C1-OFPAP** To Do type in the application
- Accumulation category defined in the application
- Amendment field and amendment mode defined in the application
- Contract type defined in the application
- Off-process request type status defined in the application

Procedure

To edit an off-process request type:

1. Click the **Admin** link in the **Application** toolbar.
A list appears.
2. From the **Admin** menu, select **O** and then click **Off-Process Request Type**.
A sub-menu appears.
3. Click the **Search** option from the **Off-Process Request Type** sub-menu.
The **Off-Process Request Type** screen appears.
4. In the **Off-Process Request Type List** zone, click the **Edit** (✎) icon in the **Edit** column corresponding to the off-process request type whose details you want to edit.

The **Off-Process Request Type** screen appears. It contains the following sections:

- **Main** - Used to specify basic details about the off-process request type.
- **Characteristics** - Used to define the characteristics for the off-process request type.

The **Main** section contains the following fields:

Field Name	Field Description	Mandatory (Yes or No)
Off-Process Request Type	Displays the off-process request type.	Not applicable
Business Object	Indicates the business object using which you are defining the off-process request type.	Not applicable
Description	Used to specify the description for the off-process request type.	Yes
Off-Process Request Business Object	Used to indicate the business object using which you want to create the off-process request.	Yes
Detailed Description	Used to specify additional information about the off-process request type.	No
Status	Used to indicate the status of the off-process request type. The valid values are: <ul style="list-style-type: none"> Active Inactive 	Yes
	<p>Note:</p> <p>You cannot change the status of an off-process request type to Inactive when the corresponding off-process request is in a status other than Processed or Rejected.</p> <p>If you do not specify the status, by default, it is set to Active.</p>	
Amendment Mode	Used to indicate the amendment mode selected for the off-process request type. The valid values are: <ul style="list-style-type: none"> Adjustment Billable Charge 	Yes
Approval Required	Used to indicate whether the approval is required before generating adjustments or billable charges through an off-process request.	No
Approval To Do Type	Used to indicate that To Do entry of the specified To Do type must be created when an off-process request is submitted for approval.	Yes (Conditional)
	<p>Note:</p> <p>The Search  icon appears corresponding to the Approval To Do Type field. On clicking the Search icon, the To Do Type Search window appears.</p> <p>On specifying the To Do type, the description of the To Do type appears corresponding to the Approval To Do Type field.</p> <p>This field appears when the Approval Required option is selected.</p>	
	<p>Note: This field is required when the Approval Required option is selected.</p>	

Field Name	Field Description	Mandatory (Yes or No)
Approval To Do Role	Used to indicate that users with the specified To Do role can only approve an off-process request submitted for approval.	Yes (Conditional)
	<p>Note:</p> <p>The list includes only those To Do roles which are associated to the specified approval To Do type.</p> <p>This field appears only when the Approval Required option is selected.</p>	<p>Note: This field is required when the Approval Required option is selected.</p>

Tip: Alternatively, you can edit the details of a off-process request type by clicking the **Edit** button in the **Off-Process Request Type** zone.

5. Modify the details in the **Main** section, if required.
6. Define, edit, or remove accumulation amendment details from the off-process request type, if required.
7. Define, edit, or remove characteristics of the off-process request type, if required.
8. Click **Save**.

The changes made to the off-process request type are saved.

Related Topics

For more information on...	See...
Off-Process Request Type screen	Off-Process Request Type on page 3223
Off-Process Request Type List zone	Off-Process Request Type List on page 3224
Off-Process Request Type zone	Off-Process Request Type on page 3224
How to add accumulation details for an off-process request type	Adding the Accumulation Amendment Details in an Off-Process Request Type on page 3229
How to define a characteristic for an off-process request type	Defining a Characteristic for an Off-Process Request Type on page 3231

Deleting an Off-Process Request Type

Procedure

To delete an off-process request type:

1. Click the **Admin** link in the **Application** toolbar.
A list appears.
2. From the **Admin** menu, select **O** and then click **Off-Process Request Type**.
A sub-menu appears.
3. Click the **Search** option from the **Off-Process Request Type** sub-menu.
The **Off-Process Request Type** screen appears.
4. In the **Off-Process Request Type List** zone, click the **Delete** (🗑️) icon in the **Delete** column corresponding to the off-process request type that you want to delete.
A message appears confirming whether you want to delete the off-process request type.

Note: You can delete an off-process request type when you have not created an off-process request using the off-process request type.

Tip: Alternatively, you can delete an off-process request type by clicking the **Delete** button in the **Off-Process Request Type** zone.

5. Click **OK**.

The off-process request type is deleted.

Related Topics

For more information on...	See...
Off-Process Request Type screen	<i>Off-Process Request Type</i> on page 3223
Off-Process Request Type List zone	<i>Off-Process Request Type List</i> on page 3224
Off-Process Request Type zone	<i>Off-Process Request Type</i> on page 3224

Copying an Off-Process Request Type

Instead of creating an off-process request type from scratch, you can create a new off-process request type using an existing off-process request type. This is possible through copying an off-process request type. On copying an off-process request type, the details including the characteristics are copied to the new off-process request type. You can then edit the details, if required.

Prerequisites

To copy an off-process request type, you should have:

- Off-process request type (whose copy you want to create) defined in the application
- Off-process request business objects defined in the application
- Required approval profiles defined in the application
- A To Do role assigned to the **C1-OFPPAP** To Do type in the application
- Accumulation category defined in the application
- Amendment field and amendment mode defined in the application
- Contract type defined in the application
- Adjustment type and billable charge line type defined in the application
- Off-process request type status defined in the application

Procedure

To copy an off-process request type:

1. Click the **Admin** link in the **Application** toolbar.
A list appears.
2. From the **Admin** menu, select **O** and then click **Off-Process Request Type**.
A sub-menu appears.
3. Click the **Search** option from the **Off-Process Request Type** sub-menu.
The **Off-Process Request Type** screen appears.
4. In the **Off-Process Request Type List** zone, click the **Duplicate** () icon in the **Duplicate** column corresponding to the off-process request type whose copy you want to create.

The **Off-Process Request Type** screen appears. It contains the following sections:

- **Main** - Used to specify basic details about the off-process request type.
- **Characteristics** - Used to define the characteristics for the off-process request type.

The **Main** section contains the following fields:

Field Name	Field Description	Mandatory (Yes or No)
Off-Process Request Type	Used to specify the off-process request type.	Yes
Business Object	Indicates the business object using which you are defining the off-process request type.	Not applicable
Description	Used to specify the description for the off-process request type.	Yes
Off-Process Request Business Object	Used to indicate the business object using which you want to create the off-process request.	Yes
Detailed Description	Used to specify additional information about the off-process request type.	No
Off-Process Request Business Object	Used to indicate the business object using which you want to create the respective off-process request type.	Yes
Status	Used to indicate the status of the off-process request type. The valid values are: <ul style="list-style-type: none"> • Active • Inactive <div style="border: 1px solid black; padding: 5px; margin-top: 10px;"> <p>Note: You cannot change the status of an off-process request type to Inactive when the corresponding off-process request is in a status other than Processed or Rejected. If you do not specify the status, by default, it is set to Active.</p> </div>	Yes
Amendment Mode	Used to indicate the amendment mode selected for the off-process request type. The valid values are: <ul style="list-style-type: none"> • Adjustment • Billable Charge 	Yes
Approval Required	Used to indicate whether the approval is required before generating adjustments or billable charges through an off-process request.	No

Field Name	Field Description	Mandatory (Yes or No)
Approval To Do Type	Used to indicate that To Do entry of the specified To Do type must be created when an off-process request is submitted for approval.	Yes (Conditional) Note: This field is required when the Approval Required option is selected.
	<p>Note:</p> <p>The Search  icon appears corresponding to the Approval To Do Type field. On clicking the Search icon, the To Do Type Search window appears.</p> <p>On specifying the To Do type, the description of the To Do type appears corresponding to the Approval To Do Type field.</p> <p>This field appears when the Approval Required option is selected.</p>	
Approval To Do Role	Used to indicate that users with the specified To Do role can only approve an off-process request submitted for approval.	Yes (Conditional) Note: This field is required when the Approval Required option is selected.
	<p>Note:</p> <p>The list includes only those To Do roles which are associated to the specified approval To Do type.</p> <p>This field appears only when the Approval Required option is selected.</p>	

Tip: Alternatively, you can copy an off-process request type by clicking the **Duplicate** button in the **Off-Process Request Type** zone.

5. Enter the required details in the **Main** section.
6. Define, edit, or remove the accumulation amendment details from the off-process request type, if required.
7. Define, edit, or remove characteristics of the off-process request type, if required.
8. Click **Save**.

The new off-process request type is defined.

Related Topics

For more information on...	See...
Off-Process Request Type screen	Off-Process Request Type on page 3223
Off-Process Request Type List zone	Off-Process Request Type List on page 3224
Off-Process Request Type zone	Off-Process Request Type on page 3224
How to add accumulation details to an off-process request type	Adding the Accumulation Amendment Details in an Off-Process Request Type on page 3229
How to define a characteristic for an off-process request type	Defining a Characteristic for an Off-Process Request Type on page 3231

Viewing the Off-Process Request Type Details

Procedure

To view the details of an off-process request type:

1. Click the **Admin** link in the **Application** toolbar.
A list appears.
2. From the **Admin** menu, select **O** and then click **Off-Process Request Type**.
A sub-menu appears.
3. Click the **Search** option from the **Off-Process Request Type** sub-menu.
The **Off-Process Request Type** screen appears.
4. In the **Off-Process Request Type List** zone, click the **Broadcast** () icon corresponding to the off-process request type whose details you want to view.
The **Off-Process Request Type** zone appears.
5. View the details of the off-process request type in the **Off-Process Request Type** zone.

Related Topics

For more information on...	See...
Off-Process Request Type screen	Off-Process Request Type on page 3223
Off-Process Request Type List zone	Off-Process Request Type List on page 3224
Off-Process Request Type zone	Off-Process Request Type on page 3224

Off-Process Request (Used for Searching)

The **Off-Process Request** screen allows you to search for an off-process request using various search criteria. It also allows you to define an off-process request. It contains the following zone:

- [Search Off-Process Request](#) on page 3238

Through this screen, you can navigate to the following screen:

- [Off-Process Request \(Used for Viewing\)](#) on page 3244

Search Off-Process Request

The **Search Off-Process Request** zone allows you to search for an off-process request using various search criteria. It contains the following two sections:

- **Search Criteria** - The **Search Criteria** section contains the following fields:

Field Name	Field Description	Mandatory (Yes or No)
Search By	Used to indicate whether you want to search for an off-process request using the off-process request or adjustment/billable charge details. The valid values are: <ul style="list-style-type: none"> Request Details Adjustment/Billable Charge Details 	Yes
	Note: By default, the Request Details option is selected.	
Off-Process Request ID	Used to search a particular off-process request.	No
Created From	Used to search off-process requests which are created from a particular date onwards.	No
	Note: This field appears when the Request Details option is selected from the Search By list.	
Created Until	Used to search off-process requests which are created till a particular date.	No
	Note: This field appears when the Request Details option is selected from the Search By list.	
Off-Process Request Type	Used to search off-process requests using a particular off-process request type.	No
Status	Used to search off-process requests with a particular status. The valid values are: <ul style="list-style-type: none"> Approval In Progress Draft Processed Rejected 	No
	Note: This field appears when the Request Details option is selected from the Search By list.	
Parent Person ID	Used to search off-process requests which include adjustments or billable charges of a particular parent person.	No
	Note: The Search  icon appears corresponding to the Parent Person ID field. On clicking the Search icon, the Person Search window appears. This field appears when the Request Details option is selected from the Search By list.	

Field Name	Field Description	Mandatory (Yes or No)
Creation Mode	Used to search off-process requests which are created using a particular mode. The valid values are: <ul style="list-style-type: none"> • Automatic • Manual 	No
	Note: This field appears when the Request Details option is selected from the Search By list.	

Note: You must specify at least one search criterion while searching for an off-process request.

- **Search Results** - On clicking the **Search** button, the search results appear based on the specified search criteria. The **Search Results** section contains the following columns:

Column Name	Column Description
Creation Date Time	Displays the date and time when the off-process request is created.
Off-Process Request Information	Indicates the information about the off-process request. Note: It has a link. On clicking the link, the Off-Process Request screen appears where you can view the details of the respective off-process request.
Parent Person Information	Indicates the information about the parent person. In addition, this column has a context menu which helps in navigating to other screens in the application. Note: It has a link. On clicking the link, the Off-Process Request screen appears where you can view the details of the respective off-process request.
Created By	Indicates the user who has created the off-process request.
Status	Indicates the status of the off-process request. The valid values are: <ul style="list-style-type: none"> • Approval In Progress • Draft • Processed • Rejected
Creation Mode	Indicates how the off-process request is created. The valid values are: <ul style="list-style-type: none"> • Automatic • Manual

Note: Pagination is used to display limited number of records in the **Search Results** section. You can use the navigation links, such as **Previous** and **Next** to navigate between pages.

Related Topics

For more information on...	See...
How to search for an off-process request	Searching for an Off-Process Request on page 3241

For more information on...	See...
How to view the off-process request details of an off-process request	Viewing the Off-Process Request Details of an Off-Process Request on page 3243
How to create an off-process request	Defining an Off-Process Request on page 3241

Searching for an Off-Process Request

Prerequisites

To search for an off-process request, you should have:

- Off-process request types defined in the application

Procedure

To search for an off-process request:

1. Click the **Menu** link in the **Application** toolbar.
A list appears.
2. From the **Main** menu, select **Transaction and Audit Event Management** and then click **Off-Process Request**.
A sub-menu appears.
3. Click the **Search** option from the **Off-Process Request** sub-menu.
The **Off-Process Request** screen appears.
4. Enter the search criteria in the **Search-Off Process Request** zone.

Note: ORMB search engine supports wildcard search, where you can substitute the percentage (%) symbol as a stand in for any word or letter in a search criteria. You can use the ‘%’ wildcard character in all input fields except the date and ID fields. The ‘%’ wildcard character is suffixed automatically at the end of the partial search criteria. Therefore, you may or may not specify the wildcard character at the end of the partial search criteria. However, you have to prefix the wildcard character manually wherever required.

5. Click **Search**.

A list of off-process requests that meet the search criteria appears in the **Search Results** section.

Related Topics

For more information on...	See...
Off-Process Request screen	Off-Process Request (Used for Searching) on page 3238
Search Off-Process Request zone	Search Off-Process Request on page 3238

Defining an Off-Process Request

Prerequisites

To create an off-process request, you should have:

- Off-Process request types defined in the application
- Accumulation category and accumulation group defined in the application
- Amendment field defined in the application
- Persons defined in the application
- Account ID defined in the application

- Characteristic types defined in the application
- Adjustment types or billable charge line types defined in the application

Procedure

To create an off-process request:

1. Click the **Menu** link in the **Application** toolbar.
A list appears.
2. From the **Main** menu, select **Transaction and Audit Event Management** and then click **Off-Process Request**.
A sub-menu appears.
3. Click the **Add** option from the **Off-Process Request** sub-menu.

The **Add Off-Process Request** screen appears. It contains the following field:

Field Name	Field Description	Mandatory (Yes or No)
Off-Process Request Type	Used to indicate the off-process request type using which you want to create the off-process request.	Yes

Tip: Alternatively, you can access this screen by clicking the **Add** button in the **Page Title** area of the **Off-Process Request** screen.

4. Select the required off-process request type from the **Off-Process Request Type** field.
5. Click **OK**.

The **Off-Process Request** screen appears. It contains the following sections:

- **Main** - Used to specify basic details about the off-process request.
- **Off-Process Request Information** - Used to specify the off-process request information.
- **Characteristics** - Used to define the characteristics for the off-process request.

The **Main** section contains the following fields:

Field Name	Field Description	Mandatory (Yes or No)
Off-Process Request Type	Indicates the off-process request type using which you want to create the off-process request.	Not applicable
Creation Mode	Indicates the mode in which the offset request is created. The valid values are: <ul style="list-style-type: none"> • Automatic • Manual 	Not applicable

Field Name	Field Description	Mandatory (Yes or No)
Parent Person Id	Used to indicate the parent customer (.e. person whose person type is set to Parent Customer) for which you want to create an off-process request.	Yes
	<p>Note:</p> <p>The Search (🔍) icon appears corresponding to the Parent Person ID field. On clicking the Search icon, the Parent Customer Search window appears.</p> <p>On specifying the parent person, the description of the parent person appears corresponding to the Parent Person ID field.</p>	
Comments	Used to specify the comments for an off-process request.	No

6. Enter the required details in the **Main** section.
7. Add the accumulation amendment details in the off-process request, if required.
8. Define characteristics for the off-process request, if required.
9. Click **Save**.

The off-process request is created in the **Draft** status.

Related Topics

For more information on...	See...
Off-Process Request screen	Off-Process Request (Used for Viewing) on page 3244
How to add the off-process request details in an off-process request	Adding the Off-Process Request Details in an Off-Process Request on page 3250
How to define a characteristic for an off-process request information	Defining a Characteristic for an Off-Process Request on page 3253

Viewing the Off-Process Request Details of an Off-Process Request

Procedure

To view the off-process request details of an off-process request:

1. Search for the off-process request in the **Off-Process Request** screen.
2. In the **Search Results** section, click the link in the **Off-Process Request Information** column corresponding to the off-process request whose details you want to view.

The **Off-Process Request** screen appears.

3. Ensure that the **Main** tab is selected.
4. View the details of the off-process request in the **Off-Process Request** zone.
5. View the accumulation and amendment details in the **Off-Process Request Details** zone.

Related Topics

For more information on...	See...
How to search for an off-process request	Searching for an Off-Process Request on page 3241

For more information on...	See...
Off-Process Request screen	Off-Process Request (Used for Searching) on page 3238
Off-Process Request zone	Off-Process Request on page 3244
Off-Process Request Details zone	Off-Process Request Details on page 3246

Off-Process Request (Used for Viewing)

The **Off-Process Request** screen allows you to:

- View the details of the off-process request
- Edit the details of the off-process request
- Delete the off-process request
- Submit the off-process request for processing
- Approve or reject the off-process request
- View the error message of the off-process request
- View the log of the off-process request
- Add a log entry for the off-process request

It consists of the following tabs:

- [Off-Process Request - Main](#) on page 3244
- [Off-Process Request - Log](#) on page 3248

Off-Process Request - Main

The **Main** tab displays information about the off-process request. It contains the following zones:

- [Off-Process Request](#) on page 3244
- [Off-Process Request Details](#) on page 3246
- [Off-Process Request Error Message](#) on page 3248

Related Topics

For more information on...	See...
How to view the off-process request details of an off-process request	Viewing the Off-Process Request Details of an Off-Process Request on page 3243
How to view the error message of an off-process request	Viewing the Error Message of an Off-Process Request on page 3249

Off-Process Request

The **Off-Process Request** zone displays the details of the off-process request. It contains the following sections:

- **Main** - Displays basic information about the off-process request. It contains the following fields:

Field Name	Field Description
Off-Process Request Information	Displays information about the off-process request.

Field Name	Field Description
Off-Process Request Type	Indicates the off-process request type using which the off-process request is created.
	Note: It has a link. On clicking the link, the Off-Process Request Type screen appears where you can view the details of the respective off-process request type.
Parent Person	Indicates the parent person for whom the off-process request is created.
Status	Indicates the status of the off-process request. The valid values are: <ul style="list-style-type: none"> • Approval In Progress • Draft • Processed • Rejected
Creation Mode	Indicates whether the off-process request is created automatically or manually. The valid values are: <ul style="list-style-type: none"> • Automatic • Manual

- **Record Actions** - This section contains the following buttons:

Button Name	Button Description
Edit	Used to edit the details of the off-process request.
	Note: The Edit button appears when the off-process request is in the Draft status.
Delete	Used to delete the off-process request.
	Note: The Delete button appears when the off-process request is in the Draft status.
Submit	Used to submit the off-process request.
	Note: The Submit button appears when the off-process request is in the Draft status.
Approve	Used to approve the off-process request.
	Note: The Approve button appears when: <ul style="list-style-type: none"> • The off-process request is in the Approval In Progress status. • A user with the approval To Do role is reviewing the off-process request.
Reject	Used to reject the off-process request.
	Note: The Reject button appears when: <ul style="list-style-type: none"> • The off-process request is in the Approval In Progress status. • A user with the approval To Do role is reviewing the off-process request.

- **Record Information** - This section contains the following fields:

Field Name	Field Description
Business Object	Indicates the business object using which the off-process request is created. In addition, a context menu appears corresponding to this field which helps in navigating to other screens in the application.
	Note: It has a link. On clicking the link, the Business Object screen appears where you can view the details of the respective business object.
Status Date/Time	Displays the date and time when the off-process request status is updated
Create Date/Time	Displays the date and time when the off-process request is created.

- **Characteristics** - Lists the characteristics defined for the off-process request. It contains the following columns:

Column Name	Column Description
Effective Date	Displays the date from when the characteristic is effective for the off-process request.
Characteristic Type	Indicates the characteristic type.
Characteristic Value	Displays the value of the characteristic type.

Related Topics

For more information on...	See...
How to edit an off-process request	Editing an Off-Process Request on page 3253
How to delete an off-process request	Deleting an Off-Process Request on page 3254
How to submit an off-process request	Submitting an Off-Process Request on page 3255
How to approve an off-process request	Approving an Off-Process Request on page 3256
How to reject an off-process request	Rejecting an Off-Process Request on page 3257

Off-Process Request Details

The **Off-Process Request Details** zone lists the accumulation and amendment details of the off-process request. This zone contains the following columns:

Column Name	Column Description
Accumulation Category	Displays the category whose field value is amended through an off-process request. The valid values are: <ul style="list-style-type: none"> • Aggregate Stop Loss • Discount Arrangement • Level Funded • Specific Stop-Loss
Accumulation Group ID	Indicates the accumulation group for which the (accumulation and amendment) changes are reflected in the system.

Column Name	Column Description
Amendment Field	<p>Indicates the accumulation field whose value is amended through the off-process request. The valid values are:</p> <ul style="list-style-type: none"> • ASL Limit • Aggregated Amount • Cumulative ASL Credit • Cumulative SSL Credit • Maximum Limit • Minimum Limit • Run Out Fund • Settlement Fund
Off-Process Amount	Displays the amount which is amended through the off-process request.
Member/Subscriber ID	Displays the member or the main subscriber for whom the field value is amended in the system.
Status	Displays the current status of the off-process request.
Account Information	<p>Indicates the account for which the adjustment or billable charge is created in the system. In addition, a context menu appears corresponding to this field which helps in navigating to other screens in the application.</p> <p>Note: It has a link. On clicking the link, the Account screen appears where you can view the details of the respective account.</p>
Effective Date	Indicates the date when the field value is amended in the system.
Coverage Start Date	Indicates the date from when the amendment is applicable for the off-process request.
Coverage End Date	Indicates the date till when the amendment is applicable for the off-process request.
Adjustment Type	Indicates the adjustment type using which the adjustment should be created when the amendment mode is set to Adjustment in the respective off-process request type.
Adjustment Information	<p>Displays information about the adjustment.</p> <p>Note: It has a link. On clicking the link, the Adjustment screen appears where you can view the details of the respective adjustment.</p>
Billable Charge Line Type	Indicates the billable charge line type using which the billable charge should be created when the amendment mode is set to Billable Charge in the respective off-process request type.
Billable Charge Information	<p>Displays information about the billable charge.</p> <p>Note: It has a link. On clicking the link, the Billable Charge screen appears where you can view the details of the respective billable charge.</p>

On clicking the **Broadcast** () icon corresponding to an off-process request detail record, the **Error Message** zone is displayed.

Note:

Pagination is used to display limited number of records in the **Search Results** section. You can use the navigation links, such as **Previous** and **Next** to navigate between pages.

You can filter the list using **Record Status** field as the search criteria available in the **Filter** area. By default, the **Filter** area is hidden. You can view the **Filter** area by clicking the **Filters** (🔍) icon in the upper right corner of this zone.

Related Topics

For more information on...	See...
How to view the off-process request details of an off-process request	Viewing the Off-Process Request Details of an Off-Process Request on page 3243

Off-Process Request Error Message

The **Error Message** zone displays the error message of an off-process request. It contains the following column:

Column Name	Column Description
Error Message	Displays the error message indicating the error that occurred while executing an off-process request.

Note: This zone appears when the **Status** column in the Off-Process Request Details zone displays the status as **Error**.

Related Topics

For more information on...	See...
How to view the error message of an off-process request	Viewing the Error Message of an Off-Process Request on page 3249

Off-Process Request - Log

The **Log** tab contains the following zone:

- [Off-Process Request Log](#) on page 3248

Related Topics

For more information on...	See...
How to view the log of an off-process request	Viewing the Log of an Off-Process Request on page 3259
How to add a log entry for an off-process request	Adding a Log Entry for an Off-Process Request on page 3259

Off-Process Request Log

The **Off-Process Request Log** zone lists the complete trail of actions performed on the off-process request. It contains the following columns:

Column Name	Column Description
Creation Date/Time	Displays the date and time when the action was performed on the off-process request.
Details	Displays the details of the action performed on the off-process request.
User	Indicates the user who has performed the action on the off-process request.

Column Name	Column Description
Log Type	Indicates the type of log.
Related Object	Indicates the object or entity which is created when the action is performed on the off-process request. Note: At present, no data appears in this column. The implementation team can build the custom logic to meet the business requirements.
Status Reason	Indicates the reason why the off-process request was rejected by the approver. Note: The data appears in this column when the off-process request is in the Rejected status.

Note: You can manually add a log entry for the off-process request by clicking the **Add Log Entry** link in the upper right corner of the **Off-Process Request Log** zone.

Related Topics

For more information on...	See...
How to view the log of an off-process request	Viewing the Log of an Off-Process Request on page 3259
How to add a log entry for an off-process request	Adding a Log Entry for an Off-Process Request on page 3259

Viewing the Error Message of an Off-Process Request

Procedure

To view the error message of an off-process request:

1. Search for the off-process request in the **Off-Process Request** screen.
2. In the **Search Results** section, click the link in the **Off-Process Request Information** column corresponding to the off-process request whose details you want to view.

The **Off-Process Request** screen appears.

3. Ensure that the **Main** tab is selected.
4. In **Off-Process Request Details** zone, click the **Broadcast** (📢) icon corresponding to the off-process request whose error message you want to view.

The **Error Message** zone appears.

5. View the error message of the off-process request in the **Error Message** zone.

Related Topics

For more information on...	See...
How to search for an off-process request	Searching for an Off-Process Request on page 3241
Off-Process Request screen	Off-Process Request (Used for Searching) on page 3238
Off-Process Request - Main tab	Off-Process Request - Main on page 3244
Error Message zone	Off-Process Request Error Message on page 3248

Adding the Off-Process Request Details in an Off-Process Request

Prerequisites

To add the off-process request details in an off-process request, you should have:

- Off-process request types defined in the application
- Categories defined in the application (where the characteristic entity is set to **Off-Process Request**)
- Applicable adjustments and billable charge line types defined in the application.

Procedure

To add the off-process request details in an off-process request:

1. Ensure that the **Off-Process Request Details** section is expanded when you are editing an off-process request.

The **Off-Process Request Details** section contains the following fields in a grid:

Field Name	Field Description	Mandatory (Yes or No)
Accumulation Category	Used to indicate the accumulation category whose field value you want to amend through the off-process request. The valid values are: <ul style="list-style-type: none"> • Aggregate Stop Loss • Discount Arrangement • Level Funded • Specific Stop-Loss 	Yes
Accumulation Group ID	Used to indicate the accumulation group for which the (accumulation and amendment) changes should be reflected in the system. Note: The Search (🔍) icon appears corresponding to the Accumulation Group ID field. On clicking the Search icon, the Accumulation Group Search window appears. On specifying the accumulation group Id, the description of the accumulation group Id appears corresponding to the Accumulation Group ID field. If the accumulation category is set to Specific Stop-Loss , you can only select the accumulation group defined at the bill group level. However, if the accumulation category is set to Aggregate Stop-Loss, Discount Arrangement, or Level Funded , you can only select the accumulation group defined at the parent customer level.	No

Field Name	Field Description	Mandatory (Yes or No)
Amendment Field	<p>Used to indicate the accumulation field whose value you want to amend through the off-process request. The valid values are:</p> <ul style="list-style-type: none"> • ASL Limit • Aggregated Amount • Cumulative ASL Credit • Cumulative SSL Credit • Maximum Limit • Minimum Limit • Run Out Fund • Settlement Fund <p>Note: You can select only those accumulation categories and fields for which the contract type and adjustment type or billable charge line type information is available in the respective off-process request type.</p>	<p>Yes (Conditional)</p> <p>Note: This field is required when you select the Accumulation Category for the off-process request.</p>
Account ID	<p>Used to indicate the account for which the adjustment or billable charge should be created in the system.</p> <p>Note: The account ID and the account information appear automatically when you select the appropriate option from the Amendment Field field.</p> <p>The Search (🔍) icon appears corresponding to the Account ID field. On clicking the Search icon, the Account Search window appears.</p> <p>On specifying the account ID, the description of the account appears corresponding to the Account ID field.</p>	<p>Yes (Conditional)</p> <p>Note: This field is required when you select the Accumulation Group ID for the off-process request.</p>
Off-Process Amount	<p>Used to specify the amount which you want amend through the off-process request.</p>	<p>Yes (Conditional)</p> <p>Note: This field is required when you select the Accumulation Category for the off-process request.</p>

Field Name	Field Description	Mandatory (Yes or No)
Adjustment Type/ Billable Charge Line Type	Used to indicate the adjustment type or billable charge line type using which the adjustment or billable charge should be created when the amendment mode is set to Adjustment or Billable Charge in the respective off-process request type.	Yes (Conditional)
	<p>Note:</p> <p>The Search () icon appears corresponding to the Adjustment Type/Billable Charge Line Type field. On clicking the Search icon, the Adjustment Type/Billable Charge Line Type Search window appears.</p> <p>On specifying the value for a predefined adjustment type or billable charge line type, the description of the adjustment type or billable charge line type appears corresponding to the Adjustment Type/Billable Charge Line Type Search field.</p> <p>Once the Amendment Field is selected, its respective adjustment type or billable charge line type appears in the Adjustment Type/Billable Charge Line Type field.</p>	<p>Note: This field is required when you select the Accumulation Category for the off-process request.</p>
Member/Subscriber ID	Used to specify member or the main subscriber for whom the field value should be amended in the system.	No
Effective Date	Used to indicate the date from when the field value should be amended in the system.	Yes (Conditional)
		<p>Note: This field is required when you select the Accumulation Category for the off-process request.</p>
Coverage Start Date	Used to indicate the date from when the amendment is applicable for the off-process request.	No
Coverage End Date	Used to indicate the date till when the amendment is applicable for the off-process request.	No

- Enter the required details in the **Off-Process Request Details** section.
- If you want to define more than one off-process request detail for the off-process request, click the **Add** (+) icon and then repeat step 2.

Note: However, if you want to remove an off-process request detail from the off-process request, click the **Delete** () icon corresponding to the off-process request detail.

Related Topics

For more information on...	See...
How to define an off-process request	Defining an Off-Process Request on page 3241
How to edit an off-process request	Editing an Off-Process Request on page 3253

Defining a Characteristic for an Off-Process Request

Prerequisites

To define a characteristic for an off-process request, you should have:

- Off-process request types defined in the application
- Characteristic types defined in the application (where the characteristic entity is set to **Off-Process Request**)

Procedure

To define a characteristic for an off-process request:

1. Ensure that the **Characteristics** section is expanded when you are defining, editing, or copying an off-process request.

The **Characteristics** section contains the following fields in a grid:

Field Name	Field Description	Mandatory (Yes or No)
Effective Date	Used to specify the date from when the characteristic is effective for the off-process request.	Yes (Conditional)
		Note: This field is required when you are defining a characteristic for the off-process request.
Characteristic Type	Used to indicate the characteristic type.	Yes (Conditional)
		Note: The list includes only those characteristic types where the characteristic entity is set to Off-Process Request . Note: This field is required when you are defining a characteristic for the off-process request.
Characteristic Value	Used to specify the value for the characteristic type.	Yes (Conditional)
		Note: This field is required when you are defining a characteristic for the off-process request.

2. Enter the required details in the **Characteristic** section.
3. If you want to define more than one characteristic for the off-process request, click the **Add (+)** icon and then repeat step 2.

Note: However, if you want to remove a characteristic from the off-process request, click the **Delete (🗑)** icon corresponding to the off-process request information.

Related Topics

For more information on...	See...
How to edit an off-process request	Editing an Off-Process Request on page 3253

Editing an Off-Process Request

Procedure

To edit an off-process request:

1. Search for the off-process request in the **Off-Process request** screen.

- In the **Search Results** section, click the link in the **Off-Process Request Information** column corresponding to the off-process request whose details you want to edit.

The **Off-Process Request** screen appears.

- Click the **Edit** button in the **Off-Process Request** zone.

Note: The **Edit** button appears only when the off-process request is in the **Draft** status.

The **Edit Off-Process Request** screen appears. It contains the following sections:

- **Main** - Used to specify basic details about the off-process request.
- **Off-Process Request Information** - Used to specify the off-process request information.
- **Characteristics** - Used to define the characteristics for the off-process request.

The **Main** section contains the following fields:

Field Name	Field Description	Mandatory (Yes or No)
Off-Process Request Information	Displays information about the off-process request.	Not applicable
Off-Process Request Type	Indicates the off-process request type.	Not applicable
Creation Mode	Indicates the mode in which the offset request is created. The valid values are: <ul style="list-style-type: none"> • Automatic • Manual 	Not applicable
Parent Person ID	Indicates the parent customer (.e. person whose person type is set to Parent Customer) whose off-process request you want to edit.	No
Comments	Used to specify the comments for an off-process request	No

- Modify the details of the off-process request, if required.
- Define, edit, or remove off-process request details from the off-process request, if required.
- Define, edit, or remove characteristics of the off-process request, if required.
- Click **Save**.

The changes made to the off-process request are saved.

Related Topics

For more information on...	See...
How to search for an off-process request	Searching for an Off-Process Request on page 3241
Off-Process Request screen	Off-Process Request (Used for Searching) on page 3238
Off-Process Request zone	Off-Process Request on page 3244
How to define a characteristic for an off-process request	Defining a Characteristic for an Off-Process Request on page 3253

Deleting an Off-Process Request

Procedure

To delete an off-process request:

1. Search for the off-process request in the **Off-Process Request** screen.
2. In the **Search Results** section, click the link in the **Off-Process Request Information** column corresponding to the off-process request that you want to delete.

The **Off-Process Request** screen appears.

3. Click the **Delete** button in the **Off-Process Request** zone.

A message appears confirming whether you want to delete the off-process request.

Note: The **Delete** button appears when the off-process request is in the **Draft** status.

4. Click **OK**.

The off-process request is deleted.

Related Topics

For more information on...	See...
How to search for an off-process request	Searching for an Off-Process Request on page 3241
Off-Process Request screen	Off-Process Request Type on page 3223
Off-Process Request zone	Off-Process Request on page 3244

Submitting an Off-Process Request

Prerequisites

To submit an off-process request, you should have:

- Accumulation and amendment details defined in the off-process request
- Adjustment types or billable charge line types defined in the off-process request

Procedure

To submit an off-process request:

1. Search for the off-process request in the **Off-Process Request** screen.
2. In the **Search Results** section, click the link in the **Off-Process Request Information** column corresponding to the off-process request that you want to submit.

The **Off-Process Request** screen appears.

3. Click the **Submit** button in the **Off-Process Request** zone.

The system behaves in the following manner:

If...	Then...
The Approval Required option is selected in the respective off-process request type	A To Do of the C1-OFPAP To Do type is created and sent to the approver. The status of the Off-Process Request is then changed to Approval In Progress . Once the approver approves the off-process request, the status of the off-process request is changed to Approved . The system then creates the adjustments or billable charges to amend the accumulation field values. Finally, the status of the off-process request is changed to Processed .
The Approval Required option is not selected in the respective off-process request type	The system creates the adjustments or billable charges to amend the accumulation field values. Finally, the status of the off-process request is changed to Processed .

Note: The **Submit** button appears when the off-process request is in the **Draft** status.

Related Topics

For more information on...	See...
How to search for an off-process request	Searching for an Off-Process Request on page 3241
Off-Process Request screen	Off-Process Request (Used for Searching) on page 3238
Off-Process Request zone	Off-Process Request on page 3244

Approving an Off-Process Request

You can view the number of off-process requests which are pending for approval in the **Off-Process Request** screen. The approver can review, and accordingly approve, reject, or submit the off-process request based on the observations.

Note: The system will not allow you to approve, reject or submit an off-process request submitted by you.

Procedure

To approve an off-process request:

1. Do either of the following:

If you want to...	Then...
Approve an off-process request through the Off-Process Request screen	<ol style="list-style-type: none"> 1. Search for the off-process request in the Off-Process Request screen. 2. In the Search Results section, click the link in the Off-Process Request Information column corresponding to the off-process request which you want to review.
Approve an off-process request from the To Do List screen	<ol style="list-style-type: none"> 1. Click the Menu link in the Application toolbar. A list appears. 2. From the Main menu, select To Do and then click To Do List. The To Do Type for User Search window appears. 3. Enter C1-OFPAP in the To Do Type field. 4. Click the Search button corresponding to the To Do Type field. The To Do List screen appears. 5. Select the Open option from the Filter by list to view all unassigned To Dos. 6. Click the link in the Message column corresponding to the To Do of the off-process request that you want to review.

The **Off-Process Request** screen appears.

2. Review the off-process request details in the **Off-Process Request** screen.

3. If the information in the off-process request is accurate, click the **Approve** button in the **Off-Process Request** zone.

If you are...	Then...
Approving an off-process request	The status of the off-process request is changed to Approved . The system then creates the adjustments or billable charges to amend the accumulation field values. Finally, the status of the off-process request is changed to Processed .

Note: The **Approve** button appears when:

- The off-process request is in the **Approval In Progress** status.
- A user with the approval To Do role is reviewing the off-process request.

Related Topics

For more information on...	See...
How to search for an off-process request	Searching for an Off-Process Request on page 3241
Off-Process Request screen	Off-Process Request (Used for Searching) on page 3238
Off-Process Request zone	Off-Process Request on page 3244

Rejecting an Off-Process Request

Prerequisites

To reject an off-process request, you should have:

- Reasons defined for the **Rejected** status of the **C1-OffProcessRequest** business object in the **Status Reason** screen

Note: The system will not allow you to approve, reject or submit an off-process request submitted by you.

Procedure

To reject an off-process request:

1. Do either of the following:

If you want to...	Then...
Reject an off-process request through the Off-Process Request screen	<ol style="list-style-type: none"> 1. Search for the off-process request in the Off-Process Request screen. 2. In the Search Results section, click the link in the Off-Process Request Information column corresponding to the off-process request which you want to review.

If you want to...	Then...
Reject an off-process request from the To Do List screen	<ol style="list-style-type: none"> 1. Click the Menu link in the Application toolbar. A list appears. 2. From the Main menu, select To Do and then click To Do List. The To Do Type for User Search window appears. 3. Enter C1-OFPPAP in the To Do Type field. 4. Click the Search button corresponding to the To Do Type field. The To Do List screen appears. 5. Select the Open option from the Filter by list to view all unassigned To Dos. 6. Click the link in the Message column corresponding to the To Do of the off-process request that you want to review.

The **Off-Process Request** screen appears.

2. Review the off-process request details in the **Off-Process Request** screen.
3. If the information in the off-process request is incorrect, then click the **Reject** button in the **Off-Process Request** zone.

The **Reject Off-Process Request** window appears. It contains following fields:

Field Name	Field Description	Mandatory (Yes or No)
Status Reason	Used to indicate the reason why you want to reject the off-process request. Note: The list includes only those reasons which are defined for the Rejected status of the C1-OffProcessRequest business object in the Status Reason screen.	Yes
Comments	Used to specify additional information while rejecting the off-process request.	No

Note: The **Reject** button appears when:

- The off-process request is in the **Approval In Progress** status.
- A user with the approval To Do role is reviewing the off-process request.

4. Select the rejection reason from the **Status Reason** list.
5. Click **Save**.

The status of the off-process request is changed to **Rejected**.

Related Topics

For more information on...	See...
How to search for an off-process request	Searching for an Off-Process Request on page 3241
Off-Process Request screen	Off-Process Request (Used for Searching) on page 3238
Off-Process Request zone	Off-Process Request on page 3244

Viewing the Log of an Off-Process Request

Procedure

To view the log of an off-process request:

1. Search for the off-process request in the **Off-Process Request** screen.
2. In the **Search Results** section, click the link in the **Off-Process Request Information** column corresponding to the off-process request whose log you want to view.

The **Off-Process Request** screen appears.

3. Click the **Log** tab.

The **Log** tab appears.

4. View the complete trail of actions performed on the off-process request in the **Off-Process Request Log** zone.

Related Topics

For more information on...	See...
How to search for an off-process request	Searching for an Off-Process Request on page 3241
Off-Process Request screen	Off-Process Request (Used for Searching) on page 3238
Off-Process Request Log zone	Off-Process Request Log on page 3248
How to add a log entry for an off-process request	Adding a Log Entry for an Off-Process Request on page 3259

Adding a Log Entry for an Off-Process Request

Procedure

To add a log entry for an off-process request:

1. Search for the off-process request in the **Off-Process Request** screen.
2. In the **Search Results** section, click the link in the **Off-Process Request Information** column corresponding to the off-process request whose log you want to edit.

The **Off-Process Request** screen appears.

3. Click the **Log** tab.

The **Log** tab appears.

4. Click the **Add Log Entry** link in the upper right corner of the **Off-Process Request Log** zone.

The **Add Off-Process Request Log** window appears. It contains the following fields:

Field Name	Field Description	Mandatory (Yes or No)
Off-Process Request Information	Displays information about the off-process request.	Not applicable

Field Name	Field Description	Mandatory (Yes or No)
Log Details	Used to specify additional comments for the off-process request.	Yes

5. Enter the comments in the **Log Details** field.

6. Click **Save**.

The log entry is added in the **Off-Process Request Log** zone.

Related Topics

For more information on...	See...
How to search for an off-process request	Searching for an Off-Process Request on page 3241
Off-Process Request screen	Off-Process Request (Used for Searching) on page 3238
Off-Process Request Log zone	Off-Process Request Log on page 3248

Chapter 40

Individual Health Insurance Pricing

Topics:

- [Business Rules](#)

Oracle Revenue Management and Billing enables you to define pricing for different services offered in a health plan. Each service offered in a health plan should be defined as a price item in the system. For example, services may include medical insurance, home care, hospital visits, etc.

You can define the age based, tier based, or additional charge pricing for a price item using the respective pricing rule. You can create an age based, tier based, and additional charge pricing rule using the respective pricing rule type. The following pricing rule type and pricing rule business objects are enhanced to support the fully-insured individual business:

- C1-PrcRuleTypeAgeBased
- C1-PricingRuleAgeBased
- C1-PrcRuleTypeTierBased
- C1-PricingRuleTierBased
- C1-PrcRuleTypeCapitationFee
- C1-PricingRuleCapitationFee
- C1-PrcRuleTypeBenefit

You can create a pricing rule for a health plan using a pricing rule type only when the pricing rule type is associated with the health plan. The system enables you to define pricing rules for various services offered in the health plan. You must add the required price items in a pricing rule type. The system then enables you to create a pricing rule for a price item using the respective pricing rule type. While defining an age based pricing rule for a price item, you can offer different rates to different member persons based on the age, member relationship, geographic rating area, member person attributes, etc. You can also charge additional fee or given discount to a member person based on modifier attributes. For example, you may charge more premium to an alcoholic person compared to a non-alcoholic person for the same service (i.e. price item). While defining a tier based pricing rule for a price item, you can offer different rates to different memberships based on the subscription tier, geographic rating area, member person attributes, etc.

You can associate one or more pricing rule types with a health plan through a health product and plan inbound message. You can define one or more pricing rules for a health plan through a health product and plan inbound message. The system creates the pricing rule for a price item using the business object which is specified in the pricing rule type. While creating a pricing rule for a health plan, you can define pricing eligibility rules for a pricing rule. The system considers the pricing rule for an individual membership when the pricing eligibility rule (i.e. eligibility criteria) is satisfied.

The system enables you to define a pricing rule for a price item without the pricing rule eligibility. Such pricing rule is considered as a default pricing rule for the price item. If an individual membership is not eligible for any pricing rule, the system uses the default pricing rule of the price item for the individual membership.

Note: On inactivating a health plan, the system will not automatically inactivate the pricing rules defined for the health plan.

Business Rules

Oracle Revenue Management and Billing facilitates you to calculate the premium for each individual membership differently based on various health product, health plan, membership, or member person attributes. You can define different set of business rules for the following categories:

- **Fully-Insured Pricing** - If an individual membership meets the criteria of a fully-insured pricing business rule, the system derives the following information from the business rule:
 - Maximum Age Limit of Dependents
 - Dependent Order Priority
 - Age Calculation Date
 - Age Recalculation Date
 - Young Adult Applicability
 - Young Adult Max Age Limit
 - Member Relationship Derivation Date
- **New Born** - If an individual membership meets the criteria of a new born business rule, the system derives the following information from the business rule:
 - Gift Days Applicability
 - New Born Gift Days

A business rule contains a criteria. If the criteria of the business rule is met, the information is derived from the business rule. This information is used while deriving the member relationship for a member person, subscription tier for an individual membership, and while deriving eligible member persons for premium calculation.

You can define criteria for a business rule using a set of parameters which are associated with a business rule type. The system enables you to associate only those parameters in a business rule type where the parameter usage is set to **Business Rule Eligibility Criteria**.

To implement the business rule feature, the following new screens are introduced in this release:

- **Business Rule Type** - Used to specify a list of parameters where the parameter usage is set to **Business Rule Eligibility Criteria**. You can then use the parameter while defining a criteria in the business rule.
- **Business Rule** - Used to search business rules of a particular category (i.e. Fully-Insured Pricing or New Born).

At present, there is no user interface or inbound web service available from where you can define and edit the business rules for each category. You will have to design and develop a custom user interface to create and edit the business rules.

Business Rule Type

The **Business Rule Type** screen allows you to search for a business rule type using various search criteria. It also allows you to define, edit and delete a business rule type. It contains the following zone:

- [Search Business Rule Type](#) on page 3263
- [Business Rule Type](#) on page 3267

Search Business Rule Type

The **Search Business Rule Type** zone allows you to search for a business rule type using various search criteria. It contains the following two sections:

- **Search Criteria** - The **Search Criteria** section contains the following fields:

Field Name	Field Description	Mandatory (Yes or No)
Business Rule Type	Used to search a particular business rule type.	No
Priority	Used to search a business rule type based on the priority.	No
	Note: If you set the priority to a lowest number, the system crawls from the lowest number to the highest, whenever you perform a search for a business rule type. For example, a business rule type with the priority 10 will be searched before a business rule type with the priority 20.	
Description	Used to search a business rule type having a particular description.	No
Criteria Sequence	Used to search a business rule type where the business rule criteria has a specific order of execution.	No
	Note: This field appears when you click the Advanced Search link.	
Criteria Description	Used to search a business rule type where the business rule criteria has a specific description.	No
	Note: This field appears when you click the Advanced Search link.	
Parameter 1	Used to search a business rule type with a parameter code.	No
	Note: This field appears when you click the Advanced Search link. You can specify the parameter code where the parameter usage is set to Business Rule Eligibility Criteria . You must not specify the ampersand (&) character in this field. The Search (🔍) icon appears corresponding to this field. On clicking the Search icon, the Parameter Search window appears.	
Parameter 1 Value	Used to search a business rule type with a parameter value.	Yes (Conditional)
		Note: This field is required if Parameter 1 is specified.

Field Name	Field Description	Mandatory (Yes or No)
Parameter 2	<p>Used to search a business rule type with a parameter code.</p> <p>Note: This field appears when you click the Advanced Search link. You can specify the parameter code where the parameter usage is set to Business Rule Eligibility Criteria. You must not specify the ampersand (&) character in this field. The Search (🔍) icon appears corresponding to this field. On clicking the Search icon, the Parameter Search window appears.</p>	No
Parameter 2 Value	Used to search a business rule type with a parameter value.	Yes (Conditional) <p>Note: This field is required if Parameter 2 is specified.</p>
Parameter 3	<p>Used to search a business rule type with a parameter code.</p> <p>Note: This field appears when you click the Advanced Search link. You can specify the parameter code where the parameter usage is set to Business Rule Eligibility Criteria. You must not specify the ampersand (&) character in this field. The Search (🔍) icon appears corresponding to this field. On clicking the Search icon, the Parameter Search window appears.</p>	No
Parameter 3 Value	Used to search a business rule type with a parameter value.	Yes (Conditional) <p>Note: This field is required if Parameter 3 is specified.</p>

Field Name	Field Description	Mandatory (Yes or No)
Parameter 4	Used to search a business rule type with a parameter code. Note: This field appears when you click the Advanced Search link. You can specify the parameter code where the parameter usage is set to Business Rule Eligibility Criteria . You must not specify the ampersand (&) character in this field. The Search (🔍) icon appears corresponding to this field. On clicking the Search icon, the Parameter Search window appears.	No
Parameter 4 Value	Used to search a business rule type with a parameter value.	Yes (Conditional) Note: This field is required if Parameter 4 is specified.

Note: While searching for the business rule type, always ensure that you provide the parameter and the parameter value in a sequential order.

- **Search Results** - On clicking the **Search** button, the search results appear based on the specified search criteria. The **Search Results** section contains the following columns:

Column Name	Column Description
Business Rule Type	Displays the business rule type which is associated with the parameters of the usage type Business Rule Eligibility Criteria .
Description	Displays the description of the business rule type.
Priority	Displays the priority of the business rule type.
Parameters	Indicates the parameters which are associated with the business rule type.
Edit	On clicking the Edit (✎) icon, the Business Rule Type screen appears where you can edit the business rule type details.
Delete	On clicking the Delete (🗑) icon, you can delete the business rule type.

Note:
Pagination is used to display limited number of records in the **Search Results** section. You can use the navigation links, such as **Previous** and **Next** to navigate between pages.

By default, the **Filter** area is visible. You can hide the **Filter** area by clicking the **Filters** (🔼) icon in the upper right corner of this zone.

On clicking the **Broadcast** (📡) icon corresponding to a business rule type, the **Business Rule Type** zone appears where you can view the details of the respective business rule type.

Related Topics

For more information on...	See...
Business Rule Type screen	Business Rule Type on page 3263
How to edit a business rule type	Editing a Business Rule Type on page 3272
How to delete a business rule type	Deleting a Business Rule Type on page 3273

Business Rule Type

The **Business Rule Type** zone displays the details of the business rule type. It contains the following sections:

- **Main** - Displays basic information about the business rule type. It contains the following fields:

Field Name	Field Description
Business Rule Type	Displays the business rule type.
Priority	Displays the priority of the business rule type.
Description	Displays the description of the business rule type.

- **Parameters** - The parameters section lists the parameters associated with the business rule type where the parameter usage is set to **Business Rule Eligibility Criteria**. It contains the following columns:

Column Name	Column Description
Sequence	Indicates the order in which the business rule criteria should be executed in the business rule.
Parameter	Indicates the parameter which is associated with the business rule type.

- **Characteristics** - The characteristics section lists the characteristics defined for the business rule type. It contains the following columns:

Column Name	Column Description
Characteristic Type	Indicates the characteristic type.
Characteristic Value	Displays the value of the characteristic type.

- **Record Actions** - This section contains the following buttons:

Button Name	Button Description
Edit	Used to edit the details of the business rule type.
Delete	Used to delete the business rule type.

- **Record Information** - This section contains the following field:

Field Name	Field Description
Business Object	Indicates the business object using which the business rule type is created. In addition, a context menu appears corresponding to this field which helps in navigating to other screens in the application.
	Note: It has a link. On clicking the link, the Business Object screen appears where you can view the details of the respective business object.



Note: By default, the **Business Rule Type** zone does not appear in the **Business Rule Type** screen. It appears when you click the **Broadcast** (📡) icon corresponding to a business rule type in the **Search Business Rule Type** zone.

Related Topics

For more information on...	See...
How to edit a business rule type	Editing a Business Rule Type on page 3272
How to delete a business rule type	Deleting a Business Rule Type on page 3273
How to view the details of a business rule type	Viewing the Business Rule Type Details on page 3269

Business Rule Criteria

The **Business Rule Criteria** zone displays the criteria details of the business rule. It contains the following columns:

Column Name	Column Description
Criteria Sequence	Displays the order in which the criteria is executed in the business rule.
Criteria Description	Displays the description of the criteria.
Criteria	Displays the details of the criteria.
Edit	On clicking the Edit () icon, the Business Rule Criteria screen appears where you can edit the business rule criteria details.
Delete	On clicking the Delete () icon, you can delete the business rule criteria.

Note:

By default, the **Business Rule Criteria** zone does not appear in the **Business Rule Type** screen. It appears when you click the **Broadcast** () icon corresponding to a business rule type in the **Search Business Rule Type** zone.

You can either edit or delete all the business criterias by clicking the **Select All** check box available in the first column of the table in the **Business Rule Criteria** zone.

You can also add a new business criteria by clicking the **Add** link in the upper right corner of the **Business Rule Criteria** zone.

Related Topics

For more information on...	See...
How to edit the business rule criteria of a business rule type	Editing the Business Rule Criteria of a Business Rule Type on page 3275

Searching for a Business Rule Type**Prerequisites**

To search for a business rule type, you should have:

- Parameters defined in the application where the parameter usage is set to **Business Rule Eligibility Criteria**

Procedure

To search for a business rule type:

- Click the **Admin** link in the **Application** toolbar.
A list appears.
- From the **Admin** menu, click **B** and then click **Business Rule Type**.
A sub-menu appears.

- Click the **Search** option from the **Business Rule Type** sub-menu.

The **Business Rule Type** screen appears.

- Enter the search criteria in the **Search Business Rule Type** zone.

Note: ORMB search engine supports wildcard search, where you can substitute the percentage (%) symbol as a stand in for any word or letter in a search criteria. You can use the ‘%’ wildcard character in all input fields except the date and ID fields. The ‘%’ wildcard character is suffixed automatically at the end of the partial search criteria. Therefore, you may or may not specify the wildcard character at the end of the partial search criteria. However, you have to prefix the wildcard character manually wherever required.

- Click **Search**.

A list of business rule types that meet the search criteria appears in the **Search Results** section.

Note: Pagination is used to display limited number of records in the **Search Results** section. You can use the navigation links, such as **Previous** and **Next** to navigate between pages.

Related Topics

For more information on...	See...
Search Business Rule Type zone	Search Business Rule Type on page 3263
Business Rule Type screen	Business Rule Type on page 3263
Business Rule Criteria screen	Business Rule Criteria on page 3268

Viewing the Business Rule Type Details

Procedure

To view the business rule type details:

- Search for the business rule type in the **Business Rule Type** screen.
- In the **Search Results** section, click the **Broadcast** (📡) icon corresponding to the business rule type whose details you want to view:

The **Business Rule Type** zone appears.

- View the details of the business rule type in the **Business Rule Type** zone.

Related Topics

For more information on...	See...
Business Rule Type screen	Business Rule Type on page 3263
Search Business Rule Type zone	Search Business Rule Type on page 3263
Business Rule Type zone	Business Rule Type on page 3267

Defining a Business Rule Type

Prerequisites

To define a business rule type you should have:

- Parameters defined in the application (where the **Business Rule Eligibility Criteria** option is selected in the **Parameter Usage** section)
- Characteristic types defined in the application (where the characteristic entity is set to **Business Rule Type**).

Procedure

To define a business rule type:

1. Click the **Admin** link in the **Application** toolbar.
A list appears.
2. From the **Admin** menu, select **B** and then click **Business Rule Type**.
A sub-menu appears.
3. Click the **Add** option from the **Business Rule Type** sub-menu.

The **Business Rule Type** screen appears. It contains the following sections:

- **Main** - Used to specify basic details about the business rule type.
- **Parameters** - Used to associate the parameters with the business rule type.
- **Characteristics** - Used to define the characteristics for the business rule type.

The **Main** section contains the following fields:

Field Name	Field Description	Mandatory (Yes or No)
Business Rule Type	Used to specify the business rule type.	Yes
Priority	Used to specify the priority for the business rule type. Note: If you set the priority to a lowest number, the system crawls from the lowest number to the highest, whenever you perform a search for a business rule type. For example, a business rule type with the priority 10 will be searched before a business rule type with the priority 20. The priority cannot be less than or equal to zero.	Yes
Description	Used to specify the description for the business rule type.	Yes

Tip: Alternatively, you can access the **Business Rule Type** screen by clicking the **Add** button in the **Page Title** area of the **Business Rule Type** screen.

4. Enter the required details in the **Main** section.
5. Associate the parameters with the business rule type, if required.
6. Define the characteristics for the business rule type, if required.
7. Click **Save**.

The business rule type is defined.

Related Topics

For more information on...	See...
Business Rule Type screen	Business Rule Type on page 3263
How to associate parameters with the business rule type	Associating a Parameter with a Business Rule Type on page 3271
How to define a characteristic for the business rule type	Defining a Characteristic for a Business Rule Type on page 3271

Associating a Parameter with a Business Rule Type

Prerequisites

To associate a parameter with a business rule type, you should have:

- Parameters defined in the application (where the **Business Rule Eligibility Criteria** option is selected in the **Parameter Usage** section)

Procedure

To associate a parameter with a business rule type:

- Ensure that the **Parameters** section is expanded when you are defining, editing, or copying a business rule type.

The **Parameters** section contains the following fields in a grid:

Field Name	Field Description	Mandatory (Yes or No)
Sequence	Used to specify the sequence number for the parameter.	Yes (Conditional)
	Note: The sequence cannot be less than or equal to zero.	Note: This data is required while associating the parameters with the business rule type.
Parameter	Used to indicate the parameter which you want to associate with the business rule type.	Yes (Conditional)
	Note: The Search (🔍) icon appears corresponding to the Parameter field. On clicking the Search icon, the Parameter Search window appears. On specifying the value for a parameter, the description of the parameter appears corresponding to the Parameter field.	Note: This data is required while associating the parameters with the business rule type.

- Enter the required details in the **Parameters** section.
- If you want to associate more than one parameter with the business rule type, click the **Add** (+) icon and then repeat step 2.

Note: However, if you want to disassociate a parameter from the business rule type, click the **Delete** (🗑️) icon corresponding to the parameter.

- Click **Save**.

The parameter is associated with the business rule type.

Related Topics

For more information on...	See...
How to define a business rule type	Defining a Business Rule Type on page 3269
How to edit a business rule type	Editing a Business Rule Type on page 3272

Defining a Characteristic for a Business Rule Type

Prerequisites

To define a characteristic for a business rule type, you should have:

- Characteristic types defined in the application (where the characteristic entity is set to **Business Rule Definition**)

Procedure

To define a characteristic for a business rule type:

1. Ensure that the **Characteristics** section is expanded when you are defining, editing, or copying a business rule type.

The **Characteristics** section contains the following fields in a grid:

Field Name	Field Description	Mandatory (Yes or No)
Characteristic Type	Used to indicate the characteristic type.	No
	Note: The list includes only those characteristic types where the characteristic entity is set to Business Rule Definition .	
Characteristic Value	Used to specify the value for the characteristic type.	No
	Note: On specifying the value for a predefined characteristic type, the description of the characteristic value appears corresponding to the Characteristic Value field.	

2. Enter the required details in the **Characteristics** section.
3. If you want to define more than one characteristic for the business rule type, click the **Add (+)** icon and then repeat step 2.

Note: However, if you want to remove a characteristic from the business rule type, click the **Delete (🗑)** icon corresponding to the characteristic.

4. Click **Save**.

The characteristic is defined for the business rule type.

Related Topics

For more information on...	See...
How to define a business rule type	Defining a Business Rule Type on page 3269
How to edit a business rule type	Editing a Business Rule Type on page 3272

Editing a Business Rule Type

Prerequisites

To edit a business rule type you should have:

- Parameters defined in the application (where the **Business Rule Eligibility Criteria** option is selected in the **Parameter Usage** section)
- Characteristic types defined in the application (where the characteristic entity is set to **Business Rule Type**).

Procedure

To edit a business rule type:

1. Search for the business rule type in the **Business Rule Type** screen.

2. In the **Search Results** section, click the **Edit** (✎) icon in the **Edit** column corresponding to the business rule type whose *details* you want to edit.

The **Business Rule Type** screen appears. It contains the following sections:

- **Main** - Used to specify basic details about the business rule type.
- **Parameters** - Used to associate the parameters with the business rule type.
- **Characteristics** - Used to define the characteristics for the business rule type

The **Main** section contains the following fields:

Field Name	Field Description	Mandatory (Yes or No)
Business Rule Type	Displays the business rule type.	Not applicable
Priority	Used to specify the priority for the business rule type. Note: If you set the priority to a lowest number, the system crawls from the lowest number to the highest, whenever you perform a search for a business rule type. For example, a business rule type with the priority 10 will be searched before a business rule type with the priority 20. The priority cannot be less than or equal to zero.	Yes
Description	Used to specify the description for the business rule type.	Yes

3. Modify the required details in the **Main** section.
4. Associate or disassociate parameters from the business rule type, if required.
5. Define, edit, or remove characteristics of the business rule type, if required.
6. Click **Save**.

The changes made to the business rule type are saved.

Tip: Alternatively, you can edit the details of a business rule type by clicking the **Edit** button in the **Business Rule Type** zone.

Related Topics

For more information on...	See...
Business Rule Type screen	Business Rule Type on page 3263
Business Rule Type zone	Business Rule Type on page 3267
How to associate parameters with the business rule type	Associating a Parameter with a Business Rule Type on page 3271
How to define a characteristic for the business rule type	Defining a Characteristic for a Business Rule Type on page 3271

Deleting a Business Rule Type

Procedure

To delete a business rule type:

1. Search for the business rule type in the **Business Rule Type** screen.
2. In the **Search Results** section, click the **Delete** (🗑️) icon in the **Delete** column corresponding to the business rule type that you want to delete.
A message appears confirming whether you want to delete the business rule type.

Note: You can delete a business rule type when a deal is not created using the business rule type.

Tip: Alternatively, you can delete a business rule type by clicking the **Delete** button in the **Business Rule Type** zone.

3. Click **OK**.
The business rule type is deleted.

Related Topics

For more information on...	See...
Business Rule Type screen	Business Rule Type on page 3263
Business Rule Type zone	Business Rule Type on page 3267

Defining a Business Rule Criteria for a Business Rule Type

Procedure

To define a business rule criteria for a business rule type, you should have:

- Business rule type defined in the application.
- Parameters defined in the application where the parameter usage is set to **Business Rule Eligibility Criteria**.

Procedure

To define a business rule criteria for a business rule type:

1. Search for the business rule type in the **Business Rule Type** screen.
2. In the **Search Results** section, click the **Broadcast** (📡) icon corresponding to the business rule type whose business rule criteria details you want to edit.

The following zones appear:

- [Business Rule Type](#) on page 3267
- [Business Rule Criteria](#) on page 3268

3. In the **Business Rule Criteria** zone, click the **Add** link in the upper-right corner of this zone.

The **Business Rule Criteria** screen appears. It contains the following columns:

Column Name	Column Description
Business Rule Type	Displays the business rule type for which you want to define the criteria.
Description	Displays the description of the business rule type.

In addition to these columns, this screen contains additional fields:

Field Name	Field Description
Criteria Sequence	Used to specify the order in which the criteria is executed in the business rule.
Criteria Description	Used to specify the description of the criteria.

Field Name	Field Description						
Criteria	In addition, this column contains some more additional fields: <table border="1"> <thead> <tr> <th>Field Name</th> <th>Field Description</th> </tr> </thead> <tbody> <tr> <td>Parameter</td> <td>Displays the parameter code associated with the criteria. Note: This is a read-only field.</td> </tr> <tr> <td>Parameter Value</td> <td>Used to indicate the value of the parameter code. Note: This is a read-only field. The Search (🔍) icon appears corresponding to this field. On clicking the Search icon, the Parameter Search window appears. On specifying the parameter, the description of the parameter appears corresponding to the Parameter Value field.</td> </tr> </tbody> </table>	Field Name	Field Description	Parameter	Displays the parameter code associated with the criteria. Note: This is a read-only field.	Parameter Value	Used to indicate the value of the parameter code. Note: This is a read-only field. The Search (🔍) icon appears corresponding to this field. On clicking the Search icon, the Parameter Search window appears. On specifying the parameter, the description of the parameter appears corresponding to the Parameter Value field.
Field Name	Field Description						
Parameter	Displays the parameter code associated with the criteria. Note: This is a read-only field.						
Parameter Value	Used to indicate the value of the parameter code. Note: This is a read-only field. The Search (🔍) icon appears corresponding to this field. On clicking the Search icon, the Parameter Search window appears. On specifying the parameter, the description of the parameter appears corresponding to the Parameter Value field.						

- Enter the required business rule criteria details.
- If you want to add more than one criteria to the business rule type, click the **Add** (+) icon and then repeat step 2.

Note: However, if you want to remove a criteria from the business rule type, click the **Delete** (🗑️) icon corresponding to the criteria sequence field.

- Click **Save**.

The business rule criteria is defined for the business rule type.

Related Topics

For more information on...	See...
Business Rule Type screen	Business Rule Type on page 3263

Editing the Business Rule Criteria of a Business Rule Type

Procedure

To edit the business rule criteria of a business rule type:

- Search for the business rule type in the **Business Rule Type** screen.
- In the **Search Results** section, click the **Broadcast** (📡) icon corresponding to the business rule type whose business rule criteria details you want to edit.

The following zones appear:

- [Business Rule Type](#) on page 3267
- [Business Rule Criteria](#) on page 3268

- In the **Business Rule Criteria** zone, click the check box corresponding to the **Criteria Sequence** column whose business rule criteria details you want to edit and click the **Edit** button available above the table in this zone.

The **Business Rule Criteria** screen appears.

Note: You can also edit all the business criterias by clicking the **Select All** check box available in the first column of the table

The **Business Rule Criteria** screen contains the following columns:

Column Name	Column Description
Business Rule Type	Displays the business rule type.
Description	Displays the description of the business rule type.

In addition to these columns, this screen contains additional fields:

Field Name	Field Description								
Criteria Sequence	Displays the order in which the criteria is executed in the business rule.								
	Note: This is a read-only field.								
Criteria Description	Used to specify the description of the criteria.								
Criteria	In addition, this column contains some more additional fields:								
	<table border="1"> <thead> <tr> <th>Field Name</th> <th>Field Description</th> </tr> </thead> <tbody> <tr> <td rowspan="2">Parameter</td> <td>Displays the parameter code associated with the criteria.</td> </tr> <tr> <td>Note: This is a read-only field.</td> </tr> <tr> <td rowspan="2">Parameter Value</td> <td>Indicates the value of the parameter code.</td> </tr> <tr> <td>Note: This is a read-only field.</td> </tr> </tbody> </table>	Field Name	Field Description	Parameter	Displays the parameter code associated with the criteria.	Note: This is a read-only field.	Parameter Value	Indicates the value of the parameter code.	Note: This is a read-only field.
	Field Name	Field Description							
	Parameter	Displays the parameter code associated with the criteria.							
Note: This is a read-only field.									
Parameter Value	Indicates the value of the parameter code.								
	Note: This is a read-only field.								

- Modify the criteria description.

Note: You can only modify the criteria description.

- Click **Save**.

The changes made to the business rule criteria are saved.

Related Topics

For more information on...	See...
Business Rule Type screen	Business Rule Type on page 3263

Deleting the Business Rule Criteria of a Business Rule Type

Procedure

To delete the business rule criteria of a business rule type:

- Search for the business rule type in the **Business Rule Type** screen.

- In the **Search Results** section, click the **Broadcast** (📡) icon corresponding to the business rule type whose criteria details you want to view.

The following zones appear:

- Business Rule Type**
 - Business Rule Criteria**
- In the **Business Rule Criteria** zone, click the check box corresponding to the **Criteria Sequence** column whose business rule criteria details you want to delete and click the **Delete** button available above the table in this zone.

A message appears confirming whether you want to delete the business rule criteria.

- Click **OK**.

The business rule criteria is deleted.

Related Topics

For more information on...	See...
Business Rule Type screen	Business Rule Type on page 3263
Search Business Rule Type zone	Search Business Rule Type on page 3263
Business Rule Type zone	Business Rule Type on page 3267
Business Rule Criteria zone	Business Rule Criteria on page 3268

Business Rule (Used for Searching)

The **Business Rule** screen allows you to search for a business rule using various search criteria. It also allows you to define, edit, and delete a business rule. It contains the following zones:

- [Search Business Rule](#) on page 3277
- [Business Rule Log](#) on page 3280

Search Business Rule

The **Search Business Rule** zone allows you to search for a business rule using various search criteria. It contains the following two sections:

- Search Criteria** - The **Search Criteria** section contains the following fields:

Field Name	Field Description	Mandatory (Yes or No)
Search By	Used to indicate whether you want to search for a business rule using the business rule category. The valid values are: <ul style="list-style-type: none"> Binder Payment Rules Fully-Insured Pricing Rules New Born Rules Rate Guarantee Rules 	No
	Note: By default, the Fully-Insured Pricing Rules option is selected.	
Business Rule ID	Used to search a particular business rule.	No

Field Name	Field Description	Mandatory (Yes or No)
Business Rule Type Description	Used to search a business rule with a particular business rule type description.	No
Effective Date	Used to search business rule which is effective from a particular date.	No
Criteria Description	Used to search a business rule with a particular business rule criteria description.	No
Status	Used to search business rules with a particular status. The valid values are: <ul style="list-style-type: none"> • Active • Inactive 	No
Parameter 1	Used to search a business rule based on a particular parameter code. <div style="border: 1px solid black; padding: 5px; margin-top: 10px;"> <p>Note:</p> <p>You can specify the parameter code where the parameter usage is set to Business Rule Eligibility Criteria.</p> <p>You must not specify the ampersand (&) character in this field.</p> <p>The Search (🔍) icon appears corresponding to this field. On clicking the Search icon, the Parameter Search window appears.</p> </div>	No
Parameter 1 Value	Used to search a business rule based on a particular parameter value.	Yes (Conditional) <div style="border: 1px solid black; padding: 5px; margin-top: 10px;"> <p>Note: This field is required if Parameter 1 is specified.</p> </div>
Parameter 2	Used to search a business rule based on a particular parameter code. <div style="border: 1px solid black; padding: 5px; margin-top: 10px;"> <p>Note:</p> <p>You can specify the parameter code where the parameter usage is set to Business Rule Eligibility Criteria.</p> <p>You must not specify the ampersand (&) character in this field.</p> <p>The Search (🔍) icon appears corresponding to this field. On clicking the Search icon, the Parameter Search window appears.</p> </div>	No
Parameter 2 Value	Used to search a business rule based on a particular parameter value.	Yes (Conditional) <div style="border: 1px solid black; padding: 5px; margin-top: 10px;"> <p>Note: This field is required if Parameter 2 is specified.</p> </div>

Field Name	Field Description	Mandatory (Yes or No)
Parameter 3	Used to search a business rule based on a particular parameter code.	No
	<p>Note:</p> <p>You can specify the parameter code where the parameter usage is set to Business Rule Eligibility Criteria.</p> <p>You must not specify the ampersand (&) character in this field.</p> <p>The Search (🔍) icon appears corresponding to this field. On clicking the Search icon, the Parameter Search window appears.</p>	
Parameter 3 Value	Used to search a business rule based on a particular parameter value.	Yes (Conditional)
		Note: This field is required if Parameter 3 is specified.
Parameter 4	Used to search a business rule based on a particular parameter code.	No
	<p>Note:</p> <p>You can specify the parameter code where the parameter usage is set to Business Rule Eligibility Criteria.</p> <p>You must not specify the ampersand (&) character in this field.</p> <p>The Search (🔍) icon appears corresponding to this field. On clicking the Search icon, the Parameter Search window appears.</p>	
Parameter 4 Value	Used to search a business rule based on a particular parameter value.	Yes (Conditional)
		Note: This field is required if Parameter 4 is specified.

Note: While searching for the business rule, always ensure that you provide the parameter and the parameter value in a sequential order.

- **Search Results** - On clicking the **Search** button, the search results appear based on the specified search criteria. The **Search Results** section contains the following columns:

Column Name	Column Description
Criteria Description	Displays the description of the criteria which is associated with the business rule.
Eligibility Criteria	Displays the eligibility criteria for the business rule.
Priority	Displays the sequence in which the business rule criteria must be executed in the business rule.

Column Name	Column Description
Effective Date	Displays the date from when the business rule is effective.
Status	Indicates the status of the business rule. The valid values are: <ul style="list-style-type: none"> Active Inactive
Maximum Dependents	Indicates the maximum number of dependent persons which are eligible for premium calculation.
Dependant Max Age Limit	Indicates the maximum age limit for children which are eligible for premium calculation.
Dependant Order Priority	Indicates the order in which the system should first consider youngest or eldest children during premium calculation. The valid values are - YOUNGEST and ELDEST .
Age Calculation Date	Indicates whether you want to calculate the member person's age using the member person's enrollment date or policy's start or renewal date.
Age Recalculation Date	Indicates whether you want to recalculate the member person's age using the member person's age changes or next month or policy renewal date.
Young Adult Applicability	Indicates whether you want to consider the young adults during the premium calculation. The system supports the following two characteristic values — Y and N .
Young Adult Max Age Limit	Indicates the maximum age limit for young adults which are eligible for premium calculation.
Member Relationship Derivation Date	Indicates whether you want to derive the member relationship for a member person using its date of birth or enrollment date. The system supports the following two characteristic values — Date of Birth and Enrollment Date.
Business Rule ID	Displays the business rule ID.

Note: Pagination is used to display limited number of records in the **Search Results** section. You can use the navigation links, such as **Previous** and **Next** to navigate between pages.

By default, the **Filter** area is visible. You can hide the **Filter** area by clicking the **Filters** () icon in the upper right corner of this zone.

On clicking the **Broadcast** () icon corresponding to a business rule, the **Business Rule** zone appears where you can view the details of the respective business rule.

Related Topics

For more information on...	See...
Business Rule screen	Business Rule (Used for Searching) on page 3277
How to search a business rule	Searching for a Business Rule on page 3281

Business Rule Log

The **Business Rule Log** zone lists the complete trail of actions performed on the business rule. It contains the following columns:

Column Name	Column Description
Creation Date Time	Displays the date and time when the action was performed on the business rule.
Details	Displays the details of the action performed on the business rule.
User	Indicates the user who has performed the action on the business rule.

Related Topics

For more information on...	See...
How to view the log of a business rule	Viewing the Log of a Business Rule on page 3296

Searching for a Business Rule

Prerequisites

To search for a business rule, you should have:

- Business rule criteria defined in the application
- Business rule types associated with the business rule
- Parameters associated with the business rule types and their corresponding vales defined in the application
- Business rules defined in the application

Procedure

To search for a business rule:

1. Click the **Admin** link in the **Application** toolbar.
A list appears.
2. From the **Admin** menu, click **B** and then click **Business Rule**.
A sub-menu appears.
3. Click the **Search** option from the **Business Rule** sub-menu.
The **Business Rule** screen appears.
4. Enter the search criteria in the **Search Business Rule** zone.

Note: ORMB search engine supports wildcard search, where you can substitute the percentage (%) symbol as a stand in for any word or letter in a search criteria. You can use the ‘%’ wildcard character in all input fields except the date and ID fields. The ‘%’ wildcard character is suffixed automatically at the end of the partial search criteria. Therefore, you may or may not specify the wildcard character at the end of the partial search criteria. However, you have to prefix the wildcard character manually wherever required.

5. Click **Search**.

A list of business rules that meet the search criteria appears in the **Search Results** section.

Note: Pagination is used to display limited number of records in the **Search Results** section. You can use the navigation links, such as **Previous** and **Next** to navigate between pages.

Related Topics

For more information on...	See...
Business Rule screen	Business Rule (Used for Searching) on page 3277
Search Business Rule zone	Search Business Rule on page 3277

Defining a Binder Payment Business Rule

To define a binder payment business rule, you should have:

- Business rule type defined in the application
- Binder payment business rule category defined in the application
- Values defined for the **BUS_RULE_CAT_FLG** lookup field
- Status defined for the binder payment business rule in the application

Procedure

To define a binder payment business rule:

1. Click the **Admin** link in the **Application** toolbar.
A list appears.
2. From the **Admin** menu, select **B** and then click **Business Rule**.
A sub-menu appears.
3. Click the **Add** option from the **Business Rule** sub-menu.

The **Select Business Category** screen appears. It contains the following field:

Field Name	Field Description	Mandatory (Yes or No)
Business Rule Category	Used to indicate the business rule category using which you want to create a business rule. The valid values are: <ul style="list-style-type: none"> • Binder Payment Business Rule • Fully-Insured Pricing Business Rule • New Born Business Rule • Rate Guarantee Business Rule 	Yes

Note: Alternatively, you can access the **Business Rule Category** screen by clicking the **Add** button in the **Page Title** area of the **Business Rule** screen.

4. Select the **Binder Payment Business Rule** option from the **Business Rule Category** list.
5. Click **OK**.

The **Binder Payment Business Rule** screen appears. It contains the following fields:

Field Name	Field Description	Mandatory (Yes or No)
Criteria Description	Used to indicate the business criteria for the binder payment business rule.	Yes
	Note: The Search (🔍) icon appears corresponding to the Criteria Description field. On clicking the Search icon, the Business Rule Criteria Search window appears.	
Effective Date	Used to specify the date from when the binder payment business rule is effective.	Yes

Field Name	Field Description	Mandatory (Yes or No)
Status	Used to indicate the status of the binder payment business rule. The valid values are: <ul style="list-style-type: none"> Active Inactive <p>Note: It is a read-only field. By default, the Active option is selected.</p>	Not applicable
Binder Payment Applicability	Used to indicate that you want the system to monitor whether the binder payment is received or not before activating the individual membership.	No
Threshold Percentage	Used to specify the threshold percentage using which the threshold amount should be calculated. <p>Note: This field is enabled only when the Binder Payment Applicability check box is selected.</p>	No
Grace Days	Used to calculate the grace date for the individual membership. <p>Note: The grace days cannot be less than or equal to zero. This field is enabled only when the Binder Payment Applicability check box is selected.</p>	Yes (Conditional) Note: This field is required if the Binder Payment Applicability check box is selected.
Hold Billing	Used to indicate whether you want to hold the bill generation process for the individual membership until the binder payment is received. <p>Note: This field is enabled only when the Binder Payment Applicability check box is selected.</p>	No

- Enter the required details in the **Binder Payment Business Rule** screen.
- If you want to define more than one binder payment business rule, click the **Add (+)** icon and then repeat step 6.

Note: However, if you want to remove a binder payment business rule, click the **Delete** (🗑️) icon corresponding to the **Criteria Description** field.

- Click **Save**.

The binder payment business rule is defined.

Related Topics

For more information on...	See...
Business Rule screen	Business Rule (Used for Searching) on page 3277

Defining a Fully-Insured Pricing Business Rule

To define a fully-insured pricing business rule, you should have:

- Business rule type defined in the application
- Fully-Insured pricing business rule category defined in the application
- Values defined in the following lookup fields:
 - **BUS_RULE_CAT_FLG** lookup field
 - **DEP_ORDER_PRIORITY_FLG** lookup field
 - **AGE_CAL_DT_BASED_ON_FLG** lookup field
 - **AGE_RECAL_DT_BASED_ON_FLG** lookup field
 - **MEM_ROLE_DERV_DT_BASED_ON_FLG** lookup field
- Status defined for the fully-insured pricing business rule in the application

Procedure

To define a fully-insured pricing business rule:

1. Click the **Admin** link in the **Application** toolbar.
A list appears.
2. From the **Admin** menu, select **B** and then click **Business Rule**.
A sub-menu appears.
3. Click the **Add** option from the **Business Rule** sub-menu.

The **Select Business Category** screen appears. It contains the following field:

Field Name	Field Description	Mandatory (Yes or No)
Business Rule Category	Used to indicate the business rule category using which you want to create a business rule. The valid values are: <ul style="list-style-type: none"> • Binder Payment Business Rule • Fully-Insured Pricing Business Rule • New Born Business Rule • Rate Guarantee Business Rule 	Yes

Note: Alternatively, you can access the **Business Rule Category** screen by clicking the **Add** button in the **Page Title** area of the **Business Rule** screen.

4. Select the **Fully-Insured Pricing Business Rule** option from the **Business Rule Category** list.
5. Click **OK**.

The **Fully-Insured Pricing Business Rule** screen appears. It contains the following fields:

Field Name	Field Description	Mandatory (Yes or No)
Criteria Description	Used to indicate the business criteria for the fully-insured pricing business rule.	Yes
	Note: The Search (🔍) icon appears corresponding to the Criteria Description field. On clicking the Search icon, the Business Rule Criteria Search window appears.	
Effective Date	Used to specify the date from when the fully-insured pricing business rule is effective.	Yes
Status	Used to indicate the status of the fully-insured pricing business rule.	Not applicable
	Note: It is a read-only field. By default, the Active option is selected.	
Maximum Dependents	Used to specify the maximum number of children which are eligible for premium calculation.	No
	Note: The value for this field must either be zero (0) or a positive integer.	
Dependent Max Age Limit	Used to specify the maximum age limit for children eligible for premium calculation.	Yes (Conditional)
	Note: The value for this field must either be zero (0) or a positive integer.	
	Note: This field is required when you have specified zero (0) in the Maximum Dependents field while defining a fully-insured pricing business rule.	
Dependent Order Priority	Used to indicate the order priority of the dependent during premium calculation. The valid values are:	Yes (Conditional)
	<ul style="list-style-type: none"> • Eldest • Youngest 	
		Note: This field is required when you have specified zero (0) in the Maximum Dependents field while defining a fully-insured pricing business rule.

Field Name	Field Description	Mandatory (Yes or No)
Age Calculation Date	Used to indicate whether the member person's age should be calculated using the member person's enrollment date or policy's start or renewal date. The valid values are: <ul style="list-style-type: none"> Member Enrollment Date Member Enrollment Nearest Age Membership Renewal Date 	Yes
Age Recalculation Date	Used to indicate whether the member person's age should be recalculated using the member person's enrollment date or policy's start or renewal date. The valid values are: <ul style="list-style-type: none"> After Birthday Month Membership Renewal Date Nearest Birthday 	No
Young Adult Applicability	Used to indicate that the child or dependent enrolling in the membership becomes the young adult in the enrollment period.	No
Young Adult Max Age Limit	Used to specify the maximum age limit for young adults which are eligible for premium calculation. Note: This field is enabled only when the Young Adult Applicability check box is selected.	Yes (Conditional) Note: This field is required if you have selected the Young Adult Applicability check box.
Member Relationship Derivation Date	Used to indicate the member relationship for a member person. The valid values are: <ul style="list-style-type: none"> Member Date of Birth Member Enrollment Date 	Yes

- Enter the required details in the **Fully-Insured Pricing Business Rule** screen.
- If you want to define more than one fully-insured pricing business rule, click the **Add (+)** icon and then repeat step 6.

Note: However, if you want to remove a fully-insured pricing business rule, click the **Delete (🗑)** icon corresponding to the **Criteria Description** field.

- Click **Save**.

The fully-insured pricing business rule is defined.

Related Topics

For more information on...	See...
Business Rule screen	Business Rule (Used for Searching) on page 3277

Defining a New Born Business Rule

To define a new born business rule, you should have:

- Business rule type defined in the application
- New born business rule category defined in the application
- Values defined in the **BUS_RULE_CAT_FLG** lookup field
- Status defined for the new born business rule in the application

Procedure

To define a new born business rule:

1. Click the **Admin** link in the **Application** toolbar.
A list appears.
2. From the **Admin** menu, select **B** and then click **Business Rule**.
A sub-menu appears.
3. Click the **Add** option from the **Business Rule** sub-menu.

The **Select Business Category** screen appears. It contains the following field:

Field Name	Field Description	Mandatory (Yes or No)
Business Rule Category	Used to indicate the business rule category using which you want to create a business rule. The valid values are: <ul style="list-style-type: none"> • Binder Payment Business Rule • Fully-Insured Pricing Business Rule • New Born Business Rule • Rate Guarantee Business Rule 	Yes

Note: Alternatively, you can access the **Business Rule Category** screen by clicking the **Add** button in the **Page Title** area of the **Business Rule** screen.

4. Select the **New Born Business Rule** option from the **Business Rule Category** list.
5. Click **OK**.

The **New Born Business Rule** screen appears. It contains the following fields:

Field Name	Field Description	Mandatory (Yes or No)
Criteria Description	Used to indicate the business criteria for the new born business rule.	Yes
	Note: The Search (🔍) icon appears corresponding to the Criteria Description field. On clicking the Search icon, the Business Rule Criteria Search window appears.	
Effective Date	Used to specify the date from when the new born business rule is effective.	Yes

Field Name	Field Description	Mandatory (Yes or No)
Status	Used to indicate the status of the new born business rule.	Not applicable
	Note: It is a read-only field. By default, the Active option is selected.	
Gift Days Applicability	Used to indicate whether you want to offer gift days in case of a new born child.	No
New Born Gift Days	Used to specify the number of days you want to offer as gift days from the new born child's birth date.	Yes (Conditional)
	Note: By default, this field is disabled. It is enabled when you select the Gift Days Applicability check box. The value for this field must be a positive integer.	
		Note: This field is required if you select the Gift Days Applicability check box.

- Enter the required details in the **New Born Business Rule** screen.
- If you want to define more than one new born business rule, click the **Add (+)** icon and then repeat step 6.

Note: However, if you want to remove a new born business rule, click the **Delete (🗑)** icon corresponding to the **Criteria Description** field.

- Click **Save**.

The new born business rule is defined.

Related Topics

For more information on...	See...
Business Rule screen	Business Rule (Used for Searching) on page 3277

Defining a Rate Guarantee Business Rule

To define a rate guarantee business rule, you should have:

- Business rule type defined in the application
- Rate guarantee business rule category defined in the application
- Values defined in the **BUS_RULE_CAT_FLG** lookup field
- Status defined for the rate guarantee business rule in the application

Procedure

To define a rate guarantee business rule:

- Click the **Admin** link in the **Application** toolbar.
A list appears.
- From the **Admin** menu, select **B** and then click **Business Rule**.
A sub-menu appears.

- Click the **Add** option from the **Business Rule** sub-menu.

The **Select Business Category** screen appears. It contains the following field:

Field Name	Field Description	Mandatory (Yes or No)
Business Rule Category	Used to indicate the business rule category using which you want to create a business rule. The valid values are: <ul style="list-style-type: none"> Binder Payment Business Rule Fully-Insured Pricing Business Rule New Born Business Rule Rate Guarantee Business Rule 	Yes

Note: Alternatively, you can access the **Business Rule Category** screen by clicking the **Add** button in the **Page Title** area of the **Business Rule** screen.

- Select the **Rate Guarantee Business Rule** option from the **Business Rule Category** list.
- Click **OK**.

The **Rate Guarantee Business Rule** screen appears. It contains the following fields:

Field Name	Field Description	Mandatory (Yes or No)
Criteria Description	Used to indicate the business criteria for the rate guarantee business rule. Note: The Search (🔍) icon appears corresponding to the Criteria Description field. On clicking the Search icon, the Business Rule Criteria Search window appears.	Yes
Effective Date	Used to specify the date from when the rate guarantee business rule is effective.	Yes
Status	Used to indicate the status of the rate guarantee business rule. Note: It is a read-only field. By default, the Active option is selected.	Not applicable
Rate Guarantee Applicability	Used to indicate whether the rate guarantee is available for the individual membership.	No
Rate Guarantee Period	Used to specify the rate guarantee period for the individual membership. Note: By default, this field is disabled. It is enabled when you select the Rate Guarantee Applicability check box. The value for this field must be a positive integer.	Yes (Conditional) Note: This field is required if you select the Rate Guarantee Applicability check box.

6. Enter the required details in the **New Born Business Rule** screen.
7. If you want to define more than one rate guarantee business rule, click the **Add (+)** icon and then repeat step 6.

Note: However, if you want to remove a rate guarantee business rule, click the **Delete** (🗑️) icon corresponding to the **Criteria Description** field.

8. Click **Save**.

The rate guarantee business rule is defined.

Related Topics

For more information on...	See...
Business Rule screen	Business Rule (Used for Searching) on page 3277

Editing a Binder Payment Business Rule

To edit a binder payment business rule, you should have:

- Status defined for the binder payment business rule in the application

Procedure

To edit a binder payment business rule:

1. Search for the binder payment business rule in the **Business Rule** screen.
2. In the **Search Results** section, select the check box corresponding to the **Criteria Description** column and click the **Edit** button.

Note:

You can edit more than one binder payment business rules by selecting multiple check boxes.
You can edit the binder payment business rule when it is not yet used in the system.

The **Binder Payment Business Rule** screen appears. It contains the following fields:

Field Name	Field Description	Mandatory (Yes or No)
Criteria Description	Displays the business criteria for the binder payment business rule.	Not applicable
	Note: This is a read-only field.	
Effective Date	Used to specify the date from when the binder payment business rule is effective.	Yes
Status	Used to indicate the status of the binder payment business rule. The valid values are: <ul style="list-style-type: none"> • Active • Inactive 	Yes
Binder Payment Applicability	Used to indicate that you want the system to monitor whether the binder payment is received or not before activating the individual membership.	No

Field Name	Field Description	Mandatory (Yes or No)
Threshold Percentage	Used to specify the threshold percentage using which the threshold amount should be calculated.	No
	Note: This field is enabled only when the Binder Payment Applicability check box is selected.	
Grace Days	Used to calculate the grace date for the individual membership.	Yes (Conditional)
	Note: The grace days cannot be less than or equal to zero. This field is enabled only when the Binder Payment Applicability check box is selected.	
Hold Billing	Used to indicate whether you want to hold the bill generation process for the individual membership until the binder payment is received.	No
	Note: This field is enabled only when the Binder Payment Applicability check box is selected.	

3. Modify the required details in the **Binder Payment Business Rule** screen.
4. Click **Save**.

The changes made to the binder payment business rule are saved.

Related Topics

For more information on...	See...
Business Rule screen	Business Rule (Used for Searching) on page 3277
How to define a binder payment business rule	Defining a Binder Payment Business Rule on page 3282

Editing a Fully-Insured Pricing Business Rule

To edit a fully-insured pricing business rule, you should have:

- Status defined for the fully-insured pricing business rule in the application

Procedure

To edit a fully-insured pricing business rule:

1. Search for the fully-insured pricing business rule in the **Business Rule** screen.
2. In the **Search Results** section, select the check box corresponding to the **Criteria Description** column and click the **Edit** button.

Note:

You can edit more than one fully-insured pricing business rules by selecting multiple check boxes.

You can edit the fully-insured pricing business rule when it is not yet used in the system.

The **Fully-Insured Pricing Business Rule** screen appears. It contains the following fields:

Field Name	Field Description	Mandatory (Yes or No)
Criteria Description	Displays the business criteria for the fully-insured pricing business rule.	Not applicable
	Note: This is a read-only field.	
Effective Date	Used to specify the date from when the fully-insured pricing business rule is effective.	Yes
Status	Used to indicate the status of the fully-insured pricing business rule. The valid values are: <ul style="list-style-type: none"> Active Inactive 	Yes
Maximum Dependents	Used to specify the maximum number of children which are eligible for premium calculation.	No
	Note: The value for this field must either be zero (0) or a positive integer.	
Dependent Max Age Limit	Used to specify the maximum age limit for children eligible for premium calculation.	Yes (Conditional)
	Note: The value for this field must either be zero (0) or a positive integer.	
Dependent Order Priority	Used to indicate the order priority of the dependent during premium calculation. The valid values are: <ul style="list-style-type: none"> Eldest Youngest 	Yes (Conditional)
		Note: This field is required when you have specified zero (0) in the Maximum Dependents field while defining a fully-insured pricing business rule.
Age Calculation Date	Used to indicate whether the member person's age should be calculated using the member person's enrollment date or policy's start or renewal date. The valid values are: <ul style="list-style-type: none"> Member Enrollment Date Member Enrollment Nearest Age Membership Renewal Date 	Yes

Field Name	Field Description	Mandatory (Yes or No)
Age Recalculation Date	Used to indicate whether the member person's age should be recalculated using the member person's enrollment date or policy's start or renewal date. The valid values are: <ul style="list-style-type: none"> • After Birthday Month • Membership Renewal Date • Nearest Birthday 	No
Young Adult Applicability	Used to indicate that the child or dependent enrolling in the membership becomes the young adult in the enrollment period.	No
Young Adult Max Age Limit	Used to specify the maximum age limit for young adults which are eligible for premium calculation. Note: This field is enabled only when the Young Adult Applicability check box is selected.	Yes (Conditional) Note: This field is required if you have selected the Young Adult Applicability check box.
Member Relationship Derivation Date	Used to indicate the member relationship for a member person. The valid values are: <ul style="list-style-type: none"> • Member Date of Birth • Member Enrollment Date 	Yes

3. Modify the required details in the **Fully-Insured Pricing Business Rule** screen.
4. Click **Save**.

The changes made to the fully-insured pricing business rule are saved.

Related Topics

For more information on...	See...
Business Rule screen	Business Rule (Used for Searching) on page 3277
How to define a fully-insured pricing business rule	Defining a Fully-Insured Pricing Business Rule on page 3284

Editing a New Born Business Rule

To edit a new born business rule business rule, you should have:

- Status defined for the new born business rule in the application

Procedure

To edit a new born business rule:

1. Search for the new born business rule in the **Business Rule** screen.
2. In the **Search Results** section, select the check box corresponding to the **Criteria Description** column and click the **Edit** button.

Note:

You can also edit more than one new born business rule by selecting multiple check boxes and clicking the **Edit** button.

You can edit the new born business rule when it is not yet used in the system.

The **New Born Business Rule** screen appears. It contains the following fields:

Field Name	Field Description	Mandatory (Yes or No)
Criteria Description	Displays the business criteria for the new born business rule.	Not applicable
	Note: This is a read-only field.	
Effective Date	Used to specify the date from when the new born business rule is effective.	Yes
Status	Used to indicate the status of the new born business rule. The valid values are: <ul style="list-style-type: none"> Active Inactive 	Yes
Gift Days Applicability	Used to indicate whether you want to offer gift days in case of a new born child.	No
New Born Gift Days	Used to specify the number of days you want to offer as gift days from the new born child's birth date.	Yes (Conditional)
	Note: By default, this field is disabled. It is enabled when you select the Gift Days Applicability check box. The value for this field must be a positive integer.	
		Note: This field is required if you select the Gift Days Applicability check box.

3. Modify the required details in the **New Born Business Rule** screen.

4. Click **Save**.

The changes made to the new born business rules are saved.

Related Topics

For more information on...	See...
Business Rule screen	Business Rule (Used for Searching) on page 3277
How to define a new born business rule	Defining a New Born Business Rule on page 3287

Editing a Rate Guarantee Business Rule

To edit a rate guarantee business rule, you should have:

- Status defined for the rate guarantee business rule in the application

Procedure

To edit a rate guarantee business rule:

1. Search for the rate guarantee business rule in the **Business Rule** screen.
2. In the **Search Results** section, select the check box corresponding to the **Criteria Description** column and click the **Edit** button.

Note:

You can edit more than one rate guarantee business rules by selecting multiple check boxes.

You can edit the rate guarantee business rule when it is not yet used in the system.

The **Rate Guarantee Business Rule** screen appears. It contains the following fields:

Field Name	Field Description	Mandatory (Yes or No)
Criteria Description	Displays the business criteria for the rate guarantee business rule.	Not applicable
	Note: This is a read-only field.	
Effective Date	Used to specify the date from when the rate guarantee business rule is effective.	Yes
Status	Used to indicate the status of the rate guarantee business rule. The valid values are: <ul style="list-style-type: none"> • Active • Inactive 	Yes
Rate Guarantee Applicability	Used to indicate whether the rate guarantee is available for the individual membership.	No
Rate Guarantee Period	Used to specify the rate guarantee period for the individual membership.	Yes (Conditional)
	Note: By default, this field is disabled. It is enabled when you select the Rate Guarantee Applicability check box. The value for this field must be a positive integer.	
		Note: This field is required if you select the Rate Guarantee Applicability check box.

3. Modify the required details in the **Rate Guarantee Business Rule** screen.
4. Click **Save**.

The changes made to the rate guarantee business rule are saved.

Related Topics

For more information on...	See...
Business Rule screen	Business Rule (Used for Searching) on page 3277
How to define a rate guarantee business rule	Defining a Rate Guarantee Business Rule on page 3288

Deleting a Business Rule**Procedure**

To delete a business rule:

1. Search for the business rule in the **Business Rule** screen.
2. In the **Search Results** section, select the check box corresponding to the business rule which you want to delete. You can delete more than one business rule.
3. Click **Delete**.

A message appears confirming whether you want to delete the business rule.

Note: You can delete a business rule when it is not yet used in the system.

4. Click **OK**.

The business rule is deleted.

Related Topics

For more information on...	See...
Business Rule screen	Business Rule (Used for Searching) on page 3277
Search Business Rule zone	Search Business Rule on page 3277

Viewing the Log of a Business Rule

Procedure

To view the log of a business rule:

1. Search for the business rule in the **Business Rule** screen.
2. In the **Search Results** section, click the **Broadcast** (📡) icon corresponding to the business rule whose log details you want to view:

The **Business Rule Log** zone appears.

3. View the complete trail of actions performed on the business rule in the **Business Rule Log** zone.

Related Topics

For more information on...	See...
Business Rule screen	Business Rule (Used for Searching) on page 3277
Business Rule Log zone	Business Rule Log on page 3280

Chapter 41

Individual Health Insurance Billing

While calculating the premium for an individual membership using an age based pricing rule, the system derives the rate for each eligible member person. The system identifies members which are eligible for premium calculation using the fully-insured pricing and new born business rules.

On creating or editing an individual membership through a health care inbound message or membership repricing inbound web service, the system determines the fully-insured pricing and new born business rules which are applicable for the individual membership. The system enables you to define business rules of the following categories:

- Fully-Insured Pricing
- New Born

While determining the business rules which are applicable for an individual membership, the system executes the business rules of each category which are effective on the inbound processing date based on the priority of the business rule. If an individual membership meets the criteria of the business rule, the system stamps the respective business rule corresponding to the individual membership. In this way, the system derives two business rules – one fully-insured pricing business rule and another new born business rule.

While calculating the premium for an individual membership using a tier based pricing rule, the system derives the subscription tier using the fully-insured pricing and new born business rules.

Once the premium is calculated for an individual membership, the system creates a billable charge for the premium. If the account is defined for the individual membership using the characteristic types specified in the **Account Identifier Type Char Type** and **Account Identifier Value Char Type** option types of the **C1-ASOBLLNG** feature configuration, the system uses the account to bill the charge for the premium. However, if these characteristics are not defined for the individual membership, the system considers the account of the financially responsible member person to the charge for the premium.

Chapter 42

Entity Audit

Topics:

- [Audit Event Status Transition](#)
- [Prerequisites](#)
- [Entity Audit Process](#)
- [Algorithms Used in the Entity Audit Process](#)
- [Audit Event Type](#)
- [Audit Event \(Used for Searching\)](#)
- [Audit Event \(Used for Viewing\)](#)

Oracle Revenue Management and Billing provides a mechanism wherein auditors can track various actions, such as add, update, and delete for an entity. If the entity audit feature is enabled for a business object, the system creates audit events whenever you define, edit, or delete an entity (which is created using the respective business object). For example, if the entity audit feature is enabled for the **C1-Membership** business object, the system creates an audit event whenever you define, edit, or delete a membership in a policy plan or whenever you add or remove persons from a membership. For more information on how to enable the entity audit feature for a business object, see [Prerequisites](#) on page 3300.

The entity audit process is a two-step process, wherein the system creates the audit events and then processes them whenever the **Audit Event Processing (C1-AUDEV)** batch is executed. For more information about these processes, see the following sections:

- [Audit Event Creation](#) on page 3301
- [Audit Event Processing](#) on page 3302

During the entity audit process, each audit event goes through various statuses in its lifecycle. For more information about the audit event statuses, see [Audit Event Status Transition](#) on page 3300.

Audit Event Status Transition

The following figure graphically indicates how an audit event moves from one status to another in its lifecycle:

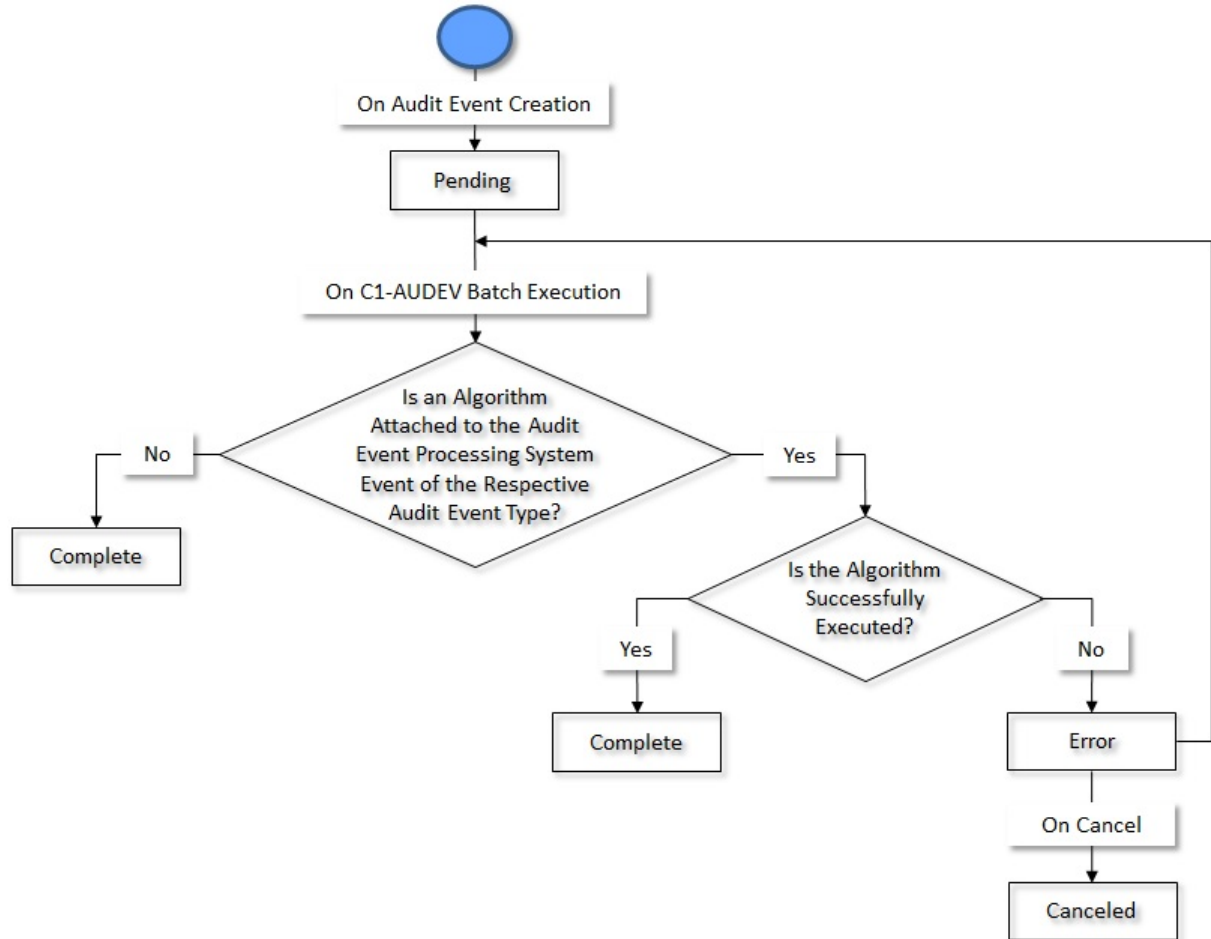

Prerequisites

To setup the entity audit feature for a business object, you need to do the following:

- Set the **Eligible for Audit Event** option type of the entity business object to **Y**.

Note: The **Eligible for Audit Event** option type is available for the entity business object when the **Valid BO Option Type** option type of the respective maintenance object is set to **C1AT**.

- Attach an algorithm created using the **C1-READEVNT** algorithm type to the **Audit** system event of the entity business object.

Note:

At present, this algorithm is designed to work with the following business objects:

- C1-POLICY
- C1-ASOPolicy
- C1-Membership
- C1-PolicyPlan
- C1_PERSON_BO
- C1-PricingRuleTierBased
- C1-PricingRuleAgeBased

If you want to use the audit algorithm for the business objects which are not listed above, you need to create a custom audit algorithm.

- Define an active audit event type for the entity business object in the system.
- Define the required algorithm types where the algorithm entity is set to **Audit Event Processing**.
- Create the required algorithms and attach them to the **Audit Event Processing** system event of the audit event type.

Note: The **C1-AUDEVMPR** algorithm type is shipped with the product. You must attach an algorithm created using the **C1-AUDEVMPR** algorithm type to the audit event types which are defined for the **C1-PricingRuleTierBased** and **C1-PricingRuleAgeBased** business objects.

- Define the values for the **AUDIT_USAGE_FLG** lookup field
- Define the required characteristic types where the characteristic entity is set to **Audit Event Type**.

Entity Audit Process

The entity audit process consists of the following two sub-processes:

- [Audit Event Creation](#) on page 3301
- [Audit Event Processing](#) on page 3302

Audit Event Creation

If you add, edit, or delete an entity which is created using a business object for which the entity audit feature is enabled, the system checks whether an active audit event type exists for the entity business object. If so, it considers the active audit event type and creates the audit event using the respective audit event type. The system creates the audit event while:

- Defining an entity when the **Add Action** option is selected in the audit event type
- Editing an entity when the **Update All** option is selected in the audit event type or when the updated element is listed in the **Audit Elements for Entity Update** section
- Deleting an entity when the **Delete Action** option is selected in the audit event type

For more information about the audit event type, see [Audit Event Type](#) on page 3303.

The audit event is created in the **Pending** status. Note that the system creates one audit event for the entity irrespective of the number of changes made during the entity update. The entity type and entity ID for which an audit event is created are added corresponding to the audit event in the **C1_AUDIT_EVENT** table. For example, if the audit event is created

while adding or updating a pricing rule, then the entity type is set to **Pricing Rule** and entity ID is set to the pricing rule ID. In addition, an effective date is stamped corresponding to the audit event in the **C1_AUDIT_EVENT** table. Note that if the entity has a start date, then the effective date is set to the entity's start date. But, if the entity does not have a start date, then the effective date is set to the system date.

At a time, you can have only two audit events for the entity in the **Pending** status — one audit event which is created during the **Add** action and another audit event which is created during the **Update** action.

Note: Before creating an audit event, the system checks whether an audit event for the entity ID with the same effective date already exists in the **Pending** or **Error** status for the respective action. If so, the system does not create a new audit event for the entity. Instead, the system adds a new log entry in the existing audit event.

Audit Event Processing

On executing the **Audit Event Processing (C1-AUDEV)** batch, the system checks whether there are any audit events in the **Pending** status. If there is an audit event in the **Pending** status, the system checks whether an algorithm is attached to the **Audit Event Processing** system event of the respective audit event type. If an algorithm is not attached to the **Audit Event Processing** system event of the respective audit event type, the status of the audit event is set to **Complete**.

However, if an algorithm is attached to the **Audit Event Processing** system event of the respective audit event type, the system executes the algorithm and accordingly changes the status of the audit event to **Complete**. For example, while processing the audit events of the **C1-PricingRuleTierBased** and **C1-PricingRuleAgeBased** business objects, the system checks whether an algorithm is attached to the **Audit Event Processing** system event of the respective audit event type. If the **C1-AUDEVMPR** algorithm is attached to the audit event type, the system identifies the policy plan where the pricing rule is defined. Once the policy plan is identified, it extracts a list of membership defined on the policy plan and the pricing rule type using which the pricing rule is created. Then, the system creates an entry for each membership, pricing rule type, and effective date combination in the **CI_REPRC_ENTITY_DTL** table. The status of these entries is set to **P**. Finally, the status of the audit event is set to **Complete**.

If any error occurs, the status of the audit event is set to **Error**. The system enables you to either reprocess or cancel the audit events which are in the **Error** status. On canceling an audit event, the status of the audit event is changed to **Canceled**.

For more information about the **Audit Event Processing (C1-AUDEV)** batch and its parameters, see *Oracle Revenue Management and Billing Batch Guide*.

Algorithms Used in the Entity Audit Process

The following table lists the algorithms which are designed to implement the entity audit process:

Algorithm	Algorithm Type	Attached To	System Event	Algorithm Description
C1- REAUDEVNT	C1- REAUDEVNT	Entity Business Object	Audit	Refer to C1-REAUDEVNT on page 3302.
C1- AUDEVMPR	C1- AUDEVMPR	Audit Event Type of the C1-PricingRuleAgeBased and C1-PricingRuleTierBased business objects	Audit Event Processing	Refer to C1-AUDEVMPR on page 3303.

C1-REAUDEVNT

If this algorithm is attached to the **Audit** system event of a business object, it is invoked whenever you define, edit, or delete the respective entity. It checks whether an active audit event type exists for the entity business object. If so, it considers the active audit event type and creates the audit event using the respective audit event type. The system creates the audit event while:

- Defining an entity when the **Add Action** option is selected in the audit event type
- Editing an entity when the **Update All** option is selected in the audit event type or when the updated element is listed in the **Audit Elements for Entity Update** section
- Deleting an entity when the **Delete Action** option is selected in the audit event type

The entity type and entity ID for which an audit event is created are added corresponding to the audit event in the **C1_AUDIT_EVENT** table. In addition, the effective date is stamped corresponding to the audit event in the **C1_AUDIT_EVENT** table. Note that if the entity has a start date, then the effective date is set to the entity's start date. But, if the entity does not have a start date, then the effective date is set to the system date.

Note: Before creating an audit event, the system checks whether an audit event for the entity ID with the same effective date already exists in the **Pending** or **Error** status for the respective action. If so, the system does not create a new audit event for the entity. Instead, the system adds a new log entry in the existing audit event.

At present, this algorithm is designed to work with the following business objects:

- C1-POLICY
- C1-ASOPolicy
- C1-Membership
- C1-PolicyPlan
- C1_PERSON_BO
- C1-PricingRuleTierBased
- C1-PricingRuleAgeBased

If you want to use the audit algorithm for the business objects which are not listed above, you need to create a custom audit algorithm.

It contains the following parameters:

- **Audit Event Business Object** – Used to specify the business object using which you want to create the audit event.
- **Audit Event Pending Status** – Used to specify the status in which you want to create the audit event. This parameter is also used for determining whether an audit event for the entity ID already exists in the system.
- **Audit Event Error Status** – Used to specify the status in which an audit event is transitioned when an error occurs while processing the audit event. This parameter is used for determining whether an audit event for the entity ID already exists in the system.

All the above parameters are mandatory.

C1-AUDEVMPR

You must attach this algorithm to the **Audit Event Processing** system event while creating an audit event type for the **C1-PricingRuleAgeBased** and **C1-PricingRuleTierBased** business objects.

This algorithm is invoked when the **Audit Event Processing (C1-AUDEV)** batch is executed. If this algorithm is attached to the **Audit Event Processing** system event of the respective audit event type, the system identifies the policy plan where the pricing rule is defined. Once the policy plan is identified, it extracts a list of membership defined on the policy plan and the pricing rule type using which the pricing rule is created. Then, the system creates an entry for each membership, pricing rule type, and effective date combination in the **CI_REPRC_ENTITY_DTL** table. The status of these entries is set to **P** in the **CI_REPRC_ENTITY_DTL** table.

Audit Event Type

Oracle Revenue Management and Billing enables you to define an audit event type for an entity business object. However, at a time, only one audit event type of the entity business object can be in the **Active** status. The system

creates an audit event using the active audit event type whenever you define, edit, or delete the respective entity. The audit event type helps the system to determine:

- **Entity Business Object** – The business object for which you want to define the audit event type.
- **Audit Usage** – The usage indicates the purpose of auditing an entity which is created using the entity business object. For example, membership premium charges might change due to change in pricing and therefore you may want to audit the pricing rules for premium calculation.
- **Audit Actions** – The various options, such as **Add Action**, **Delete Action**, and **Update All** are available while defining an audit event type. The system creates an audit event while defining, editing or deleting an entity depending on whether the respective option is selected in the audit event type. For example, if you create the active audit event types for the following entity business objects where the below listed options are selected:

Audit Event Type	Entity Business Object	Add Action	Update All	Delete Action
AETY1	C1-POLICY	Y	N	N
AETY2	C1-ASOPolicy	Y	Y	Y

Then, the system will create an audit event using the **AETY1** audit event type when you define a fully-insured group policy. But, the system will not create an audit event when you edit or delete a fully-insured group policy. However, the system will create an audit event using the **AETY2** audit event type when you define, edit, or delete a self-funded policy.

- **Audit Elements During Update** – Alternatively, you can list the elements of the entity business object which should be monitored for the auditing purpose while editing an entity in the audit event type. You can list the elements of the entity business object when the **Update All** option is not selected. The system enables you to monitor a set of the business object statuses, characteristic types, and fields and accordingly creates an audit event while editing an entity. For example, if you create the audit event types for the following entity business objects:

Audit Event Type	Entity Business Object	Update All	Audit Elements During Update
AETY3	C1_PERSON_BO	Y	Not applicable
AETY4	C1-PricingRuleTierBased	N	Pricing Start Date, Rate Option, Base Fee for a Price Component
AETY5	C1-PricingRuleAgeBased	N	Rate Option, Base Fee for a Price Component

Then, the system will create an audit event using the **AETY3** audit event type when you edit any details of a person. But, the system will create an audit event using the **AETY4** audit event type when the following fields in a tier based pricing rule are edited:

- Pricing Start Date
- Rate Option
- Base Fee for a Price Component

Similarly, the system will create an audit event using the **AETY5** audit event type when the following fields in an age based pricing rule are edited:



- Rate Option
- Base Fee for a Price Component

The **Audit Event Type** screen allows you to define, edit, copy, and delete an audit event type. It contains the following zones:

- [Audit Event Type List](#) on page 3305
- [Audit Event Type](#) on page 3306

Audit Event Type List

The **Audit Event Type List** zone lists the audit event types that are already defined in the system. It contains the following columns:

Column Name	Column Description
Audit Event Type	Displays the audit event type.
Description	Displays the description of the audit event type.
Entity Business Object	Indicates the business object for which the audit event type is created. In addition, this column has a context menu which helps in navigating to other screens in the application. Note: It has a link. On clicking the link, the Business Object screen appears where you can view the details of the respective business object.
Status	Indicates the status of the audit event type. The valid values are: <ul style="list-style-type: none"> Active Inactive
Audit Usage	Indicates the purpose of auditing an entity which is created using the entity business object. The valid values are: <ul style="list-style-type: none"> Disaggregation/Reseeding - Used when you want to audit an entity for which the system should automatically create disaggregation or reseeding request. Premium Calculation - Used when you want to audit an entity which has an impact on membership premium calculation.
Edit	On clicking the Edit () icon, the Audit Event Type screen appears where you can edit the details of the audit event type. Note: You can edit an audit event type when an audit event is not yet created using the audit event type. However, if an audit event is created using the audit event type, you can only do the following: <ul style="list-style-type: none"> Change the status from Active to Inactive and vice-versa Attach algorithms (if required) to the audit event type Define, edit, or remove characteristics of the audit event type
Duplicate	On clicking the Duplicate () icon, the Audit Event Type screen appears where you can define a new audit event type using an existing audit event type.
Delete	On clicking the Delete () icon, you can delete the audit event type. Note: You can delete an audit event type when an audit event is not yet created using the audit event type.

Note: Pagination is used to display limited number of records in this zone. You can use the navigation links, such as **Previous** and **Next** to navigate between pages.

You can filter the list using various search criteria (such as, **Status** and **Entity Business Object**) available in the **Filter** area. By default, the **Filter** area is hidden. You can view the **Filter** area by clicking the **Filters** (🔍) icon in the upper right corner of this zone.

On clicking the **Broadcast** (📡) icon corresponding to an audit event type, the **Audit Event Type** zone appears with the details of the respective audit event type.

Related Topics

For more information on...	See...
How to edit an audit event type	Editing an Audit Event Type on page 3316
How to copy an audit event type	Copying an Audit Event Type on page 3318
How to delete an audit event type	Deleting an Audit Event Type on page 3321
How to view the details of an audit event type	Viewing the Audit Event Type Details on page 3321

Audit Event Type

The **Audit Event Type** zone displays the details of the audit event type. It contains the following sections:

- **Main** - Displays basic information about the audit event type. It contains the following fields:

Field Name	Field Description
Audit Event Type	Displays the audit event type.
Description	Displays the description of the audit event type.
Detailed Description	Displays additional information about the audit event type.
Status	Indicates the status of the audit event type. The valid values are: <ul style="list-style-type: none"> • Active • Inactive
Entity Business Object	Indicates the business object for which the audit event type is defined. In addition, this field has a context menu which helps in navigating to other screens in the application. <div style="border: 1px solid black; padding: 5px; margin-top: 5px;"> <p>Note: It has a link. On clicking the link, the Business Object screen appears where you can view the details of the respective business object.</p> </div>
Audit Usage	Indicates the purpose of auditing an entity which is created using the entity business object. The valid values are: <ul style="list-style-type: none"> • Premium Calculation - Used when you want to audit an entity which has an impact on membership premium calculation. • Disaggregation/Reseeding - Used when you want to audit an entity for which the system should automatically create disaggregation or reseeding request.
Update All	Indicates whether an audit event must be created whenever any field, characteristic, or status of the entity is updated.
Add Action	Indicates whether an audit event must be created whenever an entity is added.
Delete Action	Indicate whether an audit event must be created whenever an entity is deleted.

- **Algorithms** - Lists the algorithms associated with the audit event type. It contains the following columns:

Column Name	Column Description
System Event	Indicates the system event when the algorithm must be triggered. The valid value is: <ul style="list-style-type: none"> • Audit Event Processing
Sequence	Indicates the order in which the algorithms with the same system event must be triggered.
Algorithm	Indicates the algorithm attached to the system event. Note: It has a link. On clicking the link, the Algorithm screen appears where you can view the details of the respective algorithm.

- **Audit Elements for Entity Update** - Lists the elements which must be monitored for auditing while updating the entity. It contains the following columns:

Column Name	Column Description						
Element Type	Indicates the type of element. The valid values are: <ul style="list-style-type: none"> • Business Object Status • Characteristic • Field 						
Element Name	Displays the element which must be monitored for auditing. Note: If the element is a part of a group or list, the system displays the element name along with the element group and/or list. For example, if you select the policyPerRole element of the C1-ASOPolicy business object, the system displays the <code>policyPersons/policyPerRole</code> in the Element Name field. Here, the policyPersons is the element list.						
Element Value	The following table lists the element value depending on the element type: <table border="1" data-bbox="610 1299 1463 1518"> <thead> <tr> <th>Element Type</th> <th>Element Value</th> </tr> </thead> <tbody> <tr> <td>Business Object Status</td> <td>Indicates the status of the entity business object which must be monitored for auditing.</td> </tr> <tr> <td>Characteristic</td> <td>Indicates the characteristic type which must be monitored for auditing.</td> </tr> </tbody> </table> Note: The data does not appear in this column when the element type is set to Field .	Element Type	Element Value	Business Object Status	Indicates the status of the entity business object which must be monitored for auditing.	Characteristic	Indicates the characteristic type which must be monitored for auditing.
Element Type	Element Value						
Business Object Status	Indicates the status of the entity business object which must be monitored for auditing.						
Characteristic	Indicates the characteristic type which must be monitored for auditing.						

- **Characteristics** - Lists the characteristics which are defined for the audit event type. It contains the following columns:

Column Name	Column Description
Characteristic Type	Indicates the characteristic type.
Characteristic Value	Displays the value of the characteristic type.

- **Record Actions** - This section contains the following buttons:

Button Name	Button Description
Edit	Used to edit the details of the audit event type. Note: You can edit an audit event type when an audit event is not yet created using the audit event type. However, if an audit event is created using the audit event type, you can only do the following: <ul style="list-style-type: none"> • Change the status from Active to Inactive and vice-versa • Attach algorithms (if required) to the audit event type • Define, edit, or remove characteristics of the audit event type
Delete	Used to delete the audit event type. Note: You can delete an audit event type when an audit event is not yet created using the audit event type.
Duplicate	Used to create a new audit event type using an existing audit event type.

- **Record Information** - This section contains the following field:

Field Name	Field Description
Business Object	Indicates the business object using which the audit event type is created. In addition, a context menu appears corresponding to this field which helps in navigating to other screens in the application. Note: It has a link. On clicking the link, the Business Object screen appears where you can view the details of the respective business object.

By default, the **Audit Event Type** zone does not appear in the **Audit Event Type** screen. It appears when you click the **Broadcast** () icon corresponding to an audit event type in the **Audit Event Type List** zone.

Related Topics

For more information on...	See...
How to edit an audit event type	Editing an Audit Event Type on page 3316
How to copy an audit event type	Copying an Audit Event Type on page 3318
How to delete an audit event type	Deleting an Audit Event Type on page 3321
How to view the details of an audit event type	Viewing the Audit Event Type Details on page 3321

Defining an Audit Event Type

Prerequisites

To define an audit event type, you should have:

- Entity business objects defined in the application
- The **Eligible for Audit Event** option type of the entity business object (for which you want to define an audit event type) set to **Y**

Note: The **Eligible for Audit Event** option type is available for the entity business object when the **Valid BO Option Type** option type of the respective maintenance object is set to **CIAT**.

- Values defined for the **AUDIT_USAGE_FLG** lookup field

Procedure

To define an audit event type:

1. Click the **Admin** link in the **Application** toolbar.
A list appears.
2. From the **Admin** menu, select **A** and then click **Audit Event Type**.
A sub-menu appears.
3. Click the **Add** option from the **Audit Event Type** sub-menu.

The **Audit Event Type** screen appears. It contains the following sections:

- **Main** - Used to specify basic information about the audit event type.
- **Algorithms** - Used to associate algorithms with the audit event type.
- **Audit Elements for Entity Update** - Used to list the elements from the entity business object which you want to monitor for auditing while updating the entity.

Note: The **Audit Elements for Entity Update** section is enabled only when the **Update All** option is not selected in the **Main** section.

- **Characteristics** - Used to define the characteristics for the audit event type.

The **Main** section contains the following fields:

Field Name	Field Description	Mandatory (Yes or No)
Audit Event Type	Used to specify the audit event type.	Yes
	Note: You cannot specify any special characters except hyphen and underscore in the audit event type.	
Business Object	Indicates the business object using which you are defining the audit event type.	Not applicable
Description	Used to specify the description for the audit event type.	Yes
Detailed Description	Used to specify additional information about the audit event type.	No
Status	Used to indicate the status of the audit event type. The valid values are: <ul style="list-style-type: none"> • Active • Inactive 	Yes
	Note: You can create only one audit event type in the Active status for an entity business object.	

Field Name	Field Description	Mandatory (Yes or No)
Entity Business Object	Used to indicate the business object for which you want to define the audit event type.	Yes
	Note: The list includes only those business objects where the Eligible for Audit Event option type is set to Y .	
Audit Usage	Used to indicate the purpose of auditing an entity which is created using the entity business object. The valid values are: <ul style="list-style-type: none"> • Disaggregation/Reseeding - Used when you want to audit an entity for which the system should automatically create disaggregation or reseeding request. • Premium Calculation - Used when you want to audit an entity which has an impact on membership premium calculation. 	Yes
Update All	Used to indicate whether you want to create an audit event whenever any field, characteristic, or status of the entity is updated.	No
Add Action	Used to indicate whether you want to create an audit event whenever the entity is added.	Yes (Conditional)
		Note: This field is required when you want to create an audit event while adding the entity.
Delete Action	Used to indicate whether you want to create an audit event whenever the entity is deleted.	Yes (Conditional)
		Note: This field is required when you want to create an audit event while deleting the entity.

Tip: Alternatively, you can access this screen by clicking the **Add** button in the **Page Title** area of the **Audit Event Type** screen.

4. Enter the required details in the **Main** section.
5. Associate the required algorithms with the audit event type.
6. Add elements (such as, field, characteristic, or status) which you want to monitor for auditing while updating the entity.

Note: You can list the elements for auditing when the **Update All** option is not selected in the **Main** section.

7. Define characteristics for the audit event type, if required.
8. Click **Save**.

The audit event type is defined.

Related Topics

For more information on...	See...
Audit Event Type screen	Audit Event Type on page 3303
How to associate an algorithm with an audit event type	Associating an Algorithm with an Audit Event Type on page 3311
How to add an element for auditing in an audit event type	Adding an Element for Auditing in an Audit Event Type on page 3312
How to define a characteristic for an audit event type	Defining a Characteristic for an Audit Event Type on page 3315

Associating an Algorithm with an Audit Event Type

Prerequisites

To associate an algorithm with an audit event type, you should have:

- Algorithms defined in the application (which are created using an algorithm type where the algorithm entity is set to **Audit Event Processing**)

Note: The **C1-AUDEVMPR** algorithm type is shipped with the product. You must attach an algorithm created using the **C1-AUDEVMPR** algorithm type to the audit event types which are defined for the **C1-PricingRuleTierBased** and **C1-PricingRuleAgeBased** business objects.

Procedure

To associate an algorithm with an audit event type:

- Ensure that the **Algorithms** section is expanded when you are defining, editing, or copying an audit event type.

The **Algorithms** section contains the following fields in a grid:

Field Name	Field Description	Mandatory (Yes or No)
System Event	Used to indicate the system event when you want to trigger the algorithm. The valid value is: <ul style="list-style-type: none"> Audit Event Processing - Used when you want to trigger the attached algorithm while executing the Audit Event Process Monitor (C1-AUDEV) batch. 	Yes (Conditional) <p>Note: This field is required when you are associating an algorithm with the audit event type.</p>
Sequence	Used to indicate the order in which the algorithms with the same system event should be triggered.	Yes (Conditional) <p>Note: This field is required when you are associating an algorithm with the audit event type.</p>

Field Name	Field Description	Mandatory (Yes or No)
Algorithm	Used to indicate the algorithm that you want to attach to the system event.	Yes (Conditional)
	<p>Note:</p> <p>Once you select the system event, the Search (🔍) icon appears corresponding to the Algorithm field. On clicking the Search icon, the Algorithm Search window appears.</p> <p>On specifying the algorithm, the description of the algorithm appears corresponding to the Algorithm field.</p>	<p>Note: This field is required when you are associating an algorithm with the audit event type.</p>

2. Enter the required details in the **Algorithms** section.
3. If you want to associate more than one algorithm with the audit event type, click the **Add** (+) icon, and then repeat step 2.

Note: However, if you want to remove an algorithm from the audit event type, click the **Delete** (🗑️) icon corresponding to the algorithm.

Related Topics

For more information on...	See...
How to define an audit event type	Defining an Audit Event Type on page 3308
How to edit an audit event type	Editing an Audit Event Type on page 3316
How to copy an audit event type	Copying an Audit Event Type on page 3318

Adding an Element for Auditing in an Audit Event Type

Prerequisites

To add an element for auditing in an audit event type, you should have:

- Required elements defined in the entity business object schema
- Required statuses defined in the lifecycle of the entity business object
- Required characteristic types defined in the application (where the characteristic entity is set to the respective entity)

Procedure

To add an element for auditing in an audit event type:

1. Ensure that the **Audit Elements for Entity Update** section is expanded when you are defining, editing, or copying an audit event type.

The **Audit Elements for Entity Update** section contains the following fields in a grid:

Field Name	Field Description	Mandatory (Yes or No)								
Element Type	Used to indicate the type of element. The valid values are: <ul style="list-style-type: none"> • Business Object Status • Characteristic • Field 	Yes (Conditional) Note: This field is required when you want to create an audit event whenever the specified element is updated.								
Element Name	Used to specify the element which you want to monitor while updating the entity. The following table lists the elements which you must select for the respective element type: <table border="1" data-bbox="542 611 1180 1482" style="width: 100%; border-collapse: collapse;"> <thead> <tr> <th data-bbox="542 611 776 663">Element Type</th> <th data-bbox="776 611 1180 663">Element Name</th> </tr> </thead> <tbody> <tr> <td data-bbox="542 663 776 747">Business Object Status</td> <td data-bbox="776 663 1180 747">boStatus</td> </tr> <tr> <td data-bbox="542 747 776 831">Characteristic</td> <td data-bbox="776 747 1180 831">characteristics/characteristicsList/characteristicType</td> </tr> <tr> <td data-bbox="542 831 776 1482">Field</td> <td data-bbox="776 831 1180 1482"> Any field from the entity business object schema Note: Here, you must not specify a element whose type is set to group or list. If the element is a part of a group or list, the system displays the element name along with the element group and/or list. For example, if you select the policyPerRole element of the C1-ASOPolicy business object, the system displays the <code>policyPersons/policyPerRole</code> in the Element Name field. Here, the policyPersons is the element list. </td> </tr> </tbody> </table>	Element Type	Element Name	Business Object Status	boStatus	Characteristic	characteristics/characteristicsList/characteristicType	Field	Any field from the entity business object schema Note: Here, you must not specify a element whose type is set to group or list . If the element is a part of a group or list, the system displays the element name along with the element group and/or list. For example, if you select the policyPerRole element of the C1-ASOPolicy business object, the system displays the <code>policyPersons/policyPerRole</code> in the Element Name field. Here, the policyPersons is the element list.	Yes (Conditional) Note: This field is required when you want to create an audit event whenever the specified element is updated.
Element Type	Element Name									
Business Object Status	boStatus									
Characteristic	characteristics/characteristicsList/characteristicType									
Field	Any field from the entity business object schema Note: Here, you must not specify a element whose type is set to group or list . If the element is a part of a group or list, the system displays the element name along with the element group and/or list. For example, if you select the policyPerRole element of the C1-ASOPolicy business object, the system displays the <code>policyPersons/policyPerRole</code> in the Element Name field. Here, the policyPersons is the element list.									
	Note: The Search (🔍) icon appears corresponding to the Element Name field. On clicking the Search icon, the Schema window appears. The Schema window does not appear when the entity business object is not specified in the Main section.									

Field Name	Field Description	Mandatory (Yes or No)						
Element Value	Used to specify the element value depending on the element type. The following table lists the element value that you must specify depending on the element type:	Yes (Conditional)						
	<table border="1"> <thead> <tr> <th>Element Type</th> <th>Element Value</th> </tr> </thead> <tbody> <tr> <td>Business Object Status</td> <td>Used to indicate the status of the entity business object which you want to monitor for auditing. The system then creates an audit event whenever the entity is transitioned to the specified status.</td> </tr> <tr> <td>Characteristic</td> <td>Used to indicate the characteristic type which you want to monitor for auditing. Here, you must specify a characteristic type where the characteristic entity is set to the respective entity. The system then creates an audit event whenever the specified characteristic is defined, edited, or removed from the entity.</td> </tr> </tbody> </table>	Element Type	Element Value	Business Object Status	Used to indicate the status of the entity business object which you want to monitor for auditing. The system then creates an audit event whenever the entity is transitioned to the specified status.	Characteristic	Used to indicate the characteristic type which you want to monitor for auditing. Here, you must specify a characteristic type where the characteristic entity is set to the respective entity. The system then creates an audit event whenever the specified characteristic is defined, edited, or removed from the entity.	Note: This field is required when you want to create an audit event whenever the specified element is updated.
	Element Type	Element Value						
	Business Object Status	Used to indicate the status of the entity business object which you want to monitor for auditing. The system then creates an audit event whenever the entity is transitioned to the specified status.						
Characteristic	Used to indicate the characteristic type which you want to monitor for auditing. Here, you must specify a characteristic type where the characteristic entity is set to the respective entity. The system then creates an audit event whenever the specified characteristic is defined, edited, or removed from the entity.							
Note: The Search  icon appears corresponding to the Element Value field. On clicking the Search icon, the Characteristic Type Search window appears.								
Note: This field does not appear when the Field option is selected from the Element Type list.								

Note: The **Audit Elements for Entity Update** section is enabled when the **Update All** option is not selected in the **Main** section.

- Enter the required details in the **Audit Elements for Entity Update** section.
- If you want to add more than one element for auditing in the audit event type, click the **Add** (+) icon and then repeat step 2.

Note: However, if you want to remove an element from the audit event type, click the **Delete** (🗑️) icon corresponding to the element.

Related Topics

For more information on...	See...
How to define an audit event type	Defining an Audit Event Type on page 3308

For more information on...	See...
How to edit an audit event type	Editing an Audit Event Type on page 3316
How to copy an audit event type	Copying an Audit Event Type on page 3318

Defining a Characteristic for an Audit Event Type

Prerequisites

To define a characteristic for an audit event type, you should have:

- Characteristic types defined in the application (where the characteristic entity is set to **Audit Event Type**)

Procedure

To define a characteristic for an audit event type:

1. Ensure that the **Characteristics** section is expanded when you are defining, editing, or copying an audit event type.

The **Characteristics** section contains the following fields in a grid:

Field Name	Field Description	Mandatory (Yes or No)
Characteristic Type	Used to indicate the characteristic type.	Yes (Conditional)
	Note: The list includes only those characteristic types where the characteristic entity is set to Audit Event Type .	Note: This field is required when you are defining a characteristic for the audit event type.
Characteristic Value	Used to specify the value for the characteristic type.	Yes (Conditional)
	Note: If you select a predefined characteristic type, the Search (🔍) icon appears corresponding to the Characteristic Value field. On clicking the Search icon, the Predefined Characteristic Search window appears where you can search for a predefined characteristic value. On specifying the value for a predefined characteristic type, the description of the characteristic value appears corresponding to the Characteristic Value field.	Note: This field is required when you are defining a characteristic for the audit event type.

2. Enter the required details in the **Characteristics** section.
3. If you want to define more than one characteristic for the audit event type, click the **Add** (+) icon, and then repeat step 2.

Note: However, if you want to remove a characteristic from the audit event type, click the **Delete** (🗑️) icon corresponding to the characteristic.

Related Topics

For more information on...	See...
How to define an audit event type	Defining an Audit Event Type on page 3308
How to edit an audit event type	Editing an Audit Event Type on page 3316
How to copy an audit event type	Copying an Audit Event Type on page 3318

Editing an Audit Event Type

You can edit an audit event type when an audit event is not yet created using the audit event type. However, if an audit event is created using the audit event type, you can only do the following:

- Change the status from **Active** to **Inactive** and vice-versa
- Attach algorithms (if required) to the audit event type
- Define, edit, or remove characteristics of the audit event type

Prerequisites

To edit an audit event type, you should have:

- Values defined for the **AUDIT_USAGE_FLG** lookup field

Procedure

To edit an audit event type:

1. Click the **Admin** link in the **Application** toolbar.
A list appears.
2. From the **Admin** menu, select **A** and then click **Audit Event Type**.
A sub-menu appears.
3. Click the **Search** option from the **Audit Event Type** sub-menu.
The **Audit Event Type** screen appears.
4. In the **Audit Event Type List** zone, click the **Edit** (✎) icon in the **Edit** column corresponding to the audit event type whose details you want to edit.

The **Audit Event Type** screen appears. It contains the following sections:

- **Main** - Used to specify basic information about the audit event type.
- **Algorithms** - Used to associate algorithms with the audit event type.
- **Audit Elements for Entity Update** - Used to list the elements from the entity business object which you want to monitor for auditing while updating the entity.

Note: The **Audit Elements for Entity Update** section is enabled only when the **Update All** option is not selected in the **Main** section.

- **Characteristics** - Used to define the characteristics for the audit event type.

The **Main** section contains the following fields:

Field Name	Field Description	Mandatory (Yes or No)
Audit Event Type	Displays the audit event type.	Not applicable
Business Object	Indicates the business object which is used while defining the audit event type.	Not applicable

Field Name	Field Description	Mandatory (Yes or No)
Description	Used to specify the description for the audit event type.	Yes
Detailed Description	Used to specify additional information about the audit event type.	No
Status	Used to indicate the status of the audit event type. The valid values are: <ul style="list-style-type: none"> Active Inactive <p>Note: You can create only one audit event type in the Active status for an entity business object.</p>	Yes
Entity Business Object	Indicates the business object for which the audit event type is defined.	Not applicable
Audit Usage	Used to indicate the purpose of auditing an entity which is created using the entity business object. The valid values are: <ul style="list-style-type: none"> Premium Calculation - Used when you want to audit an entity which has an impact on membership premium calculation. Disaggregation/Reseeding - Used when you want to audit an entity for which the system should automatically create disaggregation or reseeding request. 	Yes
Update All	Used to indicate whether you want to create an audit event whenever any field, characteristic, or status of the entity is updated.	No
Add Action	Used to indicate whether you want to create an audit event whenever the entity is added.	Yes (Conditional) <p>Note: This field is required when you want to create an audit event while adding the entity.</p>
Delete Action	Used to indicate whether you want to create an audit event whenever the entity is deleted.	Yes (Conditional) <p>Note: This field is required when you want to create an audit event while deleting the entity.</p>

Tip: Alternatively, you can access this screen by clicking the **Edit** button in the **Audit Event Type** zone.

- Modify the required details in the **Main** section.
- Associate or disassociate the required algorithms from the audit event type.

Note: If an audit event is created using the audit event type, you cannot edit or remove algorithms from the audit event type. In such case, you can only associate additional algorithms with the audit event type.

- Add, edit, or remove elements from the audit event type, if required.

Note:

The **Audit Elements for Entity Update** section is enabled when the **Update All** option is not selected in the **Main** section.

You cannot add, edit, or remove elements from the **Audit Elements for Entity Update** section when an audit event is already created using the audit event type.

8. Define, edit, or remove characteristics of the audit event type, if required.

Note: You cannot define, edit, or remove characteristics of the **Characteristics** section when an audit event is already created using the audit event type.

9. Click **Save**.

The changes made to the audit event type are saved.

Related Topics

For more information on...	See...
Audit Event Type screen	Audit Event Type on page 3303
Audit Event Type List zone	Audit Event Type List on page 3305
Audit Event Type zone	Audit Event Type on page 3306
How to associate an algorithm with an audit event type	Associating an Algorithm with an Audit Event Type on page 3311
How to add an element for auditing in an audit event type	Adding an Element for Auditing in an Audit Event Type on page 3312
How to define a characteristic for an audit event type	Defining a Characteristic for an Audit Event Type on page 3315

Copying an Audit Event Type

Instead of creating an audit event type from scratch, you can create a new audit event type using an existing audit event type. This is possible through copying an audit event type. On copying an audit event type, the details including the algorithms, audit elements, and characteristics are copied to the new audit event type. You can then edit the details, if required.

Prerequisites

To copy an audit event type, you should have:

- Audit event type (whose copy you want to create) defined in the application
- Entity business objects defined in the application
- The **Eligible for Audit Event** option type of the entity business object (for which you want to define an audit event type) set to **Y**

Note: The **Eligible for Audit Event** option type is available for the entity business object when the **Valid BO Option Type** option type of the respective maintenance object is set to **CIAT**.

- Values defined for the **AUDIT_USAGE_FLG** lookup field

Procedure

To copy an audit event type:

1. Click the **Admin** link in the **Application** toolbar.

A list appears.

- From the **Admin** menu, select **A** and then click **Audit Event Type**.

A sub-menu appears.

- Click the **Search** option from the **Audit Event Type** sub-menu.

The **Audit Event Type** screen appears.

- In the **Audit Event Type List** zone, click the **Duplicate** () icon in the **Duplicate** column corresponding to the audit event type whose copy you want to create.

The **Audit Event Type** screen appears. It contains the following sections:

- Main** - Used to specify basic information about the audit event type.
- Algorithms** - Used to associate algorithms with the audit event type.
- Audit Elements for Entity Update** - Used to list the elements from the entity business object which you want to monitor for auditing while updating the entity.

Note: The **Audit Elements for Entity Update** section is enabled only when the **Update All** option is not selected in the **Main** section.

- Characteristics** - Used to define the characteristics for the audit event type.

The **Main** section contains the following fields:

Field Name	Field Description	Mandatory (Yes or No)
Audit Event Type	Used to specify the audit event type.	Yes
	Note: You cannot specify any special characters except hyphen and underscore in the audit event type.	
Business Object	Indicates the business object which is used while defining the audit event type.	Not applicable
Description	Used to specify the description for the audit event type.	Yes
Detailed Description	Used to specify additional information about the audit event type.	No
Status	Used to indicate the status of the audit event type. The valid values are: <ul style="list-style-type: none"> Active Inactive 	Yes
	Note: You can create only one audit event type in the Active status for an entity business object.	
Entity Business Object	Used to indicate the business object for which you want to define the audit event type.	Yes
	Note: The list includes only those business objects where the Eligible for Audit Event option type is set to Y .	

Field Name	Field Description	Mandatory (Yes or No)
Audit Usage	Used to indicate the purpose of auditing an entity which is created using the entity business object. The valid values are: <ul style="list-style-type: none"> • Premium Calculation - Used when you want to audit an entity which has an impact on membership premium calculation. • Disaggregation/Reseeding - Used when you want to audit an entity for which the system should automatically create disaggregation or reseeding request. 	Yes
Update All	Used to indicate whether you want to create an audit event whenever any field, characteristic, or status of the entity is updated.	No
Add Action	Used to indicate whether you want to create an audit event whenever the entity is added.	Yes (Conditional) Note: This field is required when you want to create an audit event while adding the entity.
Delete Action	Used to indicate whether you want to create an audit event whenever the entity is deleted.	Yes (Conditional) Note: This field is required when you want to create an audit event while deleting the entity.

Tip: Alternatively, you can copy an audit event type by clicking the **Duplicate** button in the **Audit Event Type** zone.

- Enter the required details in the **Main** section.
- Associate or disassociate the required algorithms from the audit event type.
- Add, edit, or remove elements from the audit event type, if required.

Note: The **Audit Elements for Entity Update** section is enabled when the **Update All** option is not selected in the **Main** section.

- Define, edit, or remove characteristics of the audit event type, if required.
- Click **Save**.

The new audit event type is defined.

Related Topics

For more information on...	See...
Audit Event Type screen	Audit Event Type on page 3303
Audit Event Type List zone	Audit Event Type List on page 3305
Audit Event Type zone	Audit Event Type on page 3306
How to associate an algorithm with an audit event type	Associating an Algorithm with an Audit Event Type on page 3311

For more information on...	See...
How to add an element for auditing in an audit event type	Adding an Element for Auditing in an Audit Event Type on page 3312
How to define a characteristic for an audit event type	Defining a Characteristic for an Audit Event Type on page 3315

Deleting an Audit Event Type

Procedure

To delete an audit event type:

1. Click the **Admin** link in the **Application** toolbar.
A list appears.
2. From the **Admin** menu, select **A** and then click **Audit Event Type**.
A sub-menu appears.
3. Click the **Search** option from the **Audit Event Type** sub-menu.
The **Audit Event Type** screen appears.
4. In the **Audit Event Type List** zone, click the **Delete** (🗑️) icon in the **Delete** column corresponding to the audit event type that you want to delete.
A message appears confirming whether you want to delete the audit event type.

Note: You can delete an audit event type when an audit event is not yet created using the audit event type.

Tip: Alternatively, you can delete an audit event type by clicking the **Delete** button in the **Audit Event Type** zone.

5. Click **OK**.
The audit event type is deleted.

Related Topics

For more information on...	See...
Audit Event Type screen	Audit Event Type on page 3303
Audit Event Type List zone	Audit Event Type List on page 3305
Audit Event Type zone	Audit Event Type on page 3306

Viewing the Audit Event Type Details

Procedure

To view the details of an audit event type:

1. Click the **Admin** link in the **Application** toolbar.
A list appears.
2. From the **Admin** menu, select **A** and then click **Audit Event Type**.
A sub-menu appears.
3. Click the **Search** option from the **Audit Event Type** sub-menu.

The **Audit Event Type** screen appears.

- In the **Audit Event Type List** zone, click the **Broadcast** (📡) icon corresponding to the audit event type whose details you want to view.

The **Audit Event Type** zone appears.

- View the details of the audit event type in the **Audit Event Type** zone.

Related Topics

For more information on...	See...
Audit Event Type screen	Audit Event Type on page 3303
Audit Event Type List zone	Audit Event Type List on page 3305
Audit Event Type zone	Audit Event Type on page 3306

Audit Event (Used for Searching)

The **Audit Event** screen allows you to search for an audit event using various search criteria. It contains the following zone:

- [Search Audit Event](#) on page 3322

Through this screen, you can navigate to the following screen:

- [Audit Event \(Used for Viewing\)](#) on page 3326

Related Topics

For more information on...	See...
How to search for an audit event	Searching for an Audit Event on page 3325
How to view the details of an audit event	Viewing the Audit Event Details on page 3326

Search Audit Event

The **Search Audit Event** zone allows you to search for an audit event using various search criteria. It contains the following two sections:

- Search Criteria** - The **Search Criteria** section contains the following fields:

Field Name	Field Description	Mandatory (Yes or No)
Search By	Used to indicate whether you want to search for an audit event using the entity or audit event details. The valid values are: <ul style="list-style-type: none"> Entity Details Audit Event Details 	Yes
	Note: By default, the Entity Details option is selected.	

Field Name	Field Description	Mandatory (Yes or No)
Entity	Used to search audit events which are created for a particular entity business object.	No
	<p>Note:</p> <p>This field appears when the Entity Details option is selected from the Search By list.</p> <p>The list includes only those entity business objects where the Eligible for Audit Event option type is set to Y.</p>	
Created From	Used to search audit events which are created from a particular date onwards.	No
Created To	Used to search audit events which are created till a particular date.	No
Entity ID	Used to search audit events which are created for a particular entity.	No
	<p>Note:</p> <p>This field appears when the following conditions are met:</p> <ul style="list-style-type: none"> • The Entity Details option is selected from the Search By list. • The entity business object is selected from the Entity list. <p>You can search for an audit event by clicking the Search (🔍) icon corresponding to the field.</p>	
Status	<p>Used to search audit events with a particular status. The valid values are:</p> <ul style="list-style-type: none"> • Canceled • Complete • Error • Pending 	No
	<p>Note:</p> <p>This field appears in the search criteria by default, when the Audit Event Details option is selected from the Search By list.</p> <p>In case you choose the Entity Details option, this field appears only when the entity business object is selected from the Entity list.</p>	

Field Name	Field Description	Mandatory (Yes or No)
From Effective Date	Used to search audit events whose effective date is equal to or later than the specified date.	No
	Note: This field appears only when you choose the Entity Details option from the Search By list and entity business object from the Entity list.	
To Effective Date	Used to search audit events whose effective date is equal to or earlier than the specified date.	No
	Note: This field appears only when you choose the Entity Details option from the Search By list and entity business object from the Entity list.	
Audit Event ID	Used to search a particular audit event.	No
	Note: This field appears when the Audit Event Details option is selected from the Search By list.	
Audit Event Type	Used to search audit events which are created using a particular audit event type.	No
	Note: This field appears when the Audit Event Details option is selected from the Search By list.	
Audit Action	Used to search audit events which are created while adding, updating, or deleting an entity. The valid values are: <ul style="list-style-type: none"> • Add Row • Change Row • Delete Row 	No
	Note: This field appears when the Audit Event Details option is selected from the Search By list.	

Note: You must specify at least one search criterion while searching for an audit event.

- **Search Results** - On clicking the **Search** button, the search results appear based on the specified search criteria. The **Search Results** section contains the following columns:

Column Name	Column Description
Creation Date Time	Displays the date and time when the audit event is created.
Audit Event Information	Displays information about the audit event.
	Note: It has a link. On clicking the link, the Audit Event screen appears where you can view the details of the respective audit event.
Entity ID	Indicates the entity for which the audit event is created.
Entity	Indicates the entity business object for which the audit event is created.

Column Name	Column Description
Effective Date	Displays the effective date which is stamped corresponding to the audit event.
	Note: The effective date is used later to derive the timeline for premium calculation.
Status	Indicates the status of the audit event. The valid values are: <ul style="list-style-type: none"> • Canceled • Complete • Error • Pending
Audit Action	Indicates the action due to which the audit event is created for the entity. The valid values are: <ul style="list-style-type: none"> • Add Row • Change Row • Delete Row
Pricing Requested	Indicates whether the repricing entity detail records are created for the audit event. The valid values are: <ul style="list-style-type: none"> • Yes • No
	Note: It has a link. On clicking the link, if the repricing entity record exist, the Repricing Request screen appears where you can view the details of the repricing entity. In case the record does not exist, the system displays a warning message.

Note: Pagination is used to display limited number of records in the **Search Results** section. You can use the navigation links, such as **Previous** and **Next** to navigate between pages.

Related Topics

For more information on...	See...
How to search for an audit event	Searching for an Audit Event on page 3325
How to view the details of an audit event	Viewing the Audit Event Details on page 3326

Searching for an Audit Event

Prerequisites

To search for an audit event, you should have:

- Entity business objects defined in the application
- The **Eligible for Audit Event** option type of the entity business object set to **Y**

Note: The **Eligible for Audit Event** option type is available for the entity business object when the **Valid BO Option Type** option type of the respective maintenance object is set to **CIAT**.

Procedure

To search for an audit event:

1. Click the **Menu** link in the **Application** toolbar.
A list appears.
2. From the **Main** menu, select **Transaction and Audit Event Management** and then click **Audit Event**.
The **Audit Event** screen appears.
3. Enter the search criteria in the **Search Audit Event** zone.

Note: ORMB search engine supports wildcard search, where you can substitute the percentage (%) symbol as a stand in for any word or letter in a search criteria. You can use the ‘%’ wildcard character in all input fields except the date and ID fields. The ‘%’ wildcard character is suffixed automatically at the end of the partial search criteria. Therefore, you may or may not specify the wildcard character at the end of the partial search criteria. However, you have to prefix the wildcard character manually wherever required.

4. Click **Search**.
A list of audit events that meet the search criteria appears in the **Search Results** section.

Related Topics

For more information on...	See...
Audit Event screen	Audit Event (Used for Searching) on page 3322
Search Audit Event zone	Search Audit Event on page 3322

Viewing the Audit Event Details

Procedure

To view the details of an audit event:

1. Search for the audit event in the **Audit Event** screen.
2. In the **Search Results** section, click the link in the **Audit Event Information** column corresponding to the audit event whose details you want to view.
The **Audit Event** screen appears.
3. Ensure that the **Main** tab is selected.
4. View the details of the audit event in the **Audit Event** zone.

Related Topics

For more information on...	See...
How to search for an audit event	Searching for an Audit Event on page 3325
Audit Event screen	Audit Event (Used for Viewing) on page 3326
Audit Event zone	Audit Event on page 3327

Audit Event (Used for Viewing)

The **Audit Event** screen allows you to view the details of an audit event. In addition, it allows you to cancel an audit event which is in the **Error** status. It contains the following tabs:

- [Audit Event - Main](#) on page 3327
- [Audit Event - Log](#) on page 3328

Related Topics

For more information on...	See...
How to view the details of an audit event	Viewing the Audit Event Details on page 3326
How to cancel an audit event	Canceling an Audit Event on page 3329

Audit Event - Main

The **Main** tab displays information about the audit event. It contains the following zone:

- [Audit Event](#) on page 3327

Audit Event

The **Audit Event** zone displays the details of the audit event. It contains the following sections:

- **Main** - Displays basic information about the audit event. It contains the following fields:

Field Name	Field Description
Audit Event Information	Displays information about the audit event.
Audit Event Type	Indicates the audit event type using which the audit event is created. Note: It has a link. On clicking the link, the Audit Event Type screen appears where you can view the details of the respective audit event type.
Status	Indicates the status of the audit event. The valid values are: <ul style="list-style-type: none"> • Canceled • Complete • Error • Pending
Entity ID	Indicates the entity for which the audit event is created.
Effective Date	Displays the effective date which is stamped corresponding to the audit event in the C1_AUDIT_EVENT table. Note: If the entity has a start date, then the effective date is set to the entity's start date. But, if the entity does not have a start date, then the effective date is set to the system date.
Audit Action Flag	Indicates the action due to which the audit event is created for the entity. The valid values are: <ul style="list-style-type: none"> • Add Row • Change Row • Delete Row

Field Name	Field Description
Maintenance Object	Indicates the maintenance object of the entity business object for which the audit event is created.
	Note: It has a link. On clicking the link, the Maintenance Object screen appears where you can view the details of the respective maintenance object.

- **Characteristics** - Lists the characteristics defined for the audit event. It contains the following columns:

Column Name	Column Description
Characteristic Type	Indicates the characteristic type.
Characteristic Value	Displays the value of the characteristic type.

- **Record Actions** - This section contains the following button:

Button Name	Button Description
Cancel	Used to cancel the audit event.
	Note: The Cancel button appears when the audit event is in the Error status.

- **Record Information** - This section contains the following fields:

Field Name	Field Description
Business Object	Indicates the business object using which the audit event is created. In addition, a context menu appears corresponding to this field which helps in navigating to other screens in the application.
	Note: It has a link. On clicking the link, the Business Object screen appears where you can view the details of the respective business object.
Status Date/Time	Displays the date and time when the audit event status is updated.
Create Date/Time	Displays the date and time when the audit event is created.

Related Topics

For more information on...	See...
How to cancel an audit event	Canceling an Audit Event on page 3329

Audit Event - Log

The **Log** tab contains the following zone:

- [Audit Event Log](#) on page 3328

Audit Event Log

The **Audit Event Log** zone lists the complete trail of actions performed on the audit event. It contains the following columns:

Column Name	Column Description
Creation Date Time	Displays the date and time when the action was performed on the audit event.

Column Name	Column Description
Details	Displays the details about the action performed on the audit event.
User	Indicates the user who has performed the action on the audit event.
Log type	Indicates the type of log.
Related Object	Indicates the object or entity which is created when the action is performed on the audit event. Note: At present, no data appears in this column. The implementation team can build the custom logic to meet the business requirements.
Status Reason	Indicates the reason why the status of the audit event is changed. Note: At present, no data appears in this column. The implementation team can build the custom logic to meet the business requirements.

Related Topics

For more information on...	See...
How to view the log of an audit event	Viewing the Log of an Audit Event on page 3330

Canceling an Audit Event

There might be situations when an erroneous audit event is created in the system. In such case, the system provides you with an ability to cancel such audit events. However, note that you can cancel an audit event when the audit event is in the **Error** status.

Prerequisites

To cancel an audit event, you should have:

- Cancel reasons defined in the application

Note: While cancelling an audit event, you need to specify the reason why you want to cancel the audit event. You can select the appropriate cancel reason when you have defined the reasons for the **Canceled** status of the **C1-AuditEvent** business object in the **Status Reason** screen.

Procedure

To cancel an audit event:

1. Search for the audit event in the **Audit Event** screen.
2. In the **Search Results** section, click the link in the **Audit Event Information** column corresponding to the audit event which you want to cancel.

The **Audit Event** screen appears.

3. Ensure that the **Main** tab is selected.
4. Click the **Cancel** button in the **Audit Event** zone.

The **Status Reason** window appears. It contains the following field:

Field Name	Field Description	Mandatory (Yes or No)
Status Reason	Used to indicate the reason why you want to cancel the audit event.	Yes

Note: The **Cancel** button appears when the audit event is in the **Error** status.

5. Select the cancel reason from the **Status Reason** list.
6. Click **Save**.

The status of the audit event is changed to **Canceled**.

Related Topics

For more information on...	See...
How to search for an audit event	Searching for an Audit Event on page 3325
Audit Event screen	Audit Event (Used for Viewing) on page 3326
Audit Event zone	Audit Event on page 3327

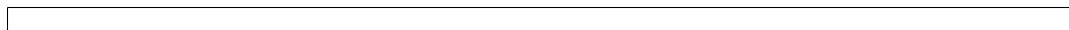

Viewing the Log of an Audit Event

Procedure

To view the log of an audit event:

1. Search for the audit event in the **Audit Event** screen.
2. In the **Search Results** section, click the link in the **Audit Event Information** column corresponding to the audit event whose log you want to view.

The **Audit Event** screen appears.

3. Click the **Log** tab.

The **Log** tab appears.

4. View the complete trail of actions performed on the audit event in the **Audit Event Log** zone.

Related Topics

For more information on...	See...
How to search for an audit event	Searching for an Audit Event on page 3325
Audit Event screen	Audit Event (Used for Viewing) on page 3326
Audit Event Log zone	Audit Event Log on page 3328



Chapter 43

Invoice Request

Topics:

- [Prerequisites](#)
- [Types of Invoice Request](#)
- [Invoice Request Manual Trial Bill Generation \(Without Approval\) Status Transition](#)
- [Invoice Request Manual Regular Bill Generation \(Without Approval\) Status Transition](#)
- [Invoice Request Manual Regular Bill Generation \(With Approval\) Status Transition](#)
- [Invoice Request Automatic Regular Bill Generation \(Without Approval\) Status Transition](#)
- [Invoice Request Type](#)
- [Invoice Request \(Used for Searching\)](#)
- [Invoice Request \(Used for Viewing\)](#)

Oracle Revenue Management and Billing enables you to generate an adhoc regular or trial bill for an account through an invoice request. The system enables you to create an invoice request manually or automatically. It enables you to create an invoice request for a person or an account. You can create an invoice request for an account where the **Eligible For Invoice Request Creation (INVRACTE)** characteristic is set to **Y**.

If you create an invoice request for a person, the system will consider all those accounts of the person where the **Eligible For Invoice Request Creation (INVRACTE)** characteristic is set to **Y**. You can then exclude an account from the invoice request, if required. The system also enables you to consider all accounts of the person and its child persons where the **Eligible For Invoice Request Creation (INVRACTE)** characteristic is set to **Y**.

Note: The system searches for the characteristic type which is specified in the **Invoice Request Account Eligibility Char Type** option type of the **C1-INVREQ** feature configuration. By default, this option type is set to **INVRACTE**. You can change the characteristic type, if required.

In other words, the system enables you to create the following types of invoice request:

- **Manual Regular Bill Generation Invoice Request** - It is used to generate an adhoc regular bill for an account. You can create a manual regular bill generation invoice request for a person or an account from the user interface.
- **Manual Trial Bill Generation Invoice Request** - It is used to generate an adhoc trial bill for an account. You can create a manual trial bill generation invoice request for a person or an account from the user interface.
- **Automatic Regular Bill Generation Invoice Request** - It is used to generate an adhoc regular bill for an account. You can configure the system such that an automatic regular bill generation invoice request is created for an account automatically when a fully-insured group policy is activated, terminated, reinstated, or renewed from the user interface or through a health care inbound message.

Note:

The automatic invoice request creation feature is only designed to work for the fully-insured group health insurance business and not for the financial services or self-funded health insurance business.

You cannot create an automatic regular bill generation invoice request for a person.

At present, the system is not designed to create an automatic trial bill generation invoice request.

While creating an invoice request, you need to specify an invoice request type using which you want to create the invoice request. The system enables you to create the invoice request types with the following combinations:

Invoice Mode	Bill Generation Type	Approval Process
Manual	Regular	On
Manual	Regular	Off
Manual	Trial	Off
Automatic	Regular	Off

It is the invoice request type which helps the system to determine:

- The business object using which the invoice request should be created in the system

Note: Two invoice request business objects named **Invoice Request - Regular Bill Generation (C1-InvoiceRequest)** and **Invoice Request - Trial Bill Generation (C1-InvoiceRequestTrial)** are introduced in this release. If the **Bill Generation Type** field is set to **Regular**, you must select the **Invoice Request - Regular Bill Generation** business object from the **Invoice Request Business Object** list. However, if the **Bill Generation Type** field is set to **Trial**, you must select the **Invoice Request - Trial Bill Generation** business object from the **Invoice Request Business Object** list.

- Whether a manual or automatic invoice request should be created in the system
- Whether a regular or trial bill generation invoice request should be created in the system
- Whether a manual regular bill generation invoice request for an account should be processed in the online or deferred mode

Note:

The system will process a manual regular bill generation invoice request for an account in the deferred mode when the number of billable charges of the account exceeds the defer processing billable charge count.

The defer processing billable charge count is not considered when a manual regular bill generation invoice request is created for a person.

You can specify the defer processing billable charge count when the invoice mode is set to **Manual** and bill generation type is set to **Regular**.

- Whether the approval is required for the invoice request

Note: You can only set the **Approval Required** flag when the invoice mode is set to **Manual** and bill generation type is set to **Regular**.

- The wait days which is used to calculate the processing date for an invoice request

Note:

If the invoice request is processed in the online mode, the system will process the invoice request when the processing date is earlier than or equal to the system date. However, if the invoice request is processed in the deferred mode, the system will process the invoice request when the processing date is earlier than or equal to the batch business date.

If required, you can configure the system such that the processing date does not fall on a holiday. To implement this requirement you need to specify the work calendar which helps to determine the working day.

- The date calculation algorithm which is used to calculate the processing date for an automatic regular bill generation invoice request

Note: In addition, you can configure threshold days for automatic invoice request creation. It is used to determine whether the number of days between the bill cycle date and processing date is greater than the threshold days. This parameter is used in Invoice Request Date Calculation algorithm to check whether the processing date of the invoice request is within threshold period. If so, the automatic invoice request is not created for the account. This parameter is only applicable while activating or renewing a fully-insured group policy.

While creating a manual invoice request, you need to specify the following – invoice request type, entity (i.e. person or account for which the invoice request should be created), cutoff date, accounting date, and bill date.

Note: The cutoff date, accounting date, and bill date are derived while creating an automatic invoice request for an account.

For more information about the types of invoice request, see [Types of Invoice Request](#) on page 3334.

For more information on how to setup the invoice request feature, see [Prerequisites](#) on page 3334.

Prerequisites

To setup the invoice request process, you need to do the following:

- Define the required invoice request types in the system.
- Define the required characteristic types where the characteristic entity is set to **Invoice Request Type**
- Define the required characteristic types where the characteristic entity is set to **Invoice Request**
- Assign the **C1-INVRA** To Do type to a To Do role whose users must receive To Do generated while submitting an invoice request for approval
- Assign the **C1-INVRS** To Do type to a To Do role whose users must receive To Do generated while resubmitting an invoice request
- Set the batch control type of the **Invoice Request Periodic Monitor (C1-INVQR)** batch to **Timed** and define the following attributes:
 - Time Interval
 - Timer Active
 - User ID
 - Batch Language
 - Email Address

For more information about the **Invoice Request Periodic Monitor (C1-INVQR)** batch, see *Oracle Revenue Management and Billing Batch Guide*.

- Set the batch control type of the **Pending Bill Generation (BILLOPEN)**, **Bill Segment Generation (BSGENREG)**, and **Bill Completion (POSTPROC)** batches to **Timed** and define the following attributes:
 - Time Interval
 - Timer Active
 - User ID
 - Batch Language
 - Email Address

For more information about these batches, see *Oracle Revenue Management and Billing Batch Guide*.

Set the following feature configuration in the system:

- **Invoice Request Configuration (C1-INVREQ)**

Types of Invoice Request

The system allows you to create the following types of invoice requests:

- [Manual Regular Bill Generation Invoice Request](#) on page 3334
- [Manual Trial Bill Generation Invoice Request](#) on page 3336
- [Automatic Regular Bill Generation Invoice Request](#) on page 3336

Manual Regular Bill Generation Invoice Request

Once a manual regular bill generation invoice request is created in the **Draft** status, the system checks whether it is created for a person or an account. If a manual regular bill generation invoice request is created for an account,

you can submit the invoice request. On submitting the invoice request, the system checks whether the number of the billable charges of the account exceed the defer processing billable charge count. If the number of the billable charges of the account exceed the defer processing billable charge count, the status of the invoice request is changed to **Defer Processing Batch**. However, if the number of the billable charges of the account does not exceed the defer processing billable charge count, the system checks whether the processing date of the invoice request is earlier than or equal to the system date. If the processing date is later than the system date, the status of the invoice request is changed to **Defer Processing**. On the **C1-INVRQ** batch execution, the system checks whether there are any invoice requests in the **Defer Processing** status. If there is an invoice request in the **Defer Processing** status, the system checks whether the processing date of the invoice request is earlier than or equal to the system date. If the processing date is later than the system date, the status of the invoice request remains as **Defer Processing**.

Note: The system enables you to cancel an invoice request which is in the **Defer Processing Batch** or **Defer Processing** status.

However, if the processing date is earlier than or equal to the system date, the system checks whether the pending bill already exists for the account. If the pending bill does not exist for the account, the system checks whether the cutoff date is later than the bill after date. If cutoff date is later than the bill after date, the system checks whether the accounting calendar is open for the accounting date. If the accounting calendar is open for the accounting date, the system creates the adhoc regular bill for the account in the online mode. Finally, the status of the invoice request is changed to **Processed**.

However, if the pending bill exists for the account, or if the cutoff date is earlier than or equal to the bill after date, or if the accounting calendar is not open for the accounting date, or if an error occurs while creating adhoc regular bill or its bill segments, the status of the invoice request is changed to **Error**. The system enables you to move such erroneous invoice request back to the **Draft** status.

However, if a manual regular bill generation invoice request is created for a person, the system checks whether the number of accounts of the person (if the **Include Person Hierarchy** option is not selected) or the number of accounts of the person and its child persons (if the **Include Person Hierarchy** option is selected) exceeds the limit defined in the **Account Limit** option type of the **C1-INVREQ** feature configuration. If the number of accounts does not exceed the account limit, the system derives the account of the person or the person and its child persons. Once the accounts are successfully derived, the status of the invoice request is changed to **Defer Processing Batch**.

However, if the number of accounts exceeds the account limit, the status of the invoice request is changed to **Account Derivation Pending**. On the **C1-INVRQ** batch execution, the system checks whether there are any invoice requests in the **Account Derivation Pending** status. If there is an invoice request in the **Account Derivation Pending** status, the system derives the accounts of the person or the person and its child persons. Once the accounts are successfully derived, the status of the invoice request is changed to **Defer Processing Batch**.

When you execute the **BILLOPEN** batch with the **Off Cycle Switch** parameter set to **Y**, the system checks whether the account that meets the search criteria is included in any invoice request which is in the **Defer Processing Batch** status. If the account is included in the invoice request, the system checks whether the processing date of the invoice request is earlier than or equal to the batch business date. If processing date is earlier than or equal to the batch business date, the system checks whether there is any record in the **Processing** status for the account in the invoice request. If so, the system checks whether the pending bill already exists for the account. If the pending bill does not exist for the account, the system checks whether the cutoff date is later than the bill after date. If cutoff date is later than the bill after date, the system checks whether the accounting calendar is open for the accounting date. If the accounting calendar is open for the accounting date, the system creates the adhoc regular bill for the account in the **Pending** status. When you execute the **BSGENREQ** batch with the **Off Cycle Switch** parameter set to **Y**, the system creates the bill segments for the adhoc regular bill. When you execute the **POSTPROC** batch with the **Off Cycle Switch** parameter set to **Y**, the system creates the post-processing bill segments (if any) and completes the adhoc regular bill of the account. Finally, the status of the invoice request is changed to **Processed**.

However, if the pending bill exists for the account, or if the cutoff date is earlier than or equal to the bill after date, or if the accounting calendar is not open for the accounting date, or if an error occurs while creating adhoc regular bill or its bill segments, or if a To Do is generated for the bill review, the status of the record in the invoice request is changed to **Error**. If all records in the invoice request are in the **Error** status, the status of the invoice request is changed to **Error**. The system enables you to move such erroneous invoice request back to the **Draft** status.

You can optionally configure the approval process for the manual regular bill generation invoice request. If the **Approval Required** flag is set to **Yes** in the invoice request type, the status of the manual regular bill generation invoice request is changed to **Approval In Progress** when you submit the invoice request. The approver can then approve or reject the manual regular bill generation invoice request based on the observations.

Manual Trial Bill Generation Invoice Request

The manual regular bill generation invoice request and manual trial bill generation invoice request are created and processed identically with the following exceptions:

- On submitting the manual trial bill generation invoice request for an account, the system does not check whether the number of the billable charges of the account exceed the defer processing billable charge count. Therefore, the manual trial bill generation invoice request is always processed in the deferred mode.
- You need to specify the following parameters while executing the **BILLOPEN**, **BSGENREQ**, and **POSTPROC** batches:
 - Bill Generation Type (set to **Trial**)
 - Description for Trial Billing Batch Run
 - Off Cycle Switch (set to **Y**)
- The **BSGENREQ** batch will not freeze and complete a trail bill for the account.
- At present, a To Do is not generated for a trial bill review, and therefore the system does not check whether a To Do is generated for a trial bill review.

Automatic Regular Bill Generation Invoice Request

To enable the automatic invoice request creation feature for the fully-insured group health insurance business, you need to attach the following algorithms:

If you want to create an automatic invoice request for an account while...	Then attach the algorithm....			
	Business Object	Status	System Event	Algorithm
Activating a Fully-Insured Group Policy <div style="border: 1px solid black; padding: 5px;"> <p>Note: This happens only on the customer onboarding. If an invoice request is already processed for any account in the person's hierarchy, the system will not create an invoice request for the account.</p> </div>	C1-POLICY	In Force/ Active	Enter	C1- INVREQCRE
Terminating a Fully-Insured Group Policy		Terminated	Enter	C1- INVREQPT
Reinstating a Fully-Insured Group Policy		Reinstated	Enter	C1- INVREPRIN
Renewing a Fully-Insured Group Policy		-	Audit	C1- IRPOLREW

If you want to create an automatic invoice request for an account while...	Then attach the algorithm....			
	Business Object	Status	System Event	Algorithm
Creating an Account for a Parent Customer or Bill Group who is the Main Customer of the Fully-Insured Group Policy <div style="border: 1px solid black; padding: 5px; margin-top: 10px;"> <p>Note: This happens only on the customer onboarding. If an invoice request is already processed for any account in the person's hierarchy, the system will not create an invoice request for the account.</p> </div>	C1-AccountBO	-	Post-Processing	C1-INVRCTPO

The above algorithms contain a parameter wherein you can specify the invoice request type using which the automatic invoice request should be created in the system.

If the automatic invoice request creation feature is configured for the fully-insured group health insurance business, the system creates an automatic regular bill generation invoice request in the **Defer Processing Batch** status for an account when:

- A fully-insured group policy is activated, terminated, reinstated, or renewed
- An account is created for a parent customer or bill group who is the main customer of the fully-insured group policy

The deferred mode processing for manual regular bill generation invoice request and automatic regular bill generation invoice request is identical.

Invoice Request Manual Trial Bill Generation (Without Approval) Status Transition

The following figure graphically indicates how an invoice request in the manual trial bill generation process moves from one status to another when the approval process is not configured in the invoice request type:

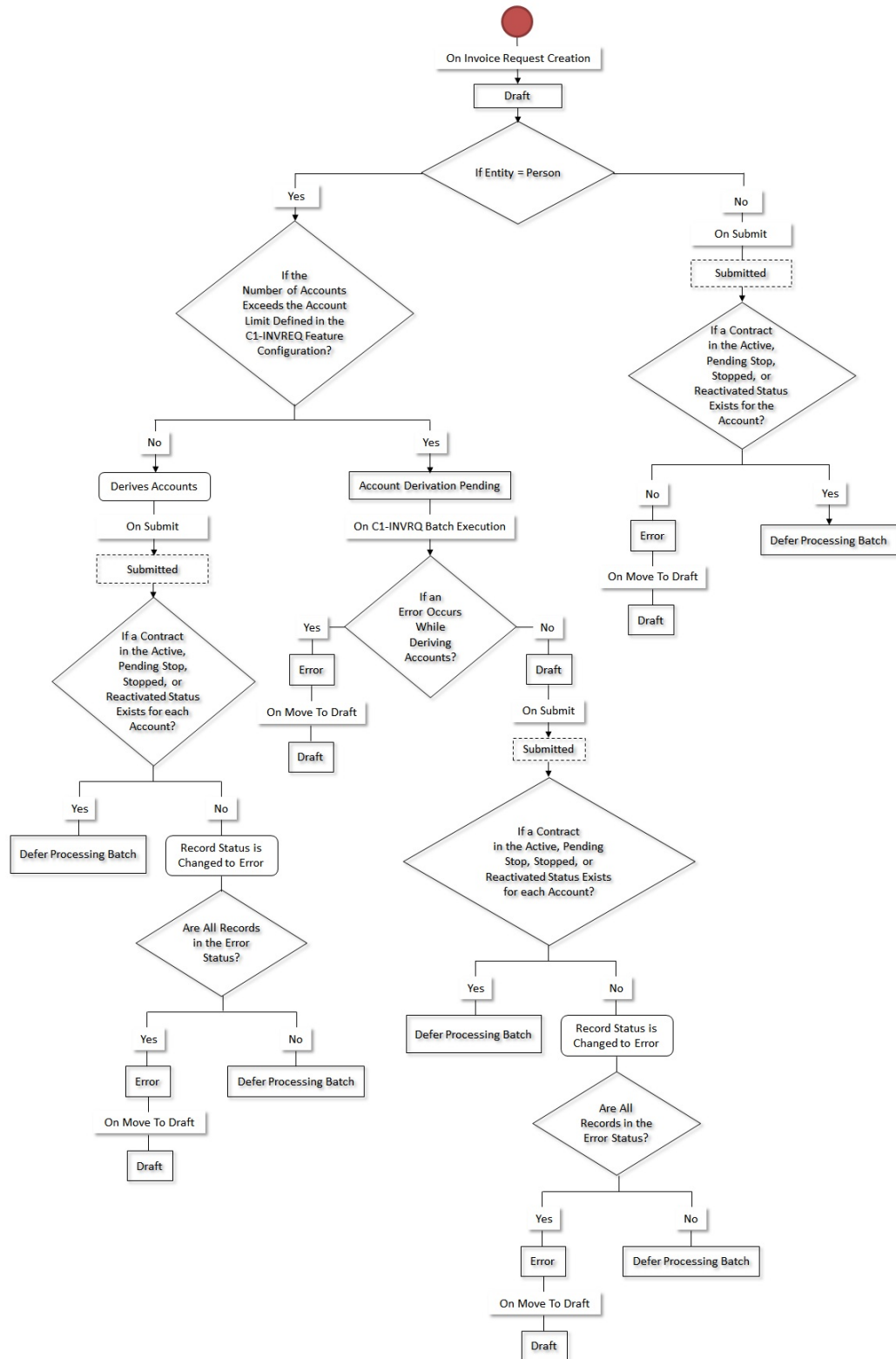

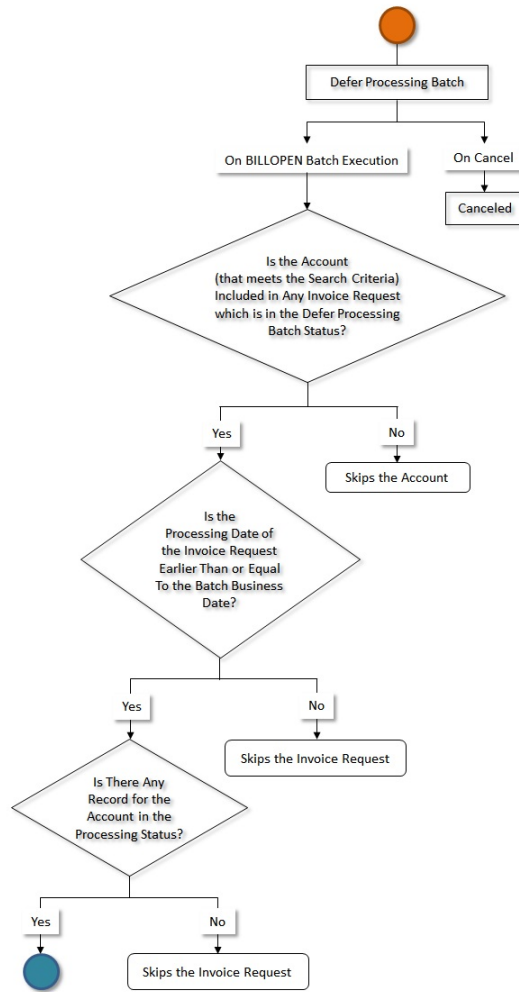

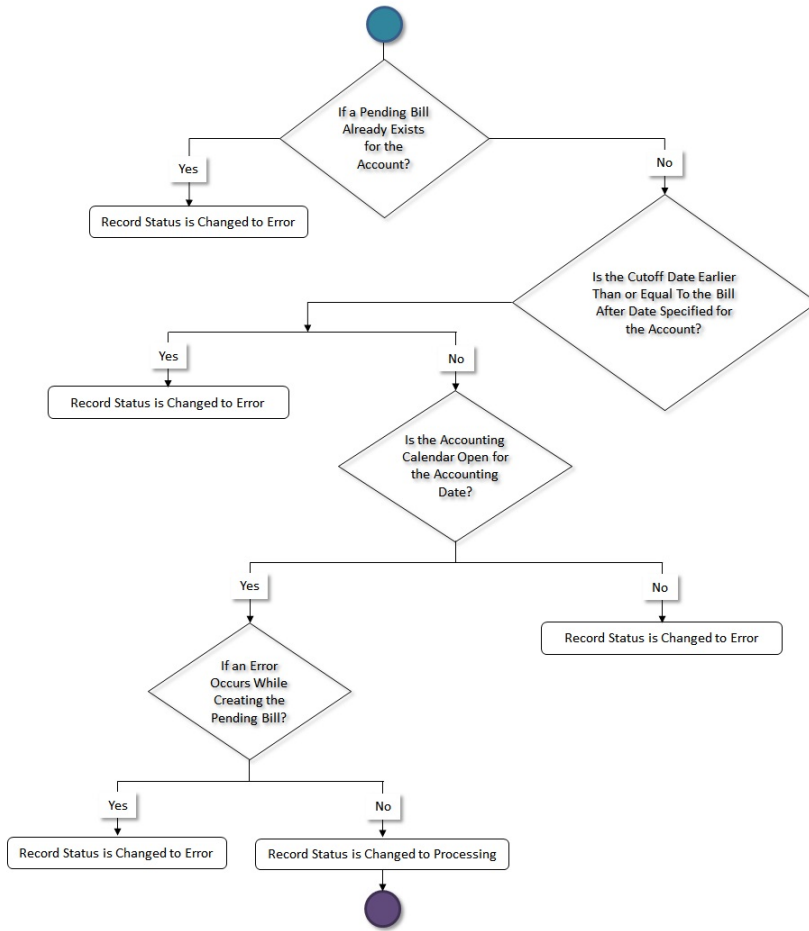

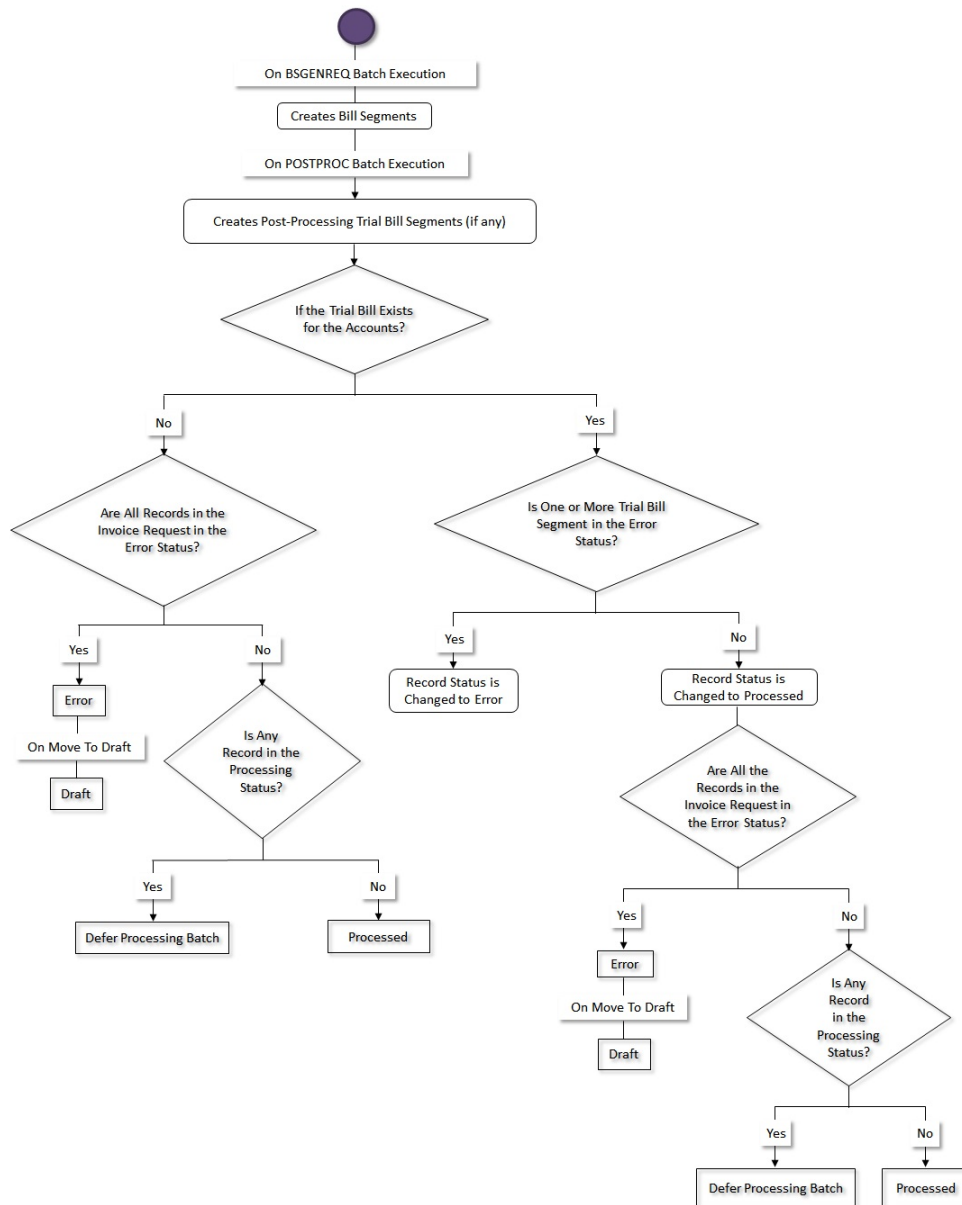

Invoice Request Manual Regular Bill Generation (Without Approval) Status Transition

The following figure graphically indicates how an invoice request in the manual regular bill generation process moves from one status to another when the approval process is not configured in the invoice request type:

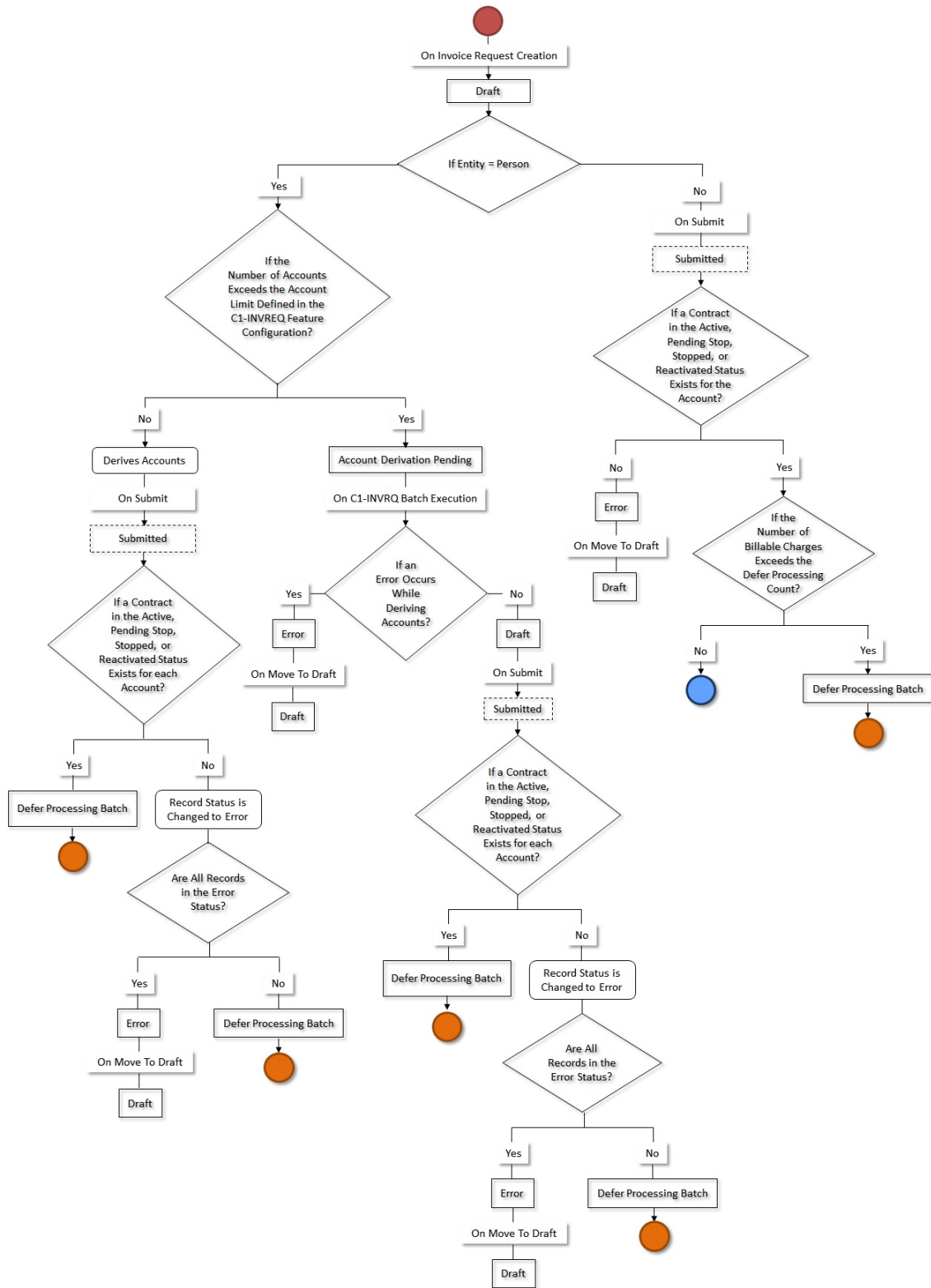

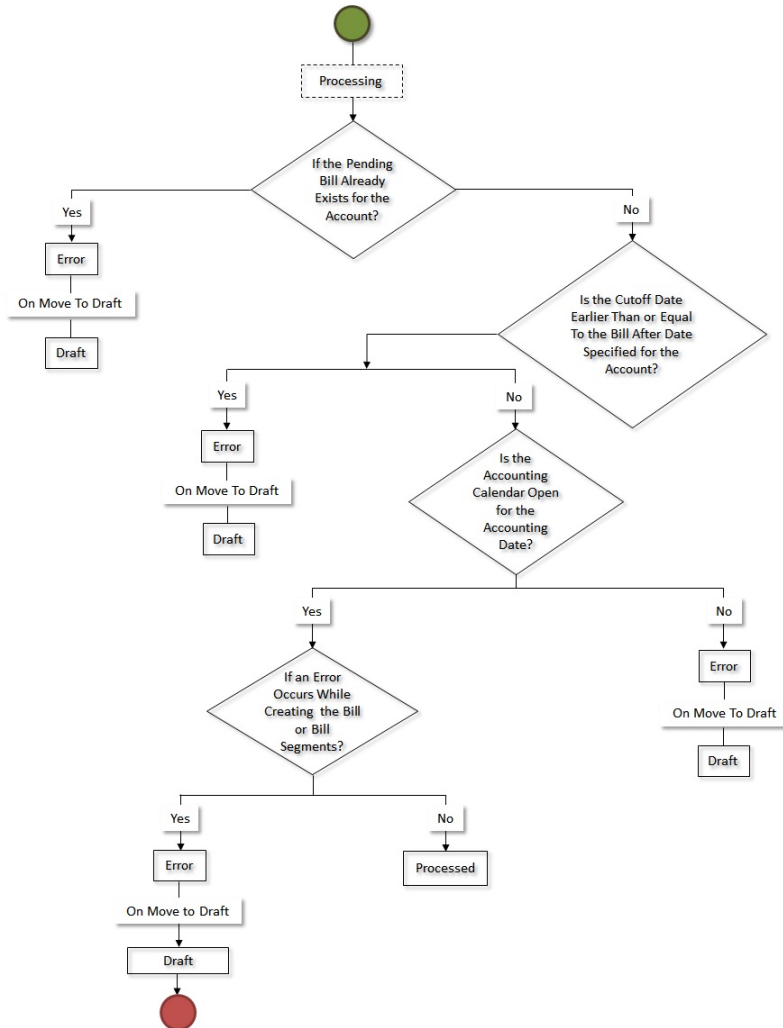
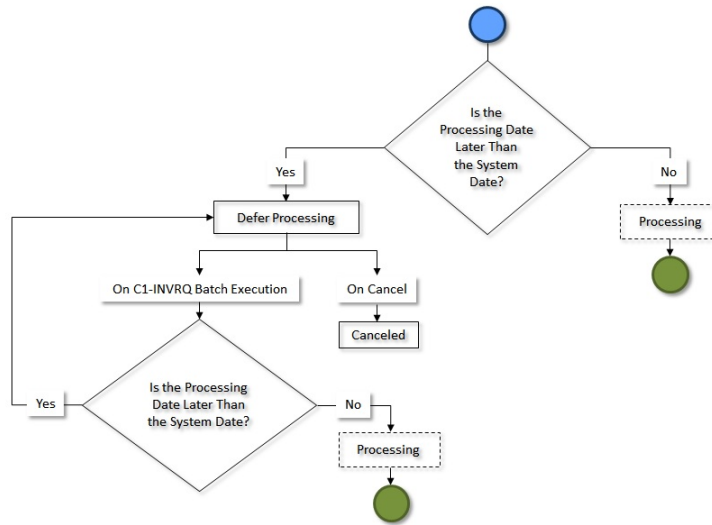

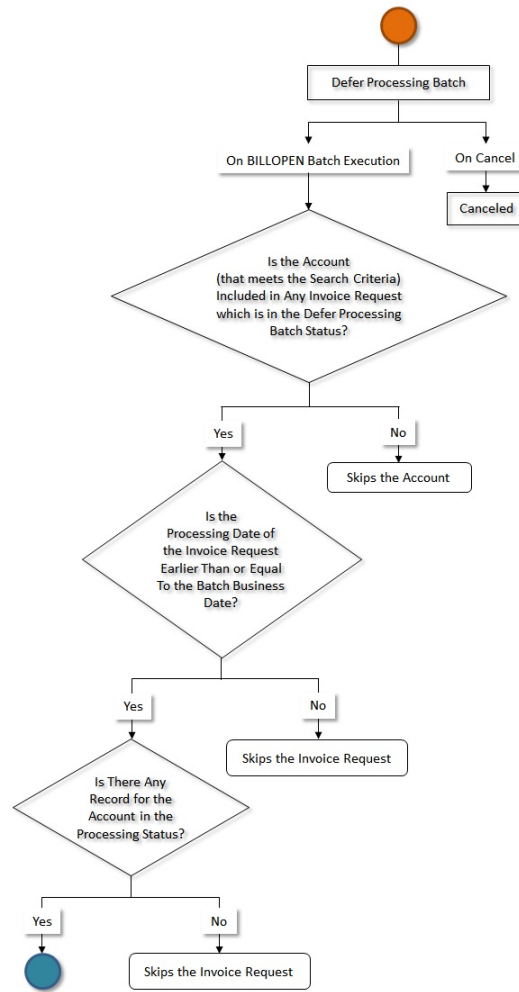

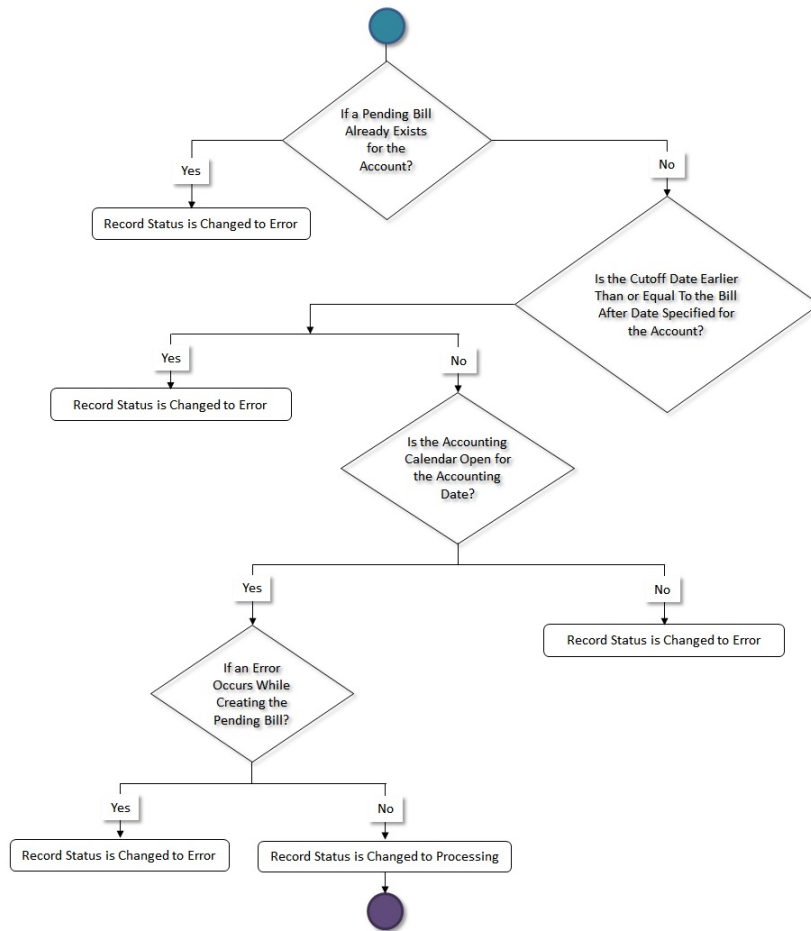

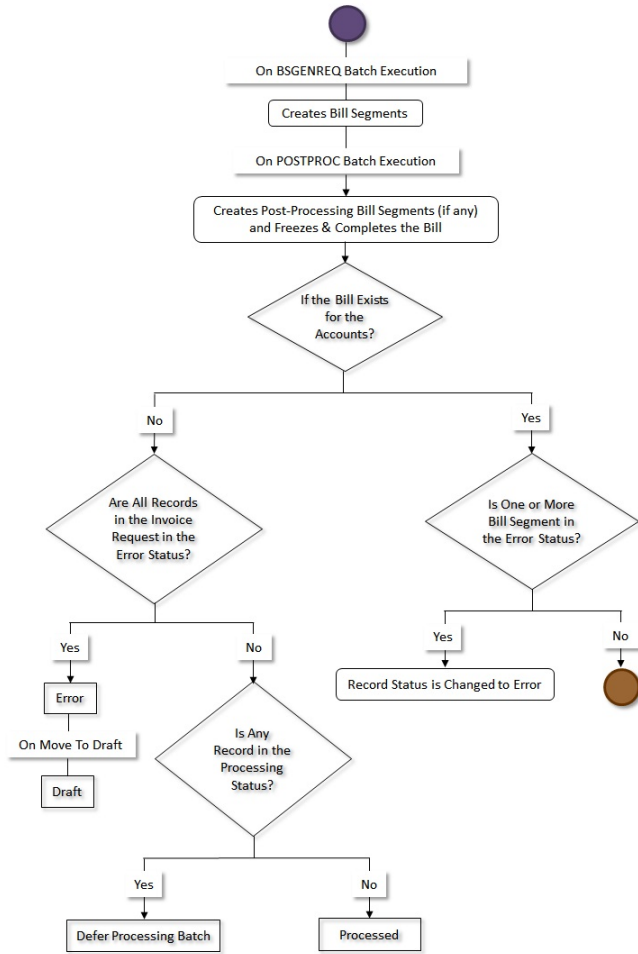

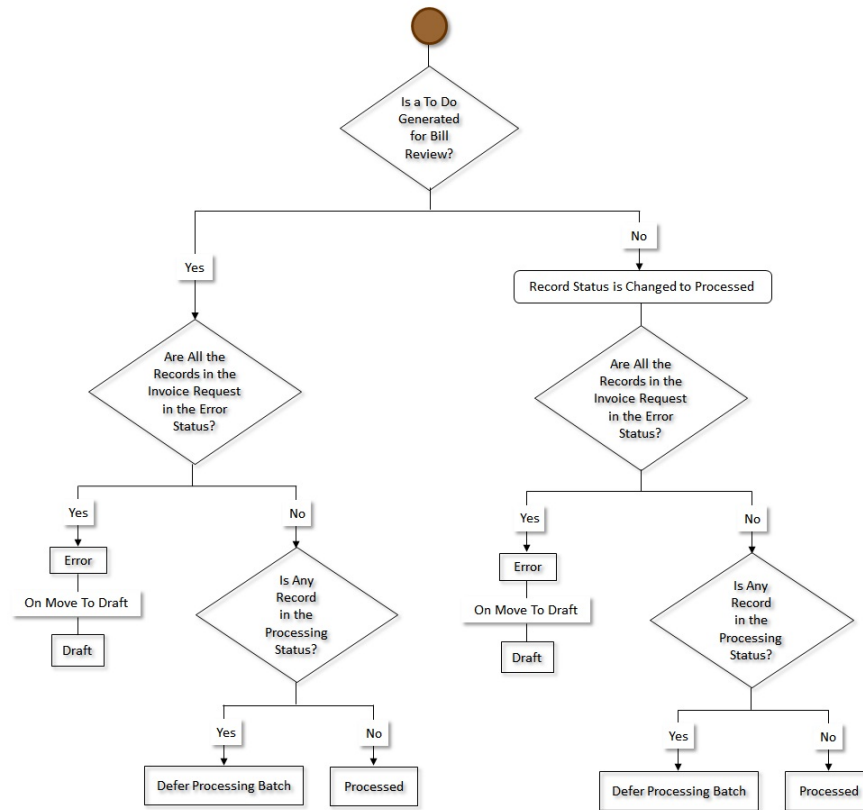

Invoice Request Manual Regular Bill Generation (With Approval) Status Transition

The following figure graphically indicates how an invoice request in the manual regular bill generation process moves from one status to another when the approval process is configured in the invoice request type:

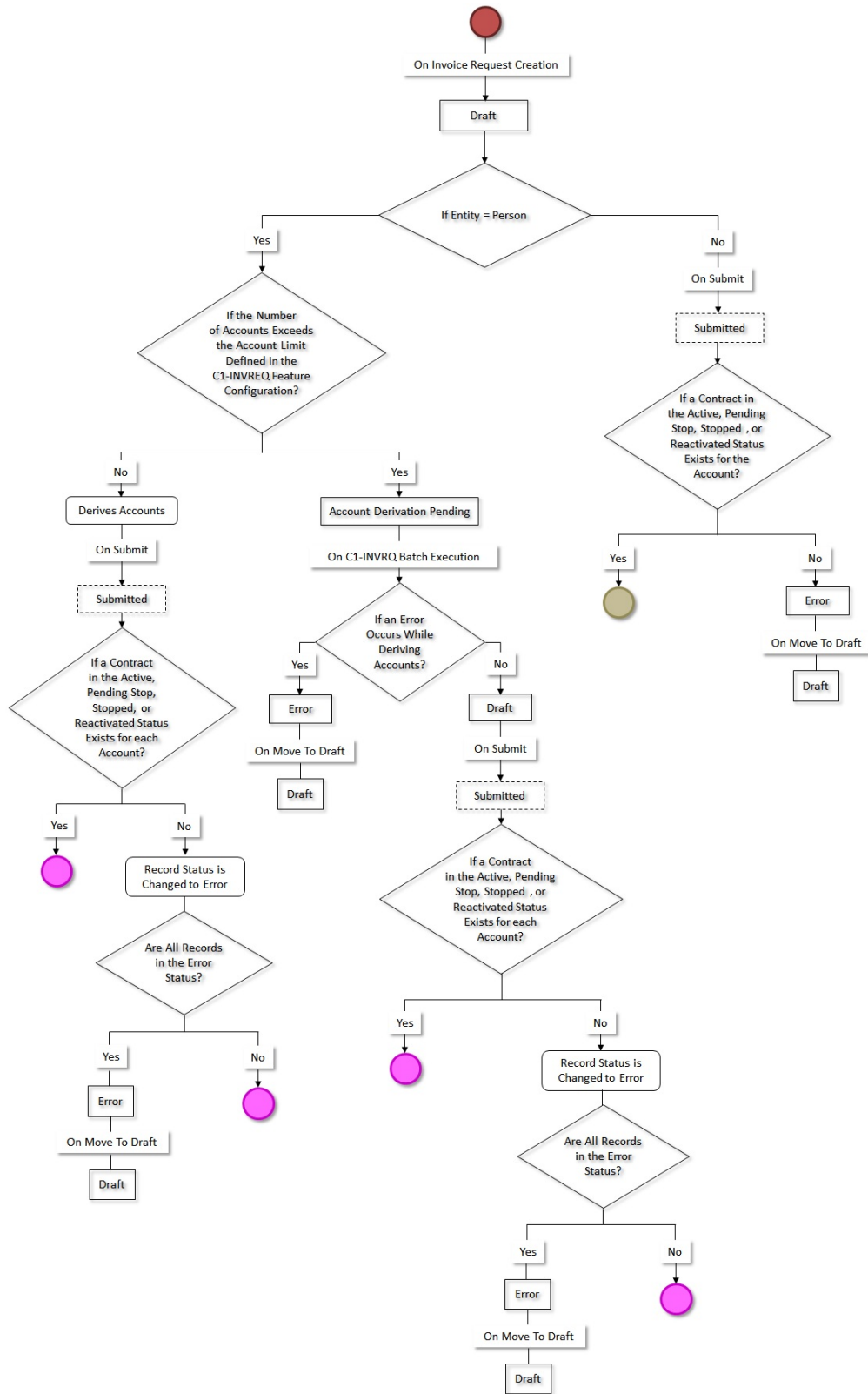

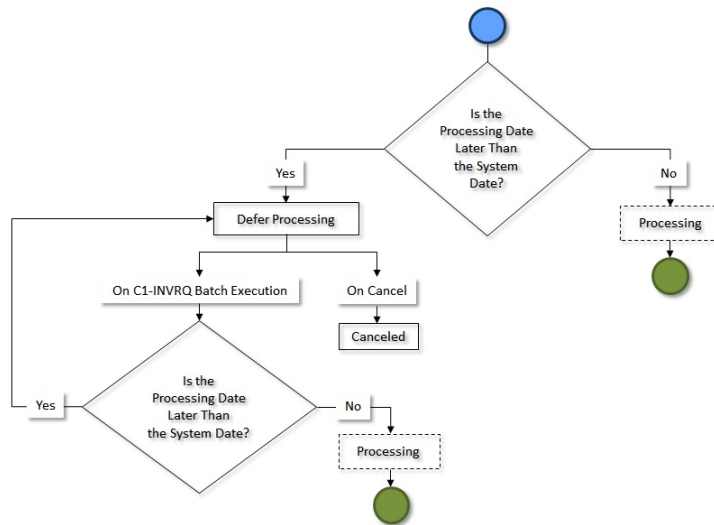
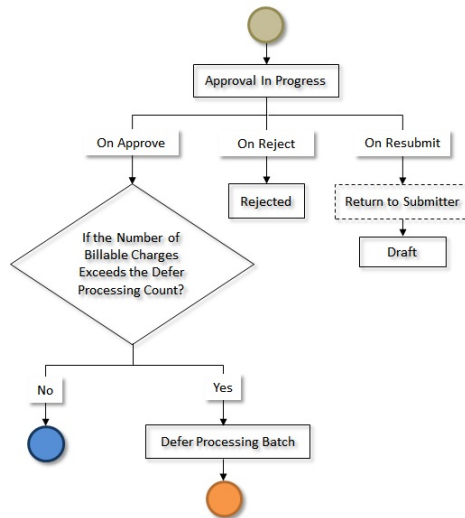
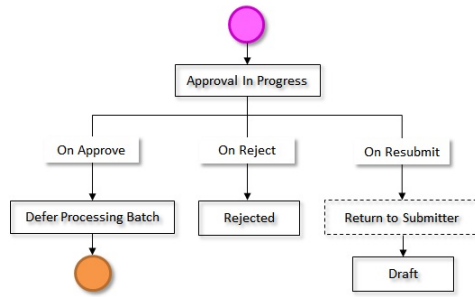

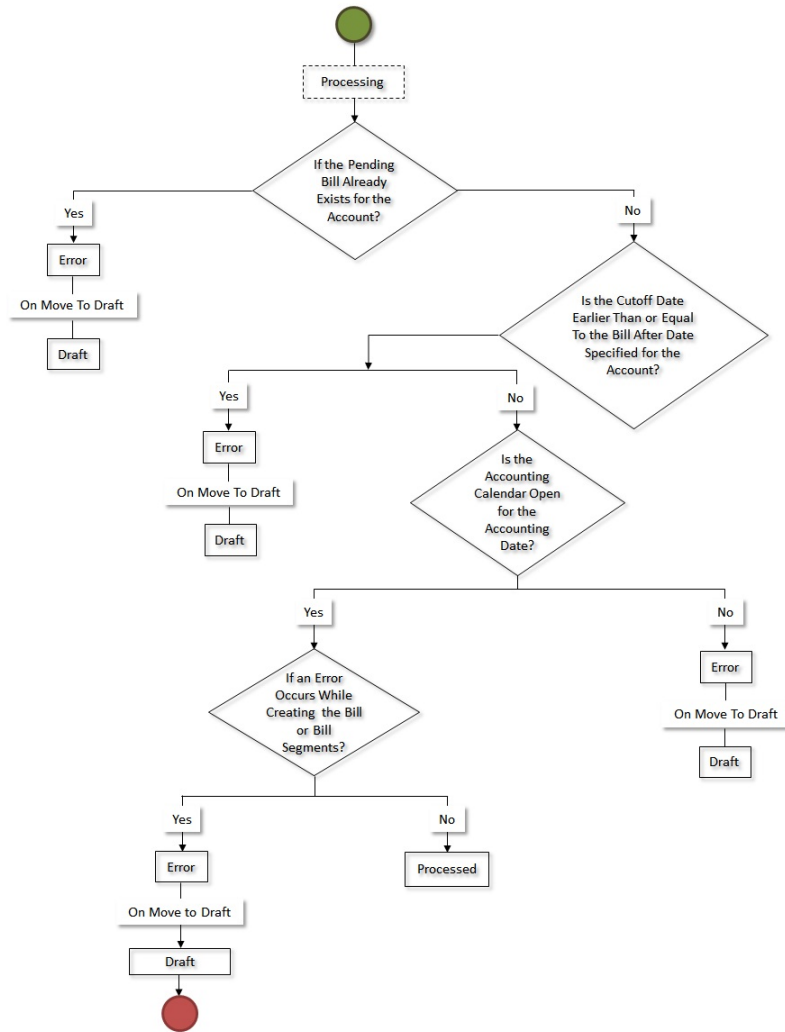

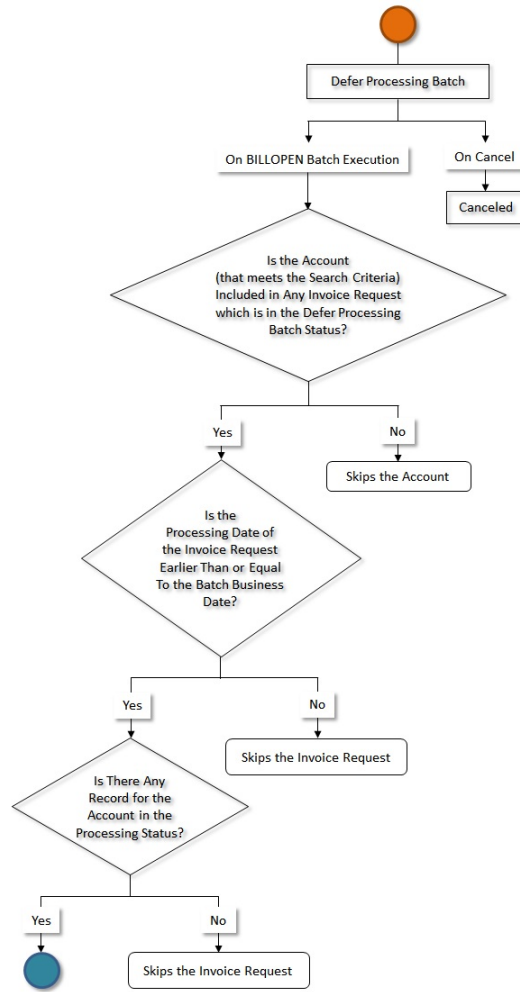

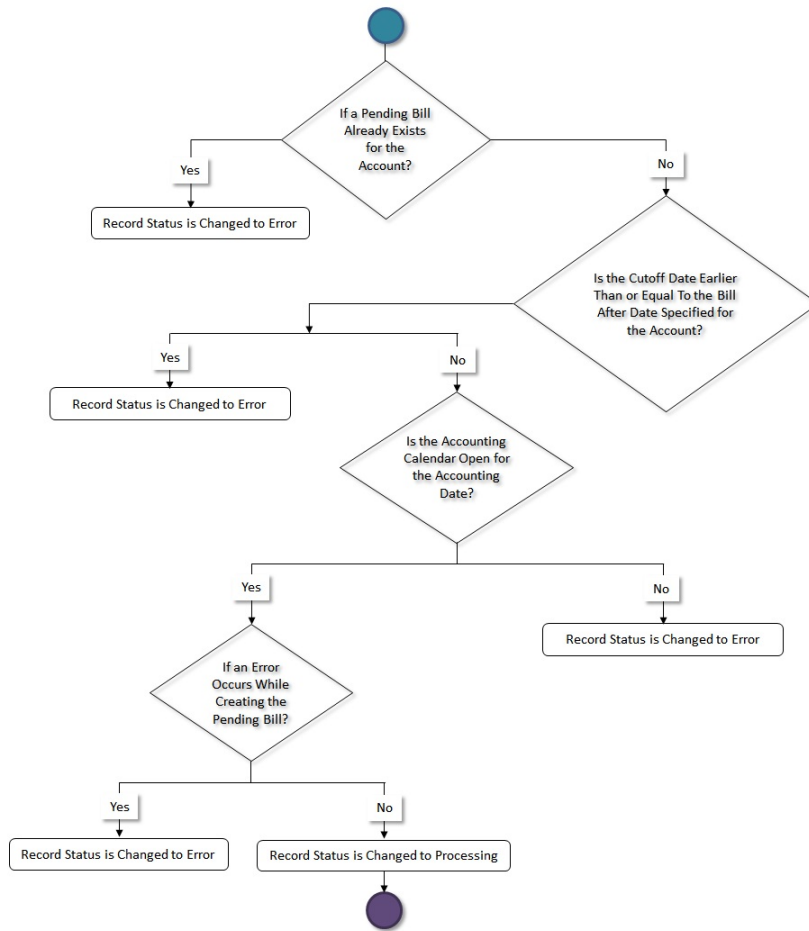

Invoice Request Automatic Regular Bill Generation (Without Approval) Status Transition

The following figure graphically indicates how an invoice request in the automatic regular bill generation process moves from one status to another when the approval process is not configured in the invoice request type:

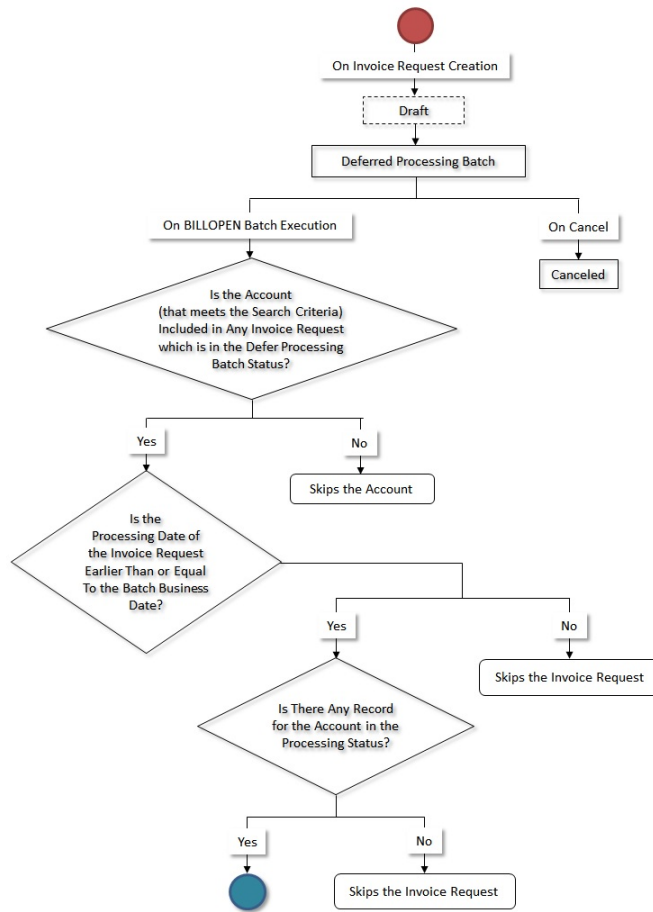

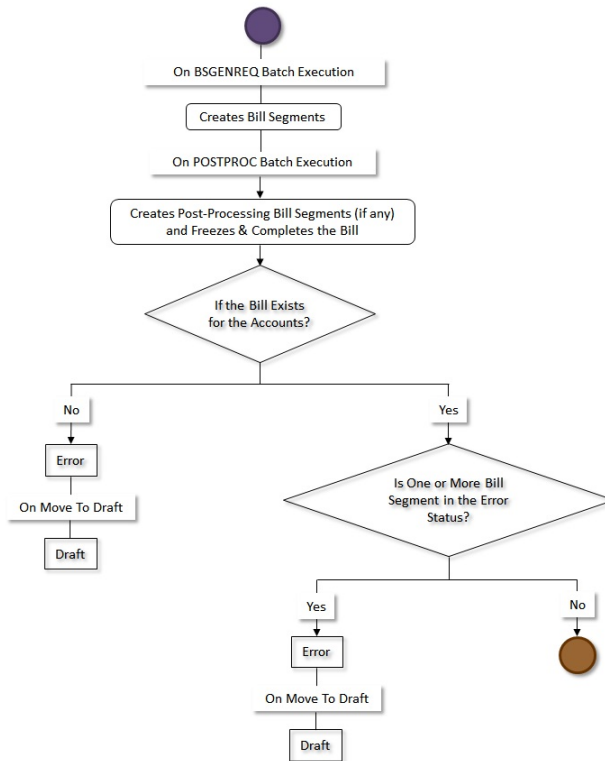
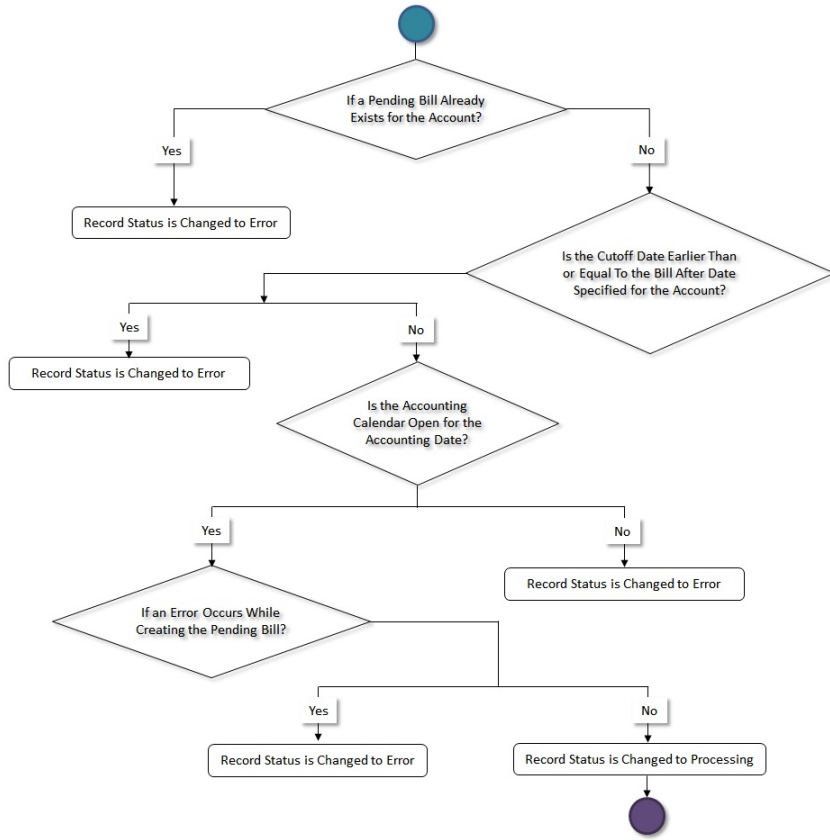

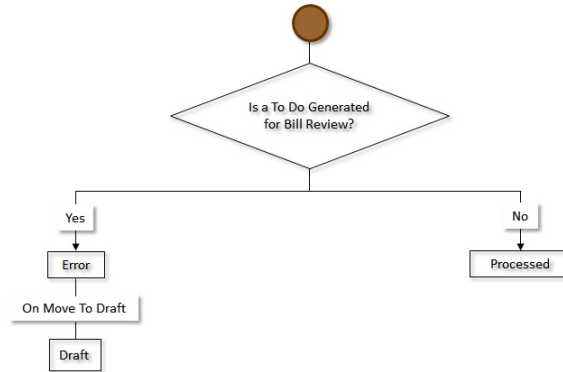

Invoice Request Type

Oracle Revenue Management and Billing enables you to define an invoice request type using which you can create an invoice request. The invoice request type helps the system to determine:

- The business object using which the invoice request should be created in the system
- Whether a manual or automatic invoice request should be created in the system
- Whether a regular or trial bill generation invoice request should be created in the system
- Whether a manual regular bill generation invoice request for an account should be processed in the online or deferred mode
- Whether the approval is required for the invoice request
- The wait days which is used to calculate the processing date for an invoice request
- The date calculation algorithm which is used to calculate the processing date for an automatic regular bill generation invoice request

Note: The automatic invoice request is only designed to work for the fully-insured group and individual health insurance businesses and not for the financial services or self-funded health insurance businesses.

The **Invoice Request Type** screen allows you to define, edit, copy, and delete an invoice request type. It contains the following zones:

- [Invoice Request Type List](#) on page 3355
- [Invoice Request Type](#) on page 3356

Invoice Request Type List

The **Invoice Request Type List** zone lists the invoice request types that are already defined in the system. It contains the following columns:

Column Name	Column Description
Invoice Request Type	Displays the invoice request type.
Description	Displays the description of the invoice request type.
Edit	On clicking the Edit (✎) icon, the Invoice Request Type screen appears where you can edit the details of the invoice request type.

Column Name	Column Description
Duplicate	On clicking the Duplicate (📄) icon, the Invoice Request Type screen appears where you can define a new invoice request type using an existing invoice request type.
Delete	On clicking the Delete (🗑️) icon, you can delete the invoice request type.
	Note: You can delete an invoice request type when an invoice request is not created using the invoice request type.

On clicking the **Broadcast** (📡) icon corresponding to an invoice request type, the **Invoice Request Type** zone appears with the details of the respective invoice request type.

Related Topics

For more information on...	See...
How to edit an invoice request type	Editing an Invoice Request Type on page 3365
How to copy an invoice request type	Copying an Invoice Request Type on page 3370
How to delete an invoice request type	Deleting an Invoice Request Type on page 3369
How to view the details of an invoice request type	Viewing the Invoice Request Type Details on page 3374

Invoice Request Type

The **Invoice Request Type** zone displays the details of the invoice request type. It contains the following sections:

- **Main** - Displays basic information about the invoice request type. It contains the following fields:

Field Name	Field Description
Invoice Request Type	Displays the invoice request type.
Description	Displays the description of the invoice request type.
Invoice Request Business Object	Indicates the business object using which an invoice request should be created. In addition, a context menu appears corresponding to this field which helps in navigating to other screens in the application. Note: It has a link. On clicking the link, the Business Object screen appears where you can view the details of the respective business object.
Detailed Description	Displays additional information about the invoice request type.
Status	Indicates the status of the invoice request type. The valid values are: <ul style="list-style-type: none"> • Active • Inactive
Invoice Mode	Indicates the mode of the invoice request type. The valid values are: <ul style="list-style-type: none"> • Automatic • Manual

Field Name	Field Description
Bill Generation Type	<p>Indicates the bill generation type, using which an invoice request should be created. The valid values are:</p> <ul style="list-style-type: none"> • Regular • Trial <p>Note: If Automatic option is selected from the Invoice Mode list, this field is disabled, and by default, is set to Regular.</p>
Defer Processing Billable Charge Count	<p>Displays the count which helps to determine whether an invoice request must be processed in the deferred mode (i.e. in the background) or in real time (i.e. immediately). If the number of billable charges created for the bills which are selected in the invoice request exceeds the defer processing billable charge count, the system processes the invoice request in the deferred mode. However, if the number of billable charges created for the bills which are selected in the invoice request does not exceed the defer processing billable charge count, the system processes the invoice request in real time (i.e. immediately).</p> <p>Note: You cannot specify a negative value in this field.</p> <p>Deferred mode means in the background when the Generic Request Periodic Monitor (C1-GENRQ) batch is invoked. You can configure the Generic Request Periodic Monitor (C1-GENRQ) batch such that it is executed at regular intervals. For more information about the Generic Request Periodic Monitor (C1-GENRQ) batch, refer to <i>Oracle Revenue Management and Billing Batch Guide</i>.</p> <p>This field appears when the Manual option is selected from the Invoice Mode list, and Regular option is selected from the Bill Generation Type list.</p> <p>If you set the defer processing billable charge count to zero (0), the system resets the default value to 500.</p>
Date Calculation Algorithm	<p>Indicates the algorithm using which the date should be calculated while adding a bill in an invoice request.</p> <p>Note: It has a link. On clicking the link, the Algorithm screen appears where you can view the details of the respective algorithm.</p> <p>This field appears when the Automatic option is selected from the Invoice Mode list.</p>
Invoice Request Approval Required	<p>Indicates whether approval is required while invoicing bills through an invoice request.</p> <p>Note: This field appears when the Automatic option is selected from the Invoice Mode list.</p>

Field Name	Field Description
Approval To Do Type	Indicates that the To Do entry of the specified To Do type must be created when an invoice request is submitted for approval.
	<p>Note:</p> <p>It has a link. On clicking the link, the To Do Type screen appears where you can view the details of the respective To Do Type.</p> <p>This field appears when the Approval Required option is selected.</p>
Approval To Do Role	Indicates that users with the specified To Do role can only approve an invoice request which is submitted for approval.
	<p>Note:</p> <p>It has a link. On clicking the link, the To Do Role screen appears where you can view the details of the respective To Do Role.</p> <p>This field appears when the Approval Required option is selected.</p>
Submitter To Do Type	Indicates the submitter To Do type. At present, the submitter To Do type is not used to create To Do entry when the approver rejects an invoice request. It is only used to fetch the roles associated with the submitter To Do type while defining or editing the invoice request type.
	<p>Note: It has a link. On clicking the link, the To Do Type screen appears where you can view the details of the respective To Do type.</p>
Submitter To Do Role	Indicates that users with the specified To Do role cannot approve an invoice request which is submitted for approval.
	<p>Note: It has a link. On clicking the link, the To Do Role screen appears where you can view the details of the respective To Do role.</p>
Freeze and Complete	Indicates whether the invoice request raised through an automatic or manual invoice mode should be freeze and complete.
	<p>Note:</p> <p>This field is not mandatory if the Invoice Mode - Manual option is selected.</p> <p>By default, this field is selected and disabled when the Invoice Mode - Automatic option is selected.</p> <p>The field should not be checked when the Bill Generation Type - Trial option is selected.</p> <p>Once it is defined and saved, it cannot be changed as it is linked to request(s) which are under processing.</p> <p>For the Batch mode, this field value will be passed to the batch parameter Freeze and Complete.</p>

Field Name	Field Description
Wait Days	Displays the maximum wait period (in days) after which the bills in an invoice request are processed.
	Note: You cannot specify a negative value in the Wait Days field.

- **Characteristics** - Lists the characteristics defined for the invoice request type. It contains the following columns:

Field Name	Field Description
Characteristic Type	Indicates the characteristic type.
Characteristic Value	Displays the value of the characteristic type.

- **Record Actions** - This section contains the following buttons:

Button Name	Button Description
Edit	Used to edit the details of the invoice request type.
Delete	Used to delete the invoice request type.
	Note: You can delete an invoice request type when an invoice request is not created using the invoice request type.
Duplicate	Used to create a new invoice request type using an existing invoice request type.

- **Record Information** - This section contains the following field:

Field Name	Field Description
Business Object	Indicates the business object using which the invoice request type is created. In addition, a context menu appears corresponding to this field which helps in navigating to other screens in the application.
	Note: It has a link. On clicking the link, the Business Object screen appears where you can view the details of the respective business object.

By default, the **Invoice Request Type** zone does not appear in the **Invoice Request Type** screen. It appears when you click the **Broadcast** (📢) icon corresponding to an invoice request type in the **Invoice Request Type List** zone.

Related Topics

For more information on...	See...
How to edit an invoice request type	Editing an Invoice Request Type on page 3365
How to copy an invoice request type	Copying an Invoice Request Type on page 3370
How to delete an invoice request type	Deleting an Invoice Request Type on page 3369
How to view the details of an invoice request type	Viewing the Invoice Request Type Details on page 3374

Defining an Invoice Request Type

Prerequisites

To define an invoice request type, you should have:

- Invoice request type business objects defined in the application.
- Invoice request business objects defined in the application.
- Date calculation algorithm defined using the **C1-INVREDTCA** algorithm type.
- Required To Do role assigned to the **C1-INVRA** and **C1-INVRS** To Do types in the application

Procedure

To define an invoice request type:

1. Click the **Admin** link in the **Application** toolbar.
A list appears.
2. From the **Admin** menu, select **I** and then click **Invoice Request Type**.
A sub-menu appears.
3. Click the **Add** option from the **Invoice Request Type** sub-menu.



The **Invoice Request Type** screen appears. It contains the following sections:

- **Main** - Used to specify basic details about the invoice request type.
- **Characteristics** - Used to define the characteristics for the invoice request type.

The **Main** section contains the following fields:

Field Name	Field Description	Mandatory (Yes or No)
Invoice Request Type	Used to specify the invoice request type.	Yes
Business Object	Indicates the business object using which you are defining the invoice request type.	Not applicable
Description	Used to specify the description for the invoice request type.	Yes
Invoice Request Business Object	Used to indicate the business object using which you want to create an invoice request. The valid values are: <ul style="list-style-type: none"> • Invoice Request - Regular Bill Generation • Invoice Request - Trial Bill Generation 	Yes
Detailed Description	Used to specify additional information about the invoice request type.	No
Status	Used to indicate the status of the invoice request type. The valid values are: <ul style="list-style-type: none"> • Active • Inactive 	Yes
Invoice Mode	Used to indicate the mode of the invoice request type. The valid values are: <ul style="list-style-type: none"> • Manual • Automatic 	Yes
	Note: The automatic mode is not supported while creating an invoice request type for the financial services domain.	

Field Name	Field Description	Mandatory (Yes or No)
Bill Generation Type	<p>Used to indicate the bill generation type, using which an invoice request should be created. The valid values are:</p> <ul style="list-style-type: none"> • Regular • Trial <p>Note: If Automatic option is selected from the Invoice Mode list, this field is disabled, and by default, is set to Regular.</p>	Yes
Defer Processing Billable Charge Count	<p>Used to specify the count which helps to determine whether an invoice request must be processed in the deferred mode (i.e. in the background) or in real time (i.e. immediately). If the number of billable charges created for the bills which are selected in the invoice request exceeds the defer processing billable charge count, the system processes the invoice request in the deferred mode. However, if the number of billable charges created for the bills which are selected in the invoice request does not exceed the defer processing billable charge count, the system processes the invoice request in real time (i.e. immediately).</p> <p>Note:</p> <p>You cannot specify a negative value in this field.</p> <p>Deferred mode means in the background when the Generic Request Periodic Monitor (C1-GENRQ) batch is invoked. You can configure the Generic Request Periodic Monitor (C1-GENRQ) batch such that it is executed at regular intervals. For more information about the Generic Request Periodic Monitor (C1-GENRQ) batch, refer to <i>Oracle Revenue Management and Billing Batch Guide</i>.</p> <p>This field appears when the Manual option is selected from the Invoice Mode list, and Regular option is selected from the Bill Generation Type list.</p> <p>If you set the defer processing billable charge count to zero (0), the system resets the default value to 500.</p>	No

Field Name	Field Description	Mandatory (Yes or No)
Date Calculation Algorithm	Used to indicate the algorithm using which the date should be calculated while adding a bill in an invoice request.	Yes (Conditional)
	<p>Note:</p> <p>The Search  icon appears corresponding to the Date Calculation Algorithm field. On clicking the Search icon, the Algorithm Search window appears.</p> <p>On specifying the date calculation algorithm, the description of the date calculation algorithm appears corresponding to the Date Calculation Algorithm field.</p> <p>You can specify the date calculation algorithm when the Invoice Mode is selected as Automatic.</p>	<p>Note:</p> <p>This field is required when Invoice mode is Automatic.</p>
Invoice Request Approval Required	Used to indicate whether approval is required while invoicing bills through an invoice request.	No
	<p>Note: This field appears when the Automatic option is selected from the Invoice Mode list.</p>	
Approval To Do Type	Used to indicate that the To Do entry of the specified To Do type must be created when an invoice request is submitted for approval.	Yes (Conditional)
	<p>Note:</p> <p>The Search () icon appears corresponding to the Approval To Do Type field. On clicking the Search icon, the To Do Type Search window appears.</p> <p>On specifying the To Do type, the description of the To Do type appears corresponding to the Approval To Do Type field.</p> <p>This field appears when the Approval Required option is selected.</p> <p>The C1-INVRA To Do type is shipped with the product. You can use the C1-INVRA To Do type or a custom To Do type, if required.</p>	
Approval To Do Role	Used to indicate that users with the specified To Do role can only approve an invoice request which is submitted for approval.	Yes (Conditional)
	<p>Note:</p> <p>The list includes only those To Do roles which are associated with the approval To Do type.</p> <p>This field appears when the Approval Required option is selected.</p>	

Field Name	Field Description	Mandatory (Yes or No)
Submitter To Do Type	Used to indicate the submitter To Do type. At present, the submitter To Do type is not used to create To Do entry when the approver rejects an offset request. It is only used to fetch the roles associated with the submitter To Do type.	Yes (Conditional) Note: This field is required when the Approval Required option is selected.
	Note: The Search (🔍) icon appears corresponding to the Submitter To Do Type field. On clicking the Search icon, the To Do Type Search window appears. On specifying the To Do type, the description of the To Do type appears corresponding to the Submitter To Do Type field. The C1-INVRS To Do type is shipped with the product. You can use the C1-INVRS To Do type or a custom To Do type, if required.	
Submitter To Do Role	Used to indicate that users with the specified To Do role cannot approve an invoice request which is submitted for approval.	Yes (Conditional) Note: This field is required when the Approval Required option is selected. Once it is defined and saved, it cannot be changed as it is linked to request(s) which are under processing.
	Note: The list includes only those To Do roles which are associated with the submitter To Do type.	
Wait Days	Used to indicate the threshold days before which no other invoice request for any bill generation process will be initiated.	No
	Note: By default, the value displayed for wait days is 0 .	

4. Enter the required details in the **Main** section.
5. Define characteristics for the invoice request type, if required.
6. Click **Save**.

The invoice request type is defined.

Related Topics

For more information on...	See...
Invoice Request Type screen	Invoice Request Type on page 3355

For more information on...	See...
How to define a characteristic for an invoice request type	Defining a Characteristic for an Invoice Request on page 3390

Defining a Characteristic for an Invoice Request Type

Prerequisites

To define a characteristic for an invoice request type, you should have:

- Characteristic types defined in the application (where the characteristic entity is set to **Invoice Request Type**)

Procedure

To define a characteristic for an invoice request type:

1. Ensure that the **Characteristics** section is expanded when you are defining, editing, or copying an invoice request type.

The **Characteristics** section contains the following fields in a grid:

Field Name	Field Description	Mandatory (Yes or No)
Characteristic Type	Used to indicate the characteristic type.	Yes (Conditional)
	Note: The list includes only those characteristic types where the characteristic entity is set to Invoice Request Type .	Note: This field is required when you are defining a characteristic for the invoice request type.
Characteristic Value	Used to specify the value for the characteristic type.	Yes (Conditional)
	Note: If you select a predefined characteristic type, the Search (🔍) icon appears corresponding to the Characteristic Value field. On clicking the Search icon, the Predefined Characteristic Search window appears. On specifying the value for a predefined characteristic type, the description of the characteristic value appears corresponding to the Characteristic Value field.	Note: This field is required when you are defining a characteristic for the invoice request type.

2. Enter the required details in the **Characteristics** section.
3. If you want to define more than one characteristic for the invoice request type, click the **Add** (+) icon and then repeat step 2.

Note: However, if you want to remove a characteristic from the invoice request type, click the **Delete** (🗑️) icon corresponding to the characteristic.

Related Topics

For more information on...	See...
How to define a invoice request type	Defining an Invoice Request Type on page 3359
How to edit a invoice request type	Editing an Invoice Request Type on page 3365

For more information on...	See...
How to copy a invoice request type	Copying an Invoice Request Type on page 3370

Editing an Invoice Request Type

Prerequisites

To edit an invoice request type, you should have:

- Invoice request type business objects defined in the application.
- Invoice request business objects defined in the application.
- Date calculation algorithm defined using the **C1-INVREDTCA** algorithm type.
- Required To Do role assigned to the **C1-INVRA** and **C1-INVRS** To Do types in the application

Procedure

To edit an invoice request type:

1. Click the **Admin** link in the **Application** toolbar.
A list appears.
2. From the **Admin** menu, select **I** and then click **Invoice Request Type**.
A sub-menu appears.
3. Click the **Search** option from the **Invoice Request Type** sub-menu.
The **Invoice Request Type** screen appears.
4. In the **Invoice Request Type List** zone, click the **Edit**  icon in the **Edit** column corresponding to the invoice request type whose details you want to edit.

The **Invoice Request Type** screen appears. It contains the following section:

- **Main** - Used to specify basic details about the invoice request type.
- **Characteristics** - Used to define the characteristics for the offset request type.

The **Main** section contains the following fields:

Field Name	Field Description	Mandatory (Yes or No)
Invoice Request Type	Displays the invoice request type.	Not applicable
Business Object	Indicates the business object using which you are defining the invoice request type.	Not applicable
Description	Used to specify the description for the invoice request type.	Yes
Invoice Request Business Object	Used to indicate the business object using which you want to create an invoice request. The valid values are: <ul style="list-style-type: none"> • Invoice Request - Regular Bill Generation • Invoice Request - Trial Bill Generation 	Yes
Detailed Description	Used to specify additional information about the invoice request type.	No

Field Name	Field Description	Mandatory (Yes or No)
Status	Used to indicate the status of the invoice request type. The valid values are: <ul style="list-style-type: none"> • Active • Inactive 	Yes
Invoice Mode	Used to indicate the mode of the invoice request type. The valid values are: <ul style="list-style-type: none"> • Manual • Automatic 	Yes
	Note: The automatic mode is not supported while creating an invoice request type for the financial services domain.	
Bill Generation Type	Used to indicate the bill generation type, using which an invoice request should be created. The valid values are: <ul style="list-style-type: none"> • Regular • Trial 	Yes
	Note: If Automatic option is selected from the Invoice Mode list, this field is disabled, and by default, is set to Regular .	

Field Name	Field Description	Mandatory (Yes or No)
Defer Processing Billable Charge Count	<p>Used to specify the count which helps to determine whether an invoice request must be processed in the deferred mode (i.e. in the background) or in real time (i.e. immediately). If the number of billable charges created for the bills which are selected in the invoice request exceeds the defer processing billable charge count, the system processes the invoice request in the deferred mode. However, if the number of billable charges created for the bills which are selected in the invoice request does not exceed the defer processing billable charge count, the system processes the invoice request in real time (i.e. immediately).</p> <p>Note: You cannot specify a negative value in this field.</p> <p>Deferred mode means in the background when the Generic Request Periodic Monitor (C1-GENRQ) batch is invoked. You can configure the Generic Request Periodic Monitor (C1-GENRQ) batch such that it is executed at regular intervals. For more information about the Generic Request Periodic Monitor (C1-GENRQ) batch, refer to <i>Oracle Revenue Management and Billing Batch Guide</i>.</p> <p>This field appears when the Manual option is selected from the Invoice Mode list, and Regular option is selected from the Bill Generation Type list.</p> <p>If you set the defer processing billable charge count to zero (0), the system resets the default value to 500.</p>	No
Date Calculation Algorithm	<p>Used to indicate the algorithm using which the date should be calculated while adding a bill in an invoice request.</p> <p>Note: The Search  icon appears corresponding to the Date Calculation Algorithm field. On clicking the Search icon, the Algorithm Search window appears.</p> <p>On specifying the date calculation algorithm, the description of the date calculation algorithm appears corresponding to the Date Calculation Algorithm field.</p> <p>You can specify the date calculation algorithm when the Invoice Mode is selected as Automatic.</p>	Yes (Conditional) Note: This field is required when Invoice mode is Automatic .
Invoice Request Approval Required	<p>Used to indicate whether approval is required while invoicing bills through an invoice request.</p> <p>Note: This field appears when the Automatic option is selected from the Invoice Mode list.</p>	No

Field Name	Field Description	Mandatory (Yes or No)
Approval To Do Type	Used to indicate that the To Do entry of the specified To Do type must be created when an invoice request is submitted for approval.	Yes (Conditional)
	<p>Note:</p> <p>The Search (🔍) icon appears corresponding to the Approval To Do Type field. On clicking the Search icon, the To Do Type Search window appears.</p> <p>On specifying the To Do type, the description of the To Do type appears corresponding to the Approval To Do Type field.</p> <p>This field appears when the Approval Required option is selected.</p> <p>The C1-INVRA To Do type is shipped with the product. You can use the C1-INVRA To Do type or a custom To Do type, if required.</p>	<p>Note: This field is required when the Approval Required option is selected.</p>
Approval To Do Role	Used to indicate that users with the specified To Do role can only approve an invoice request which is submitted for approval.	Yes (Conditional)
	<p>Note:</p> <p>The list includes only those To Do roles which are associated with the approval To Do type.</p> <p>This field appears when the Approval Required option is selected.</p>	<p>Note: This field is required when the Approval Required option is selected.</p>
Submitter To Do Type	At present, the submitter To Do type is not used to create To Do entry when the approver rejects an offset request. It is only used to fetch the roles associated with the submitter To Do type.	Yes (Conditional)
	<p>Note:</p> <p>The Search (🔍) icon appears corresponding to the Submitter To Do Type field. On clicking the Search icon, the To Do Type Search window appears.</p> <p>On specifying the To Do type, the description of the To Do type appears corresponding to the Submitter To Do Type field.</p> <p>The C1-INVRS To Do type is shipped with the product. You can use the C1-INVRS To Do type or a custom To Do type, if required.</p>	<p>Note:</p> <p>This field is required when the Approval Required option is selected.</p>

Field Name	Field Description	Mandatory (Yes or No)
Submitter To Do Role	Used to indicate that users with the specified To Do role cannot approve an invoice request which is submitted for approval.	Yes (Conditional) Note: This field is required when the Approval Required option is selected. Once it is defined and saved, it cannot be changed as it is linked to request(s) which are under processing.
	Note: The list includes only those To Do roles which are associated with the submitter To Do type.	
Wait Days	Used to specify the maximum wait period (in days) after which the bills in an invoice request are processed.	No
	Note: You cannot specify a negative value in the Wait Days field.	

Tip: Alternatively, you can access this screen by clicking the **Edit** button in the **Invoice Request Type** zone.

5. Modify the required details in the **Main** section.
6. Define, edit, or remove characteristics of the invoice request type, if required.
7. Click **Save**.

The changes made to the invoice request type are saved.

Related Topics

For more information on...	See...
Invoice Request Type screen	Invoice Request Type on page 3355
Invoice Request Type List zone	Invoice Request Type List on page 3355
Invoice Request Type zone	Invoice Request Type on page 3356
How to define a characteristic for an invoice request type	Defining a Characteristic for an Invoice Request Type on page 3364

Deleting an Invoice Request Type

Procedure

To delete an invoice request type:

1. Click the **Admin** link in the **Application** toolbar.
A list appears.
2. From the **Admin** menu, select **I** and then click **Invoice Request Type**.
A sub-menu appears.
3. Click the **Search** option from the **Invoice Request Type** sub-menu.

The **Invoice Request Type** screen appears.

- In the **Invoice Request Type List** zone, click the **Delete** () icon in the **Delete** column corresponding to the invoice request type that you want to delete.

A message appears confirming whether you want to delete the invoice request type.

Note: You can delete an invoice request type when an invoice request is not created using the invoice request type.

Tip: Alternatively, you can delete an invoice request type by clicking the **Delete** button in the **Invoice Request Type** zone.

- Click **OK**.

The invoice request type is deleted.

Related Topics

For more information on...	See...
Invoice Request Type screen	Invoice Request Type on page 3355
Invoice Request Type List zone	Invoice Request Type List on page 3355
Invoice Request Type zone	Invoice Request Type on page 3356

Copying an Invoice Request Type

Instead of creating an invoice request type from scratch, you can create a new invoice request type using an existing invoice request type. This is possible through copying an invoice request type. On copying an invoice request type, the details including the characteristics are copied to the new invoice request type. You can then edit the details, if required.

Prerequisites

To copy an invoice request type, you should have:

- Invoice request type (whose copy you want to create) defined in the application.
- Invoice request business objects defined in the application.
- Date calculation algorithm defined using the **C1-INVREDTCA** algorithm type.
- Required To Do role assigned to the **C1-INVRA** and **C1-INVRS** To Do types in the application

Procedure

To copy an invoice request type:

- Click the **Admin** link in the **Application** toolbar.
A list appears.
- From the **Admin** menu, select **I** and then click **Invoice Request Type**.
A sub-menu appears.
- Click the **Search** option from the **Invoice Request Type** sub-menu.
The **Invoice Request Type** screen appears.
- In the **Request Type List** zone, click the **Duplicate** () icon in the **Duplicate** column corresponding to the invoice request type whose copy you want to create.

The **Invoice Request Type** screen appears. It contains the following sections:

- **Main** - Used to specify basic details about the invoice request type. It contains the following fields:

- **Characteristics** - Used to define the characteristics for the invoice request type.

Field Name	Field Description	Mandatory (Yes or No)
Invoice Request Type	Used to specify the invoice request type.	Yes
Business Object	Indicates the business object using which you are defining the invoice request type.	Not applicable
Description	Used to specify the description for the invoice request type.	Yes
Invoice Request Business Object	Used to indicate the business object using which you want to create an invoice request. The valid values are: <ul style="list-style-type: none"> • Invoice Request - Regular Bill Generation • Invoice Request - Trial Bill Generation 	Yes
Detailed Description	Used to specify additional information about the invoice request type.	No
Status	Used to indicate the status of the invoice request type. The valid values are: <ul style="list-style-type: none"> • Active • Inactive 	Yes
Invoice Mode	Used to indicate the mode of the invoice request type. The valid values are: <ul style="list-style-type: none"> • Manual • Automatic 	Yes
	Note: The automatic mode is not supported while creating an invoice request type for the financial services domain.	
Bill Generation Type	Used to indicate the bill generation type, using which an invoice request should be created. The valid values are: <ul style="list-style-type: none"> • Regular • Trial 	Yes
	Note: If Automatic option is selected from the Invoice Mode list, this field is disabled, and by default, is set to Regular .	

Field Name	Field Description	Mandatory (Yes or No)
Defer Processing Billable Charge Count	<p>Used to specify the count which helps to determine whether an invoice request must be processed in the deferred mode (i.e. in the background) or in real time (i.e. immediately). If the number of billable charges created for the bills which are selected in the invoice request exceeds the defer processing billable charge count, the system processes the invoice request in the deferred mode. However, if the number of billable charges created for the bills which are selected in the invoice request does not exceed the defer processing billable charge count, the system processes the invoice request in real time (i.e. immediately).</p> <p>Note: You cannot specify a negative value in this field.</p> <p>Deferred mode means in the background when the Generic Request Periodic Monitor (C1-GENRQ) batch is invoked. You can configure the Generic Request Periodic Monitor (C1-GENRQ) batch such that it is executed at regular intervals. For more information about the Generic Request Periodic Monitor (C1-GENRQ) batch, refer to <i>Oracle Revenue Management and Billing Batch Guide</i>.</p> <p>This field appears when the Manual option is selected from the Invoice Mode list, and Regular option is selected from the Bill Generation Type list.</p> <p>If you set the defer processing billable charge count to zero (0), the system resets the default value to 500.</p>	No
Date Calculation Algorithm	<p>Used to indicate the algorithm using which the date should be calculated while adding a bill in an invoice request.</p> <p>Note: The Search  icon appears corresponding to the Date Calculation Algorithm field. On clicking the Search icon, the Algorithm Search window appears.</p> <p>On specifying the date calculation algorithm, the description of the date calculation algorithm appears corresponding to the Date Calculation Algorithm field.</p> <p>You can specify the date calculation algorithm when the Invoice Mode is selected as Automatic.</p>	Yes (Conditional) Note: This field is required when Invoice mode is Automatic .
Invoice Request Approval Required	<p>Used to indicate whether approval is required while invoicing bills through an invoice request.</p> <p>Note: This field appears when the Automatic option is selected from the Invoice Mode list.</p>	No

Field Name	Field Description	Mandatory (Yes or No)
Approval To Do Type	Used to indicate that the To Do entry of the specified To Do type must be created when an invoice request is submitted for approval.	Yes (Conditional)
	<p>Note:</p> <p>The Search (🔍) icon appears corresponding to the Approval To Do Type field. On clicking the Search icon, the To Do Type Search window appears.</p> <p>On specifying the To Do type, the description of the To Do type appears corresponding to the Approval To Do Type field.</p> <p>This field appears when the Approval Required option is selected.</p> <p>The C1-INVRA To Do type is shipped with the product. You can use the C1-INVRA To Do type or a custom To Do type, if required.</p>	<p>Note: This field is required when the Approval Required option is selected.</p>
Approval To Do Role	Used to indicate that users with the specified To Do role can only approve an invoice request which is submitted for approval.	Yes (Conditional)
	<p>Note:</p> <p>The list includes only those To Do roles which are associated with the approval To Do type.</p> <p>This field appears when the Approval Required option is selected.</p>	<p>Note: This field is required when the Approval Required option is selected.</p>
Submitter To Do Type	Used to indicate the submitter To Do type. At present, the submitter To Do type is not used to create To Do entry when the approver rejects an offset request. It is only used to fetch the roles associated with the submitter To Do type.	Yes (Conditional)
	<p>Note:</p> <p>The Search (🔍) icon appears corresponding to the Submitter To Do Type field. On clicking the Search icon, the To Do Type Search window appears.</p> <p>On specifying the To Do type, the description of the To Do type appears corresponding to the Submitter To Do Type field.</p> <p>The C1-INVRS To Do type is shipped with the product. You can use the C1-INVRS To Do type or a custom To Do type, if required.</p>	<p>Note:</p> <p>This field is required when the Approval Required option is selected.</p>

Field Name	Field Description	Mandatory (Yes or No)
Submitter To Do Role	Used to indicate that users with the specified To Do role cannot approve an invoice request which is submitted for approval.	Yes (Conditional) Note: This field is required when the Approval Required option is selected. Once it is defined and saved, it cannot be changed as it is linked to request(s) which are under processing.
	Note: The list includes only those To Do roles which are associated with the submitter To Do type.	
Wait Days	Used to indicate the threshold days before which no other invoice request for any bill generation process will be initiated.	No
	Note: By default, the value displayed for wait days is 0 .	

Tip: Alternatively, you can copy an invoice request type by clicking the **Duplicate** button in the **Invoice Request Type** zone.

- Enter the required details in the **Main** section.
- Define, edit, or remove characteristics of the invoice request type, if required.
- Click **Save**.

The new invoice request type is defined.

Related Topics

For more information on...	See...
Invoice Request Type screen	Invoice Request Type on page 3355
Invoice Request Type List zone	Invoice Request Type List on page 3355
Invoice Request Type zone	Invoice Request Type on page 3356
How to define a characteristic for an invoice request type	Defining a Characteristic for an Invoice Request Type on page 3364

Viewing the Invoice Request Type Details

Procedure

To view the details of an invoice request type:

- Click the **Admin** link in the **Application** toolbar.
A list appears.
- From the **Admin** menu, select **I** and then click **Invoice Request Type**.
A sub-menu appears.
- Click the **Search** option from the **Invoice Request Type** sub-menu.

The **Invoice Request Type** screen appears.

4. In the **Invoice Request Type List** zone, click the **Broadcast** () icon corresponding to the invoice request type whose details you want to view.
The **Invoice Request Type** zone appears.

5. View the details of the invoice request type in the **Invoice Request Type** zone.

Related Topics

For more information on...	See...
Invoice Request Type screen	Invoice Request Type on page 3355
Invoice Request Type List zone	Invoice Request Type List on page 3355
Invoice Request Type zone	Invoice Request Type on page 3356

Invoice Request (Used for Searching)

The **Invoice Request** screen allows you to search for an invoice request using various search criteria. It also allows you to define an invoice request. It contains the following zone:

- [Search Invoice Request](#) on page 3375

Through this screen, you can navigate to the following screen:



- [Invoice Request \(Used for Viewing\)](#) on page 3382

Search Invoice Request

The **Search Invoice Request** zone allows you to search for an invoice request using various search criteria. It contains the following two sections:

- **Search Criteria** - The **Search Criteria** section contains the following fields:

Field Name	Field Description	Mandatory (Yes or No)
Search By	Used to indicate whether you want to search for an invoice request using the invoice request or bill details. The valid values are: <ul style="list-style-type: none"> • Invoice Requests for Accounts • Invoice Requests for Persons <p>Note: By default, the Invoice Requests for Accounts option is selected.</p>	Yes
Invoice Request ID	Used to search a particular invoice request.	No
Created From	Used to search invoice requests which are created from a particular date onwards.	No
Created To	Used to search invoice requests which are created till a particular date.	No
Cutoff From	Used to indicate the date from when the billable charges are considered for processing the invoice request.	No

Field Name	Field Description	Mandatory (Yes or No)
Cutoff To	Used to indicate the date till when the billable charges are considered for processing the invoice request.	No
Invoice Request Type	Used to search invoice requests which are created using a particular invoice request type.	No
Status	Used to search invoice requests with a particular status. The valid values are: <ul style="list-style-type: none"> Account Derivation Pending Approved Approval In Progress Canceled Deferred Processing Deferred Processing Batch Draft Error Processed Rejected 	No
Person ID	Used to search invoice requests which include bills of a particular person. Note: The Search  icon appears corresponding to Person ID field. On clicking the Search icon, the Person Search window appears.	No
Account ID	Used to search invoice requests which include bills of a particular account. Note: The Search  icon appears corresponding to this field. On clicking the Search icon, the Account Search window appears.	No
Bill Generation Type	Used to indicate the bill generation type. The valid values are: <ul style="list-style-type: none"> Regular Trial Note: This field appears when the Invoice Requests for Accounts option is selected from the Search By list.	No

Field Name	Field Description	Mandatory (Yes or No)
External Reference Type	Used to indicate the external reference type. The valid value is: <ul style="list-style-type: none"> Policy 	No
	Note: This is a read-only field. This field is populated when the invoice request is created with the invoice mode option as Automatic .	
External Reference ID	Used to specify the external reference ID of the invoice request.	No
	Note: The Search  icon appears corresponding to the External Reference ID field. On clicking the Search icon, the Policy Search window appears.	

Note: You must specify at least one search criterion while searching for an invoice request.

- **Search Results** - On clicking the **Search** button, the search results appear based on the specified search criteria. The **Search Results** section contains the following columns:

Column Name	Column Description
Creation Date Time	Displays the date and time when the invoice request is created.
Invoice Request Information	Displays information about the invoice request.
	Note: It has a link. On clicking the link, the Invoice Request screen appears where you can view the details of the respective invoice request.
Created By	Indicates the user who has created the invoice request.
Cutoff Date	Displays the date till when all the billable charges are considered for processing the invoice request.
Account Information	Displays information about the account. In addition, this column has a context menu which helps in navigating to other screens in the application.
	Note: It has a link. On clicking the link, the Account screen appears where you can view the details of the respective account. This column appears when the Invoice Requests for Accounts option is selected from the Search By list.

Column Name	Column Description						
Person Information	<p>Displays additional information about the person. In addition, this column has a context menu which helps in navigating to other screens in the application.</p> <p>Note:</p> <p>It has a link. On clicking the link, the Person screen appears with the details of the respective person.</p> <p>This column appears when the Invoice Requests for Persons option is selected from the Search By list.</p>						
Status	<p>Indicates the status of the invoice request. The valid values are:</p> <ul style="list-style-type: none"> • Account Derivation Pending • Approved • Approval In Progress • Canceled • Deferred Processing • Deferred Processing - Batch • Draft • Error • Processed • Rejected 						
Bill Information	<p>Displays information about the bill.</p> <p>Note:</p> <table border="1" data-bbox="602 1192 1463 1598"> <thead> <tr> <th data-bbox="602 1192 1008 1245">If you select ...</th> <th data-bbox="1008 1192 1463 1245">Then...</th> </tr> </thead> <tbody> <tr> <td data-bbox="602 1245 1008 1451"> Invoice Requests for Account option from the Search By list and Regular option from the Bill Generation Type list. </td> <td data-bbox="1008 1245 1463 1451"> This column has a link. On clicking the link, the Bill screen appears where you can view the details of the respective bill. In addition this column has a context menu which helps in navigating to other screens in the application. </td> </tr> <tr> <td data-bbox="602 1451 1008 1598"> Invoice Requests for Account option from the Search By list and Trial option from the Bill Generation Type list. </td> <td data-bbox="1008 1451 1463 1598"> This column has a link. On clicking the link, the Trial Bill screen appears where you can view the details of the respective trial bill. </td> </tr> </tbody> </table> <p>By default, this column has a content menu which helps in navigating to other screens in the application.</p> <p>This column appears when the Invoice Requests for Accounts option is selected from the Search By list.</p>	If you select ...	Then...	Invoice Requests for Account option from the Search By list and Regular option from the Bill Generation Type list.	This column has a link. On clicking the link, the Bill screen appears where you can view the details of the respective bill. In addition this column has a context menu which helps in navigating to other screens in the application.	Invoice Requests for Account option from the Search By list and Trial option from the Bill Generation Type list.	This column has a link. On clicking the link, the Trial Bill screen appears where you can view the details of the respective trial bill.
If you select ...	Then...						
Invoice Requests for Account option from the Search By list and Regular option from the Bill Generation Type list.	This column has a link. On clicking the link, the Bill screen appears where you can view the details of the respective bill. In addition this column has a context menu which helps in navigating to other screens in the application.						
Invoice Requests for Account option from the Search By list and Trial option from the Bill Generation Type list.	This column has a link. On clicking the link, the Trial Bill screen appears where you can view the details of the respective trial bill.						

Column Name	Column Description
Error Message	Displays the error message indicating the error that occurred while processing the bills in the invoice request.
	Note: This column appears when the Invoice Requests for Accounts option is selected from the Search By list.
Bill Generation Type	Indicates the bill generation type. The valid values are: <ul style="list-style-type: none"> • Regular • Trial
	Note: This column appears when the Invoice Requests for Accounts option is selected from the Search By list.

Note: Pagination is used to display limited number of records in the **Search Results** section. You can use the navigation links, such as **Previous** and **Next** to navigate between pages.

Related Topics

For more information on...	See...
How to search for an invoice request	Searching for an Invoice Request on page 3379

Searching for an Invoice Request

Prerequisites

To search for an invoice request, you should have:

- Invoice request types defined in the application

Procedure

To search for an invoice request:

1. Click the **Menu** link in the **Application** toolbar.
A list appears.
2. From the **Main** menu, select **Billing Management** and then click **Invoice Request**.
A sub-menu appears.
3. Click the **Search** option from the **Invoice Request** sub-menu.
The **Invoice Request** screen appears.
4. Enter the search criteria in the **Search Invoice Request** zone.

Note: ORMB search engine supports wildcard search, where you can substitute the percentage (%) symbol as a stand in for any word or letter in a search criteria. You can use the ‘%’ wildcard character in all input fields except the date and ID fields. The ‘%’ wildcard character is suffixed automatically at the end of the partial search criteria. Therefore, you may or may not specify the wildcard character at the end of the partial search criteria. However, you have to prefix the wildcard character manually wherever required.

5. Click **Search**.

A list of invoice requests that meet the search criteria appears in the **Search Results** section.

Related Topics

For more information on...	See...
Invoice Request screen	<i>Invoice Request (Used for Searching)</i> on page 3375
Search Invoice Request zone	<i>Search Invoice Request</i> on page 3375

Manually Creating an Invoice Request

Prerequisites

To create an invoice request, you should have:

- Invoice request types defined in the application
- Bills created in the application
- Account and Person entity defined in the application

Procedure

To create an invoice request:

1. Click the **Menu** link in the **Application** toolbar.
A list appears.
2. From the **Main** menu, select **Billing Management** and then click **Invoice Request**.
A sub-menu appears.
3. Click the **Add** option from the **Invoice Request** sub-menu.

The **Add Invoice Request** window appears. It contains the following field:

Field Name	Field Description	Mandatory (Yes or No)
Invoice Request Type	Used to indicate the invoice request type using which you want to create the invoice request.	Yes

Tip: Alternatively, you can access this window by clicking the **Add** button in the **Page Title** area of the **Invoice Request** screen.

4. Select the required invoice request type from the **Invoice Request Type** list.
5. Click **OK**.

The **Invoice Request** screen appears. It contains the following sections:

- **Main** - Used to specify basic details about the invoice request.
- **Characteristics** - Used to define the characteristics for the invoice request.

The **Main** section contains the following fields:

Field Name	Field Description	Mandatory (Yes or No)
Invoice Request Type	Indicates the invoice request type using which the invoice request is created.	Not applicable

Field Name	Field Description	Mandatory (Yes or No)
Entity	Used to indicate the entity using which you want to create an invoice request. The valid values are: <ul style="list-style-type: none"> Account Person <p>Note: By default, the Account option is selected.</p>	Not applicable
Account ID	Used to indicate the account for which you want to create an invoice request. <p>Note: The Search (🔍) icon appears corresponding to the Account ID field. On clicking the Search icon, the Account Search window appears.</p>	Yes
Person ID	Used to indicate the person for whom the invoice request is generated. <p>Note: The Search (🔍) icon appears corresponding to Person ID field. On clicking the Search icon, the Person Search window appears.</p>	Yes
Cutoff Date	Used to specify the date till when the billable charges are considered for processing the invoice request. <p>Note: By default, the current date appears in this field.</p>	No
Accounting Date	Used to specify the accounting date of the bill. <p>Note: By default, the current date appears in this field.</p>	No
Bill Date	Used to specify the processing date on which the bill is completed. <p>Note: The bill date cannot be on or earlier than the last bill date of the account. By default, the current date appears in this field.</p>	No
Comments	Used to specify additional information about the invoice request.	No

- Enter the required details in the **Main** section.
- Define characteristics for the invoice request, if required.
- Click **Save**

The invoice request is created in the **Draft** status, and the status of all the records (in the invoice request) is set to **Pending**.

Related Topics

For more information on...	See...
Invoice Request screen	Invoice Request (Used for Searching) on page 3375
How to define a characteristic for an invoice request	Defining a Characteristic for an Invoice Request on page 3390

Viewing the Invoice Request Details

Procedure

To view the details of an invoice request:

1. Search for the invoice request in the **Invoice Request Search** screen.
2. In the **Search Results** section, click the link in the **Invoice Request Information** column corresponding to the invoice request whose details you want to view.

The **Invoice Request** screen appears.

3. Ensure that the **Main** tab is selected.
4. View the details of the invoice request in the **Invoice Request** zone.

Related Topics

For more information on...	See...
How to search for an invoice request	Invoice Request (Used for Searching) on page 3375
Invoice Request screen	Invoice Request (Used for Viewing) on page 3382
Invoice Request zone	Invoice Request on page 3383

Invoice Request (Used for Viewing)

The **Invoice Request** screen allows you to:

- View the details of the invoice request
- Edit the details of the invoice request
- Delete the invoice request
- Submit the invoice request for processing
- Approve or reject the invoice request
- Cancel the invoice request
- View the log of the invoice request
- Add a log entry for the invoice request

It consists of the following tabs:

- [Invoice Request - Main](#) on page 3382
- [Invoice Request - Log](#) on page 3387

Invoice Request - Main

The **Main** tab displays information about the invoice request. It contains the following zones:

- [Invoice Request](#) on page 3383

- [Invoice Request Details/Account List](#) on page 3386

Invoice Request

The **Invoice Request** zone displays the details of the invoice request. It contains the following sections:

- **Main** - Displays basic information about the invoice request. It contains the following fields:

Field Name	Field Description
Invoice Request Information	Displays information about the invoice request.
Invoice Request Type	Indicates the invoice request type using which the invoice request is created. Note: It has a link. On clicking the link, the Invoice Request Type screen appears where you can view the details of the respective invoice request type.
Entity	Indicates the entity using which an invoice request is created.
Account Information	Indicates the account using which an invoice request is created. Note: It has a link. On clicking the link, the Account screen appears where you can view the details of the respective account.
Cutoff Date	Indicates the date till when the billable charges are considered for processing the invoice request. Note: This field is applicable only for Entity Type as Account .
Accounting Date	Indicates the accounting date for which the financial transaction of the bill is created.
Bill Date	Indicates the date when the bill is completed. Note: The bill date must not be equal to or earlier than the last bill date of the account for which the invoice request is generated.
Processing Date	Indicates the date when the invoice request is processed. Note: Processing Date = Invoice Request Creation Date + Wait Day + Work Days

Field Name	Field Description
Status	<p>Indicates the status of the invoice request. The valid values are:</p> <ul style="list-style-type: none"> • Draft • Account Derivation Pending • Submitted • Approval In Progress • Approved • Deferred Processing • Deferred Processing - Batch • Rejected • Cancelled • Error • Processing • Processed • Return to Submitter
Status Reason	<p>Indicates the reason why the status of the invoice request is changed.</p> <p>Note: It has a link. On clicking the link, the Status Reason screen appears where you can view the details of the respective status.</p>

- **Characteristics** - Lists the characteristics defined for the invoice request. It contains the following columns:

Column Name	Column Description
Effective Date	Displays the date from when the characteristic is effective for the invoice request.
Characteristic Type	Indicates the characteristic type.
Characteristic Value	Displays the value of the characteristic type.

- **Record Actions** - This section contains the following buttons:

Button Name	Button Description
Edit	<p>Used to edit the details of the invoice request.</p> <p>Note: The Edit button appears when the invoice request is in the Draft status.</p>
Delete	<p>Used to delete the invoice request.</p> <p>Note: The Delete button appears when the invoice request is in the Draft status.</p>
Submit	<p>Used to submit the invoice request.</p> <p>Note: The Submit button appears when the invoice request is in the Draft status.</p>

Button Name	Button Description
Cancel	Used to cancel the invoice request.
	Note: The Cancel button appears when the invoice request is in the Deferred Processing Batch status.
Approve	Used to approve the invoice request.
	Note: The Approve button appears when: <ul style="list-style-type: none"> The invoice request is in the Approval In Progress status. A user with the approval To Do role is reviewing the invoice request.
Reject	Used to reject the invoice request.
	Note: The Reject button appears when: <ul style="list-style-type: none"> The invoice request is in the Approval In Progress status. A user with the approval To Do role is reviewing the invoice request.
Re Submit	Used to request for resubmitting the invoice request.
	Note: The Re Submit button appears when: <ul style="list-style-type: none"> The invoice request is in the Approval In Progress status. A user with the approval To Do role is reviewing the invoice request.

- **Record Information** - This section contains the following fields:

Field Name	Field Description
Business Object	Indicates the business object using which the invoice request is created. In addition, a context menu appears corresponding to this field which helps in navigating to other screens in the application.
	Note: It has a link. On clicking the link, the Business Object screen appears where you can view the details of the respective business object.
Status Date/Time	Displays the date and time when the invoice request status is updated.
Create Date/Time	Displays the date and time when the invoice request is created.

- **External Reference** - Lists the external references defined for the invoice request. This section contains the following columns:

Note: This section appears when the invoice request is in the **Deferred Processing Batch** or **Canceled** status.

Column Name	Column Description
External Reference Type	Indicates the external reference type of the invoice request.
External Reference Information	Displays additional information about the external reference type.
	Note: It has a link. On clicking the link, the Policy screen appears with the details of the respective policy.

Related Topics

For more information on...	See...
How to edit an invoice request	Editing an Invoice Request on page 3388
How to delete an invoice request	Deleting an Invoice Request on page 3391
How to submit an invoice request	Submitting an Invoice Request on page 3393
How to cancel an invoice request	Canceling an Invoice Request on page 3392
How to approve an invoice request	Approving an Invoice Request on page 3394
How to reject an invoice request	Rejecting an Invoice Request on page 3395
How to request for resubmitting an invoice request	Requesting to Resubmit an Invoice Request on page 3396

Invoice Request Details/Account List

The **Invoice Request Details/Account List** zone lists the bills or the accounts which are added to the invoice request. It contains the following columns:

Column Name	Column Description
Account Information	Indicates the account for which the invoice request is created. In addition, this column has a context menu which helps in navigating to other screens in the application. Note: It has a link. On clicking the link, the Account screen appears where you can view the details of the respective account.
Person Information	Indicates the person for which the invoice request is created. In addition, this column has a context menu which helps in navigating to other screens in the application. Note: It has a link. On clicking the link, the Person screen appears where you can view the details of the respective person.
Record Status	Indicates the status of the bills in the invoice request. The valid values are: <ul style="list-style-type: none"> • Pending • Error • Processing
Bill Information	Indicates the bill which is added to the invoice request. In addition, this column has a context menu which helps in navigating to other screens in the application. Note: It has a link. On clicking the link, the Bill screen appears where you can view the details of the respective bill.
Error Message	Displays the error message indicating the error that occurred while processing the bills in the invoice request.
Recent Billed Date	Displays the date of the bill that has been recently processed from the invoice request.

A check box appears corresponding to each account. On selecting the check box, and clicking the **Exclude** button, you can exclude the account from the invoice request. You can also select multiple accounts at the same time. In addition, you can select the check box corresponding to the column header. This allows you to exclude all accounts listed in the respective page from the invoice request.

Note:

Pagination is used to display limited number of records in this zone. You can use the navigation links, such as **Previous** and **Next** to navigate between pages.

The **Filter** icon appears when the zone is **Account List**.

You can filter the list using various search criteria (such as, **Record Status**, **Account ID**, and **Person ID**) available in the **Filter** area. By default, the **Filter** area is hidden. You can view the **Filter** area by clicking the **Filters** (🔍) icon in the upper right corner of this zone.

Excluded Accounts

The **Excluded Accounts** zone lists the accounts which are excluded from the invoice request. It appears when **Invoice Requests for Persons** option is selected from the **Search By list** in the **Search Invoice Request** zone. It contains the following columns:

Column Name	Column Description
Account Information	Indicates the account for which the invoice request is created. In addition, this column has a context menu which helps in navigating to other screens in the application.
	Note: It has a link. On clicking the link, the Account screen appears where you can view the details of the respective account.
Person Information	Indicates the person for which the invoice request is created. In addition, this column has a context menu which helps in navigating to other screens in the application.
	Note: It has a link. On clicking the link, the Person screen appears where you can view the details of the respective person.

A check box appears corresponding to each account. On selecting the check box, and clicking the **Include** button, you can include the account to the invoice request. You can also select multiple accounts at the same time. In addition, you can select the check box corresponding to the column header. This allows you to add all accounts listed in the respective page to the invoice request.

Note:

Pagination is used to display limited number of records in this zone. You can use the navigation links, such as **Previous** and **Next** to navigate between pages.

The **Filter** icon appears when the zone is **Account List**.

You can filter the list using various search criteria (such as, **Record Status**, **Account ID**, and **Person ID**) available in the **Filter** area. By default, the **Filter** area is hidden. You can view the **Filter** area by clicking the **Filters** (🔍) icon in the upper right corner of this zone.

Invoice Request - Log

The **Log** tab contains the following zone:

- [Invoice Request Log](#) on page 3387

Invoice Request Log

The **Invoice Request Log** zone lists the complete trail of actions performed on the invoice request. It contains the following columns:

Column Name	Column Description
Creation Date/Time	Displays the date and time when the action was performed on the invoice request.
Details	Displays the details of the action performed on the invoice request.
User	Indicates the user who has performed the action on the invoice request.
Log Type	Indicates the type of log.
Related Object	Indicates the object or entity which is created when the action is performed on the invoice request.
	Note: At present, no data appears in this column. The implementation team can build the custom logic to meet the business requirements.
Status Reason	Indicates the reason why the invoice request was rejected by the approver.
	Note: The data appears in this column when the invoice request is in the Rejected status.

Note: You can manually add a log entry for the invoice request by clicking the **Add Log Entry** link in the upper right corner of the **Invoice Request Log** zone.

Related Topics

For more information on...	See...
How to view the log of a invoice request	Viewing the Log of an Invoice Request on page 3398
How to add a log entry for an invoice request	Adding a Log Entry for an Invoice Request on page 3398

Editing an Invoice Request

Prerequisites

To edit an invoice request, you should have:

- Invoice request types defined in the application
- Bills created in the application
- Account and Person entity defined in the application

Procedure

To edit an invoice request:

1. Search for the invoice request in the **Invoice Request** screen.
2. In the **Search Results** section, click the link in the **Invoice Request Information** column corresponding to the invoice request whose details you want to edit.

The **Invoice Request** screen appears.

3. Click the **Edit** button in the **Invoice Request** zone.

The **Edit Invoice Request** screen appears. It contains the following sections:

- **Main** - Used to specify basic details about the invoice request.
- **Characteristics** - Used to define the characteristics for the invoice request.

The **Main** section contains the following fields:

Field Name	Field Description	Mandatory (Yes or No)
Invoice Request Information	Displays information about the invoice request.	Not applicable
Invoice Request Type	Indicates the invoice request type using which the invoice request is created.	Not applicable
Entity	Used to indicate the entity using which you want to edit an invoice request. The valid values are: <ul style="list-style-type: none"> Account Person 	Not applicable
	Note: This field is in the read-only mode.	
Account ID	Used to indicate the account using which you want to edit an invoice request.	Yes
	Note: The Search (🔍) icon appears corresponding to the Account ID field. On clicking the Search icon, the Account Search window appears.	
Cutoff Date	Used to specify the date till when the billable charges are considered for processing the invoice request.	No
	Note: If the cutoff date is not mentioned, the system considers current date as the cutoff date.	
Accounting Date	Used to specify the accounting date of the bill.	No
	Note: If the accounting date is not mentioned, the system considers current date as the accounting date.	
Bill Date	Used to specify the processing date on which the bill is completed.	No
	Note: The bill date cannot be on or earlier than the last bill date of the account. If the bill date is not mentioned, the system considers current date as the bill date.	
Comments	Used to specify additional information about the invoice request.	No

Note: The **Edit** button appears when the invoice request is in the **Draft** status.

4. Modify the details of the invoice request, if required.

5. Define, edit, or remove characteristics of the invoice request, if required.
6. Click **Save**.

The changes made to the invoice request are saved.

Related Topics

For more information on...	See...
How to search for an invoice request	Searching for an Invoice Request on page 3379
Invoice Request screen	Invoice Request (Used for Viewing) on page 3382
Invoice Request zone	Invoice Request on page 3383
How to define a characteristic for an invoice request	Defining a Characteristic for an Invoice Request on page 3390

Defining a Characteristic for an Invoice Request

Prerequisites

To define a characteristic for an invoice request, you should have:

- Characteristic types defined in the application (where the characteristic entity is set to **Invoice Request**)

Procedure

To define a characteristic for an invoice request:

1. Ensure that the **Characteristics** section is expanded when you are defining, editing, or copying an invoice request type.

The **Characteristics** section contains the following fields in a grid:

Field Name	Field Description	Mandatory (Yes or No)
Effective Date	Used to specify the date from when the characteristic is effective for the invoice request.	Yes (Conditional)
		Note: This field is required when you are defining a characteristic for the invoice request.
Characteristic Type	Used to indicate the characteristic type.	Yes (Conditional)
		Note: The list includes only those characteristic types where the characteristic entity is set to Invoice Request .
		Note: This field is required when you are defining a characteristic for the invoice request.

Field Name	Field Description	Mandatory (Yes or No)
Characteristic Value	Used to specify the value for the characteristic type.	Yes (Conditional)
	<p>Note:</p> <p>If you select a predefined characteristic type, the Search (🔍) icon appears corresponding to the Characteristic Value field. On clicking the Search icon, you can search for a predefined characteristic value.</p> <p>On specifying the value for a predefined characteristic type, the description of the characteristic value appears corresponding to the Characteristic Value field.</p>	<p>Note: This field is required when you are defining a characteristic for the invoice request.</p>

- Enter the required details in the **Characteristics** section.
- If you want to define more than one characteristic for the invoice request, click the **Add** (+) icon and then repeat step 2.

Note: However, if you want to remove a characteristic from the invoice request, click the **Delete** (🗑️) icon corresponding to the characteristic.

- Click **Save**.

The characteristics are defined for the invoice request.

Related Topics

For more information on...	See...
How to edit an invoice request	Editing an Invoice Request on page 3388

Deleting an Invoice Request

Procedure

To delete an invoice request:

- Search for the invoice request in the **Search Invoice Request** screen.
- In the **Search Results** section, click the link in the **Invoice Request Information** column corresponding to the invoice request that you want to delete.

The **Invoice Request** screen appears.

- Click the **Delete** button in the **Invoice Request** zone.

A message appears confirming whether you want to delete the invoice request.

Note: The **Delete** button appears when the invoice request is in the **Draft** status.

- Click **OK**.

The invoice request is deleted.

Related Topics

For more information on...	See...
How to search for an invoice request	Searching for an Invoice Request on page 3379
Invoice Request screen	Invoice Request (Used for Viewing) on page 3382
Invoice Request zone	Invoice Request on page 3383

Canceling an Invoice Request

Prerequisites

To cancel an invoice request, you should have:

- Reasons defined for the **Canceled** status of the **C1-InvoiceRequest** business object in the **Status Reason** screen

Procedure

To cancel an invoice request:

- Search for the invoice request in the **Search Invoice Request** screen.
- In the **Search Results** section, click the link in the **Invoice Request Information** column corresponding to the invoice request that you want to cancel.

The **Invoice Request** screen appears.

- Click the **Cancel** button in the **Invoice Request** zone.

The **Invoice Request** window appears. It contains the following field:

Field Name	Field Description	Mandatory (Yes or No)
Status Reason	Used to indicate the reason why you want to cancel the invoice request. Note: The list includes only those reasons which are defined for the Canceled status of the C1-InvoiceRequest business object in the Status Reason screen.	Yes

Note: The **Cancel** button appears when the invoice request is in the **Deferred Processing** or **Deferred Processing - Batch** status.

- Select the reason for canceling the invoice request from the **Status Reason** list.
- Click **Save**.

The status of the invoice request (along with the bills within the invoice request) is changed to **Canceled**.

Related Topics

For more information on...	See...
How to search for an invoice request	Searching for an Invoice Request on page 3379
Invoice Request screen	Invoice Request (Used for Viewing) on page 3382
Invoice Request zone	Invoice Request on page 3383

Submitting an Invoice Request

Prerequisites

To submit an invoice request, you should have:

- The status of the invoice request in the **Draft** status.
- The invoice request type as **Manual**.

Procedure

To submit an invoice request:

1. Search for the invoice request in the **Search Invoice Request** screen.
2. In the **Search Results** section, click the link in the **Invoice Request Information** column corresponding to the invoice request that you want to submit.

The **Invoice Request** screen appears.

3. Click the **Submit** button in the **Invoice Request** zone.

The system behaves in the following manner:

If...	Then...
The Approval Required option is selected in the respective invoice request type	The status of the invoice request is changed to Approval In Progress . In this status, you can perform various actions on the invoice request, such as, Approve or Reject or Return To Submitter . If the approver clicks the Approve button, the status of the invoice request is changed to Approval In Progress . If the approver clicks the Reject button, the status of the invoice request is changed to Rejected . If the approver clicks the Return To Submitter button, a To Do is generated and the invoice request is changed to Draft . The submitter updates the invoice request and redirects it back to the approver for approval purposes.
The Approval Required option is not selected in the respective invoice request type and the entity type is Person	The status of the invoice request is changed to Processed , or Deferred Processing or Deferred Processing - Batch .
The Approval Required option is not selected in the respective invoice request type, and the entity type is Account , and the billable charge count exceeds the defer processing billable charge count	The status of the invoice request is changed to Deferred Processing - Batch .
The Approval Required option is not selected in the respective invoice request type, and the entity type is Account , and the billable charge count does not exceed the defer processing billable charge count, and the invoice processing date does not exceed the system date	The status of the invoice request is changed to Processed else it is changed to Defer Processing .

Note:

The **Submit** button appears when the invoice request is in the **Draft** status and invoice request type is **Manual**.

Related Topics

For more information on...	See...
How to search for an invoice request	Searching for an Invoice Request on page 3379
Invoice Request screen	Invoice Request (Used for Viewing) on page 3382
Invoice Request zone	Invoice Request on page 3383

Approving an Invoice Request

You can view the number of invoice requests which are pending for approval in the **Invoice Request** screen. The approver can review, and accordingly approve, reject, or ask the submitter to resubmit the invoice request based on the observations.

Note: The system will not allow you to approve, reject, or resubmit an invoice request submitted by you.

Prerequisites

To approve an invoice request, you should have:

- Approval To Do role assigned in the system

Procedure

To approve an invoice request:

1. Do either of the following:

If you want to...	Then...
Approve an invoice request through the Invoice Request screen	<ol style="list-style-type: none"> 1. Search for the invoice request in the Invoice Request screen. 2. In the Search Results section, click the link in the Invoice Request Information column corresponding to the invoice request which you want to review.
Approve an Invoice request from the To Do List screen	<ol style="list-style-type: none"> 1. Click the Menu link in the Application toolbar. A list appears. 2. From the Main menu, select To Do and then click To Do List. The To Do Type for User Search window appears. 3. Enter C1-INVRATODO in the To Do Type field. 4. Click the Search button corresponding to the To Do Type field. The To Do List screen appears. 5. Select the Open option from the Filter by list to view all unassigned To Dos. 6. Click the link in the Message column corresponding to the To Do of the invoice request that you want to review.

The **Invoice Request** screen appears.

2. Review the details in the **Invoice Request** screen.
3. If the information in the invoice request is accurate, then click the **Approve** button in the **Invoice Request** zone.

The system behaves in the following manner:

If...	Then...
The status of the invoice request is changed to Approved	A To Do entry is created using the To Do type F1-TODOCOMPL specified in the approval profile and is assigned back to the submitter to complete the invoice request.

Note: The **Approve** button appears when:

- The invoice request is in the **Approval In Progress** status.
- A user with the approval To Do role is reviewing the invoice request.

Related Topics

For more information on...	See...
How to search for an invoice request	Searching for an Invoice Request on page 3379
Invoice Request screen	Invoice Request (Used for Viewing) on page 3382
Invoice Request zone	Invoice Request on page 3383

Rejecting an Invoice Request

Prerequisites

To reject an invoice request, you should have:

- Reasons defined for the **Rejected** status of the **C1-InvoiceRequest** business object in the **Status Reason** screen.

Note: The system will not allow you to approve, reject, or resubmit an invoice request submitted by you.

Procedure

To reject an invoice request:

1. Do either of the following:

If you want to...	Then...
Reject an invoice request through the Invoice Request screen	<ol style="list-style-type: none"> 1. Search for the invoice request in the Invoice Request screen. 2. In the Search Results section, click the link in the Invoice Request Information column corresponding to the invoice request which you want to review.
Reject an invoice request from the To Do List screen	<ol style="list-style-type: none"> 1. Click the Menu link in the Application toolbar. A list appears. 2. From the Main menu, select To Do and then click To Do List. The To Do Type for User Search window appears. 3. Enter C1-INVRATODO in the To Do Type field. 4. Click the Search button corresponding to the To Do Type field.

If you want to...	Then...
	<p>The To Do List screen appears.</p> <ol style="list-style-type: none"> 5. Select the Open option from the Filter by list to view all unassigned To Dos. 6. Click the link in the Message column corresponding to the To Do of the invoice request that you want to review.

The **Invoice Request** screen appears.

2. Review the details in the **Invoice Request** screen.
3. If the information in the invoice request is incorrect, then click the **Reject** button in the **Invoice Request** zone.

The **Reject Invoice Request** window appears. It contains following fields:

Field Name	Field Description	Mandatory (Yes or No)
Status Reason	Used to indicate the reason why you want to reject the invoice request. Note: The list includes only those reasons which are defined for the Rejected status of the C1-InvoiceRequest business object in the Status Reason screen.	Yes
Comments	Used to specify additional information while rejecting the invoice request.	No

Note: The **Reject** button appears when:

- The invoice request is in the **Approval In Progress** status.
- A user with the approval To Do role is reviewing the invoice request.

4. Select the reason for rejecting the invoice request from the **Status Reason** list.
5. Click **Save**.

The status of the invoice request is changed to **Rejected**.

Related Topics

For more information on...	See...
How to search for an invoice request	Searching for an Invoice Request on page 3379
Invoice Request screen	Invoice Request (Used for Viewing) on page 3382
Invoice Request zone	Invoice Request on page 3383

Requesting to Resubmit an Invoice Request

Procedure

To request to resubmit an invoice request:

1. Do either of the following:

If you want to...	Then...
Request for resubmitting an invoice request through the Invoice Request screen	<ol style="list-style-type: none"> 1. Search for the invoice request in the Invoice Request screen. 2. In the Search Results section, click the link in the Invoice Request Information column corresponding to the invoice request which you want to review.
Request for resubmitting an invoice request from the To Do List screen	<ol style="list-style-type: none"> 1. Click the Menu link in the Application toolbar. A list appears. 2. From the Main menu, select To Do and then click To Do List. The To Do Type for User Search window appears. 3. Enter C1-INVRATODO in the To Do Type field. 4. Click the Search button corresponding to the To Do Type field. The To Do List screen appears. 5. Select the Open option from the Filter by list to view all unassigned To Dos. 6. Click the link in the Message column corresponding to the To Do of the invoice request that you want to review.

The **Invoice Request** screen appears.

2. Review the details in the **Invoice Request** screen.
3. If the information in the invoice request is incomplete and you want the submitter to make the required changes and resubmit the invoice request for approval, then click the **ReSubmit** button in the **Invoice Request** zone.

The **Resubmit Invoice Request** window appears. It contains the following field:

Field Name	Field Description	Mandatory (Yes or No)
Comments	Used to specify the changes which the submitter should make in the invoice request before resubmitting it for approval.	Yes

Note: The **Re Submit** button appears when:

- The invoice request is in the **Approval In Progress** status.
- A user with the approval To Do role is reviewing the invoice request.

4. Enter the comments in the respective field and then click **Save**.

A To Do is created using the submitter To Do type and assigned to all users with a submitter To Do role specified in the invoice request type. In addition, the status of the invoice request is changed to **Draft**.

Related Topics

For more information on...	See...
How to search for an invoice request	Searching for an Invoice Request on page 3379

For more information on...	See...
Invoice Request screen	Invoice Request (Used for Viewing) on page 3382
Invoice Request zone	Invoice Request on page 3383

Viewing the Log of an Invoice Request

Procedure

To view the log of an invoice request:

1. Search for the invoice request in the **Invoice Request** screen.
2. In the **Search Results** section, click the link in the **Invoice Request Information** column corresponding to the invoice request whose log you want to view.

The **Invoice Request** screen appears.

3. Click the **Log** tab.

The **Log** tab appears.

4. View the complete trail of actions performed on the invoice request in the **Invoice Request Log** zone.

Related Topics

For more information on...	See...
How to search for an invoice request	Searching for an Invoice Request on page 3379
Invoice Request screen	Invoice Request (Used for Viewing) on page 3382
Invoice Request Log zone	Invoice Request on page 3383
How to add a log entry for an invoice request	Adding a Log Entry for an Invoice Request on page 3398

Adding a Log Entry for an Invoice Request

Procedure

To add a log entry for an invoice request:

1. Search for the invoice request in the **Invoice Request** screen.
2. In the **Search Results** section, click the link in the **Invoice Request Information** column corresponding to the invoice request whose log you want to edit.

The **Invoice Request** screen appears.

3. Click the **Log** tab.

The **Log** tab appears.

4. Click the **Add Log Entry** link in the upper right corner of the **Invoice Request Log** zone.

The **Add Request Log** window appears. It contains the following fields:

Field Name	Field Description	Mandatory (Yes or No)
Request Information	Displays information about the invoice request.	Not applicable
Log Details	Used to specify additional comments for the invoice request.	Yes

5. Enter the comments in the **Log Details** field.

6. Click Save.

The log entry is added in the **Invoice Request Log** zone.

Related Topics

For more information on...	See...
How to search for an invoice request	Searching for an Invoice Request on page 3379
Invoice Request screen	Invoice Request (Used for Viewing) on page 3382
Invoice Request Log zone	Invoice Request on page 3383

Chapter

44

Mass Payment Transfer

Topics:

- [Full Payment Transfer](#)
- [Mass Payment Transfer Process](#)
- [CSV File Format for Mass Payment Transfer](#)
- [Sample CSV File for Mass Payment Transfer](#)

Oracle Revenue Management and Billing facilitates mass payment transfer using the **File Upload Interface** feature. In the mass payment transfer, you can transfer multiple payments at once. You can transfer payments at the payment or payment event level (i.e. transfer an individual payment or all payments of a payment event at once). However, note that you can transfer only those payments which are in the **Frozen** status.

You can upload the data for full payment transfer in the CSV format through the **File Transformation and Upload (C1-FTRAN)** batch. While executing the **File Transformation and Upload (C1-FTRAN)** batch, you need to specify a file request type which indicates the XPath of the fields where the data from the CSV record should be stored while transforming the data in the XML format using the **C1-TransferPaymentService** business service. Once each CSV file record is transformed in the XML format, you can transfer payments through the **File Request Processing (C1-FREQP)** batch.

Full Payment Transfer

You can upload the data for full payment transfer from the CSV file using the **File Upload Interface** utility. You can only transfer positive payments which are in the **Frozen** status and where the payment amount is greater than zero using the **File Upload Interface** utility.

While doing full payment transfer at the payment level, the system cancels the old payment and creates one new payment using the specified match type in the **Frozen** status. For example, the P1 payment is created against the contract of the A1 account, as shown in the following table:

Account	Payment Event	Payment Details	Match Type	Match Value	Amount	Status
A1	PE1	P1	Suspense Contract	C1	\$200	Frozen

Now, when you fully transfer the payment using the match type as Bill from the A1 to A2 account, the system will cancel the old payment and create a new payment as shown in the following table:

Account	Payment Event	Payment Details	Match Type	Match Value	Amount	Status
A1	PE1	P1	Suspense Contract	C1	\$200	Canceled
A2	PE2	P2	Bill	Bill1	\$200	Frozen

While doing full payment transfer at the payment event level, the system fetches the list of frozen payments linked to the payment event and then adds them in the **C1_PAY_DETAILS** table. In addition, the system sets the **PY_CANCEL_SW** column corresponding to the payments in the **C1_PAY_DETAILS** table to **Y**. Let us assume that the following payments are made to the A1 account through the PE1 payment event:

Account	Payment Event	Payment Details	Match Type	Match Value	Amount	Status
A1	PE1	P1	Suspense Contract	C1	\$100	Frozen
		P2	On Account Contract	C2	\$50	Frozen
		P3	Suspense Contract	C3	\$100	Frozen
		P4	Overpayment on Bill	C4	\$100	Frozen
		P5	On Account Contract	C5	\$100	Frozen
		P6	Suspense Contract	C1	\$100	Frozen
		P7	On Account Contract	C5	\$100	Frozen

Account	Payment Event	Payment Details	Match Type	Match Value	Amount	Status
		P8	Overpayment on Bill	C4	\$75	Canceled
		P10	Bill	Bill1	\$200	Frozen
		P11	Bill	Bill2	\$100	Frozen
		P12	Bill	Bill3	\$350	Frozen
		P13	Bill	Bill2	\$25	Canceled

Now, if you want to fully transfer the payments from the A1 account to the A2 account using the match type as Bill, the system considers the following payments for transfer from the payment list:

Account	Payment Event	Payment Details	Match Type	Match Value	Amount	Status
A1	PE1	P1	Suspense Contract	C1	\$100	Frozen
		P2	On Account Contract	C2	\$50	Frozen
		P3	Suspense Contract	C3	\$100	Frozen
		P4	Overpayment on Bill	C4	\$100	Frozen
		P5	On Account Contract	C5	\$100	Frozen
		P6	Suspense Contract	C1	\$100	Frozen
		P7	On Account Contract	C5	\$100	Frozen
		P10	Bill	Bill1	\$200	Frozen
		P11	Bill	Bill2	\$100	Frozen
		P12	Bill	Bill3	\$350	Frozen

Then, the system will cancel the old payments and create a new payment, as shown in the following table:

Account	Payment Event	Payment Details	Match Type	Match Value	Amount	Status
A1	PE1	P1	Suspense Contract	C1	\$100	Canceled
		P2	On Account Contract	C2	\$50	Canceled

Account	Payment Event	Payment Details	Match Type	Match Value	Amount	Status
		P3	Suspense Contract	C3	\$100	Canceled
		P4	Overpayment on Bill	C4	\$100	Canceled
		P5	On Account Contract	C5	\$100	Canceled
		P6	Suspense Contract	C1	\$100	Canceled
		P7	On Account Contract	C5	\$100	Canceled
		P10	Bill	Bill1	\$200	Canceled
		P11	Bill	Bill2	\$100	Canceled
		P12	Bill	Bill3	\$350	Canceled
A2	PE2	P1	Bill	Bill4	\$1300	Frozen

Mass Payment Transfer Process

The following are the different steps involved in the Mass Payment Transfer process:

1. [Defining a File Request Type for Payment Transfer](#) on page 3404
2. [Uploading a Payment Transfer File](#) on page 3406
3. [Transferring Payments](#) on page 3406

Defining a File Request Type for Payment Transfer

Procedure

To define a file request type for payment transfer:

1. Click the **Admin** link in the **Application** toolbar.
A list appears.
2. From the **Admin** menu, select **F** and then click **File Request Type**.
A sub-menu appears.
3. Click the **Add** option from the **File Request Type** sub-menu.
The **File Request Type** screen appears.
4. Do the following in the **Main** section:
 - a) Enter the file request type and description in the respective fields.
 - b) Select the **Data Transformation Required** option.
The **File Format** and **File Extension** fields are enabled. In addition, the **Root XML Tag** field appears in the **Main** section.
 - c) Select the **Comma Separated Values** option from the **File Format** list.

- d) Enter `csv` in the **File Extension** field.
- e) Ensure that the **C1-FRTA** algorithm is attached to the **Data Transformation Algorithm** field.
5. Do the following in the **Services** section:
- Enter the sequence number in the respective field.
 - Select the **Business Service** option from the **Service Type** list.
 - Enter the **C1-TransferPaymentService** business service in the **Service Name** field.
 - Select the **Update** option from the **Operation** list.
6. If you have included a header in the CSV file, add the appropriate details in the **Header Transformation** section.
7. Similarly, if you have included a footer in the CSV file, add the appropriate details in the **Footer Transformation** section.
8. In the **Field Transformation** section, you need to specify the following details:

Field Name	Field Description	Mandatory (Yes or No)
Sequence	Used to indicate the data field in the CSV record which you want to upload in the system.	Yes
Field Name	Used to indicate the field for which you want to upload the data in the system.	Yes
Map Field XPath	Used to specify the XPath of the field where you want to store the data field from the CSV record.	Yes

While creating a file request type for mass payment transfer, you need to specify the following field mappings in the **Field Transformation** section:

Sequence	Field Name	Map Field XPath
1	PAY_EVENT_ID	C1-TransferPaymentService/ paymentEventId
2	PAY_ID	C1-TransferPaymentService/ paymentId
3	TRANSFER_TYPE	C1-TransferPaymentService/ transferType
4	TRANSFER_REASON	C1-TransferPaymentService/ transferReason
5	MATCH_TYPE	C1-TransferPaymentService/ matchType
6	MATCH_TYPE_VALUE	C1-TransferPaymentService/ matchTypeValue
7	SRC_SYSTEM	C1-TransferPaymentService/ sourceSystem
8	EXT_TXN_ID	C1-TransferPaymentService/ externalTransactionId
9	EXT_SRC_ID	C1-TransferPaymentService/ externalSourceId

9. Click **Save**.

The file request type is defined for mass payment transfer.

Uploading a Payment Transfer File

You can upload the mass payment transfer file in the CSV format through the **File Transformation and Upload (C1-FTRAN)** batch. While executing this batch, you need to specify a file request type using which you want to upload the payment transfer data from the CSV file in the respective fields. For more information about the batch, refer to *Oracle Revenue Management and Billing File Upload Interface Batch Execution Guide*.

Once the CSV file is uploaded in the system, you can download the file or move the file to a different directory on the SFTP server using the **File Management System** screen. You can also view whether the CSV file records are successfully uploaded or not, whether an error occurred while uploading the file, and the header and footer details of the file using the **File Upload Dashboard** screen. In addition, if the CSV file records are successfully added in the system, you can view the status of the file records and their original and transformed payloads through the **File Record Details** screen. For more information about these screens, refer to *Oracle Revenue Management and Billing File Upload Interface User Guide*.

Transferring Payments

You can transfer multiple payments at once through the **File Request Processing (C1-FREQP)** batch. While executing this batch, you need to specify a file request type using which the payment transfer data is transformed in the XML format. For more information about the batch, refer to *Oracle Revenue Management and Billing File Upload Interface Batch Execution Guide*.

Once the CSV file record is successfully processed, the payment is transferred from one account to another. To view the details of the payment, you can navigate to the **Payment** screen through the **File Record Details** screen. For more information about the **File Record Details** screen, refer to *Oracle Revenue Management and Billing File Upload Interface User Guide*.

CSV File Format for Mass Payment Transfer

Before uploading a payment transfer file through the **File Upload Interface** utility, you need to ensure that the CSV file contains the following data:

Data	Description	Mandatory (Yes or No)
Payment Event ID	Used to indicate the payment event whose frozen payments you want to transfer.	Yes (Conditional) Note: This data is required when you want to transfer all frozen payments of a particular payment event.
Payment ID	Used to indicate the payment that you want to transfer. Note: The system allows you to transfer a payment which is in the Frozen status.	Yes (Conditional) Note: This data is required when you want to transfer a particular payment.

Data	Description	Mandatory (Yes or No)
Transfer Type	Used to indicate whether you want to transfer payments at the payment or payment event level. The valid values are: <ul style="list-style-type: none"> E — Used when you want to transfer all frozen payments of a particular payment event. P — Used when you want to transfer a particular payment. 	Yes
Transfer Reason	Used to indicate the reason why you want to transfer the payment. <div style="border: 1px solid black; padding: 2px;">Note: Here, you must specify the payment cancel reason where the Payment Transfer option is selected.</div>	Yes
Match Type	Used to indicate the match type using which you want to transfer the payment. <div style="border: 1px solid black; padding: 2px;">Note: You must specify the match type which is already defined in the system.</div>	Yes
Match Value	Used to indicate the entity against which you want to transfer the payment. <div style="border: 1px solid black; padding: 2px;">Note: Here, the entity can be account, bill, or contract. You must specify an entity which already exists in the system.</div>	Yes
Source System	Used to indicate the external system from where the payment transfer data is received. <div style="border: 1px solid black; padding: 2px;">Note: You must specify an external system which is already defined in the system.</div>	No
External Transaction ID	Used to indicate the transaction in the external system through which the payment transfer data is received.	No
External Source System ID	Used to specify the external source system ID.	No

Related Topics

For more information on...	See...
Sample CSV File for Mass Payment Transfer	Sample CSV File for Mass Payment Transfer on page 3407

Sample CSV File for Mass Payment Transfer

```
,436878000000,P,ROBL,HCMATCH,770018000000,,,
,436229000000,P,ENTR,HCMATCH,770018000000,,,
436560000000,,E,NSF,HCMATCH,770018000000,,,
,436912000000,P,ACCT,HCMATCH,770018000000,,,
```

Let us assume that the payment transfer file is uploaded and transformed using a file request type with the following field transformation details:

Sequence	Field Name	Map Field XPath
1	Payment Event ID	C1-TransferPaymentService/paymentEventId
2	Payment ID	C1-TransferPaymentService/paymentId
3	Transfer Type	C1-TransferPaymentService/transferType
4	Transfer Reason	C1-TransferPaymentService/transferReason
5	Match Type	C1-TransferPaymentService/matchType
6	Match Type Value	C1-TransferPaymentService/matchTypeValue
7	Source System	C1-TransferPaymentService/sourceSystem
8	External Transaction Id	C1-TransferPaymentService/externalTransactionId
9	External Source system Id	C1-TransferPaymentService/externalSourceId

On successfully uploading and transforming the data, the system creates a transformed payload for each CSV file record. The transformed payload stores the payment transfer data in the following tags:

Service Payload	Tag Name	CSV File Record 1	CSV File Record 2	CSV File Record 3	CSV File Record 4
C1-Transfer Payment Service	paymentEventId	-	-	436560000000	-
	paymentId	436878000000	436229000000	-	436912000000
	transferType	P	P	E	P
	transferReason	ROBL	ENTR	NSF	ACCT
	matchType	HCMATCH	HCMATCH	HCMATCH	HCMATCH
	matchTypeValue	770018000000	770018000000	770018000000	770018000000
	sourceSystem	-	-	-	-
	externalTransactionId	-	-	-	-
	externalSourceId	-	-	-	-

Related Topics

For more information on...	See...
CSV File Format for Mass Payment Transfer	CSV File Format for Mass Payment Transfer on page 3406

Chapter 45

FOP Reports

Oracle Revenue Management and Billing enables you to extract data using the following FOP reports:

- **User Access Report** - Enables you to view the permissions granted to a particular user for accessing the data.
- **Payment Summary Report** - Enables you to view the total payment made via a tender type for each customer in a division.
- **Payment Detail Report** - Enables you to view the individual payment details of each account and customer in a division.
- **Invoice Ageing Report** - Enables you to view the invoices which are due for payment in different aging buckets.

These FOP reports are not shipped with the product. Oracle Revenue Management and Billing provides the UserAccessReport, PaymentSummaryReport, PaymentDetailReport, and AgingReport XSL files using which you can create the respective report. Once the FOP report is created, you can extract the data from the system in the PDF format using the FOP report. For more information about these FOP reports, refer to *Oracle Revenue Management and Billing FOP Reports Guide*.

Chapter 46

Garbling Customer Information

Oracle Revenue Management and Billing enables you to garble the personal information of a customer, such as the customer name, address, email ID, social security number or any other identifier, birth date, gender, and so on. On receiving the data erasure request from a customer, the data controller will garble the personal information of the customer by masking the data with random characters and then cease the access to the customer records.

To garble the information of one or more persons, you need to do the following:

1. Define the **Garble Data (C1-GRBL)** characteristic for each person whose data needs to be garbled and set its value to **Y**.
2. Execute the **Garble Person Information (C1-GRBPI)** batch. For more information about this batch, see *Oracle Revenue Management and Billing Batch Guide*.

On executing the **Garble Person Information (C1-GRBPI)** batch, the system identifies the persons where the **Garble Data (C1-GRBL)** characteristic is set to **Y** and the **Garbling Completed (C1-GBCM)** characteristic is either not defined or set to **N**. Note that the system considers the **Garble Data (C1-GRBL)** characteristic value which is effective on the batch business date.

Once the persons are identified, the data in the following fields is masked with random characters across all records in the system:

- ACCOUNT_NBR
- ACCT_NBR
- ADDRESS1
- ADDRESS1_UPR
- ADDRESS2
- ADDRESS3
- ADDRESS4
- BIRTH_DT
- BROKER_NAME
- CITY
- COUNTRY
- COUNTY
- CUSTOMER_NAME
- EMAILID

- ENTITY_NAME
- ENTITY_NAME1
- ENTITY_NAME2
- ENTITY_NAME3
- GEO_CODE
- HOUSE_TYPE
- IN_CITY_LIMIT
- NAME1
- OVRD_MAIL_NAME1
- OVRD_MAIL_NAME2
- OVRD_MAIL_NAME3
- PER_ID_NBR
- PHONE
- POSTAL
- POSTAL_UPR
- STATE

In other words, the personal and account related information of a customer is garbled across the system. In addition, this batch allows you to garble the required characteristics and identifiers of a person and account.

Note: An account may have one or more persons linked to it. The information of an account is garbled when the data erasure request is received for the main customer of the account.

Once the personal and account related information of a customer is garbled, the access group of the person is changed to **C1GB** (which does not have any data access role). This ensures that the data of the person and his or her accounts cannot be accessed from any screens in the system. If an approval transaction contains personal and account related information of a customer, you cannot even view the approval transaction in the system.

Note: The access is forbidden for performing any transaction for the person and account only from the user interface and web services and not through the background process.

You can also garble the data of a person using the **C1-GRBPI** inbound web service. However, you can garble the data of only one person at a time using this inbound web service.

Appendix

A

Most Commonly Used Tasks

Topics:

- [Changing the Layout](#)

This section lists some of the common tasks that are performed while using various functionality in the application.

Changing the Layout

You can change the layout of the zone by:

- [Removing a Column from the Zone](#) on page 3414
- [Adding a Column to the Zone](#) on page 3414
- [Rearranging Columns in the Zone](#) on page 3414

Adding a Column to the Zone

Once you have removed the columns from the zone, you can add them back to the zone. To add a column to the zone:

1. Click the **Column Configuration** () icon in the upper right corner of the zone.

A panel appears at the bottom of the zone with a list of column names.

Note: The column names with the white background in the panel are currently not displayed in the zone.

2. Drag and drop the column name from the panel to the location where you want to add the column in the zone.
The white background of the column name in the panel changes to the grey background indicating that the column is currently displayed in the zone.
3. If you want to add another column name from the panel to the zone, repeat the second step. Click the **Refresh** button, data will be displayed to the columns added in the zone.

Related Topics

For more information on...	See...
How to change the layout of the zone	Changing the Layout on page 3414

Rearranging Columns in the Zone

You can change the order in which the columns are displayed in the zone. To change the position of a column in the zone:

1. Click the column name whose position you want to change in the zone.
2. Drag and drop the column name between the columns where you want to place the selected column.

The position of the column changes in the zone.

Related Topics

For more information on...	See...
How to change the layout of the zone	Changing the Layout on page 3414

Removing a Column from the Zone

To remove a column from the zone:

Click the **Delete** () icon corresponding to the column name that you want to remove from the zone.

The column is removed from the zone and is currently displayed with white background in the panel.

Note: Alternatively you can remove the column from the zone by clicking the Delete (🗑️) icon corresponding to the column name in the panel.

Related Topics

For more information on...	See...
How to change the layout of the zone	Changing the Layout on page 3414

Appendix

B

Administration

Topics:

- [UI Maps](#)
- [Feature Configurations](#)

This section lists some of the administrative tasks.

UI Maps

This section explains how to create the UI maps for viewing and modifying data of the business objects within the approval workflow group.

Creating Display UI Map for an Approval Workflow Group

The system provides you with the ability to automatically generate a Display UI map, and associate it with the approval workflow group. Alternatively, you can create a Display UI map manually, and attach it to the approval workflow group.

Procedure

To create a Display UI map manually:

1. Click the **Admin** link in the **Application** toolbar.
A list appears.
2. From the **Admin** menu, select **U** and then click **UI Map**.
A sub-menu appears.
3. Click the **Search** option from the **UI Map** sub-menu.
The **UI Map** screen appears.
4. In the **Main** tab, enter the name and description of the Display UI map.

Note: The system uses the CM_<Approval Workflow Group Code>_AppTxn_Display naming convention while automatically generating a Display UI map. Therefore, do not use this naming convention while creating a Display UI map manually.

5. Select **Complete HTML Document** from the **UI Map Type** list.
6. Click the **Schema** tab.
The **Schema** tab appears.
7. Add the following schema in the **Scheme Editor** zone:

```
<schema>
  <<Business Object Name> type="group">
    <includeBO name="<Business Object Name>" />
  </<Business Object Name>>
</schema>
```

In the above schema, you must replace <Business Object Name> with the name of the business object. For example, if you want to create a Display UI map for account, you must use the following schema:

```
<schema>
  <account type="group">
    <includeBO name="Account" />
  </account>
</schema>
```

8. Click the **Save** link in the **Actions/Navigation** area.
The **Display Only** and **Input Map** buttons are enabled on the dashboard.
9. Click the **Display Only** button.
The HTML code is generated in the **HTML Editor** zone.
10. Click the **Save** link in the **Actions/Navigation** area.
The changes are saved.

Related Topics

For more information on...	See...
How to define an approval workflow group	Defining an Approval Workflow Group on page 1030
How to edit an approval workflow group	Editing an Approval Workflow Group on page 1040

Creating Input UI Map for an Approval Workflow Group

The system provides you with the ability to automatically generate an Input UI map, and associate it with the approval workflow group. Alternatively, you can create an Input UI map manually, and attach it to the approval workflow group.

Procedure

To create an Input UI map manually:

1. Click the **Admin** link in the **Application** toolbar.
A list appears.
2. From the **Admin** menu, select **U** and then click **UI Map**.
A sub-menu appears.
3. Click the **Search** option from the **UI Map** sub-menu.
The **UI Map** screen appears.
4. In the **Main** tab, enter the name and description of the Input UI map.

Note: The system uses the CM_<Approval Workflow Group Code>_AppTxn_Input naming convention while automatically generating an Input UI map. Therefore, do not use this naming convention while creating an Input UI map manually.

5. Select **Complete HTML Document** from the **UI Map Type** list.
6. Click the **Schema** tab.
The **Schema** tab appears.
7. Add the following schema in the **Scheme Editor** zone:

```
<schema>
  <approvalTransactionId/>
  <action/>
  <<Business Object Name> type="group">
    <includeBO name="<Business Object Name>" />
  </<Business Object Name>>
</schema>
```

In the above schema, you must replace <Business Object Name> with the name of the business object. For example, if you want to create an Input UI map for account, you must use the following schema:

```
<schema>
  <approvalTransactionId/>
  <action/>
  <account type="group">
    <includeBO name="Account" />
  </account>
</schema>
```

The <approvalTransactionId/> tag is used in the schema to retrieve the approval transaction ID of the respective business object. The <action/> tag is used in the schema to retrieve the action performed by the submitter.

- Click the **Save** link in the **Actions/Navigation** area.

The **Display Only** and **Input Map** buttons are enabled on the dashboard.

- Click the **Input Map** button.

The HTML code is generated in the **HTML Editor** zone.

- Add the following tag in the head tag:

```
<script language="javascript" type="text/javascript" src="code/
approvalWorkflow.js"></script>
```

- Add the text highlighted in bold within the tag as shown below:

```
<td>
<input onClick=performAction('<Approval Workflow Group Code>');"
oraMdLabel="SAVE_BTN_LBL" class="oraButton" type="button">
<input onClick="oraSubmitMap('CANCEL', false);" oraMdLabel="CANCEL_LBL"
class="oraButton" type="button">
</td>
```

In the above HTML code, you must replace <Approval Workflow Group Code> with the code of the approval workflow group for which you are creating a UI map.

- Click the **Save** link in the **Actions/Navigation** area.

The changes are saved.

Related Topics

For more information on...	See...
How to define an approval workflow group	Defining an Approval Workflow Group on page 1030
How to edit an approval workflow group	Editing an Approval Workflow Group on page 1040

Feature Configurations

This section explains how to set various feature configurations which are required for implementing various features in Oracle Revenue Management and Billing.

Setting the C1_ACCTINFO Feature Configuration

Prerequisites

To set the **C1_ACCTINFO** feature configuration, you should have:

- Account Type characteristic type defined in the application (where the characteristic entity is set to Account)
- Invoice Group Account characteristic type defined in the application (where the characteristic entity is set to Account)

Procedure

To set the **C1_ACCTINFO** feature configuration:

- Click the **Admin** link in the **Application** toolbar.

A list appears.

- From the **Admin** menu, select **F** and then click **Feature Configuration**.

A sub-menu appears.

- Click the **Search** option from the **Feature Configuration** sub-menu.

The **Feature Configuration Search** window appears.

- Enter **C1_ACCTINFO** in the **Feature Name** field.

- Click the **Search** button corresponding to the **Feature Name** field.

The **Feature Configuration** screen appears. It contains the following option types:

Option Type	Description	Mandatory (Yes or No)
Account Type	Used to specify the characteristic type. This characteristic type is used to define the type of account in the Account screen. Note: By default, the C1_F_ATY characteristic type is specified. If you want to use account types other than the ones defined in the C1_F_ATY characteristic type, you need to create a new predefined characteristic type and add the required account types as its characteristic values. Then, specify the newly created characteristic type as the value for this option type.	Yes
Invoice Group Account	Used to specify the characteristic type. This characteristic type is used to indicate whether the account is a master or member account in the Account screen. Note: By default, the C1_F_IGA characteristic type is specified. If you want to use any other characteristic type other than C1_F_IGA , you need to create a new predefined characteristic type and add two characteristic values — Y and N. Then, specify the newly created characteristic type as the value for this option type.	Yes

- Enter the values for the required option types in the **Feature Configuration** screen.

- Click the **Save** button in the **Page Title** area.

The changes made to the feature configuration are saved.

Related Topics

For more information on...	See...
Invoicing Group	Invoicing Group

Setting the C1-ASOBLNG Feature Configuration

The **C1-ASOBLNG** feature configuration enables the system to determine the following:

- Whether the approval transaction should be created while defining, editing, or deleting a self-funded pricing rule.
- Various parameters, characteristic types, and extendable lookup business objects which should be used for the fully-insured group, fully-insured individual, and self-funded business.
- Person relationship type using which the bill group should be related to the parent customer.
- Policy person roles using which the parent customer and bill groups should be associated with the fully-insured group and self-funded policies.
- Status to which a policy should be transitioned on terminating, reinstating, or renewing the fully-insured group policy.
- Status to which a group membership should be transitioned on inactivating the main subscriber of the group membership.
- Status to which a member person of a group membership should be transitioned on inactivating the group membership.
- Status to which an individual membership should be transitioned on canceling the main subscriber of the individual membership.
- Status to which a member person of an individual membership should be transitioned on canceling the individual membership.
- Whether the plan-specific contracts should be created on the accounts for the fully-insured group policies.

Prerequisites

To set the **C1-ASOBLLNG** feature configuration, you should have:

- Required policy person roles, account relationship types, and person relationship types defined in the application
- Approval workflow settings configured for the **C1PRCANC**, **C1PRCASL**, **C1PRCRLCLM**, **C1PRCDA**, **C1PRFLTFFEE**, **C1PRCLVLFN**, **C1PRETCLM**, **C1PRRETENR**, and **C1PRCSSL** approval workflow groups
- Required approval workflow group defined for the Minimum Premium Program (MPP) pricing rule and approval workflow settings configured for the MPP approval workflow group
- Required characteristic types defined in the application
- Values defined for the **C1-ExtLookClaimTemplate**, **C1-ExtLookPricingRuleLineItem**, and **C1-ExtLookRetTypeRateOpt** extendable lookups
- Predefined values defined for the **C1INVTYP** characteristic type
- Required SQIs defined in the application
- Pricing arrangement parameter defined in the application (where the value type is set to **Adhoc**, source entity is set to **Transaction**, and the parameter usage is set to **Price Item**)
- Billable charge line type parameter defined in the application (where the value type is set to **Adhoc**, source entity is set to **Transaction**, and the parameter usage is set to **Price Item**)
- Pricing group rule parameter defined in the application (where the value type is set to **Adhoc**, source entity is set to **Transaction**, and the parameter usage is set to **Price Item**)
- A predefined characteristic type named **Active Employee Coverage Billing Arrangement** defined with the following characteristic values:

Characteristic Value	Description
DRT	Direct Billing
GRP	Group Billing

You must set the characteristic entity of the **Active Employee Coverage Billing Arrangement** characteristic type to **Person**.

- A predefined characteristic type named **Benefit Billing Arrangement** defined with the following characteristic values:

Characteristic Value	Description
DRT	Direct Billing
GRP	Group Billing

You must set the characteristic entity of the **Benefit Billing Arrangement** characteristic type to **Person, Policy, and Policy Plan**.

- A predefined characteristic type named **COBRA Billing Arrangement** defined with the following characteristic values:

Characteristic Value	Description
DRT	Direct Billing
GRP	Group Billing
TPA	TPA Billing

You must set the characteristic entity of the **COBRA Billing Arrangement** characteristic type to **Person, Policy, and Policy Plan**.

- Required billing preference, binder payment preference, geographic rating area preference for fully-insured group and individual, medicare preference, member relationship and subscription tier preference, and membership status reason preference defined in the application.

Procedure

To set the **C1-ASOBLLNG** feature configuration:

1. Click the **Admin** link in the **Application** toolbar.
A list appears.
2. From the **Admin** menu, select **F** and then click **Feature Configuration**.
A sub-menu appears.
3. Click the **Search** option from the **Feature Configuration** sub-menu.
The **Feature Configuration Search** window appears.
4. Enter **C1-ASOBLLNG** in the **Feature Name** field.
5. Click the **Search** button corresponding to the **Feature Name** field.

The **Feature Configuration** screen appears. It contains the following option types:

Option Type	Description	Mandatory (Yes or No)
Account Identifier Type Char Type	Used to specify the characteristic type which stores the account identifier type. It is used to determine the account to which you want to bill the group or individual membership.	Yes (Conditional)
	Note: You must specify a characteristic type where the characteristic entity is set to Membership .	Note: This data is required while billing a group or individual membership.
Account Identifier Value Char Type	Used to specify the characteristic type which stores the account identifier. It is used to determine the account to which you want to bill the group or individual membership.	Yes (Conditional)
	Note: You must specify a characteristic type where the characteristic entity is set to Membership .	Note: This data is required while billing a group or individual membership.
Age Based Parameter	Used to specify the parameter using which you want to define the lower age limit and upper age limit pricing eligibility criteria in an age based pricing.	Yes (Conditional)
	Note: The AGEBASED parameter is shipped with the product. By default, the value is set to AGEBASED . You can change the value, if required. However, note that you must specify an adhoc parameter where source entity is set to Algorithm , source type code is set to Calculate membership person's age , and the parameter usage is set to Pricing Eligibility Criteria .	Note: This data is required while defining an age based pricing rule.
Approval Workflow Group for ASL	Used to specify the approval workflow group for an aggregate stop-loss pricing rule. It helps the system to determine whether the approval transaction should be created while defining, editing, or deleting an aggregate stop-loss pricing rule.	Yes (Conditional)
	Note: The C1PRCASL approval workflow group for an aggregate stop-loss pricing rule is shipped with the product. By default, the value is set to C1PRCASL . You can change the value, if required.	Note: This data is required while enabling the approval workflow process for an aggregate stop-loss pricing rule.

Option Type	Description	Mandatory (Yes or No)
Approval Workflow Group for Ancillary	<p>Used to specify the approval workflow group for an ancillary pricing rule. It helps the system to determine whether the approval transaction should be created while defining, editing, or deleting an ancillary pricing rule.</p> <p>Note:</p> <p>The CIPRCANC approval workflow group for an ancillary pricing rule is shipped with the product.</p> <p>By default, the value is set to CIPRCANC. You can change the value, if required.</p>	<p>Yes (Conditional)</p> <p>Note: This data is required while enabling the approval workflow process for an ancillary pricing rule.</p>
Approval Workflow Group for Claim	<p>Used to specify the approval workflow group for a claim pricing rule. It helps the system to determine whether the approval transaction should be created while defining, editing, or deleting a claim pricing rule.</p> <p>Note:</p> <p>The CIPRCRLCLM approval workflow group for a claim pricing rule is shipped with the product.</p> <p>By default, the value is set to CIPRCRLCLM. You can change the value, if required.</p>	<p>Yes (Conditional)</p> <p>Note: This data is required while enabling the approval workflow process for a claim pricing rule.</p>
Approval Workflow Group for Flat Fees	<p>Used to specify the approval workflow group for the one-time and recurring flat fees pricing rules. It helps the system to determine whether the approval transaction should be created while defining, editing, or deleting the one-time and recurring flat fees pricing rules.</p> <p>Note:</p> <p>The C1PRFLTFFEE approval workflow group for the one-time and recurring flat fees pricing rules is shipped with the product.</p> <p>By default, the value is set to C1PRFLTFFEE. You can change the value, if required.</p>	<p>Yes (Conditional)</p> <p>Note: This data is required while enabling the approval workflow process for the one-time and recurring flat fees pricing rules.</p>

Option Type	Description	Mandatory (Yes or No)
Approval Workflow Group for Level Funded	Used to specify the approval workflow group for the enrollment based premium and flat rate based premium level funded pricing rules. It helps the system to determine whether the approval transaction should be created while defining, editing, or deleting the enrollment based premium and flat rate based premium level funded pricing rules.	Yes (Conditional)
	<p>Note:</p> <p>The C1PRCLVLFN approval workflow group for the enrollment based premium and flat rate based premium level funded pricing rules is shipped with the product.</p> <p>By default, the value is set to C1PRCLVLFN. You can change the value, if required.</p>	<p>Note: This data is required while enabling the approval workflow process for the enrollment based premium and flat rate based premium level funded pricing rules.</p>
Approval Workflow Group for MPP	Used to specify the approval workflow group for a minimum premium program pricing rule. It helps the system to determine whether the approval transaction should be created while defining, editing, or deleting a minimum premium program pricing rule.	Yes (Conditional)
Approval Workflow Group for Retention Type Claim Based	Used to specify the approval workflow group for a retention type claim based pricing rule. It helps the system to determine whether the approval transaction should be created while defining, editing, or deleting a retention type claim based pricing rule.	Yes (Conditional)
	<p>Note:</p> <p>The C1PRETCLM approval workflow group for a retention type claim based pricing rule is shipped with the product.</p> <p>By default, the value is set to C1PRETCLM. You can change the value, if required.</p>	<p>Note: This data is required while enabling the approval workflow process for a retention type claim based pricing rule.</p>

Option Type	Description	Mandatory (Yes or No)
Approval Workflow Group for Retention Type Enrollment Based	Used to specify the approval workflow group for a retention type enrollment based pricing rule. It helps the system to determine whether the approval transaction should be created while defining, editing, or deleting a retention type enrollment based pricing rule.	Yes (Conditional)
	<p>Note:</p> <p>The C1PRRETENR approval workflow group for a retention type enrollment based pricing rule is shipped with the product.</p> <p>By default, the value is set to C1PRRETENR. You can change the value, if required.</p>	<p>Note: This data is required while enabling the approval workflow process for a retention type enrollment based pricing rule.</p>
Approval Workflow Group for SSL	Used to specify the approval workflow group for a specific stop-loss pricing rule. It helps the system to determine whether the approval transaction should be created while defining, editing, or deleting a specific stop-loss pricing rule.	Yes (Conditional)
	<p>Note:</p> <p>The C1PRCSSL approval workflow group for a specific stop-loss pricing rule is shipped with the product.</p> <p>By default, the value is set to C1PRCSSL. You can change the value, if required.</p>	<p>Note: This data is required while enabling the approval workflow process for a specific stop-loss pricing rule.</p>
Approval Workflow Group-Discount Arrangement	Used to specify the approval workflow group for the discount share and discount guarantee pricing rules. It helps the system to determine whether the approval transaction should be created while defining, editing, or deleting the discount share and discount guarantee pricing rules.	Yes (Conditional)
	<p>Note:</p> <p>The C1PRCDA approval workflow group for the discount share and discount guarantee pricing rules is shipped with the product.</p> <p>By default, the value is set to C1PRCDA. You can change the value, if required.</p>	<p>Note: This data is required while enabling the approval workflow process for the discount share and discount guarantee pricing rules.</p>

Option Type	Description	Mandatory (Yes or No)
Base Fee PC Sequence Characteristic	Used to specify the characteristic type where you want to store the sequence number of the eligible base fee's price component. This characteristic is then passed to the rating engine for further processing.	Yes (Conditional)
	<p>Note:</p> <p>The C1BSFESE characteristic type is shipped with the product.</p> <p>By default, the value is set to C1BSFESE. You can change the value, if required. However, note that you must specify an adhoc characteristic type where the characteristic entity is set to Rate Component.</p>	<p>Note: This data is required while billing fully-insured group and individual health plans.</p>
Benefit Billing Arrangement	Used to specify the characteristic type which indicates whom to bill the premium for a Medicare group membership. This characteristic type is defined for a policy plan, policy, and/or parent customer. The system then uses this characteristic type to determine whom to bill the Medicare group membership premium.	Yes (Conditional)
Bill Cycle Rule Code	Used to specify the characteristic type which stores the billing preference of the account. This characteristic type is defined for an account. The system then uses this characteristic type to derive the bill cycle and bill period for the account.	Yes (Conditional)
	<p>Note: You must specify a characteristic type where the characteristic entity is set to Account.</p>	<p>Note: This data is required when you want the bill cycle and bill period to be tightly coupled with each other.</p>
Bill Group Policy Person Role	Used to specify the policy person role using which a bill group should be associated with a fully-insured group or self-funded policy when the policy information is given for the bill group in an inbound message.	Yes
	<p>Note: You must specify a policy person role which is already defined in the system.</p>	
Bill Seg Req Reference Id Char Type	Used to indicate the characteristic type where you want to store the request reference ID. During the fully-insured group and individual bill segment generation, this characteristic is stamped on a bill segment calculation line which indicates the repricing request for which the bill segment calculation line is created.	Yes (Conditional)
	<p>Note: You must specify a characteristic type where the characteristic entity is set to Bill Segment Calc Line.</p>	<p>Note: This data is required while billing fully-insured group and individual health plans.</p>

Option Type	Description	Mandatory (Yes or No)
Billable Charge Line Type Parameter	Used to specify the parameter in which you want to store the billable charge line type. This parameter can then be used while defining an ancillary pricing rule type.	Yes (Conditional)
	Note: You must specify an adhoc parameter where the source entity is set to Transaction and the parameter usage is set to Price Item .	Note: This data is required while defining an ancillary pricing rule type.
Billing Arrangement	Used to specify the characteristic type which indicates whom to bill the premium for an active employee coverage group membership. This characteristic type is defined for a parent customer and/or bill group. The system then uses this characteristic type to determine whom to bill the active employee coverage group membership premium.	Yes (Conditional)
Binder Payment Field Mapping	Used to specify a binder payment preference. The system considers the various attributes of the binder payment preference while creating and monitoring binder payments for an individual membership.	Yes (Conditional)
	Note: You must specify a binder payment preference which is already defined in the system.	Note: This data is required while creating and monitoring binder payments for an individual membership.
Claim Template Extendable Business Object Lookup	Used to specify the claim template extendable lookup business object. The system displays the values of the specified extendable lookup in the Claim Template list while defining or editing a claim pricing rule type.	Yes
Note: The C1-ExtLookClaimTemplate extendable lookup for claim template is shipped with the product. By default, the value is set to C1-ExtLookClaimTemplate . You can change the value, if required.		
Cobra Billing Arrangement	Used to specify the characteristic type which indicates whom to bill the premium for a COBRA group membership. This characteristic type is defined for a policy plan, policy, and/or parent customer. The system then uses this characteristic type to determine whom to bill the COBRA group membership premium.	Yes (Conditional)
		Note: This data is required while billing the premium for a COBRA group membership.

Option Type	Description	Mandatory (Yes or No)
Customer Registration ID Characteristic for Inbound Log	Used to specify the characteristic type where you want to store the customer registration ID. This characteristic type is used while creating a log entry for a health care inbound message. The log entry then indicates the customer registration object which is created through the health care inbound message.	Yes (Conditional)
	<p>Note:</p> <p>The C1CRLOG characteristic type is shipped with the product.</p> <p>By default, the value is set to C1CRLOG. You can change the value, if required. However, note that you must specify a foreign key characteristic type where the characteristic entity is set to Inbound Message Log.</p>	<p>Note: This data is required while creating a person, account, policy, and/or policy plan through a health care inbound message.</p>
Default Flat Rate Option	Used to specify the rate option which must be used by default when the rate option is not given and the modifier method is set to either FLAT or NULL in the pricing rule data of a health care inbound message.	Yes (Conditional)
	<p>Note: You must specify a rate option where the rate schedule is set to HC_FRTSC.</p>	<p>Note: This data is required while creating an age based and tier based pricing.</p>
Default Percentage Rate Option	Used to specify the rate option which must be used by default when the rate option is not given and the modifier method is set to either EXPT or INPT in the pricing rule data of a health care inbound message.	Yes (Conditional)
	<p>Note: You must specify a rate option where the rate schedule is set to HC_PRTSC.</p>	<p>Note: This data is required while creating an age based and tier based pricing.</p>

Option Type	Description	Mandatory (Yes or No)
Invoice Type Characteristic Type	<p>Used to specify the characteristic type which indicates the type of account. This characteristic type is defined for the account. The system then uses this characteristic type to determine the account on which the claim, specific stop-loss credits, aggregate stop-loss credits, claim based fee, enrollment based fee, one-time flat fees, recurring flat fees, ancillary, discount, or level funded billable charges should be created in the system. For more information, refer to <i>Bill Group's Account</i> on page 65.</p> <p>Note: The C1INVTYP characteristic type is shipped with the product. By default, the value is set to C1INVTYP. You can change the value, if required. However, note that you must specify a predefined characteristic type where the characteristic entity is set to Account.</p>	Yes
Line Item Extendable Lookup Business Object	<p>Used to specify the line item extendable lookup business object. The system displays the values of the specified extendable lookup in the Line Item list while defining, editing, or copying a claim template.</p> <p>Note: The C1-ExtLookPricingRuleLineItem extendable lookup for line item is shipped with the product. By default, the value is set to C1-ExtLookPricingRuleLineItem. You can change the value, if required.</p>	Yes
Medicare	<p>Used to specify a Medicare preference. The system considers the various attributes of the Medicare preference while creating charges for Medicare Part D Low Income Subsidy (LIS) and Late Enrollment Penalty (LEP).</p> <p>Note: You must specify a Medicare preference which is already defined in the system.</p>	Yes (Conditional) Note: This data is required while creating charges for Medicare Part D LIS and LEP.
Membership Cancel Status	<p>Used to specify the status to which an individual membership should be transitioned when the status of its main subscriber is set to Canceled.</p> <p>Note: You must specify a status which is defined in the lifecycle of the C1-IndMembership business object.</p>	Yes (Conditional) Note: This data is required while canceling an individual membership.

Option Type	Description	Mandatory (Yes or No)
Membership Characteristic Inbound Log for	Used to specify the characteristic type where you want to store the membership ID. This characteristic type is used while creating a log entry for a health care inbound message. The log entry then indicates the group or individual membership which is created through the health care inbound message.	Yes (Conditional)
	<p>Note:</p> <p>The CIMBRLOG characteristic type is shipped with the product.</p> <p>By default, the value is set to CIMBRLOG. You can change the value, if required. However, note that you must specify a foreign key characteristic type where the characteristic entity is set to Inbound Message Log.</p>	<p>Note: This data is required while creating a group or individual membership through a health care inbound message.</p>
Membership Characteristic Billable Charge ID for	Used to specify the characteristic type where you want to store the membership ID. During the fully-insured group and individual billable charge creation process, this characteristic is stamped on a billable charge which indicates the group or individual membership for which the billable charge is created.	Yes (Conditional)
	<p>Note: You must specify a foreign key characteristic type where the characteristic entity is set to Billable Charge.</p>	<p>Note: This data is required while billing a group or individual membership.</p>
Membership Status Inactive	Used to specify the status to which a group membership should be transitioned when its main subscriber is inactivated.	Yes (Conditional)
	<p>Note: You must specify a status which is defined in the lifecycle of the C1-Membership business object.</p>	<p>Note: This data is required while inactivating a group membership.</p>
Membership Cancel Status Person	Used to specify the status to which the member persons of an individual membership should be transitioned when the individual membership is canceled.	Yes (Conditional)
	<p>Note: You must specify a status which is defined in the MEMBER_PER_STATUS_FLG lookup field.</p>	<p>Note: This data is required while canceling an individual membership.</p>

Option Type	Description	Mandatory (Yes or No)
Membership Person Inactive Status	Used to specify the status to which the member persons of a group membership should be transitioned when the group membership is inactivated.	Yes (Conditional)
	Note: You must specify a status which is defined in the MEMBER_PER_STATUS_FLG lookup field.	Note: This data is required while inactivating a group membership.
Off-process Request Detail Maximum Count	Used to indicate the maximum number of amendment details you can specify in an off-process request.	Yes (Conditional)
		Note: This data is required while creating an off-process request.
Override Proration Applicability Characteristic Type	Used to specify the characteristic type which indicates whether the proration rule should be overridden for a member person. At present, the override proration feature is used for a new born when the gift days are offered to a new born. This characteristic type can be defined for the group membership, policy plan, policy, and state.	Yes (Conditional)
	Note: You must specify a characteristic type where the characteristic entity is set to Membership, Policy Plan, Policy, and State . Here, the predefined values for the characteristic type can be Y and N .	Note: This data is required when you want to override the proration rule.
Override Proration Effective Date Characteristic Type	Used to specify the characteristic type where you want to store the date from when the premium should be calculated for the new born. This characteristic is used during the bill segment generation to determine the bill period in which the date falls. The system then accordingly prorates the premium amount for the new born.	Yes (Conditional)
	Note: You must specify a characteristic type where the characteristic entity is set to Membership Person .	Note: This data is required when you want to override the proration rule.
Override Proration Rule Characteristic Type	Used to specify the characteristic type where you want to store the override SQ rule for a new born. This characteristic type can be defined for the group membership, policy plan, policy, and state. If this characteristic is not defined at any level, the system uses the SQ rule of the rate schedule attached to the active contract to prorate the premium amount of a new born child.	Yes (Conditional)
	Note: You must specify a characteristic type where the characteristic entity is set to Membership, Policy Plan, Policy, and State .	Note: This data is required when you want to override the proration rule.

Option Type	Description	Mandatory (Yes or No)
Parent Customer Policy Person Role	Used to specify the policy person role using which the parent customer should be associated with a fully-insured group or self-funded policy when the policy information is given for the bill group or parent customer in an inbound message.	Yes
	Note: You must specify a policy person role which is already defined in the system.	
Person ID Characteristic for Inbound Log	Used to specify the characteristic type where you want to store the person ID. This characteristic type is used while creating a log entry for a health care inbound message. The log entry then indicates the person whose record is created through the health care inbound message.	Yes (Conditional)
	<p>Note:</p> <p>The CIPERLOG characteristic type is shipped with the product.</p> <p>By default, the value is set to CIPERLOG. You can change the value, if required. However, note that you must specify a foreign key characteristic type where the characteristic entity is set to Inbound Message Log.</p>	<p>Note: This data is required while creating a person through a health care inbound message.</p>
Person Identifier Type Char Type	Used to specify the characteristic type which stores the person identifier type. It is used to determine the person to whom you want to bill the group or individual membership.	Yes (Conditional)
	<p>Note: You must specify a characteristic type where the characteristic entity is set to Membership.</p>	<p>Note: This data is required while billing a group or individual membership.</p>
Person Identifier Value Char Type	Used to specify the characteristic type which stores the person identifier. It is used to determine the person to whom you want to bill the group or individual membership.	Yes (Conditional)
	<p>Note: You must specify a characteristic type where the characteristic entity is set to Membership.</p>	<p>Note: This data is required while billing a group or individual membership.</p>

Option Type	Description	Mandatory (Yes or No)
Person Relationship Type	<p>Used to indicate how a bill group should be related to a parent customer. The system uses the person relationship type while:</p> <ul style="list-style-type: none"> • Creating a bill group for a parent customer through an inbound message • Viewing the 360° information of a parent customer <p>Note: You must specify a person relationship type which is already defined in the system.</p>	Yes
Plan Based Contract Characteristic Type	<p>Used to specify the characteristic type which helps to determine whether the system should create plan-specific contracts for a price item. This characteristic must be defined on the person for whom you want to create plan-specific contracts on the accounts.</p> <p>Note: You must specify a characteristic type where the characteristic entity is set to Person.</p>	Yes (Conditional) Note: This data is required when you want to enable the plan-specific contract creation feature for specific persons in the fully-insured group health plan business.
Plan Based Contract Characteristic Value	Used to specify the characteristic value which indicates that the system should create plan-specific contracts for a price item on the accounts.	Yes (Conditional) Note: This data is required when you want to enable the plan-specific contract creation feature for specific persons in the fully-insured group health plan business.
Plan Based Contract Creation Eligibility	Used to indicate whether the system should create plan-specific contract for a price item on the account. The valid value is Yes .	Yes (Conditional) Note: This data is required when you want to enable the plan-specific contract creation feature for the fully-insured group health plan business.
Plan Id Characteristic Type	<p>Used to specify the characteristic type where you want to store the plan for which the contract is created. During the fully-insured group policy plan contract creation, this characteristic is defined on the contract.</p> <p>Note: You must specify a characteristic type where the characteristic entity is set to Contract.</p>	Yes (Conditional) Note: This data is required when you want to enable the plan-specific contract creation feature for the fully-insured group health plan business.

Option Type	Description	Mandatory (Yes or No)
Policy Reinstatement Status	Used to specify the status to which the policy must be transitioned when it is reinstated.	Yes (Conditional)
	Note: You must specify a status which is defined in the lifecycle of the C1-POLICY business object.	Note: This data is required while reinstating a fully-insured group policy.
Policy Renewal Status	Used to specify the status to which the policy must be transitioned when it is renewed.	Yes (Conditional)
	Note: You must specify a status which is defined in the lifecycle of the C1-POLICY business object.	Note: This data is required while renewing a fully-insured group policy.
Policy Termination Status	Used to specify the status to which the policy must be transitioned when it is terminated.	Yes (Conditional)
	Note: You must specify a status which is defined in the lifecycle of the C1-POLICY business object.	Note: This data is required while terminating a fully-insured group policy.
Pricing Arrangement Parameter	Used to specify the parameter in which you want to store the pricing arrangement. This parameter can then be used while defining an ancillary pricing rule type.	Yes (Conditional)
	Note: You must specify an adhoc parameter where the source entity is set to Transaction and the parameter usage is set to Price Item .	Note: This data is required while defining an ancillary pricing rule type.
Pricing Group Rule Parameter	Used to specify the parameter in which you want to store the pricing group rule. The system stamps this parameter on the price assignment which is created through a pricing rule using a pricing group. It indicates that the price assignment is created using the respective rule in the pricing group.	Yes (Conditional)
	Note: You must specify an adhoc parameter where the source entity is set to Transaction and the parameter usage is set to Price Item .	Note: This data is required while defining a claim, specific stop-loss, aggregate stop-loss, retention type claim based, or retention type enrollment based pricing rule for a bill group using a pricing group.

Option Type	Description	Mandatory (Yes or No)
Pricing Rule ID for Characteristic Inbound Log	<p>Used to specify the characteristic type where you want to store the pricing rule ID. This characteristic type is used while creating a log entry for a health care inbound message. The log entry then indicates the pricing rule which is created through the health care inbound message.</p> <p>Note: The C1PRLOG characteristic type is shipped with the product. By default, the value is set to C1PRLOG. You can change the value, if required. However, note that you must specify a foreign key characteristic type where the characteristic entity is set to Inbound Message Log.</p>	<p>Yes (Conditional)</p> <p>Note: This data is required while creating a pricing rule through a health care inbound message.</p>
Pricing Rule Type Category Characteristic	<p>Used to specify the characteristic type which indicates the pricing rule type category. This characteristic type is defined for a billable charge line type. The system uses this characteristic to lists the billable charge line types which are valid while defining a pricing rule type or pricing rule of a particular category.</p> <p>Note: The C1PRTCAT characteristic type is shipped with the product. By default, the value is set to C1PRTCAT. You can change the value, if required. However, note that you must specify a foreign key characteristic type where the characteristic entity is set to Billable Charge Line Type.</p>	<p>Yes</p>
Proration Distributed SQI	<p>Used to specify the SQI where you want to store the distributed premium amount for the non-skip billing period. The system uses this SQI while creating the SQI based billable charge for the group membership premium.</p> <p>Note: You must specify an SQI which is already defined in the system.</p>	<p>es (Conditional)</p> <p>Note: This data is required when the 9/10 Billing (Skip Months) feature is enabled for an account.</p>
Proration SQI	<p>Used to specify the SQI where you want to store the pre-calculated or calculated premium amount. The system uses this SQI while creating the SQI based billable charge for the group or individual membership premium.</p> <p>Note: You must specify an SQI which is already defined in the system.</p>	<p>Yes (Conditional)</p> <p>Note: This data is required while billing fully-insured group and individual health plans.</p>

Option Type	Description	Mandatory (Yes or No)
Rate Component Base Fee Characteristic	Used to specify the characteristic type which indicates whether the rate component is a base fee rate component. This characteristic type is defined for the rate component.	Yes
	<p>Note:</p> <p>The C1RCBFMA characteristic type is shipped with the product.</p> <p>By default, the value is set to C1RCBFMA.</p>	
Rate Option Extendable Lookup Business Object	Used to specify the rate option extendable lookup business object. The system displays the values of the specified extendable lookup in the Rate Option list while defining, editing, or copying a pricing rule type.	Yes
	<p>Note:</p> <p>The C1-ExtLookRetTypeRateOpt extendable lookup for rate option is shipped with the product.</p> <p>By default, the value is set to C1-ExtLookRetTypeRateOpt. You can change the value, if required.</p>	
Rating Area Field Mapping for Group	Used to specify a geographic rating area preference. The system considers the various attributes of the geographic rating area preference while deriving the geographic rating area for a group membership.	Yes (Conditional)
	<p>Note: You must specify a geographic rating area preference which is already defined in the system.</p>	
Rating Area Field Mapping for Individual	Used to specify a geographic rating area preference. The system considers the various attributes of the geographic rating area preference while deriving the geographic rating area for an individual membership.	Yes (Conditional)
	<p>Note: This data is required while deriving the geographic rating area for a group membership.</p>	
	<p>Note: This data is required while deriving the geographic rating area for an individual membership.</p>	

Option Type	Description	Mandatory (Yes or No)
Relation Structure Code Field Mapping	Used to specify a member relationship and subscription tier preference. The system considers the various attributes of the member relationship and subscription tier preference while deriving the member relationship for a member person and the subscription tier for a group or individual membership.	Yes (Conditional) Note: This data is required while deriving the member relationship for a member person and the subscription tier for a group or individual membership.
	Note: You must specify a member relationship and subscription tier preference which is already defined in the system.	
Sponsored Switch Characteristic for Billable Charge	Used to specify the characteristic type which indicates whether the billable charge is a reverse charge for a benefit. This characteristic type is defined while creating the reverse charge for a benefit.	Yes (Conditional) Note: This data is required while creating the reverse charge for a benefit.
	Note: You must specify a characteristic type where the characteristic entity is set to Billable Charge .	
State of Issue Characteristic Type	Used to specify the characteristic type where you store the state for which the group or individual membership, policy plan, or policy is issued. This characteristic type can be defined for the group or individual membership, policy plan, or policy. This characteristic is used while identifying a list of eligible children in a group or individual membership for premium calculation.	Yes (Conditional) Note: This data is required while identifying a list of eligible children for premium calculation.
	Note: You must specify a characteristic type where the characteristic entity is set to Membership, Policy Plan, and Policy .	
Status Reason Mapping	Used to specify a membership status reason preference. The system considers the various attributes of the membership status reason preference while deriving the individual membership or member person status reason.	Yes (Conditional) Note: This data is required while maintaining an individual membership.
	Note: You must specify a membership status reason preference which is already defined in the system.	

Option Type	Description	Mandatory (Yes or No)
To Do Role Characteristic Type	<p>Used to specify the characteristic type where you want to store the To Do role. This characteristic type is defined for the parent customer. The system uses this characteristic to determine the users to whom the To Dos created using the C1-REPC1, C1-REPC2, and C1-FIBCR To Do types should be assigned.</p> <p>Note:</p> <p>A To Do is created using the C1-REPC1 To Do type when an error occurs while creating a repricing request. A To Do is created using the C1-REPC2 To Do type when an error occurs while calculating group or individual membership premium. A To Do is created using the C1-FIBCR To Do type when an error occurs while creating a billable charge for a group and individual membership.</p> <p>You must specify an adhoc characteristic type where the characteristic entity is set to Person.</p>	<p>Yes (Conditional)</p> <p>Note: This data is required while billing fully-insured group and individual health plans.</p>
TPA Account Relationship Type	<p>Used to indicate how a third party administrator (TPA) person should be related to its account. The system uses this account relationship type while creating a TPA account for a TPA person through a health care inbound message.</p> <p>Note: You must specify an account relationship type which is already defined in the system.</p>	<p>Yes (Conditional)</p> <p>Note: This data is required while creating a TPA account through a health care inbound message.</p>
TPA Person Relationship Type	<p>Used to indicate how a third party administrator (TPA) person should be related to its parent customer. The system uses this person relationship type while creating a TPA person for a parent customer through a health care inbound message.</p> <p>Note: You must specify a person relationship type which is already defined in the system.</p>	<p>Yes (Conditional)</p> <p>Note: This data is required while creating a TPA person through a health care inbound message.</p>
TPA Policy Person Role	<p>Used to specify the policy person role using which a third party administrator (TPA) person should be associated with a fully-insured group policy when the policy information is given for the TPA person in a health care inbound message.</p> <p>Note: You must specify a policy person role which is already defined in the system.</p>	<p>Yes (Conditional)</p> <p>Note: This data is required while associating a TPA person with a fully-insured group policy through a health care inbound message.</p>

6. Enter the values for the required option types in the **Feature Configuration** screen.

7. Click the **Save** button in the **Page Title** area.

The changes made to the feature configuration are saved.

Related Topics

For more information on...	See...
Customer 360° Information screen	Customer 360° Information on page 659
Health Care Inbound Message	Health Care Inbound Message on page 2080

Setting the C1_AXENTITY Feature Configuration

The **C1_AXENTITY** feature configuration enables you to configure various settings related to the **Approval Workflow** feature.

Prerequisites

To set the **C1_AXENTITY** feature configuration, you should have:

- An algorithm defined using the **C1-APPTXN** algorithm type in the application
- To Do types defined in the application
- Fields defined in the application
- XSL files that you want to use for the Input and Display UI maps

Procedure

To set the **C1_AXENTITY** feature configuration:

1. Click the **Admin** link in the **Application** toolbar.
A list appears.
2. From the **Admin** menu, select **F** and then click **Feature Configuration**.
A sub-menu appears.
3. Click the **Search** option from the **Feature Configuration** sub-menu.
The **Feature Configuration Search** window appears.
4. Enter **C1_AXENTITY** in the **Feature Name** field.
5. Click the **Search** button corresponding to the **Feature Name** field.

The **Feature Configuration** screen appears. It contains the following option types:

Option Type	Description	Mandatory (Yes or No)
Approval Transaction Compare New or Missing Entry Color	Used to indicate the color in which you want to highlight the new record or new additions made to the existing record. This helps in comparing the existing and new data while reviewing an approval transaction.	Yes
	Note: You must specify a hexadecimal value for this option type.	

Option Type	Description	Mandatory (Yes or No)
Approval Transaction Compare Value Changed Color	<p>Used to indicate the color in which you want to highlight the modifications made to the existing data. This helps in comparing the existing and new data while reviewing an approval transaction.</p> <p>Note: You must specify a hexadecimal value for this option type.</p>	Yes
Approval Transaction Entity Access Algorithms	<p>Used to specify the algorithm which controls access to the maintenance objects based on the access group and division.</p> <p>Note: By default, the value is set to C1-APPTXN. If you create new maintenance objects and want to control the access of these new maintenance objects based on the access group and division, you have to create a custom algorithm and then attach it to this option type. In such case, you will have to define this option type twice — one with the default algorithm (that is, C1-APPTXN) and another with the custom algorithm.</p>	Yes
Approval Transaction Resolve To Do Type	<p>Used to indicate that To Do entry of the specified To Do type must be created when an approver at any level in the hierarchy rejects an approval transaction.</p> <p>Note: You must specify a To Do type which is already defined in the system.</p>	Yes
Approval Transaction screen timeout	<p>Used to indicate the time (in minutes) in which the screen timeout message should appear in the Comparison: New versus Existing screen when the system takes longer time to display an approval transaction.</p>	Yes
Disable Approval Transaction Fields in Input UI Maps	<p>Used to indicate the fields that you want to disable whenever the input UI maps are regenerated.</p> <p>Note: You must specify a field which is already defined in the application.</p>	Yes

Option Type	Description	Mandatory (Yes or No)
Display Existing Panel on Left Side (Y/N)	Used to indicate whether you want to view the existing or new data in the left panel while reviewing an approval transaction. The valid values are: <ul style="list-style-type: none"> • Y - Used when you want the existing data to appear in the left panel of the Comparison: New versus Existing screen. • N - Used when you want the new data to appear in the left panel of the Comparison: New versus Existing screen. <p>Note: If you do not specify the value for this option type, by default, it is set to N.</p>	No
Display Information String	Used to indicate whether the approval transaction information string should appear in the Comparison: New versus Existing screen when you are reviewing an approval transaction of a construct. The valid values are: <ul style="list-style-type: none"> • true • false 	Yes
Display UI XSL	Used to indicate the XSL file that you want to use while regenerating the Display UI maps.	Yes
Display only Differences of fields on UI	Used to indicate whether you want to view only those fields of a record where the data is added or updated or all fields of a record while reviewing an approval transaction. The valid values are: <ul style="list-style-type: none"> • Yes - Used when you want to view only those fields of a record where the data is added or updated in the Comparison: New versus Existing screen. • No - Used when you want to view all fields of a record in the Comparison: New versus Existing screen. 	Yes
Input UI XSL	Used to indicate the XSL file that you want to use while regenerating the Input UI maps.	Yes

6. Enter the values for the required option types in the **Feature Configuration** screen.
7. Click the **Save** button in the **Page Title** area.

The changes made to the feature configuration are saved.

Setting the C1-BILLADJSQ Feature Configuration

Prerequisites

To set the **C1-BILLADJSQ** feature configuration, you should have:

- Service quantity identifiers (SQIs) defined in the application

Procedure

To set the **C1-BILLADJSQ** feature configuration:

1. Click the **Admin** link in the **Application** toolbar.
A list appears.
2. From the **Admin** menu, select **F** and then click **Feature Configuration**.
A sub-menu appears.
3. Click the **Search** option from the **Feature Configuration** sub-menu.
The **Feature Configuration Search** window appears.
4. Enter **C1-BILLADJSQ** in the **Feature Name** field.
5. Click the **Search** button corresponding to the **Feature Name** field.

The **Feature Configuration** screen appears. It contains the following option types:

Option Type	Description	Mandatory (Yes or No)
Billable Charge SQI	Used to specify the service quantity identifier (SQI) which you want to use while creating a billable charge for the state assessment fee.	Yes (Conditional)
	Note: You must specify an SQI which is already defined in the system.	Note: This data is required when you want to create billable charges for the state assessment fee.
Coverage End Date SQI	Used to specify the service quantity identifier (SQI) which you want use to derive the coverage end date from the account's last billed charge. The system uses the derived coverage end date in calculating the future retro adds (debits) for the respective account.	Yes
	Note: You must specify an SQI which is already defined in the system.	
Premium Amount SQI	Used to specify the service quantity identifier (SQI) based on which you want to calculate the catch up premium for each eligible billable charge. The value derived is finally used to calculate the future retro adds (debits) for the respective account.	Yes
	Note: You must specify an SQI which is already defined in the system. The future retro adds (debits) appears in the Billing and Adjustment Summary zone of the Account tab on the Customer 360° Information screen.	

6. Enter the values for the required option types in the **Feature Configuration** screen.
7. Click the **Save** button in the **Page Title** area.

The changes made to the feature configuration are saved.

Related Topics

For more information on...	See...
Billing and Adjustment Summary zone	Billing and Adjustment Summary on page 681

Setting the C1_CMO Feature Configuration

The **C1_CMO** feature configuration enables the system to determine the administrative contracts and excess credit transactions which should be listed in the **Customer 360° Information** screen.

Prerequisites

To set the **C1_CMO** feature configuration, you should have:

- Contract types defined in the application

Procedure

To set the **C1_CMO** feature configuration:

1. Click the **Admin** link in the **Application** toolbar.
A list appears.
2. From the **Admin** menu, select **F** and then click **Feature Configuration**.
A sub-menu appears.
3. Click the **Search** option from the **Feature Configuration** sub-menu.
The **Feature Configuration Search** window appears.
4. Enter **C1_CMO** in the **Feature Name** field.
5. Click the **Search** button corresponding to the **Feature Name** field.

The **Feature Configuration** screen appears. It contains the following option types:

Option Type	Description	Mandatory (Yes or No)
Administrative Contract Type	Used to specify the contract type. The contracts of the specified contract type are then listed in the Administrative Contracts zone of the Account tab on the Customer 360° Information screen. Note: If you want to specify multiple contract types, you need to set the Administrative Contract Type option type multiple times with a unique sequence number. If you do not specify the value for this option type, the data does not appear in the Administrative Contracts zone.	No

Option Type	Description	Mandatory (Yes or No)
On Account Contract Type	Used to specify the contract type. The excess credit transactions on the contracts of the specified contract type are then listed in the Billed Vs Paid zone of the Account tab on the Customer 360° Information screen.	No
	<p>Note:</p> <p>If you want to specify multiple contract types, you need to set the On Account Contract Type option type multiple times with a unique sequence number.</p> <p>If you do not specify the value for this option type, the data does not appear in the Billed Vs Paid zone.</p>	

- Enter the values for the required option types in the **Feature Configuration** screen.
- Click the **Save** button in the **Page Title** area.

The changes made to the feature configuration are saved.

Related Topics

For more information on...	See...
Administrative Contracts zone	Administrative Contracts on page 680
Billed Vs Paid zone	Billed Vs Paid on page 684

Setting the C1_DIVFUNCT Feature Configuration

Procedure

To set the **C1_DIVFUNCT** feature configuration:

- Click the **Admin** link in the **Application** toolbar.
A list appears.
- From the **Admin** menu, select **F** and then click **Feature Configuration**.
A sub-menu appears.
- Click the **Search** option from the **Feature Configuration** sub-menu.
The **Feature Configuration Search** window appears.
- Enter **C1_DIVFUNCT** in the **Feature Name** field.
- Click the **Search** button corresponding to the **Feature Name** field.

The **Feature Configuration** screen appears. It contains the following option types:

Option Type	Description	Mandatory (Yes or No)
Enforce division-specific validations	Used to indicate whether the division-specific validations must be triggered on the Person , Account and Contract screens. The valid values are: <ul style="list-style-type: none"> • Y • N 	Yes

6. Enter the values for the required option types in the **Feature Configuration** screen.
7. Click the **Save** button in the **Page Title** area.

The changes made to the feature configuration are saved.

Setting the C1-EHRCONFIG Feature Configuration

The **C1-EHRCONFIG** feature configuration enables the system to determine the maximum number of levels that can be included in an entity hierarchy relationship. Accordingly, the system enables you to create hierarchy entities for upto one level less than the level specified in the **Maximum Hierarchy Level** option type of the **C1-EHRCONFIG** feature configuration. For example, if you set the **Maximum Hierarchy Level** option type to 5, the system allows you to create hierarchy entities for upto four levels (i.e. Level 1, Level 2, Level 3, and Level 4). The last level (i.e. Level 5) is reserved for a price item that you want to include in an entity hierarchy relationship. Therefore, you need to accordingly set the value as per the business requirements.

Procedure

To set the **C1-EHRCONFIG** feature configuration:

1. Click the **Admin** link in the **Application** toolbar.
A list appears.
2. From the **Admin** menu, select **F** and then click **Feature Configuration**.
A sub-menu appears.
3. Click the **Search** option from the **Feature Configuration** sub-menu.
The **Feature Configuration Search** window appears.
4. Enter **C1-EHRCONFIG** in the **Feature Name** field.
5. Click the **Search** button corresponding to the **Feature Name** field.

The **Feature Configuration** screen appears. It contains the following option type:

Option Type	Description	Mandatory (Yes or No)
Maximum Hierarchy Level	Used to indicate the maximum number of levels that you want to include in an entity hierarchy relationship.	Yes
	Note: At present, the system supports maximum 10 levels in an entity hierarchy relationship. Therefore, you can define hierarchy entities for upto 9 levels. The last level (i.e. Level 10) is reserved for a price item that you want to include in an entity hierarchy relationship. By default, the value is set to 10. If you do not require 10 levels in an entity hierarchy relationship, you can set a lower maximum limit in this option type.	

- Enter the value for the required option type in the **Feature Configuration** screen.
- Click the **Save** button in the **Page Title** area.

The changes made to the feature configuration are saved.

Related Topics

For more information on...	See...
How to define a hierarchy entity	Defining a Hierarchy Entity
How to edit a hierarchy entity	Editing a Hierarchy Entity
How to copy a hierarchy entity	Copying a Hierarchy Entity

Setting the C1_EXCHRATE Feature Configuration

Procedure

To set the **C1_EXCHRATE** feature configuration:

- Click the **Admin** link in the **Application** toolbar.
A list appears.
- From the **Admin** menu, select **F** and then click **Feature Configuration**.
A sub-menu appears.
- Click the **Search** option from the **Feature Configuration** sub-menu.
The **Feature Configuration Search** window appears.
- Enter **C1_EXCHRATE** in the **Feature Name** field.
- Click the **Search** button corresponding to the **Feature Name** field.

The **Feature Configuration** screen appears. It contains the following option types:

Option Type	Description	Mandatory (Yes or No)
End Date Required for Division Override	Used to indicate whether the end date is mandatory for a division-specific exchange rate. The valid values are: <ul style="list-style-type: none"> • Y • N By default, the value of this option type is set to N.	Yes

- Enter the values for the required option types in the **Feature Configuration** screen.
- Click the **Save** button in the **Page Title** area.

The changes made to the feature configuration are saved.

Related Topics

For more information on...	See...
How to define an exchange rate	Defining an Exchange Rate
How to edit an exchange rate	Editing an Exchange Rate

Setting the C1_EXP_OVRD Feature Configuration

Procedure

To set the **C1_EXP_OVRD** feature configuration:

- Click the **Admin** link in the **Application** toolbar.
A list appears.
- From the **Admin** menu, select **F** and then click **Feature Configuration**.
A sub-menu appears.
- Click the **Search** option from the **Feature Configuration** sub-menu.
The **Feature Configuration Search** window appears.
- Enter **C1_EXP_OVRD** in the **Feature Name** field.
- Click the **Search** button corresponding to the **Feature Name** field.

The **Feature Configuration** screen appears. It contains the following option types:

Option Type	Description	Mandatory (Yes or No)
Expire Override Switch	Used to indicate whether you want to automatically expire an agreed pricing when the agreed pricing of a person or an account without end date is overridden. The valid values are: <ul style="list-style-type: none"> • Y • N 	Yes

- Enter the values for the required option types in the **Feature Configuration** screen.
- Click the **Save** button in the **Page Title** area.

The changes made to the feature configuration are saved.

Setting the C1_FINTRANOP Feature Configuration

The **C1_FINTRANOP** feature configuration enables the system to determine various options which should be considered while creating billable charges, determining a price item pricing, generating bill segments, and while creating an actual bill using a trial bill.

Procedure

To set the **C1_FINTRANOP** feature configuration:

1. Click the **Admin** link in the **Application** toolbar.
A list appears.
2. From the **Admin** menu, select **F** and then click **Feature Configuration**.
A sub-menu appears.
3. Click the **Search** option from the **Feature Configuration** sub-menu.
The **Feature Configuration Search** window appears.
4. Enter **C1_FINTRANOP** in the **Feature Name** field.
5. Click the **Search** button corresponding to the **Feature Name** field.

The **Feature Configuration** screen appears. It contains the following option types:

Option Type	Description	Mandatory (Yes or No)
Account Financial History Details Switch	<p>Used to indicate whether detailed or summarized information should be displayed for an account in the Account Financial History screen. The valid values are:</p> <ul style="list-style-type: none"> • Y - Used when you want to list all financial transactions of a bill, payment, or adjustment for an account in the Account Financial History screen. • N - Used when you want to summarize all financial transactions of a particular type on an entity (i.e. bill, payment, or adjustment) and display the total amount in the Account Financial History screen. <p>Note: If you do not specify the value for this option type, by default, it is set to Y.</p>	No

Option Type	Description	Mandatory (Yes or No)
Allow Caching Of Rule Based Autopay List	<p>Used to indicate whether you want to cache the rule based auto pay instructions of an account when the C1-APRULEEVL algorithm is invoked. The valid values are:</p> <ul style="list-style-type: none"> • Y • N <p>Note: If you do not specify the value for this option type, by default, it is set to N.</p>	No
Avoid Pricing Crawling if Rate Schedule present at Contract	<p>Used to indicate that the system should not determine the price item pricing using the price assignment search algorithm (which is attached on the account's division) when the effective rate schedule is present on the contract. The valid values are:</p> <ul style="list-style-type: none"> • Y • N <p>Note: If you do not specify the value for this option type, by default, it is set to N.</p>	No
Bill Segment Regeneration on Freeze	<p>Used to indicate whether you want to regenerate the bill segments before freezing them. The valid value is:</p> <ul style="list-style-type: none"> • Y • N <p>Note:</p> <p>If you do not specify the value for this option type, by default, it is set to N.</p> <p>If the Freeze and Complete option is selected for the respective window period in the bill cycle and the Bill Segment Regeneration on Freeze option type is set to Y, then the bill segments are regenerated and the status of the bill segments is set to Frozen. However, if the Freeze and Complete option is not selected for the respective window period in the bill cycle, then the bill segments are always regenerated irrespective of whether the Bill Segment Regeneration on Freeze option type is set to Y or N.</p>	No

Option Type	Description	Mandatory (Yes or No)
Billable Charges Date	<p>Used to indicate whether you want to consider the non-recurring billable charges whose start or end date is earlier than or equal to the cut-off date. The valid values are:</p> <ul style="list-style-type: none"> • S - Used when you want to consider the non-recurring billable charges whose start date is earlier than or equal to the cut-off date. • E - Used when you want to consider the non-recurring billable charges whose end date is earlier than or equal to the cut-off date. <p>Note:</p> <p>If you do not specify the value for this option type, by default, it is set to S.</p> <p>The system always considers the recurring billable charges whose start date is earlier than the cut-off date and end date is later than the cut-off date irrespective of whether the Billable Charges Date option type is set to S or E.</p>	No
Skip Priceitem Contract Type Validation	<p>Used to indicate whether you want to skip the price item's and billable charge's contract's contract type validation. The valid values are:</p> <ul style="list-style-type: none"> • Y - Used when you to create a billable charge for a price item on the contract which is created using a contract type to which the price item is not associated. • N - Used when you to create a billable charge for a price item on the contract which is created using a contract type to which the price item is associated. <p>Note: If you do not specify the value for this option type, by default, it is set to N.</p>	No

Option Type	Description	Mandatory (Yes or No)
Rate Component Step Optimization	<p>Used to indicate whether you want to determine the rate for all tiering ranges of a step tiered rate component or for only those tiering ranges of a step tiered rate component till when the quantity is exhausted. The valid values are:</p> <ul style="list-style-type: none"> • Y - Used when you want to determine the rate for only those tiering ranges of a step tiered rate component till when the quantity is exhausted. It helps to improve the performance of the billing batches. If you set this option type to Y, always ensure that you define the price components with the tiering ranges in the ascending order. • N - Used when you want to determine the rate for all tiering ranges of a step tiered rate component. <p>Note: If you do not specify the value for this option type, by default, it is set to N.</p>	No
Trial Bill Characteristics Conversion	<p>Used to indicate whether you want to copy the trial bill's characteristics when an actual bill is created using a trial bill. The valid values are:</p> <ul style="list-style-type: none"> • Y • N <p>Note: If you do not specify the value for this option type, by default, it is set to N.</p>	No

6. Enter the values for the required option types in the **Feature Configuration** screen.
7. Click the **Save** button in the **Page Title** area.

The changes made to the feature configuration are saved.

Setting the C1_FM Feature Configuration

Procedure

To set the **C1_FM** feature configuration:

1. Click the **Admin** link in the **Application** toolbar.
A list appears.
2. From the **Admin** menu, select **F** and then click **Feature Configuration**.
A sub-menu appears.
3. Click the **Search** option from the **Feature Configuration** sub-menu.
The **Feature Configuration Search** window appears.
4. Enter **C1_FM** in the **Feature Name** field.

5. Click the **Search** button corresponding to the **Feature Name** field.

The **Feature Configuration** screen appears. It contains the following option types:

Option Type	Description	Mandatory (Yes or No)
First Batch in Transaction Aggregation Cycle	Used to specify the first mandatory batch that you want to be executed in the transaction aggregation cycle.	Yes
	Note: At present, the system does not support any value other than C1-TXNIP for this option type.	
Last Batch in Transaction Aggregation Cycle	Used to specify the last mandatory batch that you want to be executed in the transaction aggregation cycle.	Yes
	Note: At present, the system does not support any value other than C1-TXNCU for this option type.	
Disaggregation - Price Assignment	Used to indicate whether the disaggregation request should be automatically created for a person or account when a price item is assigned to the person or account or the existing price item pricing assigned to the person or account is modified. The valid values are: <ul style="list-style-type: none"> • true • false 	No
	Note: You can use this feature when an algorithm which is created using the TXNDISAGGPRA algorithm type is attached to the Post-Processing system event of the C1_PRASGN_BO business object.	
Allow Duplicate Summary ID	Used to indicate whether the transaction legs can have duplicate summary ID while creating an aggregated billable charge using the Service Quantity Calculation (C1-TXNSQ) batch. The valid values are: <ul style="list-style-type: none"> • true • false 	No
	Note: If you set this option type to false , the system does not create the aggregated billable charge when one or more transaction legs have the same summary ID. If you do not specify the value for this option type, by default, the value is set to false .	

Option Type	Description	Mandatory (Yes or No)
Parallel Query Degree	<p>Used to specify the degree of parallelism that you want to use while creating chunks (i.e. work units) in various Transaction Feed Management (TFM) batches. The valid values are:</p> <ul style="list-style-type: none"> • 1 • 2 • 3 • 4 • 5 • 6 • 7 <p>Note:</p> <p>With the parallel query feature, multiple threads on the database can work together simultaneously to process a single SQL statement which is used to create chunks. This helps to improve the batch performance.</p> <p>The system calculates the number of threads on the database that can be used to execute the SQL statement by setting 2 to the power of the specified parallel query degree. For example, if you set the parallel query degree to 4, the system uses 16 (i.e. 2⁴) threads on the database to create work units.</p> <p>You must set the parallel query degree depending on the infrastructure available on the site. If you do not specify the value for this option type, by default, the parallel query degree is set to 2.</p>	No
Price Item Determination Batch Description	Used to specify the description for the batch which is used for validating the transaction and deriving the price item in the transaction aggregation cycle. For example, Validate Transaction and Derive Price Item . This description appears in the error message when the transaction aggregation batches are not executed in the specified sequence.	Yes

Option Type	Description	Mandatory (Yes or No)
Remove Duplicates from Accumulated Rule Output	<p>Used to indicate whether duplicate transaction legs must be created during the transaction aggregation cycle through the rule output accumulation process. The valid values are:</p> <ul style="list-style-type: none"> • true • false <p>Note: If you do not specify the value for this option type, by default, the value is set to false.</p>	No
Rule Output Accumulation	<p>Used to indicate whether the system should accumulate the output parameters of all rules where the criteria returns Rule Is True irrespective of whether the rule true action is set to Next Dependent, Next Rule by Priority, or Success and then create transaction legs using the accumulated output parameters. The valid values are:</p> <ul style="list-style-type: none"> • true • false <p>Note: If you do not specify the value for this option type, by default, the value is set to false.</p>	No
Show Default Values in Price Item Pricing	<p>Used to indicate whether the default values must appear in the Ignore Transaction, Aggregate Transaction, and Aggregation Schedule fields while defining the price item pricing. The valid values are:</p> <ul style="list-style-type: none"> • Y • N 	Yes
Use Materialized Views	<p>Used to indicate whether the price item pricing information must be cached in the CI_PRC_AGRD, CI_PRC_PL, and CI_PRC_INH_PL tables. The valid values are:</p> <ul style="list-style-type: none"> • true • false 	Yes
Maximum Price Item Parameters Cache Size	<p>Used to indicate the maximum number of price items whose parameter information can be cached in the memory.</p>	Yes
Maximum Price Item Parameter Groups Cache Size	<p>Used to indicate the maximum number of price item parameter groups whose information can be cached in the memory.</p>	Yes

Option Type	Description	Mandatory (Yes or No)
SQ Recalculation Required	<p>Used to indicate whether the SQIs in an aggregated billable charge must be recalculated while executing the C1-TXNCU batch. The valid values are:</p> <ul style="list-style-type: none"> • Y • N <p>Note: If you do not specify the value for this option type or if you set the value to N, the system will not recalculate the SQIs in an aggregated billable charge.</p>	No
Transaction Detail Account Validation	<p>Used to indicate whether the account must be validated during the transaction validation process. The valid values are:</p> <ul style="list-style-type: none"> • Y • N <p>Note:</p> <p>If you set this option type to N, the system overrides the transaction's account identifier type, account identifier, and division with the first derived account's account identifier type, account identifier, and division, respectively.</p> <p>If you do not specify the value for this option type, the system will validate the account during the transaction validation process.</p>	No
Populate Summary Table Batch Description	<p>Used to specify the description for the batch which is used for adding a summary record in the CI_TXN_DTL_PRITM_SUMMARY table. For example, Populate CI_TXN_DTL_PRITM_SUMMARY Table. This description appears in the error message when the transaction aggregation batches are not executed in the specified sequence.</p>	<p>Yes (Conditional)</p> <p>Note: This data is required when the Use C1-TXNPS During Transaction Aggregation option type is set to true.</p>
Find Price Item Pricing Batch Description	<p>Used to specify the description for the batch which is used for finding the price item pricing for transactions in the transaction aggregation cycle. For example, Price Item Pricing Verification. This description appears in the error message when the transaction aggregation batches are not executed in the specified sequence.</p>	Yes

Option Type	Description	Mandatory (Yes or No)
Update Transaction Status Batch Description	Used to specify the description for the batch which is used for updating the status of the transactions (for which the error has occurred) in the transaction aggregation cycle. For example, Update Status . This description appears in the error message when the transaction aggregation batches are not executed in the specified sequence.	Yes
Service Quantity Calculation Batch Description	Used to specify the description for the batch which is used for creating the billable charges for transactions in the transaction aggregation cycle. For example, Service Quantity Calculation . This description appears in the error message when the transaction aggregation batches are not executed in the specified sequence.	Yes
Transaction Completion Batch Description	Used to specify the description for the batch which is used for updating the status of the transactions in the transaction aggregation cycle. For example, Mark Completion . This description appears in the error message when the transaction aggregation batches are not executed in the specified sequence.	Yes
Cleanup Unwanted Data Batch Description	Used to specify the description for the batch which is used for updating or deleting billable charges created for transactions in the transaction aggregation cycle. For example, Clean Up . This description appears in the error message when the transaction aggregation batches are not executed in the specified sequence.	Yes

Option Type	Description	Mandatory (Yes or No)
Use C1-TXNPS During Transaction Aggregation	<p>Used to indicate whether you want to use an alternative transaction aggregation process when the aggregation ratio is low. The valid values are:</p> <ul style="list-style-type: none"> • true • false <p>Note: If you set this option type to true, you need to execute the following batches in the specified order in the transaction aggregation cycle:</p> <ol style="list-style-type: none"> 1. Flush All Caches (F1-FLUSH) 2. Refresh Pricing (C1-TXNRP) 3. Header Validation (C1-TXNHV) 4. Validate Transaction and Derive Price Item (C1-TXNIP) 5. Populate CI_TXN_DTL_PRITM_SUMMARY Table (C1-TXNPS) 6. Price Item Pricing Verification (C1-TXNVP) 7. Update Status (C1-TXNEX) 8. Service Quantity Calculation (C1-TXNSQ) 9. Mark Completion (C1-TXNCM) 10. Clean Up (C1-TXNCU) with the Request Type parameter set to EROR 	No

6. Enter the values for the required option types in the **Feature Configuration** screen.
7. Click the **Save** button in the **Page Title** area.

The changes made to the feature configuration are saved.

Setting the C1-OFFSETREQ Feature Configuration

The **C1-OFFSETREQ** feature configuration enables the system to determine whether the completed debit or credit bills of the effective child persons of the main customer (whose bill is added as the primary bill in the offset request) should be listed when you search for a bill in the offset request.

Procedure

To set the **C1-OFFSETREQ** feature configuration:

1. Click the **Admin** link in the **Application** toolbar.
A list appears.
2. From the **Admin** menu, select **F** and then click **Feature Configuration**.
A sub-menu appears.
3. Click the **Search** option from the **Feature Configuration** sub-menu.
The **Feature Configuration Search** window appears.
4. Enter **C1-OFFSETREQ** in the **Feature Name** field.
5. Click the **Search** button corresponding to the **Feature Name** field.

The **Feature Configuration** screen appears. It contains the following option type:

Option Type	Description	Mandatory (Yes or No)
Allow Offsetting Across Persons	Used to indicate whether you want to offset bills across main customer's hierarchy. The valid values are: <ul style="list-style-type: none"> • Y - Used when you want to offset one or more bills of the main customer against one or more bills of the same or other accounts of the main customer or against one or more bills of the accounts of its effective child persons. • N - Used when you want to offset one or more bills of the main customer against one or more bills of the same or other accounts of the main customer. 	Yes

6. Enter the value for the required option type in the **Feature Configuration** screen.
7. Click the **Save** button in the **Page Title** area.
The changes made to the feature configuration are saved.

Related Topics

For more information on...	See...
How to add a debit or credit bill to an offset request	Adding a Debit or Credit Bill to an Offset Request on page 1608

Setting the C1-PAYPORTAL Feature Configuration

Procedure

To set the **C1-PAYPORTAL** feature configuration:

1. Click the **Admin** link in the **Application** toolbar.
A list appears.
2. From the **Admin** menu, select **F** and then click **Feature Configuration**.
A sub-menu appears.
3. Click the **Search** option from the **Feature Configuration** sub-menu.
The **Feature Configuration Search** window appears.

4. Enter **C1-PAYPORTAL** in the **Feature Name** field.
5. Click the **Search** button corresponding to the **Feature Name** field.

The **Feature Configuration** screen appears. It contains the following option types:

Option Type	Description	Mandatory (Yes or No)
Allow Overpayment	Used to indicate whether you want to allow overpayment against an entity while editing the payment amount. The valid values are: <ul style="list-style-type: none"> • true • false 	Yes
FK Reference for Bill	Used to indicate the foreign key reference which generates the information string for a bill in the Edit Payment Amount screen. Note: The C1-BLACT foreign key reference for bill is shipped with the product. You can also create a custom foreign key reference, if required.	Yes
FK Reference for Bill Segment	Used to indicate the foreign key reference which generates the information string for a bill segment in the Edit Payment Amount screen. Note: The C1-BSEG foreign key reference for bill segment is shipped with the product. You can also create a custom foreign key reference, if required.	Yes
FK Reference for Contract	Used to indicate the foreign key reference which generates the information string for a contract in the Edit Payment Amount screen. Note: The C1_F_SA foreign key reference for contract is shipped with the product. You can also create a custom foreign key reference, if required.	Yes
FK Reference for Settlement	Used to indicate the foreign key reference which generates the information string for a settlement ID in the Edit Payment Amount screen. Note: At present, no foreign key reference for settlement ID is shipped with the product. Only the settlement ID appears in the information string. You can create a foreign key reference for settlement ID and specify it in this field.	No

6. Enter the values for the required option types in the **Feature Configuration** screen.
7. Click the **Save** button in the **Page Title** area.

The changes made to the feature configuration are saved.

Related Topics

For more information on...	See...
How to edit the payment amount against each entity	Editing the Payment Amount on page 1511

Setting the C1_PER_REL Feature Configuration

You can define person to person relationship type sequence in the **C1_PER_REL** feature configuration. This sequence is used while searching for effective price item pricing at the parent customer level.

Procedure

To set the **C1_PER_REL** feature configuration:

1. Click the **Admin** link in the **Application** toolbar.
A list appears.
2. From the **Admin** menu, select **F** and then click **Feature Configuration**.
A sub-menu appears.
3. Click the **Search** option from the **Feature Configuration** sub-menu.
The **Feature Configuration Search** window appears.
4. Enter **C1_PER_REL** in the **Feature Name** field.
5. Click the **Search** button corresponding to the **Feature Name** field.

The **Feature Configuration** screen appears. It contains the following option types:

Option Type	Description	Mandatory (Yes or No)
Person to Person Relationship Type	Used to indicate the person to person relationship type. Note: If you want to define more than one relationship type in the feature configuration, you need to specify the sequence in which the relationship type should be considered while searching effective price item pricing at the parent customer level.	Yes

6. Enter the values for the required option types in the **Feature Configuration** screen.
7. Click the **Save** button in the **Page Title** area.

The changes made to the feature configuration are saved.

Related Topics

For more information on...	See...
Person to Person Relationship Type Sequence screen	Person to Person Relationship Type Sequence

Setting the C1_PERSTYPE Feature Configuration

The **C1_PERSTYPE** feature configuration enables the system to determine whether the entities should be created directly or through a customer registration object whenever a health care inbound message is processed. If the person type specified in the health care inbound message matches the person type specified in the **Bill Group Person Type**, **Parent Person Type**, or **TPA Person Type** option type of the **C1_PERSTYPE** feature configuration, the system creates or updates the person, account, policy, policy plan, and address through a customer registration object. Note that the memberships, pass-through billable charges, and pricing rules are created directly and not via customer registration object. However, if the person type specified in the health care inbound message does not match the person type specified in the **Bill Group Person Type**, **Parent Person Type**, or **TPA Person Type** option type, the system creates or updates the person and its other entities directly and not through a customer registration object.

Prerequisites

To set the **C1_PERSTYPE** feature configuration, you should have:

- Values defined for the **PER_OR_BUS_FLG** lookup field

Procedure

To set the **C1_PERSTYPE** feature configuration:

1. Click the **Admin** link in the **Application** toolbar.
A list appears.
2. From the **Admin** menu, select **F** and then click **Feature Configuration**.
A sub-menu appears.
3. Click the **Search** option from the **Feature Configuration** sub-menu.
The **Feature Configuration Search** window appears.
4. Enter **C1_PERSTYPE** in the **Feature Name** field.
5. Click the **Search** button corresponding to the **Feature Name** field.

The **Feature Configuration** screen appears. It contains the following option types:

Option Type	Description	Mandatory (Yes or No)
Bill Group Person Type	Used to specify the person type which indicates that the person is a bill group.	Yes (Conditional)
	Note: You must specify a value which is already defined in the PER_OR_BUS_FLG lookup field. It must be in the Active status.	Note: This data is required while creating a bill group through a health care inbound message.
Parent Person Type	Used to specify the person type which indicates that the person is a parent customer.	Yes (Conditional)
	Note: You must specify a value which is already defined in the PER_OR_BUS_FLG lookup field. It must be in the Active status.	Note: This data is required while creating a parent customer through a health care inbound message.

Option Type	Description	Mandatory (Yes or No)
TPA Person Type	Used to specify the person type which indicates that the person is a third party administrator.	Yes (Conditional)
	Note: You must specify a value which is already defined in the PER_OR_BUS_FLG lookup field. It must be in the Active status.	Note: This data is required while creating a TPA person through a health care inbound message.

- Enter the values for the required option types in the **Feature Configuration** screen.
- Click the **Save** button in the **Page Title** area.

The changes made to the feature configuration are saved.

Related Topics

For more information on...	See...
Health Care Inbound Message	Health Care Inbound Message on page 2080

Setting the C1_PPARM_FLG Feature Configuration

The **C1_PPARM_FLG** feature configuration enables the system to determine whether the multi parameter based pricing or variance parameter based pricing feature is enabled. For more information on how to define pricing for a price item or price item bundle based on multiple parameters, see [Multi Parameter Based Pricing](#). For more information on how to define pricing for a price item or price item bundle based on variance parameter, see [Variance Parameter Based Pricing](#).

Procedure

To set the **C1_PPARM_FLG** feature configuration:

- Click the **Admin** link in the **Application** toolbar.
A list appears.
- From the **Admin** menu, select **F** and then click **Feature Configuration**.
A sub-menu appears.
- Click the **Search** option from the **Feature Configuration** sub-menu.
The **Feature Configuration Search** window appears.
- Enter **C1_PPARM_FLG** in the **Feature Name** field.
- Click the **Search** button corresponding to the **Feature Name** field.

The **Feature Configuration** screen appears. It contains the following option type:

Option Type	Description	Mandatory (Yes or No)
Multi Price Parameter	Used to indicate whether you want to enable the multi parameter or variance parameter based pricing feature. The valid values are: <ul style="list-style-type: none"> • True - Used when you want to enable the multi parameter based pricing feature. • False - Used when you want to enable the variance parameter based pricing feature. 	Yes

6. Enter the value for the required option type in the **Feature Configuration** screen.
7. Click the **Save** button in the **Page Title** area.

The changes made to the feature configuration are saved.

Setting the C1_PR_REC Feature Configuration

Procedure

To set the **C1_PR_REC** feature configuration:

1. Click the **Admin** link in the **Application** toolbar.
A list appears.
2. From the **Admin** menu, select **F** and then click **Feature Configuration**.
A sub-menu appears.
3. Click the **Search** option from the **Feature Configuration** sub-menu.
The **Feature Configuration Search** window appears.
4. Enter **C1_PR_REC** in the **Feature Name** field.
5. Click the **Search** button corresponding to the **Feature Name** field.

The **Feature Configuration** screen appears. It contains the following option types:

Option Type	Description	Mandatory (Yes or No)
Effective Pricing RecordSet Limit	Used to specify the number of records that can be displayed in the Search Results section of the Effective Price Assignment zone. The value must be an integer and not in decimals. The maximum number of records that can be displayed are 5000. Note: If you enter the value as 0 or if you do not specify the value for the Effective Pricing RecordSet Limit option type, no records will be displayed in the Search Results section.	Yes

6. Enter the values for the required option types in the **Feature Configuration** screen.
7. Click the **Save** button in the **Page Title** area.

The changes made to the feature configuration are saved.

Related Topics

For more information on...	See...
Effective Price Assignment zone in the Pricing (Account) screen	Effective Price Assignments for Account
Effective Price Assignment zone in the Pricing (Person) screen	Effective Price Assignments for Person

Setting the C1_PRASNORDR Feature Configuration

The **C1_PRASNORDR** feature configuration enables the system to determine the manner in which price assignments should be searched for a global customer. For more information on how effective price item pricing is derived, see [Price Assignment Search Mechanism](#).

Prerequisites

To set the **C1_PRASNORDR** feature configuration, you should have:

- An algorithm defined using the **C1_PRASN_PP** algorithm type in the application

Procedure

To set the **C1_PRASNORDR** feature configuration:

1. Click the **Admin** link in the **Application** toolbar.
A list appears.
2. From the **Admin** menu, select **F** and then click **Feature Configuration**.
A sub-menu appears.
3. Click the **Search** option from the **Feature Configuration** sub-menu.
The **Feature Configuration Search** window appears.
4. Enter **C1_PRASNORDR** in the **Feature Name** field.
5. Click the **Search** button corresponding to the **Feature Name** field.

The **Feature Configuration** screen appears. It contains the following option type:

Option Type	Description	Mandatory (Yes or No)
Price Assignment Algorithm	Used to specify the algorithm using which the price assignment should be searched for a global customer. Note: You must specify an algorithm which is already defined in the system.	Yes

6. Enter the value for the required option type in the **Feature Configuration** screen.
7. Click the **Save** button in the **Page Title** area.

The changes made to the feature configuration are saved.

Related Topics

For more information on...	See...
Pricing (Person) screen	Pricing (Person)

Setting the C1_PRICING Feature Configuration

The **C1_PRICING** feature configuration enables the system to determine the following:

- The contract type that should be associated with a price item or price item bundle which is available for pricing.
- The priority that should be defaulted while assigning a price list to a person or an account from the user interface or through a business service.
- Whether the logs should be maintained when the **C1-GetAllAssignedPriceLists**, **C1-AssignPriceList**, **C1-GetEffectivePricing**, **C1-GetAccountRate**, **C1_PRICEASSIGN_SERVICE**, **C1-PriceAccount**, and **C1-GetPricing** business services are invoked.

Prerequisites

To set the **C1_PRICING** feature configuration, you should have:

- Contract types defined in the application

Procedure

To set the **C1_PRICING** feature configuration:

1. Click the **Admin** link in the **Application** toolbar.
A list appears.
2. From the **Admin** menu, select **F** and then click **Feature Configuration**.
A sub-menu appears.
3. Click the **Search** option from the **Feature Configuration** sub-menu.
The **Feature Configuration Search** window appears.
4. Enter **C1_PRICING** in the **Feature Name** field.
5. Click the **Search** button corresponding to the **Feature Name** field.

The **Feature Configuration** screen appears. It contains the following option types:

Option Type	Description	Mandatory (Yes or No)
Default Contract Type	Used to indicate the contract type that you want to associate with a price item or price item bundle which is available for pricing.	Yes
	Note: You must specify a contract type which is already defined in the system. You must ensure that the specified contract type is defined for all divisions in the system.	
Default Price List Priority	Used to indicate the default priority that should appear in the Price List Assignment screen when you assign a price list to a person or an account. You can then edit the priority, if required. It is also used when both the priority and priority indicator are not passed to the C1-AssignPriceList business service.	No
	Note: The value for this option type must be a positive integer.	

Option Type	Description	Mandatory (Yes or No)
Enable Service Logging	Used to indicate whether you want to maintain logs when the C1-GetAllAssignedPriceLists , C1-AssignPriceList , C1-GetEffectivePricing , C1-GetAccountRate , C1_PRICEASSIGN_SERVICE , C1-PriceAccount , and C1-GetPricing business services are invoked. The valid values are: <ul style="list-style-type: none"> • True • False 	No

6. Enter the values for the required option types in the **Feature Configuration** screen.
7. Click the **Save** button in the **Page Title** area.

The changes made to the feature configuration are saved.

Related Topics

For more information on...	See...
How to define a price item or price item bundle	Defining a Price Item or Price Item Bundle on page 785
How to edit a price item or price item bundle	Editing a Price Item or Price Item Bundle on page 836
How to copy a price item or price item bundle	Copying a Price Item or Price Item Bundle on page 816
How to assign a price list to a person	Assigning a Price List to a Person on page 904
How to assign a price list to an account	Assigning a Price List to an Account on page 901
How to assign a price list to one or more eligible persons	Assigning a Price List to One or More Eligible Persons on page 920
How to assign a price list to one or more eligible accounts	Assigning a Price List to One or More Eligible Accounts on page 918

Setting the C1-PYREQSRT Feature Configuration

Procedure

To set the **C1-PYREQSRT** feature configuration:

1. Click the **Admin** link in the **Application** toolbar.
A list appears.
2. From the **Admin** menu, select **F** and then click **Feature Configuration**.
A sub-menu appears.
3. Click the **Search** option from the **Feature Configuration** sub-menu.
The **Feature Configuration Search** window appears.
4. Enter **C1-PYREQSRT** in the **Feature Name** field.
5. Click the **Search** button corresponding to the **Feature Name** field.

The **Feature Configuration** screen appears. It contains the following option types:

Option Type	Description	Mandatory (Yes or No)
Bill	Used to sort columns by the selected option type. The table fields in CI_BILL table are used to set the values for the option type Bill . It also enables sorting by order. Its valid values are: <ul style="list-style-type: none"> • Ascending • Descending 	No
Bill Segment	Used to sort columns by the selected option type. The table fields in CI_BSEG table are used to set the values for the option type Bill Segment . It also enables sorting by order. Its valid values are: <ul style="list-style-type: none"> • Ascending • Descending 	No
Contract	Used to sort columns by the selected option type. The table fields in CI_SA table are used to set the values for the option type Contract . It also enables sorting by order. Its valid values are: <ul style="list-style-type: none"> • Ascending • Descending 	No

Note: Above options types are configured for the **Sort By** field for sorting columns on the **Edit Payment Amount** screen.

6. Enter the values for the required option types in the **Feature Configuration** screen.
7. Click the **Save** button in the **Page Title** area.

The changes made to the feature configuration are saved.

Setting the C1_RLENG Feature Configuration

Procedure

To set the **C1_RLENG** feature configuration:

1. Click the **Admin** link in the **Application** toolbar.
A list appears.
2. From the **Admin** menu, select **F** and then click **Feature Configuration**.
A sub-menu appears.
3. Click the **Search** option from the **Feature Configuration** sub-menu.
The **Feature Configuration Search** window appears.
4. Enter **C1_RLENG** in the **Feature Name** field.
5. Click the **Search** button corresponding to the **Feature Name** field.

The **Feature Configuration** screen appears. It contains the following option types:

Option Type	Description	Mandatory (Yes or No)
Logging Rules for Transaction Feed	Used to indicate whether a log should be generated when you execute the Transaction Validation and Initial Product Determination (C1-TXNIP) batch. The valid values are: <ul style="list-style-type: none"> • True • False 	Yes
	Note: This log indicates the rules that were executed for each transaction and whether each rule passed or failed during the execution.	
Maximum Number of Rules in Cache	Used to indicate the maximum number of rules whose entry should be created in the log file.	Yes

6. Enter the values for the required option types in the **Feature Configuration** screen.

7. Click the **Save** button in the **Page Title** area.

The changes made to the feature configuration are saved.

Related Topics

For more information on...	See...
Transaction Feed Management	Transaction Feed Management on page 1139

Setting the C1-TXNDMYID Feature Configuration

For manually added transactions, the system can generate header details including the header ID automatically if you set the option types in the **C1-TXNDMYID** feature configuration.

Procedure

To set the **C1-TXNDMYID** feature configuration:

1. Click the **Admin** link in the **Application** toolbar.
A list appears.
2. From the **Admin** menu, select **F** and then click **Feature Configuration**.
A sub-menu appears.
3. Click the **Search** option from the **Feature Configuration** sub-menu.
The **Feature Configuration Search** window appears.
4. Enter **C1-TXNDMYID** in the **Feature Name** field.
5. Click the **Search** button corresponding to the **Feature Name** field.

The **Feature Configuration** screen appears. It contains the following option types:

Option Type	Description	Mandatory (Yes or No)
Dummy File Name	Used to specify the dummy file name.	Yes
Dummy Header ID	Used to specify the dummy header ID.	Yes

Option Type	Description	Mandatory (Yes or No)
Dummy Transaction Source	Used to specify the dummy transaction source.	Yes
Dummy Header Date	Used to specify the dummy header date.	Yes

- Enter the values for the required option types in the **Feature Configuration** screen.
- Click the **Save** button in the **Page Title** area.

The changes made to the feature configuration are saved.

Related Topics

For more information on...	See...
Transaction Feed Management	Transaction Feed Management on page 1139

Setting the C1-PAYFLUPLD Feature Configuration

Procedure

To set the **C1-PAYFLUPLD** feature configuration:

- Click the **Admin** link in the **Application** toolbar.
A list appears.
- From the **Admin** menu, select **F** and then click **Feature Configuration**.
A sub-menu appears.
- Click the **Search** option from the **Feature Configuration** sub-menu.
The **Feature Configuration Search** window appears.
- Enter **C1-PAYFLUPLD** in the **Feature Name** field.
- Click the **Search** button corresponding to the **Feature Name** field.

The **Feature Configuration** screen appears. It contains the following option types:

Option Type	Description	Mandatory (Yes or No)
Payment Portal Thread Count	Used to specify the number of threads you want to spawn in parallel. This value is used when a batch job is automatically created for the Create Payments from Payment Staging Records (PUPL) batch.	No
	Note: By default, the value is set to 5 . You can change the value, if required.	
Thread Pool Name	Used to specify the thread pool on which you want to execute the batch. This value is used when a batch job is automatically created for the following batches: <ul style="list-style-type: none"> Upload Payment Records in Pre-Staging Area (C1-PYUP1) Move Payment Records to Staging Area (C1-PYUP2) Create Payments from Payment Staging Records (PUPL) 	No

6. Enter the values for the required option types in the **Feature Configuration** screen.
7. Click the **Save** button in the **Page Title** area.

The changes made to the feature configuration are saved.