PeopleSoft FSCM 9.2: PeopleSoft Cost Management

December 2021

PeopleSoft FSCM 9.2: PeopleSoft Cost Management
Copyright © 1988, 2021, Oracle and/or its affiliates.

This software and related documentation are provided under a license agreement containing restrictions on use and disclosure and are protected by intellectual property laws. Except as expressly permitted in your license agreement or allowed by law, you may not use, copy, reproduce, translate, broadcast, modify, license, transmit, distribute, exhibit, perform, publish, or display any part, in any form, or by any means. Reverse engineering, disassembly, or decompilation of this software, unless required by law for interoperability, is prohibited.

The information contained herein is subject to change without notice and is not warranted to be error-free. If you find any errors, please report them to us in writing.

If this is software or related documentation that is delivered to the U.S. Government or anyone licensing it on behalf of the U.S. Government, then the following notice is applicable:

U.S. GOVERNMENT END USERS: Oracle programs (including any operating system, integrated software, any programs embedded, installed or activated on delivered hardware, and modifications of such programs) and Oracle computer documentation or other Oracle data delivered to or accessed by U.S. Government end users are "commercial computer software" or "commercial computer software documentation" pursuant to the applicable Federal Acquisition Regulation and agency-specific supplemental regulations. As such, the use, reproduction, duplication, release, display, disclosure, modification, preparation of derivative works, and/or adaptation of i) Oracle programs (including any operating system, integrated software, any programs embedded, installed or activated on delivered hardware, and modifications of such programs), ii) Oracle computer documentation and/or iii) other Oracle data, is subject to the rights and limitations specified in the license contained in the applicable contract. The terms governing the U.S. Government's use of Oracle cloud services are defined by the applicable contract for such services. No other rights are granted to the U.S. Government.

This software or hardware is developed for general use in a variety of information management applications. It is not developed or intended for use in any inherently dangerous applications, including applications that may create a risk of personal injury. If you use this software or hardware in dangerous applications, then you shall be responsible to take all appropriate fail-safe, backup, redundancy, and other measures to ensure its safe use. Oracle Corporation and its affiliates disclaim any liability for any damages caused by use of this software or hardware in dangerous applications.

Oracle and Java are registered trademarks of Oracle and/or its affiliates. Other names may be trademarks of their respective owners.

Intel and Intel Inside are trademarks or registered trademarks of Intel Corporation. All SPARC trademarks are used under license and are trademarks or registered trademarks of SPARC International, Inc. AMD, Epyc, and the AMD logo are trademarks or registered trademarks of Advanced Micro Devices. UNIX is a registered trademark of The Open Group.

This software or hardware and documentation may provide access to or information about content, products, and services from third parties. Oracle Corporation and its affiliates are not responsible for and expressly disclaim all warranties of any kind with respect to third-party content, products, and services unless otherwise set forth in an applicable agreement between you and Oracle. Oracle Corporation and its affiliates will not be responsible for any loss, costs, or damages incurred due to your access to or use of third-party content, products, or services, except as set forth in an applicable agreement between you and Oracle.

Documentation Accessibility

For information about Oracle's commitment to accessibility, visit the Oracle Accessibility Program website at <http://www.oracle.com/pls/topic/lookup?ctx=acc&id=docacc>.

Access to Oracle Support

Oracle customers that have purchased support have access to electronic support through My Oracle Support. For information, visit <http://www.oracle.com/pls/topic/lookup?ctx=acc&id=info> or visit <http://www.oracle.com/pls/topic/lookup?ctx=acc&id=trs> if you are hearing impaired.

Contents

- Preface: Preface.....xi**
- Understanding the PeopleSoft Online Help and PeopleBooks..... xi
- Hosted PeopleSoft Online Help..... xi
- Locally Installed Help..... xi
- Downloadable PeopleBook PDF Files.....xi
- Common Help Documentation.....xi
- Field and Control Definitions..... xii
- Typographical Conventions..... xii
- ISO Country and Currency Codes..... xii
- Region and Industry Identifiers..... xiii
- Translations and Embedded Help..... xiii
- Using and Managing the PeopleSoft Online Help..... xiv
- PeopleSoft FSCM Related Links..... xiv
- Contact Us..... xiv
- Follow Us..... xiv
- Chapter 1: Getting Started With PeopleSoft Supply Chain Management Cost Management.....17**
- PeopleSoft SCM Cost Management Overview..... 17
- Common Elements Used in Cost Management..... 18
- PeopleSoft SCM Cost Management Business Processes..... 20
- PeopleSoft SCM Cost Management Integration..... 20
- PeopleSoft SCM Cost Management Implementation..... 23
- Chapter 2: Structuring Your Cost Management System..... 27**
- Understanding Cost Structure..... 27
- Common Elements Used to Understand Cost Structure..... 31
- Setting Up the Cost Structure..... 32
- Pages Used to Define Cost Structure..... 32
- Establishing PeopleSoft General Ledger Business Units, Ledger Groups, and Ledgers..... 34
- Books Page..... 34
- Cost Types Page..... 35
- Associating Cost Books with PeopleSoft Inventory Business Units, Ledgers, and Ledger
 Groups..... 38
- Cost Profiles Page..... 42
- Cost Profile Groups - Books Page..... 51
- Associating Items With Cost Books and Cost Profiles..... 53
- Cost Elements Page..... 54
- Attaching Cost Elements to Generate Costs..... 56
- Determining Your Negative Inventory Strategy..... 57
- Pages Used to Determine Your Negative Inventory Strategy..... 58
- Selecting the Method to Number Accounting Lines..... 59
- Pages Used to Select the Method to Number Accounting Lines..... 61
- Enabling ChartField Security..... 61
- Chapter 3: Setting Up the Accounting Rules Structure..... 65**
- Understanding the Accounting Structure..... 65
- Common Elements Used in Accounting Structure..... 65
- Defining the Accounting Structure..... 66
- Pages Used to Define the Accounting Structure..... 67

Verifying Your PeopleSoft Financial Structure.....	68
Verifying That Cost Elements are Defined and Applied to Items.....	68
Using Transaction Group Codes.....	69
Distribution Type Page.....	73
Default Distribution Type Page.....	74
Using Item Groups.....	74
Accounting Rules Page.....	74
Defining Location Accounting.....	79
Pages Used to Define Location Accounting.....	80
Inventory Options Page.....	81
Using Storage Area Control.....	81
Storage Area Accounting Page.....	82
Production Area Accounts Page.....	83
Accounting Rules Page.....	83
Establishing Commitment Control.....	87
Defining Interunit Transfers.....	88
Setting Up Intraunit Processing.....	89
Designing Shipment On Behalf Of.....	89
Pages Used to Design Shipment on Behalf Of.....	94
Creating and Reversing Interunit Expensed Issues.....	95
Pages Used to Create and Reverse Interunit Expensed Issues.....	100
Chapter 4: Defining the Cost Foundation for Makeable Items.....	103
Understanding the Manufacturing Standard Cost Foundation.....	103
Defining the Standard Cost Foundation.....	104
Pages Used to Define the Standard Cost Foundation.....	104
Cost Types Page.....	105
Cost Versions Page.....	105
Standard Cost Groups Page.....	106
Cost Elements Page.....	107
Production Conversion Codes Page.....	107
Production Overhead Codes Page.....	108
Conversion Rates Page.....	109
Overhead Rates Page.....	111
Copy Cost Structures Page.....	113
Copy Cost Types/Versions Page.....	113
Update Conversion Rates Page.....	113
Calculating the Cost of Purchased Components.....	114
Pages Used to Calculate the Cost of Purchased Components.....	114
Understanding Component Costs.....	115
Forecasted Purchase Costs Page.....	116
Adding Additional Costs.....	117
Page Used to Add Additional Costs.....	117
Additional Item Costs Page.....	117
Chapter 5: Using Standard Costing for Purchased Items.....	121
Understanding Standard Costing for Purchased Items.....	121
Common Elements Used to Understand Standard Costing for Purchased Items.....	122
Calculating Standard Costs Using Cost Rollup Process.....	122
Pages Used to Calculate Standard Costs Using Cost Rollup.....	124
Cost Versions Page.....	124
Cost Groups Page.....	125
Forecasted Purchase Costs Page.....	126

Additional Item Costs Page.....	127
Cost Rollup Page.....	128
Reviewing Standard Cost Calculations.....	130
Pages Used to Review Standard Cost Calculations.....	130
Updating the Standard Costs and Inventory Values.....	130
Page Used to Update Standard Costs.....	132
Cost Update/Revalue Page.....	132
Reviewing Standard Costs Applied to Your Environment.....	133
Pages Used to Review Applied Standard Costs.....	133
Updating Standard Costs Manually.....	134
Page Used to Maintain Standard Costs Without Cost Rollup.....	134
Production Costs Page.....	134
Chapter 6: Using Standard Costing for Makeable Items.....	135
Understanding Production Costs.....	135
Common Elements Used to Understand Production Costs.....	137
Using the Cost Rollup Process to Calculate Product Costs.....	138
Understanding the Types of Cost Rollups.....	142
Rolling Up Costs with Multiple Outputs.....	143
Rolling Up Costs for Yield by Operation Items.....	146
Performing a Cost Rollup.....	146
Pages Used to Perform the Cost Rollup Process.....	147
Defining Item Default Values.....	148
Using the BOMs.....	150
Using Item Routings.....	150
Cost Rollup Page.....	151
Reviewing Calculated Costs.....	153
Pages Used to Review Calculated Costs.....	154
Costed BOM Page.....	155
Updating Production Costs.....	157
Page Used to Update Production Costs.....	158
Revaluing Inventory.....	158
Calculating WIP Inventory.....	159
Revaluing WIP Inventory.....	161
Cost Update/Revalue Page.....	162
Reviewing Standard Costs.....	163
Pages Used to Review Applied Standard Costs.....	163
Calculating Costs for PeopleSoft Supply Planning.....	165
Pages Used to Review Calculated Planning Costs.....	166
Production Option Costing Page.....	167
Chapter 7: Setting Up Actual and Average Costing for Makeable Items.....	169
Understanding Actual and Average Costing in Manufacturing.....	169
Common Elements Used to Set Up Actual and Average Costing for Makeable Items.....	176
Defining Actual and Average Costing for Makeable Items.....	177
Pages Used to Set Up Actual Costing in Makeable Items.....	178
Set Default Versions Page.....	178
Crew Actual Cost Page.....	179
Defining Item Default Values.....	180
Using the Bill of Materials.....	182
Using Item Routings.....	182
Grouping Production Schedules for Actual or Average Costing.....	183
Pages Used to Group Schedules for Actual Costing.....	183

Auto Numbering Page.....	184
Group Schedules Page.....	185
Auto Group Schedules Page.....	186
Ungroup Schedules Page.....	187
Chapter 8: Costing Transactions and Creating Accounting Entries.....	189
Understanding Transaction Costing and Accounting Entry Creation.....	189
Common Elements Used in Transaction Costing and Accounting Entry Creation.....	191
Generating Costs for Transaction Records.....	191
Costing Negative Inventory.....	192
Calculating Cost for Actual or Average Makeable Items.....	196
Returning Components to Inventory.....	197
Creating Accounting Entries.....	197
Creating Accounting Lines.....	198
Using Commitment Control.....	200
Acquiring Intraunit Entries.....	202
Setting the General Ledger Distribution Status.....	204
Creating Transaction Costs and Accounting Entries Processes.....	204
Page Used to Create Transaction Costs and Accounting Entries.....	205
Cost Accounting Creation Page.....	205
Reviewing and Changing Item Costing and Accounting Entries.....	210
Pages Used to Review and Change Item Costing and Accounting Entries.....	212
Cost Tolerance Control Page.....	217
Pending Transactions Page.....	222
Insufficient Qty Tool (insufficient quantity tool) Page.....	226
Edit Unposted Accounting Lines Page.....	228
CM Transaction Exceptions - Header Exceptions Page.....	230
Costing and Accounting for Consigned Inventory.....	232
Costing Consignable Items.....	233
Creating Inventory Accounting Lines for Consumed Consignment Inventory.....	233
Costing and Accounting for the Repair and Maintenance of Assets.....	234
Returning Perpetual Weighted Average Items to Inventory.....	235
Costing and Accounting for Vendor Managed Inventory.....	237
Calculating and Applying Purchase Price Variance and Exchange Rate Variance.....	237
Generating a PeopleSoft EPM Extract.....	242
Page Used to Generate a PeopleSoft EPM Extract.....	242
Chapter 9: Managing Actual and Average Costing.....	243
Understanding Average and Actual Costing.....	243
Common Elements Used in Average and Actual Costing.....	243
Reviewing Actual and Average Costing for Manufacturing.....	244
Pages Used to Review Actual Costs in Manufacturing Environments.....	244
Proactive Production Cost - PID Cost Page.....	245
Compare Cost Measures - Output Analysis Page.....	246
Managing the Actual Costing Method.....	248
Pages Used to Manage the Actual Costing Method.....	248
Understanding the Management of the Actual Cost Method.....	249
Adjust Actual Cost - Item Selection Page.....	249
Adjust Actual Cost - Production Selection Page.....	250
Adjust Actual Cost - Adjustment Detail Page.....	251
Administering the Average Cost Methods.....	253
Pages Used to Administer the Average Cost Methods.....	253
Understanding the Administration of the Average Cost Methods.....	254

Adjust Average Cost Page.....	255
Adjust Retro Costs Page.....	257
Chapter 10: Managing Interunit Transfer Pricing and Additional Costs.....	261
Understanding Interunit Transfers.....	261
Applying Transfer Prices to a Material Stock Request.....	262
Determining the Calculation Method for Transfer Prices.....	263
Recording the Accounting Entries for Transfer Prices.....	265
Understanding the Types of Interunit Transfers.....	268
Prerequisite To Manage Interunit Transfer Pricing and Additional Costs.....	271
Common Elements Used to Manage Interunit Transfer Pricing and Additional Costs.....	272
Using Transfer Pricing Definitions.....	272
Pages Used to Define Transfer Prices.....	272
Understanding Transfer Pricing Definitions.....	273
Transfer Pricing Definition Page.....	274
Copy Pricing Definition Page.....	284
Additional Transfer Price (Header Level) Page.....	286
Additional Transfer Price (Detail Level) Page.....	287
Reviewing Examples of Transfer Pricing.....	288
Populating the Transfer Price Table.....	293
Page Used to Populate the Transfer Price Table.....	293
Understanding the Transfer Price Feature.....	293
Calculate Transfer Price Page.....	294
Calculating Default Actual Cost and Current Purchase Cost.....	297
Page Used to Calculate Default Actual Cost and Current Purchase Cost.....	297
Understanding Costs.....	298
Update Default Actual Cost Page.....	299
Viewing Transfer Pricing Data for an Item.....	301
Pages Used to View Transfer Pricing Data for an Item.....	301
Transfer Price Inquiry Page.....	302
Reviewing Interunit Accounting Examples.....	303
Understanding Interunit Accounting Examples.....	303
Transferring Interunit Stock Using Only an Intransit Account.....	305
Transferring Interunit Stock Using Interunit Receivables and Payables.....	305
Transferring Interunit Stock Using the Interunit Sales Approach (Intercompany).....	310
Chapter 11: Structuring Landed Costs.....	317
Understanding Landed Costs.....	317
Setting Up Miscellaneous Landed Costs.....	318
Pages Used to Define Miscellaneous Landed Costs.....	319
Landed Cost Group Page.....	319
Cost Elements Page.....	320
Misc Charge/Landed Cost Defn Page.....	320
Misc Chg/Landed Cost Template Page.....	321
Miscellaneous Charges - Miscellaneous Page.....	322
Recording Estimated Landed Costs.....	325
Pages Used to Record Estimated Landed Costs.....	328
Recording Actual Landed Costs.....	328
Creating Inventory Adjustments and Variances for Landed Costs.....	329
Pages Used to Create Adjustments and Variances for Landed Costs.....	330
Landed Cost Extract Page.....	330
Landed Cost Extraction - Messages Page.....	332
LC Manual Close (landed cost manual close) Page.....	333

Cost Accounting Creation Page.....	333
Cost Accounting Creation Page.....	335
Reviewing Landed Costs.....	336
Adding Non-Recoverable Indian Duties and Taxes to the Item Cost.....	336
Chapter 12: Accounting for Returns to Vendor.....	339
Understanding Accounting for RTVs.....	339
Costing Methods Used for RTV Depletion.....	340
Costing Destroyed Material.....	340
Returning Consigned Inventory.....	340
Returning Subcontracted Material.....	341
Reviewing an RTV Example.....	341
Chapter 13: Reconciling PeopleSoft Cost Management and Payables.....	343
Understanding the CM/AP Reconciliation Tool Set.....	343
Using the CM/AP Reconciliation Tool Set.....	344
Pages Used to Reconcile PeopleSoft Cost Management and Payables.....	344
CM/AP Reconcile Page.....	345
CM/AP Reconciliation Summary Page.....	346
CM/AP Reconciliation Detail Page.....	348
Chapter 14: Analyzing Manufacturing.....	351
Understanding Production Analysis.....	351
Prerequisite To Analyze Manufacturing.....	351
Analyzing Production Variances for Standard Cost Items.....	351
Pages Used to Analyze Production Variances for Standard Cost Items.....	357
Posted Variance Drilldown Page.....	357
Analyzing WIP Inventory Value in Standard Cost Environments.....	359
Determining WIP Value.....	360
Analyzing Efficiency Variances and Work Center Utilization.....	362
Displaying Scrap and Standard Earned Conversion Costs.....	362
Pages Used to Display Scrap and Earned Conversion Costs.....	363
Displaying Actual Labor Information.....	364
Pages Used to Display Actual Labor Costs.....	364
Chapter 15: Analyzing Financial Transactions.....	365
Understanding Financial Transaction Analysis.....	365
Prerequisites To Analyze Financial Transactions.....	365
Common Elements Used to Analyze Financial Transactions.....	365
Using the Financial Inquiry Pages.....	368
Pages Used to View Transaction Entries.....	369
Using the Drilling Functions for Cost Accounting Audit Trails.....	373
Understanding Inventory Transactions.....	375
Understanding Earned Conversion Cost Transactions.....	378
Understanding Production Variance Transactions.....	378
Understanding Production Scrap Cost Transactions.....	380
Understanding Production Actual Cost Transactions.....	380
Understanding Standard Cost Revaluation Transactions.....	380
Understanding Average Cost Adjustment Transactions.....	381
Understanding Actual Cost Adjustment Transactions.....	381
Understanding Non-stock Shipment Transactions.....	382
Generating Reports of Financial Transactions.....	382
Pages Used to Report on Financial Transactions.....	383
Using the On Hand Value Report.....	383
Chapter 16: Additional Information for the Costing Structure.....	387

Using Transaction Groups.....	387
Understanding Inventory Transactions.....	387
Understanding Earned Conversion Cost Transactions.....	396
Understanding Production Variance Transactions.....	397
Understanding Production Scrap Cost Transactions.....	398
Understanding Production Actual Cost Transactions.....	399
Understanding Standard Cost Revaluation Transactions.....	402
Understanding Average Cost Adjustment Transactions.....	403
Understanding Actual Cost Adjustment Transactions.....	404
Understanding Non-stock Shipment Transactions.....	405
Using Costing Flow Diagrams.....	406
Chapter 17: Scenarios for PeopleSoft Cost Management.....	409
Understanding Troubleshooting.....	409
Example: Calculating Transaction Costing Based on the Cost Profile.....	409
Costing Lot Controlled Items.....	409
Costing FIFO/LIFO Items.....	414
Costing Average Cost Items.....	420
Costing Standard Cost Items.....	427
Example: Determining Your Cost Structure Strategy.....	434
Using One Cost Profile and One Book.....	434
Using Different Cost Profiles in a Business Unit.....	435
Using Different Cost Profiles in Different Business Units.....	436
Using Multiple Simultaneous Costing Methods in One Business Unit.....	436
Chapter 18: PeopleSoft Cost Management Reports.....	439
PeopleSoft Cost Management Reports: A to Z.....	439
PeopleSoft Cost Management Selected Reports.....	446
Common Element Used in This Section.....	446
CMS1000 - Average Cost Adjustment/PPV Report.....	446
CMS2000 - Item Cost Profiles Report.....	447
CMS2018 - WIP Value History Report.....	447
CMS3000 - Estimated vs. Actual Landed Costs Report.....	448
CMS3010 - Total Purchase Variance Report.....	448
CMS3020 - Standard Purchase Variance Report.....	448
CMS9010 - On Hand Balance Validation Report.....	449
INS7000 - Inventory Value Report.....	449
INS7050 - Accounting Register.....	450
INS7100 - Transaction Register.....	450
SFS1500 - Production Variance Report.....	450
SFS1600 - Potential Production Variance Report.....	451
SFS2005 - Efficiency/Utilization Report.....	451

Preface

Understanding the PeopleSoft Online Help and PeopleBooks

The PeopleSoft Online Help is a website that enables you to view all help content for PeopleSoft applications and PeopleTools. The help provides standard navigation and full-text searching, as well as context-sensitive online help for PeopleSoft users.

Hosted PeopleSoft Online Help

You can access the hosted PeopleSoft Online Help on the [Oracle Help Center](#). The hosted PeopleSoft Online Help is updated on a regular schedule, ensuring that you have access to the most current documentation. This reduces the need to view separate documentation posts for application maintenance on My Oracle Support. The hosted PeopleSoft Online Help is available in English only.

To configure the context-sensitive help for your PeopleSoft applications to use the Oracle Help Center, see [Configuring Context-Sensitive Help Using the Hosted Online Help Website](#).

Locally Installed Help

If you're setting up an on-premise PeopleSoft environment, and your organization has firewall restrictions that prevent you from using the hosted PeopleSoft Online Help, you can install the online help locally. See [Configuring Context-Sensitive Help Using a Locally Installed Online Help Website](#).

Downloadable PeopleBook PDF Files

You can access downloadable PDF versions of the help content in the traditional PeopleBook format on the [Oracle Help Center](#). The content in the PeopleBook PDFs is the same as the content in the PeopleSoft Online Help, but it has a different structure and it does not include the interactive navigation features that are available in the online help.

Common Help Documentation

Common help documentation contains information that applies to multiple applications. The two main types of common help are:

- Application Fundamentals
- Using PeopleSoft Applications

Most product families provide a set of application fundamentals help topics that discuss essential information about the setup and design of your system. This information applies to many or all applications in the PeopleSoft product family. Whether you are implementing a single application, some combination of applications within the product family, or the entire product family, you should be familiar with the contents of the appropriate application fundamentals help. They provide the starting points for fundamental implementation tasks.

In addition, the *PeopleTools: Applications User's Guide* introduces you to the various elements of the PeopleSoft Pure Internet Architecture. It also explains how to use the navigational hierarchy, components, and pages to perform basic functions as you navigate through the system. While your application or implementation may differ, the topics in this user's guide provide general information about using PeopleSoft applications.

Field and Control Definitions

PeopleSoft documentation includes definitions for most fields and controls that appear on application pages. These definitions describe how to use a field or control, where populated values come from, the effects of selecting certain values, and so on. If a field or control is not defined, then it either requires no additional explanation or is documented in a common elements section earlier in the documentation. For example, the Date field rarely requires additional explanation and may not be defined in the documentation for some pages.

Typographical Conventions

The following table describes the typographical conventions that are used in the online help.

<i>Typographical Convention</i>	<i>Description</i>
Key+Key	Indicates a key combination action. For example, a plus sign (+) between keys means that you must hold down the first key while you press the second key. For Alt+W , hold down the Alt key while you press the W key.
... (ellipses)	Indicate that the preceding item or series can be repeated any number of times in PeopleCode syntax.
{ } (curly braces)	Indicate a choice between two options in PeopleCode syntax. Options are separated by a pipe ().
[] (square brackets)	Indicate optional items in PeopleCode syntax.
& (ampersand)	When placed before a parameter in PeopleCode syntax, an ampersand indicates that the parameter is an already instantiated object. Ampersands also precede all PeopleCode variables.
⇒	This continuation character has been inserted at the end of a line of code that has been wrapped at the page margin. The code should be viewed or entered as a single, continuous line of code without the continuation character.

ISO Country and Currency Codes

PeopleSoft Online Help topics use International Organization for Standardization (ISO) country and currency codes to identify country-specific information and monetary amounts.

ISO country codes may appear as country identifiers, and ISO currency codes may appear as currency identifiers in your PeopleSoft documentation. Reference to an ISO country code in your documentation does not imply that your application includes every ISO country code. The following example is a country-specific heading: "(FRA) Hiring an Employee."

The PeopleSoft Currency Code table (CURRENCY_CD_TBL) contains sample currency code data. The Currency Code table is based on ISO Standard 4217, "Codes for the representation of currencies," and also relies on ISO country codes in the Country table (COUNTRY_TBL). The navigation to the pages where you maintain currency code and country information depends on which PeopleSoft applications you are using. To access the pages for maintaining the Currency Code and Country tables, consult the online help for your applications for more information.

Region and Industry Identifiers

Information that applies only to a specific region or industry is preceded by a standard identifier in parentheses. This identifier typically appears at the beginning of a section heading, but it may also appear at the beginning of a note or other text.

Example of a region-specific heading: "(Latin America) Setting Up Depreciation"

Region Identifiers

Regions are identified by the region name. The following region identifiers may appear in the PeopleSoft Online Help:

- Asia Pacific
- Europe
- Latin America
- North America

Industry Identifiers

Industries are identified by the industry name or by an abbreviation for that industry. The following industry identifiers may appear in the PeopleSoft Online Help:

- USF (U.S. Federal)
- E&G (Education and Government)

Translations and Embedded Help

PeopleSoft 9.2 software applications include translated embedded help. With the 9.2 release, PeopleSoft aligns with the other Oracle applications by focusing our translation efforts on embedded help. We are not planning to translate our traditional online help and PeopleBooks documentation. Instead we offer very direct translated help at crucial spots within our application through our embedded help widgets. Additionally, we have a one-to-one mapping of application and help translations, meaning that the software and embedded help translation footprint is identical—something we were never able to accomplish in the past.

Using and Managing the PeopleSoft Online Help

Select About This Help in the left navigation panel on any page in the PeopleSoft Online Help to see information on the following topics:

- Using the PeopleSoft Online Help
- Managing Hosted online help
- Managing locally installed PeopleSoft Online Help

PeopleSoft FSCM Related Links

[Oracle Help Center](#)

[Hosted Online Help](#)

[PeopleSoft Information Portal](#)

[My Oracle Support](#)

Financial and Supply Chain Management information for Search Framework search engine can be found in PeopleSoft Application Fundamentals documentation. For application specific information, see the "Understanding Search Pages within Components " (Application Fundamentals) topic.

[PeopleSoft Training from Oracle University](#)

[PeopleSoft Video Feature Overviews on YouTube](#)

[PeopleSoft Business Process Maps \(Microsoft Visio format\)](#)

[PeopleSoft Spotlight Series](#)

Contact Us

Send your suggestions to psoft-infodev_us@oracle.com.

Please include the applications update image or PeopleTools release that you're using.

Follow Us

<i>Field or Control</i>	<i>Description</i>
	YouTube

Field or Control	Description
	<u>Twitter@PeopleSoft_Info.</u>
	<u>PeopleSoft Blogs</u>
	<u>LinkedIn</u>

Getting Started With PeopleSoft Supply Chain Management Cost Management

PeopleSoft SCM Cost Management Overview

PeopleSoft SCM Cost Management provides the control and flexibility you need to manage costs throughout your inventory and manufacturing processes. With powerful features that support multiple methods of costing, PeopleSoft Cost Management enables you to model your business exactly as you require it. With PeopleSoft Cost Management, you can:

- Maintain multiple sets of books within an inventory business unit for financial, governmental, and management reporting purposes.
- Define any number of cost methods to value inventory transactions; including, standard, actual, FIFO actual, LIFO actual, by specific lot ID or serial ID, perpetual weighted average, retroactive perpetual weighted average, periodic weighted average, or non-cost.
- Determine the type of costing by item, inventory business unit, and cost book combination. This flexibility allows you to mix the type of costing within one inventory business unit; some items can use standard cost, other items can use actual cost, and so on. In addition, the same item can be costed differently using different cost books within the same inventory business unit.
- Calculate the cost of each inventory transaction, including, material, conversion, conversion overhead, landed, inbound, outbound, and other costs based on your cost methods. The system also calculates and updates weighted average costs, purchase price variances, exchange rate variances, negative inventory depletions, consigned items, and return to vendor items.
- Create accounting entries for all inventory transactions that have a financial impact on PeopleSoft Inventory and PeopleSoft Manufacturing. You can design transaction accounting for the basic transactions, location accounting, budget checking, interunit transfers, fund accounting, shipments on behalf of another revenue stream, and interunit expensed issues. These accounting entries can be posted to PeopleSoft General Ledger or a third-party general ledger system.
- Calculate and track costs for makeable items in PeopleSoft Manufacturing. You can calculate the costs of makeable items, co-products, and by-products using standard, actual, or average cost methods. Additional costs besides material, labor, machine, and conversion costs, can be added to makeable items. The system enables you to revalue costs, analyze manufacturing performance, and perform cost simulations. You can closely monitor production costs at every stage in PeopleSoft Manufacturing using inquiry tools and reports to detect potential production variances and analyze completed production.
- Manually adjust the actual or average cost of an item.
- Include landed cost charges in an item's cost, including freight, insurance, duty, taxes, handling, and subcontracted services. Adjustments to landed costs based on the voucher in PeopleSoft Payables can be recorded in a variance account or added to the final cost of the item.

- Record the cost of items transferred between inventory business units. The system calculates the correct transfer price based on the Transfer Pricing Definition component. Accounting entries are created based on your business configuration, including interunit sales and payable accounts if applicable.
- Reconcile the cost of putaways in PeopleSoft Inventory with the vouchers in PeopleSoft Payables using the CM/AP Reconciliation Tool.
- Review transaction costs and accounting entries using powerful inquiry tools and reports designed for financial and management accounting needs. You can monitor accounting entries before and after they are posted to the general ledger system.

Common Elements Used in Cost Management

<i>Field or Control</i>	<i>Description</i>
As of Date	The last date for which a report or process includes data.
Business Unit	An identification code that represents a high-level organization of business information. You can use a business unit to define regional or departmental units within a larger organization.
Description	Alphanumeric text up to 30 characters.
Effective Date	Date on which a table row becomes effective; the date that an action begins. For example, if you want to close out a ledger on June 30, the effective date for the ledger closing would be July 1. This date also determines when you can view and change the information. Pages or panels and batch processes that use the information use the current row.
EmplID (employee ID)	Unique identification code for an individual associated with your organization.
Language or Language Code	The language in which you want the field labels and report headings of your reports to print. The field values appear as you enter them. Language also refers to the language spoken by an employee, applicant, or non-employee.
Process Frequency (group box)	Designates the appropriate frequency in the Process Frequency group box: Once executes the request the next time the batch process runs. After the batch process runs, the process frequency is automatically set to Don't Run . Always executes the request every time the batch process runs. Don't Run ignores the request when the batch process runs.

Field or Control	Description
Process Monitor	This button takes you to the Process List page, where you can view the status of submitted process requests.
Report ID	The report identifier.
Report Manager	This button takes you to the Report List page, where you can view report content, check the status of a report, and see content detail messages (which show you a description of the report and the distribution list).
Run	This button takes you to the Process Scheduler request page, where you can specify the location where a process or job runs and the process output format.
Run Control ID	A request identification that represents a set of selection criteria for a report or process.
SetID	An identification code that represents a set of control table information or TableSets. A TableSet is a group of tables (records) necessary to define your organization's structure and processing options.
Short Description	Alphanumeric text up to 15 characters.
Standard Unit of Measure (UOM)	A type of unit used for quantifying in PeopleSoft systems, and usually associated with items. Depending on the application, units of measure might describe dimensions, weights, volumes, or amounts of locations, containers, or business activities. Examples include inches, pounds, workhours, and standard cost dollars.
Unit (Business Unit)	An identification code that represents a high-level organization of business information. You can use a business unit to define regional or departmental units within a larger organization.
User ID	The system identifier for the individual who generates a transaction.

See the product documentation for *PeopleTools: Process Scheduler* and *PeopleTools: Applications User's Guide*.

Related Links

"Understanding PeopleSoft ChartFields" (Application Fundamentals)

PeopleSoft SCM Cost Management Business Processes

This graphic lists the PeopleSoft Cost Management business processes:

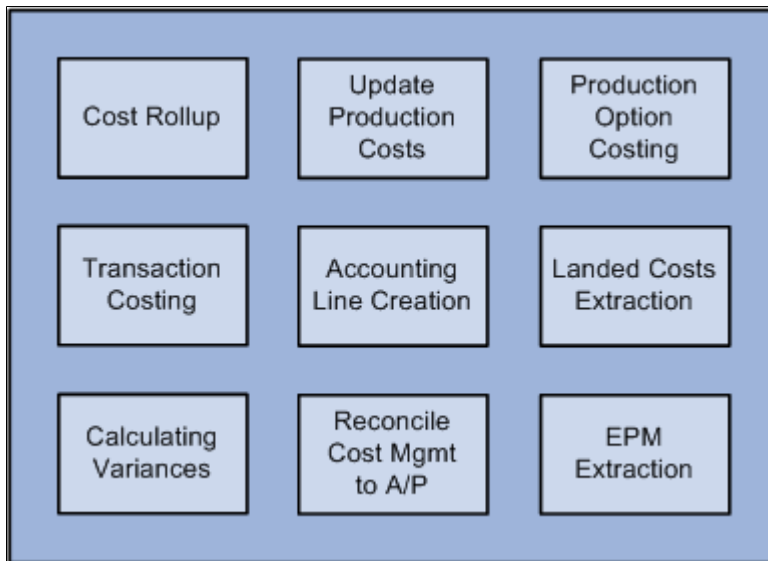

We cover these business processes in the business process topics.

PeopleSoft SCM Cost Management Integration

PeopleSoft Cost Management illustrates the integration between PeopleSoft Cost Management and other PeopleSoft FSCM applications:

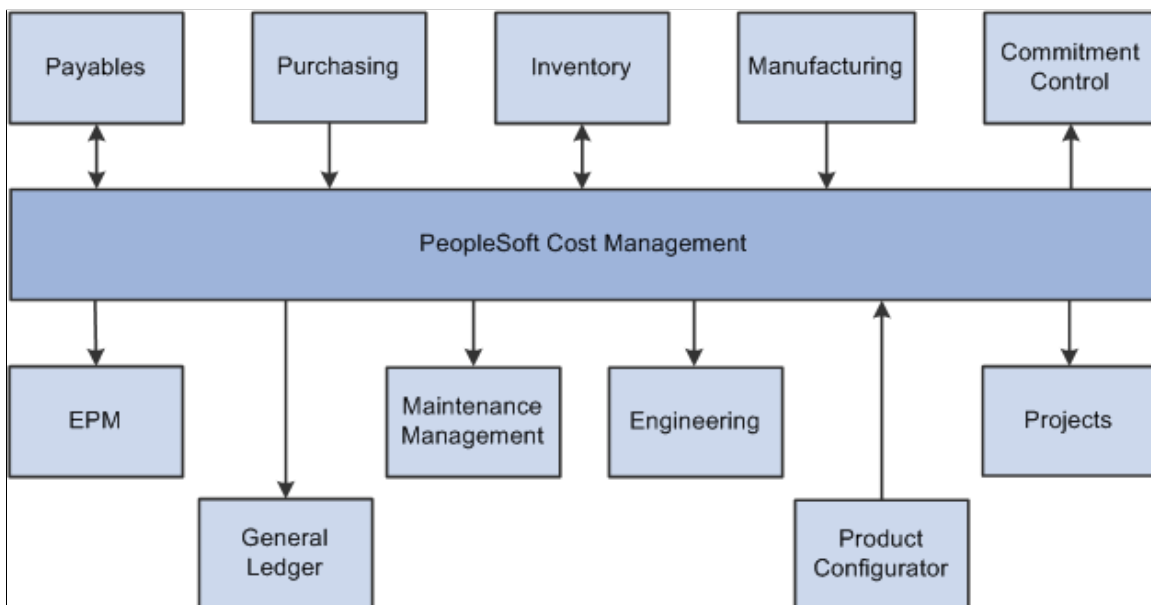

These PeopleSoft applications integrate with PeopleSoft Cost Management:

Inventory

Integration with PeopleSoft Inventory includes:

- PeopleSoft Cost Management calculates the cost and creates the accounting entries to record putaways, shipments, adjustments, and other material movements in PeopleSoft Inventory. PeopleSoft Cost Management receives costing information from PeopleSoft Purchasing, Payables, and Manufacturing to record and update the cost of stock in each inventory business unit.
- The Cost Rollup process in PeopleSoft Cost Management can calculate the costs of an inventory item. For manufactured items, the Update Production process (Cost Update/Revalue process page) then records these costs to be used when the item is putaway in PeopleSoft Inventory.

General Ledger

Integration with PeopleSoft General Ledger includes:

- Accounting entries recording the activity in PeopleSoft Inventory are retrieved from PeopleSoft Cost Management and used as input to create journal entries that are posted in the PeopleSoft General Ledger business unit tied to the Inventory business unit.
- PeopleSoft Cost Management enables you to analyze financial transactions online by using the financial inquiry pages. You can track financial transactions throughout the audit trail by drilling up to the journal entries in GL and drilling down to the accounting entries in PeopleSoft Cost Management.

Commitment Control

Integration with PeopleSoft Commitment Control includes:

- A requisition or purchase order is entered in PeopleSoft Purchasing using commitment control and a pre-encumbrance or encumbrance is established. If the purchase order is sourced from PeopleSoft Inventory, then the encumbrance is relieved and replaced with an expenditure against the budget when the Accounting Line Creation process in PeopleSoft Cost Management is run with the Budget Check Accounting Lines check box selected to run the Commitment Control Budget Processor.
- An expenditure is recorded in the budget when material stock request is created and stock is issued from PeopleSoft Inventory using a ChartField combination set up as a budgetary account for commitment control. The deduction to the budget occurs when you run the Accounting Line Creation process in PeopleSoft Cost Management with the Budget Check Accounting Lines check box selected.

Payables

Integration with PeopleSoft Payables includes:

- When a consigned item or VMI consigned item is consumed using any one of various transactions in PeopleSoft Inventory or Manufacturing, ownership of the items is transferred from the supplier to the business. The Transaction Costing and Accounting Line Creation processes in PeopleSoft Cost Management make consignment information available to PeopleSoft Payables for the creation of vouchers.
- The Landed Cost Extraction process in PeopleSoft Payables can pass cost adjustment information to PeopleSoft Cost Management for the stock putaways in inventory. These cost adjustments record differences between the purchase order cost and the voucher cost for direct material, subcontracted

costs, and other landed costs including taxes and freight. The Transaction Costing process within the Cost Accounting Creation process updates inventory putaways, depletions, and variances for the adjustments.

- When stock is returned to the supplier using the RTV feature, PeopleSoft Cost Management records an RTV variance for any differences between an item's RTV price on the debit memo derived from PeopleSoft Payables and the cost that is used to relieve the item from PeopleSoft Inventory.
- The CM/AP Reconcile process in PeopleSoft Cost Management retrieves accounting entries in PeopleSoft Payables and finds the matching accounting entire in PeopleSoft Cost Management. This reconciliation process highlights the entries that cannot be matched.

Engineering

PeopleSoft Engineering retrieves item information from PeopleSoft Cost Management and Inventory for the engineering workbench environment to help you manage product introduction and change processes throughout the enterprise.

Product Configurator

When putting away an inventory item that is configured using PeopleSoft Product Configurator, the item is stored using a lot ID and a configuration code. The cost of a configured item is calculated by the Cost Rollup process in PeopleSoft Cost Management based on the item ID and configuration code.

Purchasing

Integration with PeopleSoft Purchasing includes:

- When items on a purchase orders are received from the supplier in PeopleSoft Purchasing, the items can be put away in a PeopleSoft Inventory business unit using the putaway processes. PeopleSoft Cost Management calculates the cost of the receipts into inventory based on the purchase order price and any additional charges defined a miscellaneous charge codes (for example, landed costs).
- To return items that have been stocked in inventory, the data on the Return to Vendor (RTV) pages is entered in PeopleSoft Purchasing and passed to PeopleSoft Inventory where the items are shipped or adjusted. PeopleSoft Cost Management records an adjusting entry for the cost of the returned items.

Manufacturing

Integration with PeopleSoft Manufacturing includes:

- As PeopleSoft Manufacturing moves raw materials and subassemblies from inventory storage locations to WIP locations or directly to production, PeopleSoft Cost Management creates accounting entries to debit or credit storage locations as the materials move down the production line. This enables the system to accurately track the costs included in raw material and WIP at any point in time.
- After the make item is produced, completions are recorded and the item is putaway in PeopleSoft Inventory. The Transaction Costing process in PeopleSoft Cost Management calculates the cost of the make item once the production ID or production schedule is closed for accounting. Later, if additional costs are recorded in PeopleSoft Manufacturing, the Transaction Costing process adjusts the original putaway and any depletions based on the putaway.

EPM (Enterprise Performance Management)

Use the Generate EPM Extract process to pass costing data from PeopleSoft Cost Management to PeopleSoft EPM by populating an on-hand staging table. A PeopleSoft EPM process extracts data from this table, transforms it, and places it into a PeopleSoft EPM data warehouse.

Project Costing

The costing data for project-related transactions is retrieved from PeopleSoft Cost Management records by the PeopleSoft Project Costing application in order to create resource transactions.

Maintenance Management

PeopleSoft Maintenance Management is a product within the asset life cycle management suite. This product manages the maintenance and repair of an asset.

- PeopleSoft Cost Management provides estimated costs for each inventory item on a parts list or work order in PeopleSoft Maintenance Management.
- When items are issued from PeopleSoft Inventory to a work order, PeopleSoft Maintenance Management can provide overriding ChartField combinations. These account distribution overrides are used with the existing accounting logic in PeopleSoft Cost Management to create the necessary accounting entries.

We cover integration considerations in the implementation topics.

Supplemental information about third-party application integration is located on the My Oracle Support web site.

PeopleSoft SCM Cost Management Implementation

PeopleSoft Setup Manager enables you to generate a list of setup tasks for the organization based on the features that you are implementing. The setup tasks include the components that you must set up, listed in the order in which you must enter data into the component tables, and links to the corresponding documentation.

PeopleSoft Cost Management also provides component interfaces to help load data from the existing system into PeopleSoft Cost Management tables. Use the Excel to Component Interface utility with the component interfaces to populate the tables.

This table lists all of the components that have component interfaces:

Component	Component Interface	Reference
Distribution Type	CM_DISTR_TYPE_CI	See Distribution Type Page
Storage Area Accounting	STORAGE_ACCTS	See Using Storage Area Control
Production Conversion Codes	CE_CONCODE	See Production Conversion Codes Page

Component	Component Interface	Reference
Costing Conversion Overhead Rates	CE_CONV_OH_RATE	See Overhead Rates Page
Costing Conversion Rates	CE_CONV_RATE	See Conversion Rates Page
Forecasted Purchase Rates	CE_FCST	See Forecasted Purchase Costs Page
Additional Costs by Item	CE_ITEMEXP	See Adding Additional Costs
Conversion Overhead Codes	CE_OHCODE_CODE	See Production Overhead Codes Page
Transfer Pricing Definition	CM_TRAN_PRICE_CI	See Understanding Transfer Pricing Definitions
Floor and Ceiling Values	CM_VALUE_REF_PGRP	See Generating Reports of Financial Transactions
Assign Crew Actual Costs	CM_CREW_RATE	See Crew Actual Cost Page
Establish Actual Costs for Crew	CE_CREW_ACTCOST_CI	See Crew Actual Cost Page
InterUnit Transfer Accounting	INTERUNIT_DEF_INV	See "Interunit Ownership Page" (PeopleSoft Inventory)

PeopleSoft Events and Notifications Framework

As your organization processes the continuous stream of transactions within your PeopleSoft system, the events and notifications framework enables you to monitor the transaction flow and alert your organization to any errors, changes, and stalled transactions. The messages generated by the events and notifications framework can notify you of the problem, give you a detailed description of the issue, and provide a link to the PeopleSoft page where you can resolve it. One of the ways to use the events and notifications framework is to create PeopleSoft Queries on one or more PeopleSoft tables, add the alert using the Alert Setup component, and then complete the alert setup steps. This method enables you to monitor data within a PeopleSoft table; for example, searching for stalled transactions, instead of looking at the results of a PeopleSoft process. When the Alerts process (EOEN_ALERT) is run, the PeopleSoft table is queried and the alert messages can be generated. These messages can be routed to the appropriate person (PeopleSoft user or non-PeopleSoft user) using an email, a PeopleSoft worklist entry, an XML message, or the PeopleSoft Notification Dashboard.

For the PeopleSoft Cost Management application, sample data includes the following PeopleSoft queries that have been setup to work with the events and notifications framework. These queries may require minor modifications to work in your environment. You can also copy and alter these queries to create new alert messages.

Query	Process Name	Process Category	Description
CM_PENDING_TRANS	IN_ALERTS	CM_PENDING_TRANSACTION	Generates alert messages for costing transactions that are still pending. One alert message is created for each business unit and cost book combination. This PeopleSoft query uses the same logic as the Pending Transactions inquiry page in PeopleSoft Cost Management.
CM_ACCTG_LN_ERROR	IN_ALERTS	CM_ACCTG_LINE_ERROR	Generates alert messages for costing transactions which have an error that is preventing the creation of the accounting lines. One alert message is created per business unit.
CM_ACCTG_LN_UNPOST	IN_ALERTS	CM_ACCTG_LINE_UNPOST	Generates alert messages for costing transactions that have not been posted to the general ledger. One alert message is created for each business unit and cost book combination.

See *PeopleSoft Events and Notifications Framework*

Other Sources of Information

In the planning phase of the implementation, take advantage of all PeopleSoft sources of information, including the installation guides, table-loading sequences, data models, and business process maps. A complete list of these resources appears in the preface in the *PeopleSoft Application Fundamentals* with information about where to find the most current version of each.

Chapter 2

Structuring Your Cost Management System

Understanding Cost Structure

Costing structure determines how inventory transactions are calculated, where accounting entries are posted, and how many sets of books are maintained. PeopleSoft Cost Management gives you enormous flexibility in defining costing structure. You can choose to maintain any number of simultaneous books. Using different sets of books enables you to clearly track financial records, tax records, management records, and so on without any additional work. PeopleSoft Cost Management maintains all the books simultaneously.

PeopleSoft Cost Management also enables you to determine the type of costing by item, Inventory business unit, and cost book combination. This flexibility allows you to mix the type of costing within one inventory business unit. For example, one inventory business unit can have some items that use standard costing, other items that use actual costing, and so on. Also, one item can use different cost profiles in different business units.

In addition, the same item can be costed differently using different cost books within the same business unit. For example, an enterprise may want to track costs using local generally accepted accounting principles for financial reporting, and it may also want to track costs by using an internal activity based management model for decision-making purposes (product lines, marketing channels, target markets and so on). These two approaches can have different purposes and are often not compatible with each other; they each end with different answers as to what cost is. The power of the multiple book structure enables divergent cost approaches to be implemented in conjunction yet separate from each other.

This diagram illustrates the cost method relationships without using cost profile groups. Entering cost types and cost books on the Inventory business unit definition and defining the cost profile and cost element on the business unit item definition:

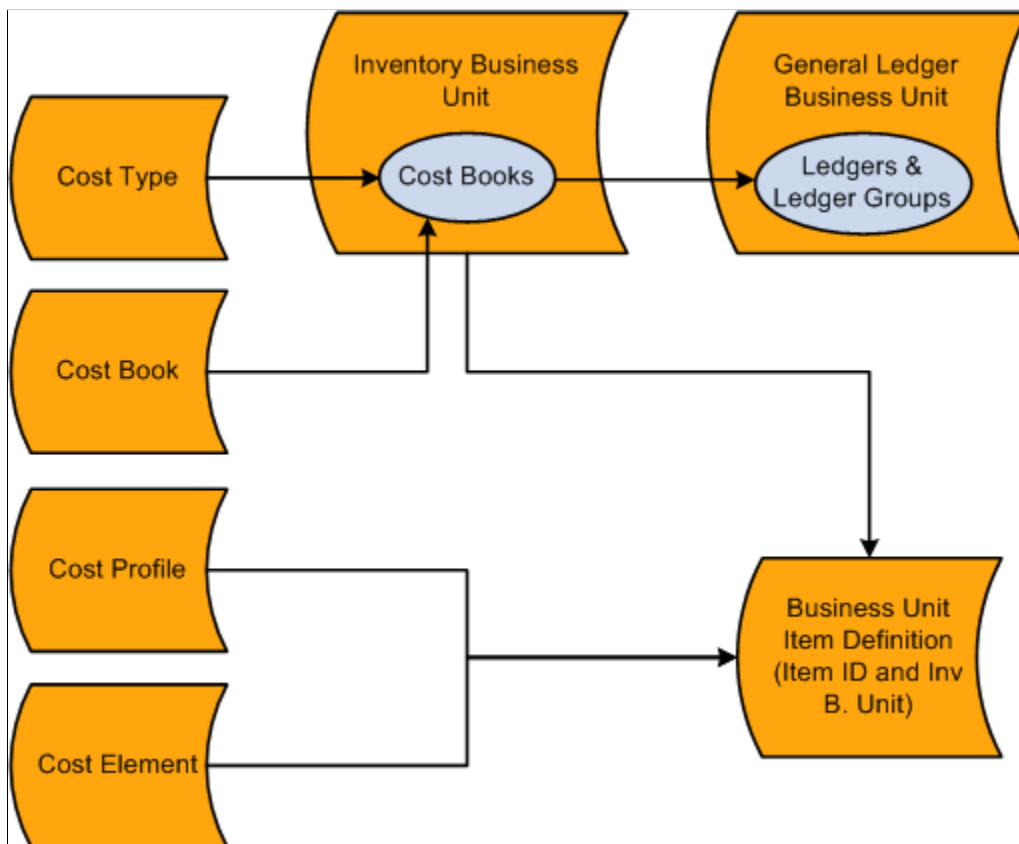

The diagram displays the different parts of the PeopleSoft Cost Management costing structure and how these parts are related to each other.

Cost Type

Cost types define a working space for cost calculations. You can define several different cost types, such as, current, revised, and forecasted costs. You calculate the cost of makeable items using cost types. Also, purchased items using the standard cost method can use cost type to calculate a standard cost. For example, in a manufacturing environment, cost books can use different cost types, enabling you to use GAAP rates for financial reporting and ABM rates for manufacturing reporting.

Cost Books

Define a separate cost book for each type of accounting records that you wish to maintain. For example, define a cost book for financial records, another cost book for tax records, management decision-making, and so on.

Inventory Business Units

When you define an inventory business unit, you identify the general ledger business unit that accepts the financial data. In addition, you define one or more combinations of cost books and ledger or ledger groups. The cost book is used to store accounting entries that are generated by inventory transactions. Each book enables you to use different cost methods; for example, a financials book can use standard

costing for items, and the tax book can use LIFO costing for items. You can define any number of simultaneous books to be used within an inventory business unit. Each inventory transaction that has a financial impact creates a separate set of accounting entries in each book that is assigned to it. The accounting entries are then posted to the specified ledger or ledger group (set of books) within PeopleSoft General Ledger.

Cost Profiles

Define the methods that are used to value the inventory items, such as standard costing, actual costing, and so on. In PeopleSoft Cost Management, you assign cost profiles to items to determine the cost method. There are a number of options for cost profiles that you may mix and match to suit your requirements. Different items or groups of items within a business unit may use different cost profiles and the same item in different business units may also use different cost profiles.

Cost Elements

Cost elements are used to categorize the different components of an item's cost, such as material, landed, conversions costs, additional transfer costs, and so on. Also, cost elements define the debit and credit ChartFields for each cost component of an item so that accounting entries can be created.

Business Unit Item Definition

The cost profile can be added here or appear default from a cost profile group that is defined at the item definition level.

This diagram illustrates the cost method relationships when using cost profile groups. Cost type and cost book are defined on the inventory business unit and the cost profile and cost book are entered on the cost profile group. The cost profile group is added to the item definition. When a business unit item definition is created the information is applied from the item definition and the business unit. Leaving only the cost element to be defined at the business unit item definition.

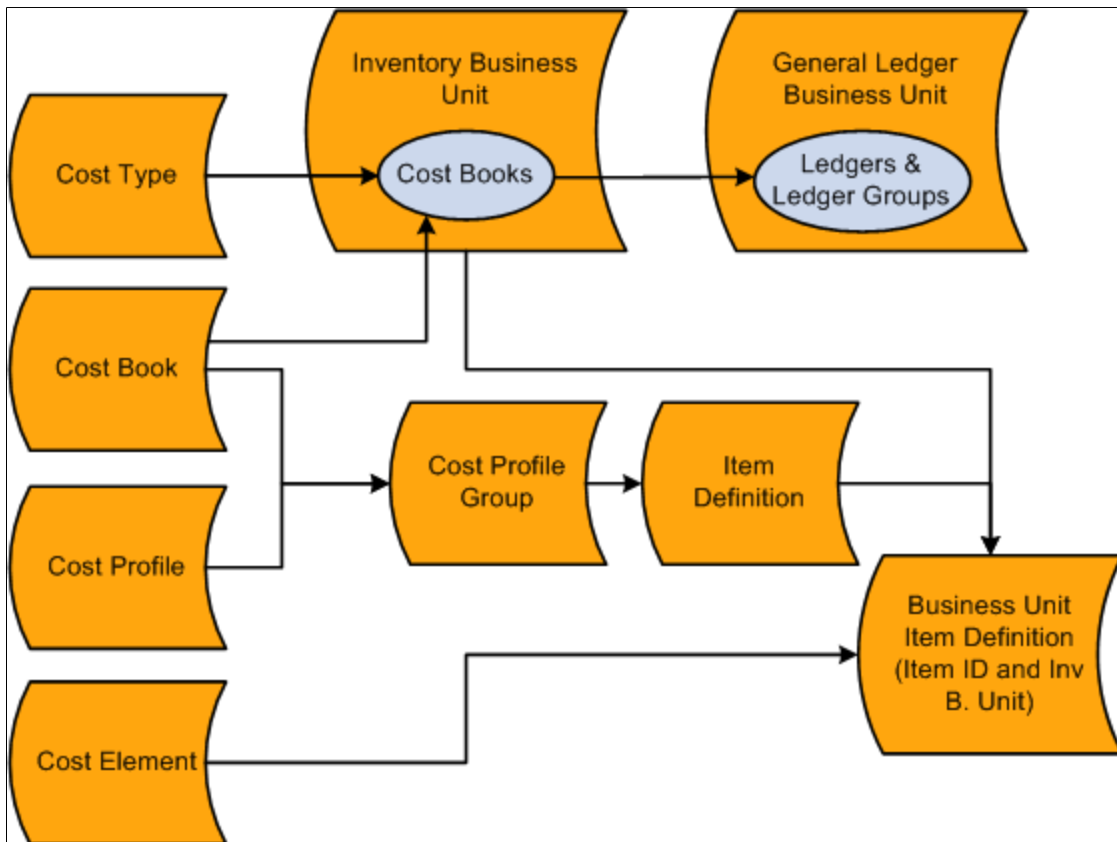

Cost Profile Groups

Cost profile groups are an optional step that enables you to define item costing for both efficient order entry and control. A cost profile group joins together a cost profile and a cost book that can be attached to multiple items. The cost profile group is attached to the Item Definition page, and then the cost profile group appears by default on the item's definition by inventory business unit, the Define Business Unit Item component. If the item uses the same cost profile and cost book across several inventory business units, then the cost profile group reduces the time that is needed to define item costing. Also, when defining a cost profile group you have the option to prevent users from changing the default cost profile and cost book on the Define Business Unit Item component; giving you a level of control over item setup.

Common Elements Used to Understand Cost Structure

<i>Field or Control</i>	<i>Description</i>
Book Name	The name of the cost book. A book contains a set of accounting entries that are posted to ledgers in the general ledger. An inventory business unit can have one or more cost books that post to ledgers within a ledger group in the general ledger.
Ledger Group	Within PeopleSoft General Ledger, you can group ledgers together into ledger groups. A ledger group provides the functionality for managing multibook transactions that must post to all ledgers within a group simultaneously.
Ledger	Within PeopleSoft General Ledger, ledgers organize the accounting data. You can define as many ledgers as you need to record financial, budget, and nonfinancial transactions.
Ledger Template	Within PeopleSoft General Ledger, defines the physical attributes of a ledger. It streamlines ledger definition. The template is defined once and used for multiple ledgers.
Book Status	The status of the cost book, including; <i>Pending, Active, Inactive, Stopped, and Cancel.</i>
Profile	The cost profile that determines the methods to value and cost inventory items and transactions. Items have cost profiles for the cost books that the inventory business unit uses.
Cost Profile Group	A grouping of the cost profile and cost book that can be attached to the item by using the Define Item component. Groups are used to default cost profiles into item definitions as items are added to an inventory business unit.
Cost Element	A code that is used to categorize the different components of an item's cost and also define the debit and credit ChartFields for accounting entries. Cost elements can be used to add an optional level of granularity to the accounting entries recorded.
Transaction Group	Predefined codes identifying different types of transactions, such as putaways, shipments, user adjustments, and so on.
Cost Type	Creates separate costing groupings with different methods of costing, such as current, revised, or forecasted costs.

Setting Up the Cost Structure

The cost structure determines how inventory transactions are calculated, where accounting entries are posted, and how many sets of books are maintained.

To set up cost structure:

1. Establish the ledgers and ledger groups for the PeopleSoft General Ledger business unit or verify that the financials implementation team creates them.
2. Define the cost books at the SetID level.
3. Define the cost types at the SetID level.
4. Associate the cost books and cost types with the PeopleSoft Inventory business units and ledgers or ledger groups.
5. Define the cost profiles at the SetID level.

You determine the receipt cost method, cost flow, and deplete cost method for the items. For an item that is manufactured with PeopleSoft Manufacturing, a cost profile also determines the costing method that is used to value labor and machine costs.

6. Create cost profile groups at the SetID level.

This page combines the cost book and cost profile.

7. Associate the inventory items with a cost book and a cost profile.

This can be done in the Define Item component or the Define Business Unit Item component.

8. Define the cost elements to categorize the different cost components for an item, including material, conversion, landed, additional transfer costs, and outbound costs.
9. Attach the cost element to the various PeopleSoft pages that generate costs.

For the material costs of the item, add the cost element that is defined for material to the item by using the Define Business Unit Item-General: Common page.

Note: Once you have read the information in this section, it is recommended that you review the examples in, "Scenarios for PeopleSoft Cost Management". Please review the sections on calculating transaction costing based on the cost profile and determining your cost structure strategy.

Pages Used to Define Cost Structure

<i>Page Name</i>	<i>Definition Name</i>	<i>Usage</i>
Books Page	CM_BOOK_DEFN	Create cost accounting books to identify the type of accounting records that are to be maintained. The books are added to the inventory business unit and the cost profile group.

Page Name	Definition Name	Usage
<u>Cost Types Page</u>	CE_TYPE	Create separate costing groupings with different methods of costing, such as current, revised or forecasting.
Ledger Group - Definition Page	LEDGER_GROUP	Define a ledger group and link it to a ledger template. Also used to assign ledger details to the group and to identify the unique attributes of each ledger within the group.
"Inventory Definition - Business Unit Definition Page" (PeopleSoft Inventory)	CM_BU_BOOK	Link the cost books and cost type with a PeopleSoft Inventory business unit, ledger, and ledger group. Define the books to populate with accounting entries for each business unit.
<u>Cost Profiles Page</u>	CM_PROFILE_DEFN	Establish the cost profile to determine how items are costed in the business unit's cost book.
Cost Profiles - Manufacturing Page	CM_PROFILE_DEF_MFG	For items that are used in PeopleSoft Manufacturing, enter additional cost profile information to define the costing methods for labor and machine costs.
Cost Profile Groups - Definition Page	CM_GROUP_DEFN	Define a cost profile group by entering a description and any comments.
<u>Cost Profile Groups - Books Page</u>	CM_GROUP_DETAIL	Link the cost book and cost profile together under the cost profile group.
Item Definition - General: Common Page	INV_ITEMS_DEFIN1	Enter a cost profile group for an item. Although this is not required, associating the items to a Cost Profile Group simplifies setup when defining items at the inventory business unit level.
Define Business Unit Item - General: Costing Page	CM_ITEM_METHOD	Define the cost profile of an item by business unit and cost book.
<u>Cost Elements Page</u>	CM_ELEMENT	Cost elements categorize the components of an item's cost. The system maintains an item's cost-by-cost element. Cost elements also help define the debit and credit ChartFields in transaction processing.

Page Name	Definition Name	Usage
"Define Business Unit Item - Manufacturing: General Page" (PeopleSoft Manufacturing)	GEN_ATTRIB_INV	Define the cost element for an item's material costs.

Related Links

[Example: Calculating Transaction Costing Based on the Cost Profile](#)

Establishing PeopleSoft General Ledger Business Units, Ledger Groups, and Ledgers

Before beginning the process of defining PeopleSoft Inventory business units, you need to establish PeopleSoft General Ledger business units, ledgers and ledger groups. Ledgers and ledger groups represent a set of books and store the posted financial entries (journal entries) by accounting period and fiscal year. Different ledgers can be defined for recording financial records, tax records, management reports, and so on.

Related Links

"Defining General Ledger Business Units" (PeopleSoft General Ledger)

"Linking Ledgers to a Ledger Group" (Application Fundamentals)

"Defining Ledgers for a Business Unit" (Application Fundamentals)

Books Page

To define the types of accounting records to maintain, use the Cost Book (CM_BOOK_DEFN) component.

Use the Books page (CM_BOOK_DEFN) to create cost accounting books to identify the type of accounting records that are to be maintained.

The books are added to the inventory business unit and the cost profile group.

Navigation:

Set Up Financials/Supply Chain > Product Related > Cost Accounting > Define Cost Books

This example illustrates the fields and controls on the Cost Books page. You can find definitions for the fields and controls later on this page.

The screenshot shows the 'Cost Books' page with the following fields and controls:

- SetID**: SHARE
- Book Name**: FIN
- *Description**: Financial Book
- IFRS Reporting**:
- Comment**: Book used for external financial reporting

Define a separate cost book for each type of accounting records that you want to maintain. For example, define a cost book for financial records; another cost book for tax records, and so on.

You can create any number of books and assign the books to a PeopleSoft Inventory business unit. Each book enables you to use different cost methods; for example, a financials book can use standard costing for items, and the tax book can use LIFO costing for items. You can define any number of simultaneous books to be used. Each inventory transaction that has a financial impact creates a separate set of accounting entries in each book that is assigned to it. The accounting entries are then posted to the specified ledger or ledger group within PeopleSoft General Ledger.

Select the IFRS Reporting check box to enable this cost book to support International Financial Reporting Standards (IFRS). This check box cannot be selected if the existing cost book uses the LIFO cost flow method. For additional information about setting up IFRS reporting, please see the Valuing Inventory for IFRS section within the Costing Transactions and Creating Accounting Entries topics.

Cost Types Page

To define cost types, use the Cost Types component (CE_TYPE).

Use the Cost Types page (CE_TYPE) to create separate costing groupings with different methods of costing, such as current, revised or forecasting.

Navigation:

Set Up Financials/Supply Chain > Product Related > Cost Accounting > Cost Types

Define different cost types, such as current, revised, and forecasted costs, to create a working space with which you can perform what-if analysis. You calculate the cost of a manufactured item based on cost types. Purchased or make items using the standard cost method can use cost types to calculate a standard cost. Cost types are used as a key to conversion costs and overhead conversion costs to calculate both standard cost and actual cost make items. The cost type is added to the Cost Rollup process page when calculating the cost of an item. For a manufactured item using an actual or average costing method, the cost type should be defined on the Inventory Definition-Business Unit Books page that is to be used by the Transaction Costing process (within the Cost Accounting Creation process) when computing the item cost.

Cost Types

SetID: SHARE CORPORATE SETID

Cost Types				
*Cost Type	Description	Short Desc	*Purchase Cost Used	
ABC	Activity Based Cost	AB Costs	Forecasted	+ -
AVE	Costs based on Wt Ave Material	Wt Ave	Average	+ -
CUR	Current Costs	Cur Costs	Current	+ -
FOR	Forecast Costs	Forecast	Forecasted	+ -
PRO	Proposed Costs	Prop Costs	Last Price	+ -
REPT	Reporting	Reporting	Current	+ -
REV	Revised Standards	Revised	Current	+ -

Select the method to calculate the cost of purchased components when computing the cost of an item. The method that you choose here applies to all cost versions using this cost type. Options for **Purchase Cost Used** include:

Field or Control	Description
<i>Average</i>	<p>Average cost. This represents a rolling weighted average cost calculated as: $[(\text{current average cost}) * (\text{current QOH})] + \{(\text{putaway qty}) * (\text{PO price for material only})\} / [(\text{current QOH}) + (\text{putaway qty})]$.</p> <p>QOH (quantity on hand).</p> <p>PO (purchase order).</p> <p>Qty (quantity).</p> <p>This cost is automatically updated in the Business Unit Item Definition record (the AVERAGE_COST_MAT field of the BU_ITEMS_INV record) when a purchase receipt is put away. The current value is displayed in the Avg Matl Cost field on the Define Business Unit Item-General: Common page. Use this cost when you want to reflect the supplier's price in the cost of the item. This average cost calculation only includes the material portion of the PO cost; it does not include landed costs, voucher updates, or cost adjustments. This average cost can be used by the Cost Rollup process to compute the material portion of the cost.</p>
<i>Current</i>	<p>The current purchase cost is a per unit cost which you manually enter in the Define Business Unit Item - General page (the CURRENT_COST field of the BU_ITEMS_INV record). Use current purchase cost if there is no need to vary material costs for cost simulations and what-if analysis.</p>
<i>Forecasted</i>	<p>Enter a forecasted purchase cost by a combination of item, business unit, cost type, and cost version using the Forecasted Purchase Costs page (CE_FCST_PUR record). Use forecasted costs when you want to manually maintain the material cost of purchased items. For example, you can base forecasted purchase costs on supplier quotes for items that are purchased during the standard cost period. If the purchase costs vary based on volume that is purchased from the supplier, you can set up two different versions and vary the forecasted cost for each version based on the volume assumptions.</p>
<i>Last Price</i>	<p>You can cost the item based on the price that is paid the last time that you purchased the item. This <i>Last Price</i> value (the LAST_PRICE_PAID field of the BU_ITEMS_INV record) is updated by the Complete Putaway process (PUTAWAY_REQ_INV) based on the PO price of the item's last receipt. Because it is constantly replaced, the value is an indication of an item's price at a specific point in time. In the cost calculation, you can use that price to represent the purchase cost of the component items.</p>

Related Links

[Adding Additional Costs](#)

"Define Business Unit Item - General: Common Page" (PeopleSoft Managing Items)

Associating Cost Books with PeopleSoft Inventory Business Units, Ledgers, and Ledger Groups

A critical step in designing the inventory business unit is to define the accounting links to the general ledger system. Use the Inventory Definition component to:

- Identify the PeopleSoft General Ledger business unit that accepts financial transactions by using the Inventory Definition - Business Unit Definition Page.

Only one general ledger business unit can be defined per inventory business unit.

- Define one or more combinations of cost book and ledger or ledger group for the inventory business unit by using the Inventory Definition - Business Unit Books Page.

When you attach a cost book, every financial transaction that is recorded in this inventory business unit creates accounting entries in that cost book. For example, let's assume that you identify two separate cost books, FIN and TAX, and an item is shipped from the inventory business unit. Two sets of accounting entries are recorded: one in the cost book FIN, and one in the cost book TAX. For each cost book that is defined for an inventory business unit, you must also define the ledger or ledger group that receives the accounting entries for the general ledger side. These ledgers and ledger groups must be part of the general ledger business unit that is defined for the inventory business unit.

- Identify the cost type for makeable items by using actual or average cost methods.

If makeable items use actual or average costing methods, then enter a cost type for each cost book. The cost type is used by the Transaction Costing process (within the Cost Accounting Creation process) when calculating the cost of an item that is manufactured in PeopleSoft Manufacturing. Cost types enable the Transaction Costing process to pick up the correct conversion rates and overhead conversion rates, plus any additional costs.

Designating the Primary Book

The inventory business unit must have at least one book. When you associate a cost book with a PeopleSoft Inventory business unit, one book must be designated as the primary book. This is done by associating it with the primary ledger or default ledger group for the PeopleSoft General Ledger business unit. These ledgers and groups are defined on the Ledger Group - Definition page. This page also contains a Keep Ledgers in Sync option.

If the Keep Ledgers in Sync option on the **Ledger** field is unavailable on the Ledger Group - Definition page, transactions are posted to all ledgers in the ledger group that you select for the book. Exactly one book for the business unit must be pointing to the default ledger group.

If the Keep Ledgers in Sync option is off, you can select the ledger within the ledger group to which you want to post transactions for the book. In that case, the primary book must be pointing to the primary ledger within the default ledger. With the option off, you can also leave the **Ledger** field blank and transactions are posted to all ledgers in the ledger group that you select for the book. In that case, the book must be pointing to the default ledger group.

If you select a primary ledger, it must use the base currency of the PeopleSoft Inventory business unit and PeopleSoft General Ledger business unit. If you select a default ledger group, the primary ledger of that ledger group must use the base currency of the PeopleSoft Inventory business unit and PeopleSoft General Ledger business unit.

Inventory Definition - Business Unit Books Page

Use the Inventory Definition - Business Unit Books page (CM_BU_BOOK) to link the cost books and cost type with a PeopleSoft Inventory business unit, ledger, and ledger group.

Define the books to populate with accounting entries for each business unit.

Navigation:

Set Up Financials/Supply Chain > Business Unit Related > Inventory > Inventory Definition > Business Unit Books

This example illustrates the fields and controls on the Inventory Definition - Business Unit Books page. You can find definitions for the fields and controls later on this page.

The screenshot displays the 'Business Unit Books' page. At the top, there are tabs for 'Business Unit Definition', 'Business Unit Options', 'Business Unit Counters', and 'Business Unit Books'. Below the tabs, the page is titled 'Business Unit Books' and shows 'Business Unit US008' and 'GL Business Unit US001'. The page contains several input fields and controls: 'Book Name' (FIN), 'Financial Book', 'Ledger Group' (RECORDING), 'Ledger' (LOCAL), 'Cost Type' (CUR), and '*Book Status' (Active). There are also checkboxes for 'Create Accounting Entries' (checked) and 'Create Item Profiles' (unchecked). The page includes navigation controls like 'Find | View All', 'First', '1 of 1', and 'Last'.

Field or Control	Description
Cost Type	<p>Enter a cost type for the inventory business unit cost book.</p> <p>This enables you to use different actual cost conversion rates and overhead conversion rates in different cost books. Cost types are user-defined, and different cost types can point to different conversion and overhead rate structures. Users may wish to use a set of GAAP rates for their GAAP cost type, full absorption rates for their FULLABS cost type, and activity-based cost rates for their ABM cost type. Books point to ledgers in the general ledger, so with this structure users can use different cost rates for their various books which may each have different management and financial reporting purposes.</p> <p>Books that use the frozen standard cost profile always simply use the frozen standard, which is an attribute of items in business units across all books. In other words, the cost types that make up the frozen standards are not affected by the entry in this field.</p>

Field or Control	Description
Create Accounting Entries	Select to have transactions in this book create accounting entries in the associated ledger or ledger group when the status of the book is active. This check box should remain selected unless you are an advanced user and you wish to turn off accounting entry creation for an alternative cost book.
Create Item Profiles	If one or more items do not have profiles in the book, you can check Create Item Profiles and the system creates the missing profile for those items in that book, if those items are already associated with a cost profile group. If they are not, when you try to save the new book as an active status book, an error message appears, and you must manually assign the profiles for those items for that book by using the Define Business Unit Item - General: Costing page. This check box is unavailable if every business unit item has a profile associated with that book. This option is not necessary if all items already have a cost profile.

In the **Book Status** field, enter the status of the book:

Field or Control	Description
<i>Pending</i>	When a book is added to a business unit, the default status is <i>Pending</i> . Use the pending status while preparing the book. When the book is ready, change the status to <i>Active</i> . If plans change, you can also change the status from <i>Pending</i> to <i>Inactive</i> or <i>Cancelled</i> .
<i>Active</i>	Active books can be used with the Transaction Costing process and the Accounting Line Creation process (both within the Cost Accounting Creation process). When you set a book to <i>Active</i> status, the system confirms that all items contain a cost profile for this book. This ensures that the active book can create complete accounting transactions.
<i>Inactive</i>	When an active book is no longer required, set the status to <i>Inactive</i> to prevent the book from creating further accounting entries. With an inactive status, the recorded accounting entries are not available for historical inquiries or reports.

Field or Control	Description
<i>Stopped</i>	<p>When an active book is no longer required, set the status to <i>Stopped</i> to prevent the book from creating further accounting entries. With a stopped status, the recorded accounting entries are still available for historical inquiries or reports. A warning message appears when changing an active book to <i>Stopped</i>.</p> <hr/> <p>Warning! Once an active book has been set to the status of <i>Stopped</i>, it can never again be set to <i>Active</i> status.</p> <hr/>
Cancel	You can cancel a cost book if it is never used to record accounting entries.

This table lists the conditions under which you can change the book status:

Change From This Status	To Active	To Inactive	To Pending	To Stopped	To Cancel
Active	---	Okay (warning appears).	Not allowed	Okay (warning appears).	Not allowed.
Inactive	Not allowed.	---	Not allowed.	Okay.	Not allowed.
Pending	Okay, if: All items in the business unit have a profile for the pending book. The book is seeded. The start date is greater than the present.	Okay, if: The book is seeded.	---	Not allowed.	Okay, if: The book is not seeded.
Stopped	Not allowed.	Okay.	Not allowed.	---	Not allowed.
Cancel	Not allowed.	Not allowed.	Okay.	Not allowed.	---

Related Links

- "Linking Ledgers to a Ledger Group" (Application Fundamentals)
- "Defining a Ledger Template" (Application Fundamentals)
- "Defining General Ledger Business Units" (PeopleSoft General Ledger)

"Define Business Unit Item - General: Costing Page" (PeopleSoft Managing Items)

Cost Profiles Page

To define cost profiles for items, use the Cost Profiles (CM_PROFILE_DEFN) component.

Use the Cost Profiles page (CM_PROFILE_DEFN) to establish the cost profile to determine how items are costed in the business unit's cost book.

Navigation:

Set Up Financials/Supply Chain > Product Related > Cost Accounting > Define Cost Profile Names > Profiles

This example illustrates the fields and controls on the Cost Profiles page. You can find definitions for the fields and controls later on this page.

Receipt Cost Method	Cost Flow	Deplete Cost Method
Non Cost	Non Cost	Non Cost
Actual	Lot ID	Actual Cost

The next step in setting up the system is to determine the methods that you want to use to value inventory items. In PeopleSoft Cost Management, you assign cost profiles to items to determine the costing of inventory transactions for that item. PeopleSoft Cost Management offers a number of options for cost profiles that you can mix and match to suit your requirements. Different items or groups of items within a business unit may use different cost profiles, and the same item in different business units may also use different cost profiles.

A profile determines the costing method that is used to value receipts, depletions, and inventory stock.

The Receipt Cost Method, Cost Flow, and Deplete Cost Method fields cannot be changed once a transaction using this cost profile is entered into the costing records (that is, CM_RECEIPTS table).

Receipt Cost Method

The Receipt Cost Method is the method that PeopleSoft Cost Management uses to account for receipts to inventory. Receipts from PeopleSoft Purchasing and completions from PeopleSoft Manufacturing become

putaways into PeopleSoft Inventory. PeopleSoft Cost Management tracks and accounts for each putaway. The Receipt Cost Method tells the system how the putaway is costed.

Field or Control	Description
<i>Actual</i>	The purchased item is valued at the PO price. You can also optionally adjust the cost based on the invoice price. The manufactured item is valued by the production ID that is closed for accounting.
<i>Non Cost</i>	<p>The receipt of the inventory item carries no cost and is not processed by PeopleSoft Cost Management. This profile is used for inventory items for which you want to maintain quantity-on-hand information but do not want to account for value. PeopleSoft Cost Management does not support interunit pricing for non-cost items.</p> <p>Once transactions have been generated using this cost profile, do not change the non cost option without first removing all on hand quantity from the item/business unit. Run the Inventory Balance report (INS9090) and the Cost Management On hand Balance Validation report (CMS9010) to find all on hand balances.</p>
<i>Std Cost</i>	The receipt is valued at the current frozen standard cost. The cost can be manually entered by you or calculated as a result of a cost roll-up.

Cost Flow

The Cost Flow determines how you want depletions to occur. Although the choice is often a reflection of the physical flow of goods, the choice that you make here does not need to follow the true physical flow of items, especially when it is not practical or significant enough to track the specific flow of quantities. This is the accounting assumption for a particular book. As depletions from inventory are processed, PeopleSoft Cost Management uses this part of the cost profile to determine which putaway can be assumed to have satisfied the depletion and assign putaways to depletions.

Field or Control	Description
<i>FIFO</i> (first in, first out)	The oldest items and therefore the oldest costs are used to value inventory depletions (customer shipments, material stock requests, or issues from one stock location to another). The remaining inventory is valued at the most recent costs. When each putaway tends to be similar to all other putaways, this frees users from the need to track item attributes other than the item itself when processing inventory transactions. PeopleSoft Cost Management takes on the task of tracking which putaways are assumed to have available quantities and satisfies depletions in a first-in, first-out manner. The flow of costs are independent of the physical material movement. If you prefer, more physical flow granularity can be achieved with the storage area control option.
<i>LIFO</i> (last in, first out)	The newest items and therefore the newest costs are used to value depletions. The remaining inventory is valued at the oldest costs. Similar to FIFO, this method allows you to assign costs to depletions without detailed tracking of physical movement.
<i>Lot ID</i> (specific identification by lot ID)	If the item is lot controlled, the cost of the specific lot is used. This offers you a specific method of tracking quantities and costs by lot.
<i>Non Cost</i>	This value is entered by the system when you select <i>Non Cost</i> for the receipt cost method. The receipt of the inventory item carries no cost and is not processed by PeopleSoft Cost Management. This profile is used for inventory items for which you want to maintain quantity-on-hand information but do not want to account for value.
<i>Serial ID</i> (specific identification by serial ID)	If the item is serial-controlled, the cost of the specific serial ID is used. This offers you a specific method of tracking quantities and costs by serial ID.

For lot ID, FIFO and LIFO items, it may take more than one putaway to satisfy depletions. A fully satisfied depletion is referred to as a depleted depletion. That is, using the cost flow that is specified, PeopleSoft Cost Management found enough on-hand quantities in putaways to satisfy the depletion.

Deplete Cost Method

The deplete cost method is the method that is used to assign a cost to the depleted depletion. Options are:

Field or Control	Description
<i>Actual Cost</i>	<p>Items use the actual cost of the putaway for the depleted depletion cost. Since PeopleSoft Cost Management tracks the actual cost for each putaway and knows which putaways are used to satisfy each depletion, the system knows the cost of the goods that are depleted. In the case of a specific identification cost flow such as lot ID or serial ID, the cost of goods that is depleted is more exact. In the case of FIFO or LIFO flowing items, PeopleSoft Cost Management lets you trade exactness for ease of administration, especially when it is not feasible or effective to track individual instances of items. For purchased items, the actual cost is the PO price, or an entered cost if you are doing express putaways, or the invoice price from PeopleSoft Payables, if it is available. At putaway, if the production ID (PID) is not closed, we use the current actual cost since we don't have the true cost. Once the PID is closed for accounting, we will adjust the items cost based on the PIDs finalized costs. Actual costs are stored in the records CE_ACTUAL_COST and CM_ACTUAL_COSTB.</p>
<i>Non Cost</i>	<p>This value is entered by the system when you select <i>Non Cost</i> for the receipt cost method. The receipt of the inventory item carries no cost and is not processed by PeopleSoft Cost Management. This profile is used for inventory items for which you want to maintain quantity-on-hand information but do not want to account for value. PeopleSoft Cost Management does not support interunit pricing for non-cost items.</p>
<i>Periodic Weighted Average</i>	<p>Depleted items use the periodic average cost calculated as of the run date that is used on the Transaction Costing process (CM_COSTING). The Transaction Costing process (within the Cost Accounting Creation process) may be run in two modes: Mid Period mode or Regular mode. If the process is run in Mid Period mode, the depleted depletion costing is postponed. The process waits to be run in Regular mode before attempting to calculate a periodic average cost for the depleted depletions. This allows you to run the Transaction Costing process as often as you like during a period to capture other information that you need to manage the business without prematurely computing periodic costs for these items. Once the Transaction Costing process is run in Regular mode, the periodic average cost is calculated and this one average is applied to all depleted depletions for the item during this period. The period is defined as the time that elapsed since the last time that the Transaction Costing process was run in Regular mode. Periodic average costs are stored in the CM_PERDAVG_COST record.</p>

Field or Control	Description
<i>Perpetual Weighted Average</i>	<p>The perpetual average cost is a rolling average that is based on the current quantity on hand valued at the current average cost, plus the receipts at the receipt cost, divided by the quantity on hand and the quantity received. The perpetual average is recomputed for every putaway by the inventory putaway processes based on PO price or manufacturing cost. Perpetual average cost items use the average cost that is in effect at the moment that the depletion transaction occurs.</p> <p>For example, if a purchased item is put away at the PO price and the invoice (voucher) is not yet received and processed, then the weighted average calculation includes the PO price at the time of putaway. The invoice price is not part of the weighted average at this time. Once the invoice arrives, you have the option of applying the PO-Voucher difference to the item's weighted average. In the case of a manufactured item being placed into PeopleSoft Inventory, the production ID may not yet be completed and the actual cost may not be available at the time that the finished goods are put away. Therefore, the putaway processes use the current weighted average cost. As production is closed for accounting, the average costs are adjusted. The adjustment amount is always applied to the item perpetual average. You do not have the option to apply or not apply the adjustment. Perpetual average costs are stored in the CM_PERPAVG_COST record.</p>
<i>Retroactive Perpetual Average</i>	<p>The retroactive perpetual average cost computes a new average for each putaway, just like the perpetual average method; however, this perpetual average cost is calculated at the end of the period and applied retroactively to the depleted depletions. The <i>period</i> is defined as the time that elapsed since the last time the Transaction Costing process was run in Regular mode. This method enables you to value each individual depleted depletion transaction using the current perpetual average cost at depletion time and yet still delay the calculation of the average until the end of the period when more cost information is captured for a more accurate average cost. In other words, this method enables you to capture a more accurate average by delaying the calculation of the average until later in the period when the vouchers or production completions are available. This increases the accuracy of the average cost. The retroactive perpetual average is calculated when the Transaction Costing process is run in Regular mode. If the Transaction Costing process is run in Mid Period mode, no retroactive perpetual averages are calculated. Retroactive perpetual average costs are stored in the CM_PERRAVG_COST record.</p>

Field or Control	Description
Value at Current Standard	Items use their current frozen standard cost for the depleted depletion cost. Frozen standard costs are stored in the production cost (CM_PROD_COST) record.

Insufficient Qty Cost Option

If you are using the negative inventory feature in PeopleSoft Inventory, this option enables you to control how depletion transactions are costed when the item quantity dips into negative quantity. The options are:

Field or Control	Description
<i>Always cost insufficient qty</i>	Enables the Transaction Costing process (within the Cost Accounting Creation process) to cost negative inventory depletion transactions before sufficient quantity is entered into the business unit. These costs can later be adjusted when sufficient quantity is placed in the Inventory business unit by putaway or adjustment transactions.
<i>Cost in Regular Mode Only</i>	Enables the Transaction Costing process, run in <i>Regular</i> mode only, to cost negative inventory depletion transactions before sufficient quantity is entered into the business unit. These costs can later be adjusted when sufficient quantity is placed in the Inventory business unit by putaway or adjustment transactions. If Transaction Costing is run in <i>Mid Period</i> mode, then the depletion transaction is costed up to the currently available quantity and the remainder is held.
<i>Cost to point of zero quantity</i>	Enables the Transaction Costing process to split a negative inventory depletion transaction and cost part of the depletion transaction up to the currently available stock quantity. The remaining depletion transaction is held until sufficient stock is received.
<i>Don't cost if insufficient qty</i>	Enables the Transaction Costing process to delay costing the entire negative inventory depletion transaction until sufficient stock is received to cover the depletion transaction. This is the default setting.

Note: The negative inventory feature is activated by selecting the **Allow Negative Inventory** check box on the Inventory Definition-Business Unit Options page.

Note: If *Periodic Weighted Average* is entered as the **Deplete Cost Method**, then negative inventory depletion transactions cannot be costed before sufficient quantity has been received into the business unit. The Cost Profile can only use *Don't cost if insufficient qty* or *Cost to point of zero quantity* as the **Insufficient Qty Cost Option**.

See [Costing Negative Inventory](#).

Cost Element Option

This option is enabled when you select a deplete cost method of perpetual average or retroactive perpetual average.

<i>Field or Control</i>	<i>Description</i>
<i>Default Cost Element</i>	Maintain the item's perpetual average cost by the default cost element. This option combines all costs into the primary cost element and calculates one average cost per item.
<i>Maintain Avg by Cost Element</i>	Maintain the item's perpetual average cost broken out by each cost element that is defined for the item.

Average cost at the cost element detail level only makes sense for items that consistently use the same cost elements for all putaways and if cost element level averages are required for reporting and accounting purposes.

Hold for Final Cost

The Hold for Final Cost check box delays the calculation of actual cost and standard cost variances for items until the final costs are received from PeopleSoft Payables or PeopleSoft Manufacturing. The benefit of this option is to minimize the number of extra accounting entries from PeopleSoft Cost Management. Without this option, the cost of the item is calculated when the item is put away into inventory at the currently available price (from the PO or production ID). This cost is later adjusted for any prices variances, such a, the invoice price or additional manufacturing costs. With this option and the Transaction Costing process run in Mid Period mode, the costing of all putaways and depleted depletions that are tied to unfinished costs (unvouchered and unmatched POs or production IDs with incomplete costs) are postponed. Costing of receipts and depletions is put on hold until the production is complete or PO, receipt, and vouchers are matched; this reduces the need for adjustments. If you run a period-end process, all transactions are costed by using the available cost, regardless of this check box setting.

For purchased items using actual cost, as supplier invoices (vouchers) are entered and matched to the PO and receipt ID by PeopleSoft Payables, PeopleSoft Cost Management is notified of the exact amounts that are vouchered for each receipt. PeopleSoft Cost Management is then able to adjust all receipts, depleted depletions, and variance calculations for costed transactions to the new revised cost and creates the necessary accounting entries for these adjustments. However, if you prefer to postpone the costing of quantity movements until the vouchers are been fully matched, you may select this option.

For makeable items, the Hold for Final Cost option delays the cost calculation of the manufactured item until the final costs from PeopleSoft Manufacturing for all components, conversion costs, or overhead costs are completed; reducing the number of variance adjustments that are needed. If you do not select

the Hold for Final Cost option, then the Transaction Costing process calculates the cost of a manufactured item when the production ID is closed for accounting.

The **Hold for Final Cost** check box does not restrict the flow of item quantities through inventory. PeopleSoft Cost Management keeps track of uncosted and unaccounted-for quantity flows and catches the cost up with those flows as required by period-end requirements or when the final cost is determined, whichever comes first.

Writeoff PPV and ERV

For purchased items only, select this check box to record any differences between the purchase order price and the vouchered price in an expense account rather than catching up the adjustments with the inventory receipt and depletion transactions. This check box is only available if you have selected *Actual* for the **Deplete Cost Method**. The variance is inserted into CM_VARIANC_COST record using the transaction group 400 Std/Actual Cost PPV) and the transaction group 402 (Std/Actual Cost ERV). If this check box is not selected, then both the PPV and ERV are applied to the inventory receipt and depletion transactions; however, if the IFRS Reporting check box is selected on the cost book, cost profile group, or the item business unit definition, then the ERV portion is expensed. For additional information about setting up IFRS reporting, please see the Valuing Inventory for IFRS section within the Costing Transactions and Creating Accounting Entries topics.

Storage Area Control for Costs

Check **Storage Area Control for Costs** if you want to apply the FIFO or LIFO depletion method at the storage area level. This means that the system uses FIFO or LIFO costing based on the receipts to the specific storage area from which the item is depleted. You can use storage area control with or without location accounting. However, if you use location accounting, it is strongly recommended that you use storage area control. If the FIFO or LIFO costing of depletions should apply to all receipts at the business unit level, this option can be set to *off* (unchecked).

Valid Profile Combinations

The combination of receipt cost method, cost flow, and deplete cost method that you select must match one of the valid combinations that appear at the bottom of the page.

If you select a receipt cost method of *Non Cost*, the system sets the cost flow and deplete cost method fields to *Non Cost*.

If you select a receipt cost method of *Actual* or *Std Cost*, neither the cost flow nor the deplete cost method can be *Non Cost*. Otherwise, an error message appears.

Cost Profiles - Manufacturing Page

Use the Cost Profiles - Manufacturing page (CM_PROFILE_DEF_MFG) to for items that are used in PeopleSoft Manufacturing, enter additional cost profile information to define the costing methods for labor and machine costs.

Navigation:

Set Up Financials/Supply Chain > Product Related > Cost Accounting > Cost Profiles > Manufacturing

This example illustrates the fields and controls on the Cost Profiles - Manufacturing page. You can find definitions for the fields and controls later on this page.

Receipt Cost Method	Cost Flow	Deplete Cost Method	Labor Cost Method	Machine Cost Method
Non Cost	Non Cost	Non Cost	Not Applicable	Not Applicable
Actual	Lot ID	Actual Cost	Not Applicable	Not Applicable

Field or Control	Description
Profile for Makeable Items	Select to define this cost profile for makeable items used in PeopleSoft Manufacturing. This check box activates the Labor Cost Method and Machine Cost Method fields for entry. For standard cost items, the relevant values are defaulted into the Labor Cost Method and Machine Cost Method fields and are not editable.

Labor Cost Method

If you use PeopleSoft Manufacturing, use this field to specify how labor costs are calculated. This cost profile should be attached to the make item.

Field or Control	Description
<i>Actual Time - Conversion Rate</i>	Labor costs are computed by using the production ID's actual time on the Record Actual Hours page and the conversion rates on the Conversion Rates page (by cost type/cost version).
<i>Actual Time - Crew Rate</i>	Labor costs are computed by using the production ID's actual time on the Record Actual Hours page and the rates on the Crew Actual Cost page.
<i>Not Applicable</i>	Labor costs are not calculated for this item.

Field or Control	Description
<i>Standard Time - Conversion Rate</i>	Labor costs are computed by using the standard times that are established on the Define Routings - Operations: Times page and the conversion rates that are on the Conversion Rates page (by cost type or cost version). This is the default setting for standard cost items.

Machine Cost Method

If you use PeopleSoft Manufacturing, use this field to specify how machine costs are calculated. This cost profile should be attached to the make item.

Field or Control	Description
<i>Actual Time - Conversion Rate</i>	Machine costs are computed by using the production ID's actual time that is on the Record Actual Hours page and the conversion rates that are on the Conversion Rates page (by cost type or cost version).
<i>Not Applicable</i>	Machine costs are not calculated for this make item.
<i>Standard Time- Conversion Rate</i>	Machine costs are computed by using the standard times that are established on the Define Routings - Operations: Times page and the conversion rates that are on the Conversion Rates page (by cost type or cost version). This is the default setting for standard cost items.

Valid Profile Combinations

The combination of receipt cost method, cost flow, deplete cost method, labor cost method, and machine cost method that you select must match one of the valid combinations that are displayed at the bottom of the page.

Cost Profile Groups - Books Page

To define cost profile groups, use the Cost Profile Group (CM_GROUP_DEFN) component.

Use the Cost Profile Groups - Books page (CM_GROUP_DETAIL) to link the cost book and cost profile together under the cost profile group.

Navigation:

Set Up Financials/Supply Chain > Product Related > Cost Accounting > Define Cost Profile Groups > Books

This example illustrates the fields and controls on the Cost Profile Group Books page. You can find definitions for the fields and controls later on this page.

Cost Profile Groups are designed to minimize the maintenance of item cost profiles by defaulting the proper cost profile into the business unit, item, and cost book combination. Cost Profile Groups are used to associate items with like costing profiles. First you give the cost profile group a description, then you associate it with a cost book and cost profile. By assigning the profile to the book and associating the book and profile to a cost profile group, all items that are assigned to that group use the specified cost profile as the default.

You can have any number of profiles to cost the items. Each profile can be associated to a unique book so that entries can be made to various ledgers based on different cost assumptions.

Field or Control	Description
Allow Override to Profile	If you select this option, the cost profile can be changed on the Define Business Unit Item - General: Costing page. The value for the cost profile can appear by default from the cost profile group that is entered on the Item Definition - General page. If this option is not selected, then the cost profile cannot be changed on the Define Business Unit Item - General: Costing page.
IFRS Reporting	Select this check box to enable this cost profile group to set up support for the International Financial Reporting Standards (IFRS). This check box cannot be selected if the cost profile group uses the LIFO cost flow method. For additional information about setting up IFRS reporting, please see the Valuing Inventory for IFRS section within the Costing Transactions and Creating Accounting Entries topics. See

Field or Control	Description
Apply to all Items	<p>If you change the profile for a book, you can optionally check Apply to all Items. This function provides a utility to apply cost profile changes throughout all business units in this SetID that use this book and have items that are in this cost group. This feature is especially useful during initial implementation if you develop item definitions in a repetitive manner. You may make changes at the SetID level and have those changes propagated down through the business units automatically with this function.</p> <p>When you first enter the page, this option is always deselected. If the option is selected, the changes that you make are propagated through the business units upon saving the PeopleSoft Inventory business unit. The system is careful to not permit changes to cost profiles in those business units where you have already started processing transactions. Once transactions have started with active cost profiles, changes are no longer allowed to protect the accounting validity of the book.</p>

Associating Items With Cost Books and Cost Profiles

As items are added to inventory business units, it is required that a cost profile be defined for each cost book that is used by the business unit. This ensures a complete set of accounting entries for each book. Methods for adding the cost book and cost profile to the item within an inventory business unit include:

- *Automatic Default Approach:* Enter the cost profile group on the Item Definition - General: Common page as you define the item at the SetID level.

Then, when you create the item ID and inventory business unit combinations by using the Define Business Unit Item component, the cost book and cost profile that is defined for the cost profile group appear by default on the Define Business Unit Item - General: Costing page. Use this method if you plan to use the same cost book and cost profile for every inventory business unit where this item is used.

- *Non-Automatic Default Approach:* Enter the cost profile for each item ID and inventory business unit combination by using the Define Business Unit Item - General: Costing page.

The cost book appears by default from the inventory business unit definition. Use this method if the cost profile that is used for the item varies by inventory business unit.

- Use a combination of both methods by moving the book and profile by default from the SetID level and then changing the cost profile on any Define Business Unit Item - General: Costing page that does not follow the default method.

Be sure to select Allow Overrides to Profile on the cost profile group if users at that item-in-business unit level should be able to modify cost profiles.

Note: An item cannot use a cost profile with the cost flow methods of lot ID or serial ID unless the item is defined as lot or serial controlled.

Note: On the Define Business Unit Item - General: Costing page, the **Used in Mfg** check box indicates that the item is used in manufacturing.

Related Links

- "Define Item - General: Common Page" (PeopleSoft Managing Items)
- "Define Business Unit Item - General: Costing Page" (PeopleSoft Managing Items)
- "Inventory Definition - Business Unit Books Page" (PeopleSoft Inventory)

Cost Elements Page

To define cost elements, use the Cost Elements component.

Use the Cost Elements page (CM_ELEMENT) to cost elements categorize the components of an item's cost.

The system maintains an item's cost-by-cost element. Cost elements also help define the debit and credit ChartFields in transaction processing.

Navigation:

Set Up Financials/Supply Chain > Product Related > Cost Accounting > Define Cost Elements

This example illustrates the fields and controls on the Cost Elements Page. You can find definitions for the fields and controls later on this page.

SetID SHARE		CORPORATE SETID					
Cost Elements				Personalize Find View All [Grid Icon]	First	1-5 of 26	Last
*Cost Element	Description	Short Description	*Cost Category	Allow ChartField Overrides			
101	Material - Gears	Gears	Material	<input checked="" type="checkbox"/>	+	-	
102	Material - Wheels	Wheels	Material	<input checked="" type="checkbox"/>	+	-	
107	Material - General	Mat'l	Addl Trans	<input type="checkbox"/>	+	-	
200	Material Overhead	Matl Ovhd	Inbound	<input checked="" type="checkbox"/>	+	-	
201	Material Ovhd - Desktops	MOH-Deskt	Inbound	<input checked="" type="checkbox"/>	+	-	

Use the Cost Elements page to define or maintain cost elements, which are used to categorize different components of an item's cost. An item's cost is calculated and maintained by cost elements. You can use cost element categories to define the costs at a summarized or very detailed level by using one or many cost elements. Cost elements also help define the ChartField combinations that are used to create accounting entries during the Accounting Line Creation process.

When defining cost elements, you must associate the element with a predefined cost category. Options are:

Field or Control	Description
<i>Addl Trans</i> (additional transfer costs)	<p>Additional transfer costs are the expenses that are associated with transferring stock from one inventory business unit to another. They include expenses such as freight and handling.</p> <p>See Understanding Interunit Transfers.</p>
<i>Con Ovhd</i> (conversion overhead)	<p>Conversion overhead costs are the overhead expenses that are associated with the assembly process. They include expenses such as utilities, operating supplies, rent, manufacturing supervisor expenses, or assembly department benefit expenses. This category is used only in a manufacturing environment.</p> <hr/> <p>Note: The flag is hidden, the reason is based on the test, conversion or conversion overhead cost is not displayed when performing the primary transactions.</p> <hr/>
<i>Conversion</i>	<p>Conversion costs are the direct, nonmaterial costs (including labor and machine costs) that are involved in the manufacture of items. This category is used only in a manufacturing environment.</p> <hr/> <p>Note: The flag is hidden, the reason is based on the test, conversion or conversion overhead cost is not displayed when performing the primary transactions.</p> <hr/>
<i>Inbound</i>	<p>Inbound costs are the overhead expenses that are associated with procuring material such as inbound freight, duty, purchasing, receiving and inspection, or warehousing. Use the inbound cost category when you do not need to track the variances that are associated with these types of costs.</p>
<i>Landed</i>	<p>Landed costs are the miscellaneous charges that are needed to bring an item in-house. They can include charges such as freight, handling, sales and use tax, and value-added tax. Landed costs can be charged by the merchandise supplier or by a third-party such as a shipping organization. Use the landed cost category to track the variances that are associated with these types of costs.</p>
<i>Material</i>	<p>Material costs are associated with the direct cost of an item, typically the cost to procure the item exclusive of any overhead (if purchased), or the sum of the lower level component's purchase costs (if manufactured).</p> <p>The flag should be checked and grayed.</p>
<i>Other</i>	<p>Other costs are used for any additional costs that are not covered in the other categories.</p>

Field or Control	Description
<i>Outbound</i>	Outbound costs are the overhead expenses such as material handling, staging, or warehousing that is associated with shipping material.
Allow ChartFields Override	The Material Cost Category will always be checked. For all other Cost Categories the ChartFields Override entered for the Material Cost will also be applied to the selected Cost Categories.

PeopleSoft Cost Management uses the cost categories throughout for reporting purposes. Additionally, the system uses only certain categories of costs for certain transactions. PeopleSoft Cost Management uses the costs that are associated with conversion, conversion overhead, material, inbound, landed, and other cost categories to value inventory and all the transactions. For shipments, outbound costs are also included.

Attaching Cost Elements to Generate Costs

Once you define the cost elements, attach the appropriate cost elements to the different costs that are generated by PeopleSoft Cost Management, including:

- Attach a default cost element to items by using the Define Business Unit Item page. This cost element is used when valuing receipts.
- Use landed cost elements to categorize landed costs by using the Misc Charge/Landed Cost Definition page.
- Use additional transfer cost elements to categorize interunit transfer costs by using the Transfer Pricing Definition component.
- For a purchased item using standard cost:
 - If you are not using the Cost Rollup process, then define cost elements for the items by using the Item Production Costs page. This is not a recommended method.
 - If you are using the Cost Rollup process to calculate costs, then define cost elements on the Additional Item Costs page.
- For makeable items, use the cost elements to define costing conversion rates, costing conversion overhead rates, additional item costs, and forecasted purchase costs.

Related Links

[Understanding Standard Costing for Purchased Items](#)

[Conversion Rates Page](#)

[Overhead Rates Page](#)

[Forecasted Purchase Costs Page](#)

[Adding Additional Costs](#)

"Interunit Ownership Page" (PeopleSoft Inventory)

"Define Business Unit Item - General: Common Page" (PeopleSoft Managing Items)

"Understanding Miscellaneous Charges" (PeopleSoft Purchasing)

[Using Transfer Pricing Definitions](#)

Determining Your Negative Inventory Strategy

PeopleSoft's negative inventory feature enables you to move or ship stock that sends the item's quantity balance into negative numbers within the PeopleSoft system. Negative inventory is an optional feature that is activated at the PeopleSoft Inventory business unit level.

A negative inventory depletion transaction is a depletion transaction that drives the item quantity to a negative balance in the system even though physically the quantities did exist. Causes of negative inventory in the system could include:

- The receipt transaction is entered into the system after the shipment transaction.
- A bin-to-bin transfer is entered into the system after the consumption transaction.
- An error in entering transaction quantities.

Once PeopleSoft Inventory has shipped a negative inventory depletion transaction, you have options in PeopleSoft Cost Management on how to cost the transaction. Since there is no corresponding receipt or receipt cost to apply to the negative inventory depletion transaction, you can:

- Place the transaction on hold. You have the option to split the depletion transaction, cost up to the currently available quantity in the unit, then hold the negative inventory part of the transaction. Each time the Transaction Costing process is run, any negative inventory depletion transactions on hold are examined to determine if there is sufficient quantity available to satisfy the depletion. Once sufficient quantity is entered into the business unit through putaway and adjustment transactions, then the depletion transactions are costed.
- Cost the transaction based on the most current cost. If a portion of the stock is currently available in the unit, then the depletion transaction is split, one part is costed up to the currently available stock and the negative inventory part is costed based on the most current cost. Later, when sufficient quantity is entered into the business unit through putaway and adjustment transactions, then the Negative Inventory Resolver process within the Transaction Costing process can use the new receipt cost to adjust the negative inventory depletion records.

Users are cautioned that negative inventory is an invalid state and these conditions should be investigated and reconciled on a timely basis. The negative inventory options are provided as a convenience to users where, in the user's judgment, the principle of materiality is not violated by the negative inventory state.

Setting Up Negative Inventory

The negative inventory feature is activated by selecting the **Allow Negative Inventory** check box on the Inventory Definition-Business Unit Options page. The **Insufficient Qty Cost Option** on the Cost Profiles page determines how the Transaction Costing process applies costing to negative inventory transactions.

Accounting for Transactions on Hold Due to Negative Inventory

If you allow negative inventory balances in the PeopleSoft Inventory business unit and you choose not to cost a negative inventory depletion transaction, then you will want to determine the approach to accounting for these held transactions at period end. These depletion transactions are not reflected in the financial records since they have not been processed by the Transaction Costing process, therefore, they are not passed downstream to the Accounting Line Creation process or the Journal Generator process. The options are:

- Use the Transaction Costing process to cost the depletion transactions once sufficient receipts exists. The Transaction Costing process will post the depletion transaction costs in the original period of the shipment, as long as that period is still open per the open period page for inventory and GL and per the ledger calendar. If the negative inventory balances are relatively small and do not impact the financial balances, then use the Transaction Costing process to update a prior period depletion transaction.
- Enter manual journal entries at period end to accrue negative inventory depletion transactions. Be sure to use the GL open period feature and set the open period lag days to zero so the cutoff day is the last day of the period. This enables you to enter manual journal entries in the closing period without concern that the Transaction Costing process will later post depletion transaction costs into this period, therefore doubling the accrual. By setting up the period end control in GL to zero lag days for inventory, the Transaction Costing process is prevented from posting delayed depletion transaction into the prior period and instead posts them into the current period.

Pages Used to Determine Your Negative Inventory Strategy

<i>Page Name</i>	<i>Definition Name</i>	<i>Usage</i>
Open Period Update Page	OPEN_PERIOD_SINGLE	Determine the number of open period lag days that enable any PeopleSoft Inventory or Cost Management process, such as the Transaction Costing process, to post a depleted depletion into a closing period. The lag days are defined by PeopleSoft Inventory business unit.
"Inventory Definition - Business Unit Definition Page" (PeopleSoft Inventory)	BUS_UNIT_INV5	Select the Allow Negative Inventory check box to record depletion transactions in PeopleSoft Inventory business unit that will drive the item's balance negative. If this option is not selected, the system rejects any inventory transaction that results in a negative inventory balance for the item.
<u>Cost Profiles Page</u>	CM_PROFILE_DEFN	Define the Insufficient Qty Cost Option on the Cost Profiles page to determine how the Transaction Costing process applies costing to negative inventory depletion transactions.

Page Name	Definition Name	Usage
Pending Transactions Page	CM_NPOSTED	View the number of depletion transactions on hold due to negative inventory. Click the Details links to view current transaction information generated by a predefined query.
Insufficient Qty Tool Page	RUN_CM_NEG_INV	Run this PeopleSoft application engine program, (CM_NEG_INV) to generate a query of the accounting line entries that would be generated for those transactions held back in CM_DEPLETIONS due to insufficient quantities.

Related Links

[Cost Profiles Page](#)

[Costing Negative Inventory](#)

"Understanding Accounting Calendars Based on Open and Close Periods" (Application Fundamentals)

Selecting the Method to Number Accounting Lines

Within the Accounting Line Creation process, a substantial reduction in processing time can be achieved by using set-based processing to number the lines of the newly-created accounting entries. As delivered, the system uses row-by-row processing to create the sequential accounting line numbers. By performing additional set up steps you can switch from row-based processing to set-based processing to generate the line numbers.

Note: The set-based approach is optional. The delivered default option is the row-by-row approach.

Set-based processing of the line numbers can be accomplished by using the database platform's approach and syntax to generate sequential numbers. All PeopleSoft supported database platforms have an approach for generating sequence numbers within the database. The Cost Accounting Creation process can take advantage of this feature with some minor additional set up steps.

The architecture of the set-based sequence approach is similar across all platforms with just a few changes for platform specific syntax:

- Create a temporary working table with an identity column or use a database specific rownumber function on the database platform, depending on the platform. The syntax is platform specific but the behavior is fairly common. The create table syntax is delivered as a special PeopleSoft Data Mover Script (DMS) for installation, however, some platforms will require further intervention by your database administrator.
- During the Accounting Line Creation process, the SQL statement to insert the data to the special temporary work table has slightly different syntax on different database platforms but the behaviors

are very common across platforms. This syntax is delivered as part of the process logic and requires no special user intervention.

Database Platform	Sequential Numbering Method
Microsoft SQL Server	These platforms use an IDENTITY type column. When a table is created with an identity column, the sequence numbers are generated automatically by the database behind the scenes.
Oracle	This platform uses a ROWNUM function to generate sequential numbers.

The set-based sequencing approach depends on a special installation process to set up the objects. The setup has the following steps on all platforms except Oracle:

1. Find the DMS for your specific database platform. The scripts are located on the scripts folder: <PeopleTools home>\scripts.

Database Platform	PeopleSoft Data Mover Script
Microsoft SQL Server	cm_id_create_mss.dms
DB2	cm_id_create_db2unix.dms
OS390	cm_id_create_db2os390.dms
Oracle	(no DMS needed)

2. Engage your Database Administrator and review the provided PeopleTools DMS. If your system uses customized ChartField column names, then the DMS must be modified manually. If the database is configured to use the unicode character set, then the DMS must be modified manually. Some platforms require tablespace names and other database administration parameters to be defined as part of the create table command.
3. Run the provided PeopleTools DMS to recreate the sequence numbering work table (the CM_ACCTG_LN_TM2 record) with an IDENTITY type column.
4. The *Set based Sequencing* check box on the Installation Options- Inventory page should now be available. Select the check box to use set-based sequencing.

On Oracle the installation process for set-based sequencing is just one step. Select the Set based Sequencing check box on the Installation Options- Inventory page. It is always available on an Oracle platform. The system uses a built-in database ROWNUM function and work table (the CM_ACCTG_LN_TMP record) as originally installed by PeopleTools.

At run time, the Cost Accounting Creation process checks for three specific issues before deciding to use set-based sequencing:

- Verifies the DMS has been run (This is always set for ORACLE).

- Verifies the *Set based Sequencing* check box has been selected on the Installation Options - Inventory page.
- Verifies the table structure of the sequence numbering work table (PS_CM_ACCTG_LN_TMP in Oracle and PS_CM_ACCTG_LN_TM2 in the rest of the platforms) and its sub record have not changed since the time the Set based Sequencing check box was selected.

The message log for the Cost Accounting Creation process displays which type of sequencing is being used to create accounting lines (row-by-row or set-based). This can be used to confirm the type of sequencing selected.

Note: Using the set-based processing method to generate the sequential accounting line number is significantly faster than row-based processing. However, set-based processing can produce gaps in numbering. For example, within one accounting entry with four lines, the lines can be numbered 1, 5, 6, and 11, rather than 1, 2, 3, and 4.

Pages Used to Select the Method to Number Accounting Lines

<i>Page Name</i>	<i>Definition Name</i>	<i>Usage</i>
Inventory Page	INSTALLATION_INV	Select the Set based Sequencing check box to use set-based sequencing to number your accounting lines created by the Accounting Line Creation process.

Related Links

"Installation Options - Inventory Page" (Application Fundamentals)

Enabling ChartField Security

PeopleSoft enables you to restrict access to your financial data within PeopleSoft Cost Management and across all PeopleSoft Financials Supply Chain Management (FSCM) applications. The ChartField Security feature prevents unauthorized employees and contractors from viewing and editing financial data. Other security features within PeopleSoft enable you to restrict access by business unit, ledger, SetID, paycycle, book code, and project ID; however, the ChartField Security feature enables you to restrict access to specific financial data by restricting access to a ChartField value or combination. Security by ChartField combination enables you to allow access to most financial data (such as inventory accounts or accounts payable balances) and still restrict access to sensitive data (such as executive salaries or travel accounts). Using ChartField security, you can enable access to sensitive ChartField combinations by:

- User IDs
- User roles
- Permission lists

Within PeopleSoft Cost Management, the following methods can be used to enforce ChartField security:

- *Securing the prompt edit table values:* When a user clicks the prompt button or enters a value in a field containing a ChartField (Account, Department ID, and so on), then the system only displays values that the user is authorized to view.
- *Securing inquiry results list:* When a user is entering a component, the search results are limited to transactions containing ChartField combinations that the user is authorized to view.
- *Securing transactions from a component search list:* When a user is entering a component, the search results display all applicable transactions; however, if the user selects a transaction containing a restricted ChartField combination, then an error message is displayed and the user cannot access the transaction.

The following components in PeopleSoft Cost Management can be restricted with ChartField security:

- Adjust Average Cost (securing the prompt edit table values).
- Adjust Retroactive Cost (securing the prompt edit table values).
- Accounting Entries inquiry (securing inquiry results list).
- Unposted Accounting Lines inquiry (securing transactions from a component search list).
- Posted Accounting Lines inquiry (securing transactions from a component search list).
- CM/AP Reconciliation Summary (securing inquiry results list).
- CM/AP Reconciliation Detail (securing inquiry results list).
- Inventory Transactions - Transaction Entries inquiry and Inventory Transactions - Transaction Details inquiry (securing transactions from a component search list).
- Earned Conversion Costs - Transaction Entries inquiry and Earned Conversion Costs - Transaction Details inquiry (securing transactions from a component search list).
- Production Variances - Transaction Entries inquiry and Production Variances - Transaction Details inquiry (securing transactions from a component search list).
- Production Scrap Costs - Transaction Entries inquiry and Production Scrap Costs - Transaction Details inquiry (securing transactions from a component search list).
- Production Actual Costs - Transaction Entries inquiry and Production Actual Costs - Transaction Details inquiry (securing transactions from a component search list).
- Standard Cost Revaluations - Transaction Entries inquiry and Standard Cost Revaluations - Transaction Details inquiry (securing transactions from a component search list).
- Avg Cost Adjustment Entries- Transaction Entries inquiry and Avg Cost Adjustment Detail - Transaction Details inquiry (securing transactions from a component search list).
- Actual Cost Adjustment Entries- Transaction Entries inquiry and Actual Cost Adjustment Detail - Transaction Details inquiry (securing transactions from a component search list).
- Non Stock Shipment - Transaction Entries inquiry and Non Stock Shipment - Transaction Details inquiry (securing transactions from a component search list).

For information on the setup and use of the ChartField Security feature, including specific information about PeopleSoft Cost Management components, see the Securing ChartFields topic of the *PeopleSoft Application Fundamentals*

See "Understanding ChartField Security" (Application Fundamentals).

Setting Up the Accounting Rules Structure

Understanding the Accounting Structure

This topic explains the elements that the Accounting Line Creation job process (CM_ALC) uses to create accounting entries. PeopleSoft Cost Management enables you to create accounting entries, at any level of detail, for all transactions that have a financial impact on PeopleSoft Inventory and PeopleSoft Manufacturing. When setting up the accounting structure, you decide how you want to post transactions. You can post transactions for any combination of business unit, transaction group, distribution type, and either item or item group. You can design transaction accounting for the basic transactions, location accounting, budget checking, interunit transfers, fund accounting, shipments on behalf of another revenue stream, and interunit expensed issues. The Accounting Line Creation process is discussed in the "Costing Transactions and Creating Accounting Entries" topic.

Related Links

[Creating Accounting Entries](#)

[Understanding Cost Structure](#)

Common Elements Used in Accounting Structure

<i>Field or Control</i>	<i>Description</i>
FERC Code (Federal Energy Regulatory Commission code)	Federal Energy Regulatory Commission identification codes. This field appears only if you select FERC reporting on the PeopleSoft Inventory Options page.
ChartFields	Chart of accounts used to record accounting entries and journal entries in PeopleSoft.
Cost Element	Code used to categorize the different components of an item's cost and also define the debit and credit ChartFields for accounting entries.
Transaction Group	Predefined codes attached to different types of transactions, such as stocking, issues and adjustments.
Distribution Type	User-defined codes that are a subset of transaction groups. This enables you to break down a transaction group into customized categories.

Field or Control	Description
Item Group	A grouping of items that enable you to design the accounting structure for a group of similar items, such as sporting equipment or dress shoes. The item group is attached to an item using the Item Definition - General page.

Defining the Accounting Structure

Using the Accounting Rules page, you can create your steps for accounting entries, at any level of detail, for all transactions that have a financial impact on inventory. When a transaction is created, it contains the information that is used to find and create the accounting entries, including:

Field or Control	Description
Transaction Group	A system-defined code automatically embedded in each inventory transaction that defines the type of transaction. For example, the transaction code 030 (Usage and Shipments) is embedded on the Express Issues page for external issues. Any transaction that is recorded by using this page is coded with the transaction group 030.
Distribution Type	(Optional) A subset of transaction groups that can further define the transactions. This code is user-defined and can be added during transaction entry. For example, you could decide that the transaction group 030 (Usage & Shipments) is too general and opt to use distribution types to further define it as <i>shipments to wholesale customers</i> and <i>shipments to retail customers</i> .
Unit	The PeopleSoft Inventory business unit in which the transaction is recorded.
Item ID or Item Group	The item used in the transaction or the item group to which this transaction belongs.
Cost Element	A code used to categorize the different components of an item's cost and also define the debit and credit ChartFields for accounting entries. Adding a cost element to the Define Business Unit Item - General page, identifies an item's material cost.

When you run the Accounting Line Creation process, the system searches through the accounting rules definition data that you defined on the Accounting Rules page, looking for a match to the transaction's data going from most granular to least granular. For example, suppose that you process an entry from the Express Issues page (using the transaction group 030) for item ID 10001 in the business unit US008. The process searches for an Accounting Rules page with business unit US008, transaction group 030, and item ID 1001. If the system finds this combination, then it creates the accounting entries based on

this transaction accounting rule. If more than one accounting rule can be used for the transaction, then the process uses the more specific rule, for example, item ID instead of item group.

If location accounting is turned on, then the process searches storage area accounts to find the credit account and uses the transaction accounting rule to find the debit account. Additional information about the Accounting Line Creation process is located in the Costing Transactions and Creating Accounting Entries topic.

To define the inventory accounting structure:

1. Verify that the PeopleSoft financial structure has been defined including ChartFields and combination editing.
2. Verify that the cost elements have been defined and attached to the various PeopleSoft pages that generate costs including:
 - The Define Business Unit Item page.
A purchased item must always have a cost element defined.
 - The Misc Charge/Landed Cost Definition page.
 - The Conversion Rates page.
 - The Costing Conversion Overhead Rates page.
 - The Additional Item Costs page.
 - The Forecasted Purchase Costs page.
3. Review the list of transaction groups codes.
4. Define any distribution types needed to further breakdown the transaction groups.
5. (Optional) Use the Default Distribution Type page to establish any default distribution types by transaction group.
6. Define any item groups.
7. Establish the accounting entries to be created using the Accounting Rules page.

After establishing the accounting structure, the Transaction Costing process (CM_COSTING) costs transactions and the Accounting Line Creation job process creates accounting entries. Both process are initiated using the Cost Accounting Creation process page.

Pages Used to Define the Accounting Structure

<i>Page Name</i>	<i>Definition Name</i>	<i>Usage</i>
Cost Elements Page	CM_ELEMENT	Define cost elements to categorize different components of an item's cost.

Page Name	Definition Name	Usage
Distribution Type Page	CM_DISTR_TYPE	Use to define debit and credit account ChartFields at a finer level of granularity.
Default Distribution Type Page	CM_TRANS_GROUP	Assign default distribution types for transactions.
Item Groups Page	INV_ITEM_GROUP	Create groups of similar items that should use the same ChartField combinations in their accounting entries.
Accounting Rules Page	CM_ACCTG_DIST	Create the debit and credit lines for the accounting entries based on the business unit, transaction group, distribution type, item or item group, and cost element.
Define Item - General: Common	INV_ITEMS_DEFIN1	Define the item group to which this item belongs.

Related Links

[Understanding Transaction Costing and Accounting Entry Creation](#)

Verifying Your PeopleSoft Financial Structure

Verify that the PeopleSoft financial structure has been defined, including ChartFields and combination editing. Note whether ChartField combination edits are being used. ChartField combination editing displays an error message when incorrect combinations are used. Combo edits are always based on the COMBO_DATA_TBL record. When the combo rules are changed, the new rules are not used until the Build Combo Data process is run to repopulate the record.

Related Links

"Understanding PeopleSoft ChartFields" (Application Fundamentals)

"Understanding ChartField Combination Editing" (Application Fundamentals)

"Understanding Alternate Accounts" (Application Fundamentals)

"Setting Up Financials Audit Framework (Audit Logging)" (Application Fundamentals)

"Inventory Definition - Business Unit Options Page" (PeopleSoft Inventory)

Verifying That Cost Elements are Defined and Applied to Items

Use the Cost Elements page to define or maintain cost elements, that you use to categorize different components of an item's cost. When you perform a cost roll-up, you maintain an item's standard cost by cost element. You can use cost element categories to define the costs at a summarized or very detailed level by using one or many cost elements. Cost elements also help define the ChartField combinations that you used to create accounting entries during the Accounting Line Creation process. Once you define the cost elements, attach the appropriate cost elements to the different costs that PeopleSoft Cost Management generates including:

- Attach a default cost element to each item on the Define Business Unit Item page.
- Use landed cost elements to categorize landed costs on the Misc Charge/Landed Cost Definition page.
- For make items, use the cost elements to define costing conversion rates, costing conversion overhead rates, additional item costs, and forecasted purchase costs.

Related Links

[Cost Elements Page](#)

[Understanding Standard Costing for Purchased Items](#)

[Conversion Rates Page](#)

[Overhead Rates Page](#)

[Forecasted Purchase Costs Page](#)

[Adding Additional Costs](#)

"Interunit Ownership Page" (PeopleSoft Inventory)

"Define Business Unit Item - General: Common Page" (PeopleSoft Managing Items)

"Understanding Miscellaneous Charges" (PeopleSoft Purchasing)

Using Transaction Group Codes

Each transaction, with a financial impact, is embedded with a predetermined transaction group. The transaction group identifies the type of transaction entered and determines what records are populated, how costing is calculated, and what ChartFields are used to record accounting entries. PeopleSoft Cost Management maintains a transaction history for all transactions with a transaction group. This table lists the transaction group codes and descriptions:

<i>Transaction Group Code</i>	<i>Transaction Group Description</i>
001	CM Only NegQty Costing Opt
010	Receipt to Inspection
012	Return to Vendor
013	Return to Vendor from Inspection
020	Putaway
021	Receipts from Production*
022	IBU Transfer Receipts
024	Customer Returns
025	InterCompany Receipts

<i>Transaction Group Code</i>	<i>Transaction Group Description</i>
026	Expensed Issue Return
030	Usage & Shipments
031	InterBU Transfer Shipments
032	Non Stock Shipments
034	Ship on Behalf of Other BU
035	InterCompany Transfers
036	InterUnit Expensed Issue
037	VMI Interunit shipment
038	VMI Consumption
040	Physical Count Adjustments
041	Cycle Count Adjustments
042	IBU Transfer Adjustments
050	User Adjustments
051	Inventory Scrap
052	Shipping Adjustment
053	Floor Stock Issues/Ret*
054	Inventory Scrap for RTV
060	Bin-to-Bin Transfers
200	Inventory Revalue
201	Inventory Reval - Inspection

<i>Transaction Group Code</i>	<i>Transaction Group Description</i>
205	Value Adjustment
206	Value Adjust/ActCost Items
210	WIP Revalue (Comps, Assys)*
211	WIP Revalue (Conv Costs)*
212	WIP Revaluation (Scrap)*
220	Component Kit*
221	Route to Production Kit*
222	Waste Completion
223	Component/Output Transfers
230	Component Consumption*
231	WM Usage (Maintenance Management Usage)
240	Earned Labor*
250	Assembly Scrap*
261	Material Variances*
262	Conversion Variances*
263	Rework Expense*
264	Outside Processing PPV*
265	Teardown Variance*
300	Gain/Loss on Transfer Price
301	InterCompany Cost of Goods

<i>Transaction Group Code</i>	<i>Transaction Group Description</i>
302	ShipOnBehalf Gain/Loss
400	Std/Actual Cost PPV
401	Wt Avg Updates from AP
402	Std/Actual Cost ERV
403	Wt Avg Cost Updates - ERV
404	WtAvg cost ERV WO-IFRS
405	Wt Avg Update Writeoffs
406	Actual cost ERV WO-IFRS
407	Subcontract Standard Cost PPV2*
408	Subcontract Standard Cost PPV2 ERV*
415	RTV Variances
461	Voucher Variance Writeoffs
500	Miscellaneous Charges
501	Freight Charges
601	Wt Avg Upd Production Var*
605	Wt Avg Upd Prod Writeoffs*
606	Avg Rev Compl Write-off*
622	Actual Waste Cost*
630	Overhead*
640	Actual Labor Costs*

<i>Transaction Group Code</i>	<i>Transaction Group Description</i>
645	Actual Machine Costs*
651	Production Cost Writeoff*
661	Actual Cost Variances*
664	Subcontracted Cost

*Indicates a transaction group that is related to transactions generated in PeopleSoft Manufacturing.

Related Links

[Using Transaction Groups](#)

Distribution Type Page

To define distribution types, use the Distribution Type (CM_DISTR_TYPE) component. Use the Distribution Type component interface (CM_DISTR_TYPE_CI) to load data into the tables for this component.

Use the Distribution Type page (CM_DISTR_TYPE) to use to define debit and credit account ChartFields at a finer level of granularity.

Navigation:

Set Up Financials/Supply Chain > Product Related > Cost Accounting > Distribution Type

In most instances, the transaction determines the debit and credit account to charge. For example, a customer shipment typically debits a cost of goods sold account and credits inventory. For some transactions, like a miscellaneous issue from stock, the transaction accounting rule can depend on the party to whom you issue the material. You could charge different departmental expense accounts for the receipt of inventory, depending on who requisitions the material from stock. Use distribution types to have the option to define different departments or cost centers.

When used in conjunction with the transaction group, distribution types enable you to define debit and credit ChartFields at a finer level of granularity. A manufacturing organization, for example, can set up a distribution type for each of its production departments. You assign these distribution types to the appropriate work center when you define the manufacturing data. When you record assembly completions at an operation or to stock, the system records the earned labor, machine, and overhead costs. If you have assigned a distribution type to the work center, the system records this distribution type along with the costs. This identifies the department or cost center that earned the labor, machine, and overhead costs. You can then set up transaction accounting rules for the transaction group Earned Labor (240) and the distribution type (for example, one of the assembly departments). Debit the production area account for the value of costs added to WIP and credit each department expense for the earned labor and applied overhead.

You can set up distribution sets in PeopleSoft Order Management with a distribution type that can be transferred to PeopleSoft Inventory and PeopleSoft Cost Management. This enables you to use the distribution type to classify costs of sales appropriate to the sales account.

Related Links

"Setting Up Order Processing Options" (PeopleSoft Order Management)

Default Distribution Type Page

To define default distribution types, use the Default Distribution Types (CM_TRANS_GROUP) component.

Use the Default Distribution Type page (CM_TRANS_GROUP) to assign default distribution types for transactions.

Navigation:

Set Up Financials/Supply Chain > Product Related > Cost Accounting > Distribution Type Default > Default Distribution Type

Once you define at least one distribution type, you can also assign a default distribution type that appears whenever you process a transaction. It is not required that you define a default distribution type for every transaction group; however, it can reduce entry errors. For example, you can assign a distribution type to the transaction group User Adjustments (050). Then, if an inventory adjustment occurs, the distribution type associated with the transaction appears as the default. You can override the default distribution type on a transaction by transaction basis. The use of distribution types for a transaction group is optional.

Using Item Groups

You can assign transaction accounting rules to a grouping of items by using item groups.

To use item groups for defining transaction accounting rules:

1. Define the item groups using the Item Group page.
2. Attach the item groups to the corresponding items using the Item Definition - General: Common page.
3. Use the item groups on the Accounting Rules page to define the ChartField combinations to be used for the accounting entries.

Related Links

"Item Groups Page" (PeopleSoft Managing Items)

"Define Item - General: Common Page" (PeopleSoft Managing Items)

Accounting Rules Page

To define accounting distribution, use the Account Distribution component (CM_ACCTG_DIST). This component is also known as the Transaction Accounting Rules component.

Use the Accounting Rules page (CM_ACCTG_DIST) to create the debit and credit lines for the accounting entries based on the business unit, transaction group, distribution type, item or item group, and cost element.

Navigation:

Set Up Financials/Supply Chain > Product Related > Cost Accounting > Transaction Accounting Rules > Accounting Rules

This example illustrates the fields and controls on the Accounting Rules page (partial page). You can find definitions for the fields and controls later on this page.

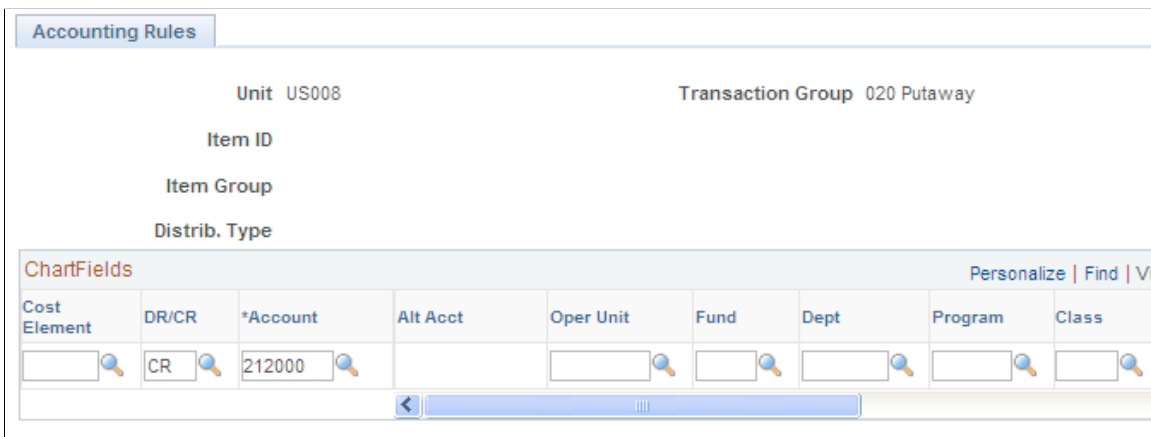

On this page, create a template of the ChartField combinations (chart of accounts) to be used for creating accounting entries. Use separate rows for the debit and credit entries. Create a separate page (or template) for each type of transaction. Once you determine how you want to model accounting entries, you can assign the debit and credit ChartFields for any combination of business **Unit, Transaction Group, Distrib. Type** (distribution type), either **Item ID** or **Item Group**, and **Cost Element**. **Business Unit** and **Transaction Group** are the only required fields.

To save maintenance time, three of the transaction groups do not need to be created or maintained on the Accounting Rules page. The transaction group 206 uses the account distribution setup defined for the transaction group 205. The transaction groups 211 and 212 use the account distribution setup defined for the transaction group 210.

Searching for the Correct Transaction Accounting Rule

As you define transaction accounting rules, there are some situations where more than one Accounting Rules page can be used for the same transaction. The system uses the transaction accounting rules with the most specific information matching the transaction. The search for the correct Accounting Rules page uses the logic in the table starting with the first row and continuing until a match is found.

<i>Row</i>	<i>Unit</i>	<i>Trans Group</i>	<i>Item ID</i>	<i>Item Group</i>	<i>Distrib Type</i>	<i>Cost Element</i>
1	Business Unit	Transaction Group	Item ID	blank	Distribution Type	Cost Element

Row	Unit	Trans Group	Item ID	Item Group	Distrib Type	Cost Element
2	Business Unit	Transaction Group	Item ID	blank	Distribution Type	blank
3	Business Unit	Transaction Group	Item ID	blank	blank	Cost Element
4	Business Unit	Transaction Group	Item ID	blank	blank	blank
5	Business Unit	Transaction Group	blank	Item Group	Distribution Type	Cost Element
6	Business Unit	Transaction Group	blank	Item Group	Distribution Type	blank
7	Business Unit	Transaction Group	blank	Item Group	blank	Cost Element
8	Business Unit	Transaction Group	blank	Item Group	blank	blank
9	Business Unit	Transaction Group	blank	blank	Distribution Type	Cost Element
10	Business Unit	Transaction Group	blank	blank	Distribution Type	blank
11	Business Unit	Transaction Group	blank	blank	blank	Cost Element
12	Business Unit	Transaction Group	blank	blank	blank	blank

Working with Cost Elements and Using Blank Spaces for Cost Elements

An item can have one or more cost elements defined in its product structure. The Transaction Costing process calculates and stores the costs by cost element. In the Accounting Line Creation process, the system attempts to match up the item's transaction costs (categorized by cost element) to a transaction accounting rule with the same information. The system finds the correct ChartField combination by searching for a row in the Accounting Rules page with a cost element matching the transaction costs of the item. If the system does not locate this, then it uses a row with a blank cost element. Therefore, you add flexibility to the system by adding different combinations of cost elements using different rows on

the same Accounting Rules page. You can use any combination of debit and credit rows. You can use rows with a blank cost element for any unspecified cost elements. If you can use the same ChartFields, regardless of the cost element, leave the **Cost Element** field blank.

Entering Adjustments

Adjustments can be either an increase or decrease. You only need to define the accounting to record an expense. The system reverses the entry to record an income transaction. For example, a cycle count adjustment could increase or decrease inventory stock. For adjustments in PeopleSoft Cost Management where you are using location accounting, you need only define the decrease (expense) scenario and the system knows to reverse the entry for any increase in stock or income. For example, when defining the transaction accounting rules for the Cycle Count Adjustments transaction group, you define the inventory adjustment expense as the debit account. The credit account in this example is an inventory location's asset account. When creating accounting lines for cycle count adjustments, the system creates an entry debiting the expense account and crediting the inventory account for all inventory losses. For any inventory gains, the system creates the entry in reverse, debiting the inventory account and crediting the expense account.

This table lists the adjustment and variance transaction groups for which this rule applies:

<i>Transaction Group</i>	<i>Description</i>
040	Physical Count Adjustments
041	Cycle Count Adjustments
042	IBU Transfer Adjustments
050	User Adjustments
052	Shipping Adjustments
053	Floor Stock Issues/Ret
200	Inventory Revalue
201	Inventory Reval - Inspection
205	Value Adjustment
206	Value Adjust/ActCost Items
210	WIP Revalue (Comps, Assys)

<i>Transaction Group</i>	<i>Description</i>
211	WIP Revalue (Conv Costs)
212	WIP Revaluation (Scrap)
261	Material Variances
262	Conversion Variances
263	Rework Expense
264	Outside Processing PPV
265	Teardown Variance
300	Gain/Loss on Transfer Price
302	ShipOnBehalf Gain/Loss
400	Std Cost Variance Receipts
401	Wt Avg Updates from AP*
402	Std Cost Exchange Rate Var
403	Wt Avg Cost Updates - ERV*
405	Wt Avg Update Writeoffs
407	Subcontract Standard Cost PPV2
408	Subcontract Standard Cost PPV2 ERV
415	RTV Variances
461	PO Voucher Variance
601	Wt Avg Upd Production Var*

<i>Transaction Group</i>	<i>Description</i>
605	Wt Avg Upd Prod Writeoffs
606	Avg Rev Compl Write-off*
651	Production Cost Writeoff*
661	Actual Cost Variances*

*In the case of transaction groups 401 (Wt Avg Updates from AP), 403 (Wt Avg Cost Updates - ERV), and 601 (Wt Avg Upd Production Var) the debit account is really the inventory account. The system updates the inventory value with any unfavorable purchase price variance or exchange rate variance.

Using the Accounting Rules page with Location or Production Area Accounting

If you are using the Location Accounting function, define only the debit or the credit side for certain transactions. The system derives the offsetting entry line from the ChartField combinations that you define for the production area, storage area, or the interunit ownership setup.

Related Links

[Accounting Rules Page](#)

Defining Location Accounting

One option for structuring accounting rules is with the location accounting approach. Location accounting enables you to define different ChartField combinations for each storage area within an inventory business unit. For example, you can assign a raw material account to one storage area and a finished goods account to another storage area. Any material residing in the raw material storage area debits or credits the raw material inventory account when material moves in or out of that storage area. Any material residing in the finished goods storage area debits or credits the finished goods inventory account.

When using the location accounting option in a manufacturing environment, assign ChartFields to both storage areas and production areas. By assigning ChartFields to storage and production areas, you can segregate raw material, in process material, and finished goods inventory for accounting purposes.

Note: For location accounting, you perform many of the same steps used to define the basic accounting structure. Please read the preceding section, "Defining the Accounting Structure" before setting up location accounting.

To define the location accounting structure:

1. Select the **Location Accounting Required** check box on the Inventory Options page.

This page is defined by SetID. Any inventory business unit using this SetID for the record group IN_01 (business unit attributes) uses location accounting.

2. Define cost profiles to use storage area control.
3. Use the Storage Area Accounting page to establish ChartField combinations for each storage area within the inventory business unit.
4. (Manufacturing environment only) Use the Production Area Accounts page to define the ChartField combinations for each production area.
5. Use the Accounting Rules page to define ChartField combinations that are not included in the Storage Area Accounting page.

The system uses both pages to create the complete accounting entries.

After establishing the accounting structure, the Transaction Costing process costs transactions and the Accounting Line Creation process creates accounting entries. Both processes are initiated from the Cost Accounting Creation process page.

Pages Used to Define Location Accounting

Page Name	Definition Name	Usage
<u>Inventory Options Page</u>	BUS_UNIT_OPT_IN	Select the Location Accounting Required check box to turn on location accounting.
"TableSet Control - Record Group Page" (PeopleSoft General Ledger)	SET_CNTRL_TABLE1	Verify that the inventory business unit uses the SetID from the Inventory Options page. Check the record group IN_01.
Profiles Page	CM_PROFILE_DEFN	Use cost profiles to determine how the system costs items in the business unit's cost book. When using location accounting, select the Storage Area Control for Costs check box.
<u>Storage Area Accounting Page</u>	STORAGE_ACCT_INV	Define the ChartField combinations for each storage area. The system debits and credits these ChartFields when material is moved in and out of the storage area.
<u>Production Area Accounts Page</u>	SF_PRAREA_ACCT	Define the ChartField combinations for each production area. The system debits and credits these ChartFields when material is received into or issued from the production ID or schedule. This page applies to a manufacturing environment only.

Page Name	Definition Name	Usage
<u>Accounting Rules Page</u>	CM_ACCTG_DIST	Create the debit and credit lines for the accounting entries based on the business unit, transaction group, distribution type, item or item group, and cost element. The system uses this page in combination with the Storage Area Accounting page.

Related Links

[Defining the Accounting Structure](#)

Inventory Options Page

Use the Inventory Options page (BUS_UNIT_OPT_IN) to select the Location Accounting Required check box to turn on location accounting.

Navigation:

Set Up Financials/Supply Chain > Business Unit Related > Inventory > Inventory Options

To use storage location accounting, select the **Location Accounting Required** check box on the Inventory Options page. This page enables you to set up storage location structures and attributes (such as stocking units and dimensions) at the TableSet level. You can share these attributes with one or more inventory business units. Use the Set Control - Record Group page to attach these inventory options to an inventory business unit by setting the record group IN_01 to the same SetID that you used to define the Inventory Options page.

Related Links

"Inventory Options Page" (PeopleSoft Inventory)

Using Storage Area Control

It is highly recommended that if you are using location accounting, you should use the storage area control option located on the Cost Profile page (Set Up Financials/Supply Chain, Product Related, Cost Accounting, Cost Profiles, Profiles). Select the **Storage Area Control for Costs** check box to apply the FIFO or LIFO depletion method (defined in the cost profile) at the storage-area level. The system uses FIFO or LIFO as the cost based on the receipts to the specific storage area from which the item was depleted. In PeopleSoft Cost Management, you assign cost profiles to items to determine how to cost inventory transactions.

Storage area control can be used even with storage area accounting off. This enables you to stratify the granularity of FIFO and LIFO layers. For example, suppose that there is a FIFO cost flow method on the cost profile. Three receipts are putaway in an inventory business unit (receipts 1, 2, and 3). Each has a separate receipt cost. Receipt 1 is placed in the storage area Zone A. Receipts 2 and 3 are placed in Zone B. Then, items are issued from Zone B. Without storage area control, the deplete cost would be from receipt 1 in a FIFO environment, but with storage area control, the deplete cost comes from receipt 2, because it is the first within Zone B.

Related Links

[Cost Profiles Page](#)

Storage Area Accounting Page

To define accounting by storage area, use the Storage Area Accounting component (STORAGE_ACCTS). Use the Storage Area Accounting Rules component interface (STORAGE_ACCTS_CI) to load data into the tables for this component.

Use the Storage Area Accounting page (STORAGE_ACCT_INV) to define the ChartField combinations for each storage area.

The system debits and credits these ChartFields when material is moved in and out of the storage area.

Navigation:

Set Up Financials/Supply Chain > Product Related > Cost Accounting > Storage Area Accounting Rules > Storage Area Accounting

This example illustrates the fields and controls on the Storage Area Accounting page (partial page). You can find definitions for the fields and controls later on this page.

The screenshot shows the 'Storage Area Accounting' page. At the top, there are tabs for 'Storage Area Accounting'. Below the tabs, the 'Unit' is set to 'US008' and the 'Storage Area' is 'AREA1'. A section titled 'ChartFields' contains a table with the following columns: Cost Element, *Account, Alt Acct, Oper Unit, Fund, Dept, Program, Class, and Bud Ref. Each column has a search icon. The *Account field contains the value '131000'. Below the table is a navigation bar with a back arrow and a search icon.

Cost Element	*Account	Alt Acct	Oper Unit	Fund	Dept	Program	Class	Bud Ref
	131000							

If you are using location accounting, enter the ChartField combinations for each storage area using the Storage Area Accounting page. Use these ChartField combinations to create the debit entry when materials are received in the storage area and to create the credit entry when materials are issued from the storage area. The other side of the entry comes from the matching Accounting Rules page.

This page remains available to edit, thus, giving you the ability to alter the ChartField combinations over time.

Working with Cost Elements

An item can have one or more cost elements defined in its product structure. The Transaction Costing process calculates and stores the costs by cost element. During the Accounting Line Creation process, the system attempts to match up the item's transaction costs by cost element to any rows using the same cost element on the Storage Area Accounting page. If this is not found, then the system uses a row with a blank cost element. Therefore, you add flexibility to the system by adding different combinations of cost elements using different rows on the same page. Rows with a blank cost element can be used for any unspecified cost elements. If you can use the same ChartFields, regardless of the cost element, leave the **Cost Element** field blank.

Production Area Accounts Page

Use the Production Area Accounts page (SF_PRAREA_ACCT) to define the ChartField combinations for each production area.

The system debits and credits these ChartFields when material is received into or issued from the production ID or schedule. This page applies to a manufacturing environment only.

Navigation:

Production Control > Define Production > Production IDs/Schedules > Production Area > Accounts

If you are using location accounting in a manufacturing environment, use this page to define the ChartField combinations for the production areas to track in-process inventory. As material is received or issued from a production ID or production schedule, the system uses the ChartField combinations of the production area to create debit or credit entries. When you create accounting entries, the system debits the ChartFields specified here for any material consumption, earned labor, applied overhead, or favorable variances. The system also credits the ChartFields for any assembly completions to stock or to another production area, assembly scrap, or unfavorable variances. The other side of the entry comes from the matching Accounting Rules page.

This page remains available to edit, thus, giving you the ability to alter the ChartField combinations over time.

Select the production type for which the ChartFields are defined. You can define a set of accounts for *Production*, *Rework*, and *Teardown* production types.

Working with Cost Elements

In the Accounting Line Creation process, the system attempts to match up the item's transaction costs by cost element to any rows using the same cost element on the Production Area Accounts page. If this is not found, then the system uses a row with a blank cost element. If you can use the same ChartFields, regardless of the cost element, leave the **Cost Element** field blank.

Accounting Rules Page

Use the Accounting Rules page (CM_ACCTG_DIST) to create the debit and credit lines for the accounting entries based on the business unit, transaction group, distribution type, item or item group, and cost element.

The system uses this page in combination with the Storage Area Accounting page.

Navigation:

Set Up Financials/Supply Chain > Product Related > Cost Accounting > Transaction Accounting Rules > Accounting Rules

The Storage Area Accounting page and Production Area Accounts page defines one side of the accounting entry when material is putaway, issued, or adjusted within a storage or production area.

The other side of the accounting entry comes from the corresponding Accounting Rules page based on the business **Unit**, **Transaction Group**, **Item ID** or **Item Group**, and **Distribution Type** fields. If the

transaction is not directly related to a storage or production area, then the system derives both sides of the transaction from the appropriate Accounting Rules page.

If you are using location accounting, the system derives ChartField combinations that it uses to create accounting entries from these pages:

Transaction Group	Description	DR	CR
010	Receipt to Inspection	Storage Area Accounting	Accounting Rules
012	Return to Vendor	Accounting Rules	Storage Area Accounting
013	Return to Vendor From Inspection	Accounting Rules	Storage Area Accounting
020	Putaway	Storage Area Accounting	Accounting Rules
021	Receipts from Production	Storage Area Accounting	Production Area Accounts
024	Customer Returns	Storage Area Accounting	Accounting Rules
030	Usages & Shipments	Accounting Rules	Storage Area Accounting
032	Non Stock Shipment	Accounting Rules	Accounting Rules
037	VMI Interunit shipment	Accounting Rules	Storage Area Accounting
038	VMI Consumption	Accounting Rules	Storage Area Accounting
040	Physical Count Adjustments	Accounting Rules	Storage Area Accounting
041	Cycle Count Adjustment	Accounting Rules	Storage Area Accounting
050	User Adjustments	Accounting Rules	Storage Area Accounting
051	Inventory Scrap	Accounting Rules	Storage Area Accounting
052	Shipping Adjustment	Accounting Rules	Storage Area Accounting
053	Floor Stock Issues/Ret	Accounting Rules	Storage Area Accounting
054	Inventory Scrap for RTV	Accounting Rules	Storage Area Accounting
060	Bin-to-Bin Transfers	Storage Area Accounting	Storage Area Accounting

Transaction Group	Description	DR	CR
200	Inventory Revalue	Accounting Rules	Storage Area Accounting
201	Inventory Reval - Inspection	Accounting Rules	Storage Area Accounting
205	Value Adjustment	Accounting Rules	Storage Area Accounting
206	Value Adjust/ActCost Items	Accounting Rules	Storage Area Accounting
210	WIP Revalue (Comps, Assys)	Accounting Rules	Production Area Accounts
211	WIP Revalue (Conv Costs)	Accounting Rules	Production Area Accounts
212	WIP Revaluation (Scrap)	Accounting Rules	Production Area Accounts
220	Component Kit	Production Area Accounts	Storage Area Accounting
221	Route to Production Kit	Production Area Accounts	Production Area Accounts
222	Waste Completion	Production Area Accounts	Accounting Rules
223	Component/Output Transfers	Production Area Accounts	Production Area Accounts
230	Component Consumption	Production Area Accounts	Storage Area Accounting
231	WM Usage (Maintenance Management Usage)	Accounting Rules	Storage Area Accounting
240	Earned Labor	Production Area Accounts	Accounting Rules
250	Assembly Scrap	Accounting Rules	Production Area Accounts
261	Material Variances	Accounting Rules	Production Area Accounts
262	Conversion Variances	Accounting Rules	Production Area Accounts
263	Rework Expense	Accounting Rules	Production Area Accounts
264	Outside Processing PPV	Accounting Rules	Accounting Rules
265	Teardown Variance	Accounting Rules	Production Area Accounts

Transaction Group	Description	DR	CR
400	Std Cost Variance Receipts	Accounting Rules	Accounting Rules
401	Wt Avg Updates from AP	Storage Area Accounting	Accounting Rules
402	Std Cost Exchange Rate Var	Accounting Rules	Accounting Rules
403	Wt Avg Cost Updates - ERV	Storage Area Accounting	Accounting Rules
405	Wt Avg Update Writeoffs	Accounting Rules	Accounting Rules
407	Subcontract Standard Cost PPV2*	Accounting Rules	Accounting Rules
408	Subcontract Standard Cost PPV2 ERV*	Accounting Rules	Accounting Rules
415	RTV Variances	Accounting Rules	Accounting Rules
461	Voucher Variance Writeoffs	Accounting Rules	Accounting Rules
500	Miscellaneous Charges	Accounting Rules	Accounting Rules
501	Freight Charges	Accounting Rules	Accounting Rules
601	Wt Avg Upd Production Var	Storage Area Accounting	Accounting Rules
605	Wt Avg Upd Prod Writeoffs	Accounting Rules	Accounting Rules
606	Avg Rev Compl Write-off*	Accounting Rules	Accounting Rules
622	Actual Waste Cost	Production Area Accounts	Accounting Rules
630	Overhead	Production Area Accounts	Accounting Rules
640	Actual Labor Costs	Production Area Accounts	Accounting Rules
645	Actual Machine Costs	Production Area Accounts	Accounting Rules
651	Production Cost Writeoff	Production Area Accounts	Accounting Rules
661	Actual Cost Variances	Production Area Accounts	Accounting Rules

<i>Transaction Group</i>	<i>Description</i>	<i>DR</i>	<i>CR</i>
664	Subcontracted Cost	Accounting Rules	Accounting Rules

If the transaction involves interunit or intercompany transfers, then part of the accounting entries are derived from pages defined for the interunit model explained in the "Managing Interunit Transfer Pricing and Additional Costs" topic. The interunit and intercompany transaction groups include:

- 022 - IBU Transfer Receipts.
- 025 - InterCompany Receipts.
- 031 - InterBU Transfer Shipments.
- 035 - InterCompany Transfers.
- 042 - IBU Transfer Adjustments.
- 300 - Gain/Loss on Transfer Price.
- 301 - InterCompany Cost of Goods.

If the transactions involve Shipment On Behalf Of or InterUnit Expensed Issues, see the sections in this topic related to these subjects. These transaction groups are:

- 034 - Ship on Behalf of Other BU.
- 036 - InterUnit Expensed Issue.
- 026 - Expensed Issue Return.
- 302 - ShipOnBehalf Gain/Loss.

Related Links

[Understanding the Types of Interunit Transfers](#)

[Designing Shipment On Behalf Of](#)

[Creating and Reversing Interunit Expensed Issues](#)

[Accounting Rules Page](#)

"Understanding Stock Transfers Between Business Units" (PeopleSoft Inventory)

Establishing Commitment Control

The PeopleSoft commitment control feature enables you to check expenditures against a predefined budget. In PeopleSoft Cost Management, these expenditures typically occur when you expense inventory material to the department or to an expense account. Commitment control considers actual expenditures and imminent future obligations (encumbrances and pre-encumbrances). To use commitment control, select the commitment control option at both the installation options level and ledger group (product) level. Set up ChartField combinations as budgetary accounts for commitment control. There is a predefined source transaction definition, CM_TRNXTN, for PeopleSoft Cost Management. For further

information on setting up PeopleSoft Cost Management to use commitment control, see the *PeopleSoft Commitment Control*.

See "PeopleSoft Commitment Control Business Processes" (PeopleSoft Commitment Control)

If you select the commitment control option, then the Accounting Line Creation process page includes the check box for running the Commitment Control (Budget Checking) process (FSPKBDP3) against accounting lines prior to posting them to the general ledger. Any transaction using a ChartField combination setup as a budgetary account for commitment control will be processed through the Budget Checking process.

Commitment control can be used in PeopleSoft Cost Management by:

- A requisition or purchase order is entered in PeopleSoft Purchasing using commitment control and a pre-encumbrance or encumbrance is established. If the purchase order is sourced from PeopleSoft Inventory, then the encumbrance is relieved and replaced with an expenditure against the budget when the Accounting Line Creation process is run with the Budget Check Accounting Lines check box selected to run the Commitment Control Budget Processor.
- A material stock request is created and stock is issued from PeopleSoft Inventory using a ChartField combination set up as a budgetary account for commitment control. The deduction to the budget occurs when you run Accounting Line Creation, no pre-encumbrance or encumbrance is created or relieved.

Note: Budget checking is not applied to manufacturing transactions.

Related Links

[Creating Accounting Entries](#)

[Understanding Interunit Transfers](#)

"Understanding the Budget Checking of Source Transactions" (PeopleSoft Commitment Control)

"Understanding Commitment Control and General Ledger Journals" (PeopleSoft General Ledger)

"Understanding PeopleSoft Interunit and Intraunit Functionality" (Application Fundamentals)

Defining Interunit Transfers

Interunit transfers include any transfer of inventory stock between two inventory business units. PeopleSoft Cost Management creates the transactions related to the stock transfer using the Accounting Line Creation process.

Related Links

[Creating Accounting Entries](#)

[Understanding Interunit Transfers](#)

"Understanding PeopleSoft Interunit and Intraunit Functionality" (Application Fundamentals)

Setting Up Intraunit Processing

Intraunit processing creates balancing entries for transfers between ChartFields (such as Fund) within the same business unit. You can perform intraunit balancing on any ChartField within the business unit except account. You must first define the ChartField combinations for intraunit receivables and interunit payables that the system uses to create offsetting accounting entries. When you run the Accounting Line Creation process, the system checks for intraunit entries and creates the balancing entries using a subprocessor called ChartField Balancing (CM_IU_ACCTG).

The ChartField Balancing process compares debit and credit ChartFields (except Account) for the same item and cost element. If the ChartFields are not the same, the system creates the intraunit receivables or intraunit payables accounting entry.

For example, suppose that you enter this transaction for the same item and cost element. The system is set up for intraunit balancing on the fund ChartField. The intraunit payable account is 4003 and the interunit receivables account is 4002 for the transaction:

	<i>Account</i>	<i>Fund</i>	<i>Dept ID</i>	<i>Program</i>	<i>Class</i>	<i>Bdgt Pd</i>
Expense	5002	100	20	88	10	2000
Inventory	1001	200	30	99	20	2000

The Accounting Line Creation process creates the Due To and Due From transaction:

	<i>Account</i>	<i>Fund</i>	<i>DeptID</i>	<i>Program</i>	<i>Class</i>	<i>Bdgt Pd</i>
Offsetting Inventory	4003	200	30	99	20	2000
Offsetting Expense	4002	100	20	88	10	2000

Related Links

Creating Accounting Entries

"Understanding PeopleSoft Interunit and Intraunit Functionality" (Application Fundamentals)

"Using Standard ChartField Configuration" (Application Fundamentals)

Designing Shipment On Behalf Of

Shipment On Behalf Of is an order that issues stock to a customer from an inventory business unit on behalf of an order management business unit when each unit posts to a different general ledger unit. In a centralized order-taking environment, the order management business unit taking the customer order may or may not have a corresponding inventory business unit from which to ship the order. The customer order is then passed to the appropriate inventory business unit to fulfill the customer demand. When the

order is shipped and inventory is depleted, the system checks to see whether the general ledger business unit associated with the order management and billing unit matches that of the inventory business unit. When they differ, the system posts the shipment as transaction group 034 - Shipment on Behalf Of Other Business Unit. To correctly match the revenue recognition in the billing business unit's general ledger with the cost of goods sold for the inventory, the Accounting Line Creation process generates accounting entries using interunit accounts.

Shipment on Behalf Of process flow where the Order Management business unit reports to a different General Ledger business unit than the shipping Inventory business unit

This diagram illustrates the shipment on behalf of process flow. The stock is shipped from the inventory business unit to the customer and the associated PeopleSoft Cost Management business unit creates accounting entries for the revenue-side general ledger and the expense-side general ledger.

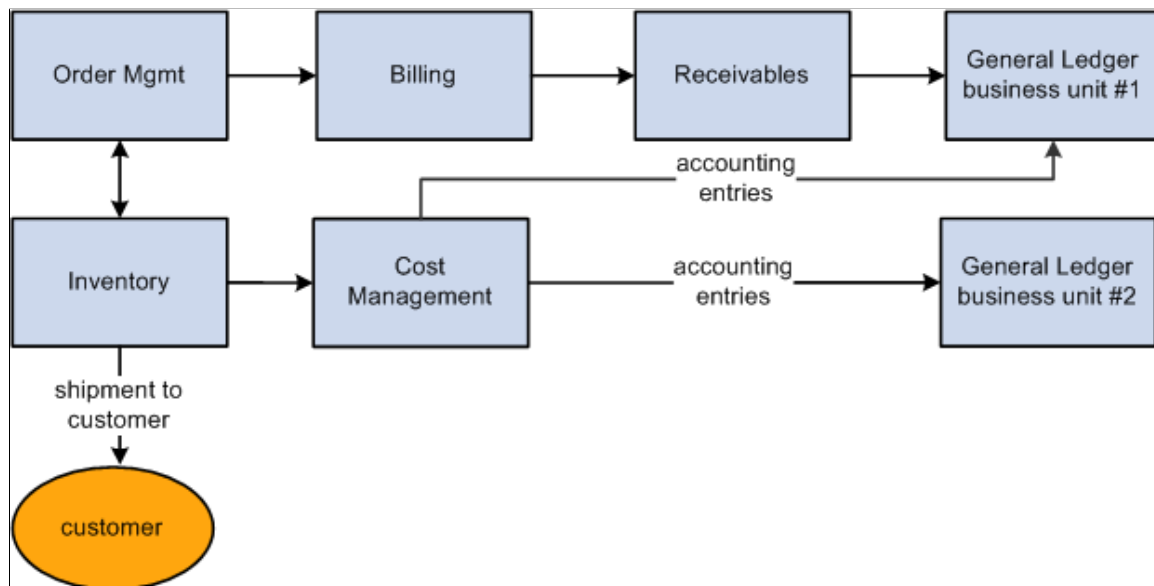

Determining the Amounts for a Shipment On Behalf Of Transaction

The Shipment On Behalf Of transactions are created in two parts:

1. The Deplete On Hand Qty process calculates the cost of the items shipped, the transfer price, and any additional transfer costs.
2. The Accounting Line Creation process generates the accounting entries using the inventory account, interunit accounts, cost of goods sold account, and any gain or loss accounts.

The interunit accounts include an accounts receivable (A./R) or Due From account in the shipping organization and an accounts payable (A/P) or Due To account in the organization recording the sale. The amount entered in the interunit A/R or A/P accounts can be the item cost or the transfer price. Additional transfer costs can also be added. In the shipping inventory business unit, your entry in the Ship on Behalf Transfer Price field of the Inventory Definition- Business Unit Definition page determines if the Deplete On Hand Qty process uses item cost or transfer price.

- *Using Item Cost:* The item cost based on the item's *deplete cost method* defined on the cost profile.
- *Using a Transfer Price:* The transfer price can be a flat amount, price markup, or both. The Transfer Pricing Definition page determines the transfer price. If no transfer pricing definition has been established for the shipping Inventory business unit, then the system uses item cost. The difference

between the transfer price and the item cost is recorded as in a gain/loss account using the transaction group 302 (ShipOnBehalf Gain/Loss).

- *Using Additional Transfer Costs:* Additional transfer costs, such as freight or handling, can be added to the shipment using the Transfer Pricing Definition component. These additional costs are added to the gain/loss account and the interunit accounts.

During demand fulfillment, the MSR is located in the IN_DEMAND table. Once the transfer price has been calculated by the Deplete On Hand Qty process, the transfer price is located in a child table, IN_DEMAND_TPRC, where it is broken out into several parts by cost elements. Cost elements can be created for material costs and additional transfer costs. The transfer price details can be viewed using the Transfer Price Inquiry component. The material and additional transfer costs are both included in the total transfer price. The transfer price details are retained by cost element in the accounting entries recorded for the Shipment On Behalf Of transaction.

The following information is used:

- Transfer price (material portion): 10.00
- Freight costs: 5.37
- Item cost: 8.25
- Cost element 100 (Material- General)
- Cost element 751 (Addl Trans- Freight)

The following diagram illustrates a Shipment On Behalf Of transaction shipping stock from the inventory business unit US010 on behalf of the order management business unit US200. The inventory business unit, US010, reports to the general ledger business unit US001. The order management business unit, US200, is linked to the billing unit, US200, receivables unit US120, and general ledger unit US120. In the inventory business unit, transfer price has been chosen using the Ship on Behalf Transfer Price field of the Inventory Definition- Business Unit Definition page.

Inventory Acct (US010/US001)		Interunit A/R (US010/US001)		Gain/Loss (US010/US001)	
(100)	8.25	(100)	10.00	(100)	1.75
		(751)	5.37	(751)	5.37
Interunit Cost of Goods Sold (US200/US120)			Interunit A/P (US200/US120)		
(100)	10.00	(100)	10.00	(751)	5.37
(751)	5.37	(751)	5.37		

The above diagram illustrates the accounting entries for a Shipment On Behalf Of transaction using the transaction group 034 (Ship on Behalf Of Other BU) and the transaction group 302 (ShipOnBehalf Gain/Loss). The inventory account is credited for the material costs. The interunit A/R and A/P accounts contains the transfer price of material and additional transfer costs. The gain and loss account contains the additional transfer cost plus any difference between the transfer price and the cost of the item. The cost of goods sold account and interunit A/P account move the cost of the item to the correct OM/BI/GL business unit chain that contains the revenue from the sale.

Setting Up Shipment On Behalf Of Transactions

To setup your organization for Ship On Behalf Of transactions:

1. Select to use item cost or transfer price for the interunit accounts. In the shipping inventory business unit, select *Use Item Cost* or *Use Transfer Price* in the Ship on Behalf Transfer Price field of the Inventory Definition- Business Unit Definition page.
2. (Optional) If you have selected *Use Transfer Price* in the Ship on Behalf Transfer Price field of the Inventory Definition- Business Unit Definition page, then you should create a transfer pricing definition for the shipping inventory business unit. The information on the Transfer Pricing Definition component should be defined for the source unit (inventory business unit) and a blank destination unit. This component provides the calculation of the item cost, transfer price, and any additional transfer costs. In addition, the transfer pricing definition gives the cost elements to be used for additional transfer costs plus any additional material costs. The transfer price default hierarchy is used to determine the transfer price.

See [Understanding Interunit Transfers](#).

3. Define the ChartField combinations for the following entry types of your inventory transaction code; interunit receivable, interunit payable, and interunit customer shipments. The entry type *interunit customer shipments* is for the cost of goods sold for shipments on behalf of.

Where you define these entry types depends on the value that you selected in the **InterUnit Method** field on the General Options - Overall page. If the value is:

- *Direct*: The ChartField combinations for the entry types are entered on the InterUnit Template page defined for both GL business units.
 - *Indirect*: The ChartField combinations for the entry types are entered on the InterUnit Template page defined for both GL business units.
 - *Pairs*: The ChartField combinations for the entry types are entered on the InterUnit Pair page. The sending GL unit must be entered in the **From GL Unit** field and the receiving unit must be defined in the **To GL Unit** field. A separate pair is defined for every combination of GL units using the Shipment on Behalf Of feature.
4. If you use the direct or indirect interunit methods, then enter the interunit template ID on the General Ledger Definition - Inter/IntraUnit page.
 5. Define the ChartField combinations for your inventory account:
 - For environments not using location accounting, define the ChartFields on the Accounting Rules page using the transaction group 034 (Shipments on Behalf of Other Business Unit).

- For environments using location accounting, define the ChartFields on the Storage Area Accounting page for each location that can ship goods.
6. If you have selected *Use Transfer Price* on the Inventory Definition- Business Unit Definition page, then define the ChartField combinations for your gain or loss account for the transaction group 302 (ShipOnBehalf Gain/Loss) using the Accounting Rules page.

Determining ChartField Combinations

For the transaction group 034 (Ship on Behalf of Other BU), the system uses these pages to derive ChartField combinations (accounts) for each accounting line. It uses different pages based on the choice of interunit method (selected on the General Options - Overall page in the installation setup) and location accounting (selected on the Inventory Options page when defining the inventory business unit):

<i>InterUnit Method</i>	<i>Location Accting</i>	<i>Page for DR Source BU</i>	<i>Page for CR Source BU</i>	<i>Page for DR Dest BU</i>	<i>Page for CR Dest BU</i>
Direct	Off	InterUnit Template (defined on the source GL)	Accounting Rules	InterUnit Template (defined on the destination GL)	InterUnit Template (defined on the destination GL)
Direct	On	InterUnit Template (defined on the source GL)	Storage Area Accounting	InterUnit Template (defined on the destination GL)	InterUnit Template (defined on the destination GL)
Indirect	Off	InterUnit Template (defined on the destination GL)	Accounting Rules	InterUnit Template (defined on the source GL)	InterUnit Template (defined on the source GL)
Indirect	On	InterUnit Template (defined on the destination GL)	Storage Area Accounting	InterUnit Template (defined on the source GL)	InterUnit Template (defined on the source GL)
Pair	Off	InterUnit Pair	Accounting Rules	InterUnit Pair	InterUnit Pair
Pair	On	InterUnit Pair	Storage Area Accounting	InterUnit Pair	InterUnit Pair

Pages Used to Design Shipment on Behalf Of

Page Name	Definition Name	Usage
"Inventory Definition - Business Unit Definition Page" (PeopleSoft Inventory)	BUS_UNIT_INV1	Define the basic attributes of a PeopleSoft Inventory business unit including the amount to be used in a Shipment On Behalf Of transaction. Select <i>Use Item Cost</i> or <i>Use Transfer Price</i> in the Ship on Behalf Transfer Price field of the Inventory Definition-Business Unit Definition page.
<u>Transfer Pricing Definition Page</u>	CM_TRAN_PRICE_DEFN	Define the transfer prices, markup percentages, and additional transfer costs to be used for a source business unit or a source and destination unit pair.
General Options - Overall Page	INSTALLATION_FS1	Select an interunit method. "Overall Page" (Application Fundamentals)
"General Ledger Definition - Definition Page" (PeopleSoft General Ledger)	BUS_UNIT_TBL_GL1	If using interunit templates, identify the template for both receiving and sending GL units.
"InterUnit Template Page" (Application Fundamentals)	IU_INTER_TMPLT	Set up the following entry types of your inventory transaction code; interunit receivable, interunit payable, and interunit customer shipments. Define the ChartField combinations (accounts) for each of these entry types.
"Interunit Pair Page" (Application Fundamentals)	IU_INTER_PR_BASIC	If the pairs method is selected on the General Options - Overall/GL page, then set up the following entry types of your inventory transaction code; interunit receivable, interunit payable, and interunit customer shipments. Define the ChartField combinations (accounts) for each of these entry types.

Related Links

[Using Transfer Pricing Definitions](#)

"Installation Options - Overall Page" (Application Fundamentals)

"Understanding PeopleSoft Interunit and Intraunit Functionality" (Application Fundamentals)

Creating and Reversing Interunit Expensed Issues

An interunit expensed issue is a stock request that issues material from an Inventory business unit to an internal department that is not reporting to the same GL unit as the inventory unit. If you are shipping stock from a centralized inventory location to various internal departments within the organization, then interunit expensed issues can create the proper accounting entries when multiple GL units are involved. The system creates an interunit expensed issue when you enter a stock request using the internal issue request type and then override the GL unit on the order. You can enter an interunit expense issue using the Material Stock Request or Express Issue pages in PeopleSoft Inventory. The system also processes interunit expense issues when demand is passed from a purchasing requisition and the GL unit on the requisition line is not the same as the inventory's GL unit. Use the Stock Request Maintenance page to add or change the destination GL unit. Use the Par Location Header page to define a destination GL unit for issues to a par location. When you override the GL unit, the system validates the destination ChartFields against the new GL unit.

Occasionally, the stock from an interunit expensed issue must be returned to inventory. Use the Expense Issue Return page to record the receipt of stock originally shipped as an interunit expensed issue. The stock can be received into the original sending inventory business unit or another inventory business unit. If the stock is received into a different inventory unit than the one from which it was initially shipped, then both inventory units must share the same set of items. You can enter the returned items on the Expense Issue Return page with or without the original interunit expensed issue stock request. To create an audit trail that goes back to the original shipment, you must retrieve and use the original interunit expensed issue transaction. You can return the full shipment or just part of the items or quantities shipped that you shipped.

Note: To run an interunit expensed issue, the currency and ChartFields must be the same for all the GL business units. For transactions with multiple currencies and accounting structures, enter an intercompany transaction (interunit sales approach) described in the "Managing Interunit Transfer Pricing and Additional Costs" topic.

See [Understanding Interunit Transfers](#).

Costing and Accounting Interunit Expensed Issues

The system uses the transfer price to cost the material issue. Define the method for interunit transfer pricing in the sending inventory business unit using the Transfer Pricing Definition component and the transfer price default hierarchy.

See [Applying Transfer Prices to a Material Stock Request](#).

See [Using Transfer Pricing Definitions](#).

You can change the transfer price manually on any line of a material stock request. The sending inventory business unit reduces its inventory stock based on the deplete cost method that you selected on the Cost Profiles page. The system records any difference between the transfer price and the item's depletion cost as a gain or loss on transfer.

When you create an interunit expensed issue, the Accounting Line Creation process creates accounting entries that debit the interunit receivables of the sending GL unit and credit the interunit payables of the recipient's GL unit. The system identifies interunit expensed issues with the transaction group 036 (InterUnit Expensed Issue). Set up the accounting distribution for this transaction group in a different

manner than the other transaction accounting rules. With this group, set up the debit for the destination GL unit and the ChartField validation against the destination GL unit. You cannot enter a cost element for the debit side of this entry. Set up the credit side for the inventory unit, if you are not using location accounting or if location accounting reports that it is using the function. Any difference between the transfer price and the item cost creates an additional entry using the transaction group 300 (Gain/Loss on Transfer Price).

The following diagram illustrates an example of the accounting entries generated for an interunit expensed issue transaction. The cost of the item is removed from the shipping organization's inventory account using the deplete cost method of the item's cost profile. In this case the item cost is 1,400 stored in the cost element 100 (material- general). The transfer price for the item is used to record the interunit accounts receivable in the shipping organization and the interunit accounts payable and expense accounts in the receiving organization. In this case, the transfer price is 1,500 stored in the cost element 100 (material- general). The transfer price is computed by the Deplete On Hand Qty process and placed in the IN_DEMAND_TRPC table. In the shipping organization, any difference between the item cost and the item transfer price is recorded in a gain/loss account using the transaction group 300 (Gain/Loss on Transfer Price).

Inventory Acct (shipping BU)	Interunit Accts Receivable (shipping BU)	Gain/Loss on Transfer Price (shipping BU)
(100) 1400.00	1500.00	(100) 100.00
Expense Acct (receiving organization)		Interunit Accts Payable (receiving organization)
1500.00		1500.00

For transaction group 036 (InterUnit Expensed Issue), use these pages to derive the ChartField combinations for each accounting line. Use different pages based on the choice of interunit method (that you selected on the Installation Options - Overall/GL page) and location accounting (that you selected on the Inventory Options page):

<i>InterUnit Method</i>	<i>Location Accting</i>	<i>Page for DR to Source BU</i>	<i>Page for CR to Source BU</i>	<i>Page for DR to Dest BU</i>	<i>Page for CR to Dest BU</i>
Direct	Off	InterUnit Template (defined on the source GL)	Accounting Rules	Accounting Rules (no cost element)	InterUnit Template (defined on the destination GL)

<i>InterUnit Method</i>	<i>Location Accting</i>	<i>Page for DR to Source BU</i>	<i>Page for CR to Source BU</i>	<i>Page for DR to Dest BU</i>	<i>Page for CR to Dest BU</i>
Direct	On	InterUnit Template (defined on the source GL)	Storage Area Accounting	Accounting Rules (no cost element)	InterUnit Template (defined on the destination GL)
Indirect	Off	InterUnit Template (defined on the destination GL)	Accounting Rules	Accounting Rules (no cost element)	InterUnit Template (defined on the source GL)
Indirect	On	InterUnit Template (defined on the destination GL)	Storage Area Accounting	Accounting Rules (no cost element)	InterUnit Template (defined on the source GL)
Pair	Off	InterUnit Pair	Accounting Rules	Accounting Rules (no cost element)	InterUnit Pair
Pair	On	InterUnit Pair	Storage Area Accounting	Accounting Rules (no cost element)	InterUnit Pair

Costing and Accounting InterUnit Expensed Issue Returns

Returns are completed using the Expense Issue Return page in PeopleSoft Inventory. To reverse the original interunit expensed issue transaction, the system uses the transfer price from the original stock request (if you have identified the interunit expensed issue transaction), or the value that you entered in the **Transfer Price** field on the Expense Issue Return page. The inventory business unit costs the receipt based on the receipt cost method that you selected on the Cost Profiles page. The system records any difference between the transfer price and the item's putaway cost as a gain or loss on transfer. For the GL unit that rejected the shipment, the system reverses the original entry by using the transfer price or you may override the price. When you use the original stock request (interunit expensed issue transaction), the system uses the transfer price stored in the IN_DEMAND_TRPC table where the transfer price is stored by cost elements. This granular detail is used to record the putaway. If you override the transfer price on the Expense Issue Return page, then the system uses the override transfer price and the Default Cost Element field defined on the Define Business Unit Item - General: Common page.

When you create an expensed issue return, the Accounting Line Creation process creates accounting entries that debit the interunit payables of the returning GL unit and credit the interunit receivables of the receiving inventory's GL unit, thereby reversing the original transaction. The system uses the transaction group 026 (Expensed Issue Return) to identify the ChartField combinations for the inventory account receiving the stock and the expense account to be reversed in the returning GL unit. Set up the accounting distribution for this transaction group in a different manner than the other transaction accounting rules. With this group, set up the credit to validate ChartFields against the returning GL unit. You cannot enter a cost element for the credit side of this entry. Set up the debit side for the inventory unit receiving the return, if you are not using location accounting or if location accounting reports that it is using the function. Any difference between the transfer price and the item's putaway cost creates an additional entry using the transaction group 300 (Gain/Loss on Transfer Price).

The following diagram illustrates an example of the accounting entries generated for an interunit expensed issue return transaction. The transfer price for the item is used to reverse the original entries in the returning organization's interunit accounts payable and expense accounts and the receiving organization's interunit accounts receivable account. In this case, the transfer price is 1,500 stored in the cost element 100 (material- general). The cost of the item is entered in the receiving organization's inventory account using the receipt cost method of the item's cost profile. In this case the item cost is 1,600. In the receiving organization, any difference between the item cost and the item transfer price is recorded in a gain/loss account using the transaction group 300 (Gain/Loss on Transfer Price).

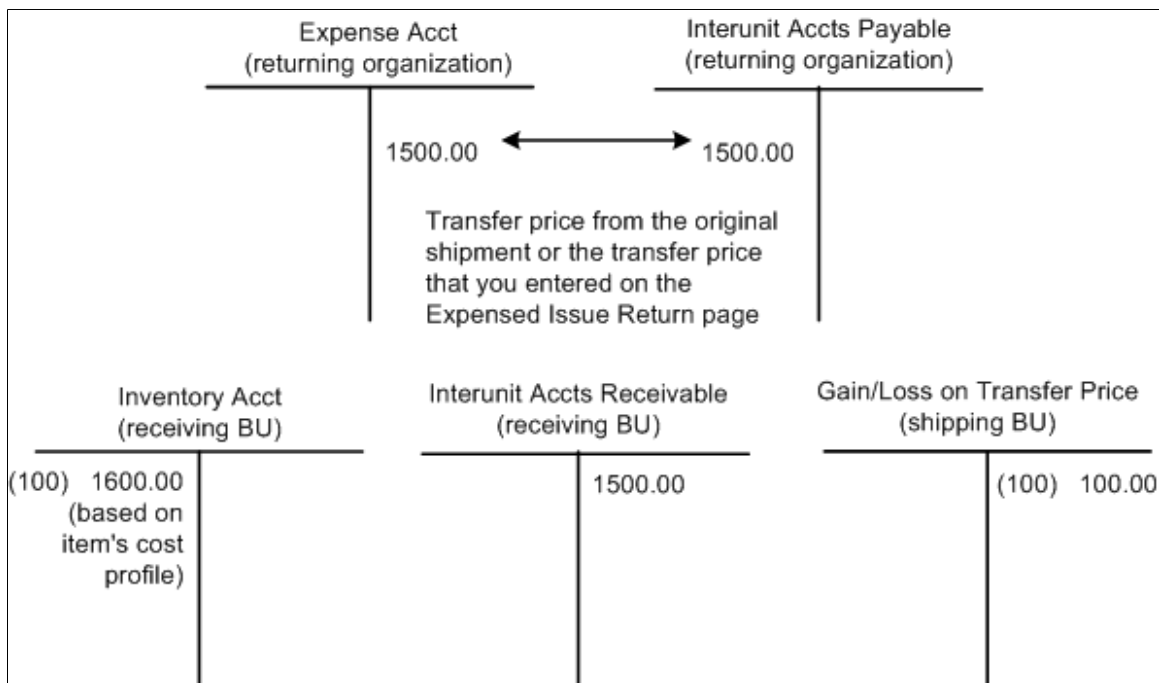

For the transaction group 026 (Expensed Issue Return), use these pages to derive the ChartField combinations for each accounting line. Use different pages based on the choice of interunit method (that you selected on the Installation Options - Overall/GL page) and location accounting (that you selected on the Inventory Options page). In this table, the *receiving GL* refers to the GL unit tied to the inventory unit that originally issued the stock. The *returning GL* refers to the GL unit returning the stock.

InterUnit Method	Location Accting	Page for DR Receiving Inv BU	Page for CR Receiving Inv BU	Page for DR Returning GL BU	Page for CR Returning GL BU
Direct	Off	Accounting Rules	InterUnit Template (defined on the receiving GL)	InterUnit Template (defined on the returning GL)	Accounting Rules (no cost element)
Direct	On	Storage Area Accounting	InterUnit Template (defined on the receiving GL)	InterUnit Template (defined on the returning GL)	Accounting Rules (no cost element)

InterUnit Method	Location Accting	Page for DR Receiving Inv BU	Page for CR Receiving Inv BU	Page for DR Returning GL BU	Page for CR Returning GL BU
Indirect	Off	Accounting Rules	InterUnit Template (defined on the returning GL)	InterUnit Template (defined on the receiving GL)	Accounting Rules (no cost element)
Indirect	On	Storage Area Accounting	InterUnit Template (defined on the returning GL)	InterUnit Template (defined on the receiving GL)	Accounting Rules (no cost element)
Pair	Off	Accounting Rules	InterUnit Pair	InterUnit Pair	Accounting Rules (no cost element)
Pair	On	Storage Area Accounting	InterUnit Pair	InterUnit Pair	Accounting Rules (no cost element)

Setting Up Interunit Expensed Issues

To enable Interunit Expensed Issues:

1. Enable interunit expense issues for PeopleSoft Inventory by selecting the **Display GL BU Override** check box on the Inventory Display Options page.

This option displays the **GL BU Override** field on the Material Stock Request, Express Issue and Stock Request Inquiry pages. On the Stock Request Maintenance page, the GL BU override is visible, but you cannot enter values if this option is not selected.

2. Define the interunit receivables and payables accounts.

Where you define these accounts depends on the value that you selected in the **InterUnit Method** field on the Installation Options - Overall page. If the value is:

- *Direct*: the interunit receivables or payables accounts are entered on the InterUnit Template page defined for both GL business units.
- *Indirect*: the interunit receivables or payables accounts are entered on the InterUnit Template page defined for both GL business units.
- *Pairs*: the interunit receivables or payables accounts are entered on the InterUnit Pair page. The sending GL unit must be entered in the **From GL Unit** field and the receiving unit must be defined in the **To GL Unit** field. A separate pair is defined for every combination of GL units using the interunit expensed issues feature.

3. Enter the interunit template ID on the General Ledger Definition - Inter/IntraUnit page, if you use direct or indirect methods.
4. Define the interunit transfer pricing using the Transfer Pricing Definition page.

InterUnit expensed issues are costed using the sending inventory business unit's transfer pricing structure.

- Use the Accounting Rules page to define the expense account (or accrued liability) to debit and the inventory account to credit using the transaction group 036 (InterUnit Expensed Issue).

If you are using location accounting, the inventory account (credit side) is derived from the Storage Area Accounting page. With this transaction group, the debit is set up for the returning GL business unit; you cannot enter a cost element for the debit side of this entry.

- Use the Accounting Rules page to record the gain or loss account to debit or credit when the item's cost differs from the transfer price using the transaction group 300 (Gain/Loss on Transfer Price).
- Use the Accounting Rules page to define the expense account (or accrued liability) to credit and the inventory account to debit using the transaction group 036 (Expensed Issue Return).

If you are using location accounting, the inventory account (debit side) is derived from the Storage Area Accounting page. With this transaction group, the credit is set up for the GL business unit returning the stock; you cannot enter a cost element for the credit side of this entry.

- Add reason codes for return.

On the Reason Codes page, define reason codes to describe the reason that the stock was returned, such as over stocked, damaged in shipment, and so on. When defining the reason codes, use the Return Type of *Expense Issue Return*. This allows you to select the reason code on the Expense Issue Return page.

Pages Used to Create and Reverse Interunit Expensed Issues

<i>Page Name</i>	<i>Definition Name</i>	<i>Usage</i>
"Stock Request Summary Page" (PeopleSoft Inventory)	EZ_ISSUE_INV	Enter an interunit expensed issue by using the internal issue request type and then override the GL unit on the order.
"Express Issue Page" (PeopleSoft Inventory)	EXPRESS_ISSUE1_INV	Enter an interunit expensed issue by using the internal issue request type and then override the GL unit on the order.
"Expense Issue Return Page" (PeopleSoft Inventory)	PUTAWAY_EXP_INV	Enter a return of stock originally issued as an interunit expensed issue transaction.
Inventory Display Options Page	BUS_UNIT_DSP_IN	Select the Display GL BU Override check box to enable interunit expense issues for the inventory business unit.
<u>Accounting Rules Page</u>	CM_ACCTG_DIST	Create the debit and credit lines for accounting entries based on the business unit, transaction group, distribution type, item or item group, and cost element.

Page Name	Definition Name	Usage
<u>Transfer Pricing Definition Page</u>	CM_TRAN_PRICE_DEFN	Define the transfer prices to be used for a shipping business unit.
Installation Options - Overall/GL Page	INSTALLATION_FS1	Select an interunit method. "Overall Page" (Application Fundamentals)
"General Ledger Definition - Definition Page" (PeopleSoft General Ledger)	BUS_UNIT_TBL_GL1	If using interunit templates, define the template for both receiving and sending GL units.
"InterUnit Template Page" (Application Fundamentals)	IU_INTER_TMPLT	If you selected the direct or indirect method on the Installation Options - Overall/GL page, then enter the interunit receivables and payables.
"Interunit Pair Page" (Application Fundamentals)	IU_INTER_PR_BASIC	If you selected the pairs method on the Installation Options - Overall/GL page, then enter the interunit receivables and payables for the GL pair.
Reason Code Page	REASON_CD	Enter reason codes to describe the various reasons that stock was returned. Use the Reason Type of Expense Issue Return.

Related Links

[Using Transaction Group Codes](#)

[Accounting Rules Page](#)

[Applying Transfer Prices to a Material Stock Request](#)

"Installation Options - Overall Page" (Application Fundamentals)

"Understanding PeopleSoft Interunit and Intraunit Functionality" (Application Fundamentals)

Defining the Cost Foundation for Makeable Items

Understanding the Manufacturing Standard Cost Foundation

Before you calculate the cost of purchased components or make items, define the basic codes and tables that PeopleSoft Cost Management uses to build and categorize an item's cost; including, the labor, machine, subcontracting, and overhead rates. The system enables you to create multiple scenarios for standard costing by using cost types and versions.

This diagram illustrates the elements that are used to define the costing structure. The cost type and cost element are used to build the costing conversion rates and the costing conversion overhead rates along with the conversion code or the overhead conversion code. The cost version is used in combination with the cost type to define the costing conversion rates:

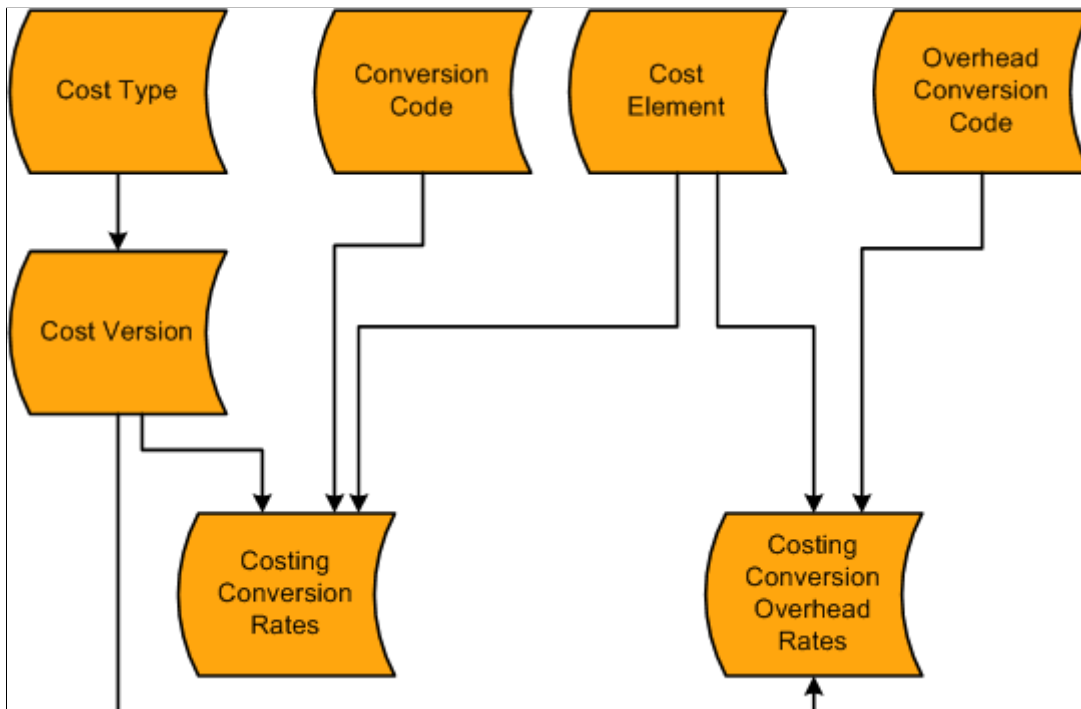

You can define how the system calculates the cost of purchased components by using the cost type page for the end item.

You can add additional costs to a manufactured item by using the Additional Item Costs page. These costs are applied after all labor, machine, material, and overhead costs are added.

Defining the Standard Cost Foundation

Before you can calculate the standard cost of purchased or makeable items, you can define the basic codes and tables that PeopleSoft Cost Management uses to build and categorize an item's standard cost.

This section discusses how to:

1. Define cost types.
2. Define cost versions.
3. Create standard cost groups.
4. Define cost elements.
5. Define conversion codes.
6. Define conversion overhead codes.
7. Create costing conversion rates.
8. Create costing conversion overhead rates.
9. Copy cost structures.
10. Copy rates.
11. Update conversion rates.

Pages Used to Define the Standard Cost Foundation

Page Name	Definition Name	Usage
<u>Cost Types Page</u>	CE_TYPE	Define cost types.
<u>Cost Versions Page</u>	CE_VERSION	Define cost versions.
<u>Standard Cost Groups Page</u>	CM_COSTGROUP	(For standard costing only) Create cost groups.
<u>Cost Elements Page</u>	CM_ELEMENT	Define cost elements.
<u>Production Conversion Codes Page</u>	CE_CONCODE	Define production conversion codes.
<u>Production Overhead Codes Page</u>	CE_OHCODE	Define conversion overhead codes.
<u>Conversion Rates Page</u>	CE_CONRATE	Create cost conversion rates.

Page Name	Definition Name	Usage
<u>Overhead Rates Page</u>	CE_CONOH_RATE	Create cost conversion overhead rates.
<u>Copy Cost Structures Page</u>	CE_COPY_COST_STRUC	Copy cost structures.
<u>Copy Cost Types/Versions Page</u>	CE_COPY_COSTS	Copy cost rates.
<u>Update Conversion Rates Page</u>	CE_MANFRZ_CON	Update conversion rates.

Cost Types Page

Use the Cost Types page (CE_TYPE) to define cost types.

Navigation:

Set Up Financials/Supply Chain > Product Related > Cost Accounting > Cost Types

Create separate costing groupings with different methods of costing, such as current, revised or forecasting. The cost type also defines how purchased components are calculated.

Cost Versions Page

To define cost versions, use the Cost Versions component (CE_VERSION).

Use the Cost Versions page (CE_VERSION) to define cost versions.

Navigation:

Cost Accounting > Item Costs > Define Rates and Costs > Cost Versions

This example illustrates the fields and controls on the Cost Versions page. You can find definitions for the fields and controls later on this page.

*Cost Version	*Cost Type	*Version Type	Description	Date Added	*Status
ENG1	CUR	Engineering	Engineering Costs	05/09/2000	Pending
REV1	CUR	Production	Initial Std Cost Load	05/09/2000	Approved
REV2	CUR	Production	New Std Costs	08/16/2000	Pending
SIM1	CUR	Simulation	Cost Simulation	05/09/2000	Pending

Use the Cost Versions page to define the different cost versions for a cost type. You can create unlimited cost versions for any cost type. By using different versions for a cost type, you can maintain a history of the different costs that are calculated for each cost type. You can base these cost versions on different sets

of assumptions, such as different bills of material (BOMs; manufacturing versus engineering), effective dates, different labor rates, or different budgets that determine the overhead expenses.

Field or Control	Description
Version Type	<p>Determines the BOM and routing that the Cost Rollup process (CEPCROLL) uses to calculate the cost of make items. Values are:</p> <p><i>Production:</i> Rolls up manufacturing data only and uses the primary BOM and routing only, each with a code of 1. Use this option to roll up the costs for a manufactured or configured item. This is the only option that produces cost calculations that can update the live production tables.</p> <p><i>Engineering:</i> Rolls up with either manufacturing or engineering data, with any combination of BOM and routing codes. Use this option exclusively for engineering roll-ups and comparisons.</p> <p><i>Simulation:</i> Only rolls up with manufacturing data, but can use any combination of BOM and routing codes. Use this option to create what-if scenarios for makeable items.</p>

Each cost version can have a status of pending, denied, or approved. You can update frozen standard costs used for accounting purposes only if the cost version status is approved. Cost versions that are related to engineering or simulation always have a status of pending.

Standard Cost Groups Page

To create standard cost groups, use the Cost Groups (CM_COSTGROUP) component.

Use the Standard Cost Groups page (CM_COSTGROUP) to (For standard costing only) Create cost groups.

Navigation:

Set Up Financials/Supply Chain > Product Related > Cost Accounting > Standard Cost Groups > Cost Groups

This example illustrates the fields and controls on the Standard Cost Groups page. You can find definitions for the fields and controls later on this page.

*Standard Cost Group	Description	Short Description		
BRD	Boards	Boards	+	-
CPITEM	Configured Items	CP Items	+	-
DTOP	Desktop Computers	Desktop	+	-
HOU	Housings	Housings	+	-
IC	Integrated Circuits	ICs	+	-
NBOOK	Notebook Computers	Notebook	+	-

Standard cost groups, also known as cost groups, enable you to group together a set of items for standard cost roll up and standard cost update, comparing costs and reporting inventory value. Add items to the cost group by entering the standard cost group on the item's Define Business Unit Item - General: Common page. Then, enter a standard cost group on the Cost Rollup page or the Cost Update/Revalue page instead of defining a range of item IDs.

Cost Elements Page

To create cost elements, use the Cost Element (CM_ELEMENT) component.

Use the Cost Elements page (CM_ELEMENT) to define cost elements.

Navigation:

Set Up Financials/Supply Chain > Product Related > Cost Accounting > Define Cost Elements

Cost elements categorize the components of an item's cost that are tracked through the PeopleSoft Inventory system. The debit and credit ChartField combinations in transaction processing can also be defined by cost element.

Related Links

[Cost Elements Page](#)

Production Conversion Codes Page

To define conversion codes, use the Conversion Codes component (CE_CONCODE). Use the Production Conversion Code component interface to load data into the tables for this component.

Use the Production Conversion Codes page (CE_CONCODE) to define production conversion codes.

Navigation:

Set Up Financials/Supply Chain > Product Related > Cost Accounting > Production Conversion Codes

This example illustrates the fields and controls on the Production Conversion Codes page. You can find definitions for the fields and controls later on this page.

The screenshot shows the 'Production Conversion Codes' page. At the top, there are tabs for 'SetID', 'SHARE', and 'CORPORATE SETID'. Below that is a header bar with 'Conversion Codes' and navigation options like 'Personalize', 'Find', 'View All', 'First', '1-6 of 25', and 'Last'. The main content is a table with the following data:

*Conversion Code	Description	Short Description		
4401	Technical	Technical	+	-
4402	Assembler	Assembler	+	-
4403	Painter	Painter	+	-
4404	Material Handler	Matl Hand	+	-
4405	Quality Assurance	QA	+	-
4406	Inspection	Inspection	+	-

Production conversion codes can be used to categorize labor, machine, and other conversion tasks and activities within work centers in the manufacturing process. Use conversion codes to define conversion rates that are associated with work centers or tasks.

Production Overhead Codes Page

To define cost conversion production overhead codes, use the Conversion Overhead Codes component (CE_OHCODE_CODE). Use the Conversion Overhead Codes component interface to load data into the tables for this component.

Use the Production Overhead Codes page (CE_OHCODE) to define conversion overhead codes.

Navigation:

Set Up Financials/Supply Chain > Product Related > Cost Accounting > Production Overhead Codes > Conversion Ovhd Codes

This example illustrates the fields and controls on the Production Overhead Codes page. You can find definitions for the fields and controls later on this page.

Production Overhead Codes

SetID SHARE CORPORATE SETID

Conversion Overhead Codes Personalize | Find | View All | First 1-7 of 19 Last

*Ovhd Code	Description	Short Description		
600	Inspection	Inspection	+	-
601	Manual Insertion	Man Insert	+	-
602	Auto Insertion	Auto Inser	+	-
603	Line Assembly	Line Assem	+	-
604	Final Assembly	Fin Assy	+	-
605	QC	QC	+	-
611	Notebook Assembly	NB Assy	+	-

Production conversion overhead codes categorize the different types of overhead costs absorbed during the manufacturing process. Use conversion overhead codes to define conversion overhead rates that are associated with work centers or tasks. You can specify up to four conversion overhead codes for the work center or task.

Conversion Rates Page

To define cost conversion rates, use the Costing Conversion Rates component (CE_CONV_RATE). Use the Costing Conversion Rates component interface to load data into the tables for this component.

Use the Conversion Rates page (CE_CONRATE) to create cost conversion rates.

Navigation:

Cost Accounting > Item Costs > Define Rates and Costs > Conversion Rates > Costing Conversion Rates

This example illustrates the fields and controls on the Conversion Rates page. You can find definitions for the fields and controls later on this page.

Conversion Rates

Business Unit US008
 Cost Type CUR Current Costs
 Cost Version REV1 Initial Std Cost Load
 Version Type Prdn

Conversion Codes Find | View All First 1 of 6 Last

*Conversion Code 4401 Technical Where-Used

*Type	Rate	Per	*Cost Element	Description
Labor Setup Rate	25.0000	Hour	300	Set Up Lab
Labor Fixed Run Rate	14.0000	Hour	301	Run Labor

Establish these rates to capture labor and machine costs in the production process. You can enter fixed run, run, post-production, and set up rates for both labor and machine. The rates are based on several factors, including business unit, cost type, cost version, conversion code, and conversion rate type. Each conversion rate type then points to a cost element. Multiple conversion code definitions can point to the same or different cost elements. This structure gives you flexibility to set up and use several different rates. Link these rates with a work center or task where they are used to determine the labor, machine, and subcontracting costs of an item's routing operation.

For each conversion rate type that you want to associate with a specific conversion code, enter a rate.

Field or Control	Description
Conversion Rate Type	Enter fixed run, run, post-production, or set up rates for either labor or machine. These rate types correspond to the costing rate types that are defined for a task, and ultimately, to an operation on an item's routing or operation list. You do not need to enter a cost for each conversion rate type. However, if any costing time type on the task, routing, or operation list does not have a corresponding cost, then the system does not include that portion of the routing or operation list cost in the item cost. This enables you to call out task types which have different cost implications for the same conversion code in different cost types or versions. Likewise, if you specify a cost in the conversion rates but do not include the corresponding costing times in the routing or operation list, those costs are not included.
Rate	Enter conversion code rates. Use production conversion codes to associate conversion rates with multiple work centers or tasks. Use the Rate Maintenance/Defaulting group box on the Manufacturing Options - MFG Business Unit Options page to determine whether to enter conversion rates for work centers or tasks.

Field or Control	Description
Per	Specify how the rate should be applied. You can enter conversion rates as an amount per <i>Hour</i> for labor and machine setup, fixed run, and post production. For labor and machine run, you can specify an amount per <i>Hour</i> or <i>Unit</i> .
Cost Element	Enter the cost element that is associated with this conversion cost. This cost element must have the category of conversion on the Cost Elements page.

For subcontracted tasks or operations, the conversion cost should represent the charge from the supplier for the outside processing. If the supplier charges you a flat amount per unit, enter that charge as a per unit cost. If the supplier quotes you a rate per hour, enter that rate as a labor-setup, run, or fixed-run rate and enter the corresponding time that it takes the supplier to complete the task on the item's routing or operation list.

Related Links

"MFG Business Unit Options Page" (PeopleSoft Manufacturing)

Overhead Rates Page

To define cost conversion overhead rates, use the Costing Conversion Overhead Rates component (CE_CONV_OH_RATE). Use the Overhead Rates component interface to load data into the tables for this component.

Use the Overhead Rates page (CE_CONOH_RATE) to create cost conversion overhead rates.

Navigation:

Cost Accounting > Item Costs > Define Rates and Costs > Overhead Rates > Costing Conv Ovhd Rates

This example illustrates the fields and controls on the Overhead Rates page. You can find definitions for the fields and controls later on this page.

The conversion overhead rates represent the overhead expenses that are associated with the production of the assemblies. Enter the cost conversion overhead rates to use for overhead costs based on the units produced, labor and machine hours, or labor and machine costs. The rates are based on business unit, cost type, cost version, conversion overhead code and cost element. You can establish several different rates. In the case of subcontracted tasks or operations, it should represent the cost of preparing and sending the item to the subcontractor for outside processing.

Select the rate type that you want to associate with the rate code. Valid rate types include:

Field or Control	Description
Per Unit Amount	Select to apply cost to the item on a per unit basis.
% of Labor Amount (percentage of labor amount)	Select to base on the standard labor costs that the operation requires. To determine the amount of overhead cost, the system first calculates the total labor cost of the operation, then multiplies that cost by the factor that is specified in the Conversion Overhead % field.
Amt per Labor Hr (amount per labor hour)	Select to base on the standard labor hours that the operation requires. As with labor cost determination, it determines the number of hours that are necessary to complete the operation by adding labor setup, run, fixed-run, and post-production times (converted to hours), and then multiplies that time by the amount that is specified in the Conversion Overhead Rate field.

Field or Control	Description
% of Machine Amount (percentage of machine amount)	This is similar to the percent of labor amount method except that the overhead cost is based on the machine costs that are associated with the operation. To determine the amount of the overhead cost to apply, the system first calculates the total machine cost of the operation, then multiplies that cost by the factor that is specified in the Conversion Overhead % field.
Amt per Machine Hr (amount per machine hour)	This is similar to the amount per labor hour method except that the overhead cost is based on the machine hours that are necessary to complete the operation. The system determines the number of hours that are necessary to complete the operation by adding machine setup, run, fixed-run, and post-production times, converted to hours, and multiplies that time by the amount that is specified in the Conversion Overhead Rate field. If you don't specify costing machine hours or run rates for the operation, the system does not apply overhead costs.
Cost Element	Enter the cost element that is associated with this conversion cost. This cost element must have the category of conversion overhead on the Cost Elements page.

Copy Cost Structures Page

Use the Copy Cost Structures page (CE_COPY_COST_STRUC) to copy cost structures.

Navigation:

Cost Accounting > Item Costs > Define Rates and Costs > Copy Cost Structures

Copy the cost foundation structures: cost types, cost elements, production conversion codes, and production overhead codes from one SetID to another. This process copies only the codes that are associated with each record and not the rates or costs that are associated with those codes.

Copy Cost Types/Versions Page

Use the Copy Cost Types/Versions page (CE_COPY_COSTS) to copy cost rates.

Navigation:

Cost Accounting > Item Costs > Define Rates and Costs > Copy Cost Types/Versions

Copy costs and rates from one business unit to another. If another business unit has the rates and item costs that you want to use, or if you want to use one set of cost type and version information as the basis for other cost types or versions, you can use this page to copy those costs and rates.

Update Conversion Rates Page

Use the Update Conversion Rates page (CE_MANFRZ_CON) to update conversion rates.

Navigation:

Cost Accounting > Item Costs > Update Costs > Update Conversion Rates

This example illustrates the fields and controls on the Update Conversion Rates page. You can find definitions for the fields and controls later on this page.

Update Conversion Rates

*Business Unit

*Cost Type Current Costs

*Cost Version Initial Std Cost Load

Conversion Code Painter

Conversion Overhead Codes

Code One <input type="text" value="6504"/>	Code Three <input type="text"/>
Code Two <input type="text" value="6505"/>	Code Four <input type="text"/>

Conversion Codes to Copy Personalize | Find | View All | | First 1-3 of 8 Last

Conversion Rate Type	Rate Per	Cost Element	Short Description
Labor Setup Rate	8.5000 HR	300	Set Up Lab
Labor Fixed Run Rate	8.5000 HR	301	Run Labor
Labor Run Rate	0.2500 UN	301	Run Labor

Conv Ovhd Codes to Copy Personalize | Find | View All | | First 1 of 1 Last

Ovhd Code	Conversion Ovhd Rate Type	Ovhd Rate	Ovhd %	Cost Element	Short Description
6504	Amt Per Mach Hr	3.8500		501	Ovhd - Mac

Use this page to update the set of production conversion rates and conversion overhead rates. For standard cost items, run the Cost Update/Revalue process (RUN_CES5001) to copy these conversion rates and conversion overhead rates into production. It then uses these rates to calculate earned labor and machine costs, as well as applied overhead for the assembly completions and scrapped assemblies. If you are introducing a new conversion rate or conversion overhead rate for a single item whose cost you are updating, you must also update the set of production conversion rates and conversion overhead rates that are used to calculate the item's cost. The lower portion of the page displays the conversion rates and conversion overhead rates to copy to the frozen rates records. Save the page to update the rates.

Calculating the Cost of Purchased Components

This section provides an overview of component costs and discusses how to forecast purchase costs.

Pages Used to Calculate the Cost of Purchased Components

<i>Page Name</i>	<i>Definition Name</i>	<i>Usage</i>
Cost Types Page	CE_TYPE	Define the method that is used to calculate the cost of purchased components.

Page Name	Definition Name	Usage
"Define Business Unit Item - Manufacturing: General Page" (PeopleSoft Manufacturing)	GEN_ATTRIB_INV	Enter the current purchase cost. This page displays the item's average purchase price and last price paid.
<u>Forecasted Purchase Costs Page</u>	CE_FCST	Enter forecasted purchase costs.

Understanding Component Costs

The standard cost of all purchased components must be accurate when rolling up the cost of a manufactured item. For standard cost items, the cost type that is entered in the Cost Rollup page determines how these costs are calculated. For actual and average cost items, the cost type is applied through the cost book that is defined at the inventory business unit definition. Select the method of calculating the purchased component's cost on the **Purchased Cost Used** field of the Cost Types page. Component costs include:

Term	Definition
Average Purchase Price	A weighted average of all purchases of this item that are calculated by the system.
Current Purchase Cost	Cost manually entered on the Define Business Unit Item - General: Common page.
Forecasted Purchase Cost	Cost manually entered on the Forecasted Purchase Costs page.
Last Price Paid	The purchase price recorded with the last receipt of this item. This price appears on the Define Business Unit Item - General: Common page.

It is possible that the system might not find a purchase cost for a component. For example, if you select the average or last price methods and the purchased item is new with no receipts, then the cost is zero. For items using standard costing, use the Cost Rollup page to select the **Use Current Cost When No Price** check box to use the current purchase cost whenever the calculated purchase cost is zero. If you select this check box, be sure to enter a value in the **Current Purchase Cost** field on the Define Business Unit Item - General: Common page.

Related Links

[Cost Types Page](#)

[Using the Cost Rollup Process to Calculate Product Costs](#)

"Define Business Unit Item - General: Common Page" (PeopleSoft Managing Items)

Forecasted Purchase Costs Page

To define forecasted purchased costs, use the Forecasted Purchase Cost (CE_FCST) component. Use the Forecasted Purchase Rates component interface to load data into the tables for this component.

Use the Forecasted Purchase Costs page (CE_FCST) to enter forecasted purchase costs.

Navigation:

Cost Accounting > Item Costs > Define Rates and Costs > Forecasted Purchase Costs > Forecasted Purchase Cost

This example illustrates the fields and controls on the Forecasted Purchase Costs page. You can find definitions for the fields and controls later on this page.

Forecasted Purchase Costs

Unit: US008
 Item ID: BKCS-1 Std UOM: EA Source Code: Buy
 Bike Transport Case

Costs by Type and Version							Customize Find View All First 1-2 of 2 Last	
*Cost Type	Description	*Cost Version	Description	Version Type	Amount	*Cost Element		
<input type="text" value="CUR"/>	Cur Costs	<input type="text" value="REV1"/>	Initial Std Cost Load	Prdn	50.0000	<input type="text" value="100"/>	<input type="button" value="+"/>	<input type="button" value="-"/>
<input type="text" value=""/>		<input type="text" value=""/>			0.0000	<input type="text" value=""/>	<input type="button" value="+"/>	<input type="button" value="-"/>

Use the Forecasted Purchase Costs page to use negotiated prices for the purchased components in the calculation of makeable items. This enables you to perform what-if scenarios or simulations by changing the material cost assumptions for each cost type and version combination. The amount that is entered should be the cost of the item only, exclusive of any freight, duty, or procurement expenses. The cost element that is selected must have a cost category of *Material* assign on the Cost Elements page.

<i>Field or Control</i>	<i>Description</i>
Amount	Enter the cost of the item only, exclusive of any freight, duty, or procurement expenses.

<i>Field or Control</i>	<i>Description</i>
Cost Element	Enter a cost element with a cost category of material assign on the Cost Elements page.

Note: Be sure that the cost type that you enter designates forecasted purchase costs as the purchase cost that is used. If you use forecasted purchase costs, you must define a cost for every purchased item.

Related Links

[Cost Types Page](#)

Adding Additional Costs

To define additional costs for a make item, use the Additional Costs by Item component. Use the Additional Costs by Item component interface to load data into the tables for this component.

This section discusses how to enter additional costs by item.

Page Used to Add Additional Costs

<i>Page Name</i>	<i>Definition Name</i>	<i>Usage</i>
<u>Additional Item Costs Page</u>	CE_ITEMEXP	Add additional costs to purchased or makeable items.

Additional Item Costs Page

Use the Additional Item Costs page (CE_ITEMEXP) to add additional costs to purchased or makeable items.

Navigation:

Cost Accounting > Item Costs > Define Rates and Costs > Additional Item Costs > Additional Costs by Item

To define additional costs, use the Additional Costs by Item component (CE_ITEMEXP).

This example illustrates the fields and controls on the Additional Item Costs page. You can find definitions for the fields and controls later on this page.

The screenshot displays the 'Additional Item Costs' interface. At the top, it shows the Business Unit as 'US008', Item ID as 'HB7101', Std UOM as 'EA', and Source Code as 'Buy'. Below this, there are sections for 'Costs by Type and Version' and 'Additional Cost Details'. The 'Costs by Type and Version' section includes fields for '*Cost Type' (CUR) and '*Cost Version' (REV1). The 'Additional Cost Details' section contains fields for 'Exp Sequence No.' (10), 'Descr' (Material Overhead), '*Application Method' (% of Material Cost), 'Expense Percentage' (55.0), '*Transaction Group' (020 Putaway), and '*Cost Element' (200). Navigation controls like 'Find | View All', 'First', and 'Last' are visible in the top right of each section.

You can add additional costs to the cost of a manufactured or purchased item by using the Additional Item Costs page. This enables the system to calculate and track the fully burdened cost of the item. Examples of additional costs are duty, freight, inspection, procurement expenses, and material handling. Based on

the cost type and cost version combination that is defined for the business unit and item and entered on the Cost Rollup page, the system adds these additional costs, one cost at a time. These costs are applied after all labor, machine, material, and overhead costs are added.

When you use this page to add landed cost components to an item, you can track and analyze the total landed cost for that item. You can set up consigned items as landed cost items; if you do, the system transacts all accrued landed cost charges when the consigned item is consumed.

The **Exp Sequence No** (expense sequence number) determines the order in which the system applies costs; it is especially critical when it applies the rate to the total cost. The total cost base includes material, labor, machine, subcontracting, overhead costs, and any additional cost that was previously applied to that point.

You must define how the system calculates the additional cost. **Application Method** values include:

Field or Control	Description
<i>% of Material Cost</i> (percentage of material cost)	Select to multiply the percentage that is specified by the sum of all costs whose cost category you set to <i>Material</i> on the Cost Elements page.
<i>% of Total Costs</i> (percentage of total costs)	Select to include all material, labor, machine, subcontracting, and conversion overhead costs, plus any previously calculated additional costs as the total cost basis. For example, suppose that the item material cost is 1.00 and you define an additional cost for sequence 10 as 50 percent of material cost and sequence 20 as 100 percent of total cost. The basis for applying additional costs for sequence 20 is 1.50 (1.00 of material cost plus 50 percent of 1).
<i>Amount Per Unit</i>	Select to add this amount to the cost of the item. You can use this method if you determine activity costs and apply those costs to items that consume the activity.

The **Transaction Group** field defines the point at which you apply the additional costs into inventory:

Field or Control	Description
<i>020 Putaway</i>	Select to receive the item into inspection or stock using the transaction group 020 Putaway. For purchased items, this takes place following receiving and inspection, whereas for makeable items this takes place following the completion from a production area and receipt into stock or to another production area. All landed costs use the Putaway transaction group.
<i>030 Usages & Shipments</i>	Select to issue the item out of inventory to a customer or to another business unit using the transaction group 030 Usages & Shipments. Costs that are applied at the time of issue are never included in the item's inventory value.

Note: For standard cost items, if you run the Cost Update/Revalue process for the item that is specified, then you cannot change the transaction group selection.

Assign a **Cost Element** for each additional cost. The cost element selected must have a cost category of *Inbound*, *Outbound*, *Landed*, or *Other* entered on the Cost Elements page.

Related Links

[Cost Elements Page](#)

Chapter 5

Using Standard Costing for Purchased Items

Understanding Standard Costing for Purchased Items

When items are defined with a frozen standard cost profile, the Transaction Costing process (within the Cost Accounting Creation process):

- Values all receipts (putaways) at the frozen standard cost.
- Values all depletions using the frozen standard cost.
- Purchase price variance (PPV) is calculated as the difference between the frozen standard cost and the actual cost on the matched, posted, and extracted vouchers.

The exchange rate variance (ERV) is the change between the exchange rate for material and landed costs on the PO and the exchange rate for material and landed costs on the voucher. These variances are calculated when you run the Transaction Costing process with the Cost Mode of *Regular*. To delay calculation of the variances, run the Transaction Costing process in *Mid Period* mode. Based on the timing of the voucher processing, the Landed Cost Extract process and the Transaction Costing process, the Purchase Price Variance could be computed and posted in two parts: standard vs. PO price, and PO price vs. voucher price, or in one part alone: standard vs. voucher price.

The standard cost of an item can be:

- Calculated using the Cost Rollup process, followed by the Update Production process (Cost Update/Revalue process page). This method creates accounting entries to adjust the current on-hand stock to the new standard cost.
- Manually adjusted using the Item Production Costs page for new items that have no activity.

This method only affects future transactions. The current inventory balance is still based on the old standard cost. This approach is not recommended for most organizations.

Related Links

"Understanding PeopleSoft ChartFields" (Application Fundamentals)

Common Elements Used to Understand Standard Costing for Purchased Items

Field or Control	Description
Cost Element	A code used to categorize the different components of an item's cost and also to define the debit and credit ChartField combinations for accounting entries.
Reason Code	Categorizes why the adjustment occurred and can be used later for analysis. The reason type limits the selection to the appropriate reason codes for adjustments.
Source Code	Identifies an item as make, buy, floor stock, expense, or planning. This determines how the system uses the item for the Cost Rollup process and Update Production process (CEREVAL, SFPREVAL, CES5001).
Std UOM (standard unit of measure)	Establish the standard UOM for this item on the Item Definition - General: Common page.

Calculating Standard Costs Using Cost Rollup Process

For purchased items, you can have the system calculate the frozen standard cost using the Cost Rollup process. This process includes one material cost per item and any other additional landed costs. Cost rollups for purchased items do not include any lower level costs, bill of materials, or item routings.

The Cost Rollup process can calculate the costs for purchased items. These new costs are temporarily stored in the CE_ITEMCOST table where you can review them using several PeopleSoft inquiry pages. If you discover that the new costs are incorrect, then you can change the data and then run the Cost Rollup process again. Once you are satisfied with the results, run the Update Production process (Cost Update/Revalue process page) to freeze and move the new standard costs into the CM_PRODCOST table as the new frozen standard costs. The Update Production process also revalues the current inventory for costing future inventory transactions.

This diagram illustrates the cost rollup for purchased items. Based on the cost type and cost version, the Cost Rollup process determines one material cost per item and any additional landed costs:

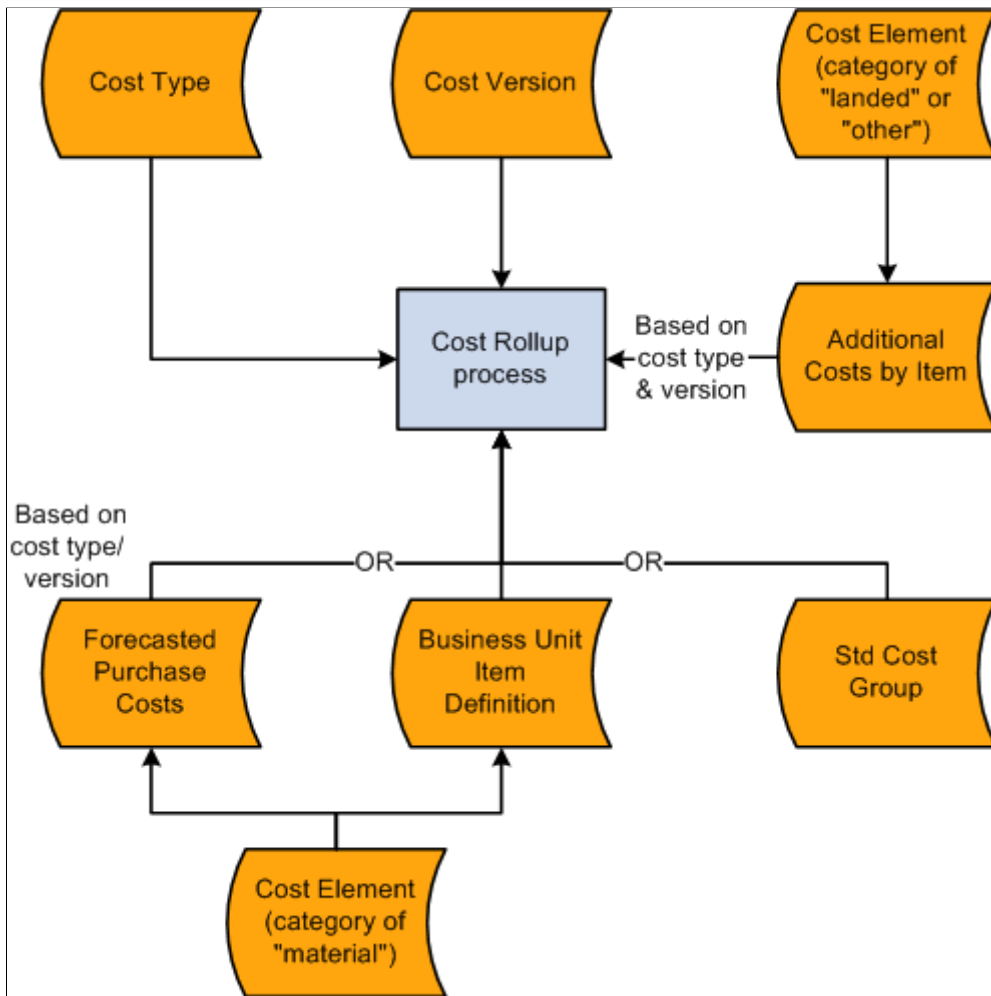

To calculate standard costs for purchased items:

1. Define the standard cost structure using the topic: "Structuring Your Cost Management System."
2. Define cost versions.
3. (Optional) Create standard cost groups.
4. (Optional) Use forecasts for material costs.
5. Add landed and miscellaneous costs using the Additional Item Costs page.
6. Calculate costs using the Cost Rollup process.

Pages Used to Calculate Standard Costs Using Cost Rollup

<i>Page Name</i>	<i>Definition Name</i>	<i>Usage</i>
Cost Versions Page	CE_VERSION	Create different versions for a cost type to maintain a history of the different costs calculated for each cost type. You can base these cost versions on different sets of assumptions, such as different effective dates or different budgets.
Cost Groups Page	CM_COSTGROUP	Cost groups (also known as standard cost groups) enable you to group together a set of items for cost rollup and update, comparing costs and reporting inventory value.
Forecasted Purchase Costs Page	CE_FCST	Use negotiated prices for the items as the basis for the standard costs.
Additional Item Costs Page	CE_ITEMEXP	Add other costs to the cost rollup of the items. Examples of additional costs are landed costs such as, duty, freight, inspection, procurement expenses, and material handling.
Cost Rollup Page	CE_ROLLUP_REQ	Run this process to calculate the standard cost for the items.

Related Links

[Cost Types Page](#)

[Cost Versions Page](#)

Cost Versions Page

Use the Cost Versions page (CE_VERSION) to create different versions for a cost type to maintain a history of the different costs calculated for each cost type.

You can base these cost versions on different sets of assumptions, such as different effective dates or different budgets.

Navigation:

Cost Accounting > Item Costs > Define Rates and Costs > Cost Versions

This example illustrates the fields and controls on the Cost Versions page. You can find definitions for the fields and controls later on this page.

Cost Versions

Unit US001

Costs by Type and Version Personalize | Find | View All | | First 1-2 of 2 Last

*Cost Version	*Cost Type	*Version Type	Description	Date Added	*Status		
REV1	CUR	Production	Initial Std Cost Load	02/20/2013	Approved		
REV1	CUR	Production	New Std Costs	02/20/2013	Pending		

Use this page to define the different cost versions for a cost type. You can create unlimited cost versions for any cost type. By using different versions for a cost type, you can maintain a history of the different costs calculated for each cost type. You can base these cost versions on different sets of assumptions, such as different effective dates or different budgets.

Field or Control	Description
Version Type	For purchased items, set this value to <i>Production</i> .
Status	Each cost version must have a status of <i>Pending</i> , <i>Denied</i> or <i>Approved</i> . You can only update the standard costs in the live environment when the status is <i>Approved</i> .

Cost Groups Page

Use the Cost Groups page (CM_COSTGROUP) to cost groups (also known as standard cost groups) enable you to group together a set of items for cost rollup and update, comparing costs and reporting inventory value.

Navigation:

Set Up Financials/Supply Chain > Product Related > Cost Accounting > Standard Cost Groups > Cost Groups

This example illustrates the fields and controls on the Standard Cost Groups page. You can find definitions for the fields and controls later on this page.

Standard Cost Groups

SetID SHARE CORPORATE SETID

Cost Groups			Personalize	Find	View All	First	1-6 of 9	Last
*Standard Cost Group	Description	Short Description						
BRD	Boards	Boards						+ -
CPITEM	Configured Items	CP Items						+ -
DTOP	Desktop Computers	Desktop						+ -
HOU	Housings	Housings						+ -
IC	Integrated Circuits	ICs						+ -
NBOOK	Notebook Computers	Notebook						+ -

Standard cost groups enable you to group together a set of items for cost roll up and update, comparing costs and reporting inventory value. Add items to the cost group by entering the standard cost group on the item's Define Business Unit Item - General: Common page. Then, enter a standard cost group on the Cost Rollup page or the Cost Update/Revalue page instead of defining a range of item IDs.

Forecasted Purchase Costs Page

Use the Forecasted Purchase Costs page (CE_FCST) to use negotiated prices for the items as the basis for the standard costs.

Navigation:

Cost Accounting > Item Costs > Define Rates and Costs > Forecasted Purchase Costs > Forecasted Purchase Cost

This example illustrates the fields and controls on the Forecasted Purchase Cost page. You can find definitions for the fields and controls later on this page.

Forecasted Purchase Costs

Unit US008

Item ID LT5000 Std UOM EA Source Code Make

Standard Wheel Subassembly

Costs by Type and Version							Personalize	Find	View All	First	1-2 of 2	Last
*Cost Type	Description	*Cost Version	Description	Version Type	Amount	*Cost Element						
CUR	Cur Costs	REV1	Initial Std Cost Load	Prdn	100.0000	100						+ -
					0.0000							+ -

Use the Forecasted Purchase Costs page to use a negotiated price as the material cost of the item in the Cost Rollup process. This enables you to use forecasted prices as a basis for the cost. The amount that

you entered should be the material cost of the item only, exclusive of any freight, duty, landed costs, or procurement expenses. The cost element that you selected must have a cost category of *Material* assigned on the Cost Elements page.

Note: Be sure that the cost type that you select designates *Forecasted* purchase costs as the purchase cost. If you use forecasted purchase costs, define a cost for every purchased item.

Related Links

[Cost Types Page](#)

Additional Item Costs Page

Use the Additional Item Costs page (CE_ITEMEXP) to add other costs to the cost rollout of the items.

Examples of additional costs are landed costs such as, duty, freight, inspection, procurement expenses, and material handling.

Navigation:

Cost Accounting > Item Costs > Define Rates and Costs > Additional Item Costs > Additional Costs by Item

This example illustrates the fields and controls on the Additional Item Costs page. You can find definitions for the fields and controls later on this page.

Additional Item Costs

Business Unit US008
 Item ID LT5000 Std UOM EA Source Code Make
 Standard Wheel Subassembly

Costs by Type and Version Find | View All First 1 of 1 Last

*Cost Type CUR Current Costs
 *Cost Version REV1 Initial Std Cost Load Version Type Production

Additional Cost Details Find | View All First 1 of 1 Last

Exp Sequence No. 10 Descr FS Material Cost

*Application Method Amount Per Unit

Expense Rate 0.0000

*Transaction Group 020 Putaway

*Cost Element 200

Landed costs and other miscellaneous costs can be added into the standard cost of an item by using the Additional Item Costs page. You define these additional costs (one cost at a time) for each cost type or cost version combination.

When you use this page to add landed cost components to an item, you can track and analyze the total landed cost for that item. You can set up consigned items as landed cost items; if you do, the system transacts all accrued landed cost charges when the consigned item is consumed. No variances is

computed for landed costs applied using this page. See the topic, "Structuring Landed Costs" for further information.

See [Understanding Landed Costs](#).

The **Exp Sequence No** (expense sequence number) determines the order in which the system applies costs; it is especially critical when it applies the rate to the total cost. For a purchased item, the total cost base includes material and any additional cost previously applied to that point.

Define how the system calculates the additional cost. **Application Method** values include:

Field or Control	Description
<i>% of Materials Cost</i> (percentage of material cost)	Multiplies the percentage specified by the item's material cost.
<i>% of Total Costs</i> (percentage of total costs)	Includes material costs plus any previously calculated additional costs as the total cost basis. For example, suppose that the item's material cost is 1.00 and you define an additional cost for sequence 10 as 50 percent of material cost, and sequence 20 as 100 percent of total cost, then the basis for applying additional costs for sequence 20 is 1.50 (1.00 of material cost plus 50 percent of 1).
<i>Amount Per Unit</i>	This amount is added to the cost of each unit of the item.

The **Transaction Group** defines the point at which you apply the additional costs into inventory. Select *Stocking* to include these costs in the standard cost calculations.

Note: If you have already run the Cost Update/Revalue process (RUN_CES5001) for the item specified, then you cannot change the transaction group selection.

Enter a cost element for each additional cost. The cost element that you entered must have a cost category of *Landed* or *Other* entered on the Cost Elements page.

Related Links

[Cost Elements Page](#)

Cost Rollup Page

To calculate the standard cost of an item, use the Cost Rollup (CE_COST_ROLLUP) component.

Use the Cost Rollup page (CE_ROLLUP_REQ) to run this process to calculate the standard cost for the items.

Navigation:

Cost Accounting > Item Costs > Update Costs > Cost Rollup > Cost Rollup

This example illustrates the fields and controls on the Cost Rollup page. You can find definitions for the fields and controls later on this page.

Use the Cost Rollup page to perform a cost rollup for a single item, a range of items, or a group of items within a business unit, cost type, or cost version combination.

Field or Control	Description
Cost Type and Cost Version	Select the combination that you want to calculate. The cost type and version determine which set of material and additional landed costs PeopleSoft Cost Management uses in the cost calculation.
Version Type	Displays the version type. The Version Type must be <i>Prdn</i> (production) in order for the calculated cost to be used as the system's standard costs. Version type is determined on the Cost Versions page.
Use Current Cost When No Price	Select to insure that all items have a material cost. If the method of calculating the material cost results in zero or a nonexistent price, then zero is replaced with the current purchase cost on the Define Business Unit Item - General: Common page.
BOM Code	Not applicable for purchased items.
Routing Code	Not applicable for purchased items.
Recalc Costs at Lower Level	Not applicable for purchased items.
Recalc Config Items & Levels	Not applicable for purchased items.

Related Links

[Cost Types Page](#)

[Cost Versions Page](#)

Reviewing Standard Cost Calculations

Before updating the production records with the new costs calculated by the Cost Rollup process, you can review the new cost using several inquiry pages, including:

- Costs by Cost Version.
- Items Without Cost by Version.
- Cost Rollup Audit.
- Message Log - Search.

Pages Used to Review Standard Cost Calculations

<i>Page Name</i>	<i>Definition Name</i>	<i>Usage</i>
Costs by Cost Version Page	CE_ITEMCOST	Displays item costs by type and version.
Cost Element Details Page	CE_ITEMCOST_DET	Displays the detailed costs maintained by component ID.
Items without Cost by Version Page	CE_NOCSTVER_INQ	Displays all items that have no cost calculated. Use after running the Cost Rollup process to verify new costs were created for the cost type and version.
Cost Rollup Audit Page	CE_ROLLUP_STAT	Use to determine what items were not costed for a specific Cost Rollup process and to view the related error message text.
Message Log-Search Page	MESSAGE_LOG	Review the status of any background process and view messages for any errors that occurred during the Cost Rollup or Update Production processes (Cost Update/Revalue process page).

Updating the Standard Costs and Inventory Values

Once you have reviewed the calculated costs for the items, you can move them into the production cost record using the Update Production process (Cost Update/Revalue process page). For a purchased item, this process performs these operations:

- Adds a new effective-dated entry to the production cost record.

The costs added are the new standard costs associated with the cost type and version that you select.

- Calculates the revaluation of inventory value for all items in stock.

You may want to run the Update Production process (Cost Update/Revalue process page) in report only mode. This enables you to determine the effects of proposed changes to inventory value.

Revaluing Inventory

Revaluing inventory is the process of updating an item's cost and accounting for the change in inventory value due to the change in frozen standard cost for the item. The process involves calculating the difference in inventory value, recording the difference, and updating the standard costs for the items. Once the system records the updated information, it can be posted to the general ledger through the normal transaction accounting cycle. Because the system bases the revaluation on a snapshot of the inventory, you want to ensure that the inventory value is as correct and accurate as possible to reflect the correct financial picture.

Prior to running the Update Production process (Cost Update/Revalue process page) to revalue inventory, you must:

1. Put away all pending inventory in the appropriate storage areas using the Complete Putaway process (INPPPTWY).

This includes all items received from vendors that require inspection, as well as any receipts from another inventory business unit. This ensures that the system can account for all inventory and can calculate and post the correct revaluation amount.

2. Run the complete Deplete On Hand Qty process (IN_FUL_DPL) to ensure that the item's quantities at the business unit level match the item's quantities at the location level.

You must issue all staged items in order for the system to complete the update for the quantity on hand.

3. Run the Transaction Costing process (CM_COSTING) within the Cost Accounting Creation process to ensure that all transactions already created throughout the PeopleSoft applications have been costed.

The transactions do not need to be posted.

4. Prohibit material movement for the business unit by selecting the **Prohibit Material Movements** check box on the Inventory Definition - Business Unit Definition page.

No inventory transactions should take place while the Update Production process (Cost Update/Revalue process page) is revaluing inventory. When it updates the standard costs, the system multiplies the change in standard cost by the quantity on hand for the item in each storage area. By prohibiting material movement, you ensure that the quantity on hand is accurate.

5. Check the Process Monitor to ensure that no one else in the organization is running the Update Production process (Cost Update/Revalue process page).

If you are updating all item costs within the business unit, you should not run two Update Production processes simultaneously.

Page Used to Update Standard Costs

Page Name	Definition Name	Usage
<u>Cost Update/Revalue Page</u>	RUN_CES5001	This process updates the standard costs and performs inventory revaluation.

Cost Update/Revalue Page

Use the Cost Update/Revalue page (RUN_CES5001) to this process updates the standard costs and performs inventory revaluation.

Navigation:

Cost Accounting > Item Costs > Update Costs > Cost Update/Revalue > Update Production

Select the business unit, cost type, and cost version with which you want to update the standard costs. The status for the cost type and version type appears and must be set to *Approved*.

The distribution type automatically changes to the distribution type associated with the inventory revaluation transaction group, but you can change it or you can leave it blank.

You have three options for running this process:

Field or Control	Description
Report Only - No Updates	Displays the impact of the standard change without actually updating the costs and posting revaluation entries. Running this process in report-only mode gives you a preview of the financial impact of the standards change without affecting the current transaction costing or inventory valuation.
Revalue Inventory and Report	Updates the standard production cost record and calculates the change in all inventory values. Running this report enables you to analyze a specific item should a question arise regarding the revaluation.
Revalue Inventory - No Report	Updates all records discussed in this section but does not print a report detailing the changes.

When reporting, you can also select to print a summary report only or to save variance results. When you choose to run the update in report-only mode and save the variance results, you can review the revaluation results by viewing the Compare Cost Updates or the Cost Updates by Tolerance pages.

Reviewing Standard Costs Applied to Your Environment

After updating the production records with the new standard costs calculated by the Cost Rollup process and applied by the Update Production process (Cost Update/Revalue process page), you can review the standard costs using several inquiry pages.

Pages Used to Review Applied Standard Costs

Page Name	Definition Name	Usage
Current Costs by Item Page	CM_PRODCOST_INQ	View the standard costs of items.
Prod'n/Standard Cost Detail Page	CM_PRODCOST_DET	Displays the detailed costs maintained by component ID.
Cost Update History Page	CE_REVALUE_VERS	Displays the history of cost updates for a business unit. Each time that you update the production costs, the system records the date and time of the update, as well as the cost type and version.
Items without Current Costs Page	CM_NOPRDNCST_INQ	Determine which items have been added to the business unit but have no costs in the standard production cost record.
Cost Updates by Tolerance Page	CE_ITEMCVAR_RPT2	Displays item cost variances outside a percentage tolerance. If you updated production costs, or ran the Update Production process (Cost Update/Revalue process page) in report-only mode, and elected to save the variance results, you can report those variances at any time.
Compare Cost Updates Page	CE_ITEMCVAR_RPT	Displays item cost variances. These variances occur when an item's costs are updated and the old cost differs from the new production costs. This information is visible only if you have actually updated production costs, or you elected to save variance information when you ran the update in report only mode.
Message Log-Search Page	MESSAGE_LOG	Review the status of any background process and view messages for any errors that occurred during the Cost Rollup or Update Production processes (Cost Update/Revalue process page).

Updating Standard Costs Manually

You can manually adjust standard costs by using the Item Production Costs page. You can only use this page to change the standard cost of items that have no activity.

Page Used to Maintain Standard Costs Without Cost Rollup

<i>Page Name</i>	<i>Definition Name</i>	<i>Usage</i>
<u>Production Costs Page</u>	CM_PRODCOST	Add the standard costs for items that are not defined as standard costed in any active business unit book.

Production Costs Page

Use the Item Production Costs page (CM_PRODCOST) to add the standard costs for items that are not defined as standard costed in any active business unit book.

Navigation:

Cost Accounting > Item Costs > Update Costs > Manual Cost Update > Item Production Costs

Use this page to manually add standard costs (material, inbound, or landed costs). The new standard costs are used for future transactions, including shipments from inventory stock (valued at the old standard costs). Use the Cost Rollup process to calculate new standard costs and update current inventory balances to the new standard.

To manually enter a standard cost for an item using this page, the item must be:

- A purchased item. Make items must use the Cost Rollup and Update Production processes to create the standard cost.
- Have no quantity currently in the inventory business unit.
- Not linked to any active standard cost books.

Item costs are effective-dated, and only one standard cost per item can be active within a business unit at any given time. Enter a valid cost element. Enter the amount associated with the cost element in the **This Level Cost** field.

Using Standard Costing for Makeable Items

Understanding Production Costs

The Cost Rollup process can calculate the costs for make or buy items within a manufacturing or distribution environment. These new costs are temporarily stored in the CE_ITEMCOST and CE_ITEMCOST_DET tables where you can review them using several PeopleSoft inquiry pages. If you discover that the new standard costs are incorrect, then you can change the cost foundation, bill of materials (BOM), or routings and then run the Cost Rollup process again. Once you are satisfied with the results, run the Update Production job (CEREVAL) to move the new standard costs into the CM_PRODCOST table that the system uses to cost manufacturing and inventory transactions. The new frozen standard costs are used for future manufacturing, production variances, and valuing inventory. Both the Cost Rollup and Update Production processes accommodate yield by operation transactions by calculating yield loss costs at the operation sequence level, maintaining extended precision cost fields, and storing detailed cost rollup calculations.

For production IDs, completions are recorded at the last operation. Completed items from Work in Process (WIP) are putaway as finished goods. These putaways are posted to TRANSACTION_INV. Completions may also be directed into another production ID.

If the end item is standard cost, the system debits the standard costs to finished goods and credits WIP. This may leave a remainder in WIP if the standard is different than the cost in the production ID. This remainder is cleared from WIP as a variance. When production IDs are closed for accounting, the variances between standard and production costs are computed by the Production Close process and stored in the SF_VARIANCES record. These variance transactions account for the difference between the standard cost of the end items putaway into finished goods and the total costs of the components, plus conversion cost consumption. WIP is cleared either to finished goods or as a variance for all completed and closed production IDs.

This diagram illustrates setting up frozen standard costs for makeable items. The Cost Rollup process calculates the frozen standard costs and stores the costs in the temporary item cost tables for review. The Update Production process (Cost Update/Revalue process page) moves the new standard costs into the production tables used to cost manufacturing and inventory transactions:

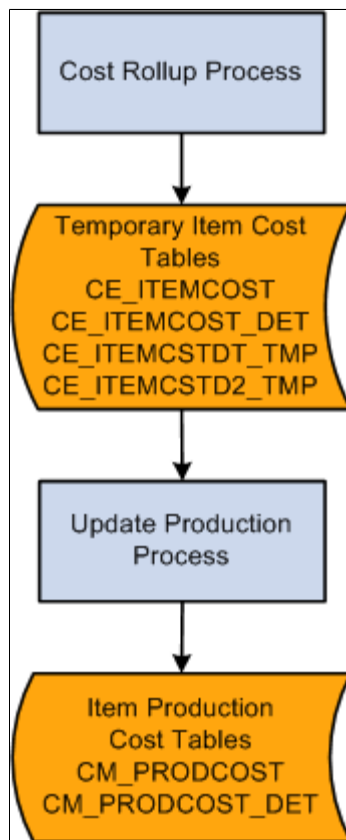

Once you have set the foundation for costing, you can calculate and update item costs. In a manufacturing environment, PeopleSoft Cost Management supports standard costing and enables you to easily perform cost simulations, standard cost updates, inventory, inspection, and WIP revaluations using a system that is well interfaced with other PeopleSoft Supply Chain Management applications.

Within a standard cost environment, you calculate the cost of makeable items based on the cost of purchased items, the makeable items product structure, and the list of tasks necessary to put the components together to form the subassembly or assembly.

Once you calculate and approve the item costs, you must put them into effect as the new frozen standard cost in production. Costs based on engineering bill of materials (EBOM) are calculated but are not used to update the standard cost for the item in production. When you have completed this process, PeopleSoft Cost Management revalues all inventories in the inspection, raw material, WIP, and finished goods storage areas at the new standard cost. Additionally, PeopleSoft Cost Management revalues any assemblies or subassemblies in process in production at the new standard. PeopleSoft Cost Management also records an accounting transaction to adjust the general ledger (GL) inventory balances.

You can maintain many standard costs for various production options and cost approaches, however, there is only one frozen standard cost per item that transcends all standard cost profiles and cost books for a business unit.

When production begins, PeopleSoft Cost Management tracks the cost of production, including any variances from the expected results. You have visibility into potential production variances before

production is completed, which gives you time to analyze potential problems before they are booked to the GL.

Related Links

[Understanding the Manufacturing Standard Cost Foundation](#)

Common Elements Used to Understand Production Costs

Field or Control	Description
Conversion Code	Define labor, machine, and other conversion costs in the manufacturing process. Use production conversion codes to define conversion rates associated with work centers or tasks. In the case of subcontracted tasks or operations, the rate should represent the cost of preparing and sending the item to the subcontractor for outside processing.
Conversion Overhead Code	Define the different types of overhead costs used in the manufacturing process. Use production overhead codes to define conversion overhead rates associated with work centers or tasks. You can specify up to four production overhead codes for the work center or task.
Cost Element	Categorize the components of an item's cost. When you perform a cost rollup, you maintain an item's cost by cost element. Cost elements also help define the debit and credit ChartField combinations in transaction processing.
Cost Type	Creates separate costing groupings with different methods of costing, such as current, revised, or forecasting. The cost type also defines how purchased components are calculated.
Cost Version	Once you have determined the cost types, you can use cost versions to determine how many iterations or versions of costs you want to calculate. By using different versions for a cost type, you can maintain a history of the different costs calculated for each cost type. You can base these cost versions on different sets of assumptions, such as different BOMs (manufacturing versus engineering), effective dates, different labor rates, or different budgets that determine the overhead expenses.
Lower Level Costs	Costs associated with the components used on the assembly.
Source Code	Identifies an item as <i>make</i> , <i>buy</i> , <i>floor stock</i> , <i>expense</i> , or <i>planning</i> . This determines how the system uses the item during the Cost Rollup and Update Production processes.
Standard Cost Group	Standard cost groups (also know as cost groups) enable you to group together a set of items for cost roll up and update, comparing costs and reporting inventory value.

Field or Control	Description
This Level Costs	Costs associated with manufacturing a specific assembly item.
Costing Conversion Overhead Rates	Establishes the rates to use for overhead costs based on the units produced, labor and machine hours, or labor and machine costs. The rates are based on business unit, cost type, cost version, conversion overhead code, and cost element. You can establish several different rates.
Costing Conversion Rates	Establishes the rates to use for labor and machine costs in the production process. You can enter fixed run, run, postproduction, and set up rates for both labor and machine. The rates are based on several factors including business unit, cost type, cost version, conversion code, and cost element. This structure gives you flexibility to set up and use several different rates.

Using the Cost Rollup Process to Calculate Product Costs

The Cost Rollup process calculates the standard cost for an item based on:

Field or Control	Description
Bill of Materials (BOM)	The BOM contains the component materials for the end item. These component material costs can be purchased components and subassemblies (both manufactured and subcontracted). The Cost Rollup process includes the cost of purchased items, the lower-level costs of manufactured subassemblies, and the cost of subcontracted assemblies. For configured items, the component list from the production order is used instead of the BOM.
Routing	(Optional) The routing contains information about the operations and work centers required for producing the item. Associated with the routings are the labor, machine, subcontracting, and overhead rates that the system uses for the cost rollup of a particular cost type and version. The Cost Rollup process uses the <i>costing</i> rate type for labor and machine setup, run, fixed run, and postproduction times or rates. For configured items, the system uses the operation list from the production order instead of the routing.

This diagram illustrates the calculation of the cost of manufactured items. The Cost Rollup process calculates the standard cost based on the BOM and routing of the item. The cost type and cost version combination determine the rates and additional costs used to calculate the cost:

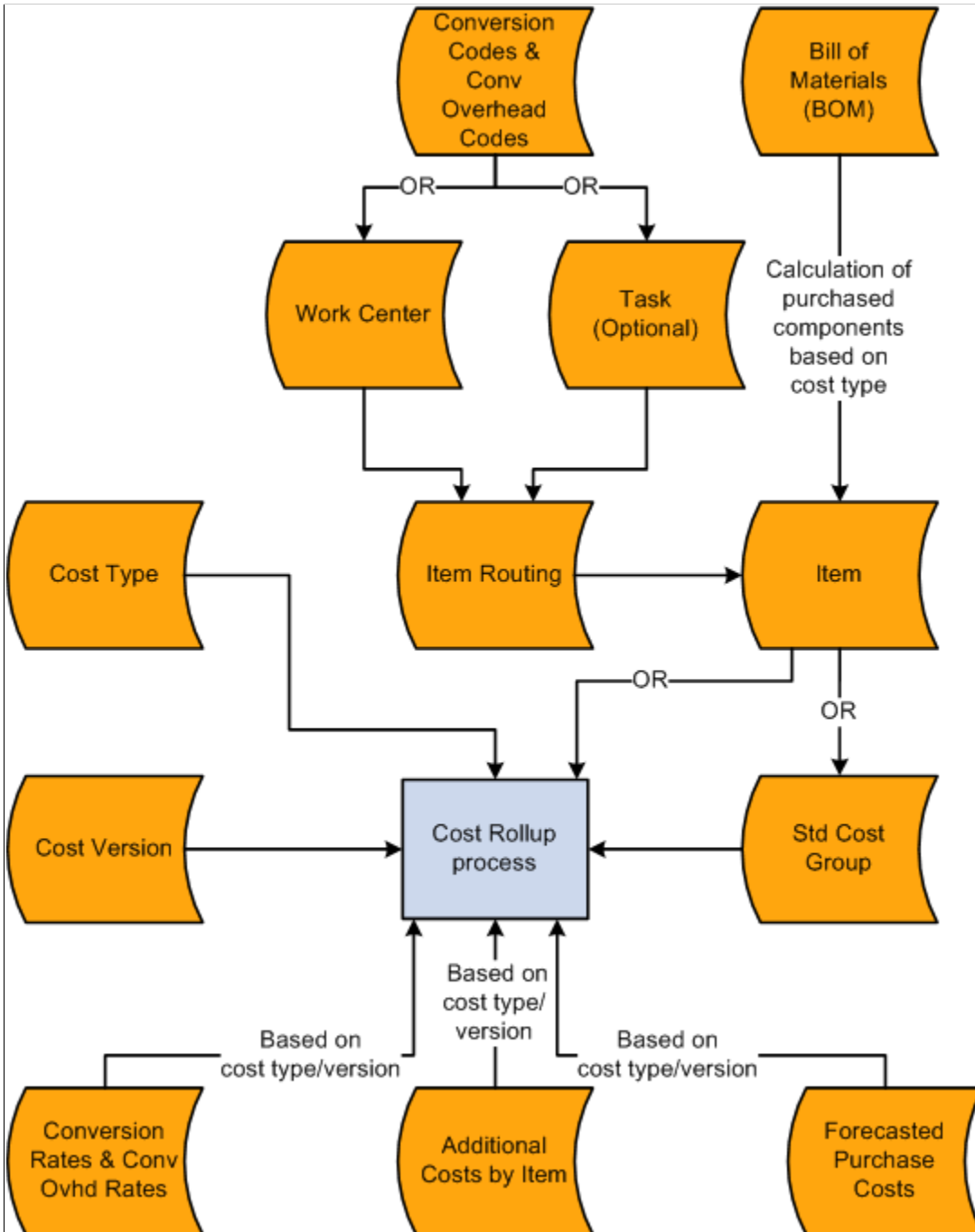

The Cost Rollup process uses several elements to compute the frozen standard costs, including:

Field or Control	Description
Cost Type	Define different cost types, such as current, revised, and forecasted costs, to create a working space for cost calculations. You perform cost rollups based on cost types. For example, you can set up a cost type of CUR for the current production costs.
Cost Version	Cost versions are a subset of cost types that enable you to have different versions or simulations of the costs. For example, for the cost type CUR (current production costs), you could have a current production version (PRD1) and an engineering version (ENG1) for cost calculations.
Cost Element	Cost elements categorize the different components of an item's cost, such as, material, labor, and machine costs. They are used on reports and inquiries of the rolled up costs of a manufactured item. They can also be used to post accounting entries for inventory transactions. You could create the cost elements, for example, 300 for recording labor setup costs, 301 for recording labor run, and 501 for overhead - machine based costs.
Production Conversion Codes	Production conversion codes define labor, machine, and other conversion costs in the manufacturing process. Use conversion codes to define conversion rates associated with work centers or tasks. For example, you could create the conversion code 4403 (painter) for conversion costs related to painting.
Production Overhead Codes (conversion overhead codes)	Production overhead codes define the different types of overhead costs that are used in the manufacturing process. Use conversion overhead codes to define conversion overhead rates associated with work centers or tasks. For example, you could create the production overhead codes of 6504 for depreciation and 6507 for electricity usage.
Costing Conversion Rates	Define the rates to use for labor and machine costs in the production process. You can create a variety of costing scenarios using different cost types, cost versions, and production conversion codes. For example, you can set the labor setup rate to 8 per hour for the CUR cost type, PRD1 cost version, 4403 (painter) conversion code, and store the results in the cost element 300 (labor setup). Then you can create a different labor run rate of 9 per hour for the CUR cost type, PRD1 cost version, 4403 (painter) conversion code, and store the results in the cost element 301 (labor setup).

Field or Control	Description
Costing Conversion Overhead Rates	<p>Establish the rates to use for overhead costs based on the units produced, labor or machine hours, or labor or machine costs. You can establish several different rates based on business unit, cost type, cost version, conversion overhead code, and cost element. For example, you can set up the depreciation costs as 5 /machine hour for the CUR cost type, PRD1 cost version, 6504 (depreciation) conversion overhead code, and store the results in the cost element 501 (overhead - machine based).</p>
Work Centers and Tasks	<p>Once you have set up the cost foundation, use the production conversion codes and the production overhead codes to define the labor and machine cost for the work centers or tasks. You can specify up to four production overhead codes for the work center or task. For example, for the work center, PAINT01, you can add the conversion code 4403 (painter) for conversion costs related to painting. You can also add the conversion overhead code of 6504 for depreciation on the paint machines.</p>
Item Routing	<p>You then define the item's routing to include these work centers and tasks within the operation sequences. The routing also defines the operation time for any operation sequence. For example, for the operation sequence 50, you could record that it takes 2 hours of labor setup, 4 hours of labor run, and 1 hour of machine time.</p>
Item	<p>The item definition for a manufactured item includes the item routing to be used and the BOMs. This information is recorded on the Define Business Unit Item - Manufacturing page. For example, for the item SR1001 (touring bike) this page defines where to get the item routing and BOM.</p>
Cost Rollup Process	<p>The Cost Rollup process uses the item routing, cost type, and cost version to determine the labor, machine, subcontracting, and overhead costs. For example, if the cost rollup process uses the cost type of CUR and the cost version of PRD1, with the item ID SR1001, then the conversion costs for the operation sequence 50 would be:</p> <ul style="list-style-type: none"> • Labor setup costs: 8 per hour * 2 hours = 16 categorized by cost element 300 and conversion code 4403. • Labor run costs: 9 per hour *4 hours = 36 categorized by cost element 301 and conversion code 4403. • Overhead costs: 5 per machine hour *1 hour = 5 for machine depreciation categorized by cost element 501 and conversion overhead code 6504. <p>The Cost Rollup process uses the item's BOM to calculate materials costs. Select the method for calculating the cost of purchased components on the Cost Type page. You can add additional costs to the Cost Rollup process using the Additional Item Costs page.</p>

The Cost Rollup process must calculate the cost at each level of the product structure, as well as the final cost. For example, if an item has a BOM or component list like the one in this diagram, the cost rollup must calculate the cost of item 2002 before it can calculate the cost of item 1001.

This diagram illustrates the cost rollup of a multi-level product structure:

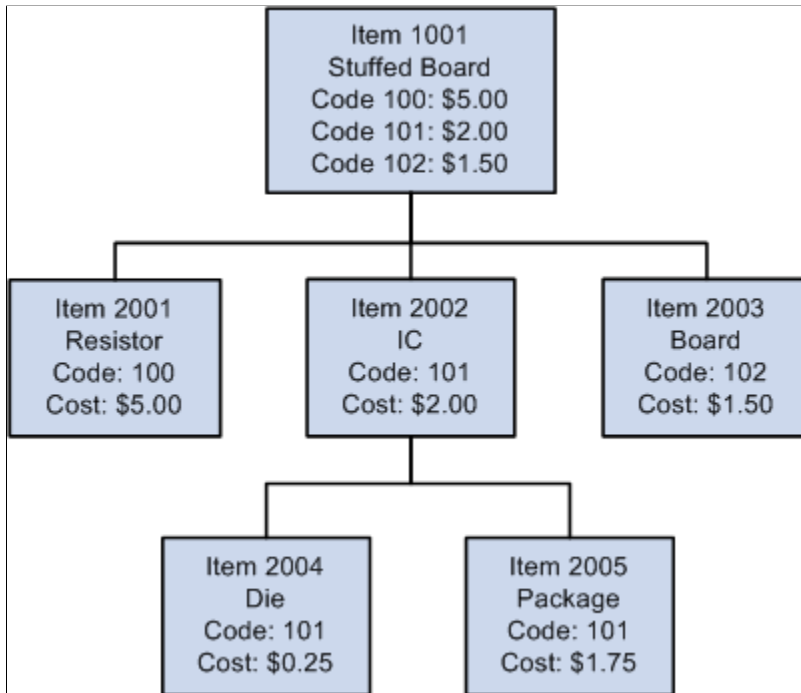

In this example, the costs associated with items 2004 and 2005 would be lower-level or component-level costs for item 2002. The cost of 2002, when you add it to items 2001 and 2003, becomes the lower-level or component costs for item 1001. The labor, machine, and overhead costs associated with manufacturing item 2002 are this-level or assembly-level costs for 2002. However, they would become lower-level or component-level costs when associated with item 1001. Item 1001 would have its own set of this-level or assembly-level costs, associated with putting items 2001, 2002, and 2003 together.

Related Links

"PeopleSoft Manufacturing" (PeopleSoft Manufacturing)

"Prerequisites" (PeopleSoft Manufacturing)

"Rounding Rules in Manufacturing" (PeopleSoft Manufacturing)

Understanding the Types of Cost Rollups

You can use the Cost Rollup process to determine the standard cost for makeable items, configured items, engineering items, purchased items, and simulations. Only cost rollups of manufactured, purchased, and configured items can be used to update production costs (the CM_PROD COST table). The system calculates engineering and simulation costs for reporting and comparison purposes.

The Cost Rollup process performs in basically the same way for the different types of items. The only difference is where the cost calculation obtains the information to determine the material and labor costs for the item.

Type of Item in Rollup	Material Costs From	Labor, Machine, Subcontracting, Overhead Costs From	Can Update Std Costs?
Manufactured	Primary manufacturing BOM code 1.	Primary production routing code 1 or the reference item routing, if one is specified for the item.	Yes
Configured	Component list.	Operation list.	Yes
Engineering	Any manufacturing BOM or engineering BOM. BOM code 1 is used for all lower levels.	Any production routing or engineering routing. Routing code 1 is used for all lower levels.	No
Simulation	Any manufacturing BOM code. BOM code 1 is used for all lower levels.	Any production routing. Routing code 1 is used for all lower levels.	No

Rolling Up Configured Items

There are two options for calculating standard cost for a configured item using the Cost Rollup process:

Field or Control	Description
Costing	The Cost Rollup process calculates the item's cost based on its BOM and routing. The standard cost is stored by item ID. One item could have multiple configuration codes but all configurations of the same item use the same standard cost.
Configuration Costing	The Cost Rollup process calculates the item's cost based on the component list and operation list from the latest production ID. The system stores the standard cost according to the combination of item ID and configuration code. Choose configuration costing by selecting the check box on the Define Item - Configuration page.

The roll up of a configured item using configuration costing does not include co-products, by-products, or yield by-operation details. However, the system maintains detailed costs for configured items according to component ID and operation sequence. It stores these detailed costs in the CE_ITEMCOST_DET and CM_PRODCOST_DET tables. It also summarizes these costs according to cost element and stores them in the CE_ITEMCOST and CM_PRODCOST tables.

Rolling Up Costs with Multiple Outputs

If the output of a production run is more than one item, then the cost is allocated. Multiple outputs include:

- Co-products.
- By-products.

Costing Co-Products

If a single manufacturing process generates multiple items, you can allocate the batch cost across the primary and co-products to determine the per unit cost of each end item. When it explodes a co-product for a multiple output BOM during Cost Rollup process, the system uses the Associated Primary BOM to determine the correct lower-level structure. An associated primary must therefore exist in this case for the rollup to occur. The BOM and routing code combination that the system used to explode the co-product must also exist.

Note: The system calculates a co-product's cost by multiplying the total cost of the batch (including the recycle and waste by-product costs) by the cost percentage for the co-product (as specified on the BOM Maintenance - Outputs page), then dividing by the expected output quantity of the co-product.

Costing By-Products

By-products can be of two types: recycle and waste. The system calculates cost relief for recycled by-products by multiplying the quantity and the cost of the recycle by-product. This cost relief is subtracted from the lower-level costs. The system treats recycled by-products as a negative cost, because they can be used as an input to another process. The cost used is determined by the purchase cost as specified for the cost type that you selected on the Cost Rollup page.

Note: A recycled by-product must have the same cost element (with a cost category of material) as another component or waste by-product; otherwise, the item is not costed. This reduces the chance of a material element producing a negative value. If the cost element becomes negative, due to a recycle by-product cost relief, the system does not cost the item and an error message is printed on the Cost Rollup Audit page.

The system treats waste by-products as positive or zero cost. They either add to the cost of the product, such as the cost of disposing it, or have no associated cost. The system determines the cost used for waste by-products by multiplying the quantity and the cost of the waste by-product. It adds this cost to the material costs.

This diagram illustrates an example of a cost rollup with multiple outputs.

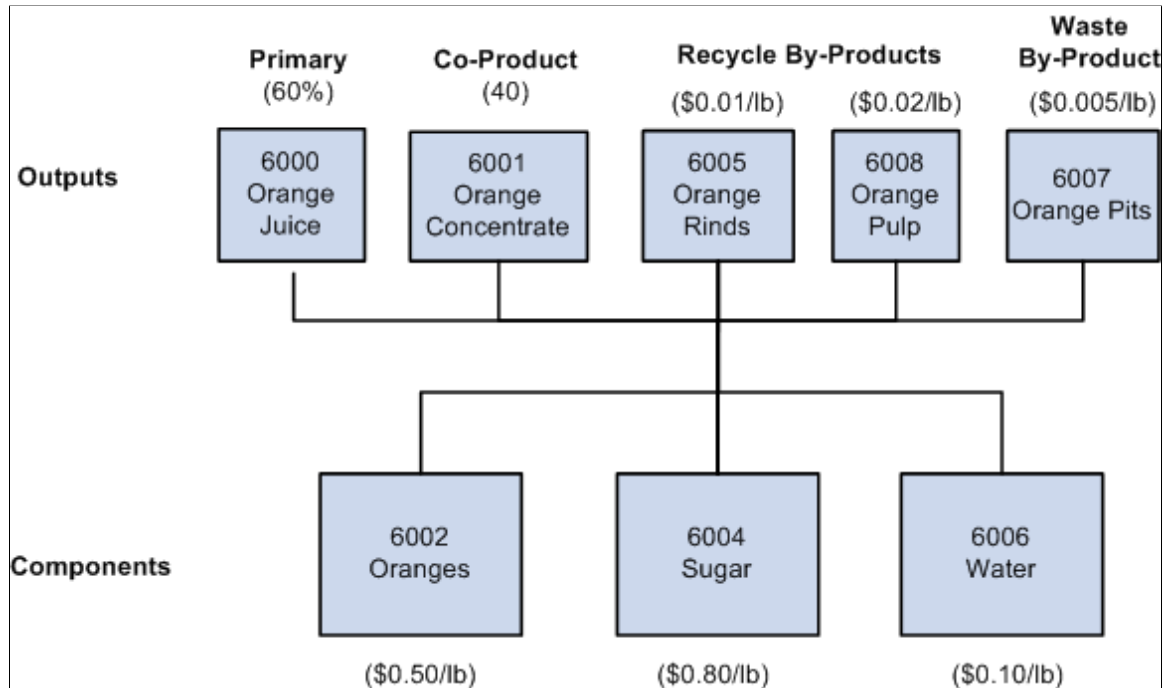

In this example for orange juice processing, you have these outputs: primary (orange juice), co-product (orange concentrate), recycle by-products (orange rinds and orange pulp), and waste by-product (orange pits). The components are oranges, sugar, and water.

Calculate the material costs by multiplying the quantity of each component by the standard cost:

$$\text{Oranges: } (5\text{lb} * 0.50) = 2.50$$

$$\text{Sugar: } (1\text{lb} * 0.80) = 0.80$$

$$\text{Water: } (10\text{Gal} * 0.10) = 1.00$$

$$\text{Total Material Costs} = 4.30$$

Calculate the by-product costs as:

Orange Rinds: $(2\text{lb} * 0.01) = -0.02$ (Cost is negative, because the recycled by-products are viewed as a cost benefit.)

$$\text{Orange Pulp: } (1\text{lb} * 0.02) = -0.02$$

$$\text{Orange Pits: } (2\text{lb} * 0.005) = 0.01 \text{ (Cost is positive, because it is a disposal cost.)}$$

$$\text{Total By-Product costs} = -0.03$$

$$\text{Total Costs} = \text{Material Costs} + \text{By-Products Costs} = 4.30 + (-0.03) = 4.27$$

To determine the primary and co-product costs, multiply the total costs by the cost percentage.

$$\text{Orange Concentrate} = 40\% * 4.27 = 1.71$$

$$\text{Orange Juice} = 4.27 - 1.71 - 2.56$$

Calculate the standard cost of the primary and co-product by dividing the apportioned costs by the output quantity of each item.

Related Links

"Understanding BOM Maintenance" (PeopleSoft Manufacturing)

Rolling Up Costs for Yield by Operation Items

For yield by operation transactions, the Cost Rollup process calculates the yield loss for each operation sequence where the operation yield is less than 100 percent.

The Cost Rollup process performs these steps to calculate yield by operation transactions:

1. Calculates and inserts costs into the temporary tables CE_ITMCSTDT_TMP and CE_ITMCSTD2_TMP by applying the operation yield at the operation sequence where they are first introduced.

Each subsequent operation sequence uses the results of the previous operation sequence. Subsequent costs take the form $(\text{cost (from original OpSeq)} / \text{operation yield percent}) - \text{cost from original OpSeq}$.

All components with an invalid or zero operation sequence are applied to the first operation sequence that you defined for the routing code specified. All by-products with an invalid or zero operation sequence are applied to the last operation sequence for the routing code. For by-products, the process uses the operation yield of this last operation sequence.

This example demonstrates how subsequent costs are created as existing costs from earlier OpSeqs move through subsequent OpSeqs where Operation Yield < 100 percent.

- a. The first operation sequence (OpSeq 10) has an operation yield of 100 percent. The cost is 10. Processing begins at the second OpSeq, because the first OpSeq processing is already complete.
 - b. The second operation sequence (OpSeq 20) has an operation yield of 96 percent. Using the formula $(\text{Cost (from original OpSeq)} / \text{Operation Yield Percent}) - \text{Cost (from original OpSeq)}$, then the additional cost for the cost originally introduced in OpSeq 10 would be $10/96\% - 10 = 10.4167 - 10 = 0.4167$.
 - c. The third operation sequence (OpSeq 30) has an operation yield of 98 percent. The additional cost for the cost originally introduced in OpSeq 10 would be $((10/96\%)/98\%) - 10/96\% = (10.6293 - 10.4167) = 0.2126$.
 - d. Therefore, the total cost is $10 + 0.4167 + 0.2126 = 10.6293$ (which is the same as $10 * \text{expected completions at OpSeq 30} = 10 / (.96 * .98) = 10.6293$).
2. Once the system processes all the specified operation sequences, it moves the cost data into the CE_ITEMCOST_DET table.

Performing a Cost Rollup

You can calculate the cost of makeable items by running the Cost Rollup process.

To calculate product costs:

1. Verify the cost foundation has been defined for the items. See the topics, "Structuring Your Cost Management System" and "Defining the Cost Foundation for Makeable Items."

See [Understanding Cost Structure](#).

See [Understanding the Manufacturing Standard Cost Foundation](#).

2. Check the item default values, including the source code, standard cost group (optional), and cost element in the Define Business Unit Item component.
3. Confirm that the items have a BOM.

If you are rolling up the costs to a configured item, verify that you have a component list on the production ID.

4. (Optional) Confirm that the items have an item routing.

If you are rolling up the costs to a configured item, verify that you have an operation list on the production ID.

5. Use the Cost Rollup page to run a cost rollup and calculate the new standard cost for the items.

Pages Used to Perform the Cost Rollup Process

<i>Page Name</i>	<i>Definition Name</i>	<i>Usage</i>
Define Business Unit Item - Manufacturing	MFG_ATTRIB	Select the source code for each item. The source code determines whether or not an item is included in the Cost Rollup process.
Define Business Unit Item - General	GEN_ATTRIB_INV	Enter the cost element for each item. The Cost Rollup process and Update Production process use cost elements to categorize the components of an item's cost. For purchased items that are components of a manufactured item, enter the current purchase cost. This insures that a default price is available for cost rollup.
Manufacturing BOMs - Summary	EN_BOM_MAINT	Verify that a BOM exists for the makeable items.
Define Routings - Summary	EN_RTG_SUMMARY	Verify that a routing exists for the makeable items.

Page Name	Definition Name	Usage
<u>Cost Rollup Page</u>	CE_ROLLUP_REQ	Run this process to calculate the standard cost for makeable items. Based on the cost type and version, you can rollup any combination of BOM and routing for production, configured, engineering, simulations. The process calculates the cost of co-products and by-products.

Related Links

"Understanding BOM Maintenance" (PeopleSoft Manufacturing)

"Understanding Routings" (PeopleSoft Manufacturing)

[Understanding the Manufacturing Standard Cost Foundation](#)

Defining Item Default Values

These default values influence the Cost Rollup process.

Source Codes

The item's source code determines how the item is used for the Cost Rollup and Update Production processes. Define each item's source code on the Define Business Unit Item - Manufacturing page. The options are:

Field or Control	Description
Buy	This is a purchased item. No lower-level costs are calculated; therefore, any BOM or routings attached to this item are not used in cost calculations.
Expense	This item is expensed when received in an inventory business unit. The cost of this item is never included in the Cost Rollup and Update Production processes. You can specify the item on a BOM to call out the material requirement, but the cost is not included in the standard cost rollup.
Floor Stock	This item is expensed when issued to production. The cost of this item is never included in the Cost Rollup and Update Production processes. You can specify the item on a BOM to call out the material requirement, but the cost is not included in the standard cost rollup.

Field or Control	Description
Make	This is a manufactured (makeable) item. The Cost Rollup and Update Production processes calculate and post new frozen standard costs for this item. Makeable items are assemblies or subassemblies that are manufactured in house, purchased from a subcontractor, or by a combination of both.
Planning	This is an item used only in PeopleSoft Supply Planning. The item is never included in the Cost Rollup and Update Production processes.

Routing

On the Define Business Unit Item - Manufacturing page, specify which production routing the item uses when the system determines the assembly item's this level labor, material, and overhead costs.

Average Order Quantity

The item's average order quantity indicates the typical batch or lot size that you use to produce this item. Define each item's average order quantity on the Define Business Unit Item - Manufacturing page. This is the quantity that you expect to produce in one production ID or production schedule based on the BOM.

If a BOM quantity on a bill is greater than 1, the component's per order quantity is spread over the BOM quantity. For example, Assembly A has a BOM quantity of 100; Component B used on A has a per order quantity (QPA, or quantity per assembly) of 1500. Therefore, the use of B for a single A is 15 (1500/100). When entering the QPA, the BOM maintenance supports a precision of 4 places to the right of the decimal. You have the option to define the calculated QPA precision that the system maintains when it determines the item's cost. On the Installation Options - Manufacturing page, you select a precision anywhere from 4 to 10 places to the right of the decimal. If the BOM and associated process results in multiple outputs (primary, co-products, and by-products), the BOM quantity must be set to the item's average order quantity.

If you use economic order quantities or average order quantities with setup, fixed run, and postproduction times, the system must prorate the cost of these processes over the order quantity to determine a per unit cost. The system determines per unit setup, fixed run, and postproduction cost by dividing the cost of each process by the average order quantity. Typically, the system calculates this at the operation level, then sums it to provide the total cost.

Standard Cost Groups

(Optional) You can use cost groups to select a set of items to process for the Cost Rollup process and the Update Production process (Cost Update/Revalue process page). Enter the group in the **Standard Cost Group** field on the Define Business Unit Item - General page.

Cost Elements

The Cost Rollup process and Update Production process (Cost Update/Revalue process page) use cost elements to categorize the components of an item's cost. Cost elements are also used when costing

a transaction. Enter the cost element for the item's material costs on the Define Business Unit Item - General page. For both purchased and makeable items, enter a cost element in the material cost category.

Used in Manufacturing Check Box

You must identify any items that are used in PeopleSoft Manufacturing. Select the **Used in Manufacturing** check box on the Item Business Unit Definition - General: Costing page for any item that:

- Has a BOM or routing.
- Is a component on a BOM or component list.
- Is associated with a production area.
- Is used on a production ID or production schedule.

Related Links

"Prerequisites" (PeopleSoft Manufacturing)

"Define Business Unit Item - General: Common Page" (PeopleSoft Managing Items)

Using the BOMs

The manufacturing bill, engineering bill, or component list determines the structure of the item and therefore the associated lower-level costs.

PeopleSoft Cost Management uses BOM yield or component yield loss to account for the loss of components during the manufacturing process. For costing purposes, the cost of the assembly item can, therefore, take into account the expected loss of components in production. In this instance, the system inflates the cost of the component by the component's yield.

Cost rollups do not include the cost of floor stock, expensed, subcontract supplied, or non-owned items. Consigned items are included in the item's cost as they are considered owned upon consumption.

If you roll up an assembly item that has no owned components, only non-owned and parts supplied by a subcontractor (Subsupply flag is set to Yes), the cost rollup does not calculate any lower-level material costs but still rolls up labor costs for that item.

Related Links

"Understanding BOM Maintenance" (PeopleSoft Manufacturing)

"Understanding Component Lists" (PeopleSoft Manufacturing)

Using Item Routings

The production routing, engineering routing, or operation list documents the operations that are necessary to assemble the item. In the Cost Rollup process, the system considers only the routings or operation lists of those items whose source code you have defined as *Make*.

When calculating conversion costs for an operation, you must consider the crew size of the operation. For example, if the crew assigned to a work center consists of three people, multiply the labor run cost by three.

As it does with crew size, the system multiplies the machine cost of an operation by the number of machines assigned to the work center in which the operation takes place.

When the conversion rate associated with the code assigned to the operation is expressed in terms of a cost per unit, as opposed to a labor or machine rate per hour, you must specify the corresponding costing time type on the routing or operation list in order for the system to include the cost. For example, suppose that you specified a labor run cost of 1.00 per unit in the conversion code associated with the operation. There must be a costing labor run time in the routing or operation list in order for the system to include that 1.00 in the item's cost.

When you specify an operation's costing times and run rates in terms of days, the system factors the rate by the work center's average daily capacity to determine the total number of hours it requires to complete the operation.

Related Links

"Understanding Routings" (PeopleSoft Manufacturing)

"Understanding Operation Lists" (PeopleSoft Manufacturing)

Cost Rollup Page

Use the Cost Rollup page (CE_ROLLUP_REQ) to run this process to calculate the standard cost for makeable items.

Based on the cost type and version, you can rollup any combination of BOM and routing for production, configured, engineering, simulations. The process calculates the cost of co-products and by-products.

Navigation:

Cost Accounting > Item Costs > Update Costs > Cost Rollup > Cost Rollup

This example illustrates the fields and controls on the Cost Rollup page. You can find definitions for the fields and controls later on this page.

Use the Cost Rollup page to perform a cost rollup for a single item, a range of items, a group of items, or all items for any BOM and routing combination within a business unit, as well as for any cost type and cost version.

When rolling up one or all items, consider these points:

- When rolling up all items, the system determines the costs of all outputs and all lower level buy items.
- If rolling up a single item and the single item specified is a primary item on the BOM code selected, it is costed and updated along with any co-products whose associated primary BOM item is the primary product selected.
- You can select a co-product as the single item to roll up.

In this instance, the system determines the BOM on which the co-product is made by looking at the co-product's associated primary BOM. Using this BOM, the co-product's cost is calculated. However, the Primary Product's cost is not calculated nor updated.

- The details for yield by operation transactions are captured by calculating yield loss costs at the operation-sequence level, maintaining extended precision cost fields, and storing detailed cost rollup calculations

Field or Control	Description
Cost Type and Cost Version	Select the combination that you want to calculate. The cost type and version determine the set of labor, machine, and overhead rates or costs, plus the purchase costs and additional costs PeopleSoft Cost Management uses in the cost calculation.
Version Type	On the Cost Versions page, you select a version type. The version type that you select has a direct impact on the Cost Rollup page. If the version type is <i>Prdn</i> (production), the system changes to the primary BOM and Routing Codes for all levels and the BOM Code and Routing Code fields appear. If the version type is <i>Eng</i> (engineering) or <i>Sim</i> (simulation), then select any combination of BOM and routing codes and the system rolls up the cost for reporting and comparison only.
As of Date	Determines which of the assembly's components to include on the item's bill when the system calculates the item's material and lower-level costs. The rollup includes any component that is effective on the bill as of the date specified. The as of date also refers, in a multiple output scenario, to by-product effectivity dates. Configured items do not use the as of date but use the components that are on the component list.
Use Current Cost When No Price	Select to ensure that all purchased items have a cost. If the method of calculating the cost of purchased items results in zero or a nonexistent price, then zero is replaced with the current purchase price.

Field or Control	Description
Recalc Costs at Lower Level (recalculate costs at lower level)	<p>Select to recalculate all lower-level costs of any subassemblies. This recalculated cost is rolled up into the standard cost of the manufactured item. If you do not select this check box, then the Cost Rollup process uses the current cost for the lower level items based on the cost type and cost version combination.</p> <p>If a lower level subassembly is included in the list of items to be rolled up, then the lower level subassembly's new value is used even though this check box has not been selected.</p>
Recalc Config Items & Levels (recalculate configured items and levels)	<p>If PeopleSoft Product Configurator is installed, select to rollup costs for configured items that use configured costing. If multiple production IDs, and therefore, multiple component and operation lists exist for the same item ID and configuration code combination, then the system uses the latest production ID to determine the cost.</p>

These errors can occur during the Cost Rollup process. Use the Cost Rollup Audit page to check for these errors:

- An invalid BOM code or routing code exists.
 - A co-product is to be rolled up, but a BOM or routing code does not exist for the primary product.
- For example, suppose that you try to roll up a co-product with BOM code 2 and routing code 2. However, if its associated primary item does not have a BOM and routing code combination of 2, 2, then an error occurs and the rollup does not take place.
- The cost element for a recycle by-product does not exist on the Define Business Unit Item component.
 - No BOM exists for a *Make* item.
 - A cost type's Purchase Cost Used is Forecasted or Last Price, and you did not enter a forecast price or last price paid for a buy item.

An error occurs and the rollup does not take place.

Related Links

[Understanding the Manufacturing Standard Cost Foundation](#)

[Cost Versions Page](#)

Reviewing Calculated Costs

Before updating the production records with the new costs calculated by the Cost Rollup process, you can review the new cost using several inquiry pages.

This section discusses how to review BOM costs for manufacturing and engineering.

Pages Used to Review Calculated Costs

Page Name	Definition Name	Usage
Costs by Cost Version Page	CE_ITEMCOST	Displays item costs by type and version.
Cost Element Details Page	CE_ITEMCOST_DET	Displays the detailed costs maintained by component ID and operation sequence.
Items without Cost by Version Page	CE_NOCSTVER_INQ	Displays all items that do not have a calculated cost. Use after running the Cost Rollup process to verify that new standard costs were created for the cost type and version.
Cost Rollup Audit Page	CE_ROLLUP_STAT	Use to determine what items were not costed for a specific Cost Rollup process and to view the related error message text.
<u>Costed BOM Page</u>	EN_BOM_INQ_COSTED	Displays component costs based on the item's manufacturing BOM or engineering BOM. You must run the Cost Rollup process for the BOM code and routing code combination to display the costs on this page.
Output Costs Page	EN_BOMCOST_OUT_SP	Displays the costs details for the output items from this BOM. This inquiry compares previously rolled up costs for a cost type and cost version (the Cost Version Item Cost column) to the current cost of assembly (the Inquiry Item Cost column) to determine the costing impact of BOM changes to an assembly.
Detailed Item Costs Page	EN_ITEMCOST_OUT_SP	Displays the detailed item costs by cost element for the output item, including materials, labor, machine, and overhead costs.
Component Detailed Costs Page	EN_ITEMCOST_SP	Displays the detailed item costs by cost element for the component item.
Output List Page	EN_BOM_LIST_OUT_SP	Lists products from this BOM including primary and co-products. Displays details about each product including resource percentage and cost percentage.

Page Name	Definition Name	Usage
Review Costed Routings - Operations Page Review Costed Eng Routings - Operations Page	CE_COST_INQ_SUM	Displays costs by item routing, including conversion and overheard conversion costs attached to the item routing by task or work center. Material costs can also appear if you enter a BOM code. Enter unit, item ID, cost type, cost version, routing code, and BOM code (optional). Select the Cost as Batch check box to view the costs and quantities for the entire batch instead of a single unit of the item. Then click the Search button to retrieve costs by operation sequence. All routing codes and BOM codes are available. You do not have to run the Cost Rollup process to retrieve the costs. This inquiry is designed for a single assembly and only at the highest level.
Operation Sequence Detail Costs Page	CE_COST_OPSQDTL_SP	Displays the extended costs of one operation sequence by cost element for each conversion code and conversion overhead code. Displays summarized cost of yield loss from prior operations (Previous OpSeq Cost Applied).
Review Costed Routings - Component/ Output Page	CE_COST_INQ_DTL	Displays the components added to each operation sequence and the output from each operation sequence.
Review Costed Routings - Additional Costs Page	CE_COST_INQ_ADDL	Displays the additional calculated costs added to this combination of business unit, item ID, cost type, and cost version. These costs are entered on the Additional Item Costs page. They are applied after all labor, machine, material, and overhead costs have been added.
Message Log-Search Page	MESSAGE_LOG	Review the status of any background process and view messages for any errors that occurred during the Cost Rollup or Update Production processes.

Costed BOM Page

Use the Costed BOM page (EN_BOM_INQ_COSTED) to displays component costs based on the item's manufacturing BOM or engineering BOM.

You must run the Cost Rollup process for the BOM code and routing code combination to display the costs on this page.

Navigation:

- **Manufacturing Definitions > BOMs and Revisions > Review BOM Information > Costed BOMs > Costed BOM**
- **Engineering > BOMs and Revisions > Review EBOM Information > Costed EBOM > Costed EBOM**

This example illustrates the fields and controls on the Costed BOM inquiry page. You can find definitions for the fields and controls later on this page.

Costed EBOMs

*Unit Search

*Item ID Professional Road Bike, Womans

*Cost Type Cur Costs *Cost Version Engineering Costs

*BOM Code Routing Code BOM Qty EA

Revision Depth Cost as Batch

Eff Date

View Output Costs Chunk Size

Components							
Lvl	Type	Component ID	Description	Cost Req. Qty	Std UOM	Per	Extended Cost
1	Component	FR7002	Bike Frame, Aluminium	1.0000000	EA	Assembly	0.0000
1	Component	FR7005	Front Fork	1.0000000	EA	Assembly	0.0000
1	Component	FR7012	Primer Paint	0.5000000	GAL	Assembly	0.0000
1	Component	FS3000	Bolt	10.0000000	EA	Assembly	0.0000
1	Component	FS3001	Washer	10.0000000	EA	Assembly	0.0000
1	Component	FS3002	Nut	10.0000000	EA	Assembly	0.0000

Another method of viewing a manufactured or engineering item's cost is to use the Costed BOM page or the Costed EBOM page. You can display the costs of an assembly, its components, and outputs according to cost type and cost version. This is especially useful for determining the costing impact of manufacturing BOM changes on an assembly. Use cost types for costing simulations, to perform what-if analyses, or to calculate new standard costs prior to updating. Cost versions are iterations of a particular cost calculation for a cost type. You can have multiple versions for each type. You cannot use these inquiry pages for configured items.

Field or Control	Description
Cost as Batch	If the output is one single item ID, then select this check box to view the costs and quantities for the entire batch instead of a single unit of the item. If the item has co-products, then the costs and quantities of the batch appear. In addition, for each of the components, the check box controls whether the per unit costs are multiplied by the BOM quantity to get a batch cost instead of a per unit cost.
Depth	Enter the number of levels of the BOM to include. To ensure the costs include all changes at the lower levels and choose the maximum depth of a BOM. This is important for revision-controlled BOMs.

Field or Control	Description
Output Costs	Click this link to access the Output Costs page, where you can view all lower-level costing details for each output product based on the costing percentage split. Also, the Output Items link on the Output Costs page enables you to view these costs by cost element.
Co-Products	Click this link to access the Output List page, where you can view any co-products associated with the component. This link is only available if co-products are present.
Component ID	Click this link to access the Component Detailed Costs page, where you can view the detailed costs of the component according to cost element.

Note: Due to rounding differences, it is possible you could see a small variance (+ or – 0.0003) between the cost version costs and the inquiry costs in this inquiry. This occurs when the system displays the costed BOM results for an item that is either a batch item or has batch assembly items at lower levels.

Related Links

"Prerequisites" (PeopleSoft Manufacturing)

"Header: Outputs Page" (PeopleSoft Manufacturing)

Updating Production Costs

To update standards costs in the production tables, use the Update Production Costs component.

Once you have reviewed and approved the calculated product costs for manufactured and configured items, you can move them into the production cost records using the Cost Update/Revalue process page. This process:

- Moves the item cost details from the temporary table CE_ITEMCOST_DET to the Production Cost details table CM_PRODCOST_DET.

The cost element summarizes the data and places it in the Production Cost table CM_PRODCOST. The data is stored by effective date, cost type, and cost version. The CM_PRODCOST_DET record captures the details for yield by operation transactions by storing yield-loss costs at the operation-sequence level and maintaining extended precision cost fields calculated by the Cost Rollup process.

- Calculates the change in inventory value for all material in storage areas (including raw material, finished goods, inspection, and material issued to WIP inventory locations) based on the new standard costs at the time of the update and the existing standard production costs for the item. If you are using the negative inventory feature and at the time of a revaluation there is an item that has negative inventory (for example, WIP bin component with a negative inventory) then the system changes the item's standard cost and generates inventory revalue (transaction group 200) entries.
- Revalues assemblies and subassemblies in process based on changes to an item's product structure, cost, routing, or rates.

The change in value reflects the revaluing of all outputs, including co-products, by-products, and teardown outputs. The revalue process only considers production IDs and schedules that have a status of *In Process*, *Pending Complete*, *Complete*, and *Closed for Labor*.

- Updates the operation list with any new routing costing labor or machine times and run rates.

This occurs only if a match between the operation list and routing occurs for the operation sequence, work center, and task (optional).

- Writes the difference in inventory value and WIP value to revaluation records for posting to the general ledger.
- Copies the conversion rates and conversion overhead rates used to determine the production costs into a production rate record.

Once the system completes the update, it uses these rates to determine earned labor, machine, subcontracting, and overhead costs for WIP for any completions once the update is performed.

The Cost Update/Revalue process page does not move product costs for an engineering or simulated cost version into the production cost record. However, you can run the process in report-only mode. This enables you to determine the effects of proposed engineering changes on inventory value.

Page Used to Update Production Costs

Page Name	Definition Name	Usage
<u>Cost Update/Revalue Page</u>	RUN_CES5001	Updates the costs and performs inventory and WIP revaluation.

Revaluing Inventory

Revaluing inventory is the process of updating an item's cost and accounting for the change in inventory value due to the change in standard cost for the item. The process involves calculating the difference in inventory value, recording the difference, and updating the standard costs for the items. Once you record the updated information, you can post it to the GL through the normal transaction accounting cycle. Because the system bases the revaluation on a snapshot of the inventory, you want to ensure that the inventory value is as correct and accurate as possible to reflect the correct financial picture.

Prior to running the Cost Update/Revalue process page to revalue inventory, you must:

1. Put away all pending inventory in the appropriate storage areas using the Complete Putaway process (INPPPTWY).

This includes all items that you received from vendors that require inspection, assemblies that have been completed in WIP and are issued back to stock or to another WIP location, as well as any receipts from another inventory business unit. This ensures that the system can account for all inventory and can calculate and post the correct revaluation amount.

2. Run the Deplete On Hand Qty process (IN_FUL_DPL) to ensure that the item's quantities at the business unit level match the item's quantities at the location level.

You must issue all staged items in order for the system to complete the update for the quantity on hand.

3. Run the Cost Accounting Creation process (CM_COSTING) to ensure that all transactions already created throughout the PeopleSoft applications have been costed.

The transactions do not need to be posted.

4. Prohibit material movement for the business unit by selecting the **Prohibit Material Movement** check box on the PeopleSoft Inventory Definition page.

No inventory transactions should take place while the Cost Update/Revalue process page is revaluing inventory. When it updates the standard costs, the system multiplies the change in standard cost by the quantity on hand for the item in each storage area. By prohibiting material movement, you ensure that the quantity on hand is accurate.

5. Check the Process Monitor to ensure that someone else in the organization is not running the Cost Update/Revalue process page.

If you are updating all item costs within the business unit, you should not run two Cost Update/Revalue processes simultaneously.

In-process inventory includes two parts:

<i>Field or Control</i>	<i>Description</i>
RIP	Raw material or subassemblies that have been issued to the shop floor but have not yet been used in an assembly. RIP inventory value is part of the storage area location inventory and is fairly easy to calculate. It is derived by multiplying the quantity on hand for an item in the WIP storage location by its costs.
WIP	Items that are in various stages of assembly. Inventory value for material in process presents more of a challenge, because it involves incomplete sets of components associated with an assembly item. It also includes value-added material that has been scrapped and must take into account material that has been completed to stock and is no longer part of WIP.

Calculating WIP Inventory

WIP value is not a value or amount that PeopleSoft Cost Management stores for end items using a frozen standard cost approach. It is calculated at any point in time using PeopleSoft records. To calculate WIP:

- Add component costs.
- Add earned conversion costs (labor, machine, subcontracting, and overhead).
- Add waste by-products.
- Subtract assembly scrap.

- Subtract assembly completions (including co-products and recycled by-products).

Component Costs

PeopleSoft Cost Management bases the WIP component costs value on the quantity of the component issued to the production ID or production schedule. The quantity issued is stored on the component list. PeopleSoft Manufacturing updates the issue quantity when you record operation or assembly completions and the component is consumed from the WIP location or when the component is kitted directly to the production ID. PeopleSoft Cost Management derives the value for component costs by multiplying each component's issue quantity by the component's standard cost-by-cost element, then summarizing all the costs for all components. This enables the system to determine the lower-level costs for WIP. To calculate the old cost, PeopleSoft Cost Management uses the latest cost for the item in the Items Production Cost record. To determine the new cost, PeopleSoft Cost Management uses the item's cost for the cost type and version that you're using to update the cost.

Earned Conversion Costs

Earned conversion costs include the labor, machine, subcontracting, and overhead costs for this level only. *Earned this level costs* account for the value added to WIP. The system bases these costs on assemblies or operations that are complete. The WIP value report summarizes entries in the earned conversion cost record for each production ID or production schedule according to the cost category associated with the cost element. The WIP revalue first determines the old *earned this level costs* by summarizing the costs as stated in the Earned Conversion Cost record. Then, the new *earned this level costs* are calculated, taking into account any changes in routing times and their corresponding rates for the cost type and version that you select. PeopleSoft Cost Management posts any differences to the earned conversion cost record, so that when it summarizes, the old earned conversion costs plus the differences equal the conversion costs at the new standards.

Waste By-Product Cost

If the production ID or production schedule has multiple outputs, then include any waste by-product that has been reported complete and issued from the operation. Determine the waste by-product cost by multiplying the actual output quantity (quantity completed at the operation) by its standard cost. Any waste by-product costs are added to the overall cost of the WIP value. To determine the change in waste by-product cost, compare the current completion cost to the cost of the quantity completed and multiply by the new cost for the cost type and version selected for the update.

Assembly Scrap

Assembly scrap accounts for the value of partially completed assemblies that you have rejected. The cost must be subtracted, because the system does not include this assembly scrap value as part of WIP or finished goods. At the time the scrap occurs, the system determines the scrap cost by summarizing the components used up to that point, plus any value added up to the point that the scrap occurred. The system stores assembly scrap costs in an assembly scrap record and summarizes scrap costs in the WIP value report by cost category for the production ID or production schedule. As with components and earned conversion costs, the scrap cost for revaluation is recalculated based on the component costs using the cost type and version. These level scrap conversion costs are based on the new times and rates for the cost type and version.

Assembly Completions

Assembly completions take into account, for all outputs, the assemblies that are completed to stock, another production area, or issued directly to another production ID, and are therefore no longer part of the production ID or production schedule value. This includes the cost of co-products and recycled by-products. The value is derived by multiplying the quantity completed for all outputs as stated in the production header record by its cost from the item production cost record. To determine the new value of completions, the assembly quantity completed is multiplied by the cost for the selected cost type and version.

Revaluing WIP Inventory

The inclusion or handling of a production ID or schedule in WIP depends on the production status. The system revalues any production ID or production schedule if the production status is not *entered*, *firmed*, *released*, *canceled*, or *closed for accounting*.

Processing Non-Matching Cost Elements

When processing non-matching cost elements, the WIP revalue involves matching cost elements from the old costs to cost elements for the new costs. In cases where there are no matches, the Cost Update/Revalue process still posts the difference to the variance record. In the case where the old cost record has a cost element that does not exist on the new cost record, the system posts a negative entry on the variance record for the entire old cost. If the new cost record has a cost element that does not exist on the old cost record, the system posts a positive entry for the entire new cost.

Processing Configurable Items

In the WIP revalue process, it is necessary to first determine if the item being revalued is a configured item that is using configured costing. When processing the component, the system verifies whether there is a configuration code on the component list for the item. If there is, the next check verifies whether the item is configured costed by reviewing the check box on the master item table. If the item is to be configured costed, the system matches the configuration code found on the component list to that on the item production cost record for the item and uses those costs to calculate any differences.

When the system processes assemblies, the same checks hold true. If the production order assembly item has a configuration code, the system verifies whether the item is to be configured costed. If the item is to be configured costed, then another match of the configuration code found on the header record is made to that on the item production cost record, and those costs are used to calculate any differences.

Processing Without Operation Lists

When a production ID or production schedule does not have an operation list, the conversion costs are earned by posting the this level costs from the item production cost record to the earned conversion cost record. Therefore, to calculate the earned conversion costs at the new standard, use this level costs for the cost type and version.

Floor Stock and Expensed Items

The system does not include floor stock or expensed items for purposes of inventory valuation and revaluation.

Operation List Updates

As part of the WIP revaluation process, the system updates the operation lists with the costing labor and machine set up, run, fixed run, and postproduction times and run rates. It makes an attempt to match the operations on the operation list to those on the items primary production routing or its referenced item routing. When the operation sequence, work center, and task code (if you use tasks) on the routing match the component list, the times and run rates in the operation list are updated with those from the routing. This ensures that the system does not create process change variances once you update the costs. If the item's reference routing changes and is different from the one that you used to create the operation list, no updates are made even if the operations, work centers, and task codes match.

The WIP Revaluation report displays the old cost, new cost, and variance.

Cost Update/Revalue Page

Use the Cost Update/Revalue page (RUN_CES5001) to update the costs and perform inventory and WIP revaluation.

Navigation:

Cost Accounting > Item Costs > Update Costs > Cost Update/Revalue > Update Production

This example illustrates the fields and controls on the Cost Update/Revalue page. You can find definitions for the fields and controls later on this page.

The screenshot displays the 'Cost Update/Revalue' page with the following fields and controls:

- Run Control ID:** ADHOC
- Language:** English (dropdown menu)
- Specified Language:** (selected)
- Recipient's Language:** (unselected)
- Business Unit:** US012
- *Cost Type:** CUR
- *Cost Version:** REV1
- Prohibit Material Movements:** (unselected)
- Status:** Current Costs
- Version Type:** (empty field)
- Item Selection:**
 - All
 - Single
 - Cost Group
- Item ID:** (text input field)
- Std Cost Group:** (text input field)
- Distrib. Type:** (text input field)
- Report/Update Options:**
 - Report Only - No Updates
 - Revalue Inventory and Report
 - Revalue Inventory - No Report
- Sort Option:** Item ID (dropdown menu)
- Summary Report Only:** (unselected)
- Save Variance Results:** (selected)

Select the business unit, cost type, and cost version with which you want to update the standard costs. The status for the cost type and version type appears and must be set to *Approved* for versions related to manufactured and configured items.

The value in the **Distrib. Type** (distribution type) field changes to the distribution type associated with the inventory revaluation transaction group, but you can change it or you can leave it blank.

Note: PeopleSoft Cost Management copies to production the cost type and version's conversion rates and conversion overhead rates only when you have selected all items. The system copies these rates and uses them to calculate the earned labor and machine costs, as well as the applied overhead values for assembly completions and scrap. If you are updating a single item cost and have based that cost on new conversion rates, you must manually copy those rates into the production rate records.

Report/Update Options

You have three options for running this process:

- **Report Only - No Updates.**

This is the only option available for versions related to engineering or simulation. Use this option to view the impact of the standard change without actually updating the costs and posting revaluation entries. Running this process in report-only mode gives you a preview of the financial impact of the standards change without affecting the current transaction costing or inventory valuation.

- **Revalue Inventory and Report.**

This option updates the standard production cost record and calculates the change in all inventory values. Running this report enables you to analyze a specific item, production ID, or schedule quantity should a question arise regarding the revaluation.

- **Revalue Inventory - No Report.**

This option updates all records discussed in this section but does not print a report detailing the changes to inspection, stores, WIP inventory locations, or to WIP inventory.

When reporting, you can also select to print a summary report only or to save variance results. When you choose to run the update in report-only mode and save variance results, you can review the revaluation results by viewing the Compare Cost Updates or the Cost Updates by Tolerance pages.

Related Links

[Update Conversion Rates Page](#)

Reviewing Standard Costs

After updating the production records with the new standard costs calculated by the Cost Rollup process and applied by the Cost Update/Revalue process, you can review the standard costs using several inquiry pages.

Pages Used to Review Applied Standard Costs

<i>Page Name</i>	<i>Definition Name</i>	<i>Usage</i>
Current Costs by Item Page	CM_PROD_COST_INQ	View the standard costs of items.

Page Name	Definition Name	Usage
Prod'n/Standard Cost Detail Page	CM_PROD COST_DET	Displays the detailed costs maintained by component ID and operation sequence.
Cost Update History Page	CE_REVALUE_VERS	Displays the history of cost updates for a business unit. Each time that you update the production costs, the system records the date and time of the update, as well as the cost type and version.
Items without Current Costs Page	CM_NOPRDNCST_INQ	Determine which items have been added to the business unit but have no costs in the standard production cost record.
Cost Updates by Tolerance Page	CE_ITEMCVAR_RPT2	Displays item cost variances outside a percentage tolerance. If you updated production costs, or ran the Cost Update/Revalue process in report-only mode, and elected to save the variance results, you can report those variances at any time.
Compare Cost Updates Page	CE_ITEMCVAR_RPT	Displays item cost variances. These variances occur when an item's costs are updated and the old cost differs from the new production costs. This information is visible only if you have actually updated production costs, or you elected to save variance information when you ran the update in report-only mode.
Message Log - Search Page	MESSAGE_LOG	Review the status of any background process and view messages for any errors that occurred during the Cost Rollup or Cost Update/Revalue processes.
Current Conversion Rates Page	CE_FRZCONRATES	Displays the current labor, machine, and subcontracting rates and costs. When you update the previous production costs with a new cost type and version and select all items, the system copies the conversion rates and conversion overhead rates that you used to calculate those costs into a record that stores the costs and rates. The system uses these rates within PeopleSoft Manufacturing to calculate the earned labor, machine, and subcontracted costs for completed and scrapped assemblies.

Page Name	Definition Name	Usage
Current Overhead Rates Page	CE_FRZCON_OH	Displays the current conversion overhead rates and costs. When you update the previous production costs with a new cost type and version, and then select all items, the system copies the conversion rates and conversion overhead rates used to calculate those costs into a record that stores the costs and rates. The system uses these rates within PeopleSoft Manufacturing to calculate overhead costs for completed and scrapped assemblies.

Calculating Costs for PeopleSoft Supply Planning

You can define specific BOM and routing combinations that can be extracted to PeopleSoft Supply Planning. This ensures that planning processes use the most accurate costs as the main driver when making sourcing decisions.

To specify BOM and routing combinations that can be extracted to PeopleSoft Supply Planning:

1. Create BOM and routing codes for an item.
2. On the Define Business Unit Item - Manufacturing page, select the **Use Prdn Option Maintenance** option to enable the system to select all BOM and routing combinations that have the **Incl Plan** (include in planning) check box selected on the Production Option Maintenance - Definition page.
3. Use the Define Production Options component to link the BOM and routing codes together and (optionally) assign them to production areas.

Select the **Include in Planning** check box to specify which BOM and routing combinations should send to the planning engine.

4. Create production IDs and production schedules for the item.
5. Run the Production Option Costing process.
6. Verify the results using the Review Sourcing Templates component.
7. Run the Optimization Table Load process (PL_LOAD_OPT).

To use the Define Business Unit Item - Manufacturing page to specify BOM and routing combinations that can be extracted to PeopleSoft Supply Planning:

1. Create BOM and routing codes for an item.
2. On the Define Business Unit Item - Manufacturing page, select the **Use BOM and Routing Defaults** option to :
 - a. Limit the number of BOM and routing combinations that are extracted to PeopleSoft Supply Planning by entering a BOM code or a routing code on this page. If you enter a value in the **BOM**

Code or **Routing Code** fields, then the Production Option Costing process only uses that value. You can use this feature to cost all BOMs with one routing or vice versa.

- b. Cost every possible BOM and routing combination by leaving the **BOM Code** and **Routing Code** fields blank.
3. Create production IDs and production schedules for the item.
 4. Run the Production Option Costing process.

This process rolls up production option costs based on the specific BOM and routing combinations.

5. Verify the results using the Review Sourcing Template component.
6. Run the Optimization Table Load process to pass costs to the planning engine.

Note: If the Production Option Costing process has not been run, PeopleSoft Supply Planning use the item cost based solely on the primary BOM and routing.

Sourcing Template

If there is a sourcing template for the item, then that template determines the sequence of production, purchase, and transfer options. If there is no sourcing template, then the template is loaded in lowest cost order.

Note: If the costing utility has not been run, then the system uses the item standard cost when creating the item's sourcing template.

Pages Used to Review Calculated Planning Costs

<i>Page Name</i>	<i>Definition Name</i>	<i>Usage</i>
Define Business Unit Item - Manufacturing Page	MFG_ATTRIB	Select the Use Prdn Option Maintenance option to enable the system to select all BOM and routing combinations that have the Incl Plan (include in Planning) check box selected on the Production Option Maintenance - Definition page.
"Production Option Maintenance - Definition Page" (PeopleSoft Manufacturing)	EN_PDO_BR	Use this page to define production options and effective-dated BOM and routing combinations that can be extracted to PeopleSoft Supply Planning.
<u>Production Option Costing Page</u>	CE_PRDNCST_REQ	Calculates the production option costs for items, based on the as of date. This ensures that a more accurate cost, based on specific BOM and routing combinations, is sent to PeopleSoft Supply Planning for each production option.

Page Name	Definition Name	Usage
Review Sourcing Templates - Sourcing Template Page	PL_SOURCE_DTL	Review the results of the Production Option Costing process.

Production Option Costing Page

Use the Production Option Costing page (CE_PRDNCST_REQ) to calculate the production option costs for items, based on the as of date.

This ensures that a more accurate cost, based on specific BOM and routing combinations, is sent to PeopleSoft Supply Planning for each production option.

Navigation:

Cost Accounting > Item Costs > Update Costs > Production Options Cost Update > Production Option Costing

The Production Option Costing process calculates the cost of items to be sent to PeopleSoft Supply Planning. This utility considers makeable items, including primary items and co-products (make items) but not buy items. If an associated primary BOM exists for an item and it is a co-product on an associated primary BOM and also has its own BOM, then both the item's BOM and its associated primary BOM are included in the costing.

For a routing with operation yield, this process captures the detailed costs at the operation-sequence level by calculating yield loss, maintaining extended precision cost fields, and storing detailed calculations in the CM_PRODCOST_DET record.

For single output BOMs, the system calculates, according to cost element, the BOM and routing combination total this level and lower-level cost, and then stores these values in the full cost fields. It then divides these values by the output quantity (same as BOM quantity for single output BOMs) to get the per unit cost.

For multiple output BOMs, the system also adds any waste by-products costs and subtracts recycle by-products costs from the full batch this level and lower-level costs. Therefore, in order to calculate the (per unit) cost for the primary and co-products, the system uses this formula:

$$\text{Item Per Unit Cost} = (\text{Output Cost \%} * \text{Full Batch Cost}) / \text{Output Qty}$$

Setting Up Actual and Average Costing for Makeable Items

Understanding Actual and Average Costing in Manufacturing

With PeopleSoft Cost Management, you can manufacture an item by using any of the five cost methods: frozen standard, actual cost, perpetual average, retroactive perpetual average, or periodic average costing. Standard costing is based on the frozen standards that are established for each component plus the conversion costs and overhead conversions costs. The actual and average costing methods are based on the actual cost of the end item as it is placed in finished goods after production is complete. This section discusses how the actual cost of an end item is computed by PeopleSoft Cost Management.

As an item is built in the manufacturing process, the costs from components, conversion costs, and overhead conversion costs are accumulated in Work in Process (WIP). The end item's actual cost is the net cost in WIP for the production ID or production schedule. When the production ID is completed and closed for accounting and the items are put away into inventory, then the WIP costs are moved to finished goods. In other words, the net debit to WIP is the actual cost. For actual or average cost end items, the finished goods account is debited with the entire WIP costs, there is no variance, as there is in standard costing.

Actuals costs for a production ID or production schedule are computed as part of the Transaction Costing process that is within the Cost Accounting Creation run control. After the production ID is closed for accounting, the Transaction Costing process finishes debiting the unposted transactions and calculates the actual cost of the assembly items. Then the process clears WIP to finished goods for all cost books. The Transaction Costing process gathers up the actual costs that are recorded and posts the costs to the work in process costs (CE_ACTUAL_COST) table. Then, the Transaction Costing process posts the manufacturing costs from the CE_ACTUAL_COST table to the CM_ACTUAL_COSTB table. Production IDs that are closed for accounting can be reopened for changes; the actual cost calculations of the Transaction Costing process handles these changes.

It is important to understand what is added (debited) to WIP during the production process. This is based on the definition of the cost profiles for the end item and components.

Material Cost of Components

The material cost of an end item is determined by the cost profiles of the input items or components. Components having different cost profiles may be used in the manufacture of an end item. For example, component A is an actual cost profile item, component B is a perpetual average cost item, component C is a standard cost item, and the end item uses an actual cost profile. Therefore, the final cost is made up of the component costs using each of those different cost assumptions. The actual cost of component A is calculated and applied to the end item. The perpetual average cost of component B is calculated and applied to the end item. The frozen standard cost of component C is applied to the end item. If you want actual cost applied to all levels, define the cost profiles of all significant components as actual cost. For purposes of computing actual costs of production ID's, if any component items (make or buy) use an actual cost profile, then those final lower-level actual costs are necessary for computing a final actual cost

at the next level. PeopleSoft provides the actual cost inquiry to display production IDs with unfinalized costs as well as the dependencies that are underneath each level.

Component consumption transactions occur as component items are issued from inventory. These issues are recorded in TRANSACTION_INV in the transaction groups; 021 Receipts from Production, 230 Component Consumption, 221 Route to Production Kit, 222 Waste Completion, and 223 Component/Output Transfers. The production ID and the operation sequence of the consumption are recorded to TRANSACTION_INV. The inventory issue transaction is triggered by recording completions. In general, these component issues credit raw material inventory and debit WIP.

Labor and Machine Conversion Costs

Define on the Cost Profile-Manufacturing page for the make item, how labor and machine costs are calculated. You can use the costing conversion rates that are established on the Conversion Rates page (defined by cost type and cost version used) or the rates can be entered by crew on the Crew Actual Cost page (defined by business unit). For time, choose between the times that are established for the item routing or the actual time per production ID that is entered on the Record Actual Hours page.

Conversion costs occur as operations are completed and are recorded in the SF_EARNCONCOST table. As operation sequences are completed, the transaction group 640—Actual Labor Costs records an accounting entry with a credit to an earned labor account and a debit to WIP. Also, the transaction group 645—Actual Machine Costs records an accounting entry with a credit to an earned machine account and debits to WIP.

Conversion Overhead Costs

Overhead costs for production, such as depreciation, electricity, rent, and insurance, are calculated and applied to a manufactured item based on the production overhead codes that are applied to the item routing and the applicable conversion overhead rates (defined by cost type and cost version that is used). Overhead costs are applied the same way for standard, actual, and average costing methods.

Conversion costs occur as operations are completed and are recorded in CE_ACTUAL_COST and SF_EARNCONCOST tables. The transaction group 630 (Overhead) records an accounting entry to debit WIP and credit a manufacturing overhead cost absorption account.

Subcontracted Costs

Costs for subcontract services are quoted as standard costs on the routing, as quoted costs on the purchase order, and finally as vouchered costs from PeopleSoft Payables. The transaction group 664 (Subcontracted Costs) records the variance between the subcontracted costs on the purchase order and the actual subcontracted costs on the voucher. The accounting entry debits WIP and credits an accrued liability account. This transaction group is used only for actual or average cost items.

Costing Co-Products

If a single manufacturing process generates multiple items, you can allocate the batch cost across the primary and co-products to determine the per unit cost of each end item. Primary and co-products can have different costing methods; for example, the primary product could use the actual cost method while one co-product uses the standard cost method and another co-product uses actual cost. When the primary product uses the actual cost method, then the Cost Accounting Creation process, with the Calculate Actual Prdn Costs check box selected, computes the actual cost of the entire manufacturing process based on the primary product. The choices made for the primary product on the Cost Profiles-Manufacturing page for calculation of labor and machine costs are used. When the cost of the production order is completed, the

cost is allocated to the co-products. If all products are using actual or average costing, then the system calculates a co-product's cost by multiplying the total cost of the batch (including the recycle and waste by-product costs) by the cost percentage for the co-product (as specified on the BOM Maintenance - Outputs page), then dividing by the expected output quantity of the co-product.

However, if one or more of the co-products uses the standard cost method, then their cost is derived from the Cost Rollup and Cost Update/Revalue processes for that co-product's item ID. Based on the cost percentages on the BOM Maintenance - Outputs page, the Cost Accounting Creation process re-weights the output cost percentages and divides the costs from the primary product among the primary and co-products that are not using standard costing. For example, assume a production ID has this breakdown:

<i>Item ID</i>	<i>Output Type</i>	<i>Output Cost Percentage</i>	<i>Cost Method</i>
10001	primary product	60	actual
10002	co-product	20	actual
10003	co-product	20	standard

The Production ID costs from the Cost Accounting Creation process are allocated:

<i>Item ID</i>	<i>Applied Output Cost Percentage</i>
10001	75 percent (60/80)
10002	25 percent (20/80)
10003	None, cost derived from standard cost for this item.

If the total cost of production is 100.00 EUR and 2 units of each item are produced, then:

<i>Item ID</i>	<i>Applied Cost</i>
10001	60.00 (total cost of production less standard costs, multiplied by the applied output cost percentage:) $100.00 - 20.00 = 80.00 \times 75\%$
10002	20.00 (total cost of production less standard costs, multiplied by the applied output cost percentage:) $100.00 - 20.00 = 80.00 \times 25\%$
10003	20.00 (the standard cost of item 10003 is 10/unit and 2 units were produced).

Costing By-Products

By-products can be of two types, recycle and waste.

Term	Definition
Recycled By-Products	<p>The system calculates cost relief for recycled by-products by multiplying the quantity and the cost of the by-product. This cost relief is subtracted from the lower level costs; the system treats recycled by-products as a negative cost because they can be used as an input to another process. The cost that is used is determined by the purchase cost as specified for the cost type that is defined on the Inventory Definition-Business Unit Books page for the item's business unit.</p> <p>If the make (end) item is actual or average costed and a recycled by-product is produced, then the Cost Accounting Creation process uses the transaction group 021–Receipts from Production when the production is closed to accounting to credit WIP and debit the finished goods inventory account.</p>
Waste By-Products	<p>The system treats waste by-products as positive or zero cost: they either add to the cost of the product, such as the cost of disposing it, or have no associated cost. The system determines the cost that is used for waste by-products by multiplying the quantity and the cost of the waste by-product. This cost is added to the material costs.</p> <p>If the make (end) item is actual or average costed and a waste by-product is produced, then the Cost Accounting Creation process uses the transaction group 622–Actual Waste Cost when the production is closed to accounting to credit an expense account, such as waste disposal liability, and debit the finished goods inventory account.</p> <hr/> <p>Note: A recycled by-product must have the same cost element (with a cost category of material) as another component or waste by-product, or the item is not costed. This reduces the chance of a material element producing a negative value. If the cost element becomes negative, because of a recycle by-product cost relief, the system does not cost the item and an error message is generated. Errors can be viewed through the Pending Transactions inquiry page or the Message Log page.</p>

By-products are valued by using net realizable value, therefore a frozen standard cost must exist for each by-product. Create the frozen standard cost by cost type and cost version by using the Cost Rollup process.

Scrap and Rejected Costs

If the make (end) item is actual or average costed and scrap is produced, then scrap costs are included in the cost of the successfully produced end items.

Costing Partial Receipts From Manufacturing

Partial receipts occur when part of a production run is completed and put away into inventory but the production ID is not yet completed and closed for accounting. All production costs are not yet recorded and are not available for actual cost computation. Therefore, any depletions from inventory that ship these partial receipts do not have an actual final receipt cost to use.

If the Cost Accounting Creation process is set for midperiod mode and the item's cost profile selects the wait for final costs option, then the partial receipts and partial depletions wait to be costed. The system simply waits for the production ID to be completed and closed for accounting to cost. If both midperiod mode and wait for final cost are not selected, then the partial receipts and partial depletions are costed using estimates based on the partial putaway cost option on the Cost Profile-Manufacturing page. Once production is complete for this production ID and lower level production IDs and the proper actual costs can be computed into CE_ACTUAL_COST and CE_ACTUAL_COST, an adjustment is made to CM_ACTUAL_COSTB to reflect the actual cost and inactivate the previously estimated cost.

The transaction group 651 is used when a user enters a cost adjustment manually. Cost adjustments made by the user will override adjustments from system calculations and any system generated transactions. The transaction group records a credit or debit to clear WIP with a credit or debit to an actual cost writeoff account.

Manufacturing Average Cost Updates

Average costs are calculated for putaways. As new cost information on putaways becomes known, the average cost is updated to the extent the new costs are different than the previous costs used in the average cost calculations. Transaction group 601 (Weighted Average Update Production Variance) accounts for average cost updates due to new cost information on receipts from manufacturing, usually when the estimated manufacturing cost from partial receipts from WIP are updated to a finalized manufacturing cost once the production order or production schedule is complete. For example, if there are three putaways with 1 unit each at an original estimated cost of 1 each and the new cost information revises the cost to 1.25 each on the first, .75 on the second, and 1.25 on the third, then for the three units the average cost needs to be increased by a net .25 per unit. The average cost is updated and transaction group 601 is designed to account for that change in the average by debiting finished goods inventory and crediting WIP for .75 (3 x 0.25).

Manufacturing Average Cost Writeoffs

When the average cost of the item needs to be updated, due to new cost information on receipts from manufacturing, but there is not enough quantity currently in stock to absorb the updated costs, then the excess is written off using transaction group 605 (Weighted Average Update Production Writeoffs). Using the example above in the transaction group 601 description, if at the time of the adjustment, there are only 2 units still on hand (1 unit was shipped already), the average cost adjustment is only done to the extent of the 2 units: 601 debiting finished goods inventory and crediting WIP for .50 (2 x 0.25). Then the transaction group 605 is used to debit an average cost writeoff account and credit WIP for the remaining cost of 0.25 (1 x 0.25). The 605 transaction does not attempt to match individual putaways; if 1 unit had shipped but another unit had been received from another production order then the 601 adjustment applies to the 3 that are on-hand inventory and there is no 605 transaction. The objective of both 601 and 605 is to

always clear work in process such that all the input costs are relieved to a net of zero once the production is complete.

Actual or Average Cost Components With Standard Cost End Items

When the output(s) are all standard cost items, the standard cost of the inputs are used to compute the standard cost of the outputs. However, although the inputs to standard cost end items will have standard costs themselves, the input items can still use any cost profile for accounting purposes. As components are depleted, the cost on the depletion becomes part of the actual cost of the output items. When the output item is standard, the transaction group 661 (Actual Cost Variance) relieves WIP for the difference between the actual cost of the component consumption transaction and the standard cost of the component(s) which were used to build up the standard cost of the end item. This transaction group is used to credit or debit WIP to clear it out and the offset is posted to a period variances account.

Working with Cost Types and Cost Versions

The Transaction Costing process within the Cost Accounting Creation process determines which conversion rates, overhead conversion rates, and additional costs to use based on the cost type and cost version of the production ID. The cost type is applied to the production ID because the cost book in the Inventory business unit definition has a cost type and appears by default on the Business Unit Item Definition page for the manufactured item. The cost version is defined by the inventory business unit and cost book by using the Set Default Versions page. By defining the cost type and cost version by a combination of inventory business unit and cost book, the system enables you to vary the rates used by various cost books. Cost books can have different cost conversion rates, calculation approaches, and update cycles for planning, budgeting, and actual books.

This diagram illustrates how actual costs from production are gathered by the Transaction Costing process. The process uses the BOM and routing of the item along with the rates determined by the cost type and cost version.

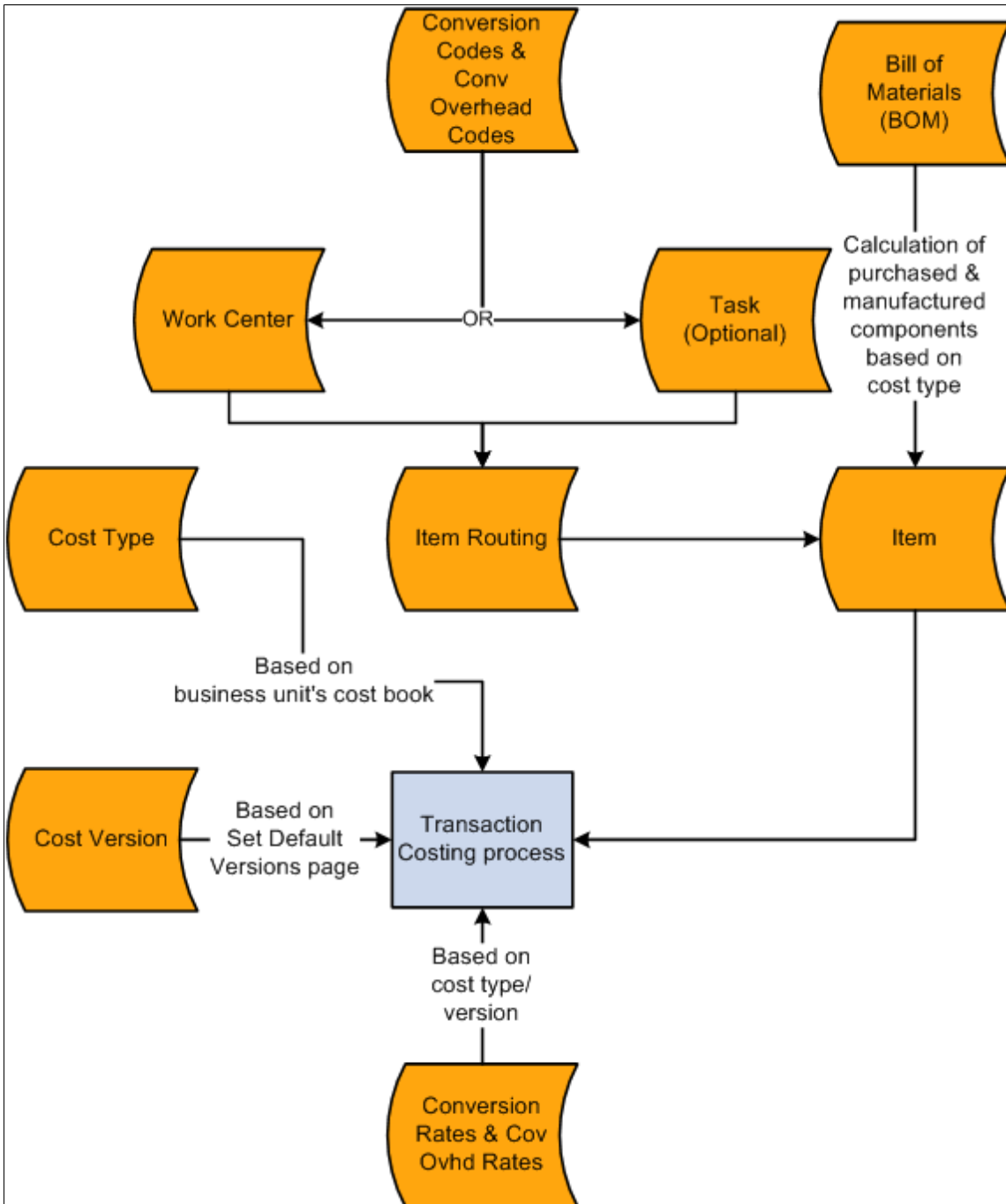

Common Elements Used to Set Up Actual and Average Costing for Makeable Items

Field or Control	Description
Actual Total Cost	The sum of the total costs of all inputs to manufacture a set of outputs on a production ID or production schedule.
Actual Unit Cost	The actual total cost apportioned to the cost percentages of the outputs and then divided by each output's quantity for the production ID or production schedule.
Average Cost	The actual unit cost of each output is added to inventory once the completed end items are put away. If the end item uses an average cost profile, that actual unit cost is used to recompute the new average cost per unit for the quantity on hand (finished or semifinished goods): $\{[(\text{actual unit cost of this putaway}) * (\text{quantity putaway})] + [(\text{average cost before this putaway}) * (\text{quantity on hand before this putaway})]\} / (\text{total quantity on hand after this putaway})$.
Book Name	The name of the cost book. A book contains a set of accounting entries that are posted to the general ledger.
Ledger Group	Within PeopleSoft General Ledger, you can group ledgers together into ledger groups. A ledger group provides the functionality for managing multibook transactions that must post to all ledgers within a group simultaneously.
Ledger	Within PeopleSoft General Ledger, ledgers organize accounting data. You can define as many ledgers as you need to record financial, budget, and nonfinancial transactions.
Ledger Template	Within PeopleSoft General Ledger, this template defines the physical attributes of a ledger. It streamlines ledger definition. The template is defined once and used for multiple ledgers.
Book Status	The status of the cost book. Values include: <i>Pending, Active, Inactive, Stopped, and Cancel</i> .
Profile	The cost profile that determines the methods to value inventory items. A profile contains three cost methods: receipt cost, cost flow, and deplete cost.
Cost Element	A code that is used to categorize the different components of an item's cost and also define the debit and credit ChartFields for accounting entries.

Field or Control	Description
Transaction Group	Predefined codes that are attached to different types of transactions, such as, putaways, shipments, user adjustments, and so on.
Cost Type	Creates separate costing groupings with different methods of costing, such as, current, revised, or forecasted costs. The cost type also defines how purchased components are calculated.
Cost Version	Cost versions are a subset of cost types that enable you to have different simulations of the costs. A cost type and cost version combination is required to calculate the final cost of an end item.

Defining Actual and Average Costing for Makeable Items

Within an actual or average cost environment, you can calculate the cost of makeable items by running the Transaction Costing process within the Cost Accounting Creation process. To set up product costs:

1. Verify that the cost structure is defined for the make and buy items. See "Structuring Your Cost Management System."

See [Understanding Cost Structure](#).

2. Verify that you defined cost foundation for manufacturing. See "Defining the Cost Foundation for Makeable Items."

See [Understanding the Manufacturing Standard Cost Foundation](#).

3. Define the default cost version by cost book.
4. Establish actual costs for crews.
5. Check the item default values, including: source code and cost element on the Define Business Unit Item component.
6. Confirm that items have a bill of material (BOM). If you roll up the costs to a configured item, verify that you have a component list on the production ID.
7. (Optional) Confirm that the items have an item routing. If you roll up the costs to a configured item, verify that you have an operation list on the production ID.
8. Once the production ID is closed for accounting, use the Transaction Costing process to calculate the cost for the items.

Pages Used to Set Up Actual Costing in Makeable Items

Page Name	Definition Name	Usage
Set Default Versions Page	CE_SET_BU_DFLT_VER	Identifies the default cost version that is to be used for each cost book when creating a production ID. Cost versions are defined for the various books for actual costing in manufacturing. Different versions may have different cost rates for different as of dates.
Crew Actual Cost Page	CE_CREW_RATE	Enter the actual labor rate by crew that is to be used by the Transaction Costing process (within the Cost Accounting Creation process) to calculate the actual cost of production IDs by using this labor crew. This page is used if the item's cost profile uses the <i>Actual Time-Crew Rate</i> option for the Labor Cost Method field.
Define Business Unit Item - Manufacturing Page	MFG_ATTRIB	Select the source code for each item.
Define Business Unit Item - General Page	GEN_ATTRIB_INV	Enter the cost element for each item. Cost elements are used to categorize the components of an item's cost. For purchased items that are components of a manufactured item, enter a value in the Current Purchase Cost field to ensure that a default price is available for the calculation of the end item.
Manufacturing BOMs - Summary Page	EN_BOM_MAINT	Verify that a BOM exists for the makeable items.
Define Routings - Summary Page	EN_RTG_SUMMARY	Verify that a routing exists for the makeable items.

Related Links

[Generating Costs for Transaction Records](#)

Set Default Versions Page

To use default versions for processing actual costing data, use the Set Default Versions component (CE_SET_BUBOOK_VER2).

Use the Set Default Versions page (CE_SET_BU_DFLT_VER) to identifies the default cost version that is to be used for each cost book when creating a production ID.

Cost versions are defined for the various books for actual costing in manufacturing. Different versions may have different cost rates for different as of dates.

Navigation:

Cost Accounting > Item Costs > Define Rates and Costs > Set Default Cost Versions

This example illustrates the fields and controls on the Set Default Versions page. You can find definitions for the fields and controls later on this page.

Set Default Versions					
Business Unit US014					
Set Default Versions					
Personalize Find View All [Print] [Refresh] First 1-5 of 5 Last					
Book Name	Cost Type	Cost Version	Effective Date	Active	
FIN	CUR	2003-FALL	01/01/2003	<input checked="" type="checkbox"/>	+
FIN	CUR	2003-FALL	09/01/2003	<input checked="" type="checkbox"/>	+
FIN	CUR	2003-SPRNG	05/01/2003	<input checked="" type="checkbox"/>	+
FIN02	CUR	2003-FALL	01/01/2003	<input checked="" type="checkbox"/>	+
FIN02	CUR	2003-SPRNG	01/01/2004	<input checked="" type="checkbox"/>	+

Identifies the default cost version that is to be used for each cost book when creating a production ID. As production IDs are created, the costing process needs to know which cost version to use for the various books for actual and average cost purposes. The Transaction Costing process (within the Cost Accounting Creation process) uses the most current cost version based on the effective date that is entered here compared to the transaction date. Cost versions must be set for all cost books. The cost versions are used for calculating labor, machine, overhead, and by-products. Since each cost book could be on a different planning or budget cycle, the system enables you to have different cost versions (and cost rates) for each book. Cost rates, such as costing conversion rates and costing conversion overhead rates, are defined by a combination of cost type and cost version.

This page is not required for cost books using a frozen standard cost profile because the standard costs do not vary across cost books. The frozen standard costs are calculated and applied to production at the business unit level for all standard cost books that are within the business unit.

Crew Actual Cost Page

To assign actual cost rates to a business unit crew, use the Assign Crew Actual Costs (CE_CREW_ACTCOST) component. Use the Assign Crew Actual Costs component interface to load data into the tables for this component.

Use the Crew Actual Cost page (CE_CREW_RATE) to enter the actual labor rate by crew that is to be used by the Transaction Costing process (within the Cost Accounting Creation process) to calculate the actual cost of production IDs by using this labor crew.

This page is used if the item's cost profile uses the Actual Time-Crew Rate option for the Labor Cost Method field.

Navigation:

Cost Accounting > Item Costs > Define Rates and Costs > Assign Actual Cost for Crews

This example illustrates the fields and controls on the Crew Actual Cost page. You can find definitions for the fields and controls later on this page.

The screenshot shows the 'Crew Actual Cost' page for Business Unit US008 and Crew Name ASSY05. It features a table with the following data:

	Crew Rate	Effective Date	Active
1	27.1500000000000000	08/03/2009	<input type="checkbox"/>
2	28.15	08/31/2009	<input checked="" type="checkbox"/>

Enter the actual labor rate by crew that is to be used by the Transaction Costing process (within the Cost Accounting Creation process) to calculate the actual cost of production IDs by using this labor crew. This page is used if the item's cost profile uses the *Actual Time-Crew Rate* option for the **Labor Cost Method** field.

Defining Item Default Values

These default values are defined for the item and influence the Transaction Costing process within the Cost Accounting Creation process.

Source Codes

The item's source code determines how the item is used for by the Transaction Costing process. You define each item's source code on the Define Business Unit Item - Manufacturing page. Options are:

Field or Control	Description
Buy	This is a purchased item. No lower level costs are calculated; therefore, any BOM or routings that are attached to this item are not used in cost calculations. The Transaction Costing process computes the cost of this item based on putaway costs. Lower-level costs, such as component costs, conversion costs, overhead conversion costs, and additional costs, are not included.
Expense	This item is expensed when it is stored in an inventory business unit. You can specify the item on a BOM to call out the material requirement, but the cost is not included in the final cost of the end item.

Field or Control	Description
Floor Stock	This item is expensed when it is issued to production. You can specify the item on a BOM to call out the material requirement, but the cost is not included in the final cost of the end item.
Make	This is a makeable item; an item that can be produced in PeopleSoft Manufacturing. Make items are assemblies or subassemblies that are manufactured in house, at a subcontractor, or by a combination of both. If a make item has an actual or average cost profile, then the Transaction Costing process calculates the final cost based on component costs, conversion costs, overhead conversion costs, and additional costs.
Planning	This is an item that is used only in PeopleSoft Supply Planning. The item is never included in the Transaction Costing process.

Routing

On the Define Business Unit Item - Manufacturing page you specify which production routing the item uses when the system determines the assembly item's this level labor, material, and overhead costs.

Average Order Quantity

The item's average order quantity indicates the typical batch or lot size that is used to produce this item. You define each item's average order quantity on the Define Business Unit Item - Manufacturing page. This is the quantity that is expected to be produced in one production ID or production schedule based on the BOM.

If a BOM quantity on a bill is greater than one, the component's per assembly quantity is spread over the BOM quantity. For example, Assembly A has a BOM quantity of 100; Component B used on A has a per assembly quantity (QPA, or quantity per assembly) of 1500. Therefore, the use of B for a single A is 15 (1500/100). When entering the QPA, BOM maintenance supports a precision of four places to the right of the decimal. You have the option to define the calculated QPA precision the system maintains when it determines the item's cost. On the Installation Options - Manufacturing page, you select a precision anywhere from 4 to 10 places to the right of the decimal. If the BOM and associated process results in multiple outputs (primary, co-products, and by-products), the BOM quantity must be set to the item's average order quantity.

If you use economic order quantities or average order quantities with setup, fixed run, and postproduction times, the system must prorate the cost of these processes over the order quantity to determine a per unit cost. The system determines per unit setup, fixed run, and postproduction cost by dividing the cost of each process by the average order quantity. Typically, the system calculates this at the operation level, then sums it to provide the total cost.

Cost Elements

The Transaction Costing process within the Cost Accounting Creation process uses cost elements to categorize the components of an item's cost. Cost elements are also used when costing a transaction. Enter the cost element for the item's material costs on the Define Business Unit Item - General page. For both purchased and makeable items, you must enter a cost element in the material cost category.

Used in Manufacturing Check Box

Any item that can have a BOM or routing, or that can be a component on a BOM or component list, or is associated with a production area, or is used on a production ID or production schedule, must be marked as used in Manufacturing. Select this check box on the Item Business Unit Definition - General: Costing page.

Related Links

["Define Business Unit Item - General: Common Page" \(PeopleSoft Managing Items\)](#)

["Understanding BOM Maintenance" \(PeopleSoft Manufacturing \)](#)

Using the Bill of Materials

The manufacturing bill, engineering bill, or component list determines the structure of the item and therefore the associated lower-level costs.

PeopleSoft Cost Management uses BOM yield or component yield loss to account for the loss of components during the manufacturing process. For costing purposes, the cost of the assembly item can therefore take into account the expected loss of components in production. In this instance, the system inflates the cost of the component by the component's yield.

Transaction costing does not include the cost of floor stock, expensed, subcontract supplied, or nonowned items. Consigned items are included in the item's cost as they are considered owned upon consumption.

If you roll up an assembly item that has no owned components, only nonowned and parts that are supplied by a subcontractor (Subsupply flag is set to Yes), the Transaction Costing process (within the Cost Accounting Creation process) does not calculate any lower-level material costs but still rolls up labor costs for that item.

Note: Subcontractor-supplied or other nonowned items must be designated as consigned to be included in an end item's final cost.

Related Links

["Understanding BOM Maintenance" \(PeopleSoft Manufacturing \)](#)

["Understanding Component Lists" \(PeopleSoft Manufacturing \)](#)

Using Item Routings

The production routing, engineering routing, or operation list documents the operations that are necessary to assemble the item. In the Transaction Costing process (within the Cost Accounting Creation process), the system considers only the routings or operation lists of those items whose source code you define as make.

When calculating conversion costs for an operation, you must consider the crew size of the operation. For example, if the crew that is assigned to a work center consists of three people, you multiply the labor run cost by three.

As it does with crew size, the system multiplies the machine cost of an operation by the number of machines that are assigned to the work center in which the operation takes place.

When the conversion rate that is associated with the code that is assigned to the operation is expressed in terms of a cost per unit, as opposed to a labor or machine rate per hour, you must specify the corresponding costing time type on the routing or operation list in order for the system to include the cost. For example, if in the conversion code that is associated with the operation, you specify a labor run cost of 1 per unit, there must be a costing labor run time in the routing or operation list in order for the system to include that 1 in the item's cost.

When you specify an operation's costing times and run rates in terms of days, the system factors the rate by the work center's average daily capacity to determine the total number of hours that it requires to complete the operation.

Related Links

"Understanding Routings" (PeopleSoft Manufacturing)

"Understanding Component Lists" (PeopleSoft Manufacturing)

Grouping Production Schedules for Actual or Average Costing

Production schedules must be included in a schedule group in order to be costed for actual or average costing by the Transaction Costing process. This section discusses how to group production schedules.

A schedule group for costing can include one or more production schedules. In the organization, one job could include several production schedules across shifts and days. You can collect all the production schedules for one job together into one schedule group ID. When the schedule group ID is costed by the Transaction Costing process, the final costs are divided by the outputs across all the production schedules in the group.

Pages Used to Group Schedules for Actual Costing

Page Name	Definition Name	Usage
Auto Numbering Page	AUTO_NUM_PNL	Define a numbering scheme to create group schedule IDs. The numbering scheme is defined by SetID and the number type <i>Schedule Group ID</i> . You cannot create groups until you establish a numbering sequence.
Group Schedules Page	CE_GROUP_PID	Group one or more production schedules into a schedule group for costing actual and average costs make items.

Page Name	Definition Name	Usage
Auto Group Schedules Page	CE_AUTOGRP_PID	Group one production schedule into one schedule group for costing actual and average cost make items.
Ungroup Schedules Page	CE_UNGROUP_PID	Remove production schedules from a schedule group. Production schedules cannot be removed after the Transaction Costing process (within the Cost Accounting Creation process) is run.

Related Links

"Creating Production Schedules" (PeopleSoft Manufacturing)

Auto Numbering Page

Use the Auto Numbering page (AUTO_NUM_PNL) to define a numbering scheme to create group schedule IDs.

The numbering scheme is defined by SetID and the number type Schedule Group ID. You cannot create groups until you establish a numbering sequence.

Navigation:

Set Up Financials/Supply Chain > Common Definitions > Codes and Auto Numbering > Auto Numbering > Automatic Numbering

This example illustrates the fields and controls on the Auto Numbering page. You can find definitions for the fields and controls later on this page.

Field or Control	Description
Number Type	Enter <i>Schedule Group ID</i> to set up automatic numbering for schedule groups.

Field or Control	Description
Field Name	Select the value CE_GRP_PID_ID for automatic numbering. This automatic numbering field is 10 characters long.
Start Seq (start sequence)	Enter a prefix using three characters. One or more prefixes can help identify the type of schedule group. For example, you may want to use a unique prefix of ALT for production schedules in the Atlanta plant and LDN for production schedules in the London plant.
Max Length (maximum length)	Enter maximum length of the schedule group ID. 10 or less characters can be entered.
Last Number Issued	Enter a numeric value to start the automatic numbering. The system starts by increasing in increments of one the last number that is issued. <hr/> Note: This field cannot be zero or blank. You must enter a value. <hr/>
Default	If you create more than one numbering sequence for this number type, indicate the default sequence.

Related Links

"Auto Numbering Page" (Application Fundamentals)

Group Schedules Page

Use the Group Schedules page (CE_GROUP_PID) to group one or more production schedules into a schedule group for costing actual and average costs make items.

Navigation:

Cost Accounting > Item Costs > Update Costs > Group Schedules for Costing

This example illustrates the fields and controls on the Group Schedules page. You can find definitions for the fields and controls later on this page.

Group Schedules

Business Unit US008
 Item ID LT5000
 Production Area SUBASSY
 Schedule Group ID 1
 *Description

Search Criteria

From Production Due Date To Date Refine Search

Select Schedules to be Grouped							Personalize Find View All	First 1-3 of 40 Last
	Production Area	Prdn Due Date	Prdn Start Date	Prdn Start Shift	Prdn Start Qty	Production Created DateTime		
<input type="checkbox"/>	1 SUBASSY	08/02/2000	07/31/2000		1	100.0000	07/14/2000 4:26PM PDT	
<input type="checkbox"/>	2 SUBASSY	08/02/2000	07/31/2000		1	100.0000	07/14/2000 4:26PM PDT	
<input type="checkbox"/>	3 SUBASSY	08/01/2000	07/31/2000		1	70.0000	07/14/2000 4:26PM PDT	

Select All
Clear All

To cost make items using actual or average costing, you must place production schedules in a group. Use this page to add one or more production schedules to a new or existing schedule group ID. When you enter this page, the system displays all available production schedules based on the business unit, item ID, and production area. You can refine the search to include the due dates from and to production. The search results only display production schedules that are not currently attached to a group. Select the production schedules to add to the schedule group ID, enter a **Description** (required), and save the page.

Auto Group Schedules Page

Use the Auto Group Schedules page (CE_AUTOGRP_PID) to group one production schedule into one schedule group for costing actual and average cost make items.

Navigation:

Cost Accounting > Item Costs > Update Cost > Auto Group Schedules

This example illustrates the fields and controls on the Auto Group Schedules page. You can find definitions for the fields and controls later on this page.

Auto Group Schedules

Selection Criteria

*Business Unit

Description

Item ID

Production Area Search

Select Schedule to be AutoGrouped								Personalize Find View All
	Item ID	Production Area	Prdn Due Date	Prdn Start Date	Prdn Start Shift	Prdn Start Qty	Production Created DateTime	First 1-2 of 37 Last
<input checked="" type="checkbox"/>	1 LT5000	SUBASSY	08/01/2000	07/31/2000	1	70.0000	07/14/00 4:26PM	
<input checked="" type="checkbox"/>	2 LT5000	SUBASSY	08/01/2000	07/31/2000	1	60.0000	07/14/00 4:26PM	

To cost make items using actual or average costing, you must place production schedules in a group. Use this page to add one production schedule to one schedule group ID. You can create multiple schedule groups at one time by selecting one or more production schedules. The system creates one group ID for each separate production schedule when you save this page.

Ungroup Schedules Page

Use the Ungroup Schedules page (CE_UNGROUP_PID) to remove production schedules from a schedule group.

Production schedules cannot be removed after the Transaction Costing process (within the Cost Accounting Creation process) is run.

Navigation:

Cost Accounting > Item Costs > Update Cost > Ungroup Schedules

This example illustrates the fields and controls on the Ungroup Schedules page. You can find definitions for the fields and controls later on this page.

Ungroup Schedules

Business Unit US008
 Item ID LT5000
 Schedule Group ID 1
 Description LT5000

Select Schedules to be UnGrouped								Personalize Find View All
								First 1-3 of 3 Last
	Production Area	Prdn Due Date	Prdn Start Date	Prdn Start Shift	Prdn Start Qty	User ID	Current DateTime	
<input type="checkbox"/>	1 SUBASSY	08/02/2000	07/31/2000	1	100.0000	DVP1	02/25/13 1:40AM	
<input type="checkbox"/>	2 SUBASSY	08/02/2000	07/31/2000	1	100.0000	DVP1	02/25/13 1:40AM	
<input type="checkbox"/>	3 SUBASSY	08/01/2000	07/31/2000	1	70.0000	DVP1	02/25/13 1:40AM	

Use this page to remove production schedules from a schedule group ID. This can only be done before the Transaction Costing process (within the Cost Accounting Creation process) is run for this schedule group ID or any transaction included in this group.

Note: If a schedule group ID is created with certain production schedules and then later you remove all the production schedules from the group, then the schedule group ID cannot be used again for a different set of production schedules.

Chapter 8

Costing Transactions and Creating Accounting Entries

Understanding Transaction Costing and Accounting Entry Creation

The inventory system posts inventory transactions into the TRANSACTION_INV table, then PeopleSoft Cost Management can assign costs to the transactions and create accounting entries. The Cost Accounting Creation process (CM_CSTACCTG) is an application engine process that completes these tasks by launching the:

1. Transaction Costing process (CM_COSTING). This application engine process picks up these inventory transactions and attaches costs to each transaction based on the item's cost profile.
2. Accounting Line Creation process (CM_ALC). This application engine process picks up the calculated costs, creates the accounting entries, and stores the entries in the CM_ACCTG_LINE table.

The Cost Accounting Creation process page launched both of these process using one run control page. This enables you to:

- Streamline the maintenance of run control definitions.
- Run both processes in a continuous stream without a break between steps.
- Run just the Transaction Costing process or just the Accounting Line Creation process based on your current processing needs.

PeopleSoft Cost Management provides inquiries and reports to view the accounting entries. Use the Edit Unposted Accounting Lines page to change the accounting entries before they are posted to the general ledger. Once, you are satisfied with the entries, use the Journal Generator process (JRNL_GEN_REQUEST) to summarize the accounting entries into journal entries. PeopleSoft General Ledger can then post the journal entries to the correct ledgers.

This diagram illustrates the cost flow of inventory transactions from the TRANSACTION_INV record using the Transaction Costing process and the Accounting Line Creation process to produce accounting entries to be picked up and summarized by the Journal Generator process.

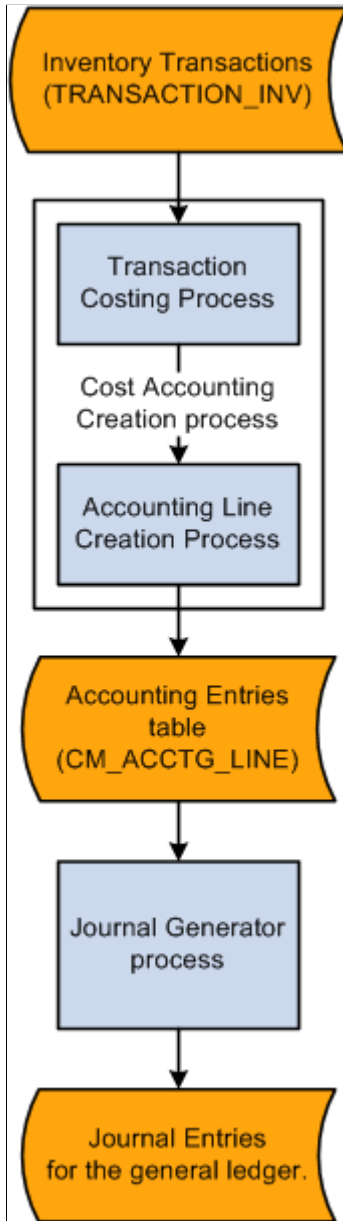

Related Links

"Understanding Journal Generator" (Application Fundamentals)

[Creating Accounting Entries](#)

"Understanding PeopleSoft ChartFields" (Application Fundamentals)

Common Elements Used in Transaction Costing and Accounting Entry Creation

<i>Field or Control</i>	<i>Description</i>
Search	Click the Search button to display the results of the search.
Transaction Group	Predefined codes attached to different types of transactions, such as, stocking, issues, adjustments, and so on.
Distribution Type	User-defined codes that are a subset of transaction groups. Enables you to break down a transaction group into customized categories.
FERC Code (Federal Energy Regulatory Commission code)	Federal Energy Regulatory Commission identification codes. Appears only if you select FERC reporting on the PeopleSoft Inventory Options page.
ChartFields	Chart of accounts used to record accounting entries and journal entries in PeopleSoft.
Cost Element	A code used to categorize the different components of an item's cost and also define the debit and credit ChartFields for accounting entries.
Item Group	A grouping of items that enable you to design the accounting structure for a group of similar items, such as, sporting equipment or dress shoes. The item group is attached to an item using the Item Definition - General page.
Book Name	The cost book used to record the accounting entry.
As of Date	The process extracts any line with a transaction date less than or equal to this date.
Foreign Amount	The amount in the entry currency.
Monetary Amount	The amount in the base currency.

Generating Costs for Transaction Records

The Transaction Costing process picks up inventory transactions from the TRANSACTION_INV record and calculates the costs of each transaction, including, material, conversion, conversion overhead, landed, inbound, outbound, and other costs. The parameters for the Transaction Costing process are defined on the Cost Accounting Creation process page.

The Transaction Costing process:

- Calculates the cost of receipts.
- Calculates the cost of depletions. If chosen in setup, this could include costing negative inventory depletions before a corresponding receipt is available.
- Calculates and updates the weighted average costs and actual costs of items having cost profiles that use actual, periodic average, or perpetual average cost methods.

Note: For standard cost items, the system does not automatically set frozen standard costs when you use the Transaction Costing process. To update standard costs, you must use the Cost Rollup process (CEPCROLL) and Update Production Costs process (CEREVAL, SFPREVAL, CES5001).

- Calculates purchase price variances and exchange rate variances.
- Calculates landed costs.
- Calculates the cost of make items produced in PeopleSoft Manufacturing.
- (optional) Launches the Negative Inventory Resolver process to check for new receipts (putaway and adjustment transactions) and adjust the quantities and costs of previously recorded negative inventory depletion transactions.

Working With Non Cost Items

Transactions involving a non-cost item (that is, items with a cost profile defined as non-cost) are not placed in the costing records by the Transaction Costing process. For example, putaway transactions are not moved to the CM_RECEIPTS record. Use caution if you later decide to change a non-cost item to an actual, standard, or average cost profile. After transactions have been generated in the system, changing a non-cost item can result in discrepancies between the costing and inventory records. A warning message displays online if you change the non-cost cost profile for an item with inventory transactions on the Define Business Unit Item - General: Costing page. If you decide to change a non-cost item please make sure you have no on hand quantity in the inventory business unit by running the Inventory Balance report (INS9090) and the Cost Management On hand Balance Validation report (CMS9010). Any inventory balance created while the business unit item used a non-cost profile will no longer be available when changing to another cost profile. In addition, PeopleSoft Cost Management does not support interunit pricing for non-cost items.

Related Links

[Using Transaction Groups](#)

[Using the Cost Rollup Process to Calculate Product Costs](#)

[Updating Production Costs](#)

[Understanding Standard Costing for Purchased Items](#)

Costing Negative Inventory

A negative inventory depletion transaction is a depletion transaction that drives the item quantity to a negative balance in the system even though physically the quantities did exist. The negative inventory feature is activated by selecting the **Allow Negative Inventory** check box on the Inventory Definition-Business Unit Options page.

Once PeopleSoft Inventory has shipped a negative inventory depletion transaction, you have options in PeopleSoft Cost Management on how to cost the transaction. There is no corresponding receipt or receipt cost to apply to the negative inventory depletion transaction. The **Insufficient Qty Cost Option** on the Cost Profiles page determines how the Transaction Costing process (within the Cost Accounting Creation process) applies costing to negative inventory transactions:

Field or Control	Description
<i>Always cost insufficient qty</i>	<p>Enables the Transaction Costing process (within the Cost Accounting Creation process) to cost negative inventory depletion transactions before sufficient quantity is entered into the business unit. For actual cost items, these costs can later be adjusted when sufficient quantity is placed in the Inventory business unit by putaway or adjustment transactions.</p> <p>For example, if there are 10 units of an item available in the business unit and an order is shipped and depleted for 15 units, then the entire depletion transaction of 15 units is costed the next time the Transaction Costing process is run, even if this is before sufficient stock is placed in the business unit. Of the 15 units, 10 are costed using the existing stock on hand and 5 are costed using the current average, current standard, or last actual cost depending on the cost method employed.</p>
<i>Cost in Regular Mode Only</i>	<p>Enables the Transaction Costing process (within the Cost Accounting Creation process), run in <i>Regular</i> mode only, to cost negative inventory depletion transactions before sufficient quantity is entered into the business unit. These costs can later be adjusted when sufficient quantity is placed in the Inventory business unit by putaway or adjustment transactions.</p> <p>If Transaction Costing is run in <i>Mid Period</i> mode, then the depletion transaction is costed up to the currently available quantity and the remainder is held.</p> <p>For example, if there are 10 units of an item available in the business unit and an order is shipped and depleted for 15 units and:</p> <ul style="list-style-type: none"> • The Transaction Costing process is run in <i>Regular</i> mode, then the entire depletion transaction of 15 units is costed. Of the 15 units, 10 are costed using the existing stock on hand and 5 are costed using the current average, current standard, or last actual cost depending on the cost method employed. • The Transaction Costing process is run in <i>Mid Period</i> mode, then the depletion transaction is split. 10 units are costed and 5 units are put on hold until sufficient stock is placed in the business unit.

Field or Control	Description
<i>Cost to point of zero quantity</i>	<p>Enables the Transaction Costing process (within the Cost Accounting Creation process) to split a negative inventory depletion transaction and cost part of the depletion transaction up to the currently available stock quantity. The remaining depletion transaction is held until sufficient stock is received.</p> <p>For example, if there are 10 units of an item available in the business unit and an order is shipped and depleted for 15 units, then the depletion transaction is split by the Transaction Costing process. 10 units are costed and 5 units are put on hold until sufficient stock is placed in the business unit.</p>
<i>Don't cost if insufficient qty</i>	<p>Enables the Transaction Costing process (within the Cost Accounting Creation process) to delay costing the entire negative inventory depletion transaction until sufficient stock is received to cover the depletion transaction. This is the default setting.</p> <p>For example, if there are 10 units of an item available in the business unit and an order is shipped and depleted for 15 units, then the entire depletion transaction of 15 units is put on hold by the Transaction Costing process until sufficient stock is placed in the business unit.</p>

The current cost used to cost negative inventory depletion transactions depends on the **Deplete Cost Method** on the item's Cost Profile. The options are:

Field or Control	Description
Actual Cost	The last actual cost received for this item.
Periodic Weighted Average	Not applicable. This deplete cost method cannot be used to cost negative inventory depletion transactions before sufficient quantity is entered in the business unit. The transaction is held.
Perpetual Weighted Average	The current average
Retroactive Perpetual Weighted Average	The current average.
Value at Current Standard	The current standard cost for the item.

If a current cost is not available for actual or average cost items, then the system uses the value entered in the **Default Actual Cost** field of the Define Business Unit Item - General: Common page.

The Accounting Line Creation process can process the costed depletion transactions and create accounting entries for the general ledger. This enables negative inventory depletion transactions to be reflected in the period end account balances rather than held up for receipt costs.

A negative inventory depletion transaction is costed by creating a dummy receipt row with a zero quantity. The depletion transaction is matched to this dummy receipt, which uses the new transaction group 001 (negative inventory) and is inserted into the costing tables. Once sufficient stock is received into the business unit, the negative state of the depletion can be cleared by using the Negative Inventory Resolver process.

Using the Negative Inventory Resolver

The Negative Inventory Resolver process has been added to the Transaction Costing process (within the Cost Accounting Creation process) to check for new putaway and adjustment transactions, and if sufficient quantities have been received into the business unit, the resolver process:

- Applies the new receipt quantities to the previously recorded negative inventory depletion transactions. The resolver matches the negative inventory depletion transactions to actual stock received.
- Creates adjusting accounting entries for items using the Deplete Cost Method of Actual Cost. The resolver creates an entry to reverse the cost previously recorded for the negative inventory depletion transaction and to record a new transaction at actual receipt cost. These changes flow to the Accounting Line Creation process where two accounting entries are created:
 1. A reversing entry to remove the depletion based on the last actual cost received before the negative state.
 2. An entry to record the depletion based on the actual receipt costs.

For items using the Deplete Cost Method of Value at Current Standard, Perpetual Weighted Average, or Retroactive Perpetual Weighted Average, the resolver does not change the previously recorded cost for the negative inventory depletion transaction. The standard or average cost on record at the time of the depletion was used on the original depletion and is not changed when the resolver corrects the negative state by matching the negative inventory depletion transactions to actual stock received.

- Inserts resolved negative inventory depletion transactions into a history table called `CM_RESOLVE_HIST`.

To resolve negative inventory, select the Resolve Negative Inventory check box on the Cost Accounting Creation process page. The process is launched within the Transaction Costing process after receipts have been processed, but before depletions.

Note: The Negative Inventory Resolver process is optional. It is highly recommended that you use this process to resolve all negative depletion transactions so that reports and queries do not reflect negative states that have been resolved. The resolver does not impact the total on hand quantity. For costs, it only impacts the total inventory value for actual cost items.

Inquiries for Negative Inventory

Two inquiries are available to monitor the costing of negative inventory depletion transactions and the recalculations of the quantities and costs performed by the Negative Inventory Resolver process. These queries are `CM_PENDING_RESOLVER` and `CM_RESOLVED_NEG_HIST` and can be viewed using the Query Viewer.

- The `CM_PENDING_RESOLVER` query returns negative inventory depletion transactions that have not been resolved.

- The CM_RESOLVED_NEG_HIST query returns negative inventory depletion transactions that have been resolved and recorded in a history table CM_RESOLVE_HIST.

Related Links

[Cost Profiles Page](#)

[Determining Your Negative Inventory Strategy](#)

Calculating Cost for Actual or Average Makeable Items

For makeable items using actual or average cost profiles, the Transaction Costing process (within the Cost Accounting Creation process) processes according to the production ID. After the production ID has been closed for accounting, the Transaction Costing process finishes debiting the unposted transactions and calculates the actual cost of the assembly items. Then, the process clears WIP to finished goods for all cost books. Finished goods receives the completed items. They are posted to the TRANSACTION_INV record or directed to another production ID. The Transaction Costing process gathers the actual costs that have been recorded and posts the costs to the CE_ACTUAL_COST table. Then, the Transaction Costing process posts the manufacturing costs from the CE_ACTUAL_COST table to the CM_ACTUAL_COST table.

If the production ID is not costed by the Transaction Costing process, the transaction displays on the Pending Transactions page under the Pending Calculation Prdn Cost. If an item is not costed, simply enter the necessary corrections to the production data and the item will be costed on the next run of the process. There are a number of reasons that the Transaction Costing process may not pick up a production ID that has been closed for accounting, including:

- The Transaction Costing process was not run for the business unit and cost book with the Calculate Actual Prdn Costs check box selected.
- For direct labor costs, no actual labor rates are set up for the business unit when the make item's Cost Profile has a labor cost method of *Actual Time-Crew Rate*.
- For direct labor costs, no conversion rates exist for the business unit when the make item's Cost Profile has a labor cost method of *Actual Time-Conversion Rate*.
- For direct labor costs, either no routing times or no conversion rates are defined for the business unit when the make item's Cost Profile has a labor cost method of *Standard Time-Conversion Rate*.
- For direct labor costs, no default cost version is active for the business unit when the make item's Cost Profile has a labor cost method of *Standard Time-Conversion Rate*.
- For direct machine costs, no conversion rates exist for the business unit when the make item's Cost Profile has a machine cost method of *Actual Time-Conversion Rate*.
- For direct machine costs, either no routing times or no conversion rates are defined for the business unit when the make item's Cost Profile has a machine cost method of *Standard Time-Conversion Rate*.
- For direct machine costs, no default cost version is active for the business unit when the make item's Cost Profile has a labor cost method of *Standard Time-Conversion Rate*.
- For overhead costs, no production overhead codes were defined.
- For overhead costs or direct materials, no default cost version is active for the business unit.

- For direct materials, the production ID has rows stuck in CM_DEPLETION or CM_DEplete.
- For direct materials, insufficient quantity exists to satisfy the depletion.
- For direct materials, an adjustment has been posted since the last time the Transaction Costing process has been run and the process must be run again for this production ID.
- The production ID has uncOSTed rows in CE_ACTUAL_COST, due to:
 - A lower level production ID with unfinished costing. The lower level production ID has the Hold for Final Cost check box selected the cost profile and the Transaction Costing process was run in mid-period mode.
 - A current level open production ID that has the Hold for Final Cost check box selected the cost profile and the Transaction Costing process was run in mid-period mode.
 - The production ID has rows stuck in CM_DEPLETION or CM_DEplete.
 - The production ID is not defined for actual or average costing.

Returning Components to Inventory

The Transaction Costing process (within the Cost Accounting Creation process) also records the cost for components or kits returned to inventory. When components are returned to inventory stock, the transaction groups, 220 (Component Kit) and 230 (Component Consumption), are inserted in the TRANSACTION_INV table with a negative quantity. The Transaction Costing process must find the correct cost and process the receipt to the CM_RECEIPTS record.

In a standard costed environment, the returned stock is received and put away at the standard cost.

For items using a deplete cost method of actual or periodic weighted average, the original receipt cost must be located by back tracking from the depletion record (for the production ID that consumed the component) to the original receipt. The process uses the last component consumed for the unit, item, production ID, and operation sequence. If the item is lot or serial-controlled, then the specific lot or serial must be found on the depletion record. FIFO and LIFO items also use the last consumed on the depletion record. For items using a deplete cost method of perpetual weighted average, the return transactions is costed using the weighted average of the items issued. For more information, see the "Returning Perpetual Weighted Average Items to Inventory" section of this topic.

Creating Accounting Entries

The parameters for the Accounting Line Creation process are defined on the Cost Accounting Creation process page. The Accounting Line Creation job performs up to three processes in this order:

<i>Field or Control</i>	<i>Description</i>
Create Accounting Lines (CM_ACCTGLINE)	This PeopleSoft Application Engine process retrieves costed transactions and finds the correct ChartField combinations to use for the debit and credit lines of each accounting entry. Results are stored in the CM_ACCTG_LINE table.

Field or Control	Description
Commitment Control Budget Processor (FS_BP_PROC)	This process performs budget checking against the rows in CM_ACCTG_LINE table. Results are stored in the CM_ACCTG_LINE table. The BUDGET_HDR_STATUS and BUDGET_LINE_STATUS fields display the current budget checking state of the accounting entry. Budget checking does not apply to manufacturing transactions.
Acquire IntraUnit Entries (CM_IU_ACCTG)	This PeopleSoft Application Engine process calls the IU_PROCESSOR process which in turn creates balancing entries for intraunit transactions in the CM_ACCTG_LINE table. If commitment control is turned on for PeopleSoft Inventory, then the accounting entry must pass budget checking successfully before ChartField balancing is done. This process picks up any row with a status of <i>N</i> (not balanced) or <i>E</i> (error) in the CM_IU_STATUS field and attempts to create the balancing entries. The results are stored back in the CM_ACCTG_LINE table with a status of <i>B</i> (balanced), <i>X</i> (balancing not required), or <i>E</i> (error).

Once the Accounting Line Creation process completes the preceding steps, the process verifies that the accounting entries were created for the debit and credit sets without error and the budget checking and ChartField balancing have been successfully completed or not required. The process then changes the GL_DISTRIB_STATUS of the transaction to *N* (none). With an *N* status, the transaction can now be picked up from the CM_ACCTG_LINE table by the Journal Generator process and sent to the general ledger system.

Numbering Sequence of the Accounting Lines

Within the Accounting Line Creation process, a substantial reduction in processing time can be achieved by using set-based processing to number the lines of the newly-created accounting entries. As delivered, the system uses row-by-row processing to create the sequential accounting line numbers. By performing additional set up steps you can switch from row-based processing to set-based processing to generate the line numbers. The set-based approach is optional. The delivered default option is the row-by-row approach.

Using the set-based processing method to generate the sequential accounting line number is significantly faster than row-based processing. However, set-based processing can produce gaps in numbering. For example, within one accounting entry with four lines, the lines can be numbered 1, 5, 6, and 11, rather than 1, 2, 3, and 4.

Related Links

[Selecting the Method to Number Accounting Lines](#)

Creating Accounting Lines

The Accounting Line Creation process retrieves costed transactions and finds the ChartFields to use for the debit and credit lines of each accounting entry. The results are stored in the CM_ACCTG_LINE table. The process always uses the date and time of the transaction and not the transaction date that was entered. Accounting entries can be manually back dated using the Edit Unposted Accounting Lines page.

The Accounting Line Creation process searches for the correct ChartField information to build the accounting entry lines. The system searches for the ChartFields based on this logic starting with the first step and continuing until a match is found:

1. If the transaction is an interunit transfer of inventory stock, then the ChartFields to define the intransit account, interunit receivables, and interunit payables balancing entries are derived from the method that you selected for interunit accounting.

The other parts of the accounting entries are derived from these pages.

2. If location accounting is used for the storage areas or production areas, the system first searches for the correct Storage Area Accounting page or Production Area Accounts page.

When the entries on these pages match the same key fields on the transaction, then the correct ChartFields are found to build the accounting entry. Often, these pages define just one side of the accounting entry and the other side is derived from the Accounting Rules page or the interunit transfer method. The system searches for the page by starting with the first rule and continuing until a match is found:

Rule	Unit	Area	Cost Element
1	Business Unit	Storage Area or Production Area	Cost Element
2	Business Unit	Storage Area or Production Area	Blank

3. The Accounting Line Creation process uses the Accounting Rules page (Account Distribution page) with the most specific information matching the transaction. There are some situations where more than one Accounting Rules page can match the transaction. In this case, the search for the correct Accounting Rules page uses the logic in this table starting with the first rule and going through all twelve rules. The system uses the first rule encountered that matches the transaction.

Rule	Unit	Trans Group	Item ID	Item Group	Distrib Type	Cost Element
1	Business Unit	Transaction Group	Item ID	Blank	Distribution Type	Cost Element
2	Business Unit	Transaction Group	Item ID	Blank	Distribution Type	Blank
3	Business Unit	Transaction Group	Item ID	Blank	Blank	Cost Element
4	Business Unit	Transaction Group	Item ID	Blank	Blank	Blank
5	Business Unit	Transaction Group	Blank	Item Group	Distribution Type	Cost Element

<i>Rule</i>	<i>Unit</i>	<i>Trans Group</i>	<i>Item ID</i>	<i>Item Group</i>	<i>Distrib Type</i>	<i>Cost Element</i>
6	Business Unit	Transaction Group	Blank	Item Group	Distribution Type	Blank
7	Business Unit	Transaction Group	Blank	Item Group	Blank	Cost Element
8	Business Unit	Transaction Group	Blank	Item Group	Blank	Blank
9	Business Unit	Transaction Group	Blank	Blank	Distribution Type	Cost Element
10	Business Unit	Transaction Group	Blank	Blank	Distribution Type	Blank
11	Business Unit	Transaction Group	Blank	Blank	Blank	Cost Element
12	Business Unit	Transaction Group	Blank	Blank	Blank	Blank

- ChartFields entered directly on the transaction override these rules. Often, this is just one side of the accounting entry.

Note: If the accounting pages have not been defined correctly, then the effected transactions are written to the error table. To view any errors occurring in the CM_ACCTG process, use the Accounting Line Errors page.

Related Links

[Understanding the Types of Interunit Transfers](#)

[Understanding the Accounting Structure](#)

"Understanding Stock Transfers Between Business Units" (PeopleSoft Inventory)

Using Commitment Control

Commitment control enables you to check expenditures against a predefined budget. In PeopleSoft Cost Management, these expenditures typically occur when you expense inventory material to a department or expense account. Commitment control considers actual expenditures and imminent future obligations (encumbrances and pre-encumbrances). The option to use commitment control must be selected at both the installation and ledger group level. In multibook environments, only the primary ledger transactions should be checked against control budgets.

Note: Commitment control does not apply budget checking to manufacturing transactions.

If you are using commitment control, the accounting entries must pass budget checking before you can pass them to the general ledger system using the Journal Generator process. If you select the **Budget Check Accounting Lines** check box on the Accounting Line Creation process page, then the Commitment Control Processor process runs on the accounting lines in the CM_ACCTG_LINE table with a BUDGET_LINE_STATUS of *N* (not budget checked) or *E* (error in budget check). Once the line passes budget checking, the status changes to *V* (valid budget check). Entries that do not pass budget checking appear on the CM Transaction Exceptions - Header Exceptions page, where you can resolve the error status by adjusting or redirecting charges to alternate accounts or changing budget periods for the transactions if authorized to do so.

Note: The Budget Processor process (FSBKBDP3) considers all of the accounting lines in a transaction set together. If one accounting line fails the budget check, the Budget Processor process rejects the entire transaction set.

Commitment Control Statuses

The header of the transaction can have these statuses in the **BUDGET_HDR_STATUS** field:

Status	Description
<i>N</i>	Not budget-checked.
<i>E</i>	Error: The transaction fails budget checking and does not update the control budget.
<i>V</i>	Valid: The transaction passes budget checking with no errors or warnings and updates the control budget. If commitment control is turned off, all transaction lines are set to <i>V</i> .

The transaction line can have these statuses in the **BUDGET_LINE_STATUS** field:

Status	Description
<i>N</i>	Not budget checked.
<i>E</i>	Error: The transaction line fails budget checking and does not update the control budget.
<i>W</i>	Warning: The transaction line completes budget checking successfully, but the transactions have warning exceptions. The transaction updates the control budget. The warnings can range from an overridden error to mismatched budget and accounting dates. It issues a warning if the transaction is over the budget amount but less than the tolerance amount.

Status	Description
<i>V</i>	Valid: The transaction line passes budget checking with no errors or warnings and the process creates the journal line for the control budget ledger. If commitment control is turned off, all transaction lines are set to <i>V</i> .

The statuses in the **CM_IU_INDICATOR** field tell the Commitment Control Processor process whether to pick up the line. If you use the centralized interunit and intraunit processor to create intraunit ChartField balancing entries, then these accounting lines do not need to be budget checked.

Status	Description
<i>N</i>	Not created by the central processor. This transaction is picked up by the Commitment Control Budget Processor process.
<i>Y</i>	Created by the central processor. The Commitment Control Budget Processor process is skipped. The budget statuses are set to <i>V</i> .

Related Links

"Understanding Basic Commitment Control Setup" (PeopleSoft Commitment Control)

"Understanding the Budget Checking of Source Transactions" (PeopleSoft Commitment Control)

Acquiring Intraunit Entries

Intraunit processing, or fund balancing, creates balancing entries for transfers between ChartFields (such as Fund) within the same business unit. Intraunit balancing can be performed on any ChartField within the business unit except Account. The ChartField Balancing process (CM_IU_ACCTG) compares debit and credit ChartFields (except Account) for the same item and cost element. If the ChartFields are not the same, the interunit receivable and interunit payable accounting entry is created. For example, suppose that these transactions are entered for the same item and cost element. The system is set up for intraunit balancing on the fund ChartField. The interunit receivable account is 4003 and the interunit payable account is 4002 for this transaction:

	Account	Fund	Dept ID	Program	Class	Bdgt Pd
Expense	5002	100	20	88	10	2000
Inventory	1001	200	30	99	20	2000

The Accounting Line Creation process creates this interunit receivable and interunit payable transaction:

	Account	Fund	DeptID	Program	Class	Bdgt Pd
Offsetting Inventory	4003	200	30	99	20	2000
Offsetting Expense	4002	100	20	88	10	2000

Set up the PeopleSoft system to use intraunit accounting. If you are using intraunit ChartField balancing, you must balance the intraunit accounting entries before you can pass them to the general ledger system using the Journal Generator process. If you are also using commitment control, the accounting entries must pass budget checking before they are available to perform ChartField balancing.

To perform ChartField balancing using the Accounting Line Creation process, select the **Acquire IntraUnit Entries** check box on the Accounting Line Creation process page. This check box is selected by default. The Intraunit Balancing process runs on the accounting lines in the CM_ACCTG_LINE table with a BUDGET_LINE_STATUS of *V* and a CM_IU_STATUS of *N* (not balanced), or *E* (error). Once the intraunit transaction has been balanced successfully, the CM_IU_STATUS changes to *B* (balanced) or to *X* (balancing not required). Entries that could not be balanced are given the status of *E* (error) and appear on the Edit Unposted Accounting Lines page where you can resolve the error status.

Note: On the intraunit transaction, if the ChartField that you are balancing on changes after the ChartField Balancing process, then the system resets the CM_IU_STATUS to *N* (not balanced) and the transaction must be rerun by the ChartField Balancing process.

Intraunit ChartField Balancing Statuses

The transaction can have these statuses in the CM_IU_STATUS field:

Status	Description
<i>N</i>	Not balanced
<i>B</i>	Balanced
<i>P</i>	In process
<i>E</i>	Error
<i>I</i>	Ignore. The line is not an intraunit transaction.
<i>X</i>	Balancing not required.
<i>S</i>	Staged

Status	Description
<i>H</i>	Hold for other business unit affiliates.

Related Links

"Understanding PeopleSoft Interunit and Intraunit Functionality" (Application Fundamentals)

Setting the General Ledger Distribution Status

The Set GL Distrib Status (general ledger distribution status) process in the Accounting Line Creation job insures that the accounting entries are not passed to the general ledger system until they are complete. The process also updates the status of accounting entries as they are picked up and used by the Journal Generator process. All rows that have a budget check status of *V* (valid) and an intraunit ChartField balancing status of *B*, *I*, or *X* will have their GL Distrib Status (general ledger distribution) set to *N* (ready).

GL Distribution Statuses

The transactions can have these statuses in the **GL_DISTRIB_STATUS** field:

Status	Description
<i>D</i>	Distributed. The entries are posted to the general ledger system. They no longer appear on the Edit Unposted Accounting Lines page.
<i>H</i>	Hold. These lines are not yet ready to be picked up by the Journal Generator.
<i>N</i>	None; not yet processed. The accounting entries are created without error and (if applicable) the budget checking and ChartField balancing complete successfully. The Journal Generator process can now pick up the entries.

Creating Transaction Costs and Accounting Entries Processes

The Cost Accounting Creation process is an application engine process that can launch both the Transaction Costing process and the Accounting Line Creation process.

Page Used to Create Transaction Costs and Accounting Entries

<i>Page Name</i>	<i>Definition Name</i>	<i>Usage</i>
<u>Cost Accounting Creation Page</u>	CM_ACCTG_REQ	Calculates the cost of transactions that have not yet been costed and then creates accounting entry lines for these costed transactions.

Cost Accounting Creation Page

Use the Cost Accounting Creation page (CM_ACCTG_REQ) to calculates the cost of transactions that have not yet been costed and then creates accounting entry lines for these costed transactions.

Navigation:

Cost Accounting > Inventory and Mfg Accounting > Create Accounting Entries > Cost Accounting Creation

This example illustrates the fields and controls on the Cost Accounting Creation process page. You can find definitions for the fields and controls later on this page.

The screenshot shows the 'Cost Accounting Creation' interface with the following sections:

- Process Request Parameters:**
 - Process Frequency: Process Once, Always Process, Don't Run
 - *Request ID: CREATION
 - Description: [Empty field]
 - As of Date: 08/08/2009
 - Generate Table Statistics
 - Generate Temp Table Statistics
- Cost Inventory Transactions:**
 - Cost Inventory Transactions (Cost Mode: Regular)
 - Calculate Actual Prdn Costs
 - Apply Perpetual Average Adjs
 - Resolve Negative Inventory (Commit Limit: [Empty field])
- Coalesced Selection Table:**

*Business Unit	*Book Name	IFRS Reporting	Location Accounting		
US008	FIN	<input type="checkbox"/>	<input checked="" type="checkbox"/>	+	-
US008	FIN	<input type="checkbox"/>	<input checked="" type="checkbox"/>	+	-
US008	FIN	<input type="checkbox"/>	<input checked="" type="checkbox"/>	+	-
- Create Accounting Lines:**
 - Create Accounting Lines
 - All Transaction Groups
 - Acquire IntraUnit Entries

Field or Control	Description
Generate Table Statistics	<p>(Database administration) This check box enables database administrators to control whether or not this process should issue basic table statistics update commands to the database for the tables accessed by this process. The Cost Accounting Creation process is structured to delete temporary working data at the beginning of the process, before that deletion step, accurate table statistics can be generated.</p> <p>Database platforms keep statistics about the distribution of the key values in each index and use these statistics to determine which indexes to use in query processing. Cost-based query optimization depends on the accuracy of the distribution statistics. Table statistics should be updated whenever a large amount of data in an indexed column has been added, changed, or removed (that is, if the distribution of key values has changed). The update table statistics option gives database administrators an added tool for maintaining table statistics for query optimization; however, sites that already have database administration procedures in place for periodically updating table statistics might want to deselect this option.</p>
Generate Temp Table Statistics	<p>The Cost Accounting Creation process stores some of its temporary working data in dedicated temporary tables. This check box is defaulted to make it easier for database administrators to generate accurate table statistics for these types of tables.</p>
As of Date	<p>The process selects all unprocessed lines with a transaction date less than or equal to this date.</p>

Cost Inventory Transactions group box

This section contains the parameters used by the Transaction Costing process.

Field or Control	Description
Cost Inventory Transactions	<p>Select to have the cost calculated for all uncosted inventory transactions using the Transaction Costing process (application engine program CM_COSTING).</p>

Field or Control	Description
Cost Mode	<p>Values are:</p> <p><i>Regular:</i> Costing is for uncosted transactions occurring in the period ending up to the <i>As of Date</i>. Regular mode can be used at anytime during the period and at period end. When you run this process in regular mode, all transactions are costed, regardless of the Hold for Final Cost check box for the cost book.</p> <p><i>Mid-Period:</i> Costing is for uncosted transactions occurring in the partial period ending on the as of date. The Mid-Period value postpones certain types of calculations if final costs are not yet available, for example, purchased items when the invoice has not yet been received or production that are not yet completed. If the profile for the book is marked as Hold for Final Cost, receipt and depletion records are not costed unless the invoice price is available (for purchased items) or the production ID or production schedule is complete (for makeable items). Periodic averages and retroactive perpetual averages are not calculated in this mode.</p>
Calculate Actual Prdn Costs	<p>Select to calculate the actual production costs of an item. This check box calls the application engine program CE_ACTCST_CR (actual cost of manufacturing process).</p>
Apply Perpetual Average Adjs	<p>Select to update the perpetual average costs to include the difference between the purchase price and the voucher, including exchange rate differences. This applies to the perpetual average costing method as defined on the cost profile. Select this check box to create adjustments to the perpetual weighted average costs in both the <i>Mid-Period</i> and <i>Regular</i> cost modes. For period end processing, select this check box if you want the perpetual average cost items to reflect the invoice price. Actual cost items are always updated once the invoice price is available. Periodic average items are not updated for cost adjustments.</p> <hr/> <p>Note: The Apply Perpetual Average Adjs check box is only applicable if you have perpetual average cost items. It does not apply to the retroactive perpetual average method.</p> <hr/>

Field or Control	Description
Resolve Negative Inventory	Select to run the Negative Inventory Resolver process to check for new receipts (putaway and adjustment transactions) and adjust the quantities and costs of previously costed negative inventory depletion transactions. The process is launched within the Transaction Costing process after receipts have been processed, but before depletions.
Commit Limit	(Optional) To manage the database resources, enter the number of rows to be processed before committing costed depletion records to the database. If this field is left blank, the system issues a commit to the database after all depletions rows have been processed.

Create Accounting Lines group box

This section contains the parameters for the Accounting Line Creation process.

Field or Control	Description
Create Accounting Lines	Select to have accounting entries generated for all costed transactions using the Create Accounting Lines process (CM_ACCTGLINE).
All Transaction Groups	Select to run this process for all transaction groups or enter specific transaction groups in the Transaction Group section. Selecting this check box erases any entries that you have made in the Transaction Group section.
Budget Check Accounting Lines	Select to run the Commitment Control Budget Processor process (the GL Budget check process BP_PROC). If you have not turned on commitment control for the PeopleSoft system, this check box is unavailable.

Field or Control	Description
Acquire IntraUnit Entries	<p>Select to run the Acquire IntraUnit Entries process (CM_IU_ACCTG) which launches the IU_PROCESSOR process. This check box is unavailable if intraunit processing is not enabled for the PeopleSoft system. The IU_PROCESSOR process creates intraunit balancing entries for all applicable transactions in the specified business unit and book. All transaction groups are processed regardless of the entries on this page.</p> <hr/> <p>Note: If the Budget Check Accounting Lines check box is available, you should not select the Create Accounting Lines check box and the Acquire IntraUnit Entries check box only, because budget checking is required before intraunit ChartField balancing can be performed. By default, all three check boxes are selected when available.</p> <hr/>
Transaction Group	Enter specific transaction groups to be processed. Use the Insert Row button to add additional transaction groups.
Accounting Line Errors	Click to access the Accounting Line Errors page, where you can view any errors generated by the Accounting Line Creation process. This page displays accounting lines that could not be processed because of missing accounting line creation rules.

See [Creating Accounting Entries](#).

Coalesced Selection group box

Specify one or many business unit and cost book combinations on each request in the **Coalesced Selection** group box. All the business units in one request are processed together as one set to take advantage of set-based relational database performance on sets of data. Define the same parameters for all business units within one request or add multiple requests to define different parameters for each request.

Use the **Insert Row** button within the **Coalesced Selection** group box to add as many business units and cost books as needed to one request.

To create multiple sets that process one at a time, create multiple process requests on the same process page by using the **Insert Row** button just below the Process Request Parameters bar (far upper right of page). Depending on your environment, multiple sets could take longer to process than one set. Each request will be run sequentially.

The system displays the business unit setting for Location Accounting.

Note: Within one process request, all the business units must have the same setting for location accounting. A warning message displays if there is a mismatch.

Related Links

[Cost Profiles Page](#)

Reviewing and Changing Item Costing and Accounting Entries

PeopleSoft Cost Management provides several interactive pages to help you analyze, compare, and review the item costs generated in a manufacturing or distribution environment. You can monitor the transactions as they are processed through the Transaction Costing, Accounting Line Creation, and Journal Generator processes. In a manufacturing environment, you can analyze the production costs at every stage of the production ID, enabling you to identify cost fluctuations early in the process.

This section discusses how to review the inventory transactions as they flow through the accounting system.

Reviewing Item Setup

PeopleSoft provides you with inquiry pages to help you review the costing status of an item. Use the:

- Item Cost Inquiry component to review every part of an item's costing definition.

This ten page component provides information about how the item is set up for costing within the business unit.
- Inventory On Hand page to identify the basic costing setup for an item and the current quantity on hand.

Monitoring the Costing Flow

PeopleSoft provides inquiry pages to enable you to monitor the transactions at each stage as they flow through the accounting processes of the Transaction Costing, Accounting Line Creation, and Journal Generator processes.

- The Message Log inquiry page checks for the successful completion of all processes, including the Transaction Costing, Accounting Line Creation, and Journal Generator processes.
- The Cost Tolerance Control page identifies possible cost errors for all transactions that have completed the Transaction Costing process.
- The Pending Transactions page identifies the number of transactions at each stage of the costing flow.

Predefined queries give detailed transaction information about each area.

- The Insufficient Qty Tool (insufficient quantity tool) page identifies depletion transactions (in environments using the negative inventory feature) where accounting entries are not created due to insufficient quantity.

Comparing and Analyzing Manufacturing Costs

PeopleSoft Cost Management enables you to monitor the costing of items produced in PeopleSoft Manufacturing for all types of costing (frozen standard, actual, and average costing methods). Use the:

- Actual Cost Inquiry page to review the actual costs of production for a manufactured item.

Costs are broken down by business unit, item ID, operation sequence, cost category, production conversion codes, and other criteria.

- Proactive Production Cost - PID Cost to take a snapshot of the production costs at any stage in the production process.

Then, these captured costs can be compared and analyzed using the Compare Cost Measures component.

- Compare Cost Measures component to identify costing flow issues by comparing the production costs at various stages for production for a single production ID or production schedule.
- Pending Transactions page to identify the number of production completions that have been putaway in inventory, partially or completely, and the number of production completions that have not been costed by Transaction Costing process.

Predefined queries give detailed transaction information about each area.

Verifying the Creation of Accounting Entries

Once you generate accounting entries using the Accounting Line Creation process, you can review or change the entries before they are picked up by the Journal Generator process for posting in the general ledger.

Use the:

- Accounting Line Errors page, the Edit Unposted Accounting Lines page, and the Detail Accounting page to review and change accounting entries.
- From the Edit Unposted Accounting Lines page, you can link to the Change Accounting Date page to redirect the accounting entry to an earlier accounting period by changing the accounting date of the transaction before it is sent to the general ledger.
- Pending Transactions page, Unposted Accounting Lines page, Posted Accounting Line page, and the Accounting Entries page to inquire about the accounting entries.

Verifying Your Entries Passed Budget Checking

If you are using commitment control, the accounting entries must pass budget checking before you can pass them to the general ledger system using the Journal Generator process. Entries that do not pass budget checking appear on the CM Transaction Exceptions component, where you can determine the action necessary to resolve the error. The Pending Transactions page also has a query for transactions not posted to the general ledger that identifies the transaction's budget checking status. If you change a line that has already been budget checked, the budget status is set to *N*, and the line must run through budget checking again.

Verifying Your Entries Passed ChartField Balancing

If you are using intraunit ChartField balancing, the intraunit accounting entries must be balanced before passing them to the general ledger system using the Journal Generator process. Also, if you are using commitment control, the accounting entries must pass budget checking before they are available to perform ChartField balancing. The system assigns an error status to entries that cannot be balanced. They appear on the Edit Unposted Accounting Lines page, where you can resolve the problem. The

Pending Transactions page also has a query for transactions not posted to the general ledger that identifies the transaction's status. When the accounting entries have successfully passed the Intraunit ChartField Balancing process, you can no longer change the interunit receivables and payables accounting lines.

Note: If you use commitment control and intraunit accounting (fund accounting), budget checking and intraunit ChartField balancing must be completed successfully before the accounting entries can be passed to the general ledger system. Once the accounting entries have been processed by the Journal Generator, you can no longer change any information on the accounting entries.

Using Reports

Use the Accounting Register report and the Transaction Register report to review both transaction costing and accounting entries.

Pages Used to Review and Change Item Costing and Accounting Entries

<i>Page Name</i>	<i>Definition Name</i>	<i>Usage</i>
Item Cost Inquiry - General: Common Page	CM_INQ_GEN	View general cost information about any item within the business unit, including default cost element, standard cost group, book names, cost profiles, default actual cost, current purchase cost, last price paid, and quantity on hand.
Item Cost Inquiry - General: Transfer Costs Page	CM_INQ_XFER	Displays transfer information about the item within the business unit. Also displays the item's transfer price or markup percentage. Information for the item appears by default in the Default Unit Transfer Attributes section. Planning attributes appear as defined at the business unit and item level.
Item Cost Inquiry - General: Supplier Costs Page	CM_INQ_VNDR	Displays the vendors defined for this item on the Purchasing Attributes - Item Supplier component, including supplier ID, supplier location, unit of measure (UOM), currency, minimum order quantity, supplier price and effective date of the price.
Item Cost Inquiry - General: Additional Costs Page	CM_INQ_ADD	Displays any additional costs added to the item using the Additional Item Costs page. Also displays the cost type, cost version, cost element, application method, and expense rate or percentage defined for the item and business unit.

Page Name	Definition Name	Usage
Item Cost Inquiry - General: Pricing Info Page	CM_INQ_PRC	Displays pricing information for this item as defined in PeopleSoft Order Management, including product ID, list price, and any price lists for this item.
Item Cost Inquiry - Standard Page	CM_INQ_STD	Displays the current frozen standard costs for this item in this business unit. These standard costs are broken down by cost element and level. The standard costs are determined by the Cost Rollup process and applied to the production environment using the Update Production process.
Prod'n/Standard Cost Detail Page	CM_PROD_COST_DET	Displays the detailed costs maintained by component ID and operation sequence.
Item Cost Inquiry - Actual Page	CM_INQ_ACT	Displays information about the item's actual costs with this business unit. The deplete cost method (from the cost profile) is identified for each book set up for this item. The item's cost history appears along with every receipt number with unit cost, supplier, the source of the receipt, and the storage area where the item was received.
Item Cost Inquiry - Perpetual Avg Page	CM_INQ_PERP	Displays the computed perpetual weighted average for this item within this business unit. The date and time of the computation also appears. Perpetual averages are calculated with each putaway of the item.
Item Cost Inquiry - Retroactive Avg Page	CM_INQ_PERR	If retroactive perpetual averaging is used for this item within this business unit, then this inquiry page displays the item's perpetual weighted average and the date and time to which it is applied. Retroactive perpetual averages are applied when you run the Transaction Costing process (within the Cost Accounting Creation process) in the <i>regular Cost Mode</i> . Multiple averages are computed and applied for each putaway.

Page Name	Definition Name	Usage
Item Cost Inquiry - Periodic Avg Page	CM_INQ_PERD	Displays the periodic weighted averages for this item within this business unit and the date and time it was applied. Periodic weighted averages are applied when you run the Transaction Costing process (within the Cost Accounting Creation process) in the <i>regular Cost Mode</i> and are applied to all putaways in the period.
Inventory On Hand Page	CM_OH_INQUIRY	View the accounting profile and current on-hand quantity for any item within a business unit. Also displays the item's book names, costing methods, on-hand quantity, and the value of the on-hand quantity.
On Hand by Receipt Line Page	CM_RCPT_LINEDET_SP	View the quantity available and its value according to the storage location for the business unit, item ID, and book name. This inquiry page also displays the receipt and deplete quantities. Click the column heading to sort the data in ascending order based on the column.
<u>Cost Tolerance Control Page</u>	CM_CTC_INQ	Review costed inventory transactions for possible costing errors based on user-defined tolerance levels. To be viewed on this inquiry, the transactions must have successfully completed the Transaction Costing process of the Cost Accounting Creation process.
Message Log Page	MESSAGE_LOG	Find any messages created during the Transaction Costing, Accounting Line Creation and Journal Generator processes.
<u>Pending Transactions Page</u>	CM_NPOSTED	View inventory accounting transactions that have not yet been posted to PeopleSoft General Ledger. This inquiry page enables you to monitor transactions before and after the Transaction Costing and Accounting Line Creation processes. Click the Details links to view current transaction information generated by predefined queries. This page also provides links to the Accounting Line Errors page and the Query Viewer.

Page Name	Definition Name	Usage
<u>Insufficient Qty Tool (insufficient quantity tool) Page</u>	RUN_CM_NEG_INV	This PeopleSoft Application Engine program, (CM_NEG_INV), provides you with a query of the accounting line entries that would be generated for those transactions held back in CM_DEPLETIONS due to insufficient quantities.
Actual Cost Inquiry Page	CM_ACTUALCOST_INQ	(Manufacturing environment only) For makeable items, you can view the actual cost of production based on the production ID or the combination of production area and item ID. Also displays the actual costs of production broken down by operation sequence, cost category, and conversion code. The production status, item ID, book name, and completed quantity also appear. The actual costs are calculated by the Transaction Costing process within the Cost Accounting Creation process.
Proactive Production Cost - PID Cost Page	CE_PRDNID_COSTING	For makeable items, this page provides advanced proactive visibility into the costing of a production ID during each phase of production. You can save the current costs under a cost measure type for reviewing and comparing on the Compare Cost Measure component.
Primary Products & Co-Product Cost Page	CE_OUTPUT_COST_SEC	View the projected costs for the primary product and co-products of this production ID.
Compare Cost Measures - Output Analysis Page	CE_COST_ANALYTICS	Review and compare the cost calculations for the output from a production ID (products, co-products, and so on) at various stages of production. Cost comparisons can include the production ID as planned, as produced, the frozen standard costs, the actual production costs, or other stages of production.
Compare Cost Measures - Input Analysis Page	CE_COST_ANALYTICS2	Review and compare the cost calculations for the input into a production ID (components, direct, and indirect costs) at various stages of production. Cost comparisons can include the production ID as planned, as produced, the frozen standard costs, the actual production costs, or other stages of production.

Page Name	Definition Name	Usage
Sequences for the Cost Measure Page	CE_COST_MEASUR_SEC	Select the sequence number for viewing costs for this business unit, production ID, and item ID combination.
Accounting Line Errors Page	CM_ACCTG_LN_ERR	Find any accounting lines that could not be created because of missing accounting rules.
<u>Edit Unposted Accounting Lines Page</u>	CM_ACCTG_LN_UNPOST	After you run the Accounting Line Creation process, use this page to review and make changes to the accounting entry line information for a transaction prior to generating journal entries. For any transaction, you can correct the ChartFields and also change the accounting date. For example, you can adjust or redirect charges to other accounts, change the budget period for the transaction, or redirect the entry to a prior accounting period.
Change Accounting Date Page	CM_ACCTG_UNPST_TRX	Enables you to redirect an accounting entry to an earlier accounting period by changing the accounting date of the transaction before it is sent to the general ledger system. The system displays all the debit and credit lines for the selected accounting entry. Enter the new date in the Accounting Date field and click the OK button to change the accounting date for this transaction. If commitment control is enabled, you cannot change the transaction if any line has passed budget checking.
Unposted to GL Page	CM_DRILL_UNPST_DET	View accounting entries that have not yet been picked up by the Journal Generator process for posting to the general ledger system. ChartField security can be applied to this page.
Posted Accounting Lines Page	CM_DRILL_JRNL_DET	View accounting entries that have already been picked up by the Journal Generator process for posting to the general ledger system. ChartField security can be applied to this page.

Page Name	Definition Name	Usage
Accounting Entries Page	CM_ACCTG_LINE	View accounting entries, by entering the search criteria and click the Refresh button. Displays the both the debit and credit sides of the accounting entry and the complete ChartField combinations. ChartField security can be applied to this page.
<u>CM Transaction Exceptions - Header Exceptions Page</u>	KK_XCP_HDR_CM1	View budget checking errors or warning messages for PeopleSoft Cost Management transactions. Users who have authority can override the budget exceptions on this page.
Cost Management Line Drill Down Page	KK_DRL_CM1_SEC	View line details for PeopleSoft Cost Management transactions with budget exceptions.
CM Transaction Exceptions - Line Exceptions Page	KK_XCP_LN_CM1	View individual lines in transactions with budget checking errors or warning messages.

Related Links

[PeopleSoft Cost Management Reports: A to Z](#)

Cost Tolerance Control Page

Use the Cost Tolerance Control page (CM_CTC_INQ) to review costed inventory transactions for possible costing errors based on user-defined tolerance levels.

To be viewed on this inquiry, the transactions must have successfully completed the Transaction Costing process of the Cost Accounting Creation process.

Navigation:

Cost Accounting > Item Costs > Review Costs > Cost Tolerance Control

This example illustrates the fields and controls on the Cost Tolerance Control page. You can find definitions for the fields and controls later on this page.

Cost Tolerance Control

*Business Unit

*Book Name

*From Date

*To Date

Item Options

Item Selection

All
 Single
 Cost Group

Item ID

Std Cost Group

Specify Acceptable Cost Tolerance:

% Under

% Over

And

Threshold

Results

Receipts that exceed Cost Tol.	0
--------------------------------	---

Go To: [Query Viewer](#)

PeopleSoft Cost Management receives transactions from a variety of sources. The Cost Tolerance Control page helps you to monitor transactions flowing into your cost management system and identifies possible cost errors from any of the sources of incoming inventory. Use the inquiry page to view costed inventory transactions that exceed your cost tolerance parameters. The inquiry results can be viewed on screen or downloaded into a spreadsheet such as Microsoft Excel for further analysis.

In order to be evaluated by this inquiry, an inventory transaction must have successfully completed the Transaction Costing process of the Cost Accounting Creation process.

Search Criteria

Enter your search criteria to select the inventory transactions to be examined for cost tolerance exceptions. Your search criteria determine the sample population to be used.

<i>Field or Control</i>	<i>Description</i>
Business Unit	(Required) Enter the PeopleSoft Inventory business unit.
Book Name	(Required) Enter the name of the cost book used.

Field or Control	Description
From Date and To Date	(Required) Enter a date range for the transaction date. The default range is from 01/01/1900 to the current system date.
All Items	Select to include all items within the business unit and cost book.
Single Item	Select to run this inquiry only for transactions with the item identified in the Item ID field.
Standard Cost Group	Select to run this inquiry only for a specific standard cost group defined in the Std Cost Group field. Standard cost groups, or cost groups, enable you to group together a set of items using the Define Business Unit Item -General: Common page. Inventory transactions with items included in the defined cost group are included in this search.

Cost Tolerances and Searching

To qualify as an exception, a transaction must exceed either the **% Under** or **% Over** tolerance and also exceed the Threshold tolerance. Cost tolerances are:

Field or Control	Description
% Under	<p>Enter a percentage of the average cost. If an individual transaction is less than this percentage of the average cost of the sample then it is tagged as a possible exception.</p> <p>For example, if the average cost in the sample for business unit US008/cost book FIN/item ID 10001 is 100 USD and the % Under value is 10 percent, then any transaction with an item cost of less than 90 USD is a possible exception.</p> <p>This field must be less than 100 percent. The default value is zero percent.</p>
% Over	<p>Enter a percentage of the average cost. If an individual transaction is greater than this percentage of the average cost of the sample then it is tagged as a possible exception.</p> <p>For example, if the average cost in the sample for business unit US008/cost book FIN/item ID 10001 is 100 USD and the % Over value is 15 percent, then any transaction with an item cost of greater than 115 USD is a possible exception.</p> <p>The default value is 100 percent.</p>

Field or Control	Description
Threshold	<p>Enter the amount that the costed inventory transaction must fluctuate from the average cost. If any individual transaction differs from the average cost of the sample by more or less than this amount, then the transaction is a possible exception.</p> <p>For example, if the average cost in the sample for business unit US008/cost book FIN/item ID 10001 is 100 USD and the Threshold value is 25 USD, then any transaction with an item cost of greater than 125 USD or less than 75 USD is a possible exception. This cost tolerance is useful if you wish to prevent small value items from appearing as exceptions.</p> <p>The default value for this field is zero.</p>

Click the **Search** button to identify transactions that exceed your cost tolerance parameters. The exception transactions are based on the following calculation:

1. Based on the business unit, book, date range, and item selection entered on this page, the system finds all costed inventory transactions that meet these parameters and creates a sample population.
2. An average cost is calculated for each business unit/cost book/item ID combination based on the sample population.

Note: This average cost could differ from the average cost used in PeopleSoft Cost Management transactions since the search criteria on this page could limit the number of transactions used.

3. Each individual transaction in the sample population is then compared to the average cost of the sample for the business unit/cost book/item combination using the cost tolerances to find exceptions. Remember, to qualify as an exception, a transaction must exceed either the % Under or % Over tolerance and also exceed the Threshold tolerance.

Viewing Search Results

Field or Control	Description
Receipts that exceed Cost Tol	Identifies the number of rows found by the search that exceed the defined cost tolerances. If too many or too few inventory transactions are found, the user can change the search criteria and cost tolerances then launch another search.
Details	Select this link to access the results of the query. This link becomes available only when search results are found.
Query Viewer	Use this link to access the Query Viewer where you can run queries or schedule them to run at a later time.

Click the **Details** link to access the query results:

This example illustrates the fields and controls on the Viewing results online (part 1 of 2). You can find definitions for the fields and controls later on this page.

CM_CTC_INQ- Cost Tolerance Inquiry														
Download results in : Excel Spreadsheet CSV Text File XML File (26 kb)														
View All														
	Unit	Book Name	Item	Dt Tmstamp	Number	Cost Source	Unit Cost	Avg Unit Cost	Cost Difference	Currency	% Difference	Qty Rcvd	Extended Cost	Extended Avg Cost
1	US010	FIN01	10000	12/20/2002 1:11:30PM	1 2	0.0000	15.2491	-15.2491	USD	-100.0000	5000.0000	0.0000	76245.5000	
2	US010	FIN01	10000	11/06/2002 11:03:04AM	1 2	25.0000	15.2491	9.7509	USD	63.9441	2947.0000	73675.0000	44939.0977	
3	US010	FIN01	10000	08/09/2000 2:08:05PM	1 2	20.0000	15.2491	4.7509	USD	31.1552	10000.0000	200000.0000	152491.0000	
4	US010	FIN01	10005	08/02/2000 2:04:39PM	1 1	35.0000	0.9367	34.0633	USD	3636.5218	110.0000	3850.0000	103.0370	
5	US010	FIN01	10006	12/20/2002 7:04:55PM	1 2	0.0000	1.7544	-1.7544	USD	-100.0000	1000.0000	0.0000	1754.4000	

This example illustrates the fields and controls on the Viewing results online (part 2 of 2). You can find definitions for the fields and controls later on this page.

BU Recv	Receipt No	Receipt Line	Seq	Distribution Li	Cost Adj Type	Supplier	Src BU	Area	Serial ID	Lot ID	Trn Source	Prdn ID	Std Cost Group
US010	RCV00283	1	0	0 0				AREA2	NONE	NONE	IN		
US010	RCV00243	1	0	0 0				AREA2	NONE	NONE	IN		
US010	RCV00227	1	0	0 0				AREA1	NONE	NONE	IN		
US001	0000000012	4	1	1 0		SCM0000003	US001	AREA2	NONE	NONE	PO		
US010	RCV00290	3	0	0 0				AREA2	NONE	NONE	IN		

Values displayed include:

Field or Control	Description
Unit Cost	The unit cost of the individual transaction that has exceeded the cost tolerance parameters.
Avg Unit Cost	The average unit cost of the sample population.
Cost Difference	"Unit Cost" - "Avg Unit Cost"
% Difference	("Unit Cost" - "Avg Unit Cost") / "Avg Unit Cost" * 100

<i>Field or Control</i>	<i>Description</i>
Extended Cost	"Unit Cost" * "Qty Rcvd"
Extended Avg Cost	"Avg Unit Cost" * "Qty Rcvd"

Costs are viewed with four decimal places; however, the intermediate calculations and comparisons utilize the full precision values available.

Pending Transactions Page

Use the Pending Transactions page (CM_NPOSTED) to view inventory accounting transactions that have not yet been posted to PeopleSoft General Ledger.

This inquiry page enables you to monitor transactions before and after the Transaction Costing and Accounting Line Creation processes. Click the Details links to view current transaction information generated by predefined queries. This page also provides links to the Accounting Line Errors page and the Query Viewer.

Navigation:

Cost Accounting > Inventory and Mfg Accounting > Analyze Inventory Accounting > View Pending Cost Transactions

This example illustrates the fields and controls on the Pending Transactions page. You can find definitions for the fields and controls later on this page.

Pending Transactions

*Business Unit

*Book Name

*As Of Date

Pending Transaction Detail			
Completions Pending Putaway	23		Details
Pending Calculation Prdn Cost	0		
Transactions Not Costed	38		Details
▼ Transactions by type			
Transaction Costing Not Run	0		
Insufficient Qty for Depletion	35		
No PerpAvg Cost for Depletions	0		
Other Issues	3		
Accounting Lines not Created	10578		Details
Not Posted to General Ledger	0		

Go To: [Query Viewer](#) [Accounting Line Errors](#)

Use this inquiry page to review inventory accounting transactions that have not yet been posted to the PeopleSoft General Ledger. This inquiry enables you to monitor pending transactions in these stages of the costing flow:

- Before production completions from PeopleSoft Manufacturing have been putaway into PeopleSoft Inventory.
- Before production completions from PeopleSoft Manufacturing have been costed.
- Before the Transaction Costing process.
- Before the Accounting Line Creation process.
- Before the Journal Generator process.

Click the **Details** links to view current transaction information generated by predefined queries for each of these three stages: (TRANSACTION_INV, CM_PENDING_COSTING, CM_PENDING_ACCTG_LINE, and CM_PENDING_GL_DISTRIB). This page also provides a link to the Query Viewer, where you can run queries or schedule them to run at a later time.

Field or Control	Description
Search	Select after entering the business unit, book name, and as of date for the inventory transactions that you want to review. The system displays the number of transactions at each stage of the accounting flow.
Completions Pending Putaway	Displays the number of WIP completions and scrap from PeopleSoft Manufacturing that have been partially putaway or not yet been putaway into an inventory storage location. This query is especially useful when using actual or average costing for make items.
Pending Calculation Prdn Cost	Displays the number of production completions from PeopleSoft Manufacturing that have been putaway into inventory but not yet costed by the Transaction Costing process. There are a number of reasons why the Transaction Costing process would not have costed these transactions; for a complete list, see the <i>Generating Costs for Transaction Records</i> section of this topic. See <u>Generating Costs for Transaction Records</u> .
Transactions Not Costed	Displays the number of inventory transactions, other than production completions, that have not been processed by the Transaction Costing process. This number is further broken down into three sections in the Transactions by Type group box.
Transaction Costing Not Run	Displays the number of inventory transactions that have not been costed, because the Transaction Costing process has not been run to include them.

Field or Control	Description
<p>Insufficient Qty for Depletion (insufficient quantity for depletion)</p>	<p>Displays the number of inventory transactions that did not complete the Transaction Costing process successfully, because the inventory business unit did not have a sufficient on-hand quantity to satisfy the depletion. The stock quantity of an item may physically exist in inventory however the quantity is not yet recorded in PeopleSoft Inventory due to timing issues or entry errors. The negative inventory feature enables you to move or ship the stock that sends the item's quantity balance into negative numbers within the PeopleSoft system. You can record a negative quantity within PeopleSoft Inventory, however, you could choose not to cost a transaction based on a negative quantity. If you choose not to cost negative inventory transactions, then the Transaction Costing process holds costing the depletion transaction. Each time the Transaction Costing process is run, the depletion transactions on hold are examined to determine if there is sufficient quantity available to satisfy the depletion. Once sufficient quantity exists, the transaction is costed.</p> <hr/> <p>Note: The negative inventory feature is activated by selecting the Allow Negative Inventory check box on the Inventory Definition-Business Unit Options page. The Insufficient Qty Cost Option on the Cost Profiles page determines how the Transaction Costing process applies costing to negative inventory transactions.</p> <hr/>
<p>Other Issues</p>	<p>Displays the number of inventory transactions that did not successfully complete the Transaction Costing process due to other issues besides insufficient depletion quantity. Other issues include:</p> <ul style="list-style-type: none"> • Transactions where a cost did not exist. • Transactions waiting for voucher costs (landed costs) from PeopleSoft Payables. • Transactions that error in the process due to the detection of corrupt or invalid data coming from an interfacing system. • Transactions that will not be picked up until you run the Transaction Costing process in the <i>regular</i> Cost Mode.
<p>Accounting Lines Not Created</p>	<p>Displays the number of inventory transactions that have completed the Transaction Costing process successfully, but have not yet been processed by the Accounting Line Creation job. The costed transactions may not have completed the Accounting Line Creation job simply because you have not run the process for the business unit, book name, and as of date combination. Also, these costed transactions may not have completed the Accounting Line Creation process successfully, because the transactions are missing an accounting rule. Click the Accounting Line Errors link at the bottom of this page to view costed transactions without accounting rules. Accounting rules must be added before you can create accounting entries for costed transactions.</p>

Field or Control	Description
Not Posted to General Ledger	<p>Displays the number of inventory transactions that have completed both the Transaction Costing process and the Accounting Line Creation job successfully, but have not yet been picked up by the Journal Generator process and posted to the general ledger. There are several reasons why the accounting entries may not have been picked up and posted as journal entries:</p> <ul style="list-style-type: none"> • The Journal Generator process may not yet have been run against these accounting lines. • If you are using commitment control, the accounting lines may not have passed budget checking. The accounting line's budget status must be <i>V</i> (valid) to be processed. Click the Details link to the right of this field to run the CM_PENDING_GL_DISTRIB query which displays the budget status for the header and line of each accounting entry. • If you are using intraunit ChartField balancing, the interunit balancing process may not have been run. Select the Acquire IntraUnit Entries check box on the Accounting Line Creation job to run the Acquire IntraUnit Entries process. • The journal template may not have been defined for these accounting entries. Accounting lines are not picked up by the Journal Generator process if the journal template is not present. Click the Details link to the right of this field to run the CM_PENDING_GL_DISTRIB query, which displays the journal template for each accounting line. • The general ledger period for these transactions may be closed. Click the Details link to the right of this field to run the CM_PENDING_GL_DISTRIB query, which displays the ledger and ledger group. Verify that you are processing to an open period.

Insufficient Qty Tool (insufficient quantity tool) Page

Use the Insufficient Qty Tool (insufficient quantity tool) page (RUN_CM_NEG_INV) to this PeopleSoft Application Engine program, (CM_NEG_INV), provides you with a query of the accounting line entries that would be generated for those transactions held back in CM_DEPLETIONS due to insufficient quantities.

Navigation:

Cost Accounting > Inventory and Mfg Accounting > Analyze Inventory Accounting > Identify Insufficient Quantity

This example illustrates the fields and controls on the Insufficient Quantity Tool page. You can find definitions for the fields and controls later on this page.

This PeopleSoft Application Engine program (CM_NEG_INV) provides you with a query of the accounting line entries that would be generated for those transactions held in CM_DEPLETIONS_VW due to insufficient quantities.

The negative inventory feature is activated by selecting the **Allow Negative Inventory** check box on the Inventory Definition-Business Unit Options page. Use the Insufficient Qty Cost Option on the Cost Profile page to specify how the negative inventory feature should be applied; select *Hold* to delay costing the entire depletion transaction that drives the item quantity to a negative balance until sufficient stock is putaway to cover the depletion transaction, or select *Partial* to split the depletion transaction that drives the item quantity to a negative balance and costs part of the depletion transaction up to the currently available stock quantity. The remaining depletion transaction is held until sufficient stock is putaway.

By **Business Unit, Book, and As of Date** this process collects the rows in CM_DEPLETIONS that are held back due to insufficient quantities and creates a query displaying the accounting entries that would be generated. The system saves the information into CM_NEG_SNP2_TBL where it is keyed by process instance, business unit, transaction group, accounting date, and line number. It includes the field, **CM_ERROR_CODE**, to identify rows where an accounting entry could not be determined, because a transaction accounting rule was not found.

After you run this process click the **Query Results** link to view the results. Using the query, the results can be exported to a Microsoft Excel spreadsheet or a CSV text file.

Field or Control	Description
Run insufficient qty process	Select to run the CM_NEG_INV PeopleSoft Application Engine process to populate the CM_NEG_SNP2_TBL record with entries based on the business unit, cost book, and as of date entered on this page.

Field or Control	Description
Purge previous data	Select to purge rows from the CM_NEG_SNP2_TBL record based on the business unit, cost book, and as of date entered on this page.

Edit Unposted Accounting Lines Page

Use the Edit Unposted Accounting Lines page (CM_ACCTG_LN_UNPOST) to after you run the Accounting Line Creation process, use this page to review and make changes to the accounting entry line information for a transaction prior to generating journal entries.

For any transaction, you can correct the ChartFields and also change the accounting date. For example, you can adjust or redirect charges to other accounts, change the budget period for the transaction, or redirect the entry to a prior accounting period.

Navigation:

Cost Accounting > Inventory and Mfg Accounting > Create Accounting Entries > Edit Unposted Accounting Lines

This example illustrates the fields and controls on the Edit Unposted Accounting Lines page. You can find definitions for the fields and controls later on this page.

After you run the Accounting Line Creation process, use this page to review and make changes to the accounting entry line information for a transaction prior to generating journal entries. For any transaction, you can correct the ChartFields and also change the accounting date. For example, you can adjust or redirect charges to other accounts, change the budget period for the transaction, or redirect the entry to a previous accounting period.

Field or Control	Description
	Click the Budget Check Details button to view the budget details for the current accounting line. This button displays when commitment control is selected for PeopleSoft Inventory on the Installation Options-Products page.

ChartFields

Field or Control	Description
	Click to access the Change Accounting Date page where you can enter a new accounting date for the transaction before the Journal Generator process picks up the transaction. If commitment control is enabled, you cannot change the transaction, if any line has passed budget checking.

Line Status

Select the **Line Status** tab.

Field or Control	Description
Budget Status	Displays the transaction's budget checking status.
IntraUnit Status	If you are using intraunit accounting, the transaction's ChartField balancing status appears.
IU Balancing Entry (intraunit balancing entry)	If you are using intraunit accounting, this check box is selected if the line is an intraunit receivable or intraunit payable that balances the transaction. These lines are added by the ChartField balancing process.
GL Dist Status (general ledger distribution status)	Indicates whether or not the accounting entry has been passed to the general ledger system.
PC Status (project costing status)	Indicates whether or not the accounting entry has been passed to PeopleSoft Project Costing. Only entries coded for project costing are passed.

To view and change unposted lines:

1. Enter the business unit, transaction group, and accounting date range.

If you do not enter a date range, all unposted transactions relating to the transaction group appear. If you do not enter a transaction group, all transaction groups appear related to the business unit that you entered.

2. (Commitment control only) Enter the budget status.

Values are: *E* (error in budget check), *N* (not budget checked), and *V* (valid budget check).

3. (ChartField balancing only) Enter the IU status (intraunit ChartField balancing status).

Values are: *B* (balanced), *E* (error), *I* (ignore. The line is not an intraunit transaction), *N* (not balanced), *H* (hold for other business unit affiliates), *P* (in process), *S* (staged), and *X* (balancing not required).

4. Click the **Search** button to populate the account line information on the lower portion of the page.
5. To alter the accounting date of a transaction, click the **Change Accounting DT** button to access the Change Accounting Date page, where you can enter a new accounting date for accounting entry. If commitment control is enabled, you cannot change the transaction if any line has passed budget checking. Accounting date is determined by the transaction date, open periods, and lag days. If the transaction date is greater than the last open date, then the accounting date is set to the first date in the next open period. If the transaction date is less than the first open date it will be set to the first open date.
6. Select the **ChartFields** tab or **Line Status** tab to display information for any accounting line.
Change any incorrect data in the editable fields.
7. Click the **Budget Check Details** button, if available, at the beginning of the account line to access the Commitment Control page for that line.

Note: For any line in error, changing information on the line resets the budget status. Rerun the GL Dist Status and the Accounting Line Creation process. Balancing ChartFields will not be available in balanced rows; therefore, you cannot make changes for those ChartFields.

Related Links

[Creating Accounting Entries](#)

"Understanding the Budget Checking of Source Transactions" (PeopleSoft Commitment Control)

CM Transaction Exceptions - Header Exceptions Page

Use the CM Transaction Exceptions - Header Exceptions page (KK_XCP_HDR_CM1) to view budget checking errors or warning messages for PeopleSoft Cost Management transactions.

Users who have authority can override the budget exceptions on this page.

Navigation:

Commitment Control > Review Budget Check Exceptions > CM Transaction > Cost Management Exceptions

<i>Field or Control</i>	<i>Description</i>
Override Transaction	Select to enable the entire transaction to update the control budget, even if error exceptions exist. This option is available for Super Users with Budget Override security access only. This option is not available if the transaction passed budget checking with only warning exceptions. Select it prior to budget checking or after you run the Budget Processor process, and it returns errors.

Field or Control	Description
Inquiry Criteria	Click to access the Refine Inquiry Criteria page, where you can restrict rows to specific business units, ledger groups, and accounts. Leave these fields blank to return all values.
Budget Override Available Info	Click the Budget Override Available Info (budget override available information) button to determine why you can't override an exception for a budget.
Budget Check	Click the Budget Check button to run the Budget Processor process again after you override the transaction or a budget. Run the process again, if you changed the transaction.
Budget Check Details	Click the Budget Check Details button to access the Commitment Control page, where you can view the commitment control transaction ID, commitment control transaction date, budget checking process status, process instance, source transaction type, commitment control amount type, and budget checking header status for the transaction.
View Exception Detail	Click the View Exception Details button to access the CM Transaction Exceptions - Line Exception page, where you can view the reason for the exception for each line and navigate to line details.
Exception	Limits the rows to transactions with either <i>Error</i> or <i>Warning</i> exception. You must select an exception type.
More Budgets Exist	If selected, the transaction has more exceptions than the number that you entered in the Maximum Rows field. Enter different search criteria to shorten the list or increase the maximum number of rows.

The **Budgets with Exceptions** group box on the lower portion of the page displays all the commitment control budgets that had exceptions for the transaction. You can limit the number of budget rows the system displays by entering selection criteria.

Field or Control	Description
Override Budget	<p>Select to update the control budget ledger, even though the transaction exceeds the budget. This field is available only if the budget transaction failed budget checking and if you have authority to override a budget entry. It is not available if the source transaction type does not permit overrides and the budget header status is <i>Not Checked</i>. If the budget header status is <i>Not Checked</i>, you changed the source transaction after the Budget Processor process issues the error exceptions, and you have not run the Budget Processor process again.</p> <p>When you override the budget, the system populates the Override User ID field with the user ID for the user who overrode budget checking and the Override Date field with the date and time the budget was overridden.</p>

Note: The ChartFields that appear might not match the budget ChartFields, because the Budget Processor process translates the transaction ChartFields into the corresponding budget ChartFields using the control budget definition.

Related Links

"Viewing and Handling Budget Transaction Exceptions" (PeopleSoft Commitment Control)

"Viewing Budget Details and Transaction Activity" (PeopleSoft Commitment Control)

Costing and Accounting for Consigned Inventory

If you use the inbound consignment inventory option, a supplier can place goods at your location, but payment is not due until you sell or use the goods.

When you receive a consigned item into inventory, the quantities are tracked but no accounting is performed. The liability is not recognized until the consigned receipt is consumed. Consumption transactions and any subsequent transactions are costed and accounting entries are created. Consumption transactions for consigned items include:

- Transfer from a non-owned location to an owned location.
- Shipping/Issue or Express Issue.
- Adjustment.
- Physical accounting adjustment.
- Stock used as a component in a PeopleSoft Manufacturing production order.
- Stock issued to a work order in PeopleSoft Maintenance Management.

Related Links

"Understanding Consigned Purchases in Inventory Management" (PeopleSoft Inventory)

Costing Consignable Items

The receipt cost associated with the depletion transaction (as defined by the item's cost profile within each cost book) determines the transaction values.

PeopleSoft Cost Management does not include consigned receipts in an item's average cost, but it does include stock transfers from a non-owned to an owned location. The system costs consigned depletions at the consigned receipt's cost, instead of the average cost of the item. When consigned items are issued to a production ID in PeopleSoft Manufacturing or a work order in PeopleSoft Maintenance Management, the receipt cost is used to value the issue transaction. For items using an average cost method, the system updates the average cost when you:

- Put away a consignable item in an owned location.
- Receive a consignable item from a non-consignment supplier.
- Transfer a consignable item from a non-owned storage location to an owned storage location.

Creating Inventory Accounting Lines for Consumed Consignment Inventory

When consigned inventory is consumed and costed, the Accounting Entry Line Creation job generates the appropriate distribution accounting for each transaction group that is processed.

Transfer From a Non-Owned to an Owned Location

Inventory transfer transactions (060), where a consigned item is moved from a non-owned to an owned location, create this entry:

DR Inventory

CR Accrued Liability

If location accounting is not used, the bin-to-bin transaction pulls the debit side of the accounting entry from the Accounting Rules page. If location accounting is used, the bin-to-bin transaction pulls the debit side of the accounting entry from the Storage Area Accounting page for the destination storage location.

Shipping/Issue or Express Issue

Issue transactions (030-034) create this entry:

DR COGS

CR Accrued Liability

The COGS account is determined using existing logic.

Issue to PeopleSoft Maintenance Management

Issue consigned inventory stock to a work order in PeopleSoft Maintenance Management using transaction group 231 (WM Usage).

DR Work Order

CR Accrued Liability

When items are issued from PeopleSoft Inventory to a work order, PeopleSoft Maintenance Management can provide overriding ChartField combinations on the work order. These account distribution overrides are used with the existing accounting logic in PeopleSoft Cost Management to create the necessary accounting entries. If overrides are not provided, the work order expense account is determined using existing logic.

Adjustments and Physical Accounting Adjustments

Inventory adjustment transactions (050, 051, 053) and inventory counting adjustment transactions (040, 041) that adjust the stock level down will create this entry:

DR Adjustment Account

CR Accrued Liability

The adjustment account is determined using existing logic.

Stock Consumed as a Component in Manufacturing

Component consumption transactions (230 and 220) create this entry:

DR WIP

CR Accrued Liability

The WIP account is determined using existing logic.

Costing and Accounting for the Repair and Maintenance of Assets

PeopleSoft Maintenance Management is a product within the asset life cycle management suite in PeopleSoft Financials. This product manages the maintenance and repair of an asset. The maintenance and repair of an asset may require parts from inventory. Work orders, created in PeopleSoft Maintenance Management, place demand for parts or items in PeopleSoft Inventory, where demand fulfillment picks, issues, and depletes the part. The technician maintaining the asset may pick up the material or the material might be delivered directly to the job site. Once work is completed, the technician returns any unused material back to PeopleSoft Inventory.

Depletions and returns for work orders are placed in the TRANSACTION_INV table where the transactions are picked up by PeopleSoft Cost Management for costing and accounting line creation.

Issuing Materials to a Work Order

When items are issued from PeopleSoft Inventory to a work order, the transaction group 231 (WM Usage) is used to debit a work order expense account and credit inventory. However, PeopleSoft Maintenance Management can provide overriding ChartField combinations. These account distribution overrides are used with the existing accounting logic in PeopleSoft Cost Management to create the necessary accounting entries. In order to override the ChartField combinations used to create accounting entries in PeopleSoft Cost Management, the **Activity ID** field must be populated for the work order placed in the TRANSACTION_INV record. If this field is not populated, the Accounting Line Creation process uses the default accounting rules as dictated by the Accounting Rules pages and the Storage Area Accounting pages. In addition to the **Activity ID** field, PeopleSoft Project Costing requires the following fields to be populated in order to post the transactions to the correct project/work order:

- Project ID
- Business Unit PC
- Resource Type
- Resource Sub Cat
- Resource Category
- Analysis Type

After the Transaction Costing and Accounting Line Creation processes have been run, the data is staged in the CM_ACCTG_LINE record with *N* in the PC_DISTRIB_STATUS field for the PeopleSoft Project Costing import process to pick up and post to the work order.

Returning Materials to Inventory

Once the repair or maintenance work is completed, the technician may return unused items to PeopleSoft Inventory. Items are returned by entering a negative quantity in the same component used to issue the items originally. During a reverse issue, the transaction group, 231 (WM Usage) is inserted in the TRANSACTION_INV table with a negative quantity.

Note: You cannot return more stock than originally issued to the work order.

Returning Perpetual Weighted Average Items to Inventory

This section discusses the cost calculation for items returned to inventory when the items are defined with a deplete cost method of perpetual weighted average. This cost calculation is applied when items are returned to inventory using the following transaction groups:

- 220 Component Kit: This transaction group is used with the PeopleSoft Manufacturing application to issue kit components from inventory stock to a production ID and also to return kit components to inventory when not used in production.
- 230 Component Consumption: This transaction group is used with the PeopleSoft Manufacturing application to record components issued from an inventory WIP location to production and also to record components returned to inventory.
- 231 Work Order Usage: This transaction group is used with the PeopleSoft Maintenance Management application to issue items to a work order in order to maintain or repair an asset. Items returned to inventory from a work order also uses this transaction group.

When a perpetual average item is returned to inventory, the return transaction is costed using the weighted average of the items issued. This return cost is stored in the CM_WGHTAVG_COST table and then used to calculate a new perpetual average for the items in inventory which is stored in the CM_PERPAVG_COST table.

Example of Perpetual Average Returns to Inventory

The following example illustrates how perpetual average items are returned to inventory using the transaction groups 220, 230, and 231. In this example, items are issued to a production ID in PeopleSoft

Manufacturing and later returned to inventory stock. The same calculations apply if material is issued to a work order in PeopleSoft Maintenance Management.

Step	Transaction	Trans Qty	Unit Cost	Inventory Qty	Perpetual Average	Inv Value	PID Value
1	Putaway in Inventory (020)	10 units	10.00	10 units	10.00/unit	100.00	
2	Issue to Production ID (230)	1	10.00	9 units	10.00/unit	90.00	10.00
3	Putaway in Inventory (020)	1	15.00	10 units	10.50/unit = (90.00 + 15.00)/10 units	105.00 = 90.00 + 15.00	
4	Issue to Production ID (230)	1	10.50	9 units	10.50/unit	94.50 = 105.00 – 10.50	20.50 = 10.00 + 10.50
5	Return to inventory from PID (230)	1	10.25 = (1 x 10.00) + (1 x 10.50) / 2 units	10 units	10.475 = (9 x 10.50) + (1 x 10.25) / 10 units	104.75	10.25
6	Return to inventory from PID (230)	1	10.25	11 units	10.4545 = (10 x 10.475) + (1 x 10.25) / 11 units	115.00	

In the above example, two items are issued to the production ID at different perpetual average costs. When the items are returned to inventory stock, the Transaction Costing process determines the weighted average of the items issued to the production ID and uses this weighted average to cost the return transaction. To keep inventory costs synchronized with the general ledger inventory balance, the Create Accounting Lines process generates an accounting entry to debit the inventory account and credit the production ID account.

Costing and Accounting for Vendor Managed Inventory

Supplier managed inventory is a supply chain management strategy in which a supplier manages goods that are located in a customer's warehouse. The goods can be consigned or non-consigned stock. The consigned stock is owned by the supplier until the customer consumes it, and the non-consigned stock is owned by the customer when it is received.

As the supplier, you will create a Supplier Managed Inventory (VMI) business unit, which represents your customer's warehouse. This PeopleSoft Inventory business unit will have storage locations that contain items and item quantities. These items and item quantities will match the consigned items and item quantities at the customer site.

Non-Consigned Goods

Non-consigned stock is owned or consumed by the customer when it is received into their warehouse. When the sales order is shipped and depleted, the transaction is written to the TRANSACTION_INV record using the transaction group 037 (VMI Interunit shipment) to debit the cost of goods sold account and credit the inventory account. In addition, the auto-putaway process is initiated and updates the item quantities in the VMI business unit and the OM Billing Interface process (OM_BILL) selects demand lines for invoicing and sends them to PeopleSoft Billing in order to create an invoice for the customer.

Consigned Goods

Consigned stock (not VMI) is owned by the supplier until the customer consumes it from the customer's warehouse. When consigned items are consumed, the customer sends an EIP message to the VMI business unit. This creates a transaction in the TRANSACTION_INV record using the transaction group 038 (VMI Consumption) to debit the cost of goods sold account and credit the inventory account. The OM Billing Interface process reads the transaction table and creates a billing-only sales order for all 038 transactions.

Related Links

"Understanding Vendor Managed Inventory" (PeopleSoft Inventory)

Calculating and Applying Purchase Price Variance and Exchange Rate Variance

In addition to costing the purchase receipt transactions, the Transaction Costing process (within the Cost Accounting Creation process) calculates variances for material charges and for any existing landed cost charges. The variances are calculated based on the values retrieved by the Landed Cost Extract process from matched and posted vouchers in PeopleSoft Payables.

An exchange rate variance (ERV) occurs when the invoice for the purchased item is in a different currency than the inventory business unit's currency and the exchange rate between the two currencies changes between the time that you enter the purchase order and the time that you voucher the invoice.

Given the costs passed in from the Landed Cost Extract process, variances between the material price, landed costs, and exchange rates are calculated:

- For standard-cost items, two variances can be calculated, purchase price variance (PPV) and exchange rate variance.
 1. The purchase price variance is the difference between the standard costs for the material and landed cost elements and the corresponding actual costs from the matched, posted, and extracted vouchers. Based on the timing of the voucher processing and the Landed Cost Extract process, the PPV could be computed and posted in one or two parts. If the voucher is not available when you run the Transaction Costing process, then the system calculates the difference between the standard cost and the PO price. When the voucher becomes available, then the Transaction Costing process computes the difference between the voucher price (in terms of the exchange rate at PO time) and the standard cost less variances previously recorded.
 2. The exchange rate variance is the change between the exchange rate for material and landed costs on the PO and the exchange rate for material and landed costs on the voucher. This is calculated once the voucher has been matched, posted, and extracted. This is the difference between the amount on the voucher (in terms of the voucher exchange rate to the base currency) less the amount from the PO receipt (in terms of the PO exchange rate).

- For actual-cost items, variances are always applied once the voucher price has been matched, posted, and extracted.

Putaways and depletions are adjusted for the variances. The cost adjustments are calculated for the difference between the current material and landed costs on the PO and the newly determined material and landed costs from the voucher (that has been matched, posted, and extracted). This adjustment does not break out the ERV separately; it is combined with the price variance. The Transaction Costing process finds the original putaways and updates the on-hand inventory stock and depletion records for the variance. The variance is posted based on the ChartField combinations used on the original entries. If you select the **Hold for Final Cost** check box on the Cost Profile page and run the Transaction Costing process in mid-period mode, then costing of putaways and depletions is put on hold until the corresponding invoices are matched, posted, and extracted; this eliminates the need for variances. This means that costs are not updated unless all cost components with the same cost element have been fully matched and the MATCH_STATUS_LC flag has been set to zero.) If you run the Transaction Costing process in regular mode, all transactions are costed using the available costs, regardless of the setting of the **Hold for Final Cost** check box. This means that costs are updated by element for all components with the MATCH_STATUS_LC flag set to zero, even if the flag is not zero for all components with that element.

- For perpetual weighted average items, the price variance and the exchange rate variance are calculated and applied if the **Apply Perpetual Average Adjs** check box is selected on the Transaction Costing process.

The price variance is the difference between the PO material and landed costs and the voucher material and landed costs. The exchange rate variance is the difference in the exchange rate between the PO and the voucher. The Transaction Costing process automatically updates the current weighted average unit cost to take into account the price change. Inventory stock is revalued to the new weighted average using these transaction groups: 401 (Wt Avg Updates from AP) and 403 (Wt Avg Cost Updates - ERV). If the variances are based on more item units than are currently in on-hand stock, then the variance is applied proportionally to the on-hand inventory stock and the excess variance is written off using transaction group 405 (Wt Avg Update Writeoffs). This writeoff typically debits an expense account and credits an accrued liabilities account. For example, suppose that 100 units are vouchered and the variances are calculated for the 100 units; however, only 90 units are

currently on hand. In this case, only 90 units worth of variance costs are applied to the item's weighted average cost for re-averaging purposes. As a result, 10 units worth of variance costs are written off.

- For periodic weighted average items, no variances are computed for material costs, landed costs or exchange rate variances.

This method assumes that the invoices have been matched, posted, and extracted within the same period that the PO was entered. When you run the Transaction Costing process, it picks up the invoice costs for putaway and average cost calculations. If the invoice costs are not available, then the PO costs are used but no variance updates the average cost calculations for delayed invoice costs.

Example of Purchase Price Variance vs. Exchange Rate Variance - Standard Costing Method

This example illustrates the accounting entries for purchase price variance and exchange rate variance for a standard cost item. The inventory business unit's currency in this example is U.S. dollars (USD).

	<i>Price</i>	<i>Exchange Rate</i>	<i>Price</i>
At PO	100.00 USD	1:5	500 EUR
At Voucher		1:7	520 EUR

The standard cost of the item is 90.00 USD.

10 units are received.

At receipt time, an entry is made to debit the inventory account at the standard cost of the item and credit the accrued liabilities account at the PO price. The difference between the PO price and the standard cost is considered purchase price variance.

<i>Account</i>	<i>Debit</i>	<i>Credit</i>
Inventory	900.00	
Accrued Liabilities		1,000.00
Purchase Price Variance	100.00	

When you receive the invoice, the price has changed to 520 EUR. At the same time, the exchange rate has improved from 1:5 to 1:7. There is an unfavorable purchase price variance (the increase in price from 500 to 520 EUR) and a favorable exchange rate variance (1:5 to 1:7), which results in more EUR per USD.

1. The liability is equal to the invoice price multiplied by the current exchange rate:

$$520 \times .143 = 74.36 \times 10 \text{ (quantity received or invoiced)} = 743.60$$

- To determine the second part of the purchase price variance (the difference between the invoice and PO), the new price of 520 EUR is converted using the PO's exchange rate:

$$520 \times .20 = 104.00$$

$$104.00 - 100.00 = 4.00 \times 10 \text{ (quantity received or invoiced)} = 40.00$$

- The exchange rate variance is the difference between the current rate and the PO rate multiplied by the invoice price.

$$.143 - .20 = .057$$

$$.057 \times 520 = 29.64 \times 10 \text{ (quantity received or invoiced)} = 296.40$$

Account	Debit	Credit
Accrued Liabilities	743.60 (1)	
Accounts Payable		743.60 (1)
Purchase Price Variance	40.00 (2)	
Accrued Liabilities		40.00 (2)
Accrued Liabilities	296.40 (3)	
Exchange Rate Variance		296.40 (3)

Example of Purchase Price Variance vs. Exchange Rate Variance - Weighted Average Cost

This example illustrates the accounting entries for purchase price variance and exchange rate variance for an average cost item. The inventory business unit's currency in this example is USD.

	Price	Exchange Rate	Price
At PO	100.00 USD	1:5	500 EUR
At Voucher		1:7	520 EUR

10 units are received.

At receipt time, an entry is made to debit the inventory account at the PO price and credit the accrued liabilities account at the PO price.

Account	Debit	Credit
Inventory	1,000.00	
Accrued Liabilities		1,000.00

When you receive the invoice, the price has changed to 520 EUR. At the same time, the exchange rate has improved from 1:5 to 1:7. There is an unfavorable purchase price variance (the increase in price from 500 to 520 EUR) and a favorable exchange rate variance (1:5 to 1:7), which results in more EUR per USD.

1. The liability is equal to the invoice price multiplied by the current exchange rate:

$$520 \times .143 = 74.36 \times 10 \text{ (quantity received or invoiced)} = 743.60$$

2. To determine the second part of the purchase price variance (the difference between the invoice and PO), the new price of 520 EUR is converted using the PO's exchange rate:

$$520 \times .20 = 104.00$$

$$104.00 - 100.00 = 4.00 \times 10 \text{ (quantity received or invoiced)} = 40.00$$

3. The exchange rate variance is the difference between the current rate and the PO rate multiplied by the invoice price.

$$.143 - .20 = .057$$

$$.057 \times 520 = 29.64 \times 10 \text{ (quantity received or invoiced)} = 296.40$$

Account	Debit	Credit
Accrued Liabilities	743.60 (1)	
Accounts Payable		743.60 (1)
Inventory	40.00 (2)	
Accrued Liabilities		40.00 (2)
Accrued Liabilities	296.40 (3)	
Inventory		296.40 (3)

Related Links

"PeopleSoft Inventory Reports: A to Z" (PeopleSoft Inventory)

Generating a PeopleSoft EPM Extract

Use the Generate EPM Extract process (enterprise performance management costing extract process) page to enable integration between PeopleSoft Cost Management and PeopleSoft EPM by populating an on-hand staging table. A PeopleSoft EPM process extracts data from this table, transforms it, and places it into a PeopleSoft EPM data warehouse.

Note: To find out how PeopleSoft EPM uses and reports PeopleSoft Cost Management data, refer to the PeopleSoft Enterprise Performance Management documentation and the ETL mapping reports.

Page Used to Generate a PeopleSoft EPM Extract

<i>Page Name</i>	<i>Definition Name</i>	<i>Usage</i>
Generate EPM Extract Page	RUN_EPM2010	Populates an on-hand staging table with costing transaction data. A PeopleSoft EPM process now picks up this data.

Chapter 9

Managing Actual and Average Costing

Understanding Average and Actual Costing

PeopleSoft Cost Management provides flexibility when establishing and adjusting costs for makeable or purchased items. This topic discusses features of PeopleSoft Cost Management that are related to the use of actual, and average costing methods that are used in either a manufacturing or distribution environment.

Actual costs for a production ID or production schedule are computed as part of the Transaction Costing process (within the Cost Accounting Creation process). Actual costs can be viewed by using the inquiry pages that are in this topic. Changes to the actual or average costing can be accomplished by using the adjustment pages that are in this topic.

Production IDs that are closed for accounting can be reopened for changes; the actual cost calculations of the Transaction Costing process handles these changes.

Common Elements Used in Average and Actual Costing

<i>Field or Control</i>	<i>Description</i>
Book Name	The name of the cost book. Books identify the type of accounting records that are to be maintained, such as tax, managerial, or financial books. A book contains a set of accounting entries that are posted to the general ledger.
Cost Element	A code that is used to categorize the different components of an item's cost and also to define the debit and credit ChartFields for accounting entries.
Lower Level Costs	Costs that are associated with the components that are used on the assembly.
Reason Code	Categorizes why the adjustment occurred and can be used later for analysis. The reason type limits the selection to the appropriate reason codes for adjustments.
Source Code	Identifies an item as make, buy, floor stock, expense, or planning. This determines how the item is used for the Cost Rollup process and Update Production process (CEREVAL, SFPREVAL, CES5001).
Std UOM (standard unit of measure)	The standard unit of measure for this item established on the Item Definition - General: Common page.

<i>Field or Control</i>	<i>Description</i>
This Level Costs	Costs that are associated with procuring distribution items.

Reviewing Actual and Average Costing for Manufacturing

PeopleSoft Cost Management provides you a number of ways to track actual costs of a production ID or production schedule.

For purposes of computing actual costs of production IDs, if any component items (make or buy) use an actual cost profile, then those final lower level actual costs are necessary for computing a final actual cost at the next level. PeopleSoft provides the actual cost inquiry to display production IDs with unfinalized costs as well as the dependencies underneath each level.

Before completing and finalizing a production ID's costs, it is useful to see a projected actual cost variance with visibility into details where an entry that is expected per the standard may have incomplete or unreasonably different actual costs, or there are actual costs for details that are not expected. This is provided by the Compare Cost Measures component, where you can make corrections before posting the costs.

Pages Used to Review Actual Costs in Manufacturing Environments

<i>Page Name</i>	<i>Definition Name</i>	<i>Usage</i>
Actual Cost Inquiry Page	CM_ACTUALCOST_INQ	(Manufacturing environment only) For makeable items, you can view the actual cost of production based on the production ID or the combination of production area and item ID. This inquiry page displays the actual costs of production broken down by operation sequence, cost category, and conversion code. The production status, item ID, book name, and completed quantity are also displayed. The actual costs are calculated by the Transaction Costing process (within the Cost Accounting Creation process).
<u>Proactive Production Cost - PID Cost Page</u>	CE_PRDNID_COSTING	For makeable items, this page provides advanced proactive visibility into the costing of a production ID during each phase of production. You can save the current costs under a cost measure type for reviewing and comparing on the Compare Cost Measure component.

Page Name	Definition Name	Usage
Primary Products & Co-Product Cost Page	CE_OUTPUT_COST_SEC	View the projected costs for the primary product and co-products of this production ID.
Compare Cost Measures - Output Analysis Page	CE_COST_ANALYTICS	Review and compare the cost calculations for the output from a production ID (products, co-products, and so on) at various stages of production. Cost comparisons can include the production ID as planned, as produced, the frozen standard costs, the actual production costs, or other stages of production.
Compare Cost Measures - Input Analysis Page	CE_COST_ANALYTICS2	Review and compare the cost calculations for the input into a production ID (components, direct, and indirect costs) at various stages of production. Cost comparisons can include the production ID as planned, as produced, the frozen standard costs, the actual production costs, or other stages of production. Compare Cost Measures - Output Analysis Page
Sequences for the Cost Measure Page	CE_COST_MEASUR_SEC	Select the sequence number for viewing costs for this business unit, production ID, and item ID combination.

Proactive Production Cost - PID Cost Page

Use the Proactive Production Cost - PID Cost page (CE_PRDNID_COSTING) to for makeable items, this page provides advanced proactive visibility into the costing of a production ID during each phase of production.

You can save the current costs under a cost measure type for reviewing and comparing on the Compare Cost Measure component.

Navigation:

- **Cost Accounting > Item Costs > Review Costs > Proactive Production Cost**
- **Production Control > Define Production > Production IDs/Schedules > Maintain PIDs > Production ID Maintenance.** Select the **Review Proactive Costing** option in the **Action Menu** field.

For makeable items, this page provides proactive visibility into the costing of a production ID during each phase of production. By using this page, you can view and capture the current costs of a production ID based on the component list and operations list. The captured costs are a snapshot of the production ID's costs at a particular point in time, such as during the as planned stage (before the production ID is released and changed by production) or the as produced stage (after the production ID is changed during

production). For any production ID, you can create multiple snapshots (or cost measures) and save them under a unique combination for cost measure, description, and sequence number. These cost measures can then be compared to each other and the actual or frozen standard costs of the production ID by using the Compare Cost Measures component. By breaking the costs out into as planned and as produced cost measurements, you can see the impact on anticipated costs throughout the life cycle of the production ID.

Field or Control	Description
Cost Measure	<p>Select a value to identify the current stage of the production ID costs. In the text field to the right, enter a description to uniquely identify these calculations. The selection here plus the description and sequence number uniquely identify these captured costs. The cost measure options are:</p> <ul style="list-style-type: none"> • <i>As Planned:</i> Identifies these captured costs as the cost planning determines and before the production ID is changed by the production process. In other words, the operations list and component list are not changed from the planning stage. The as planned costs should be captured when the production ID has a status of firmed or greater. • <i>As Produced:</i> Identifies these captured costs as the production ID's current costs in the production cycle. As a production ID flows through the production process, the operations list, component list, and rates can change. This option indicates that these capture costs reflect costs after production took over from planning and (possibly) altered the production ID to better suit the current production environment. • <i>Other:</i> Identifies all other cost measures that you wish to save other than as planned and as produced. <hr/> <p>Note: The selection in the Cost Measure field is descriptive only; it does not influence the calculation of costs.</p> <hr/>
Primary Products & Co-Products	<p>Select to access the Primary Products & Co-Product Cost page to view the primary product and any co-products for this production ID.</p>

Save this page to store the current cost calculations by cost measure type and sequence. The cost calculations are saved to the CE_PRDNID_COST record. These cost measures can be compared to each other and the actual or frozen standard costs of the production ID by using the Compare Cost Measure component.

Compare Cost Measures - Output Analysis Page

Use the Compare Cost Measures - Output Analysis page (CE_COST_ANALYTICS) to review and compare the cost calculations for the output from a production ID (products, co-products, and so on) at various stages of production.

Cost comparisons can include the production ID as planned, as produced, the frozen standard costs, the actual production costs, or other stages of production.

Navigation:

Cost Accounting > Item Costs > Review Costs > Compare Cost Measures > Output Analysis

This example illustrates the fields and controls on the Compare Cost Measures - Output Analysis page. You can find definitions for the fields and controls later on this page.

The screenshot displays the 'Output Analysis' interface. At the top, there are two tabs: 'Output Analysis' (active) and 'Input Analysis'. Below the tabs, the following fields are visible:

- Business Unit:** US008
- Book:** FIN
- Cost Measure 1:** Actual
- Cost Measure 2:** Actual
- PID or Schedule:**
 - PID
 - Schedule
- Production ID:** PRD00237
- Search:** A yellow button labeled 'Search'.

Below the search criteria, there are two expandable sections:

- Cost Measure 1: Actual** (collapsed)
- Cost Measure 2: Actual** (expanded)

Total Cost	1030.6500
Amount Variance	0.00

Review and compare the cost calculations for a production ID at various stages of production. Enter the business unit, cost book, production ID or production schedule for the production costs that you want to review.

Field or Control	Description
Cost Measure 1 and Cost Measure 2	<p>Enter the two cost measures to compare for this production ID or production schedule. Cost measures represent the current costs at various stages of production. Cost measures include:</p> <ul style="list-style-type: none"> • <i>Actual</i>: The current actual costs of this production ID or production schedule. • <i>As Planned</i>: Cost captured before while the production ID still reflected the planned production and before changes in the production process. These costs are captured by sequence number by using the Proactive Production Cost - PID Cost. • <i>As Produced</i>: Costs captured after the production ID is released to production and altered to better suit the current production environment. These costs are captured by sequence number by using the Proactive Production Cost - PID Cost. • <i>Frozen Standard</i>: The frozen standard costs that are used for this production ID or production schedule. • <i>Other</i>: Cost captured (by sequence number) using the Proactive Production Cost - PID Cost for costs that are not identified as planned or produced.
Seq Nbr (sequence number)	Enter the sequence number that uniquely identifies the captured costs that use the Cost Measure of <i>As Planned</i> , <i>As Produced</i> , or <i>Other</i> .
Search	Select to display the costs for Cost Measure 1 and Cost Measure 2 .

Managing the Actual Costing Method

This section provides an overview of the management of the actual cost method and discusses them.

Pages Used to Manage the Actual Costing Method

Page Name	Definition Name	Usage
<u>Adjust Actual Cost - Item Selection Page</u>	CM_COSTADJ_PARM	Specify the item information to adjust an actual cost item.
<u>Adjust Actual Cost - Production Selection Page</u>	CM_ACTC_INQUIRY	Specify the manufacturing information to adjust an actual cost item.

Page Name	Definition Name	Usage
Adjust Actual Cost - Adjustment Detail Page	CM_COSTADJ_ACTUAL	Apply an actual cost adjustment to an item.

Understanding the Management of the Actual Cost Method

When the items are defined as actual cost, the Transaction Costing process (within the Cost Accounting Creation process):

- For purchased items, values all receipts (putaways) at the purchase order price. The cost can be later adjusted to the voucher price when the voucher is matched, posted, and landed costs are extracted, unless you have selected the Writeoff PPV and ERV check box on the Cost Profiles page.
- For makeable items, values the receipts (putaways) that are based on the completed production costs from the completed production ID or production schedule. If finished items are placed into inventory before the production ID or production schedule is complete, then an estimated cost is used at putaway. The cost is later adjusted to the completed production cost.
- Values all depletions using the putaway cost (adjusted to the voucher price once it is matched, posted, and extracted). The choice of cost flow method on the cost profile page enables the system to track which putaways are used to satisfy each depletion. The system can track items by using lot ID, serial ID, FIFO, or LIFO.
- Actual cost items can be updated to the voucher price once it is matched and posted. Putaways and depletions that were previously costed at the purchase order price are adjusted for the difference between the purchase order (PO) price and the voucher price. To delay costing actual cost items until the voucher price is available, select the Hold for Final Cost check box (on the Cost Profiles page) and run the Transaction Costing process with the Cost Mode of Mid Period.

You also have the option to not update actual cost items to the voucher price. Select the Writeoff PPV and ERV check box on the Cost Profiles page to record any differences between the purchase order price and the vouchered price in an expense account rather than updating the inventory receipt and depletion transactions. The variance is inserted into CM_VARIANC_COST record using the transaction group 400.

The receipt costs of an actual cost item can also be manually adjusted by using the Adjust Actual Cost component. You may need to adjust an item's cost due to entry errors, variances, and other causes. You can increase or decrease the item's cost, or you can establish a new actual cost for an item. This component writes adjustments, using the transaction group 206, to the CM_USER_CST_ADJ record, where they are picked up by the Transaction Costing process.

Related Links

[Cost Profiles Page](#)

[Generating Costs for Transaction Records](#)

Adjust Actual Cost - Item Selection Page

Use the Adjust Actual Cost - Item Selection page (CM_COSTADJ_PARM) to specify the item information to adjust an actual cost item.

Navigation:

Cost Accounting > Item Costs > Update Costs > Adjust Actual Cost > Item Selection

This example illustrates the fields and controls on the Adjust Actual Cost-Item Selection page. You can find definitions for the fields and controls later on this page.

Use this page to search for the receipt to be adjusted. You can find the receipt by:

1. (required) Entering the business unit, cost book name, and item ID for which you want to update the actual cost.

You can select only those items that are actual costed in at least one business unit book.

2. (optional) Refining the search by selecting a specific **Receipt No** (receipt number).

You can include or exclude consigned receipts by selecting *B* (include both), *N* (exclude consigned items), or *Y* (include consigned items). You can also specify a receipt to a specific storage area.

3. Click the **Search** button after you make selections.

The system automatically displays the results of the search on the Adjustment Detail page.

Adjust Actual Cost - Production Selection Page

Use the Adjust Actual Cost - Production Selection page (CM_ACTC_INQUIRY) to specify the manufacturing information to adjust an actual cost item.

Navigation:

Cost Accounting > Item Costs > Update Costs > Adjust Actual Cost > Production Selection

This example illustrates the fields and controls on the Adjust Actual Cost-Production Selection page. You can find definitions for the fields and controls later on this page.

The screenshot shows a web interface with two tabs: "Item Selection" and "Production Selection". The "Production Selection" tab is active. It contains the following fields and controls:

- Business Unit:** A text field containing "US010" with a magnifying glass icon.
- *Book Name:** An empty text field with a magnifying glass icon.
- Production ID:** A section header followed by an empty text field with a magnifying glass icon.
- Production Schedules:** A section header followed by three text fields:
 - Production Area:** An empty text field with a magnifying glass icon.
 - *Item ID:** An empty text field with a magnifying glass icon and a small document icon.
 - Group ID:** An empty text field with a magnifying glass icon.
- Search:** A yellow button with the text "Search" located at the bottom right of the form area.

Use this page to search for the receipt that is to be adjusted for production information. You can find the receipt by:

1. (required) Entering the business unit, and cost book name.
2. (required) Entering either a production ID or production area and item ID.
3. (optional) Entering a group ID for production schedules.
4. Click the **Search** button after you make the selections.

The system automatically displays the results of the search on the Adjustment Detail page.

Adjust Actual Cost - Adjustment Detail Page

Use the Adjust Actual Cost - Adjustment Detail page (CM_COSTADJ_ACTUAL) to apply an actual cost adjustment to an item.

Navigation:

- **Cost Accounting > Item Costs > Update Costs > Adjust Actual Cost > Item Selection. Enter search criteria and click the Search button.**
- **Cost Accounting > Item Costs > Update Costs > Adjust Actual Cost > Production Selection. Enter search criteria and click the Search button.**



The Adjustment Details page displays the results of the search from the Item Selection page or the Production Selection page. Use the different tabs on this page to display the receipts in date and time

order, in receiver number order, in lot or serial ID order, or production ID or area order. Use this page to apply an actual cost adjustment to an item's receipt.

Field or Control	Description
Adjustment Type	<p>Select the cost adjustment type of either cost adjustment or value adjustment. Items that already have a value adjustment are unavailable for cost adjustments. You can make as many cost adjustments as you want, but the new cost is not visible on this page until the Transaction Costing process (within the Cost Accounting Creation process) is run. After you make a value adjustment to a putaway, that item can have further value adjustments, but cost adjustments are not allowed after that time. The value adjustment is considered the superseding point of information; it is the value for this putaway. Once a manual adjustment is made, further adjustments from PeopleSoft Payables are not processed; the manual intervention takes precedence over system generated adjustments.</p> <p><i>Cost Adjustment:</i> Adjusts the cost for the specified items in the inventory balance and depletion records (if any of the quantity is shipped). A cost adjustment declares that the old cost is incorrect, and this is the correct cost.</p> <p><i>Value Adjustment:</i> Adjusts the value for the specified items that are currently on hand in the inventory business unit. Depletion records are not updated. A value adjustment declares that the old cost is correct, and depletions that are accounted for at the old cost had the correct cost, but now something has occurred that requires a change to the value of the existing on-hand quantity.</p>

Use the **Auto-adjust** group box to apply one cost or percentage adjustment to all the selected receipt lines in the **Item Adjustment Selection** group box.

Field or Control	Description
Adj Method (adjustment method)	<p>To adjust the actual cost of an item, you have three options:</p> <p><i>Increase:</i> The amount that you enter in the Increase Cost By field or the % Increase field is added to the current average cost.</p> <p><i>Decrease:</i> The amount that you enter in the Decrease Cost By field or the % Decrease field is subtracted from the current average cost. Enter the amount as a positive number.</p> <p><i>New Cost:</i> The amount that you enter in the New Cost field replaces the current average cost.</p>
Adj Class (adjustment class)	<p>Specify whether the entries are expressed in amount or percentage. This applies to the adjustment methods of increase or decrease.</p>

<i>Field or Control</i>	<i>Description</i>
	Click the Apply cost to all button to apply the new costs that are entered in the Auto-adjust group box to all of the receipt lines that are displayed.
	Click the Sum Adjusted button to display adjusted quantities for the item in the Total Qty OnHand , Total Qty Adjusted , and Total Costs Difference fields.

Use the **Item Adjustment Selection** group box to adjust individual receipt lines. Receipt lines appear based on the selection criteria from the Item Selection or Production Selection pages. The receipts lines can be adjusted individually by using the appropriate **Increase**(percent increase), **Decrease** (percent decrease), or **New Cost** fields on the selected row. To adjust several receipts at one time, use the **Auto-adjust** group box.

<i>Field or Control</i>	<i>Description</i>
Sel	Select the receipt lines of the item that you want to adjust.

Administering the Average Cost Methods

This topic provides an overview of the administration of the average cost methods.

Pages Used to Administer the Average Cost Methods

<i>Page Name</i>	<i>Definition Name</i>	<i>Usage</i>
Adjust Average Cost Page	CM_COST_ADJ	Adjust perpetual weighted averages for items. ChartField security can be applied to this page.
ChartField Overrides Page	CM_COST_ADJ2	Replace the ChartField combinations that are defined in the account distribution setup. Adjust Average Cost Page
Adjust Retro Costs Page	CM_COST_ADJ_RETRO	Adjust retroactive perpetual weighted averages for items. ChartField security can be applied to this page.

Understanding the Administration of the Average Cost Methods

For average costing, you can select one of three costing methods:

Term	Definition
Periodic Weighted Average	The weighted average is calculated only once, at the end of the period. All depletions during that period use this same average. Run the Transaction Costing process (within the Cost Accounting Creation process) with a Cost Mode of Regular to calculate end-of-period averages. There is no cost adjustment page for periodic averages.
Perpetual Weighted Average	The weighted average is calculated at each putaway. The average cost that is applied to depletions could fluctuate throughout the period.
Retroactive Perpetual Weighted Average	The weighted average is calculated after each putaway, just like the perpetual average method; however, this weighted average cost is calculated at the end of the period and applied retroactively to the depletions. This method enables you to value each individual transaction by using the current perpetual average cost at depletion time, yet delay the calculation of the average until the end of a period, when more cost information is likely to be captured for a more accurate average cost. Run the Transaction Costing process (within the Cost Accounting Creation process) with a Cost Mode of <i>Regular</i> to calculate retroactive perpetual average.

Based on the entry in the **Cost Element Option** field of the Cost Profiles page, the perpetual average costing methods can combine all costs into the primary cost element and calculate one average cost per item or break out the averages by cost element.

When the items are defined as average-cost items, the Transaction Costing process (within the Cost Accounting Creation process):

- Values all receipts (putaways) at the purchase order price or the cost of production.
- Values all depletions by using the periodic weighted average, the perpetual weighted average, or the retroactive perpetual average method. The choice of cost flow method on the cost profile page does not impact the weighted average calculations, but it is necessary for the system background processes.
- To apply purchase price variances and exchange rate variances to the perpetual average cost items, select the Apply Perpetual Average Adjs check box on the Transaction Costing process page. Putaways and depletions are adjusted for the difference between the PO price and the voucher price (price variance) and also any difference in the exchange rate that is used on the PO and the voucher (ERV). To delay calculation of the price and exchange rate variances, do not select the Apply Perpetual Average Adjs check box when running the Transaction Costing process.
- For periodic weighted average items, no variances are computed. This method assumes that the invoices are matched, posted, and extracted within the same period that the PO is entered. When the Transaction Costing process is run, it picks up the invoice costs for putaway and average cost calculations. If the invoice costs are not available, then the PO costs are used but no variance later updates the average cost calculations for delayed invoice costs. The frequency of the periodic average

computation is controlled by running the Transaction Costing process in Regular mode. When the Transaction Costing process is run in Mid Period mode, periodic averages are not computed and depletion transactions are not costed. The accounting for these transactions is postponed.

The cost of an average cost item can also be manually adjusted by using the Adjust Average Cost page and the Adjust Retro Costs page. When the system is running in a live environment, you may need to manually adjust an item's average cost due to entry errors, variances, and other causes. You can increase or decrease the item's cost, or you can establish a new average cost for an item.

The Adjust Average Cost page and the Adjust Retro Costs page write the perpetual average adjustments to the average cost table, CM_PERPAVG_COST, and the average cost adjustment table, CM_COST_ADJB, where they are picked up by the Accounting Line Creation job.

All periodic average cost items are updated on the CM_PERDAVG_COST record during the Transaction Costing process whenever there is a receipt or depletion of any periodic averaged item. Each update puts a new row in the table, and all other previous rows are marked inactive, so only one row for the business unit and item ID is active. There is no cost adjustment page for periodic cost.

Note: Manual adjustments do not change the average cost that is stored in the AVERAGE_COST_MAT field of the BU_ITEMS_INV record. This field is appears in the Avg Matl Cost field of the Define Business Unit Item-General: Common page.

Related Links

[Cost Profiles Page](#)

[Generating Costs for Transaction Records](#)

Adjust Average Cost Page

Use the Adjust Average Cost page (CM_COST_ADJ) to adjust perpetual weighted averages for items.

ChartField security can be applied to this page.

Navigation:

Cost Accounting > Item Costs > Update Costs > Adjust Average Cost > Average Cost Adjustment

This example illustrates the fields and controls on the Adjust Average Cost page. You can find definitions for the fields and controls later on this page.

The screenshot shows the 'Adjust Average Cost' page with the following details:

- Business Unit: US010
- Book Name: FIN01
- Item ID: 10002
- Std UOM: EA
- Long Sleeve T-Shirt, Mens
- Qty Owned: 8145.0000
- Weighted Average Adjust Type: Adj Value
- ChartField Overrides

Below these details is a table titled 'Perpetual Weighted Average Costs' with the following data:

Cost Elmnt	Average Cost	Adj Method	Increase	Decrease	New Cost	Reason Code	Distribution Type
100	5.7191	New Cost	0.0000	0.0000	5.7191		

Use this page to adjust an item's current perpetual weighted average cost based on the business unit, cost book, item ID, and cost elements. The cost adjustment and inventory revaluation are processed by the Accounting Line Creation job. Entries on this page impact the average purchase price value displayed on the Define Business Unit Item - General: Common page.

Note: Negative quantities are acceptable, but the unit cost cannot be negative. A message appears if this situation arises.

Field or Control	Description
Qty Owned (quantity owned)	<p>Inventory is classified as owned, nonowned, or consigned. If inventory is nonowned, it is not considered a part of the inventory value for the business unit; nonowned inventory does not affect costing, and in this case, the average cost. The owned quantity for an item is used to recalculate average cost. Consigned inventory from a supplier becomes owned inventory when it is consumed; at that time, it is included in average cost recalculation.</p>
Weighted Average Adjust Type	<p>Options are:</p> <p><i>Adj Value</i> (adjustment value): Enter a new inventory value for the specified item. The adjustment is processed by the Accounting Line Creation process by using the value adjustment transaction (transaction group 205). Accounting entries are created to record the change in inventory valuation. The adjustment transaction records the difference between the old and the new weighted average cost for the current owned quantity on hand for the entire business unit. If the inventory business unit requires location accounting, the process writes an average cost adjustment transaction for each owned storage area containing a nonzero balance of the item.</p> <p><i>Change Avg</i> (change average): Enter a new current average cost for the specified item. This option does not result in accounting entries, but the transaction is stored in the database for record keeping purposes. For example, assume that the balance of the item in PeopleSoft Inventory (average cost multiplied by on-hand quantity) does not agree with the item's net balance in PeopleSoft General Ledger. Upon investigation, you discover that the general ledger (GL) balance is correct. Perhaps it is adjusted by using a manual journal entry. The change average option provides a method to change the average cost for perpetual inventory records.</p>
ChartField Overrides	<p>Select to change ChartField information, or you can select a SpeedType Key and the ChartField information appears as the default from the SpeedType. The SpeedType Key field only appears if SpeedType level is selected on the Inventory Definition - Business Unit Options page.</p>

Field or Control	Description
Adjustment Method	<p>To adjust the average cost of an item, you have three options:</p> <p><i>Increase:</i> The amount that you enter in the Increase field is added to the current average cost.</p> <p><i>Decrease:</i> The amount that you enter in the Decrease field is subtracted from the current average cost. Enter the amount as a positive number.</p> <p><i>New Cost:</i> The amount that you enter in the New Cost field replaces the current average cost.</p>
Distribution Type	(Optional) User-defined codes that are a subset of transaction groups. This enables you to break down a transaction group into customized categories which can use different ChartFields by distribution type from the distribution accounting rules.

Use the Average Cost Adjustment/PPV report to view adjustments that this page creates.

Note: ChartField security can be applied to this page.

Related Links

[CMS1000 - Average Cost Adjustment/PPV Report](#)

[Enabling ChartField Security](#)

Adjust Retro Costs Page

Use the Adjust Retro Costs page (CM_COST_ADJ_RETRO) to adjust retroactive perpetual weighted averages for items.

ChartField security can be applied to this page.

Navigation:

Cost Accounting > Item Costs > Update Costs > Adjust Retroactive Cost > Adjust Retroactive Average

Enables you to update or add an average cost for the item in the retroactive perpetual average record. The entry is inserted into the actual cost table. The Transaction Costing process (in the regular Cost Mode) then recalculates the correct average for every depleted depletion transaction.

Field or Control	Description
Qty Owned (quantity owned)	<p>Inventory is classified as owned, nonowned, or consigned. If inventory is nonowned, it is not considered a part of the inventory value for the business unit; nonowned inventory does not affect costing, and in this case, the retroactive perpetual average cost. The owned quantity for an item is used to recalculate the retroactive perpetual average cost.</p> <p>Consigned inventory from a supplier becomes owned inventory when it is consumed; at that time, it is included in perpetual average cost recalculation.</p>
Weighted Average Adjust Type	<p>The options are:</p> <p><i>Adj Value</i> (adjustment value): Enter a new inventory value for the specified item. The adjustment is processed by the Transaction Costing process and the Accounting Line Creation process by using the value adjustment transaction (transaction group 205). Accounting entries are created to record the change in inventory valuation. The adjustment transaction records the difference between the old and the new perpetual weighted average cost for the current owned quantity on hand for the entire business unit. If the inventory business unit requires location accounting, the process writes an average cost adjustment transaction for each owned storage area containing a nonzero balance of the item.</p> <p><i>Change Avg</i> (change average): Enter a new current average cost for the specified item. This option does not result in accounting entries, but the transaction is stored in the database for record keeping purposes. For example, assume that the balance of the item in PeopleSoft Inventory (average cost multiplied by on-hand quantity) does not agree with the item's net balance in PeopleSoft General Ledger. Upon investigation, you discover that the GL balance is correct. Perhaps it is adjusted by using a manual journal entry. The Change Average option provides a method to change the average cost for perpetual inventory records.</p>
ChartField Overrides	<p>Select to change ChartField information, or you can select a SpeedType Key and the ChartField information appears as the default from the SpeedType. The SpeedType Key field only appears if SpeedType level is selected on the Inventory Definition - Business Unit Options page.</p>
Adjustment Method	<p>To adjust the average cost of an item, you have three options:</p> <p><i>Increase</i>: The amount that you enter in Increase Cost By is added to the current average cost.</p> <p><i>Decrease</i>: The amount that you enter in Decrease Cost By is subtracted from the current average cost. Enter the amount as a positive number.</p> <p><i>New Cost</i>: If there is no current perpetual average for this item, then you can enter an amount in the New Cost field. This new cost is applied to the beginning of the period.</p>

<i>Field or Control</i>	<i>Description</i>
Distribution Type	(Optional) User-defined codes that are a subset of transaction groups. This enables you to break down a transaction group into customized categories which can use different ChartFields by distribution type from the distribution accounting rules.

Note: ChartField security can be applied to this page.

Related Links

[Enabling ChartField Security](#)

Managing Interunit Transfer Pricing and Additional Costs

Understanding Interunit Transfers

A transfer of stock between two inventory business units is known as an interunit transfer. To create an interunit transfer:

1. Add a material stock request (MSR) with the request type of *Interunit Transfer*. The MSR includes a destination (receiving) inventory business unit.
2. Complete the demand fulfillment steps within the source (sending) Inventory business unit to ship the stock.
3. Run the Deplete On Hand Quantity (Depletion) process in the source unit. In addition to other functions, this process calculates the transfer price (transfer cost) of the stock and any additional transfer costs.
4. When the items are received in the destination business unit, run the Load Staged Items process (INPSSTGE).
5. Run the Cost Accounting Creation process page to create the accounting entries for the interunit transfer. These accounting entries record the changes to the inventory stock accounts, intransit accounts, and record any additional transfer expenses or gain/loss on transfers.

While using this topic, please note the following points:

- The terms *transfer price* and *transfer cost* both refer to the same value.
- The setup of an interunit transfer can be divided into several parts. In this topic, we discuss the transfer pricing and accounting entries related to a transfer. Before defining your transfer pricing structure, you must set up the overall interunit transfer structure. The *PeopleSoft Inventory* provides detailed instructions for setting up the system for interunit transfers.

See "Understanding Stock Transfers Between Business Units" (PeopleSoft Inventory)

- PeopleSoft Cost Management does not support interunit pricing for non-cost items.
- This topic discusses transferring stock between two Inventory business units. For information about shipping stock to internal departments or on behalf of another GL unit, see the *PeopleSoft Cost Management*, Setting Up the Accounting Rules Structure topic. Read the sections "Designing Shipment On Behalf Of" and "Creating and Reversing Interunit Expensed Issues."

See [Designing Shipment On Behalf Of](#).

See [Creating and Reversing Interunit Expensed Issues](#).

Applying Transfer Prices to a Material Stock Request

The Deplete On Hand Qty (Depletion) process uses a default hierarchy to determine the transfer price for each line of a interunit material stock request. In the default hierarchy, the more specific information overrides the more general information. Transfer prices can be derived from:

1. Override values entered on the material stock request line. If you selected the **Allow Price/Markup Overrides** check box on the Setup Fulfillment page of the source business unit, then you can change the transfer price on the line.
2. The Transfer Pricing table. This table includes the material portion of the transfer price and the additional transfer costs. The Deplete On Hand Qty process looks for a transfer price specified for the item ID. This transfer price can be broken up into multiple cost elements. The setup and use of the Transfer Pricing table is optional.
3. The Transfer Pricing Definition component. If the Transfer Pricing table contains no entry for the specific item ID, then the Deplete On Hand Qty process calculates a transfer price using the data in the Transfer Pricing Definition component.
4. A value based on the cost of the item. If the transfer price cannot be derived from the transfer pricing definition, then the Deplete On Hand Qty process uses a value based on the item cost.

Details of the Transfer Price Default Hierarchy

The Deplete On Hand Qty process uses the following steps to determine the material transfer price and additional transfer costs included in an item's transfer price:

1. Use the override values (transfer price, markup percentage, or zero cost) entered on the MSR line using:
 - The Create/Update Stock Request component.
 - The Express Issue component.
 - The Maintain Stock Requests component.
 - The Inventory_Create_Stock_Request, Inventory_Front_End_Shipping, or Inventory_Shipping EIPs.
2. Find a transfer price for the specific item ID based on the source and destination business unit pair in the Transfer Price table. If no row contains this data, then:
3. Find a transfer price for the specific item ID in the Transfer Price table for which the source business unit is specified and the destination business unit is blank. If no row contains this data, then:
4. Use the Transfer Pricing Definition component to calculate the material portion of the transfer price using information defined for the specific source and destination unit pair.
 - a. Search for item specific information at the detail level. If no item ID information is found, then:
 - b. Search for item group information at the detail level. If no item group information is found and the Price Overrides Only check box has not been selected, then:

- c. Search for header level information (this step is skipped if the Price Overrides Only check box has been selected). If no Transfer Pricing Definition component is defined for the specific source and destination unit, then:
5. Use the Transfer Pricing Definition component to calculate the material portion of the transfer price using information defined for the specific source unit and a blank destination unit.
 - a. Search for item specific information at the detail level. If no item ID information is found, then:
 - b. Search for item group information at the detail level. If no item group information is found and the Price Overrides Only check box has not been selected, then:
 - c. Search for header level information (this step is skipped if the Price Overrides Only check box has been selected). If no Transfer Pricing Definition component is defined for the specific source unit and a blank destination unit, then:
 6. Use a value based on the item's cost as the transfer price. This value would record just a material portion of the transfer price with no additional transfer costs.
 - For standard cost items, the transfer price is the current frozen standard cost located in the CM_PRODCOST table.
 - For actual cost items, the transfer price is the value in the **Default Actual Cost** field (DFLT_ACTUAL_COST) in the Define Business Unit Item - General page.
 - For perpetual weighted average items, the transfer price is the current perpetual average cost located in the CM_PERPAVG_COST table. If there is no value in CM_PERPAVG_COST table, then the transfer price is taken from the AVERAGE_COST field in the BU_ITEMS_INV table.
 - For items using Periodic Weighted Average or Retroactive Weighted Average, the transfer price is the value in the **Average Purchase Price** field (AVERAGE_COST) in the Define Business Unit Item - General page.

Note: Rounding differences could create a small gain or loss when using the current perpetual average cost (located in the CM_PERPAVG_COST table) as the transfer price.

Related Links

"Depleting Inventory Balances" (PeopleSoft Inventory)

[Using Transfer Pricing Definitions](#)

[Populating the Transfer Price Table](#)

Determining the Calculation Method for Transfer Prices

The following costs can be included in an interunit transfer price:

- Material transfer prices
- Landed costs

- Additional transfer costs

Determining the Material Transfer Price

The transfer price includes the material cost of the transferred item determined by the transfer price default hierarchy. Create a cost element with the cost category of *Material* to be used for the transfer price. The item's default material cost element is stored in the **Default Cost Element** field in the Define Business Unit Item - General page. Additional material cost elements can be established on the transfer pricing definition or in your PeopleSoft Manufacturing setup.

There are four different methods to value the material portion of an transfer price:

- At a Transfer Price.

The system transfers the item using a fixed transfer price.

- At a Percent Markup of Cost or Transfer Price.

The system creates the new transfer price by increasing the cost or transfer price of the inventory stock by a percentage markup.

- At Zero Price.

The system values the intransit stock at zero. The zero cost method records the entire cost of the stock in the source business unit's interunit transfer gain or loss account. You can use this method for the shipment of promotional or sample items. You can change the default value for the zero price option on the material stock request line using the Material Stock Request - Accounting/Interunit Detail page or the Express Issue - Detail Override/Exceptions page. You can also change the zero price option on the Par Location Definition - Line Details page for issues to the par location.

- At a value based on the item's cost.

The system transfers the item using a value based on the item's cost in the source inventory business unit.

Note: PeopleSoft Cost Management does not support interunit pricing for non-cost items.

Recording Landed Costs

The cost of obtaining inventory stock includes more than just the material costs of the items. Landed costs include some of the charges that are associated with getting items into a warehouse and available for use or sale. In the destination business unit, landed costs are absorbed into the material cost of the item for actual and weighted average items. For standard items, a variance is recorded. For information on setting up landed costs, see the "Structuring Landed Costs" topic.

See [Understanding Landed Costs](#).

Creating Additional Transfer Costs

In addition to the item's material cost and landed costs, you can also record additional transfer fees for an interunit transfer. To define additional transfer costs:

- Establish a cost element for additional transfer by using the cost category of *Addl Trans*.

- Define a fixed cost or percentage markup to calculate the additional transfer cost using the Transfer Pricing Definition component. Additional transfer costs can be defined at the header level or detail level (item ID or item group).
- Determine if your additional transfer costs should be added to the cost of the item in the destination business unit or written off in an expense account. Select the **Expense Transfer Fees** check box on the Inventory Definition - Business Unit Definition page to write off the additional transfer costs.
- Populate the Transfer Price table (CM_TRAN_PRICE) with the transfer prices (material and additional transfer costs) by running the Calculate Transfer Price (CM_TRANS_PRC) process. Additional transfer costs can only be used from the Transfer Price table. The Deplete On Hand Qty (Depletion) process does not calculate additional transfer costs directly from the Transfer Pricing Definition component.

See [Applying Transfer Prices to a Material Stock Request](#).

Recording the Accounting Entries for Transfer Prices

During demand fulfillment, the MSR is located in the IN_DEMAND table. Once the transfer price has been calculated by the Deplete On Hand Qty process, the transfer price is located in a child table, IN_DEMAND_TPRC, where it is broken out into several parts by cost elements. Cost elements can be created for material costs, landed costs, and additional transfer costs. Estimated transfer price details can be viewed using the Transfer Price Inquiry component. While the stock is in the intransit account, the material, landed, and additional transfer costs are all included in the total transfer price. The transfer price details are retained when the stock is received by the destination business unit. During putaway, the additional transfer costs can be included in the material cost of the stock or the additional transfer costs can be expensed.

The following transaction groups can be used for an interunit transfer:

- 022 IBU Transfer Receipts
- 025 InterCompany Receipts
- 031 InterBU Transfer Shipments
- 035 InterCompany Transfers
- 042 IBU Transfer Adjustments
- 300 Gain/Loss on Transfer Price
- 301 InterCompany Cost of Goods

Transfer prices and additional transfer costs can also be used for Shipment On Behalf Of transactions using the following transaction groups:

- 034 Shipments on Behalf of Other BU
- 302 ShipOnBehalf Gain/Loss

See [Designing Shipment On Behalf Of](#).

Transfer prices only can be used with interunit expense issues using the following transaction groups:

- 036 InterUnit Expensed Issue
- 026 Expensed Issue Return

Example of the Transfer Pricing Table

Once the Deplete On Hand Qty process calculates the transfer price for a standard, actual, or average cost item, the total transfer price is stored in the TRANSFER_COST field of the IN_DEMAND table; the transfer price details, broken out by cost element, are stored in the IN_DEMAND_TRPC table. To record the material cost of the transferred items, the system used the cost element in the **Default Cost Element** field in the Define Business Unit Item - General: Common page.

The following diagram illustrates a simplified example of a material stock request with an interunit transfer price (transfer cost).

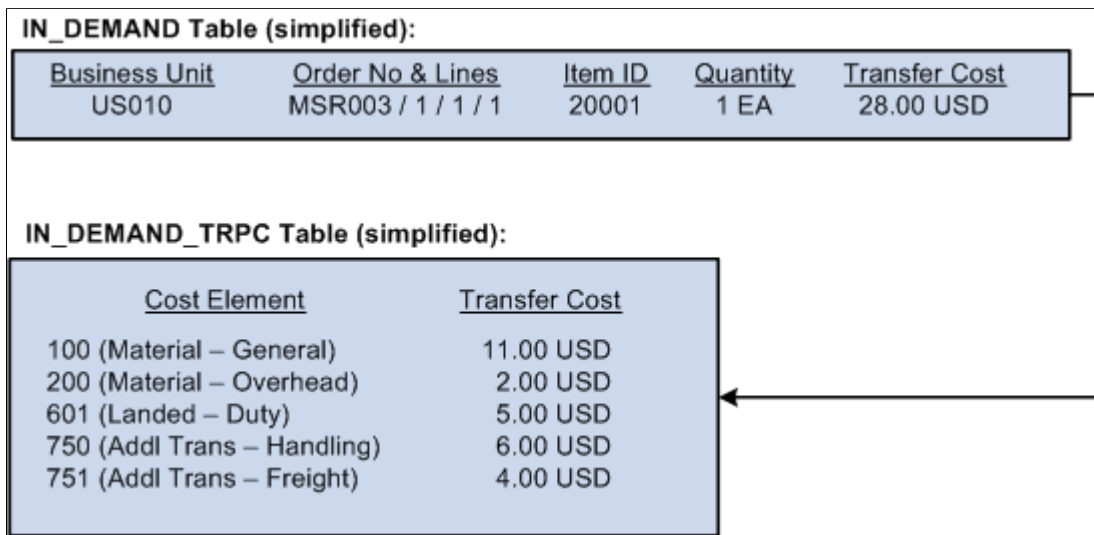

Note: The terms *transfer price* and *transfer cost* both refer to the same value.

The above example displays an item with more than one material cost element, a landed cost element, and two additional transfer cost elements. Your purchased items may only have one material cost element, however, your make (manufactured) items may have multiple material cost elements. The setup for landed cost is located in the "Structuring Landed Costs" topic.

See [Understanding Landed Costs](#).

Example of an InterBU Transfer Shipment (Transaction Group 031)

The following diagram illustrates a simplified example of the accounting entries generated in the source business unit after the Deplete On Hand Qty process and the Cost Accounting Creation process are complete. For the transaction group 031 (InterBU Transfer Shipments), the Cost Accounting Creation process determines any difference between the item's cost and the transfer price by comparing cost element to cost element. The typical shipping accounting entry debits the intransit inventory account at the item's transfer price and credits the inventory account at the item's cost. Any difference between the transfer price and cost creates an additional entry associated with the transaction group 300 (gain or loss on transfer price).

The following diagram illustrates a gain on transfer price for the source business unit.

Accounting Entries After Shipment in the Source Business Unit:					
Inventory Acct (source BU)		Intransit Account		Gain/Loss on Transfer Price	
(100)	10.00	(100)	11.00	(601)	1.00
(200)	1.75	(200)	2.00	(100)	1.00
(601)	6.00	(601)	5.00	(200)	.25
		(750)	6.00	(750)	6.00
		(751)	4.00	(751)	4.00

In the above example, note that the cost element detail is included in the accounting entry. The Cost Accounting Creation process uses the IN_DEMAND_TRPC table when creating accounting entries for interunit transactions.

Note: The above example does not address an intercompany transfer or an interunit transfer using interunit receivable and payable accounts. More detailed examples are given later in this topic.

Examples of Inventory Business Unit Transfer Receipts (Transaction Group 022)

The following diagram illustrates a simplified example of the accounting entries generated in the destination business unit after the Load Staged Items process (INPSSTGE) and the Cost Accounting Creation process are complete. The Cost Accounting Creation process uses the transaction groups 022 (IBU Transfer Receipts) and 300 (gain or loss on transfer price).

Accounting Entries After Putaway in the Destination Business Unit:					
Actual-Cost or Average-Cost Items:					
Inventory Acct (destination BU)		Intransit Account		Gain/Loss on Transfer Price	
(100)	11.00	(100)	11.00	(750)	6.00
(200)	2.00	(200)	2.00	(751)	4.00
(601)	5.00	(601)	5.00		
		(750)	6.00		
		(751)	4.00		

Standard-Cost Items:					
Inventory Acct (destination BU)		Intransit Account		Gain/Loss on Transfer Price	
(100)	10.50	(100)	11.00	(100)	.50
(200)	3.00	(200)	2.00	(750)	6.00
(601)	5.00	(601)	5.00	(751)	4.00
(std costs)		(750)	6.00		
		(751)	4.00		

In both of these examples:

- The source business unit owns the stock while it is in the intransit account.
- The destination business unit has elected to write-off the additional transfer costs rather than include them in the inventory stock's cost.

For items using one of the weighted average costing methods, the material and landed cost portions of the transfer price are weighted into the new average cost for the item in the destination business unit. For items using the actual cost method, the material and landed cost portions of the transfer price becomes the actual cost for the receipts at the destination business unit. Note that for both the actual and average cost methods, you can choose to include the additional transfer costs in the cost of the item rather than write off these amounts.

For standard cost items, a gain or loss is calculated for the difference between the transfer price (material and landed cost portions only) and the item's standard cost maintained in the destination business unit. This difference is recorded in a gain/loss on transfer price account. The interunit stock is recorded into the inventory account at the standard cost, and the additional transfer costs are written off to a gain and loss on transfer price account.

Note: The previous example does not address an intercompany transfer or an interunit transfer using interunit receivable and payable accounts. More detailed examples are given later in this topic.

Understanding the Types of Interunit Transfers

When you maintain warehouses and plants all over the world, you must be able to transfer goods among these locations and account for transfer prices, costs, currency changes, taxes, and invoicing for business units involved in the transfer. In PeopleSoft Inventory, a transfer of stock between two inventory business units is known as an interunit transfer. There are three approaches to interunit transfers:

Term	Definition
Interunit transfer using an intransit account only	The transfer price of the inventory stock is entered into an intransit account while it is moved from one inventory business unit to another. This approach can be used when both inventory business units post to the same general ledger (GL).
Interunit transfer with interunit receivables and interunit payables accounts	An intransit account is used along with interunit accounts receivable (AR) and interunit accounts payable (AP) accounts recorded for each inventory business unit. Both inventory business units post to different GL business units. This approach can be used when transferring stock between separate legal entities or within the same legal entity.
Interunit sales approach (intercompany)	An intercompany sale is recorded with the source inventory business unit recording a sale and the linked billing business unit issuing an invoice for the stock transfer to the receiving business unit's payable unit. This approach can be used when transferring stock between separate legal entities or within the same legal entity. Intercompany is required if the (GL) business units are using different currencies.

This diagram illustrates the flow of an interunit transfer using only an intransit account.

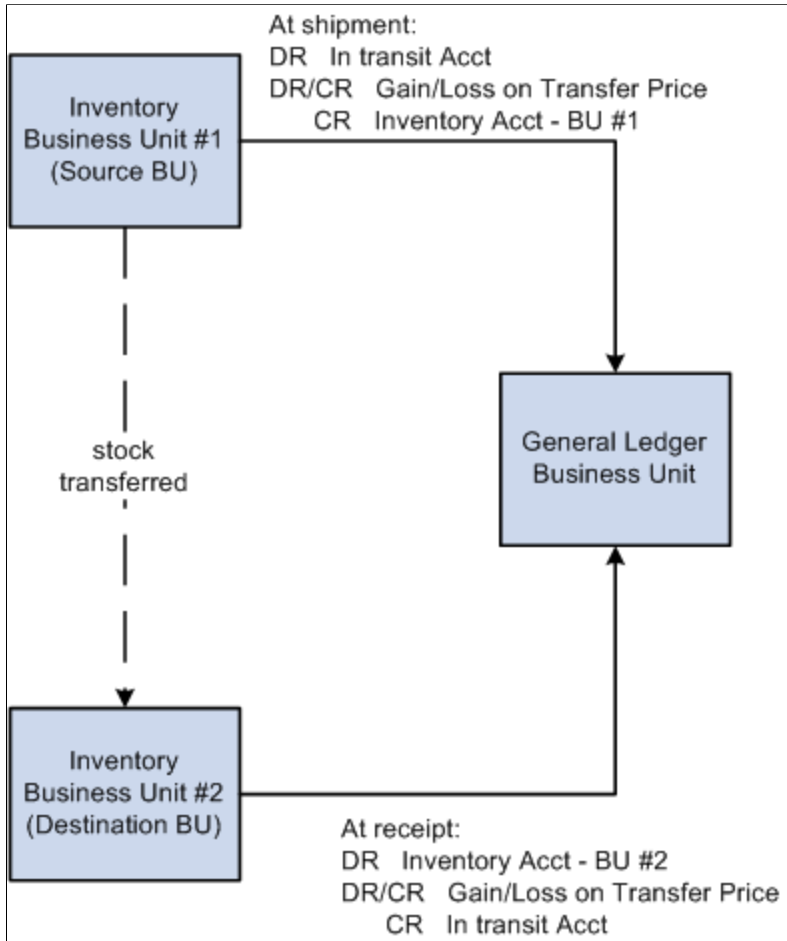

If the inventory business units transferring stock are linked to the same GL business unit, the system does not generate any affiliate interunit transactions. The intransit account must be defined as belonging to the source or destination business unit.

This diagram illustrates the flow of an interunit transfer with interunit receivables and interunit payables accounts when the source unit owns the intransit stock.

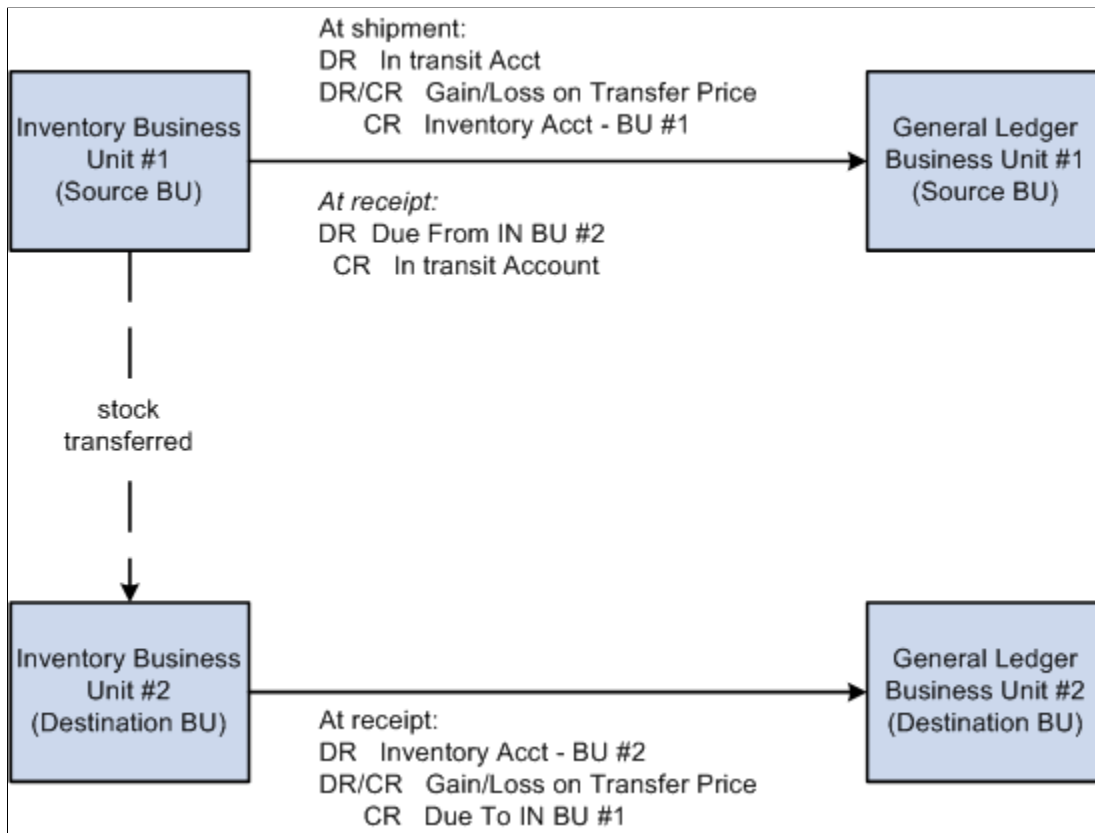

In a transfer for which the inventory business units are linked to two GL business units that may be part of the same legal entity, entries are recorded in the interunit receivables and payables accounts. Affiliate accounting is used, and the interunit receivables affiliate and interunit payables affiliate entries should equal each other.

This diagram illustrates the cost flow of an intercompany sales transaction.

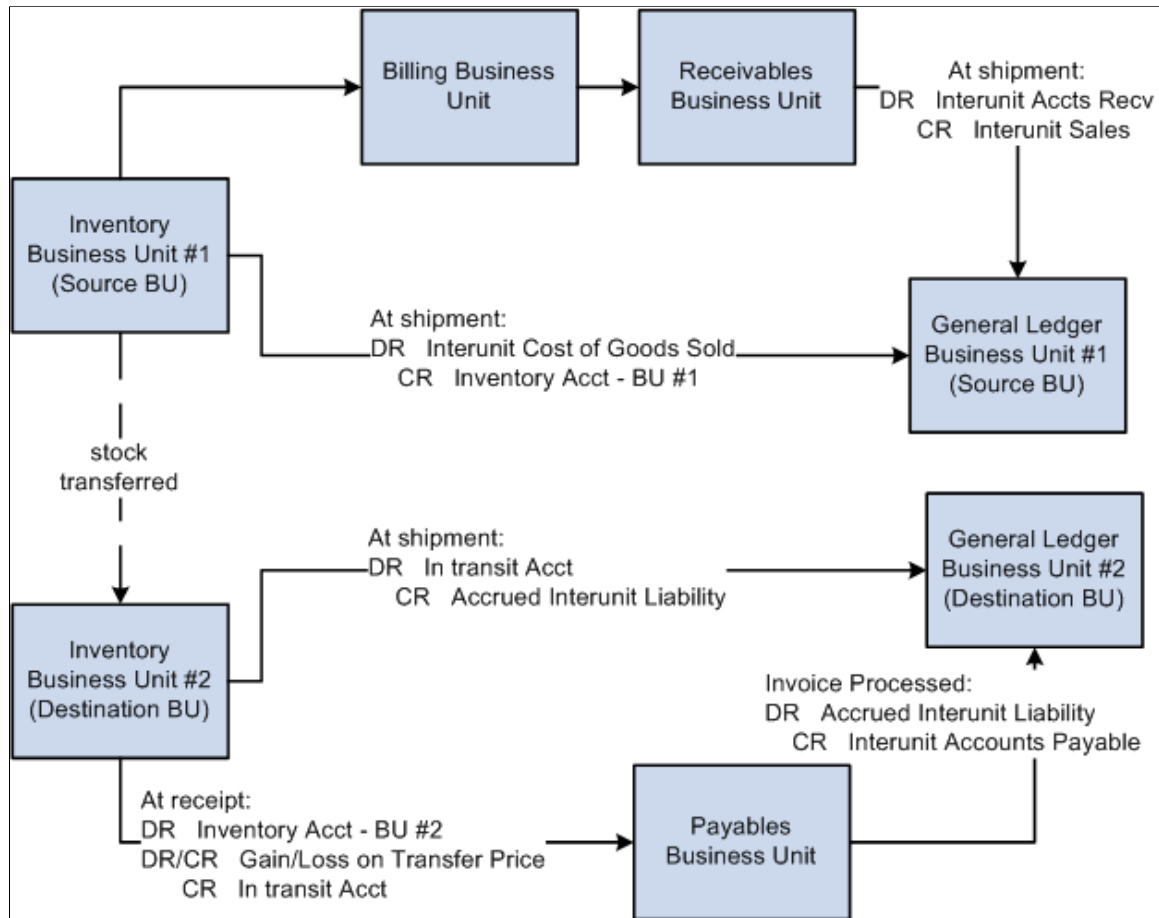

In an intercompany transfer, the inventory business units transferring stock want to transfer inventory in an "arm's length" manner. In this case, an intercompany sale is recorded. The destination inventory business unit must be defined as a customer and the source GL business unit must be defined as a supplier. The billing business unit linked to the source inventory business unit performs the additional tasks of calculating value-added taxes (VAT), invoice generation, legal shipping documentation, accounting line creation, and voucher initiation. The AP voucher is recorded in the interface tables of the destination payables business unit, where it can be processed and paid.

Related Links

- "Understanding Stock Transfers Between Business Units" (PeopleSoft Inventory)
- "Inventory Options Page" (PeopleSoft Inventory)
- "Understanding InterUnit and IntraUnit Billing" (PeopleSoft Billing)
- "Defining Additional Common Information" (Application Fundamentals)
- "Understanding PeopleSoft ChartFields" (Application Fundamentals)

Prerequisite To Manage Interunit Transfer Pricing and Additional Costs

Before defining your transfer pricing structure, you must setup the overall interunit transfer structure. The *PeopleSoft Inventory* provides detailed instructions for setting up the system for interunit transfers.

See "Understanding Stock Transfers Between Business Units" (PeopleSoft Inventory)

Common Elements Used to Manage Interunit Transfer Pricing and Additional Costs

<i>Field or Control</i>	<i>Description</i>
FERC Code (Federal Energy Regulatory Commission code)	Appears only if you select FERC reporting on the PeopleSoft Inventory Options page.
ChartFields	Chart of accounts used to record accounting entries and journal entries in PeopleSoft applications.
Cost Element	Use this code to categorize the different components of an item's cost and define the debit and credit ChartFields for accounting entries.
Transaction Group	Predefined codes attached to different types of transactions, such as, stocking, issues, adjustments, and so on.
Distribution Type	User-defined codes that are a subset of transaction groups. This enables you to break down a transaction group into customized categories.
Item Group	A grouping of items that enable you to design the accounting structure for a group of similar items, such as, sporting equipment or dress shoes. The item group is attached to an item using the Item Definition - General page.
Affiliate	A ChartField used in interunit transactions or consolidation reporting to identify the other business unit in the transaction. Provides a way to map transactions between business units while using a single intercompany account. The use of an Affiliate ChartField is optional.

Using Transfer Pricing Definitions

This topic provides an overview of transfer pricing definitions and discusses them.

Pages Used to Define Transfer Prices

<i>Page Name</i>	<i>Definition Name</i>	<i>Usage</i>
Transfer Pricing Definition Page	CM_TRAN_PRICE_DEFN	Define the transfer prices, markup percentages, and additional transfer costs to be used for a source business unit or a source and destination unit pair.

Page Name	Definition Name	Usage
<u>Copy Pricing Definition Page</u>	CM_TRAN_PRC_COPY	Enter a source inventory business unit and a destination business unit (optional) to copy an existing transfer pricing definition to another inventory business unit.
<u>Additional Transfer Price (Header Level) Page</u>	CM_TRAN_PRICE_CE	Add or change additional costs at the header level of the transfer pricing definition.
<u>Additional Transfer Price (Detail Level) Page</u>	CM_TRAN_PRICE_CEDT	Add or change additional costs to a item group or item ID (detail level).

Understanding Transfer Pricing Definitions

To define transfer prices, use the Transfer Pricing Definition component (CM_TRAN_PRICE_DEFN). Use the Transfer Pricing Definition component interface (CM_TRAN_PRICE_CI) to load data into the tables for this component.

The key to establishing your transfer price is the Transfer Pricing Definition component, where you can establish transfer prices by:

- **Inventory Business Unit Pairs:** A combination of the source business unit, destination business unit, and pricing effective date.
- **Source Business Unit Only:** A combination of the source business unit and pricing effective date. By leaving the destination business unit blank, you can create transfer prices for all items in the source unit that transfer to any destination business unit that is not already defined in a business unit pair.

The Transfer Pricing Definition component defines the transfer prices for all items within a source business unit or an inventory business unit pair. When a transfer pricing definition has not been setup for certain business units, the system transfers the items at the cost in the source inventory business unit. When a transfer pricing definition is created, setting all transfer prices at the business unit level (header level) may be too broad; therefore, the Transfer Pricing Definition component allow you to override the header level settings with transfer prices specific to the item group or item ID itself. The specific information is used instead of the more general information.

Once you define your transfer pricing definitions, you can:

- Populate the Transfer Pricing table with your transfer prices and additional transfer costs by running the Calculate Transfer Price process. The Deplete On Hand Qty process looks to this table first to find a match and to retrieve transfer data.
- Leave the Transfer Pricing table blank for some or all items. If the Deplete On Hand Qty process cannot find a match in the Transfer Pricing table, then it looks to the setup in the Transfer Pricing Definition components. The detail level overrides are used instead of the header level information. Header level information is used when no detail level overrides exist and the Price Overrides Only check box is not selected.

The Transfer Pricing Definition component can be used by both:

- The Calculate Transfer Price process to populate the Transfer Price table.
- The Deplete On Hand Qty process to calculate a transfer price for an MSR line directly using the data in the Transfer Pricing Definition component. Use this option if the Transfer Price table does not contain a transfer price for the MSR line.

Not all options on the Transfer Pricing Definition component are available when the Deplete On Hand Qty process is calculating a transfer price directly from the component. Look carefully at the field definitions for information about the Calculate Transfer Price process and the Deplete On Hand Qty process.

Note: PeopleSoft Cost Management does not support interunit pricing for non-cost items.

For additional details about applying transfer prices to an MSR, see the Understanding Interunit Transfers topic.

Related Links

[Applying Transfer Prices to a Material Stock Request "Setup Fulfillment Page" \(PeopleSoft Inventory\)](#)

Transfer Pricing Definition Page

Use the Transfer Pricing Definition page (CM_TRAN_PRICE_DEFN) to define the transfer prices, markup percentages, and additional transfer costs to be used for a source business unit or a source and destination unit pair.

Navigation:

Cost Accounting > Item Costs > Define Rates and Costs > Transfer Pricing Definition

This example illustrates the fields and controls on the Transfer Pricing Definition page. You can find definitions for the fields and controls later on this page.

The screenshot displays the 'Transfer Pricing Definition' page. At the top, it shows 'Business Unit US010', 'Destination Unit', 'Price Effective Date 03/24/2009', and '*Status Active'. Below this are 'Default Overrides' with checkboxes for 'Transfer at Zero Price', 'Zero Markup', and 'Zero Additional Costs'. The 'BU Level Defaults' section contains 'Pricing Options' (Actual Cost: Default Actual Cost, Average Cost: Average Day's Receipt, Number of Days: 9999), 'Markup Percent' (Price Markup %: 23.00), 'Markup Cost Element' (*Cost Element Option: Add'l Cost, Markup Cost Element: 751), and 'Additional Costs'. The 'Select Lines' section has '*Select Lines By All' and 'Item / Group' fields. At the bottom is the 'Item / Item Group Definitions' table:

*Select Type	*Item ID / Item Group	Description	*Price Override Action	Transfer Price	*Markup Override Action	Price Markup %	*Cost Element Override Action	Cost Element	*Add'l Cost Override Action	Additional Costs
Group	APPAREL	Apparel	Default		Default	15.00	Default		Default	
Item	10002	Long Sleeve T-Shirt, Mens	Specify		Default		Default		Specify	

New Transfer Pricing Definitions

In add mode, you enter the source inventory business unit in the **Business Unit** field and the destination inventory business units in the **Destination Unit** field. The **Pricing Effective Date** field defaults to today's date if there is no entry. The **Destination Unit** field is not required. If you leave the **Destination Unit** field blank, then the parameters set up on this component apply to the source business unit, regardless of the inventory business unit receiving the stock. The transfer pricing definition with the source business unit and no destination unit is used as the default for all business unit pairs that are not defined. The source business unit must be valid and an open inventory unit.

<i>Field or Control</i>	<i>Description</i>
Copy Pricing Definition	Click this link to access the Copy Pricing Definition page, where you can copy an existing transfer pricing definition to this source inventory business unit, destination unit, and price effective date combination. This link is only available if you are creating a new transfer pricing definition by entering this page in the add mode.

Header Levels and Detail Levels

On the Transfer Pricing Definition page, overrides and default values can be entered at both the header level or the detail level.

Overrides and default values defined at the header level apply to the entire transfer pricing definition. The header level includes the **Default Overrides** group box and the **BU Level Defaults** group box. These values are used with transfers from this source inventory business unit (or source unit and destination unit combination) and for this price effective date. Information added at the header level is used to determine the transfer price for all items that are not overridden at the detail level as long as the Price Overrides Only check box has not been selected.

Overrides and default values defined at the detail level apply to an item group or item ID within the transfer pricing definition. The detail level includes the **Item / Item Group Definitions** group box. These values can be added to override the values defined at the header level.

<i>Field or Control</i>	<i>Description</i>
Price Overrides Only	Select this check box to have the system use only the data in the Item / Item Group Definitions group box. The overrides and default values defined at the header level are not used unless the detail level selects the default option for a specific item ID or item group.

Default Overrides Group Box

The values defined in this group box apply to the header level of this transfer pricing definition. The following zero check boxes prevent the system from performing a particular calculation. These check boxes are not mutually exclusive with their associated value. For example, both a Zero Markup Percent can be entered and the Zero Markup Percent flag checked, though once the **Transfer at Zero Price** field

is selected, selecting the Zero Markup Percent has no additional effect. These check boxes control what is done for any items not overridden at the detail level. Keep in mind that these check boxes are never used for items defined in the detail level of this component. In addition, if the Price Overrides Only check box is selected, then this group box is not used.

Field or Control	Description
Transfer at Zero Price	Select this check box if all items in this transfer pricing definition are to be transferred at no cost; unless overridden at the detail level. If you select this check box, the transfer price row (in IN_DEMAND_TPRC) for each transferred item is created using the item's default cost element with a cost of 0.00.
Zero Markup	Select this check box if all items in this transfer pricing definition are to be transferred at with no markup percentage; unless overridden at the detail level.
Zero Additional Costs	Select this check box if all items in this transfer pricing definition are to be transferred at with no additional transfer costs added to the base transfer price; unless overridden at the detail level.

The check boxes in this group box are used by both:

- The Calculate Transfer Price process to populate the Transfer Price table (CM_TRAN_PRICE).
- The Deplete On Hand Qty process to calculate a transfer price for an MSR line using the data in the Transfer Pricing Definition component. This option is used if the Transfer Price table does not contain a transfer price for the MSR line.

BU Level Defaults Group Box

The default values defined in this group box apply to the entire transfer pricing definition (that is, the header level). These default values are used with transfers from this source inventory business unit (or source unit and destination unit combination) and for this price effective date. When setting up a Transfer Pricing Definition component, keep in mind that your entry in the Price Overrides Only check box changes the use of this group box.

Field or Control	Description
Actual Cost	<p>Select the method for calculating the transfer price for items using the actual cost method on the Cost Profiles page. If this field is left blank, then the system uses the <i>Default Actual Cost</i> value. The options are:</p> <ul style="list-style-type: none"> • <i>Average Day's Receipts</i>: The transfer price is base on a weighted average of receipt costs over the past number of days. Enter the number of days in the Number of Days field in this group box. The Number of Days field is required when this option is selected. The system retrieves the receipts for a date range from the current date back the specified number of days and then the system calculates a weighted average as follows: <i>sum of quantity received times receipt cost divided by total quantity received</i>. This option can only be used by the Calculate Transfer Price process to populate the Transfer Price table. • <i>Default Actual Cost</i>: The transfer price is based on the value in the Default Actual Cost field (DFLT_ACTUAL_COST) on the Define Business Unit Item - General: Common page (BU_ITEMS_INV table). This option is the default value when creating a new transfer pricing definition. If the Deplete On Hand Qty process is calculating a transfer price for an MSR line by directly using the data in the Transfer Pricing Definition component, then this option is the only available choice. • <i>Last Actual Cost</i>: The transfer price is based on the last receipt cost in CM_ACTUAL_COST table. This option can only be used by the Calculate Transfer Price process to populate the Transfer Price table. <p>PeopleSoft Cost Management does not support interunit pricing for non-cost items.</p>

Field or Control	Description
<p>Average Cost</p>	<p>Select the method for calculating the transfer price for items using an average cost methods on the Cost Profiles page.</p> <p>If this field is left blank, then the system uses the <i>Average Purchase Price</i> value. The options are:</p> <ul style="list-style-type: none"> • <i>Average Day's Receipts</i>: The transfer price is based on a weighted average of receipt costs over the past number of days. Enter the number of days in the Number of Days field in this group box. The Number of Days field is required when this option is selected. The system retrieves the receipts for a date range from the current date back the specified number of days and then the system calculates a weighted average as follows: <i>sum of quantity received times receipt cost divided by total quantity received</i>. If no receipts are found for the specified date range, then the system uses the cost in the Average Purchase Price field (AVERAGE_COST) in the Define Business Unit Item - General: Common page (BU_ITEMS_INV table). This option can only be used by the Calculate Transfer Price process to populate the Transfer Price table. • <i>Average Purchase Price</i>: The transfer price used is based on the item's deplete cost method as follows: <ul style="list-style-type: none"> • For items with a cost profile using a deplete cost method of <i>Periodic Weighted Average</i> or <i>Retroactive Weighted Average</i>, the system uses the value in the Average Purchase Price field (AVERAGE_COST) in the Define Business Unit Item - General: Common page (BU_ITEMS_INV table). • For items with a cost profile using a deplete cost method of <i>Perpetual Weighted Average</i>, the system uses the current perpetual average cost located in the CM_PERPCUR_VW table. <p>This option is the default value when creating a new transfer pricing definition. If the Deplete On Hand Qty process is calculating a transfer price for an MSR line by directly using the data in the Transfer Pricing Definition component, then this option is the only available choice.</p> <p>PeopleSoft Cost Management does not support interunit pricing for non-cost items.</p>

Field or Control	Description
Number of Days	Enter the past number of days' worth of receipts to be used to calculate the weight average for the transfer price. This field is required when the <i>Average Day's Receipts</i> value is selected for the Actual Cost field or the Average Cost field.
Price Markup % (price markup percentage)	<p>Define the percentage increase to the initial transfer price of the item. The markup percentage is applied to all cost elements. For example, if you enter a value of 25 in this field and the item includes 75 USD in the cost element 100 (material) and 25 USD in the cost element 601 (landed costs), then the markup is applied to 100 USD for a total markup of 25 USD ($100 \text{ USD} \times 25\% = 25 \text{ USD}$). The markup amount can be applied to the material cost element or to an additional transfer cost element, depending on your entry in the next field (the Cost Element Option field).</p> <p>Be sure to enter a 25% markup as 25, not .25. In addition, you can enter a percentage greater than 100.</p> <p>For the source inventory business unit, a gain is recorded for the difference between the marked up transfer price and the cost of the item. The destination business unit can include the markup in the cost of the item or expense it to another account.</p> <p>This field is used by both the Calculate Transfer Price process (to populate the Transfer Price table) and the Deplete On Hand Qty process (to calculate a transfer price directly from this component).</p>

Field or Control	Description
<p>Cost Element Option</p>	<p>Select the type of cost element to which the markup percentage should be applied. This is the Cost Category defined for the cost element. The options are:</p> <ul style="list-style-type: none"> • <i>Material</i>: The system adds the price markup to the <i>material</i> cost element of the transferred item. If you select this option, you cannot enter a value in the Markup Cost Element field on this page since the system uses the item's material cost element located in the Default Cost Element field on the Define Business Unit Item - General: Common page. • <i>Addl Cost</i>: The system adds the price markup to the <i>additional transfer costs</i> cost element of the transferred item. If you select this option, you must enter a value in the Markup Cost Element field. <p>This field is used by both the Calculate Transfer Price process (to populate the Transfer Price table) and the Deplete On Hand Qty process (to calculate a transfer price directly from this component).</p>
<p>Markup Cost Element</p>	<p>If you have entered the value of <i>Addl Cost</i> in the Cost Element Option field, enter a cost element with the cost category of Addl Trans (Additional Transfer Costs). When the price markup is calculated, it is applied to this cost element. If this field is blank, then the system retrieves the material cost element for the item from the Default Cost Element field defined on the Define Business Unit Item - General: Common page.</p> <p>This field is used by both the Calculate Transfer Price process (to populate the Transfer Price table) and the Deplete On Hand Qty process (to calculate a transfer price directly from this component).</p>
<p>Additional Costs</p>	<p>Click the Additional Costs link (in the BU Level Defaults group box) to access the Additional Transfer Price (Header Level) page, where you can define or change additional transfer costs at the header level of this transfer pricing definition. These costs use a cost element with the cost category of Addl Trans (Additional Transfer Costs). This link and the underlying Additional Transfer Price (Header Level) page can only be used by the Calculate Transfer Price process to populate the Transfer Price table.</p>

Select Lines Group Box

Use the **Select Lines** group box to enter search criteria for displaying existing items and item group definition in the **Item / Item Group Definitions** group box.

Field or Control	Description
Select Lines By	Select to search for rows by <i>Item Group</i> , <i>Item ID</i> , or <i>All</i> .
Item / Group	Enter the item ID or item group ID to be used when selecting data for the Item / Item Group Definitions group box. The search returns rows with a value equal to or greater than the item ID or item group defined. If this field is left blank, the search returns both item IDs and item groups.
Number of Lines	Enter the number of rows to be displayed in the Item / Item Group Definitions group box. If this field is blank, then the search uses a default of 100 rows. This field is populated by a default value from the Transfer Price Lines Displayed field on the Installation Options - Inventory page.
Select Lines	Click this button to search for rows previously created for items and item groups in the Item / Item Group Definition group box. The rows that appear are limited by your search criteria (Select Lines By field, Item / Group field, and Number of Lines field). To display other rows, change your search criteria and then click this button to initiate a new search; a warning message is displayed asking if you want to save changes to the existing date.

Item / Item Group Definitions Group Box

The detail level overrides and default values defined in this group box apply to the specific item ID or item group in the row. The values entered here override the same values entered at the header level. To create a new row to override header level attributes for a specific item ID or item group, add a new row to the grid.

Field or Control	Description
Select Type	When adding a new row, select to add an <i>Item</i> or <i>Group</i> to specify what type of value will be entered in the Item ID / Item Group field.

Field or Control	Description
Item ID / Item Group	Enter either an item ID or an item group depending on your entry in the Select Type field. An row in this grid overrides the header level parameters used to calculate the transfer price. If a destination business unit has been specified, the item ID must be valid in both business units.
Description	Displays the description of the item ID or item group.
Price Override Action	<p>Enter a value to determine the origin of the transfer price. The options are:</p> <ul style="list-style-type: none"> • <i>Default:</i> Use the pricing method specified at the header level of the transfer pricing definition. • <i>Specify:</i> Use the transfer price entered in the Transfer Price field on this row.
Transfer Price	<p>Enter a transfer price to override the calculation at the header level of this transfer pricing definition. To use this field, you must select the value of <i>Specify</i> for the Price Override Action field in this row. If the field is blank, then the system uses a zero price for the transfer.</p> <p>This field is used by both the Calculate Transfer Price process (to populate the Transfer Price table) and the Deplete On Hand Qty process (to calculate a transfer price directly from this component).</p>
Markup Override Action	<p>Enter a value to determine the origin of the markup percentage applied to the transfer price. The options are:</p> <ul style="list-style-type: none"> • <i>Default:</i> Use the markup percentage specified at the header level of the transfer pricing definition. • <i>Specify:</i> Use the percentage entered in the Price Markup % field on this row.

Field or Control	Description
Price Markup %	<p>Enter a markup percentage to be applied to the transfer price. This field overrides the markup percentage at the header level of this transfer pricing definition. To use this field, you must select the value of <i>Specify</i> for the Markup Override Action field in this row. If the field is blank, then the system does not use a markup percentage on the transfer price.</p> <p>This field is used by both the Calculate Transfer Price process (to populate the Transfer Price table) and the Deplete On Hand Qty process (to calculate a transfer price directly from this component).</p>
Cost Element Override Action	<p>Select the type of cost element to which the markup percentage should be applied. The options are:</p> <ul style="list-style-type: none"> • <i>Material</i>: The system adds the price markup to the <i>material</i> cost element of the transferred item. If you select this option, you cannot enter a value in the Cost Element field of this row since the system uses the item's material cost element. The system retrieves the material cost element for the item from the Default Cost Element field defined on the Define Business Unit Item - General: Common page. • <i>Default</i>: The system uses the values in the Markup Cost Element group box at the header level of this transfer pricing definition. • <i>Specify</i>: The system uses the override value in the Cost Element field in this row. This cost element must have a cost category of <i>Addl Trans</i> (additional transfer costs).
Cost Element	<p>Enter a cost element with a cost category of <i>Addl Trans</i> (additional transfer costs). The markup percentage is applied to this cost element if you have selected the value of <i>Specify</i> for the Cost Element Override Action field on this row.</p> <p>This field is used by both the Calculate Transfer Price process (to populate the Transfer Price table) and the Deplete On Hand Qty process (to calculate a transfer price directly from this component).</p>

Field or Control	Description
<p>Add'l Cost Override Action (additional cost override action)</p>	<p>Enter a value to determine the origin of the <i>Addl Trans</i> cost elements applied to the transfer price. The options are:</p> <ul style="list-style-type: none"> • <i>Default</i>: Use the <i>Addl Trans</i> cost elements specified in the Additional Transfer Price (Header Level) page of this transfer pricing definition. To access this page, click the Additional Costs link within the BU Level Defaults group box. • <i>Specify</i>: Use the <i>Addl Trans</i> cost elements entered in the Additional Transfer Price (Detail Level) page of this row. To access this page, click the Addl Costs icon on this row. <p>This field can only be used by the Calculate Transfer Price process to populate the Transfer Price table.</p>
<p> (Addl Costs)</p>	<p>Click the Additional Costs icon to access the Additional Transfer Price (Detail Level) page, where you can add or change additional costs to a item group or item ID (detail level). This link and the underlying Additional Transfer Price (Detail Level) page can only be used by the Calculate Transfer Price process to populate the Transfer Price table.</p>

Copy Pricing Definition Page

Use the Copy Pricing Definition page (CM_TRAN_PRC_COPY) to enter a source inventory business unit and a destination business unit (optional) to copy an existing transfer pricing definition to another inventory business unit.

Navigation:

Click the **Copy Pricing Definition** link on the Transfer Pricing Definition page.

This example illustrates the fields and controls on the Copy Pricing Definition page. You can find definitions for the fields and controls later on this page.

When setting up the transfer pricing definitions for each of your source unit, destination unit, and price effective date combinations, you can reduce data entry time by using the copy feature on the Copy Pricing Definition page. Enter a source inventory business unit and a destination business unit (optional) Use this page to copy an existing transfer pricing definition to your new combination of source business unit, destination unit, and price effective date. This page is only available if you are adding a new transfer pricing definitions.

Field or Control	Description
Business Unit	Enter the source business unit for an existing transfer pricing definition that you wish to copy. The default value for this field is the source business unit defined on the new Transfer Pricing Definition page.
Destination Unit	(Optional) Enter the destination business unit for an existing transfer pricing definition that you want to copy. The default value for this field is the destination unit defined on the new Transfer Pricing Definition page.
Price Effective Date	Enter the effective date for the existing transfer pricing definition that you want to copy. The Look Up icon displays existing price effective dates based your entries in the Business Unit and Destination Unit fields.
Copy Detail	Select this check box to copy the item and item group overrides (the Item / Item Group Definitions group box) from the existing transfer pricing definition to your new definition. The Additional Transfer Price (Detail Level) page is also copied. Note: In order to copy item and item group details, the business units must share the same available items. Item groups are not edited.

The copy action immediately saves the new data and overrides any existing information that you may have entered on the new transfer pricing definition.

Additional Transfer Price (Header Level) Page

Use the Additional Transfer Price (Header Level) page (CM_TRAN_PRICE_CE) to add or change additional costs at the header level of the transfer pricing definition.

Navigation:

On the Transfer Pricing Definition page, click the **Additional Costs** link in the **BU Level Defaults** group box.

This example illustrates the fields and controls on the Additional Transfer Price page at the header level. You can find definitions for the fields and controls later on this page.

This page displays the cost element detail for the header level of the transfer pricing definition and allows you to enter additional transfer costs using cost elements with a cost category of *Add'l Trans*. This page can only be used by the Calculate Transfer Price process to populate the Transfer Price table.

Field or Control	Description
Cost Element Option	Select the cost category of the cost element for this row. The options are <i>Material</i> or <i>Add'l Cost</i> . If you select the <i>Material</i> option, the Cost Element field must remain blank.
Cost Element	Select a <i>Add'l Trans</i> cost element for this row. The cost element does not have to be unique. If the cost element field is blank, then the system retrieves the material cost element for the item from the Default Cost Element field defined on the Define Business Unit Item - General: Common page.
Description	Displays the description of the cost element.
Comment	(Optional) Enter a comment about this additional charge.
Additional Fee	Enter a amount to be applied to transfers using the cost element specified on this row.

Field or Control	Description
Markup % (markup percentage)	<p>Define the percentage increase to the initial transfer price of the item. The markup percentage is applied to all cost elements. For example if you enter a value of 25 in this field and the item includes 75 USD in the cost element 100 (material) and 25 USD in the cost element 601 (landed costs) then the markup is applied to 100 USD for a total markup of 25 USD (100 USD x 25%= 25 USD). The markup amount can be applied to the material cost element or to an additional transfer cost element depending on your entry in the Cost Element Option field of this row.</p> <p>Be sure to enter a 25% markup as 25, not .25. In addition, you can enter a percentage greater than 100.</p>

Additional Transfer Price (Detail Level) Page

Use the Additional Transfer Price (Detail Level) page (CM_TRAN_PRICE_CEDT) to add or change additional costs to a item group or item ID (detail level).

Navigation:

On the Transfer Pricing Definition page, click the **Addl Costs** icon in the **Item / Item Group Definitions** group box.

This example illustrates the fields and controls on the Additional Transfer Price page at the detail level. You can find definitions for the fields and controls later on this page.

The screenshot shows the 'Additional Transfer Price' window. At the top, it displays 'Business Unit US008', 'Destination Unit US009', and 'Price Effective Date 02/25/2013'. Below this is a table titled 'Additional Costs' with columns: 'Cost Element Option', 'Cost Element', 'Description', 'Comment', 'Additional Fee', and 'Markup %'. The table contains two rows: one for 'Addl Cost' with cost element 751 (Air Freight) and an additional fee of 20,000; and another for 'Material' with cost element 750 (Handling Cost) and a markup of 2.00. At the bottom of the window are 'OK', 'Cancel', and 'Refresh' buttons.

This page displays the cost element detail for the detail level of the transfer pricing definition and allows you to enter additional transfer costs using cost elements with a cost category of *Addl Trans*. The top section of this page displays the item ID or item group for these additional prices. The field definitions are the same as the Additional Transfer Price (Header Level) page defined above. This page can only be used by the Calculate Transfer Price process to populate the Transfer Price table.

Related Links

[Additional Transfer Price \(Header Level\) Page](#)

Reviewing Examples of Transfer Pricing

The following examples show how the transfer price default hierarchy uses the Transfer Pricing Definition component. In the examples below, the fields used on the Transfer Pricing Definition component can be used by the Calculate Transfer Price process to build the Transfer Pricing table and by the Deplete On Hand Qty process to directly calculate the MSR line transfer price.

Transfer Pricing Definition 1: Source business unit: US001, Destination business unit: (blank), and Price Effective Date: 10/15/2009

- Header Level:

Price Overrides Only check box	Price Markup %	Cost Element Option	Markup Cost Element
Not selected	20%	Add'l Cost	751

- Detail Level:

Item ID	Transfer Price	Price Markup %	Cost Element
80200	Specify: 4.00	Specify: 4%	Specify: 750

Transfer Pricing Definition 2: Source business unit: US001, Destination business unit: US014, and Price Effective Date: 10/15/2009

- Header Level:

Price Overrides Only check box	Price Markup %	Cost Element Option	Markup Cost Element
Not selected	15%	Add'l Cost	750

- Detail Level:

Item ID	Transfer Price	Price Markup %	Cost Element
80400	Specify: 18.18	Specify: 10%	Default
80500	Specify: 7.00	Specify: 5%	Specify: 751

The following item and cost information are used in these examples:

<i>Item ID</i>	<i>Cost Method</i>	<i>Cost Element</i>	<i>Cost</i>
80100	Perpetual Average	Material: 100	11.00 (current perpetual average)
80200	Perpetual Average	Material: 100	10.00 (current perpetual average)
		Landed Cost- Duty: 601	1.00
80300	Actual	Material: 100	10.10 (default actual cost)
80400	Perpetual Average	Material: 100	10.00 (current perpetual average)
		Landed Cost- Duty: 601	1.00
80500	Perpetual Average	Material: 100	5.00 (current perpetual average)
		Landed Cost- Duty: 601	.25
80600	Standard cost	Material: 100	10.00 (current standard)

Example 1

In this example, the following results will occur (for the US001/US014 combination only) when the Calculate Transfer Price process populates the Transfer Pricing table or when the Deplete On Hand Qty process calculates the transfer prices directly for MSR lines. In both cases, to populate transfer prices and cost elements for the source business unit US001 and the destination business unit US014, the processes (using the transfer price default hierarchy) look first to the transfer pricing definition 2; if data cannot be found then the processes look to the transfer pricing definition 1.

<i>Item ID</i>	<i>Cost Element</i>	<i>Transfer Price</i>	<i>Comments</i>
80100	100	11.00	On the transfer pricing definition 2 no detail information for this item is found, so the header information is used. A 15% markup is applied to the current perpetual average cost and added to the 750 cost element.

<i>Item ID</i>	<i>Cost Element</i>	<i>Transfer Price</i>	<i>Comments</i>
	750	1.65	
80200	100	10.00	On the transfer pricing definition 2 no detail information for this item is found, so the header information is used. A 15% markup is applied to the current perpetual average cost and added to the 750 cost element. In addition, the landed costs in the cost element 601 is added to the transfer price.
	601	1.00	
	750	1.50	
80300	100	10.10	On the transfer pricing definition 2 no detail information for this item is found, so the header information is used. A 15% markup is applied to the default actual cost and added to the 750 cost element.
	750	1.515	
80400	100	18.18	Detail information for this item is found on the transfer pricing definition 2. A transfer price of 18.18 is applied to the material cost element and a 10% markup of the transfer price is applied to the 750 cost element.
	750	1.81	

<i>Item ID</i>	<i>Cost Element</i>	<i>Transfer Price</i>	<i>Comments</i>
80500	100	7.00	Detail information for this item is found on the transfer pricing definition 2. A transfer price of 7.00 is applied to the material cost element and a 5% markup of the transfer price is applied to the 751 cost element.
	751	.35	
80600	100	10.00	On the transfer pricing definition 2 no detail information for this item is found, so the header information is used. A 15% markup is applied to the current frozen standard cost and added to the 750 cost element.
	750	1.50	

Example 2

In this example, all information is the same as example 1 except the Price Overrides Only check box is selected on the transfer pricing definition 2. The following results will occur (for the US001/US014 combination only) when the Calculate Transfer Price process populates the Transfer Pricing table or when the Deplete On Hand Qty process calculates the transfer prices directly for MSR lines. Since the transfer pricing definition 2 is more specific, the processes (using the transfer price default hierarchy) look first to it. If data cannot be found then the processes look to the transfer pricing definition 1.

<i>Item ID</i>	<i>Cost Element</i>	<i>Transfer Price</i>	<i>Comments</i>
80100	100	11.00	No detail information for this item is found on the transfer pricing definition 2, so the header information is used from the transfer pricing definition 1. A 20% markup is applied to the current perpetual average cost and added to the 751 cost element.

<i>Item ID</i>	<i>Cost Element</i>	<i>Transfer Price</i>	<i>Comments</i>
	751	2.20	
80200	100	4.00	No detail information for this item is found on the transfer pricing definition 2, so the detail information is used from the transfer pricing definition 1. A transfer price of 4.00 is applied to the material cost element and a 4% markup of the transfer price is applied to the 750 cost element.
	750	.16	
80300	100	10.10	No detail information for this item is found on the transfer pricing definition 2, so the header information is used from the transfer pricing definition 1. A 20% markup is applied to the default actual cost and added to the 751 cost element.
	751	2.02	
80400	100	18.18	Detail information for this item is found on the transfer pricing definition 2. A transfer price of 18.18 is applied to the material cost element and a 10% markup of the transfer price is applied to the 750 cost element. Note that the detail level of the transfer pricing definition 2 instructs the system to use the header level default for the cost element even though the Price Overrides Only check box has been selected.
	750	1.81	

<i>Item ID</i>	<i>Cost Element</i>	<i>Transfer Price</i>	<i>Comments</i>
80500	100	7.00	Detail information for this item is found on the transfer pricing definition 2. A transfer price of 7.00 is applied to the material cost element and a 5% markup of the transfer price is applied to the 751 cost element.
	751	.35	
80600	100	10.00	No detail information for this item is found on the transfer pricing definition 2, so the header information is used from the transfer pricing definition 1. A 20% markup is applied to the current frozen standard cost and added to the 751 cost element.
	751	2.00	

Populating the Transfer Price Table

This topic provides an overview of the transfer price feature and discusses how to populate the Transfer Price table.

Page Used to Populate the Transfer Price Table

<i>Page Name</i>	<i>Definition Name</i>	<i>Usage</i>
<u>Calculate Transfer Price Page</u>	CM_TRAN_PRICE_REQ	Run the Calculate Transfer Price process to populate the CM_TRAN_PRICE table with the transfer prices to be used.

Understanding the Transfer Price Feature

The transfer price feature enables you to populate the Transfer Price table (CM_TRAN_PRICE) with the transfer prices (material and additional transfer costs) that are used by the system when an MSR transfers stock. The Calculate Transfer Price process (CM_TRANS_PRC) populates this table based on your setup in the Transfer Pricing Definition component. Populating the Transfer Price table is optional, you can

choose to have the system create the transfer price based on the currently available data and setup rather than using the values in this table.

Note: The performance of the Deplete On Hand Qty process can be affected if the Transfer Price table contains a large number of rows. Consider the size of the table when you design your transfer price method.

See [Applying Transfer Prices to a Material Stock Request](#).

Calculate Transfer Price Page

Use the Calculate Transfer Price page (CM_TRAN_PRICE_REQ) to run the Calculate Transfer Price process to populate the CM_TRAN_PRICE table with the transfer prices to be used.

Navigation:

Cost Accounting > Item Costs > Update Costs > Calculate Transfer Price

This example illustrates the fields and controls on the Calculate Transfer Price process page. You can find definitions for the fields and controls later on this page.

Run Control ID PRICE
Report Manager Process Monitor
Run

Process Request Parameters
Find | View All
First 1 of 1 Last

Process Frequency

Process Once

Always Process

Don't Run

*Request ID

Description

*As of Date Create Errors for No Receipts

Source Business Unit

All Business Units

Business Unit

To Business Unit

Destination Business Unit

All Business Units

Default Destination BU

Destination BU

Show Results

Selected Business Units
Personalize | Find | View All
First 1-2 of 2 Last

	Business Unit	Destination Unit	Price Effective Date	Choose One (Optional)
1	GBR03		01/01/1900	<input type="checkbox"/>
2	US008		01/01/1900	<input type="checkbox"/>

Item Options

All Items Single Item Item Group

Item ID

Item Group

Field or Control	Description
As of Date	Determines the set of parameters to use when calculating the transfer price. This date controls the effective date used to retrieve rows defined on the Transfer Pricing Definition component and to retrieve actual cost rows for pricing calculations. In addition this date is the new Price Effective Date set in the Transfer Price record.
Create Errors for No Receipts	Select this check box to have the process log error messages when the calculation method is Last Price Paid, First Price Paid, or Average N, and there are no receipts for a source business unit and item ID . Use caution when selecting this check box as the number of log messages could potentially be quite high.

Source Business Unit Group Box

This process can only select source PeopleSoft Inventory business units that:

- Are valid for the user running this process.
- Have an open status on the Inventory Definition - Business Unit Definition page.
- Have the **Generate InterUnit Prices** check box selected on the Inventory Definition - Business Unit Definition page.
- Have an existing transfer pricing definition record with a status of Active.

Field or Control	Description
All Business Units	Select this check box to have the process include all valid PeopleSoft Inventory business units as the source business units.
Business Unit and To Business Unit	Enter a range of source Inventory business units. If this run control should process one source business unit, enter the unit in the Business Unit field. If you want to process a range of business units, enter the starting unit in the Business Unit field and the ending business unit in the To Business Unit field. The system processes all Inventory business units, sorted in alphanumerical order, that fall between the starting and ending unit.

Destination Business Unit Group Box

The **Destination Business Unit** group box enables you to select destination business unit that are paired with the source unit on a transfer pricing definition. You can select combinations with a blank destination, a specific destination unit, or all valid combinations. This process can only select destination PeopleSoft

Inventory business units that have, in combination with the source unit, an existing transfer pricing definition record with an active status.

Field or Control	Description
All Business Units	Select this check box to have the process include all valid PeopleSoft Inventory business units as the destination business units. This check box includes transfer pricing definitions with a combination of source and destination units and transfer pricing definitions with a blank destination unit.
Default Destination BU	Select this check box to have the process calculate transfer prices for the source business unit for which the destination unit is always blank. This check box cannot be used in combination with the All Business Units check box mentioned previously.
Destination BU	Enter a specific destination Inventory business unit. The process only uses transfer pricing definitions with a source/destination unit pair that specify this destination unit.
Show Results	Click this button to display the valid source unit, destination unit, and price effective date combinations that can be processed based on your parameters. The search results appear in the Selected Business Units group box. You can keep current search results and change parameters to add additional combinations to the Selected Business Units group box.

Selected Business Units Group Box

This group box displays the results of the search initiated by the **Show Results** button on this page. Clicking this button displays the valid source unit, destination unit, and price effective date combinations that can be processed based on your parameters. In order for a combination to be selected, the following rules apply:

- The source and destination unit combinations must have a transfer pricing definition with a price effective date matching the **As of Date** field on this page.
- The transfer pricing definition must have a status of Active.
- The business units must:
 - Have the **Generate InterUnit Prices** check box selected on the Inventory Definition - Business Unit Definition page.
 - Be valid for the user running this process.
 - Have an open status on the Inventory Definition - Business Unit Definition page.

<i>Field or Control</i>	<i>Description</i>
Choose One (Optional)	Select a row in the Selected Business Units group box to choose just one combination for processing. The system populates the source and destination business unit values above and collapses the grid area.

Item Options Group Box

Use the **Item Options** group box to calculate transfer prices based on item ID or item group.

<i>Field or Control</i>	<i>Description</i>
All Items	Select to include all items within the source business unit. This value is the default.
Single Item	Select to limit this process run to one specific item within the source business unit. Enter the item in the Item ID field in this group box.
Item Group	Select to limit this process run to one specific item group within the source business unit. Enter the item group in the Item Group field in this group box.

Note: When you save this run control, the system performs a check of existing transfer prices in the Transfer Pricing table. Based on your parameters, if this process run could overwrite existing transfer prices, then a warning message will appear.

Calculating Default Actual Cost and Current Purchase Cost

This topic provides an overview of costs and discusses how to use the Update Default Actual Cost process.

Page Used to Calculate Default Actual Cost and Current Purchase Cost

<i>Page Name</i>	<i>Definition Name</i>	<i>Usage</i>
<u>Update Default Actual Cost Page</u>	RUN_CM_DFLTCOST	Calculate the value to be stored in the Default Actual Cost field or the Current Purchase Cost field on the Define Business Unit Item - General: Common page.

Understanding Costs

The values in the **Default Actual Cost** field and the **Current Purchase Cost** field are used by both processes and reports when a item value is needed. These fields are located on the Define Business Unit Item - General: Common page. The value in these fields can be manually updated or you can use the Update Default Actual Cost (CM_BUCST_UPD) process to automatically update these field.

Understanding Default Actual Cost and Current Purchase Cost

The **Default Actual Cost** field is used as the actual or average cost if the item does not yet have an actual cost generated from the receipt and putaway processes. This value is stored in the **DFLT_ACTUAL_COST** field of the BU_ITEMS_INV record. The Default Actual Cost is used in these processes and reports:

- The Deplete On Hand Quantity process (IN_FUL_DPL). This field value is used to determine the transfer cost of an interunit transfer when the Transfer Pricing Definition component uses the default actual cost option.
- The Reconciliation Report (INS5050) and the Stock Quantity Update process (INPOPOST) for a inventory stock count (physical count or cycle count). This field value is used to record a positive inventory adjustment when a receipt cost is not found.
- The Adjustments page (ADJUSTMENT2_INV). The field value is used if the item requires a positive inventory adjustment prior to an actual cost being generated from receipt of the item.
- The Cost Rollup process in PeopleSoft Manufacturing uses this field value as a preliminary cost if a receipt cost is not found.
- The Interunit and RMA Receiving component uses the value in the **Default Actual Cost** field to cost the receipt of items using actual cost.
- The Utilization Type Calculation Summary report (INS5100)
- The Slow Moving Inventory report (INS5200) uses this field value if a receipt cost is not found.

The **Current Purchase Cost** field is used in PeopleSoft Manufacturing. This value is stored in the **CURRENT_COST** field of the BU_ITEMS_INV record. The Cost Rollup process in PeopleSoft Manufacturing uses this field value as an optional source to calculate the value of a standard-cost item. The **Current Purchase Cost** field is used to determine the material cost of purchased items and the lower-level material cost of a manufactured item when the cost type that you are rolling uses current costs.

Understanding the Update Default Actual Cost Process

The Update Default Actual Cost (CM_BUCST_UPD) process is a PeopleSoft Application Engine program that can update the **Default Actual Cost** field and the **Current Purchase Cost** field for all the items regardless of the item's cost profile. Before running this process, be sure to run the Cost Accounting Creation process to update the PeopleSoft Cost Management tables for any new receipts, cost adjustments, PeopleSoft Payable cost adjustments, or PeopleSoft Manufacturing finalized cost adjustment transactions. Based on your search criteria, the process:

- Includes all the zero cost receipts, as they are originally part of average cost calculation during putaway.

- Excludes cancelled receipts.
- For consigned inventory items, includes all receipts irrespective of the consumption for consigned inventory items.
- Rolls up all the cost elements into one default actual cost for each item, receiver ID, receiver line, distribution line before calculating the new cost.
- Excludes manufacturing transactions with a cost source of 8 (Preliminary Production Cost).

Note: After the Update Default Actual Cost process is completed, you can query the PS_CM_ACT_COST_TMP and PS_CM_AVG_RCST_TMP tables to see what receipts were used during the cost calculation. These tables are cleared during the next run.

Update Default Actual Cost Page

Use the Update Default Actual Cost page (RUN_CM_DFLTCOST) to calculate the value to be stored in the Default Actual Cost field or the Current Purchase Cost field on the Define Business Unit - General: Common page.

Navigation:

Cost Accounting > Item Costs > Update Costs > Update Default Actual Cost

This example illustrates the fields and controls on the Update Default Actual Cost page. You can find definitions for the fields and controls later on this page.

The screenshot shows the 'Update Default Actual Cost' page with the following sections:

- Run Control:** Run Control ID: DAILY, Report Manager, Process Monitor, Run button.
- Process Request Parameters:**
 - Process Frequency: Process Once, Always Process, Don't Run.
 - *Request ID: DAILY
 - Description: [Empty field]
 - *Business Unit: US010, All Business Units
- Item Selection Option:**
 - All Items, Item Range, Item Group
 - From Item ID: 10003, To Item ID: 10010
 - Item Group: [Empty field]
 - Item Examples: Long Sleeve Biking Jersey, Wom; Mountain Bike Gloves, Womens
- Cost Update Selection:**
 - Update Default Actual Cost
 - Update Current Cost
 - Update Both
- Cost Update Options:**
 - Use Last Actual Cost
 - Use Average of Receipt Costs
 - Use BU Average Cost
 - Number of Days: [Empty field]

Use the Update Default Actual Cost process to update the cost fields Default Actual Cost (DFLT_ACTUAL_COST) and Current Purchasing Cost (CURRENT_COST) in the Define Business Unit Item - General: Common page (BU_ITEMS_INV).

Field or Control	Description
Business Unit	Enter the PeopleSoft Inventory business unit in which the process updates the cost fields for item IDs in that business unit. All items meeting the search criteria on this page are updated, regardless of the cost profile used.
All Business Units	<p>Select all Inventory business units. The process updates the cost fields for the specified item IDs in all of the business units.</p> <p>If row-level security is enabled, then the user must have security access to all of the Inventory business units for the process to run the cost calculations.</p>
All Items	Select this option to include all items in the business units that meet the search criteria of this page.
Item Range	Select this option to define a range of item IDs to be processed.
Item Group	Select this option to define an item group ID to be processed.
From Item ID and To Item ID	Enter a range of item IDs to be processed. The system includes all items in the alphanumeric sequence. The Item Range option must be selected to enter values in these fields.
Item Group	<p>Enter an item group ID to be processed. The Item Group option must be selected to enter a value in this field.</p> <p>If the Item Group option is selected and the Item Group field is left blank, then the process includes only the items that do not have an item group assigned on the Define Item - General: Common page (MASTER_ITEM_TBL table).</p>
Cost Update Selection	<p>Select the cost fields to be updated by this process. The options are:</p> <ul style="list-style-type: none"> • <i>Update Default Actual Cost:</i> Select to update the value in the Default Actual Cost field (DFLT_ACTUAL_COST) in the Define Business Unit Item - General: Common page (BU_ITEMS_INV). • <i>Update Current Cost:</i> Select to update the value in the Current Purchasing Cost field (CURRENT_COST) in the Define Business Unit Item - General: Common page (BU_ITEMS_INV). • <i>Update Both:</i> Select to update the values in the Default Actual Cost field and the Current Purchasing Cost field in the Define Business Unit Item - General: Common page. Both fields are updated with the same cost calculation.

Field or Control	Description
Cost Update Options	<p>Choose the method to update the cost fields. The options are:</p> <ul style="list-style-type: none"> • <i>Use Last Actual Cost:</i> The value in the cost field is based on the last receipt cost in CM_ACTUAL_COSTB table for the selected item. The process combines all of the cost elements in the last receipt. If the items included in your selection criteria do not have any receipts in the business unit, then the process cannot update the cost fields. • <i>Use Average of Receipt Costs:</i> The value in the cost field is based on a weighted average of receipt costs over the past number of days, starting with the current date. Enter the number of days in the Number of Days field in this group box. The Number of Days field is required when this option is selected. This calculation excludes any cancelled receipts and then averages all of the receipt costs. If the items included in your selection criteria do not have any receipts in the business unit, then the process cannot update the cost fields. • <i>Use BU Average Cost:</i> The value in the cost field is current value in the Average Purchase Price field (AVERAGE_COST) on the Define Business Unit Item - General: Common page (BU_ITEMS_INV).
Number of Days	Enter the past number of days' worth of receipts to be used to calculate the weight average for the transfer price. The field is required when the option <i>Use Average of Receipt Costs</i> is selected.

Viewing Transfer Pricing Data for an Item

This topic discusses how to use the transfer price inquiry, which is an online inquiry page that enables you to view the transfer pricing setup for an item.

Pages Used to View Transfer Pricing Data for an Item

Page Name	Definition Name	Usage
<u>Transfer Price Inquiry Page</u>	CM_TRAN_PRICE_INQ	View the transfer pricing data for a specific item ID.
Source / Dest BU Lookup Page	CM_IU_PAIR_LOOKUP	View the source and destination business unit pairs created for the item.

Transfer Price Inquiry Page

Use the Transfer Price Inquiry page (CM_TRAN_PRICE_INQ) to view the transfer pricing data for a specific item ID.

Navigation:

Cost Accounting > Item Costs > Review Costs > Transfer Price Inquiry

This example illustrates the fields and controls on the Transfer Price Inquiry page. You can find definitions for the fields and controls later on this page.

Transfer Price Inquiry

*Item ID Refrigerator, Ice Trays

Source BU Destination BU [Source / Dest BU Lookup](#)

Price Effective Date

Cost Method Perpetual Weighted Average Transfer Price 6.0051

Transfer Pricing Definition

Price Effective Date 09/28/2009 Pricing Option Average Purchase Price

Transfer Price Price Markup % 5.00

Number of Days Markup Cost Element 750

Additional Costs [Personalize](#) | [Find](#) | [View All](#) | | [First](#) | 1 of 1 | [Last](#)

Cost Element	Comment	Price Markup %	Additional Fee

Transfer Prices

Calculated Transfer Prices [Personalize](#) | [Find](#) | [View All](#) | | [First](#) | [Last](#)

Effective Date	Cost Element	Description	Transfer Price
02/20/2013			

The Transfer Price Inquiry page displays the transfer pricing details for the combination of a specific item ID, source business unit, destination unit, and price effective date.

Field or Control	Description
Search	Click this button to search for transfer pricing data based on your entries in the Item ID , Source BU , Destination BU , and Price Effective Date fields.
Source / Dest BU Lookup	Click this link to access the Source / Dest BU Lookup page, where you can view the source and destination business unit pairs that were created for the item.
Cost Method	Displays the Deplete Cost Method from the Cost Profile used for this item ID in the source Inventory business unit.

Field or Control	Description
Transfer Price	<p>Displays the transfer price that would be used for this item. In some cases, the most current transfer price is determined by the Deplete On Hand Qty process; therefore, this price may be just an estimate.</p> <p>The field is calculated at the time of display using the transfer pricing hierarchy defined in this topic.</p> <p>See Applying Transfer Prices to a Material Stock Request.</p>

Transfer Pricing Definition Group Box

This group box displays the values from the Transfer Pricing Definition component that apply to this item ID based on source unit, destination unit, and price effective date. The data displays any override values entered at the item ID or item group level as well as any additional cost data from the Additional Transfer Price page.

Transfer Prices Group Box

This group box displays values from the Transfer Pricing table. This table is optional and is populated by the Calculate Transfer Price process.

Reviewing Interunit Accounting Examples

This section provides an overview of interunit accounting examples and reviews examples of:

- Transferring interunit stock using only an intransit account.
- Transferring interunit stock using interunit receivables and payables.
- Transferring interunit stock using the interunit sales approach (intercompany).

Understanding Interunit Accounting Examples

This table describes the accounting entries that you can create using the three different types of interunit stock transfers

Type of Transfer	Description	Examples
Interunit transfer using only an intransit account	The cost of the inventory stock is entered into an intransit account while being moved from one inventory business unit to another. Use this approach when both inventory business units post to the same general ledger.	Example 1

Type of Transfer	Description	Examples
Interunit transfer using interunit receivables and interunit payables accounts	An intransit account is used along with interunit receivables and payables accounts recorded for each inventory business unit. Both inventory business units post to different general ledger business units. Use this approach when transferring stock between separate legal entities or within the same legal entity.	Examples 2.1 to 2.3
Interunit sales approach (intercompany)	An intercompany sale is recorded with the source inventory business unit recording a sale and the linked billing business unit issuing a voucher (invoice) for the stock transfer to the payable unit of the receiving business unit. Use this approach when transferring stock between separate legal entities or within the same legal entity. The Intercompany method is required if the GL business units use different currencies.	Examples 3.1 to 3.4

All of the examples use the following cost elements:

- 100 (Material- General)
- 601 (Landed- Duty)
- 751 (Addl Trans- Freight)

Determining the Inventory Account

For all the examples below, the location accounting feature determines how the system selects the ChartField combination used for the inventory stock account. The inventory account is debited for receipt of stock and credited for shipment of stock. The location accounting feature is turned on at the business unit level by selecting the Location Accounting Required check box on the Inventory Options page (Set Up Financials/Supply Chain, Business Unit Related, Inventory, Inventory Options).

- If the Location Accounting Required check box is not selected, the inventory account is derived from the Accounting Rules page (Account Distribution page) for the applicable transaction group.
- If the Location Accounting Required check box is selected, the inventory account is derived from the storage area from which the inventory is shipped.

Determining the Intransit Account

For all the examples below, the intransit inventory account defined using the inventory business unit combinations on the InterUnit Ownership page or from the intransit account defined in the centralized interunit and intraunit processor.

Transferring Interunit Stock Using Only an Intransit Account

This example illustrates a stock transfer from inventory business unit US012 to inventory business unit US013. Both of these business units post to the same general ledger (US003); in this case, US012 owns the intransit inventory until it is received at the requesting business unit. The item uses the actual-cost method. In this example, the item cost and the transfer price for the item differ.

Example 1

The following diagram illustrates the accounting entry for the shipping transaction in the source business unit US012 (transaction group 031- InterBU Transfer Shipments). The inventory account is credited at item cost for the material and landed costs. The intransit account contains the transfer price of material, landed cost, and additional transfer costs. The gain and loss on transfer price account contains the additional transfer cost plus any difference between the transfer price and the cost of the item.

Inventory Acct (source BU)		Intransit Account		Gain/Loss on Transfer Price	
(100)	1400.00	(100)	1500.00	(100)	100.00
(601)	100.00	(601)	100.00	(751)	50.00
		(751)	50.00		

The following diagram illustrates the accounting entry for the putaway transaction in the destination business unit US013 (transaction group 022 - IBU Transfer Receipts). The entire shipment arrives intact, and the intransit account is credited for the transfer price (material, landed, and additional transfer costs). Since the item uses the actual-cost method, the inventory account in US013 is debited for transfer price of the material and landed costs portions. Since the **Expense Transfer Fees** check box for US013 is selected on Inventory Definition - Business Unit Definition page, the additional transfer costs are written off to the gain and loss on transfer price account rather than added to the cost of the item.

Inventory Acct (destination BU)		Intransit Account		Gain/Loss on Transfer Price (destination BU)	
(100)	1500.00	(100)	1500.00	(751)	50.00
(601)	100.00	(601)	100.00		
		(751)	50.00		

Transferring Interunit Stock Using Interunit Receivables and Payables

These examples illustrate stock transfers for inventory business units that post to different PeopleSoft General Ledgers.

Example 2.1

This example illustrates a stock transfer from inventory business unit US001 to inventory business unit US012. These inventory business units post to different general ledgers; inventory unit US001 reports to the GL unit US001 and inventory unit US012 reports to the GL unit US003. The source inventory business unit, US001, owns the intransit inventory until it is received. The item uses an actual or average-cost method. The units use the same currency. In this case there is a difference between the item cost and the transfer price for the item. During setup, the intercompany (interunit sales approach) method was not selected for these two units.

The following diagram illustrates the accounting entry for the shipping transaction in the source business unit US001 (transaction group 031 - InterBU Transfer Shipments). The inventory account is credited, at item cost, for the material and landed costs. The intransit account contains the transfer price of material, landed, and additional transfer costs. The gain and loss on transfer price account contains the additional transfer cost plus any difference between the transfer price and the cost of the item.

Inventory Acct (source BU)		Intransit Account		Gain/Loss on Transfer Price	
(100)	1400.00	(100)	1500.00	(100)	100.00
(601)	100.00	(601)	100.00	(751)	50.00
		(751)	50.00		

The following diagram illustrates the accounting entry for the putaway transaction in the destination business unit US012 (transaction group 022 - IBU Transfer Receipts). The entire shipment arrives intact and the intransit account is credited for the transfer price (material, landed, and additional transfer costs). The interunit receivable account in the source business unit and the interunit payables account in the destination business unit are posted with the transfer price (material, landed, and additional transfer costs). Since the item uses the actual or average-cost method, the inventory account in US012 is debited for the material and landed costs portions of the transfer price. Since the **Expense Transfer Fees** check box has been selected on Inventory Definition - Business Unit Definition page for US012, the additional transfer costs are written off to the gain and loss on transfer price account rather than added to the cost of the item.

Interunit Receivables (in US001)		Intransit Account (in US001)	
1650.00		(100) 1500.00	
		(601) 100.00	
		(751) 50.00	
Inventory Acct (in US012)		Interunit Payables (in US012)	
(100) 1500.00		1650.00	
(601) 100.00			
		Gain/Loss on Transfer Price (in US012)	
		(751) 50.00	

Example 2.2

This example has the same conditions as Example 2.1 except that the intransit account is owned by the destination business unit (US012).

The following diagram illustrates the accounting entry for the shipping transaction in the source business unit US001 (transaction group 031 - InterBU Transfer Shipments). The interunit receivable and interunit payable transactions are recorded at shipment time because the intransit stock is owned by the destination business unit. The inventory account is credited, at item cost, for the material and landed costs. The intransit account contains the transfer price of material, landed, and additional transfer costs. The gain and loss on transfer price account contains the additional transfer cost plus any difference between the transfer price and the cost of the item.

Inventory Acct (in US001)		Interunit Receivables (in US001)		Gain/Loss on Transfer Price (in US001)	
(100)	1400.00	1650.00		(100)	100.00
(601)	100.00			(751)	50.00

Intransit Account (US012)		Interunit Payables (in US012)	
(100)	1500.00		1650.00
(601)	100.00		
(751)	50.00		

The following diagram illustrates the accounting entry for the putaway transaction in the destination business unit US012 (transaction group 022 - IBU Transfer Receipts).

Inventory Acct (in US012)		Intransit Account (US012)	
(100)	1500.00	(100)	1500.00
(601)	100.00	(601)	100.00
		(751)	50.00

Gain/Loss on Transfer Price (in US012)	
(751)	50.00

Example 2.3

This example has the same conditions as Example 2.1 except that the quantity of the item shipped is different from the quantity of the item received.

The following diagram illustrates the accounting entry for the shipping transaction in the source business unit US001 (transaction group 031 - InterBU Transfer Shipments). The inventory account is credited, at item cost, for the material and landed costs. The intransit account contains the transfer price of material, landed, and additional transfer costs. The gain and loss on transfer price account contains the additional transfer cost plus any difference between the transfer price and the cost of the item.

Inventory Acct (source BU)		Intransit Account		Gain/Loss on Transfer Price	
	(100) 1400.00	(100) 1500.00			(100) 100.00
	(601) 100.00	(601) 100.00			(751) 50.00
		(751) 50.00			

During transit, half of the shipment was stolen. The source business unit (US001) shipped 10 units, but the destination business unit (US012) received only 5 units. Since the source business unit owned the intransit stock, it must absorb the loss for the stolen items.

Example of receiving interunit stock when shipping quantity is more than received quantity.

Interunit Receivables (in US001)		Intransit Account (US001)	
Half of shipment: 825.00 (entire transfer price)			(100) 1500.00 (601) 100.00 (751) 50.00
Gain/Loss on Transfer Price (in US001)			
Write-off of missing stock:			
(100) 750.00 (601) 50.00 (751) 25.00			
Inventory Acct (in US012)		Interunit Payables (in US012)	
Half of shipment: (100) 750.00 (601) 50.00 (material and landed portions)			825.00 (half of 1650.00)
Gain/Loss on Transfer Price (in US012)			
Freight on received stock:			
(751) 25.00			

Transferring Interunit Stock Using the Interunit Sales Approach (Intercompany)

These examples illustrate different types of accounting transactions that can be generated for intercompany transfers.

Example 3.1

This example illustrates an intercompany inventory transfer from business unit US002 to business unit US013. These business units all use the same base currency. These inventory business units post to different general ledgers; inventory unit US002 reports to the GL unit US001 and inventory unit US013 reports to the GL unit US003. The inventory unit US013 assumes ownership at the time of shipment. The item is standard costed for US013 and can be any cost type for US002. In this case, there are

differences between the item cost in the source business unit, the item transfer price, and the item cost in the destination business unit. Here is what the setup looks like for this example:

Field or Control	Description
US002 (source BU) Cost	5.00
Transfer Price	7.00
US013 (destination BU) Std Cost	6.00

This diagram illustrates the accounting entries in PeopleSoft Inventory and PeopleSoft Billing after shipment. These entries belong to the transaction group 301 (Intercompany Cost of Goods).

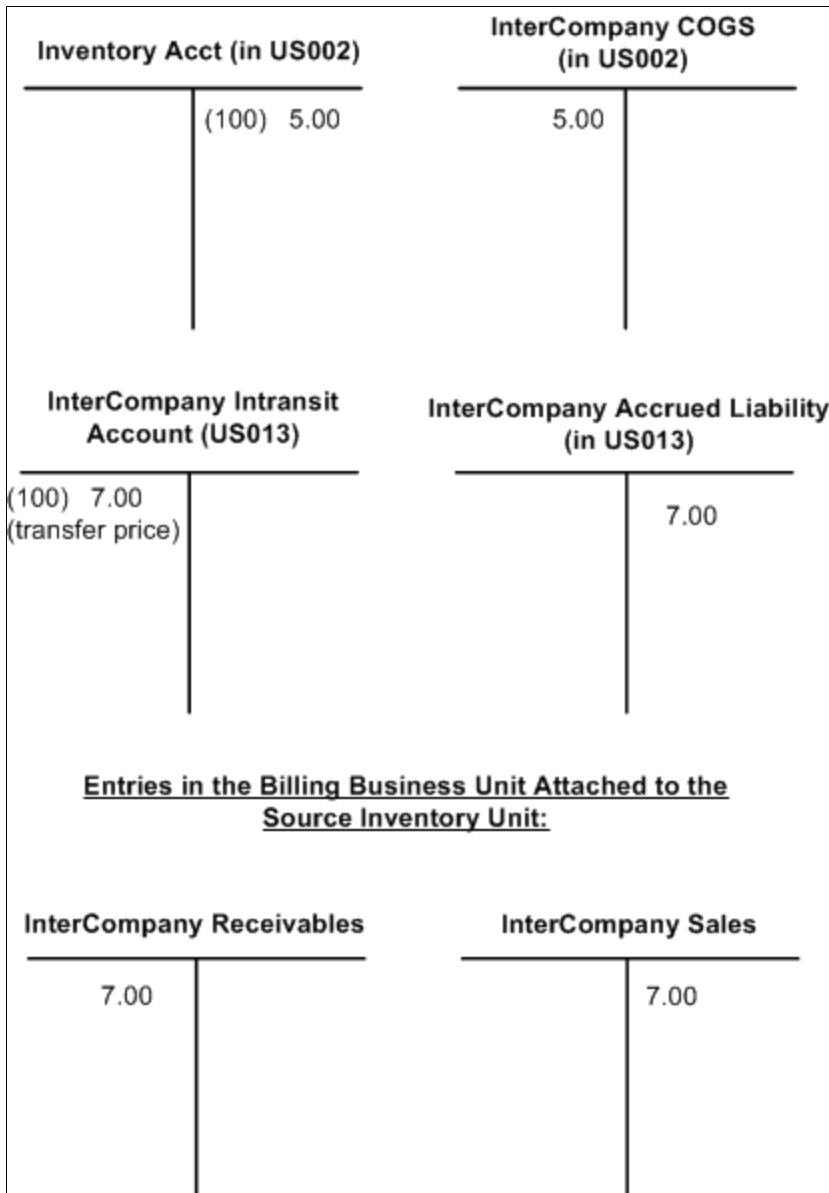

The above accounts are derived from the following sources:

- *Inventory account in source unit:* If the location accounting check box is deselected in the source business unit, the inventory account is derived from the Accounting Rules page (Account Distribution page) for the Intercompany Cost of Goods transaction group (301). If the location accounting check box is selected, the inventory account is derived from the storage area from which the inventory is shipped.
- *InterCompany Cost of Goods Sold (COGS) account:* The COGS account is the source interunit account defined for the inventory business unit combination on the InterUnit Pair page or InterUnit Template page of the centralized interunit and intraunit processor.
- *InterCompany Intransit account:* The intercompany intransit account is defined on the Interunit Ownership page. This transaction belongs to the InterCompany Transfers transaction group (035).
- *InterCompany Accrued Liability account:* The intercompany accrued liability account, in the destination business unit, is the destination interunit account defined for the inventory business unit combination on the InterUnit Pair page or InterUnit Template page of the centralized interunit and intraunit processor. This transaction belongs to the Intercompany Transfers transaction group (035).

Note: The source inventory business unit doesn't use the gain or loss on transfer price transaction group (300); the margin between the cost of the inventory transferred and the transfer price is intrinsic in the difference between the intercompany sales and the intercompany cost of goods sold.

Here is what the accounting entries for PeopleSoft Inventory look like upon putaway in the destination business unit (US013). These entries belong to the transaction group 025 (InterCompany Receipts).

Inventory Acct		InterCompany Intransit Account		Gain/Loss on Transfer Price	
(100)	6.00 (standard cost)		(100) 7.00 (transfer price)	(100)	1.00

Here is what the accounting entry looks like for PeopleSoft Payables upon voucher processing.

InterCompany Accrued Liability	InterCompany Accounts Payable
7.00	7.00

Here is what the accounting entry looks like for the open payable and receivable settlement.

Cash (in destination organization)		InterCompany Accounts Payable (in destination organization)	
	7.00	7.00	
Cash (in sending organization)		InterCompany Receivables (in sending organization)	
7.00			7.00

Example 3.2

This example has the same conditions as example 3.1 except the item ID uses the actual or average-cost method in the destination business unit.

This example differs from example 3.1 only in the accounting entries for PeopleSoft Inventory upon putaway. In this example, the item is an actual or average cost item for US013. Here is what the accounting entries look like in PeopleSoft Inventory upon putaway.

Inventory Acct		InterCompany Intransit Account	
(100) 7.00 (transfer price)		(100) 7.00 (transfer price)	

Example 3.3

This example illustrates an intercompany inventory transfer from business unit US012 to business unit FRA02. These inventory business units post to different general ledgers; inventory unit US012 reports to the GL unit US003 and inventory unit FRA02 reports to the GL unit FRA01. In addition, these business units have different base currencies; USD and EUR. The inventory business unit FRA02 assumes ownership at the time of shipment. The item uses the standard-cost method for FRA02 and can be any cost method for US012. In this case, there are differences between the item cost in the source business unit, the item transfer price, and the item cost in the destination business unit.

Field or Control	Description
US012 Cost	5.00 (in USD: US012 base currency)
Transfer Price	7.00 (in USD: US012 base currency)
FRA02 Std. Cost	6.00 (in EUR: FRA02 base currency)
Exchange Rate	1.05 (one unit of USD-US012 base currency = 1.05 units of EUR-FRA02 base currency)

Here is what the accounting entries look like in PeopleSoft Inventory upon shipment using the transaction group 301 (Intercompany Cost of Goods).

<p>Inventory Acct (in US012)</p> <hr/> <p>(100) 5.00 USD</p>	<p>InterCompany COGS (in US012)</p> <hr/> <p>5.00 USD</p>
<p>InterCompany Intransit Account (FRA02)</p> <hr/> <p>(100) 7.35 EUR</p>	<p>InterCompany Accrued Liability (in FRA02)</p> <hr/> <p>7.35 EUR</p>
<p><u>Entries in the Billing Business Unit Attached to the Source Inventory Unit:</u></p>	
<p>InterCompany Receivables</p> <hr/> <p>7.00</p>	<p>InterCompany Sales</p> <hr/> <p>7.00</p>

The above accounts are derived from the same sources as in example 3.1; however, the amount recorded in the FRA02 business unit is in FRA02's base currency of EUR. The intransit amount is the transfer price (7.00 USD) multiplied by the exchange rate (1.05) resulting in 7.35 EUR.

Here is what the accounting entries look like for PeopleSoft Inventory unit FRA02 upon putaway using the transaction group 025 (InterCompany Receipts).

Inventory Acct	InterCompany Intransit Account
(100) 6.00 EUR (standard cost)	(100) 7.35 EUR (transfer price)
Gain/Loss on Transfer Price <hr style="width: 50%; margin: 0 auto;"/> (100) 1.35 EUR	

Note: Entries are in FRA01 base currency of EUR.

Here is what the accounting entry looks like for PeopleSoft Payables upon voucher processing.

InterCompany Accrued Liability (in FRA02)	InterCompany Accounts Payable (in FRA02)
7.35	7.35

Here is what the accounting entry looks like for open payable and receivable settlement.

Cash (in FRA02)		InterCompany Accounts Payable (in FRA02)	
	7.35 EUR	7.35 EUR	
Cash (in US012)		InterCompany Receivables (in US012)	
7.00 USD			7.00 USD

Example 3.4

This example has the same conditions as example 3.3 except the item ID uses the actual or average-cost method in the destination business unit (FRA02).

This example differs from example 3.3 only in the accounting entries for PeopleSoft Inventory upon putaway. In this example, the item is an actual or average cost item for FRA02. Here is what the accounting entries look like in PeopleSoft Inventory upon putaway.

Inventory Acct		InterCompany Intransit Account	
(100) 7.35 EUR (transfer price)		(100) 7.35 EUR (transfer price)	

Note: Transaction Group 042 (IBU Transfer Adjustments) works the same for intercompany receipts as it does for interunit receipts.

Related Links

"Understanding Stock Transfers Between Business Units" (PeopleSoft Inventory)

"Understanding InterUnit and IntraUnit Billing" (PeopleSoft Billing)

Structuring Landed Costs

Understanding Landed Costs

The cost of obtaining inventory stock includes more than just the material costs of the items. Landed costs include all of the charges that are associated with getting items into a warehouse and available for use or sale, including material, subcontracted services, freight, insurance, duty, taxes, and handling charges. This topic discusses how to handle all of the landed costs.

PeopleSoft's landed costs feature calculates and accounts for the total landed cost by recording the variances for the difference between the actual invoiced cost and estimated purchase order (PO) cost for:

1. Material costs of the item.
2. Subcontracted services that are included in a production ID in PeopleSoft Manufacturing. This only applied to subcontracted services using actual cost accounting.
3. Other miscellaneous landed costs, such as freight, insurance, duty, taxes, and handling charges.

Note: PeopleSoft's landed cost feature can be used to record the non-recoverable portion of excise duty, customs duty, and sales tax for India.

These variances can be applied to the system by updating the item's cost (for actual and average cost items) or updating a variance account (for standard cost items).

PeopleSoft's landed costs feature:

- Uses cost elements and miscellaneous charge codes to identify and track each type of landed cost separately or in groups. The material cost of the item is tracked by the material cost element. Other miscellaneous landed costs are tracked by the miscellaneous charge codes and cost elements in the *landed cost* cost category.
- Displays the estimated landed costs by default on the PO.
- Copies the estimated landed costs from the PO to the receipt where the landed costs are prorated to the individual receipt distribution lines. At putaway, the accrued landed costs are entered into the value of the inventory stock so that the full cost of obtaining the inventory stock is recorded.
- Uses the actual landed costs that are derived from the posted vouchers in PeopleSoft Payables, including all adjustment and reversal vouchers, to calculate variances that update inventory stock values or variance accounts. These variances adjust for changes between estimated and actual landed costs based on fluctuations in both the costs and exchange rates. During voucher entry, material costs and miscellaneous charges can be entered on vouchers that are received from the merchandise supplier or from third-party vendors. The merchandise vouchers must be matched and posted before their actual landed costs are passed to PeopleSoft Cost Management. Third-party vouchers must be posted before their actual costs are passed to PeopleSoft Cost Management.

- Processes the material cost of a subcontracted PO as a landed cost. The subcontracted service must be defined for actual cost. No miscellaneous charge codes are needed for subcontracted services. The estimated cost on the PO is used to record the receipt of the subcontracted service into PeopleSoft Inventory and Manufacturing. Later, when the voucher is entered, matched, and posted, the actual (voucher) cost is used to update the production ID and inventory stock.
- Generates reports to accurately compare estimated versus actual landed costs enabling you to better evaluate supply options.

Consigned items can be set up as landed cost items. When the consigned item is consumed, then the system transacts all accrued landed cost charges.

Note: To use the complete landed cost feature, you must have PeopleSoft Cost Management, PeopleSoft Purchasing, PeopleSoft Inventory, and PeopleSoft Payables installed. To update subcontracted services to actual costs, you must also have PeopleSoft Manufacturing installed and use a cost profile for actual cost.

Setting Up Miscellaneous Landed Costs

Miscellaneous landed costs include costs of obtaining the item, such as freight, insurance, duty, taxes, and handling charges. In order to record miscellaneous landed costs, you must first define several factors. You must decide how to categorize and identify landed costs by using cost elements and miscellaneous charge codes. You can set up the conditions that the system uses to automatically apply miscellaneous landed costs to POs. You must establish how the various miscellaneous landed costs are calculated and prorated to receipt and voucher distribution lines.

To set up miscellaneous landed costs:

1. (Optional) For reporting purposes, you can group similar landed costs together to make reports more readable to users. Use the Landed Cost Group page to create groups for landed costs. For example, air freight and ocean freight components might be grouped into a single freight cost group.
2. Create cost elements with the cost category of *landed*. Cost elements enable you to account for and report on different types of costs. This enables you to accurately identify each different type of miscellaneous landed costs. Use the Cost Elements page to create cost elements. A landed cost element can be made up of one or many miscellaneous charge codes.
3. Define miscellaneous charge codes (also know as cost components) to define miscellaneous landed costs along with the attributes that identify how and when the landed costs are to be applied, calculated, and prorated. Use the Misc Charge/Landed Cost Definition page to define miscellaneous charge codes. Define which cost element the miscellaneous charge will summarize into.
4. (Optional) If you plan to applying several miscellaneous charge codes to a single PO line, then consider using the landed cost template to group all the related charge codes together and apply them as a group. This feature enables you to quickly apply charge codes and track relationships for future changes to the structure. Use the Misc Chg/Landed Cost Template page to define different collections of miscellaneous charge codes.
5. (Optional) You may tell the system when to apply the miscellaneous charge codes or landed cost templates to a PO. This is done by identifying the properties that must exist on a PO in order to apply the charge codes. Use the Miscellaneous Charges - Miscellaneous page to associate templates or charge codes and specific charge amounts for any combination of item category, item ID, supplier ID,

supplier location code, ship-to ID, and purchasing business unit. When one of these item/category/supplier combinations is included on a PO, the system applies the template or charge code, and then calculates and prorates the estimated landed costs to the PO schedule line.

6. (Optional) For items that you wish to define a standard cost profile to be used for analytical purposes.

Note: If you do not need to update landed costs to actual amounts because the estimated costs are accurate, then include the landed costs by using the Additional Item Costs page. Apply the estimated landed costs to the item by simplifying entering the costs by cost element on the Additional Item Costs page. This method does not update inventory values or create variance when the voucher is processed.

Pages Used to Define Miscellaneous Landed Costs

Page Name	Definition Name	Usage
Landed Cost Group Page	CM_LC_GROUP	Aggregate landed cost charges into cost groups for reporting purposes.
Cost Elements Page	CM_ELEMENT	Use to categorize the different components of an item's landed costs.
Misc Charge/Landed Cost Defn Page	CM_LC_COMPONENT	Define miscellaneous charges, including landed costs, to be applied to POs.
Misc Chg/Landed Cost Template Page	CM_LC_TEMPLATE	Define different collections of landed cost charge codes that you can apply to groups of purchased material.
Miscellaneous Charges - Miscellaneous Page	ITM_CAT_VNDR_MC	Enter the criteria for applying miscellaneous charge codes or landed cost templates to POs.
Miscellaneous Charges Selection Page	ITM_CAT_MC_CRITERIA	Enter the criteria for the miscellaneous charges to appear on the Miscellaneous Charges - Miscellaneous page. Miscellaneous Charges - Miscellaneous Page

Related Links

[Understanding the Manufacturing Standard Cost Foundation](#)

[Understanding Standard Costing for Purchased Items](#)

Landed Cost Group Page

To create landed cost groups, use the Landed Cost Group (CM_LC_GROUP_GBL) component.

Use the Landed Cost Group page (CM_LC_GROUP) to aggregate landed cost charges into cost groups for reporting purposes.

Navigation:

Set Up Financials/Supply Chain > Product Related > Cost Accounting > Landed Cost Groups > Landed Cost Group

For reporting purposes, you can group similar miscellaneous landed costs together to make reports more readable to users. Use the Landed Cost Group page to create groups for landed costs. By SetID, enter a group ID and a description. As you define miscellaneous charge codes on the Misc Charge/Landed Cost Definition page, enter the related landed cost group ID. Set the parameters of the reports to view the information by cost group.

Cost Elements Page

Use the Cost Elements page (CM_ELEMENT) to use to categorize the different components of an item's landed costs.

Navigation:

Set Up Financials/Supply Chain > Product Related > Cost Accounting > Define Cost Elements

Cost elements are used for more than landed cost charges. They identify and categorize all the different components of an item's cost and also define the debit and credit ChartField combinations for accounting entries. Cost elements enable you to report and record costs in different categories. For landed costs, you create one or more cost elements for reporting. When setting up a cost element for landed costs, you must identify its category as landed.

Related Links

[Cost Elements Page](#)

Misc Charge/Landed Cost Defn Page

To define miscellaneous charge codes, use the Misc Charge/Landed Cost Defn component (CM_LC_COMPONENT).

Use the Misc Charge/Landed Cost Defn page (CM_LC_COMPONENT) to define miscellaneous charges, including landed costs, to be applied to POs.

Navigation:

Set Up Financials/Supply Chain > Product Related > Procurement Options > Charges/Costs > Misc and Landed Cost Defn

This example illustrates the fields and controls on the Miscellaneous Charges/Landed Cost Defn page. You can find definitions for the fields and controls later on this page.

Misc Charge/Landed Cost Defn

SetID: SHARE

Miscellaneous Charge: EXPRESS

*Description: Express Freight-Overnight

*Type: Freight Expense Prorate

Purchasing Attributes

*Calculation Method: Weight Landed Cost Component RTV Credit

*Allocation Method: Weight Merchandise Supplier Charge

Landed Cost Component Info

Cost Element: 600 % Ext Amount Tolerance: 5.00

Landed Cost Group: FRT Qty Rcvd Tolerance %: 5.00

Accrue Charge

This page is used to identify both miscellaneous charges and miscellaneous landed cost charges. Landed costs charges are prorated to the PO distribution lines, receipt distribution lines, and voucher lines. A landed cost can be from the merchandise supplier or a third-party supplier.

If you select the **Accrue Charge** check box, then the estimated landed costs for that miscellaneous charge code are included in inventory value at putaway. If you do not select the Accrue Charge check box, the system waits for the actual landed costs (recorded on the matched and posted voucher) and then records the actual landed costs in an expense account. The non-accrued charges are not included in the inventory value.

Note: PeopleSoft's landed cost feature can be used to record the non-recoverable portion of excise duty, customs duty, and sales tax for India. Define a miscellaneous charge code by using the VAT input non-recoverable type and selecting the **Prorate** and **Landed Cost Component** options. The non-recoverable portion is recorded in the item value.

Related Links

" Misc Charge/Landed Cost Defn Page" (PeopleSoft Source to Settle Common Information)

Misc Chg/Landed Cost Template Page

To create a landed cost template, use the Misc Chg/Landed Cost Template component (CM_LC_TEMPLATE).

Use the Misc Chg/Landed Cost Template page (CM_LC_TEMPLATE) to define different collections of landed cost charge codes that you can apply to groups of purchased material.

Navigation:

Set Up Financials/Supply Chain > Product Related > Procurement Options > Charges/ Costs > Misc & Landed Cost Tmplt

If you plan to apply several miscellaneous charge codes to a single PO or PO line, then consider using the landed cost template to group all of the related charge codes together. You can apply them as a

group to the Miscellaneous Charges - Miscellaneous page or directly to the PO by using the Header - Miscellaneous page or the Schedule-Miscellaneous Charges page. This feature enables you to quickly apply charge codes and track relationships for future changes to the structure. Use the Misc Chg/Landed Cost Template page to define different collections of miscellaneous charge codes.

Related Links

"Defining Miscellaneous Charges and Landed Costs" (PeopleSoft Source to Settle Common Information)

Miscellaneous Charges - Miscellaneous Page

Use the Miscellaneous Charges - Miscellaneous page (ITM_CAT_VNDR_MC) to enter the criteria for applying miscellaneous charge codes or landed cost templates to POs.

Navigation:

Items > Define Items and Attributes > Miscellaneous Charges > Miscellaneous

This example illustrates the fields and controls on the Miscellaneous Charges - Miscellaneous page. You can find definitions for the fields and controls later on this page.

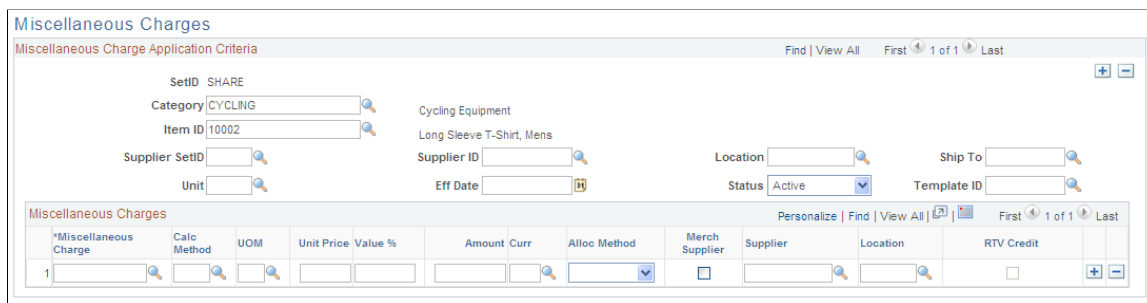

In order to have the system automatically populate the POs with the correct miscellaneous charge codes and charge amounts; you must design a series of parameter combinations. When a PO is entered that matches the combination of parameters that you define, the assigned charge code or template is used.

You can set up default miscellaneous charges that are automatically calculated based on these combinations, where level one overrides level two, and so on:

Level	Miscellaneous Charge Hierarchy Criteria
1	Item, supplier, purchasing business unit, and ship to location. (INV_ITEM_ID, VENDOR_ID, BUSINESS_UNIT, and SHIPTO_ID)
2	Item, supplier, and purchasing business unit. (INV_ITEM_ID, VENDOR_ID, and BUSINESS_UNIT; and no SHIPTO_ID)
3	Item and supplier. (INV_ITEM_ID and VENDOR_ID; and no BUSINESS_UNIT nor SHIPTO_ID)

Level	Miscellaneous Charge Hierarchy Criteria
4	Item. (INV_ITEM_ID; and no VENDOR_ID, BUSINESS_UNIT, nor SHIPTO_ID)
5	Category, supplier, purchasing business unit, and ship to location. (CATEGORY_ID, VENDOR_ID, BUSINESS_UNIT, and SHIPTO_ID; and no INV_ITEM_ID)
6	Category, supplier, and purchasing business unit. (CATEGORY_ID, VENDOR_ID, and BUSINESS_UNIT; and no INV_ITEM_ID nor SHIPTO_ID)
7	Category and supplier. (CATEGORY_ID and VENDOR_ID; and no INV_ITEM_ID, SHIPTO_ID, nor BUSINESS_UNIT)
8	Category. (CATEGORY_ID; and no INV_ITEM_ID, VENDOR_ID, BUSINESS_UNIT, nor SHIPTO_ID)

For example, you can set up miscellaneous charges that are automatically calculated on the PO when a certain item is ordered from a particular supplier, for a particular purchasing business unit, and for a specific ship to location of the business unit. You can also set up a miscellaneous charge that is automatically calculated for a particular item.

Only one Miscellaneous Charges - Miscellaneous page combination is used for each charge code. If you define the same charge code at multiple levels, the system uses the Miscellaneous Charges - Miscellaneous page at the most specific level of detail. However, you can define more than one charge code. For example, if you define a miscellaneous charge named shipping for an item (level 4), and also for the category (level 8) that the item belongs to, only the charge that is defined for the item is used. The miscellaneous charge that is defined for the category is only used for items that do not have a miscellaneous charge that is specifically defined for them. However, if you define one charge code (shipping) at the item level and another charge code (handling) at the category/supplier/Purchasing business unit/ship to location, then the PO picks up both the handling and shipping charges.

Field or Control	Description
Template ID	If you want to apply a template of miscellaneous charges, select the template ID. Miscellaneous charge templates are set up on the Misc Chg/Landed Cost Template page.
Misc Chg (miscellaneous charge)	The miscellaneous charge code. If you want to apply a miscellaneous charge code, select the charge code ID. Miscellaneous charge codes are set up on the Misc Charge/Landed Cost Definition page.

Field or Control	Description
Calc Method (calculation method)	<p>Select the method that you want to use to calculate this charge. The default comes from the Misc Charge/Landed Cost Defn page. Choose from these options:</p> <p><i>FL</i> (flat amount): The charge is a flat amount that you enter in the Amount field.</p> <p><i>FR</i> (free): No charge is to be applied.</p> <p><i>UNT</i> (per unit amount): Calculate the charge based on the number of items on the PO line.</p> <p><i>VAL</i> (percent of value): Calculate the charge based on a percentage of the material value.</p> <p><i>VOL</i> (rate based on volume): Calculate the charge based on the total volume for the PO line.</p> <p><i>WT</i> (rate based on weight): Calculate the charge based on the total weight for the PO line.</p>
UOM (unit of measure)	The unit of measure, for volume or weight, depending on the choice that you made in the Calc Method field.
Unit Price	The per unit amount of the charge.
Value %	If the miscellaneous charge is a percentage of the unit price, this is the percentage of the charge.
Amount	The fixed order amount of the miscellaneous charge. You can define both a unit price and an amount if the calculation method is UNT, VOL, or WT.
Currency	The currency of the miscellaneous charge.
Alloc Method (allocation method)	<p>Select the method to allocate the miscellaneous charge. The default comes from the Misc Charge/Landed Cost Defn page. Options are:</p> <p><i>Matl Value</i> (material value): Allocates the charges based on the value of the items on each selected line.</p> <p><i>Quantity</i>: Allocates the charges based on the quantity of items on each selected line.</p> <p><i>Volume</i>: Allocates the charges based on the volume of the items on each selected line.</p> <p><i>Weight</i>: Allocates the charges based on the weight of the items on each selected line.</p>

Field or Control	Description
Merch Supplier (merchandise vendor)	The Merch Supplier option setting appears by default from the miscellaneous charge's purchasing attributes on the Misc Charge/Landed Cost Defn page. You can override the setting here as necessary. If you select this option, charges are paid to the PO supplier. If you do not select this option, you can use the Supplier and supplier Location fields to designate a third-party supplier.
RTV Credit (return to vendor credit)	Select this check box if you can receive credit from the vendor for these miscellaneous charges if the items are returned. This check box is only active if the merchandise supplier is selected.
Selection Criteria	Click to access the Miscellaneous Charges Selection page, where you enter the criteria for the miscellaneous charges to appear on the Miscellaneous Charges page.

Miscellaneous Charges Selection Page

Use the Miscellaneous Charges Selection page (ITM_CAT_MC_CRITERIA) to enter the criteria for the miscellaneous charges to appear on the Miscellaneous Charges - Miscellaneous page.

Navigation:

Select the Selection Criteria link on the Miscellaneous Charges - Miscellaneous page.

Enter criteria in each field to narrow the search. For example, if you enter only a SetID, then all the miscellaneous charges that are set up on the Miscellaneous Charges - Miscellaneous page for that SetID are retrieved. If you enter a SetID and an item, then all the miscellaneous charges that are set up for that item in that SetID are retrieved.

Enter the maximum number of rows that you want to retrieve in the **Max Rows** field.

Related Links

"Capturing Item Miscellaneous Charges" (PeopleSoft Purchasing)

Recording Estimated Landed Costs

The PO and receipt in PeopleSoft Purchasing use an estimated cost. The actual cost is not known until the invoice (voucher) is received and processed in PeopleSoft Payables.

POs

Estimated landed costs appear by default on the purchase order:

<i>Field or Control</i>	<i>Description</i>
Material Costs	The PO price for material costs is derived from the PeopleSoft Purchasing system's pricing structure.
Subcontracted Services	The cost of subcontracted services is derived from the item routing of the production ID. In PeopleSoft Manufacturing, when part or all of the manufacturing process is done by an outside supplier, you need to generate POs for the production IDs with subcontracted operations. Using the Select Subcontract Prdn for PO page in PeopleSoft Manufacturing, you select one or more production IDs, production areas, or item IDs for which to generate POs for subcontracted operations. When you run the Select Subcontract Prdn for PO (SFS5000) process, the system automatically transfers the subcontracted operations information for PO creation to PeopleSoft Purchasing, including the production ID information for which the outside processing must be done as well as the operation sequence that is associated with the outside operation. PeopleSoft Purchasing creates the PO by using the information from the production ID. The Inventory business unit that is used for manufacturing is populated to the PO line. Only one distribution line is allowed for the subcontracted item.

Field or Control	Description
Miscellaneous Landed Costs	<p>Other miscellaneous landed costs are placed on the PO by adding miscellaneous charge codes. Miscellaneous charge codes can be applied to the PO:</p> <ul style="list-style-type: none"> • <i>Automatically:</i> Enter a PO, if any Miscellaneous Charges - Miscellaneous page has the same combination of item category, item ID, supplier ID, supplier location code, ship-to ID, and purchasing business unit, then the charge codes or templates that are defined are placed on the PO. The system then calculates and prorates the estimated landed costs to the PO schedule. • <i>Manually add to the PO Header:</i> Attach the miscellaneous charge codes or landed cost templates directly to a PO by using the Header - Miscellaneous page. Use the PO Form: Miscellaneous page to select the miscellaneous charge codes and the lines to which they apply. The system then calculates and prorates the estimated landed costs to the PO schedule. • <i>Manually add to the PO Schedule:</i> Attach the miscellaneous charge codes or landed cost templates directly to a PO schedule by using the Schedule-Miscellaneous Charges page. You can also view the landed cost charges that appear by default from the Header - Miscellaneous page and the Miscellaneous Charges - Miscellaneous page.

In all cases, the PO prices can be manually altered before dispatch.

For further information about POs, see *PeopleSoft Purchasing*, "Creating Purchase Orders Online."

See "Understanding the Purchase Order Business Process" (PeopleSoft Purchasing)

Receipts

When the merchandise is received in PeopleSoft Purchasing, the material and other landed cost charges from the PO schedule are copied onto the receipt distribution line. A completed receipt in PeopleSoft Purchasing populates the records, RECV_LN_DISTRIB, RECV_LN_DIST_LC and RECV_LN_SHIP_LC, which are used later by the Landed Cost Extract process to pass data to PeopleSoft Cost Management by using the CM_MATCHED_COST record. For subcontracted services, the production ID information is copied to the receipt line and distribution line. For miscellaneous landed costs, the selection in the Accrue Charge check box on the Misc Charge/Landed Cost Definition page determines if the estimated landed costs are included in the inventory value at putaway or included in expense accounts when they are invoiced.

Once the receipt is recorded in PeopleSoft Purchasing, use the putaway processes in PeopleSoft Inventory to store the item into inventory and record the material and other landed costs.

For subcontracted services, enter the receipt on the Subcontracted Receipt page to complete the subcontracted operation of the production ID. The system records the estimated PO cost or the standard cost, depending on the cost profile of the end item, as a debit to Work in Process (WIP).

Pages Used to Record Estimated Landed Costs

Page Name	Definition Name	Usage
Maintain Purchase Order- Header Misc. Charges Page	PO_MISC_WRK	Apply miscellaneous charges that you add on the Header - Miscellaneous Charges page to the lines of the PO.
Header - Miscellaneous Charges Page	PO_HDR_MISC	Enter the miscellaneous charges that you want to allocate to some or all of the lines on the PO using the Maintain Purchase Order- Header Misc. Charges page.
"Miscellaneous Charges for Schedule Page" (PeopleSoft Purchasing)	PO_SCHED_MISC	Change miscellaneous charges on this schedule.

Related Links

"Understanding the Receiving Business Process" (PeopleSoft Purchasing)

"Understanding Subcontracting Using PeopleSoft Manufacturing" (PeopleSoft Manufacturing)

"Header Misc. Charges (header miscellaneous charges) Page" (PeopleSoft Purchasing)

"Defining Miscellaneous Charges and Landed Costs" (PeopleSoft Source to Settle Common Information)

"Miscellaneous Charges for Schedule Page" (PeopleSoft Purchasing)

Recording Actual Landed Costs

The actual landed costs are recorded on the voucher in PeopleSoft Payables. Landed costs (material, subcontracted services, and other miscellaneous landed costs) can be recorded on regular vouchers, adjustment or reversal vouchers, or third-party vouchers. A merchandise voucher must be matched and posted and a third-party voucher must be posted before their actual landed costs can be passed to PeopleSoft Cost Management.

In PeopleSoft Payables, miscellaneous charges can be attached to vouchers as non-merchandise and non-recoverable VAT charges. These non-merchandise charges are freight, sales tax, use tax and miscellaneous charges.

Note: For excise duty, customs duty, and sales tax for India, you must enter the receipt ID on the associated voucher line in order to adjust the inventory value to the actual cost of these charges. Once this voucher (recorded to pay these duties or taxes) is matched and posted in PeopleSoft Payables, the system can calculate and apply any variance between the non-recoverable amount on the voucher and the non-recoverable amount in the item cost.

For further information about recording, matching, and posting vouchers, see *PeopleSoft Payables*.

Related Links

"Understanding the Matching Process" (PeopleSoft Payables)

"Understanding the Voucher Posting and Payment Posting Processes" (PeopleSoft Payables)

Creating Inventory Adjustments and Variances for Landed Costs

Once the voucher is matched and posted, the actual landed costs can be sent to PeopleSoft Cost Management. The differences between the estimated and actual landed costs are calculated based on the fluctuations in the cost and the exchange rates. These differences can be applied as adjustments to the item cost for actual or average cost items or can be applied as variances to variance accounts for standard cost items.

To calculate landed cost adjustments or variances:

1. Run the Landed Cost Extract process (LC_EXTRACT) to link the voucher landed costs back to the PO and receipt costs.

This process retrieves from PeopleSoft Payables the landed costs, including material costs, subcontracted costs, and other miscellaneous landed costs. The miscellaneous landed costs are categorized by the miscellaneous charge codes. Material costs, including subcontracted costs, are categorized by the material cost element. The vouchered costs are recorded into the CM_MATCHED_COST table.

2. Review and correct in exceptions from the Landed Cost Extract process.
3. As needed, manually close any receipt lines or charges that are not fully matched or fully matched but not within the miscellaneous charge code tolerances.
4. For subcontracted services, run the Production Close process (SFS1100) to set the production ID to closed for accounting.
 - For standard cost items, receive the subcontracted PO and complete the operation in PeopleSoft Manufacturing (subcontracted services are on the operations list). The subcontracted service is costed at standard cost. The variance between the standard cost, PO, and voucher amounts are recorded in a variance account and do not update the cost of the subcontracted item.
 - For actual cost items, you also receive the subcontracted PO and complete the operation in PeopleSoft Manufacturing. Once the voucher is posted to CM_MATCHED_COST, the difference between the estimated subcontracted cost on the purchase order and the actual subcontracted cost on the voucher is calculated and flows into WIP and to finished goods. This difference is posted as an adjustment to the subcontracted cost using the transaction group 664 (Subcontracted Cost) in the following step.
5. Run the Transaction Costing process (CM_COSTING) to calculate the variances and cost adjustments. This process is run from the Cost Accounting Creation process page. For actual and average costed items that are produced in PeopleSoft Manufacturing, the Transaction Costing process can calculate the variances for subcontracted services between PO costs and voucher costs.
6. Run the Accounting Line Creation process (CM_ALC) to create accounting entries to record the variances and cost adjustments. This process is run from the Cost Accounting Creation process page.

Pages Used to Create Adjustments and Variances for Landed Costs

<i>Page Name</i>	<i>Definition Name</i>	<i>Usage</i>
<u>Landed Cost Extract Page</u>	LC_RUN_CNTRL	This application engine process retrieves landed cost data from vouchers, POs and receivers, and passes the data to PeopleSoft Cost Management.
<u>Landed Cost Extraction - Messages Page</u>	AP_MESSAGE_LOG	View error messages that are associated with previous landed cost extraction requests.
"Landed Cost Extract Exceptions Page" (PeopleSoft Payables)	VCHR_LC_LOG	View exceptions from the Landed Cost Extract process.
<u>LC Manual Close (landed cost manual close) Page</u>	CM_LC_MANU_CLOSE	View and enter details about landed costs that are applied to a receipt and the vouchers that are created to pay for them. Use this page to perform manual overrides, closing individual or all landed cost lines that are associated with the selected receipt line.
"Voucher Details Page" (PeopleSoft Purchasing)	CM_LC_MANU_CLS_VC	View voucher details for the selected landed cost that is applied to the receipt line.
<u>Cost Accounting Creation Page</u>	CM_COST_REQ	Use this run control process page to calculate the cost of transactions that have not yet been costed (CM_COSTING) and also to create accounting entry lines (CM_ACCTG) for these costed transactions.

Landed Cost Extract Page

Use the Landed Cost Extract page (LC_RUN_CNTRL) to this application engine process retrieves landed cost data from vouchers, POs and receivers, and passes the data to PeopleSoft Cost Management.

Navigation:

Accounts Payable > Batch Processes > Extracts and Loads > Extract Landed Cost > Landed Cost Extract

The Landed Cost Extraction module links all landed costs from vouchers, POs, and receipts, and passes this data for both material charges and landed cost miscellaneous charges to PeopleSoft Cost Management. The material costs, including subcontracted services, are categorized by the material cost element. The miscellaneous landed cost charges are categorized by the miscellaneous charge codes. This process is separate from the PeopleSoft Payables Matching process (AP_MATCHING), which matches merchandise vouchers with POs or receivers for that merchandise. However, even if you are not using

miscellaneous landed costs, you must run this process to pass invoiced material costs to PeopleSoft Cost Management, where the material variances for price and exchange rates are computed and applied.

Note: In order to run Landed Cost Extraction, you must have PeopleSoft Payables, PeopleSoft Purchasing, and PeopleSoft Cost Management installed on the same database. For subcontracted services, you must also have PeopleSoft Manufacturing installed on the same database.

The Landed Cost Extract process does not pass the actual vouchered miscellaneous charges to PeopleSoft Cost Management until all the vouchers are created for the miscellaneous charge codes that are within a particular cost element. This avoids repeated or erroneous changes to the costs within PeopleSoft Cost Management.

Run the Landed Cost Extract process prior to running the Transaction Costing process (within the Cost Accounting Creation process).

The Landed Cost Extraction program processes inventory items by:

- Flagging eligible vouchers (matched, posted and not yet processed by land cost extract process).
Eligible vouchers are regular, adjustment, reversal, and third-party vouchers.
- Finding the corresponding receipts (not yet processed by the landed cost extract process) in the RECV_LN_DISTRIB, RECV_LN_DIST_LC, and RECV_LN_SHIP_LC tables.
- Summing the vouchers with the same receiver line information (BUSINESS_UNIT, RECEIVER_ID, RECV_LN_NBR, RECV_SHP_SEQ_NBR).
- Prorating the miscellaneous charges to the receiver lines based on the receiver accepted quantity.

The voucher line miscellaneous charge will be prorated based on QTY_RECV_APPLIED / sum of QTY_RECV_APPLIED for the voucher line.

- Calculating the material unit costs.

Note: Life to date voucher amounts will include previously extracted vouchers, in addition to the vouchers selected in the current Landed Cost Extract run control. This helps to ensure accurate calculations of voucher costs by including associated vouchers. For example, a regular voucher and its associated debit memo voucher will be included in the voucher unit cost calculation.

- $CM_UNIT_COST_VO = \text{Life to date } RECV_VCHR_MTCH.MERCH_AMT_VCHR \text{ (converted to Inventory business unit base currency)} / RECV_LN_SHIP.QTY_SH_ACCPT_SUOM.$
- $CM_UNIT_COST_POVO = \text{Life to date } RECV_VCHR_MTCH.MERCH_AMT_VCHR \text{ (converted to Inventory business unit base currency using exchange rate on purchase order)} / RECV_LN_SHIP.QTY_SH_ACCPT_SUOM.$
- $CM_UNIT_COST_PO = RECV_LN_DIST.MERCH_AMT_BSE / RECV_LN_SHIP.QTY_SH_ACCPT_SUOM.$
- Calculating the miscellaneous charge unit costs.
 - $CM_UNIT_COST_VO = \text{Life to date } RECV_VCHR_MTCH.MERCH_AMT_VCHR \text{ (converted to Inventory business unit base currency)} / RECV_LN_SHIP.QTY_SH_ACCPT_SUOM.$

- $CM_UNIT_COST_POVO = \text{Life to date } RECV_VCHR_MTCH.MERCH_AMT_VCHR$
(converted to Inventory business unit base currency using exchange rate on purchase order) /
 $RECV_LN_SHIP.QTY_SH_ACCPT_SUOM.$
- $CM_UNIT_COST_PO = RECV_LN_DISTRIB.MERCH_AMT_BSE /$
 $RECV_LN_DISTRIB.QTY_DS_ACCPT_SUOM.$
- Populating `CM_MATCHED_COST` record for material unit costs and miscellaneous charge unit costs by matching receipts and vouchered costs (`CM_UNIT_COST_VO`, `CM_UNIT_COST_POVO`, and `CM_UNIT_COST_PO`).

One row is created for each cost element of a receiver distribution line.

- Populating `CM_MATCHED_COST` record for the subcontracted services for a production ID (PeopleSoft Manufacturing).
- Populating `CM_MATCHED_COST` record for the excise duties, customs duties, and sales taxes for India.

The process matches the non-recoverable portion of these charges from third-party vouchers (PeopleSoft Payables) to the non-recoverable portion from the POs and receipts (PeopleSoft Purchasing).

- Populating `CM_RMATCH_COST` record for return to vendor (RTV) adjustment vouchers.
- Populates receiving shipment (`RECV_LN_SHIP_VC`) and distribution (`RECV_LN_DIST_VC`) tables with the actual vouchered miscellaneous charges so that you can report and inquire on this data.
- Adds a line to the `CM_MATCHED_COST` record and the `RECV_LN_DIST_LC` record with a zero amount if a charge is vouchered which was not on the purchase order to alert analysts of a discrepancy between the expected and vouchered miscellaneous charges.
- Updates the voucher and receiver tables by flagging the processed vouchers and receivers with the landed cost extracted flag.

Related Links

"Understanding the Landed Cost Extraction Process" (PeopleSoft Payables)

Landed Cost Extraction - Messages Page

When the Landed Cost Extract process is complete:

- Use the Landed Cost Extraction - Messages page to view error messages that are associated with previous landed cost extraction requests.
- If the system encounters exceptions during the Landed Cost Extraction cycle, you can view the exceptions on the Landed Cost Extract Exceptions page. The system generates exceptions if:
 - The high (ceiling) tolerances that are established on the Misc. Charge/Landed Cost Defn page are exceeded. If the low (floor) tolerances are not met, no exception is generated based on the assumption that there are more vouchers to come. An exception does not prevent further processing.

- Other errors are found beside tolerance exceptions, including no conversion rate or other setup errors.

Correct any exceptions and rerun the Landed Cost Extract process.

Related Links

[Landed Cost Extract Page](#)

"Reviewing Landed Cost Exceptions" (PeopleSoft Payables)

LC Manual Close (landed cost manual close) Page

Use the LC Manual Close (landed cost manual close) page (CM_LC_MANU_CLOSE) to view and enter details about landed costs that are applied to a receipt and the vouchers that are created to pay for them.

Use this page to perform manual overrides, closing individual or all landed cost lines that are associated with the selected receipt line.

Navigation:

Purchasing > Receipts > Close Landed Costs > LC Manual Close

Use the LC Manual Close page to manually close receipt lines or charges that will not be fully matched. From this page, you can access a Landed Cost Manual Close-Voucher Detail page displaying all voucher line charges that are allocated to a receipt line charge. The Landed Cost Extract process only passes costs to PeopleSoft Cost Management once miscellaneous charges for cost elements are fully matched. This page lets users manually close charges that are not fully matched.

Related Links

"Working with Landed Costs on Receipts" (PeopleSoft Purchasing)

Cost Accounting Creation Page

Use the Cost Accounting Creation page (CM_COST_REQ) to use this run control process page to calculate the cost of transactions that have not yet been costed (CM_COSTING) and also to create accounting entry lines (CM_ACCTG) for these costed transactions.

Navigation:

Cost Accounting > Inventory and Mfg Accounting > Create Accounting Entries > Cost Accounting Creation

Given the costs that are passed in from the Landed Cost Extract process to the CM_MATCHED_COST and CM_RMATCH_COST records, the Transaction Costing process (within the Cost Accounting Creation process) makes the necessary cost adjustments or variances for the landed costs. The Transaction Costing process is run from the Cost Accounting Creation process page. Calculations include:

1. For standard cost items, two variances are calculated: purchase price variance (PPV) and exchange rate variance (ERV). Together, the PPV and the ERV make up the total standard cost variance.

- a. The PPV is the difference between the standard cost for the landed cost element and the actual landed costs from the matched, posted, and extracted voucher expressed in the PO exchange rate. Based on the timing of the voucher, the variance could be computed and posted in two parts. If the voucher is not available in the CM_MATCHED_COST record when the Transaction Costing process is run, then the system calculates the difference between the standard cost and the PO price. When the voucher becomes available, then the Transaction Costing process computes the difference between the PO price and the voucher price expressed in the PO exchange rate.
 - b. The ERV is the change between the exchange rate for landed costs on the PO and the exchange rate for landed costs on the voucher. This is calculated once the voucher is matched, posted, and extracted to the CM_MATCHED_COST record. An ERV occurs when the invoice for the purchased item is in a different currency than the inventory business unit's currency and the exchange rate between the two currencies changes between the time that you enter the PO and the time that you voucher the invoice.
2. For actual cost items, a cost adjustment is calculated for the difference between the landed costs on the PO and the landed costs on the voucher (that is matched, posted, and extracted to the CM_MATCHED_COST record). This adjustment includes changes in the exchange rate between the PO and voucher. The Transaction Costing process finds the original putaway (in TRANSACTION_INV) and updates the on-hand inventory stock and depletion records for the adjustment. The adjustment is posted based on the ChartField combinations that are used on the original entries.
 3. For perpetual weighted average items and retroactive perpetual weighted average items, the cost adjustment (difference between PO price and voucher price including the exchange rate difference) are calculated and applied if the Apply Perpetual Average Adj check box is selected on the Cost Accounting Creation process page. The cost adjustment is added to the on-hand inventory stock. If the cost adjustment is based on more item units than are currently in on-hand stock, then the adjustment is proportionally applied to the on-hand inventory stock and the excess is written off to a write-off account.
 4. For periodic weighted average items, the system lets users decide when to perform the calculations on a periodic basis. For the receipts that have been vouchered, the voucher amount is used. On the Cost Accounting Creation process page, select the Apply Perpetual Average Adjs check box to update the perpetual average costs to include price and exchange rate adjustments.
 5. The system maintains a full history of all cost changes that are processed for inventory items.

If you select the **Accrue Charge** check box on the Misc Charge/Landed Cost Defn page, then the miscellaneous landed costs for that miscellaneous charge code are included in inventory value at putaway. When the difference between the PO and the voucher (both cost and exchange rate) are computed, the differences are handled based on the cost method:

Field or Control	Description
Actual Cost Items	<p>The item's inventory value is adjusted for the difference, along with all depletions against the receipts.</p> <p>If you wish to write-off the cost adjustment rather than update the item's value, use the Writeoff PPV and ERV check box on the Cost Profiles page. Select this check box to record any differences between the purchase order price and the vouchered price in an expense account rather than catching up the adjustments with the inventory receipt and depletion transactions.</p>
Average Cost Items	<p>The average cost is adjusted (depending on the run control settings for transaction costing on the Cost Accounting Creation process page) and transactions are recorded to adjust the inventory balance. Depletion transactions are not adjusted.</p>
Standard Cost Items	<p>The item's inventory value is not adjusted for the difference. Standard cost is used for the item value. The difference between the standard cost, PO price, and voucher is recorded to a variance account using the ChartField combination (accounts) defined in the transaction accounting rules.</p>

If you select the Hold for Final Cost check box on the Cost Profiles page and run the Cost Accounting Creation process for transaction costing in midperiod mode, then the process waits for the matched cost from the invoice to record adjustments to the actual cost items and to record variances for the standard cost items. Costing of receipts and depletions is put on hold until the PO, receipt, and vouchers are matched and in to the CM_MATCHED_COST record, eliminating the need for variances. If you run the Cost Accounting Creation process for transaction costing in Regular mode, all transactions are costed by using the available cost, regardless of this check box setting.

Most vouchers are processed just one time, however, if corrections are necessary the corrected voucher amounts can be extracted and passed to PeopleSoft Cost Management as often as needed. The system is designed to continuously update the costs to the most current information as vouchers are updated.

Related Links

[Generating Costs for Transaction Records](#)

[Calculating and Applying Purchase Price Variance and Exchange Rate Variance](#)

Cost Accounting Creation Page

Use the Cost Accounting Creation page (CM_COST_REQ) to use this run control process page to calculate the cost of transactions that have not yet been costed (CM_COSTING) and also to create accounting entry lines (CM_ACCTG) for these costed transactions.

Navigation:

Cost Accounting > Inventory and Mfg Accounting > Create Accounting Entries > Cost Accounting Creation

The Accounting Line Creation job records accounting entries for landed cost differences. This process is run from the Cost Accounting Creation process page. This application engine process retrieves the variances that are computed by the Transaction Costing process (also within the Cost Accounting Creation process page) and creates the accounting entries. These results are stored in the CM_ACCTG_LINE table. The Journal Generator process can then create the journal entries to post to the general ledger system.

If you select the **Accrue Charge** check box on the Misc Charge/Landed Cost Defn page, then the miscellaneous landed costs for that miscellaneous charge code are included in inventory value at putaway. When the variances are computed, the Accounting Line Creation process creates accounting entries to record the variances.

Related Links

[Creating Accounting Entries](#)

Reviewing Landed Costs

To review landed costs:

1. Use the Accrued Liability Reconciliation Tool to verify that all differences between the PO costs and the voucher costs are properly accounted for. The entries that are made to this account by PeopleSoft Cost Management should offset the entries that PeopleSoft Payables makes. The reconciliation tool helps identify transactions that are not offsetting for both material costs and other landed costs.
2. Generate PeopleSoft reports to accurately compare estimated versus actual landed costs, enabling you to better evaluate suppliers. Reports include:
 - a. **Estimated vs. Actual Landed Costs** (CMS3000): Lists variances between the PO's price and the voucher's price for all landed cost components.
 - b. **Total Purchase Variance** (CMS3010): Lists variances between the PO (price and exchange rate) and the voucher (price and exchange rate) for all landed cost components.
 - c. **Standard Purchase Variance** (CMS3020): For standard cost items only, lists the variance between the item's standard cost and the PO price that is recognized at the receipt of the item.

Related Links

[Understanding the CM/AP Reconciliation Tool Set](#)
[PeopleSoft Cost Management Reports: A to Z](#)

Adding Non-Recoverable Indian Duties and Taxes to the Item Cost

When you receive raw materials from a supplier, the applicable excise duties, customs duties, and sales taxes (from the supplier excise invoice) can be split into recoverable and non-recoverable parts. The system adds the non-recoverable portion to the inventory value of the raw materials. Later, when you receive the invoice from the supplier and post it into PeopleSoft Payables, any change in the non-

recoverable excise duties, custom duties, or sales taxes can be applied to the inventory stock by using the Landed Cost Extract process.

To set up non-recoverable customs duties as a landed cost, read the topic, "Setting Up Your Customs Duty Structure."

To set up non-recoverable excise duty and sales taxes as a landed cost:

1. Create or identify cost elements with the Cost Category of *Landed*.

Cost elements enable you to record and report on each different type of landed cost. Use the Cost Elements page to create separate cost elements for non-recoverable excise duty and non-recoverable sales taxes.

2. Create miscellaneous charge codes to define the non-recoverable excise duty and non recoverable sales taxes.

The charge codes use the type of VAT input non-recoverable, and select the Prorate and Landed Cost Component check boxes. The cost elements that are defined should be added to the charge codes. Use the Misc Charge/Landed Cost Definition page to define miscellaneous charge codes.

3. Enter the miscellaneous charge codes for non-recoverable excise duty and non-recoverable sales taxes to the corresponding tax components that are defined on the Tax Component page.
4. For each tax rate code, enter the recoverable percentage of the total excise duty or sales taxes in the **Recoverable Tax Pct** field on the Tax Rate Code page.

The system calculates the non-recoverable percentage by subtracting the recoverable percent from 100 percent.

5. For items using standard costing, you can use the Additional Item Costs page to include the non-recoverable excise duty and sales taxes as landed costs in the cost rollup.

Non-recoverable excise duty and sales taxes are applied in this manner:

1. The system determines and calculates the excise duty and sales taxes for the PO.
2. When the raw material is received into PeopleSoft Purchasing, the internal supplier excise invoice is recorded with the total excise duty and sales taxes.
3. The Receipt Push process takes the receipt line and matches up the excise duty and sales taxes from the PO schedule line to create the receipt landed costs transactions. The receipt landed costs transactions contain only the non-recoverable portion of excise duty and sales taxes. The Receipt Push process inserts the non-recoverable excise duty and sales taxes into the Putaway staging tables.
4. The receipts (including non-recoverable excise duty and sales taxes) in the Putaway staging tables are then inserted into PeopleSoft Inventory by the Load Staged Items process and the Complete Putaway process.
5. When you receive the supplier's invoice and process it into PeopleSoft Payables, the Landed Cost Extract process passes the difference (if any) between estimated non-recoverable taxes (on the PO) and the actual non-recoverable taxes (on the voucher) to PeopleSoft Inventory, where the item is updated. This process is the same process used for all landed cost adjustments.

Related Links

"Creating Third-Party Vouchers with Customs Duty" (PeopleSoft Payables)

Chapter 12

Accounting for Returns to Vendor

Understanding Accounting for RTVs

PeopleSoft Cost Management accommodates the various reasons for returning goods to a supplier:

Term	Definition
Return for credit	Returning items without expecting them to be replaced. In this case, you expect a credit from the supplier.
Return for exchange	Returning one item for another, to either the original supplier or another supplier. The system handles this case in two parts: a return for credit followed by a request for the new item. To request the new item, you manually add a new line to an existing purchase order or create a new purchase order (PO), and you indicate that the new line or PO is a result of an RTV.
Return for replacement	Returning items and expecting them to be replaced.
Return to vendor	Returning items and expecting them to be replaced. The system treats this case as a return for replacement; it is another way to categorize a return for replacement.
Destroy	Destroying the items, instead of returning them, and expecting them to be replaced. The system treats this case as a return for replacement; it is another way to categorize a return for replacement.

You can specify the receipt being returned or the receipt can be unspecified. You can return items for credit that are the same or different than the cost of the original receipt. You can record other miscellaneous charges, such as, restocking fees and freight. With PeopleSoft, you can return items to a supplier at any time:

- If you refuse an item during the physical receipt of the supplier's shipment into your warehouse. Then you record the return on the receipt pages in PeopleSoft Purchasing. In this situation, the system never considers receipt of the item to be accepted and no RTV form is needed.
- You can also return the item after you record the receipt, after it is put away into PeopleSoft Inventory, and even after the system matches the receipt to an invoice, pays it, and posts it. In all of these situations, the receipt should be allowed to flow through to PeopleSoft Payables and an RTV should be created to offset the voucher. PeopleSoft Payables will build an adjustment voucher when you return an item for credit or if you enter adjustment fees, such as restocking fees, when you enter the RTV.

- You can return an item after closing its PO and reopen the closed PO when necessary. You can even return an item in situations where a PO or receipt identifier is no longer or never was known. You enter on the RTV page all the data that normally appears by default from the PO or receipt. You can record additional RTV fees that are charged by either you or the supplier; the Voucher Build process picks up the fees and creates an adjustment voucher.

Costing Methods Used for RTV Depletion

PeopleSoft Cost Management calculates the cost of returned items using the transaction group 012 (Return to Vendor). The RTV accounting entry consists of:

- The item's RTV Price. This is the negotiated amount of credit from the supplier for the return of the goods. The RTV price is entered on the debit memo in PeopleSoft Payables.
- The item's cost relieved from the inventory business unit. PeopleSoft Cost Management calculates the cost of returned items based on the depletion costing method that is assigned to the items in the business unit books:
 - The weighted average costing of items uses the cost in effect at the time of the return (depletion). No unweighting of the cost occurs.
 - The standard costing of items uses the standard cost in effect at the time of the return.
 - The actual costing of items with lot or serial cost profiles uses the specific lot IDs and serial IDs on the transaction. The actual costing of items with FIFO or LIFO, uses the next FIFO or LIFO receipt (as predetermined with the supplier), even if the RTV indicates a specific PO or receiver.
- The RTV variance. If there is a difference between the item's RTV price and the cost used to relieve inventory, then an RTV variance is calculated. These RTV variances use the transaction group 415 (RTV Variances) to account for those differences.

Costing Destroyed Material

The Transaction Costing process costs the destroy transaction that is used when you destroy an item instead of returning it and expect a replacement in the same manner as it costs the RTV depletion. The Accounting Line Creation process (CM_ALC) also handles the destroy transaction in the same manner as it accounts for the RTV depletion, using the Transaction Accounting Rules-Accounts page for the RTV transaction group (012 and 013).

Returning Consigned Inventory

When you return a consigned item from a nonowned location, the system assumes that the item is not consumed and is still owned by the consignment supplier. The system therefore makes no accounting entry.

When you return a consigned item from an owned location, the system treats it like a regular owned item. In this case, all costing accounting entries are the same as those for a regular, owned RTV.

Returning Subcontracted Material

Subcontracted material can be returned for replacement or credit:

When you return it for replacement, the system makes no accounting entries other than the recognition of the outside processing costs for the good assemblies. This is handled in the earned labor, overhead, outside processing entry in WIP.

When you return subcontracted material for credit, the system scraps the unacceptable assemblies in production. Since the outside processing costs are not incurred, the assemblies must be scrapped at a cost that includes all material, labor, overhead, and outside processing costs up to that subcontracted operation. It does not include the subcontracted operations costs.

Reviewing an RTV Example

This example displays how RTV accounting entries are created.

<i>Inventory</i>	<i>Accrued RTV Receivable</i>	<i>Gain/Loss on RTV</i>	<i>Accts Payable</i>				
	500 (1)	500 (1)					
			450 (2)			450 (2)	
			50 (3)	50 (3)			

1. In the PeopleSoft Inventory/Cost Management, inventory is reduced by the amount of the returned stock using the transaction group 012, Return to Vendor.
2. In the PeopleSoft Payables system, an debit voucher is entered, posted, and extracted. This credit voucher is for the cost of the returned stock plus any additional charges such as restocking fees. This amount may or may not match the value credited to the inventory account.
3. In the PeopleSoft Inventory/Cost Management, the difference between the credit voucher and the inventory stock reduction is recorded as a gain or loss due to RTV using the transaction group 415, RTV Variance.

Reconciling PeopleSoft Cost Management and Payables

Understanding the CM/AP Reconciliation Tool Set

Purchase order receipts to inventory can yield many inventory putaways. Each inventory putaway can yield many accounting entries, which generally debit an inventory asset account and credit the accrued liability account as specified on the purchase order receipt.

On the PeopleSoft Payables side, vouchers are entered to set up payment for supplier invoices. Each purchase order receipt to inventory can yield many vouchers from many suppliers for the material and its landed cost charges. Each of those vouchers generally triggers a debit to accrued liability (as specified on the purchase order receipt) and a credit to accounts payable.

The CM/AP Reconciliation tool set helps with the task of ensuring that for each purchase order receipt, the entries to accrued liability from PeopleSoft Cost Management are reconciled with the entries from PeopleSoft Payables. These entries should offset, netting to zero. In practice, there are a number of situations where the accounting entries from the two sources do not offset:

- Receipts are not yet put away.
- Putaways and adjustments are not costed.
- Putaways and adjustments are costed but accounting entries are not yet created.
- Putaways and adjustments are costed and accounting entries are created, but are not picked up by the Journal Generator.
- Receipts are not vouchered.
- Receipts are vouchered but are not posted to voucher accounting lines.
- Wait for final cost is in effect (select the Hold for Final Cost check box on the cost profile so that no costing of transactions occurs until the voucher is matched) if you run in midperiod mode (to minimize adjustments). In regular mode, the purchase order amounts post if the voucher is not yet processed.
- Voucher amounts are different than the purchase order receipt amounts, and those matched cost adjustments are not yet processed through PeopleSoft Cost Management and passed on to the general ledger.
- User-created journal entry to manually account for a difference.

Using the CM/AP Reconciliation Tool Set

The CM/AP Reconciliation tool set allows you to:

1. Run the CM/AP Reconciliation process (CM_APRECN) to match up PeopleSoft Cost Management entries for receipts against PeopleSoft Payable entries for receipts.
2. The CM/AP Reconciliation Summary provides inquiries into the receipts that do not offset each other, and drill-down capabilities through the details of those transactions. Also, there is an option to select receipts that should no longer be displayed on the reconciliation list. These receipts are designated by users as insignificant differences, or they are dealt with in some fashion, such as a manually entered journal entry. You can view and mark as reconciled the receipts having corresponding payables entries that do not balance to zero. You can also view and mark as reconciled the voucher entries that do not have corresponding costing entries but have been accounted for elsewhere.
3. Use the CM/AP Reconciliation Detail to view all detail information about PeopleSoft Payables transactions and PeopleSoft Cost Management transactions. You can also mark any discrepancies as reconciled.

Note: The CM/AP Reconciliation tool set does not perform reconciliation entries, but it does provide information necessary for you to understand and resolve reconciliation differences.

Pages Used to Reconcile PeopleSoft Cost Management and Payables

<i>Page Name</i>	<i>Definition Name</i>	<i>Usage</i>
<u>CM/AP Reconcile Page</u>	CM_APRECN_REQ	Run the CM/AP Reconcile process, after which you can use inquiry pages to find Payables transactions that you need to reconcile with PeopleSoft Cost Management transactions.
<u>CM/AP Reconciliation Summary Page</u>	CM_APRECN_INQ	View summary information about discrepancies between Payables transactions and PeopleSoft Cost Management transactions. You can also mark the discrepancies as reconciled. ChartField security can be applied to this page.
<u>CM/AP Reconciliation Detail Page</u>	CM_APRECN_DETAIL	View all detail information about Payables transactions and PeopleSoft Cost Management transactions from the request process. You can also mark any discrepancies as reconciled. ChartField security can be applied to this page.

CM/AP Reconcile Page

Use the CM/AP Reconcile page (CM_APRECN_REQ) to run the CM/AP Reconcile process, after which you can use inquiry pages to find Payables transactions that you need to reconcile with PeopleSoft Cost Management transactions.

Navigation:

Cost Accounting > Inventory and Mfg Accounting > Analyze Inventory Accounting > Reconcile Accrued Liability > CM/AP Reconcile

This example illustrates the fields and controls on the CM/AP Reconcile process page. You can find definitions for the fields and controls later on this page.

The screenshot shows the 'CM / AP Reconcile' page with the following fields and controls:

- Buttons: Run Control ID, Reconcile, Report Manager, Process Monitor, and a yellow 'Run' button.
- *Request ID: Text input field containing 'RECONCILE'.
- Description: Text input field containing 'Reconcile'.
- *Process Frequency: Dropdown menu set to 'Always Process'.
- *Business Unit: Text input field containing 'US010' with a search icon.
- *Account: Text input field with a search icon.
- *Fiscal Year: Text input field.
- Include Prior Fiscal Years: Check box (unchecked).
- *Accounting Period: Text input field.
- Delete All Previous Results: Check box (unchecked).

Use the CM/AP Reconcile process (CM_APRECN) to match PeopleSoft Cost Management accounting entries (that are posted to the general ledger) to a matching entry in Payables accounting line table. This process reports any entries that cannot be matched. After running the CM/AP Reconcile process, use inquiry pages to find Payables transactions that you need to reconcile with PeopleSoft Cost Management transactions. There are many causes of discrepancy; for example, maybe you did not voucher a receipt, or you entered a voucher for an amount that differs from the amount on the purchase order. Actions like these can then cause the system to, for instance, not voucher a receipt, not post a vouchered receipt to the voucher accounting lines, not pick up an accounting line with the journal generator, or to post a voucher to the liability account without a receipt.

Field or Control	Description
Business Unit	Enter your Inventory business unit.
Account	Enter the number (ChartField) of an accrued liability account. The system accepts the number of any account used by both PeopleSoft Cost Management and PeopleSoft Payables.

Field or Control	Description
Fiscal Year and Accounting Period	<p>Enter the time period to be used by this process. The system collects all receipts and vouchers from the first period of the fiscal year to the accounting period entered. Using this time period, the process:</p> <ol style="list-style-type: none"> 1. Collects all receipts with the accrued liability account named in the Account field and marked as distributed to the general ledger. 2. Collects all vouchers matched to the receipts selected. 3. Collects all vouchers with the accrued liability account named in the Account field and marked as distributed to the general ledger.
Include Prior Fiscal Years	Select this check box to include all outstanding receipts from the prior fiscal year that have not yet been vouchered (non-reconciled receipts).
Delete All Previous Results	Select if you want this run to delete the results of all previous runs. If the check box is not selected, only the data from the prior run of the selected Run Control ID and Request ID are deleted.

CM/AP Reconciliation Summary Page

Use the CM/AP Reconciliation Summary page (CM_APRECN_INQ) to view summary information about discrepancies between Payables transactions and PeopleSoft Cost Management transactions.

You can also mark the discrepancies as reconciled. ChartField security can be applied to this page.

Navigation:

Cost Accounting > Inventory and Mfg Accounting > Analyze Inventory Accounting > Accrued Liability Summary > CM/AP Summary

This example illustrates the fields and controls on the CM/AP Reconciliation Summary page displaying costing entries without vouchers. You can find definitions for the fields and controls later on this page.

CM / AP Summary									
Run Control ID:		RUN			Request ID:		RUN		
Description:		run							
Costing Entries without Vouchers									
Error OK	Item	Recv Unit	Receipt ID	Line	Sched #	Payables Total	Inventory Total	Difference	Details
<input type="checkbox"/>	ACT	US001	0000000078	1	1		225.00	225.000	Details
<input type="checkbox"/>	ACT	US001	0000000078	1	1		-225.00	-225.000	Details

This example illustrates the fields and controls on the CM/AP Reconciliation Summary page displaying vouchers without costing entries. You can find definitions for the fields and controls later on this page.

CM/AP Summary										
CM / AP Summary										
Run Control ID:		recon				Request ID:		RECON		
Description:		Reconcile								
Costing Entries with Voucher Balance										
Error OK	Item	Recv Unit	Receipt ID	Line	Sched #	Payables Total	Inventory Total	Difference	Details	
<input type="checkbox"/>	ACT	US001	0000000080	1	1	90.00		90.00	Details	
<input type="checkbox"/>	AVG	US001	0000000080	2	1	90.00		90.00	Details	

This example illustrates the fields and controls on the CM/AP Reconciliation Summary page displaying costing entries with vouchers. You can find definitions for the fields and controls later on this page.

CM/AP Summary										
CM / AP Summary										
Run Control ID:		GEN				Request ID:		GEN		
Description:		Generatae								
Costing Entries with Voucher Balance										
Error OK	Item	Recv Unit	Receipt ID	Line	Sched #	Payables Total	Inventory Total	Difference	Details	
<input type="checkbox"/>	PHLC	US001	0000000058	1	1	15500.00	4500.00	20000.00	Details	

After you run the CM/AP Reconcile process, you can view summary information about discrepancies between the costing balance in PeopleSoft Cost Management and the voucher balance in PeopleSoft Payables. You can also mark the discrepancies as reconciled. Balanced receipt lines are marked as reconciled and do not appear on the summary page. This component can display the following information:

- Vouchers without costing entries.
- Costing entries without vouchers.
- Costing entries with voucher balances.

Field or Control	Description
Error OK	Select this check box to mark the discrepancies as reconciled. The receipt line does not appear in future runs.
Item	Displays the item ID.
Recv Unit	Displays the receiving business unit attached to the receipt ID.

Field or Control	Description
Payables Total	Displays the payables accounting entries summed to the voucher line. A blank in the this field indicates that the receipt was not vouchered.
Inventory Total	Displays the inventory accounting lines that are summed to the receipt schedule line.
Difference	Displays the absolute value of the difference between the Payables Total field and the Inventory Total field.
Details	Click this link to access the CM/AP Reconciliation Detail page where you can see the actual accounting entries for the receipt schedule line.
AP Unit	Displays the PeopleSoft Payables business unit. This field only displays if there are vouchers without costing entries.
Voucher	Displays the voucher ID. Select this link to access the Voucher Inquiry page within PeopleSoft Payables where you can review the status of the voucher and any payment information. This field only displays if there are vouchers without costing entries.

ChartField security can be applied to this page.

See [Enabling ChartField Security](#).

CM/AP Reconciliation Detail Page

Use the CM/AP Reconciliation Detail page (CM_APRECN_DETAIL) to view all detail information about Payables transactions and PeopleSoft Cost Management transactions from the request process.

You can also mark any discrepancies as reconciled. ChartField security can be applied to this page.

Navigation:

Cost Accounting > Inventory and Mfg Accounting > Analyze Inventory Accounting > Accrued Liability Details > CM/AP Detail

This example illustrates the fields and controls on the CM/AP Detail page. You can find definitions for the fields and controls later on this page.

Accrued Liability Details

Recv Unit: US001
 Receipt ID: 0000000058 Receipt Line: 1
 Item ID: PHLC Ship Seq: 1

Reconciled

Inventory Accrued Liability Customize | Find | First 1-3 of 3 Last

Transaction Account

IN Unit	Seq Nbr	Group	Accounting Line	Acctg Date	Date/Time	Cost Elmnt	Description
US010		1 020	21914	08/11/2009	08/11/2009 3:19:03.900000AM	100	Material - General
US010		1 020	21915	08/11/2009	08/11/2009 3:19:03.900000AM	100	Material - General
US010		1 400	154	08/11/2009	08/11/2009 3:19:03.900000AM	100	Material - General

Vouchers Customize | Find | First 1 of 1 Last

Distribution Account

Unit	Voucher	Line	Dist	Vendor	Name	Merchandise	Sales Tax	Freight	Use Tax	Mis
US001	00000111	1	1	SCM0000001	BIKE SHOP	15500.00				

After you run the CM/AP Reconcile process, use this page to view all detail information about Payables transactions and PeopleSoft Cost Management transactions from the request process. You can also mark any discrepancies as reconciled.

The **Reconciled** check box is selected if the receipt and voucher are balanced; it is deselected if the receipt and voucher do not balance. Select **Reconciled** if the discrepancy for this transaction is acceptable.

Inventory Accrued Liability

Use the **Transaction** tab on this page to view and reconcile accrued liability transactions that have corresponding voucher entries that do not balance to zero. Click the **Accounting Line** link to drill to transaction details on the Inventory Transaction Entries page.

Use the first **Account** tab on this page to view account information for accrued liability transactions having corresponding voucher entries that do not balance to zero.

Vouchers

Use the **Distribution** tab to view and reconcile voucher distribution lines having accrued liability transactions that do not balance to zero. Click the **Voucher** link to see details on the Voucher Inquiry page.

Use the second **Account** tab to view account information for voucher entries that do not have corresponding costing entries.

ChartField security can be applied to this page.

Related Links

[Enabling ChartField Security](#)

Analyzing Manufacturing

Understanding Production Analysis

PeopleSoft Cost Management enables you to manage and evaluate cost performance. When you are in the process of manufacturing items, you can generate inquiries and reports that depict potential production variances and that notifies the appropriate individuals of the variances through workflow. After you close production to accounting, you can run detailed reports that analyze production variances and WIP inventory value.

Prerequisite To Analyze Manufacturing

Before using this topic, review the closing production and reopening production sections of the *PeopleSoft Manufacturing*.

Related Links

"Understanding the Production Close Process" (PeopleSoft Manufacturing)

Analyzing Production Variances for Standard Cost Items

When you close a production ID or production quantity for accounting, PeopleSoft Manufacturing calculates variances. The variances capture the differences between the cost of what is built and the frozen standard cost of the item. The process breaks down the variances by reason, such as: configuration, usage, component yield, lot size, routing process, rework, teardown, outside processing, and output mix. These variances are summarized up to the production ID and cost element level and are used for accounting and analysis purposes.

Once closed for accounting, PeopleSoft Manufacturing calculates these production variances:

Variance Type	Accounts For	Calculation	Transaction Group
01- Configuration	See <i>Understanding the Configuration Variance</i> section below this table.	Summarized for all components, calculated by cost element: [(ISSUE_QTY + YIELD_QTY) * component's this level and lower level costs] - component usage variance - component yield variance - (production ID completion qty * prodcost LL cost) - component total production scrap cost - mix variances- operation yield.	261 – Material Variances
02 - Usage	Cost that is associated with the difference between the component's current scheduled quantity and the actual issue quantity. The current scheduled quantity is based on the number of components that should have been used for the completed assemblies. The actual issue quantity is the number of good components that are consumed for the completed assemblies or kitted to the production ID. Usage variance is not calculated for floor stock or expensed items.	[(ISSUE_QTY - (CURR_SCHED_QTY * YIELD/100)) * each element of the component's costs summarized by this level and lower level. The component's current scheduled quantity is adjusted to take into account assemblies that are scrapped before where the component is required. Additionally, the current scheduled quantity is adjusted again when the full production quantity is not completed but production is closed.	261 – Material Variances
03 - Component yield	Cost associated with the difference between the expected and the actual component yield loss of a component in production. Component yield variance is not calculated for floor stock or expensed items.	[(YIELD_QTY - (Current Schedule Qty * 1 - YIELD/100)) * component cost by cost element summarized by this level and lower level. The component's current scheduled quantity is adjusted to take into account assemblies that are scrapped before the component is required. Additionally, the current scheduled quantity is adjusted again when the full production quantity is not completed but production is closed. In this manner, the current schedule quantity is based on the quantity completed multiplied by the quantity per for the component.	261 – Material Variances

Variance Type	Accounts For	Calculation	Transaction Group
04 - Labor (and Machine) Lot size	Difference in per-unit setup, fixed run, and postproduction conversion costs when the system completes assemblies (with a quantity that differs from the average order quantity [AOQ]) at an operation. Lot size variances could occur if you have split a production ID and the parent and child production ID quantity are each less than the assembly item's AOQ.	For labor and machine lot size variance: Calculated by operation: (AOQ - assembly quantity issued to the operation) * (setup, fixed run, or postproduction operation time expressed in hours * corresponding labor or machine rate/AOQ).	262 – Conversion Variances
05 - Routing process	Financial impact of changes in an item's routing for a production ID or production run. This includes adding, deleting, or skipping operations and changing work centers or tasks. Note: The Routing Process variance is not displayed on the Production Variance Drilldown page.	Summarized by cost element: Earned labor, machine, and overhead costs from SF_EARNCONCOST - lot size variance - this-level-only assembly scrap - this-level-only assembly completions.	262 – Conversion Variances
08 - Material Lot Size	A material lot size variance accounts for the difference between the production quantity and the AOQ for those components whose production quantity is per order. Lot size variances could occur if you have split a production ID and the parent and child production ID quantity are each less than the assembly item's AOQ.	(AOQ - assembly quantity issued to the operation) * component's this-level plus lower-level costs.	261 – Material Variances
09 - Rework (Material) Expense	Total charges that are incurred for the rework production ID are compared to the standard cost of the reworked assembly. The difference is the rework expense.	Standard cost of the reworked assembly - total charges that are incurred for the rework.	263 – Rework Expense
10 - Rework Labor Expense			263 – Rework Expense

Variance Type	Accounts For	Calculation	Transaction Group
11 - Outside Processing Variance PPV	The difference between the standard outside processing costs of the operation and the supplier's price as stated on the purchase order that is used to manage the subcontracted operation.	(PRICE_PO from the production ID's purchase order - outside processing cost from the production ID's operation list) * quantity that is completed at the subcontract operation.	264 – Outside Processing PPV
12 - Mix	The difference between the actual outputs and the expected outputs.	Calculated and totaled by cost element. Applied to all outputs (co-product, by product, waste, and recycle). OUTPUT_LIST.SCHED QTY - OUTPUT_LIST.COMP QTY) * (prodcost TL cost + prodcost LL cost)	261 – Material Variances
13 - Teardown Material Expense	Total charges that are incurred for the teardown production ID are compared to the standard cost of the assembly that is to be torn down. This variance includes any components that are lost in the teardown process.	(Standard cost of the assembly to tear down + standard cost of any additional components) - (standard cost of component outputs or assembly scrap)	265 – Teardown Variance
14 - Teardown Conversion Expense	Total charges that are incurred for the teardown production ID are compared to the standard cost of the assembly that is to be torn down. This always includes the This Level Labor costs of the assembly that is torn down. It could also include additional labor and overhead costs if a teardown operation list is used.	(Standard cost of the assembly to tear down + any labor and overhead added) - (standard cost of component outputs or assembly scrap)	265 – Teardown Variance
15 – (Operation) Yield	Difference between actual scrap and expected scrap at the operation when there is operation yield on the operation list. The difference in scrap quantity is costed at the cumulative cost for the operation at which it is incurred.	Calculated by cost element: {(actual scrap – [operation start quantity * (1– (operation yield/100))]} * cumulative operation cost	262 – Conversion Variances

Note: Variances can be incurred depending on the item's unit of measure rounding and precision. If you have a unit of measure for an item that has a precision of 0 to the right of the decimal, the item can be issued only in whole units. If the item is a component on a BOM and has a component yield factor, the system schedules the component on a production ID or schedules only in whole units. However, the cost of the assembly item using the component is calculated by using the fractional quantity. This could result in small variances, because the sum of the scheduled component costs is greater than the cost of the total completed number of assemblies using the component.

Understanding the Configuration Variance

The configuration variance consists of variance amounts caused by:

- Difference between the cost of the production ID or production quantity's bill of material (BOM) and the cost of the bill that is used to determine the current production costs.
- Changes to AOQ.
- Quantity differences due to rounding to the appropriate unit of measure.
- Any remaining variance amounts not already included in another production variance.

If the Enable Variance Drilldown check box was selected at the business unit level, then any configuration variance is stored in the Configuration Variance Detail record (SF_CFGVAR_DET) by the Close Production process. The configuration variance amounts are documented in this record with a message set and message number to identify the reason for the amount, including:

Message Set	Message Number	Message Text	Description
15401	252	Component Std Cost or Qty-Per changed	The standard cost or quantity per amount has been changed on the bill used for production.
15401	253	Component cost not in ASSY Frozen Std	A component cost in production does not match the frozen standard cost of the BOM.
15401	254	Added to component list, not in the frozen std	The cost of a component that was added to production but was not included in the BOM.
15401	255	Component Deleted	A component was deleted from production but was part of the BOM.
15401	261	Misc Config Variance by Cost Element	Miscellaneous variances that could be due to rounding, changes in quantity per order, and other reasons.

Reviewing Production Variances Reports for Standard Cost Items

PeopleSoft Manufacturing provides the online Production Variance Drilldown component (Production Control, Close and Analyze Production, Production Variance Drilldown) to view the calculations of each production variance. The production variance calculation details are retrieved from the Production Variance Detail record (SF_VARS_DETAIL) and the Configuration Variance Detail record (SF_CFGVAR_DET) that are populated during the Close Production process (SFS1100) for production IDs and schedules with the status of Closed for Accounting.

In addition, after the Cost Accounting Creation process has been run, the Posted Variance Drilldown page (Cost Accounting, Inventory and Mfg Accounting, Analyze Production Costs, Posted Variance Drilldown) can be used to view the accounting lines related to the production variances. Links on both the Production Variance Drilldown page and the Posted Variance Drilldown page enable you to drill down into more detailed information or drill up into summary information.

PeopleSoft Cost Management provides two reports for analyzing variances:

Field or Control	Description
Potential Production Variance Report	Lists potential variances that exist in production before closing the production IDs and schedules for accounting. You can generate the report when you are in a production status that is in process, pending complete, complete, or closed for labor. Review this report periodically so that you can act to correct potential production problems. In addition, the system can send the report to the appropriate individuals through workflow to notify them of the potential variances. When this report is run, no accounting close occurs, and no variances are posted. This process only calculates and reports the variances based on the current snapshot of production.
Production Variance Report	Lists production variances that exist after you close production IDs and schedules for accounting. Reports all PeopleSoft Manufacturing variances except efficiency and utilization.

Pages Used to Analyze Production Variances for Standard Cost Items

Page Name	Definition Name	Usage
<u>Posted Variance Drilldown Page</u>	CE_PRD_VAR_INQ	View accounting lines related to production variances calculated in PeopleSoft Manufacturing. Links on this page enable you to drill down into more detailed information or drill up into summary information.

Posted Variance Drilldown Page

Use the Posted Variance Drilldown page (CE_PRD_VAR_INQ) to review accounting lines posted for production variances produced for a production ID or schedule in PeopleSoft Manufacturing.

Navigation:

Cost Accounting >Inventory and Mfg Accounting >Analyze Production Costs >Posted Variance Drilldown

This example illustrates the fields and controls on the Posted Variance Drilldown page. You can find definitions for the fields and controls later on this page.

The Posted Variance Drilldown page displays only one accounting line number at a time.

Note: In order to view accounting line data using the Posted Variance Drilldown page, the production ID or schedule must be in the status of Closed for Accounting and you must first run the Close Production process to populate the Production Variance Detail record (SF_VARS_DETAIL) and the Configuration Variance Detail record (SF_CFGVAR_DET) and then run the Cost Accounting Creation process to generate accounting entries.

The **Account Line Number** group box displays information about the accounting line reviewed on this page.

Click the **Variance Drilldown by Production ID** link to access the Production Variance Drilldown page where you can review the calculation details of the production variances produced for a production ID or schedule. The Production Variance Drilldown page displays only one production ID or schedule at a time.



Variance Details

The Variance Details group box displays the accounting entry details, amounts, and different variance types. The Production Detail tab displays information about the accounting entry.

Field or Control	Description
 (Download icon)	Click the Download icon to move the data in the displayed tab to a Microsoft Excel spreadsheet.
Debit Line Number and Credit Line Number	Displays the accounting line number. Click this link to access the Production Variances- Transaction Details page to view additional transaction details related to the production variance.

Variance Type Group Box

For the production variance that created this accounting line, you can display a group box for the specific variance. The title of the group box is the variance type name. All required information used to calculate the variance is included in the Variance Detail tab. The fields displayed are different based on the variance type. The Production Detail tab displays information about the production ID or schedule.

<i>Field or Control</i>	<i>Description</i>
 (Embedded Help icon)	Click the Embedded Help icon to display information about the production variance and how it is calculated.
 (Download icon)	Click the Download icon to move the data in the displayed tab to a Microsoft Excel spreadsheet.

Analyzing WIP Inventory Value in Standard Cost Environments

Periodically, you must determine the value of material in process. Use this data to verify the general ledger balance for WIP inventory as well as to provide management with an indication of in-process inventory levels.

In-process inventory includes three parts:

- Raw material or subassemblies for regular production that are issued to the shop floor not yet used in an assembly.

This portion of in-process inventory is stored in the work center's WIP locations and is included as part of the stockroom inventory valuation. Materials in WIP locations use the issue or replenishment method of issuing material.

- Items in various stages of assembly (including material consumed from the WIP locations) as well as labor, machine, overhead, and outside processing costs that are incurred up to the point that the WIP inventory value report is run.

Additionally, components that are kitted to a production ID are directly charged to production and are, therefore, included as part of the in-process inventory (although they might not yet be part of the assembly item). The WIP Value report does not include the costs of scrapped components or assemblies that are completed to stock.

- Rework or tear down assemblies or subassemblies that are issued to the shop floor.

You might issue additional components to rework an item and incur additional labor and overhead expenses to rework or tear down.

PeopleSoft Manufacturing uses information that is associated with a specific production ID or production quantity as the basis for determining the WIP value; it also maintains a status for all production. WIP value comprises production with a status of:

- In process

- Pending complete
- Complete
- Closed for labor

Production with a status of entered, firmed, released, canceled, or closed for accounting status is not included in the WIP value.

PeopleSoft Manufacturing uses various records to determine WIP value:

Record	Function
Production ID Component List	Determines the components that are used. Maintains the quantity of each component that is issued into production. By costing the component's issued quantity, the system can determine the lower-level costs of the assembly. The component list also contains the rework or teardown assembly issue quantities. This value is determined by multiplying the assembly item's this-level and lower-level costs by the issued quantity.
Earned Conversion Costs	Maintains the labor, machine, and overhead costs that are incurred to date for the production ID or production quantity. This includes conversion costs that are incurred for a subcontracted operation.
Assembly Scrap Costs	Maintains the value of scrapped assemblies to subtract from the in-process value. This includes scrap costs that are incurred for a subcontracted operation.
Production Header Output Record	Contains the quantity that is completed. For a single output production ID or schedule, this is the assembly quantity. For multiple output production, this includes the quantity of primary, co-product, and by-product completions. The system also subtracts costed completions from the WIP value.

Determining WIP Value

Use the WIP Inventory Value report to analyze work in process. The basic procedure for determining WIP value is:

- Determine the cost of components that are consumed from WIP locations or kitted directly to a production ID.

If the production ID is for rework or teardown, the cost of the assemblies that are issued to production is determined.

- Add any labor, machine, outside processing and overhead costs.
- Add any waste by-product costs.
- Subtract scrapped assemblies.

- Subtract assemblies and primary products, co-products, and by-products that are completed and moved to stock or to another production area.

The result is inventory remaining in process.

Understanding WIP Inventory Value Report Categories

The categories of cost across the top of the report correspond to the categories that are associated with the cost elements. They are:

- Material
- Inbound
- Conversion (labor and machine)
- Conversion overhead
- Outbound
- Other

PeopleSoft Manufacturing further defines each of these categories:

Summarization Category	Definition	PeopleSoft Manufacturing:
Component costs	These lower-level costs are the costs that are associated with the components that are issued to production. If the PID is for rework or teardown, these costs represent the assembly items this-level and lower-level costs.	For each component, multiplies the issued quantity by the component's standard cost as its defined in the Current Costs by Item record. It then combines this-level and lower-level costs for a given cost element.
Earned this level costs	The assembly's labor, machine, subcontract, and overhead costs earned to date based on the assembly operation completions that are recorded. Maintained in the SF_EARNCONCOST record.	Subtracts negative records that are associated with a production ID (due to completion reversals or revaluations) from the total.
Waste by-product costs	Costs that are associated with the disposal or removal of waste by-products.	Adds costs due to waste by-products to the total for the cost category. It is determined by multiplying the completed quantity as stated in the Production Output record by the cost of the waste item.

Summarization Category	Definition	PeopleSoft Manufacturing:
Less assembly scrap	Maintained in the SF_SCRAPCOST record.	Adds negative records (due to reversals of scrap or revaluations) from the total for the cost category.
Less assembly completions	Costs that are associated with the assemblies that are completed to stock.	Determines this value by multiplying the quantity of assemblies that are completed to stock or another production area by the assembly's standard cost. Includes primary item, co-products, and recycle by-products. It combines this-level and lower-level costs for a cost element.

Related Links

[Understanding the Manufacturing Standard Cost Foundation](#)

[PeopleSoft Cost Management Reports: A to Z](#)

Analyzing Efficiency Variances and Work Center Utilization

If you record actual labor and machine hours, you want to analyze efficiency variances and work center utilization. The Efficiency/Utilization report details variances and utilization by work center. Within work centers, the production ID or schedule that utilized the work center is specified.

Efficiency variance is the difference between the actual hours that are expended for an operation and the earned hours for the operation. Earned hours are based on the standard costing labor and machine setup, run, fixed-run, and postproduction times that are specified in the production operation list and on the quantity that is completed at the operation. The system reports efficiency variances for both labor and machine.

Utilization compares the available hours for a work center to the actual hours that are recorded for a work center. Available hours are equal to the scheduled hours (if entered for the work center) during actual labor and machine time recording. If scheduled hours are not entered, available hours are derived from the work center, production, or five-day workweek calendar. The system reports utilization measurements for both labor and machines by work center.

Note: PeopleSoft Manufacturing reports on (but does not post) efficiency variances and utilization calculations.

Displaying Scrap and Standard Earned Conversion Costs

Periodically, you want to monitor scrap and earned conversion costs that are associated with production. Viewing this information enables you to see how the manufacturing floor is performing. PeopleSoft provides you with the ability to view scrap and earned conversion costs against production IDs and production schedules in the production environment.

Earned conversion costs are calculated for:

Field or Control	Description
Labor or Machine Setup	Setup time converted to hours multiplied by the labor or machine setup rate. Setup is earned when the first completion is recorded for the operation or when the SetUp Complete check box is selected during the recording of completions and scrap for an assembly.
Labor or Machine Fixed Run	Fixed run time converted to hours multiplied by the labor or machine fixed run rate. Fixed run is earned when the first completion is recorded for the operation.
Labor or Machine Run	When the run labor or machine rate is in terms of a rate per hour, the run times (or run rates) are converted to an amount per hour multiplied by the quantity completed, which is then multiplied by the labor or machine rate. When the labor or machine rate is in terms of an amount per unit, the per-unit amount is multiplied by the quantity that is completed.
Labor or Mach Post Production	Post production time converted to hours, multiplied by the labor or machine post production rate. Post production time is earned when the Post Production check box is selected during the recording of completions and scrap for an assembly or when a production ID or schedule is closed for accounting.

Pages Used to Display Scrap and Earned Conversion Costs

Page Name	Definition Name	Usage
Scrap List by Operation Page	SF_SCRAP_INQ_OP	After entering data in the Production Selection page, you can view scrap information by operation sequence for a specific production ID or production schedule.
Scrap Cost Detai Pagel	SF_SCRAP_INQ	After entering data in the Production Selection page, you can view detailed scrap costs for the production ID or schedule broken down by operation sequence.
Earned Conversion Cost by Operation Page	SF_EARNCON_INQ_OP	After entering data in the Production Selection page, you can view conversion cost information by operation sequence for a specific production ID or production schedule.

<i>Page Name</i>	<i>Definition Name</i>	<i>Usage</i>
Earned Conversion Cost Detail Page	SF_EARNCON_INQ	After entering data in the Production Selection page, you can view earned conversion cost detail for production.

Displaying Actual Labor Information

Use the Actual Labor inquiry pages to display a summary of the actual labor and machine hours, by operation or work center, recorded for a particular date, and to display those same actual hours in more detail by the type of labor or machine that is performed.

Pages Used to Display Actual Labor Costs

<i>Page Name</i>	<i>Definition Name</i>	<i>Usage</i>
Actual Hours by Operation Page	SF_ACTHRS_INQ_GRD	After entering data in the Production Selection page, you can view actual labor and machine hours for a production ID or schedule by operation.
Actual Hours Detail Page	SF_ACTHRS_INQ	After entering data in the Production Selection page, you can view detailed information on actual labor and machine hours for a production ID or schedule by operation.
Crew/Machine Resources Detail Page	SF_ACTHRS_INQ_SEC	View the details for the crew or machine.

Chapter 15

Analyzing Financial Transactions

Understanding Financial Transaction Analysis

Monitoring general ledger activity is very important in any environment. PeopleSoft Cost Management provides several tools to review financial transactions, including:

- Using online inquiry pages to review transactions in an interactive mode.
- Generating reports that give vital information on the financial health of an organization.

Prerequisites To Analyze Financial Transactions

You can begin to analyze financial information after PeopleSoft Cost Management accounting lines are created. To create accounting lines, you need to perform these functions:

- Generate financial transactions by using PeopleSoft Distribution and Manufacturing.
- Execute the Transaction Costing process (CM_COSTING) within the Cost Accounting Creation process to cost the financial transactions.
- Execute the Accounting Line Creation process (CM_ALC) within the Cost Accounting Creation process to generate the accounting lines for the transactions.

Once the accounting lines are created, you can navigate, report on, and view accounting information within PeopleSoft Cost Management before it is processed through the Journal Generator.

After generating the accounting lines for the transactions, you can execute the Journal Generator process (FSPGJGEN) to prepare the transactions for posting to the journal. Once the Journal Generator process is completed, you have the ability to navigate from both PeopleSoft General Ledger and PeopleSoft Cost Management.



Related Links

[Understanding Transaction Costing and Accounting Entry Creation](#)

"Setting Up for Journal Generator" (Application Fundamentals)

Common Elements Used to Analyze Financial Transactions

<i>Field or Control</i>	<i>Description</i>
	Click the View Related Links button to go to the Transfer Menu, where you can drill to general ledger and transaction details.

Field or Control	Description
	Click the More Details button to view an additional page with more detailed information.
	Click the Download button to load the data that appears on the page to a Microsoft Excel spreadsheet.
FERC Code	Federal Energy Regulatory Commission identification codes. This field appears only if you select FERC reporting on the PeopleSoft Inventory Options page.
ChartFields	Chart of accounts that are used to record accounting entries and journal entries in PeopleSoft.
Cost Element	A code used to categorize the different components of an item's cost and also define the debit and credit ChartFields for accounting entries.
Transaction Group / Group	Predefined codes that are attached to different types of transactions, such as stocking, issues, adjustments, and so on.
Distribution Type	User-defined codes that are a subset of transaction groups. This enables you to break down a transaction group into customized categories.
Item Group	A grouping of items that enable you to design an accounting structure for a group of similar items, such as sporting equipment or dress shoes. The item group is attached to an item by using the Item Definition - General page.
Journal	The general ledger journal ID number. This is assigned when the journal entry is created.
Date	The journal date.
CM Unit	PeopleSoft Cost Management business unit, which is the same unit as the Inventory and Manufacturing business units.
Book Name	The cost book that is used to record the accounting entry.
Acctg Date (accounting date)	Date that the accounting line is created.
Base Amount	Transaction amount that is expressed in the base currency of the unit.

Field or Control	Description
Base Quantity	The item's quantity in the standard unit of measure for the item.
Container ID	The identification number of the storage container that is used to stock this inventory.
Conversion Type	The type of conversion costs that are incurred in the manufacturing process. Conversion types include labor setup, machine setup, labor fixed run, machine fixed run, labor run, machine run, labor post production, machine post production, and manufacturing overhead.
OH Rate Type	Overhead rate type.
OH Lab/Mac	Overhead labor and machine.
Variance Type	Identifies the type of variance. The variances are: 01 configuration, 02 usage, 03 component yield, 04 labor lot size, 05 rtg var (process routing variance), 06 efficiency variance, 07 rate variance, 08 material lot size, 09 rework expense, 10 rework labor expense, 11 outside processing PPV, 12 mix variance, 13 teardown material expense, and 14 teardown conversion expense.
Variance Source	Indicates when the variance is recorded. A variance source of C (close) indicates that the variances are calculated when the production ID or schedule is closed for accounting by using Production Control, Close and Analyze Production, Close Production. A variance source of O (open) indicates that production is reopened and all previously recorded variances are reversed by using Production Control, Close and Analyze Production, Reopen Production.
Production Type	The type of production. The options are: <i>PR</i> (production), <i>RW</i> (rework), and <i>TD</i> (teardown).
TL Scrap	This-level scrap cost that is associated with the scrap cost transaction.
LL Scrap	Lower-level scrap cost that is associated with the scrap cost transaction.
Revalue Type	The types of revaluation include: 01 inv (inventory), 02 inspection, 03 WIP- component costs, 04 WIP - assembly costs, and 05 WIP - waste costs.
Shipping Charge Type	Shipping charge types include freight charges, miscellaneous charges, and non-stockable items.

Field or Control	Description
CC Status	Options include: <i>A</i> (all), <i>E</i> (error), <i>N</i> (not budget checked), and <i>V</i> (valid).

Related Links

"Understanding PeopleSoft ChartFields" (Application Fundamentals)

Using the Financial Inquiry Pages

Viewing financial transaction detail and its associated accounting entries is necessary when investigating a suspect entry in the general ledger or when performing daily monitoring of production activity. PeopleSoft Cost Management enables you to see this transaction information on different pages depending on the type of transaction that you are investigating.

The financial inquiry pages consist of:

Field or Control	Description
Review Accounting Lines menu	Under this menu, three components enable you to review accounting entries, including, the Accounting Entries page, the Unposted Accounting Entries page, and the Posted Accounting Entries page.
Review Transaction Entries menu	Under this menu, nine separate pages give you the ability to view the most relevant information pertaining to the different types of transactions.
Review Transaction Details menu	Under this menu, nine separate pages give you the ability to review detailed information about the transaction that you select.

The Review Transaction Entries menu and the Review Transaction Details menu both include pages for you to review these types of entries:

- Inventory transactions.
- Earned conversion costs.
- Production variances.
- Production scrap costs.
- Production actual costs.
- Standard cost revaluations.
- Average cost adjustments.

- Actual cost adjustment.
- Non-stock shipment transactions.

You choose how you want to view accounting entries on the pages that display them. Entries can display debits and credits in one column or two separate columns based on the selection of the **Display Debit/Credit Amounts in Subsystems** check box on the Overall Preferences page. This default is applied by user ID. In addition, ChartField security can be applied to these pages.

Pages Used to View Transaction Entries

<i>Page Name</i>	<i>Definition Name</i>	<i>Usage</i>
"User Preferences - Overall Preferences Page" (PeopleSoft eSettlements)	OPR_DEF_TABLE_FS1	Based on user ID, specify overall default preferences, including the display of debits and credits in one column or two separate columns for the inquiries under the Review Transaction Entries menu and the Review Transaction Details menu. Select the Display Debit/Credit Amounts in Subsystems check box to display accounting entries in separate columns for debits and credits. Do not select this check box to display accounting entries in a single Monetary Amounts column that uses positive numbers to represent debits and negative numbers to represent credits.
Inventory On Hand Page	CM_OH_INQUIRY	View the accounting profile and current on-hand quantity for any item within a business unit. This inquiry page displays the item's book names, costing methods, on-hand quantity, and the value of the on-hand quantity.
Unposted to GL Page	CM_DRILL_UNPST_DET	View unposted accounting lines. Unposted accounting lines represent financial transactions that are not yet processed by the Journal Generator process so they are not posted in the journal in PeopleSoft General Ledger. The general ledger has no record of these transactions at this point. ChartField security can be applied to this page.

Page Name	Definition Name	Usage
Posted Accounting Lines Page	CM_DRILL_JRNL_DET	View posted accounting lines. Posted accounting lines represent financial transactions that are processed by the Journal Generator process originating from PeopleSoft Order Management, Purchasing, Inventory, and Manufacturing. These entries can now be posted to the appropriated journal in the general ledger. ChartField security can be applied to this page.
Accounting Entries Page	CM_ACCTG_LINE	To view accounting entries, enter the search criteria and click the refresh button. This page displays the both the debit and credit sides of the accounting entry and the complete ChartField combinations. ChartField security can be applied to this page.
Inventory Transactions - Transaction Entries Page	CM_DRILL_ACCT_INV	View the accounting entries for inventory transactions and the accounting entries for route to production transactions. ChartField security can be applied to this page.
Earned Conversion Costs - Transaction Entries Page	CM_DRILL_ACCT_ERN	View the accounting entries for earned-cost transactions. ChartField security can be applied to this page.
Production Variances - Transaction Entries Page	CM_DRILL_ACCT_VAR	View the accounting entries for variance transactions. ChartField security can be applied to this page.
Production Scrap Costs - Transaction Entries Page	CM_DRILL_ACCT_SCP	View the accounting entries for scrap-cost transactions. ChartField security can be applied to this page.

Page Name	Definition Name	Usage
Production Actual Costs - Transaction Entries Page	CM_DRILL_ACCT_MFG	View the accounting entries for actual-cost transactions in PeopleSoft Manufacturing. ChartField security can be applied to this page.
Standard Cost Revaluations - Transaction Entries Page	CM_DRILL_ACCT_REV	View the accounting entries for revaluation transactions. ChartField security can be applied to this page.
Avg Cost Adjustment Entries-Transaction Entries Page	CM_DRILL_ACCT_ADJ	View accounting entries for cost adjustment transactions to perpetual average and retroactive perpetual average items. This includes value adjustments and change average adjustments stored in the CM_COST_ADJ record. ChartField security can be applied to this page.
Actual Cost Adjustment Entries-Transaction Entries Page	CM_DRILL_ACCT_UADJ	View accounting entries for value adjustment transactions to actual cost items. This includes only value adjustments stored in the CM_USER_CST_ADJ record. ChartField security can be applied to this page.
Non Stock Shipment - Transaction Entries Page	CM_DRILL_ACCT_NSS	View the accounting entries for non-stock shipment transactions. ChartField security can be applied to this page.
Inventory Transactions - Transaction Details Page	CM_DRILL_INV_DET	View detailed information about inventory transactions and the accounting entries for route to production transactions. ChartField security can be applied to this page.
More Transaction Details Page	CM_DRILL_INV_IN	Displays additional information that is associated with the transaction.

Page Name	Definition Name	Usage
Earned Conversion Costs - Transaction Details Page	CM_DRILL_ERN_DET	View transaction detail that is associated with the earned-cost transaction. ChartField security can be applied to this page.
Production Variances - Transaction Details Page	CM_DRILL_VAR_DET	View transaction detail that is associated with the variance transaction. ChartField security can be applied to this page. See
Production Scrap Costs - Transaction Details Page	CM_DRILL_SCP_DET	View transaction detail associated with the scrap-cost transaction. ChartField security can be applied to this page.
Production Actual Costs - Transaction Details Page	CM_DRILL_MFG_DET	View transaction detail that is associated with actuals costs of production. ChartField security can be applied to this page.
Standard Cost Revaluations - Transaction Details Page	CM_DRILL_REV_DET	View transaction detail that is associated with the revaluation transaction. ChartField security can be applied to this page.
Avg Cost Adjustment Detail - Transaction Details Page	CM_DRILL_ADJ_DET	View transaction detail associated with the cost adjustment transaction for perpetual average and retroactive perpetual average items. This includes value adjustments and change average adjustments stored in the CM_COST_ADJ record. ChartField security can be applied to this page.
Actual Cost Adjustment Detail - Transaction Details Page	CM_DRILL_UADJ_DET	View transaction detail associated with value adjustment transactions for actual cost items. This includes only value adjustments stored in the CM_USER_CST_ADJ record. ChartField security can be applied to this page.

Page Name	Definition Name	Usage
Non Stock Shipment - Transaction Details Page	CM_DRILL_NSS_DET	View transaction detail that is associated with the non-stock shipment transaction. ChartField security can be applied to this page.

Related Links

"Defining Cross-Application User Preferences" (Application Fundamentals)

[Enabling ChartField Security](#)

Using the Drilling Functions for Cost Accounting Audit Trails

By using the financial inquiry pages, you can track financial transactions throughout the audit trail by drilling up to the journal entries and drilling down to the accounting entries. You can analyze financial transactions in a few different ways, including:

- Viewing an entry in the general ledger and drilling down to the actual transaction details or entries that created the entry.
- Viewing the financial transaction details or entries and drilling up to the journal entries that are created in the general ledger.
- Drilling between the actual transaction detail and the accounting entries for the transaction before or after you perform the Journal Generator process.
- Viewing accounting entries that are created without using the drill-up and drill-down functionality.
- Generating reports that display the accounting register, inventory value, and transaction register.

Note: If you have purge or archive production data, you cannot view production-related costs such as earned labor, scrap costs or variances.

This diagram illustrates the drill up and drill down flow between transactions and accounting entries.

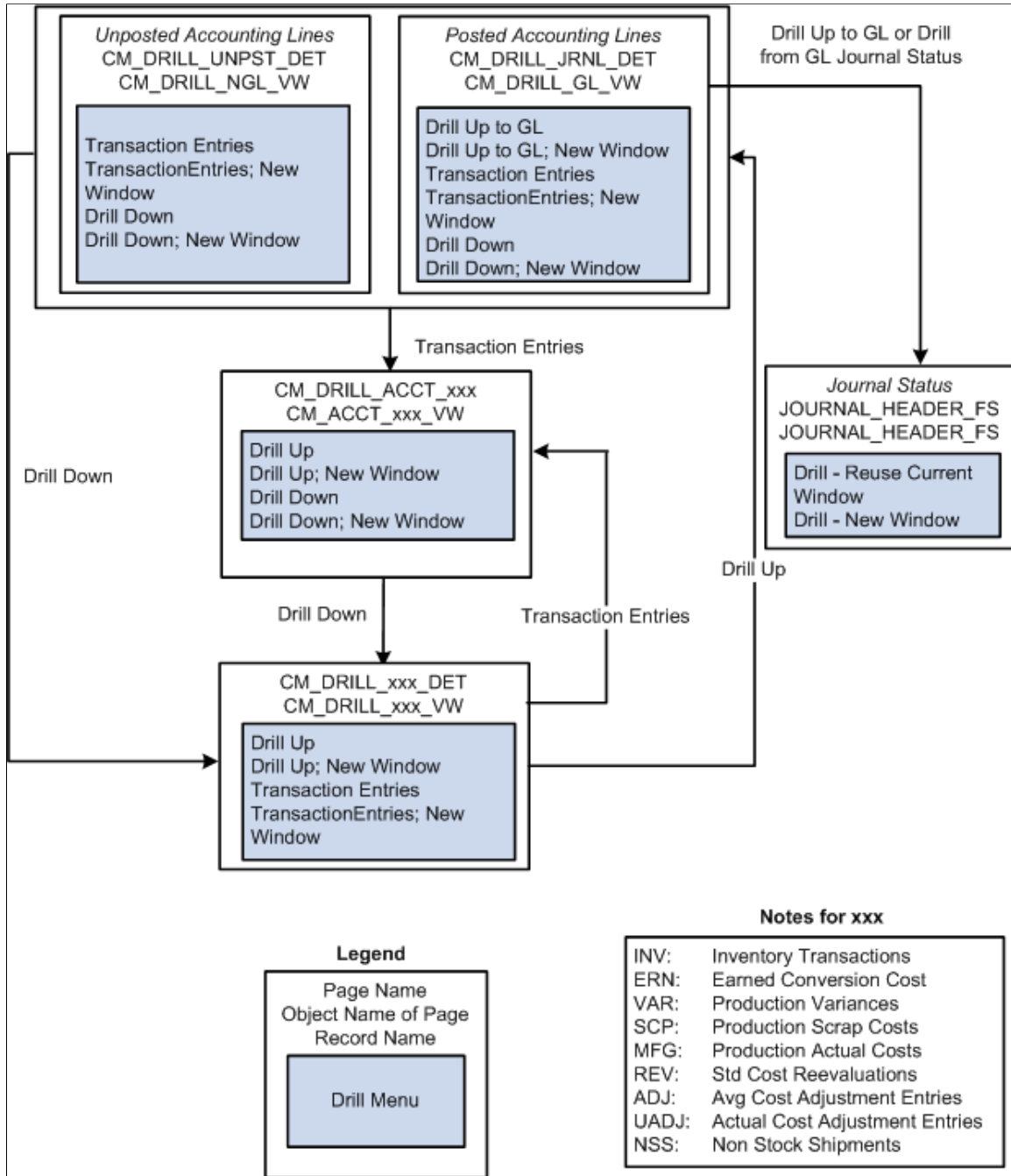

Understanding the Transfer Menu

Transfer menus enable you to navigate between the different inquiry pages. The transfer menus can vary, depending on the inquiry page. To access the transfer menu, click the **View Related Links** button for any account line number. This example illustrates the transfer menu that is available from the Posted Accounting Lines page in PeopleSoft Cost Management.

This example illustrates the fields and controls on the Transfer Menu Example. You can find definitions for the fields and controls later on this page.

Please select one of the following links:

TransactionEntries
TransactionEntries; New Window

Drill Down
Drill Down; New Window

Cancel

The new window option in the transfer menu gives you the ability to have more than one window open at a time, enabling you to analyze several transactions at one time.

Drilling Down from PeopleSoft General Ledger to PeopleSoft Cost Management

The drill-down feature begins at the General Ledger inquiry pages in PeopleSoft General Ledger. Select an entry and click its **View Related Links** button to access a transfer menu. Select a drill option from the menu, and you can navigate to the Posted Accounting Lines page in PeopleSoft Cost Management. After you select a posted accounting line, you can use another transfer menu to access the originating transaction detail page or the transaction accounting entry page. These transaction pages give you the ability to see the transaction details or accounting entries for a selected transaction.

Drilling Up from PeopleSoft Cost Management to PeopleSoft General Ledger

When you want to trace an originating entry up to the general ledger, you can drill up. You begin by viewing the transaction detail or transaction accounting entries in PeopleSoft Cost Management. Then select the transaction and click the **View Related Links** button to access a transfer menu. Select Drill Up from the menu to drill up to the Posted Accounting Lines page (if the transaction is processed by the Journal Generator process) or to the Unposted Accounting Lines page (if it is not yet processed by the Journal Generator process). From the Posted Accounting Lines page in PeopleSoft Cost Management, you can drill up to journal entries by using a transfer menu. You cannot drill up to the journal entries from the Unposted Accounting Lines page because the journal entries do not yet exist for those accounting lines.

Drilling Between the Transaction Details and Transaction Accounting Entries

When you are interested in viewing the transaction detail and transaction accounting entries only within PeopleSoft Cost Management, you can drill between the different types of information. To go from the transaction details to the transaction accounting entries, you select Transaction Entries from the transfer menu. To go from the transaction accounting entries to the transaction details, you select Drill Down from the transfer menu.

Understanding Inventory Transactions

Inventory transactions are any material movement transactions that have a financial affect on inventory balances, such as purchase receipts, adjustments, and issues. Inventory transactions include route to production kits transactions. Route to production kits transactions occur when an assembly item is completed on a production ID or schedule, and it can be routed to another production ID, where it is used as a component on the next-higher-level assembly. The component's issue method must be set to *Kit* in

order for you to route directly to production. This inventory transaction information is derived from the transaction history records (TRANSACTION_INV and TRANS_INV_CM). Transactions that can be viewed on the Inventory Transactions inquiry pages are these transaction groups:

<i>Transaction Group</i>	<i>Description</i>
010	Receipt to Inspection.
012	Return to Vendor.
013	Return to Vendor from Inspection.
020	Putaway.
021	Receipts from Production.
022	IBU Transfer Receipts.
024	Customer Returns.
025	InterCompany Receipts.
026	Expensed Issue Return.
030	Usages & Shipments.
031	InterBU Transfer Shipments.
032	Non Stock Shipments.
034	Ship on Behalf of Other BU.
035	InterCompany Transfers.
036	InterUnit Expensed Issue.
037	VMI Interunit shipment
038	VMI Consumption
040	Physical Count Adjustments.
041	Cycle Count Adjustments.

<i>Transaction Group</i>	<i>Description</i>
042	IBU Transfer Adjustments.
050	User Adjustments.
051	Inventory Scrap.
052	Shipping Adjustment.
053	Floor Stock Issues/Ret.
054	Inventory Scrap for RTV.
060	Bin-To-Bin Transfers.
220	Component Kit
221	Route To Production Kit
222	Waste Completion.
223	Component/Output Transfers.
230	Component Consumption.
231	WM Usage (Maintenance Management Usage).
300	Gain/Loss on Trans Price.
301	InterCompany Cost of Goods.
302	ShipOnBehalf Gain/Loss.
400	Std Cost Variance Receipts.
402	Std Cost Exchange Rate Var.
461	PO Voucher Variance.

Understanding Earned Conversion Cost Transactions

Earned conversion costs account for all earned labor, machine, subcontracting, and overhead costs. The information that is on the Earned Conversion Costs inquiry pages is derived from the Earned Conversion Cost record (SF_EARNCONCOST). The transactions that create entries in this table are:

<i>Transaction Group</i>	<i>Description</i>
240	Earned Labor
211	WIP Revalue (Conv Costs)

Understanding Production Variance Transactions

Production variance transactions represent material variances and conversion variances that are incurred on a production ID or schedule when production is closed for accounting. The information is derived from the Production Variance record (SF_VARIANCES). The Production Variances inquiry pages use these variances:

<i>Transaction Group</i>	<i>Description</i>	<i>Comprised of Variance Type</i>	<i>Description</i>
261	Material Variances.	01	Configuration Variance.
		02	Usage Variance.
		03	Component Yield Variance.
		08	Material Lot Size Variance.
262	Conversion Variances.	04	Labor Lot Size Variance.
		05	Routing Process Variance.
263	Rework Expense.	09	Material Rework Expense.
		10	Labor Rework Expense.
264	Outside Processing PPV.	11– For standard cost makeable items, this transaction group records the variance between the standard cost and the purchase order price of the subcontracted service.	Outside Processing PPV.

Transaction Group	Description	Comprised of Variance Type	Description
265	Teardown Variance.	13	Teardown Material Expense.
		14	Teardown Conversion Expense.
407	Subcontract Standard Cost PPV2		For subcontracted purchases using standard costing, this is the purchase price variance that records the price difference between the purchase order and the voucher.
408	Subcontract Standard Cost PPV2 ERV		For subcontracted purchases using standard costing, this is the purchase price variance that records the exchange rate difference between the purchase order and the voucher.
415	RTV Variances.	Records the difference between the inventory value of goods being returned and the amount of the supplier refund recorded in accounts payable.	Return to Vendor Variance.
601	Wt Avg Upd Production Var.		Weighted Average Update Production Variance.
661	Actual Cost Variances.	For actual cost makeable items, this transaction group records the variance between the actual cost of the components and the standard cost of the end items.	Production Actual Cost Writeoff.
664	Subcontracted Cost.	For actual cost makeable items, this transaction group records the variance between the purchase order price and the voucher price of the subcontracted service for actual cost components.	Subcontracted Cost

Understanding Production Scrap Cost Transactions

Production scrap cost transactions account for the cost of assemblies that are scrapped in process while recording operation and assembly completions. The information that appears on the Production Scrap Costs inquiry pages is derived from the Assembly Scrap Cost record (SF_SCRAPCOST). The transaction groups that are used to record scrap are:

<i>Transaction Group</i>	<i>Description</i>
212	WIP Revaluation (Scrap)
250	Assembly Scrap

Understanding Production Actual Cost Transactions

Production actual cost transactions account for the actual cost of production when the make item uses an actual or average cost method. Actual production costs include the actual cost of materials, conversion costs, conversion overhead costs, subcontracted components, and additional costs. The information that appears on the Production Actual Costs inquiry pages is derived from the CE_ACTUAL_COST record. These transaction groups are used:

<i>Transaction Group</i>	<i>Description</i>
622	Actual Waste Cost
630	Overhead
640	Actual Labor Costs
645	Actual Machine Costs
651	Production Cost Writeoff
661	Actual Cost Variances
664	Subcontracted Cost

Understanding Standard Cost Revaluation Transactions

Standard cost revaluation transactions occur when you change standard costs and update the production cost record with the new version of costs. At that time, the system:

- Calculates the change in inventory value by determining the change in cost and multiplying that difference by the quantity on hand in inspection, stores, and WIP locations.

- Determines the change in WIP inventory by calculating the change in cost of components that are remaining in process, as well as the associated labor, machine, subcontracting, and overhead costs that are earned to that point.

The WIP revaluation information that appears in the Standard Cost Revaluations inquiry pages is associated with the revaluation of the components that are issued to the production ID or schedule as well as the revaluation of the assembly item itself. Detail information is derived from the Posted Item Cost Variance record (CE_ITEMCVAR_PST). The transaction groups are:

Transaction Group	Description
200	Inventory Revalue.
201	Inventory Reval-Inspection.
210	WIP Revalue (Comps, Assys).

Understanding Average Cost Adjustment Transactions

Average cost value adjustment transactions occur when adjusting the cost of the perpetual weighted average cost or the retroactive perpetual weighted average cost items and the resulting change in inventory value. Value adjustments for items using perpetual weighted average costing or retroactive perpetual weighted average costing can be:

- Manually created using the Adjust Average Cost page or the Adjust Retro Costs page.
- System created by the Transaction Costing subprocess within the Cost Accounting Creation process.

The information that appears in the Average Cost Adjustment inquiry pages is derived from the CM_COST_ADJ record. The transaction groups are:

Transaction Group	Description
205	Value Adjustment.
401	Wt Avg Updates from AP.
403	Wt Avg Cost Updates - ERV.
405	Wt Avg Update Writeoffs.

Understanding Actual Cost Adjustment Transactions

Actual cost value adjustment transactions occur when adjusting the cost of the actual cost items and the resulting change in inventory value. Actual cost items are adjusted using the Adjust Actual Cost component. The information that appears in the Actual Cost Adjustment inquiry pages is derived from the CM_USER_CST_ADJ record. The transaction group is:

<i>Transaction Group</i>	<i>Description</i>
206	Value Adjust/ActCost Items.

Understanding Non-stock Shipment Transactions

Non-stock shipment transactions occur when you specify a non-stocked item on a sales order in PeopleSoft Order Management and mark it for PeopleSoft Billing. The information on the Non Stock Shipment inquiry pages is derived from the Non-Stock Shipments record (CM_CST_NSSHIP). The transaction group is:

<i>Transaction Group</i>	<i>Description</i>
032	Non Stock Shipments.

Generating Reports of Financial Transactions

PeopleSoft Cost Management includes these reports to assist with the accounting and PeopleSoft Cost Management review:

- Accounting Register (INS7050).
- Inventory Value (INS7000).
- Transaction Register (INS7100).
- Item Cost Profiles (CMS2000).
- Items with Overridden Profiles (CMS2001).
- Items with no Profiles (CMS2002).
- Inventory On Hand Value (CMS2010).
- WIP Value History (CMS2018).
- Movement by Receipt Line (CMS2015).
- Movement by Depletion Line (CMS2016).
- On Hand Balance Validation (CMS9010).

Pages Used to Report on Financial Transactions

<i>Page Name</i>	<i>Definition Name</i>	<i>Usage</i>
Floor and Ceiling Values Page	CM_VALUE_REF	To establish floor and ceiling values, use the Floor and Ceiling Values (CM_VALUE_REF_PGRP) component. These values are used when you run the Inventory On Hand Value report (CMS2010).
On Hand Value Report Page	RUN_CMS2010A RUN_CMS2010 RUN_CMS2011	Lists on-hand quantity and value at the summary or detail level. The report can also store snapshots of previously generated report data for historical reporting.
On Hand Value Report-Selection Criteria Page	RUN_CMS2010	Enter the data selection criteria for the on-hand value report.
On Hand Value Report-Other Criteria Page	RUN_CMS2011	Define additional criteria for the on-hand value report.

Related Links

"Defining Cross-Application User Preferences" (Application Fundamentals)

Using the On Hand Value Report

Use this component to run the On Hand Value report, which shows on-hand quantity and value at the summary or detail level. This report can be used for items with cost profiles having any cost method. This report displays transactions that have been costed and posted to accounting lines as well as transactions that are posted to the general ledger.

The report can also store snapshots of previously generated report data for historical reporting. In addition, you can also use it to compare the on-hand value by using floor and ceiling costs or last price used.

Select Report Options

Use the On Hand Value Report page (RUN_CMS2010A) to lists on-hand quantity and value at the summary or detail level.

The report can also store snapshots of previously generated report data for historical reporting.

Navigation:

Cost Accounting > Inventory and Mfg Accounting > Reports > Inventory Value History

Field or Control	Description
Print, Don't Store Snapshot	Print the report that is to be generated, but do not store a snapshot of the report data for subsequent reprinting.
Print, Store Snapshot	Print the report that is to be generated, and store a snapshot of the report data for subsequent reprinting.
Don't Print, Store Snapshot	Generate the report and store a snapshot of the data, but do not print a report.
Print Stored Snapshot	Reprint a previously stored snapshot of the report.
Purge Stored Snapshot	Delete a previously stored snapshot of the report.

To print or purge a previously stored snapshot, select a process instance by number, business unit, or as of date.

Enter Selection Criteria

Use the On Hand Value Report-Selection Criteria page (RUN_CMS2010) to enter the data selection criteria for the on-hand value report.

Navigation:

Cost Accounting > Inventory and Mfg Accounting > Reports > Inventory Value History > Selection Criteria

On the Selection Criteria tab: Select a Currency Code. Select a specific cost book to report on, or select *All* to include all of the books in the business unit. Select *All*, *None*, or a specific single cost profile group that is associated with the cost book. *None* applies to all items that have no association with a cost profile group. Select *All* or a specific cost profile that is associated with the book.

Also on the **Selection Criteria** tab: Select either *All* or *Range* (for a range of items). For an item range, enter the from item ID and the to item ID. Select an item group and an item family.

Complete the Selections on the Other Criteria tab

Use the On Hand Value Report-Other Criteria page (RUN_CMS2011) to define additional criteria for the on-hand value report.

Navigation:

Cost Accounting > Inventory and Mfg Accounting > Reports > Inventory Value History > Other Criteria

- *Consigned Inventory Only*: Include only consigned items.
- *Exclude Consigned Inventory*: Include only owned items.

- *Include Consigned Inventory:* Include both owned and consigned items.

If its included, consigned inventory appears at the bottom of the items for each book.

- The Sort option enables you to sort the On Hand Value report by several different methods.
- Enter a storage area to limit the report to a specific storage area that is within the business unit.
- Select the **Include zero On Hand Qty Items** check box to include items with no quantity in the report.
- Select the as of date for which you are requesting the on-hand value. Select a system date or choose an accounting period.
- Cost comparison: These options are only available for detail reports.

The choices are:

- None
No cost comparison.
- Floor and Ceiling
Compare floor and ceiling costs with the unit cost. You maintain floor and ceiling costs in the Floor and Ceiling Values page.
- Last Price Used
Compare the last price used on a voucher or purchase order with the unit cost.
- Report Type - Select Summary, or select Detail. The summary report shows totals by business unit, book, and item. Select to report by either Cost Category or Cost Element.

Additional Information for the Costing Structure

Using Transaction Groups

Each transaction with a financial impact is embedded with a transaction group. The transaction group identifies the type of transaction that is entered and determines what records are populated, how costing is calculated, and what ChartFields are used to record accounting entries. In this section, we identify all the transaction groups by code, description, transaction process description, and specific menu paths. We divide the transaction groups into their logical categories, including:

- Inventory transactions.
- Earned conversion cost transactions.
- Production variance transactions.
- Production scrap cost transactions.
- Production actual cost transactions.
- Standard cost revaluation transactions.
- Average cost adjustment transactions.
- Actual cost adjustment transactions.
- Non-stock shipment transactions.

Understanding Inventory Transactions

Inventory transactions are any material movement transactions that have a financial affect on inventory balances, such as purchase receipts, adjustments, and issues. Inventory transactions include route to production kit transactions. Route to Production kit transactions are the transactions that occur when an assembly item is completed on a production ID or schedule, and it can be routed to another production ID, where it is used as a component on the next-higher-level assembly. The component's issue method must be set to kit in order for you to route directly to production.

This information is derived from the transaction history records (TRANSACTION_INV and TRANS_INV_CM). Inventory transactions include these transaction groups:

Transaction Group	Description	Transaction Process	Menu Path
010	Receipt to Inspection.	Put away an item that is received from a purchase order that requires inspection.	Inventory, Putaway Stock, Complete Putaway
012	Return to Vendor.	Inventory that is returned from a storage location. The express issue request type must be marked as supplier returns.	Inventory, Fulfill Stock Orders, Shipping, Deplete On Hand Quantity
013	Return to Vendor from Inspection.	Inventory returned from an inspection location. The express issue request type must be marked as supplier returns.	Inventory, Fulfill Stock Orders, Shipping, Deplete On Hand Quantity
020	Putaway.	Put away an item that is received from a purchase order, one that doesn't require inspection.	<ul style="list-style-type: none"> • Inventory, Putaway Stock, Complete Putaway • Inventory, Putaway Stock, Express Putaway
021	Receipts from Production.	Put away an assembly completion that is routed to a storage area or another WIP location.	<ul style="list-style-type: none"> • Inventory, Putaway Stock, Complete Putaway • Production Control, Process Production, Complete Production, Record Completions and Scrap (if Putaway Action is set to Putaway at Receipt Save Time)
022	IBU Transfer Receipts.	<p>Receive an item that is shipped to the inventory business unit from another inventory business unit.</p> <p>In addition to the TRANSACTION_INV table, the IN_DEMAND_TPRC table stores the transfer price by cost elements.</p>	Inventory, Putaway Stock, InterUnit and RMA Receiving
024	Customer Returns.	Receive an item from a customer and it specifies RMA receipt.	Inventory, Putaway Stock, InterUnit and RMA Receiving

Transaction Group	Description	Transaction Process	Menu Path
025	InterCompany Receipts.	<p>Receive material from an inventory business unit that is associated with another general ledger, where intercompany processing is indicated.</p> <p>In addition to the TRANSACTION_INV table, the IN_DEMAND_TPRC table stores the transfer price by cost elements.</p>	Inventory, Putaway Stock, InterUnit and RMA Receiving
026	Expensed Issue Return.	<p>Receive material returned from an interunit expensed issue using the IN_DEMAND_TPRC table.</p>	Inventory, Putaway Stock, Expense Issue Return
030	Usages & Shipments.	<p>Issuing material to fulfill a sales order, express issue, or material stock request.</p>	Inventory, Fulfill Stock Orders, Shipping, Deplete On Hand Quantity
031	InterBU Transfer Shipments.	<p>Issuing material for a shipment to another inventory business unit, which is entered through an express issue or material stock request.</p> <p>In addition to the TRANSACTION_INV table, the IN_DEMAND_TPRC table stores the transfer price by cost elements.</p>	Inventory, Fulfill Stock Orders, Shipping, Deplete On Hand Quantity
034	Shipments on Behalf of Other BU.	<p>Issuing material for a customer shipment based on a Sales Order that is taken in an Order Management Business Unit. The Order Management and Billing units must post to a different General Ledger business unit than is posted by the inventory unit.</p> <p>In addition to the TRANSACTION_INV table, the IN_DEMAND_TPRC table stores the transfer price by cost elements.</p>	Inventory, Fulfill Stock Orders, Shipping, Deplete On Hand Quantity

Transaction Group	Description	Transaction Process	Menu Path
035	InterCompany Transfers.	<p>Transfer material from an inventory business unit that is associated with another general ledger, where intercompany processing is indicated.</p> <p>In addition to the TRANSACTION_INV table, the IN_DEMAND_TPRC table stores the transfer price by cost elements.</p>	Inventory, Fulfill Stock Orders, Shipping, Deplete On Hand Quantity
036	InterUnit Expensed Issue.	<p>Expense material from an inventory business unit to an internal department of an unrelated general ledger business unit.</p> <p>In addition to the TRANSACTION_INV table, the IN_DEMAND_TPRC table stores the cost by cost elements.</p>	Inventory, Fulfill Stock Orders, Shipping, Deplete On Hand Quantity
037	VMI Interunit shipment	Record the shipment of non-consigned goods from an inventory business unit to a VMI business unit by debiting the cost of goods sold account and crediting the inventory account.	Inventory, Fulfill Stock Orders, Shipping, Deplete On Hand Quantity
038	VMI Consumption	Record the consumption of materials in a VMI business unit by debiting the cost of goods sold account and crediting the inventory account.	SCM Integrations, Process Transactions, Inventory, VMI Quantity On Hand
040	Physical Count Adjustments.	Record inventory adjustments from a physical inventory.	Inventory, Inventory Counts, Reconcile Inventory Balances, Update Stock Quantity
041	Cycle Count Adjustments.	Record inventory adjustments from a cycle count.	Inventory, Inventory Counts, Reconcile Inventory Balances, Update Stock Quantity

Transaction Group	Description	Transaction Process	Menu Path
042	IBU Transfer Adjustments.	Receive more or less than the quantity that is shipped by using the Inter Business Unit Shipment. When the interunit receipt is closed, a comparison is made between the shipment quantity and the receipt quantity. Any differences are recorded here. In addition to the TRANSACTION_INV table, the IN_DEMAND_TPRC table stores the transfer price by cost elements.	Inventory, Putaway Stock, InterUnit and RMA Receiving
050	User Adjustments.	Specify a quantity adjustment type of increase or decrease.	Inventory, Manage Inventory, Adjustments
051	Inventory Scrap.	Specify an adjustment type of scrap.	Inventory, Manage Inventory, Adjustments
052	Shipping Adjustment.	Deplete less than the quantity that is picked for a shipment that is entered by using a sales order, an express issue, or material stock request. If the picked quantity differs from the depletion quantity, that difference is accounted for here.	Inventory, Fulfill Stock Orders, Shipping, Deplete On Hand Quantity
053	Floor Stock Issues/Ret.	Specify an adjustment type of Miscellaneous Issue or Miscellaneous Receipt.	Inventory, Manage Inventory, Adjustments
054	Inventory Scrap for RTV.	Specify an adjustment type of scrap RTV.	Inventory, Manage Inventory, Adjustments
060	Bin-to-Bin Transfers.	Transfer inventory from one storage location to another. This can be a direct bin-to-bin transfer, a material release of a production pick plan for components using the issue method, or the result of a replenishment workflow work it action.	<ul style="list-style-type: none"> • Inventory, Manage Inventory, Transfers, EZ Transfers • Production Control, Process Production, Issue Materials, Material Release

Transaction Group	Description	Transaction Process	Menu Path
220	Component Kit.	<p>Transfer of inventory from a storage area directly to a production ID. This is accomplished in material release of a production pick plan for components using the kit issue method or by doing a single issue of a kit component.</p> <p>Dekitting a production ID creates reversing entries, as does a return of a kitted component.</p>	<ul style="list-style-type: none"> • Production Control, Process Production, Issue Materials, Material Release • Production Control, Process Production, Issue Materials, Issue/Return Kit Components • Production Control, Process Production, Issue Materials, De-Kit Components • Production Control, Process Production, Issue Materials, Issue/Return Kit Components
221	Route To Production Kit.	<p>Record completions of an assembly at the last operation and route the completed assembly to another production ID. The assembly must be a component whose issue method is set to kit at the next higher production ID.</p>	<ul style="list-style-type: none"> • Production Control, Process Production, Complete Production, Record Completions and Scrap • Production Control, Process Production, Subcontract Production, Receive Subcontract Assembly • Production Control, Process Production, Complete Production, Process Completions and Scrap
222	Waste Completion.	Record completion of a waste product on a PID or schedule.	Production Control, Process Production, Complete Production, Record Completions and Scrap
223	Component/Output Transfers.	Moving components or outputs from one PID to another as a result of a PID split. You can also move components from one PID to another to reallocate material issues.	Production Control, Process Production, Split Production, Production ID Split

<i>Transaction Group</i>	<i>Description</i>	<i>Transaction Process</i>	<i>Menu Path</i>
230	Component Consumption.	Material is consumed from the WIP location during a completion or scrap transaction. The components issue method must be set to issue or replenish.	<ul style="list-style-type: none"> • Production Control, Process Production, Complete Production, Record Completions and Scrap • Production Control, Process Production, Issue Materials, Edit/Issue Components • Production Control, Process Production, Complete Production, Record Completions and Scrap
231	WM Usage (Maintenance Management Usage)	Issuing material to a work order in PeopleSoft Maintenance Management to maintain or repair an asset. Material returned to inventory from a work order also uses this transaction group.	Inventory, Fulfill Work Orders, Issue to Work Orders
300	Gain/Loss on Transfer Price.	<p>Ship an item to another inventory business unit specifying a transfer price that differs from the items cost.</p> <p>or</p> <p>Receive an Inter Business Unit Shipment for a standard cost item with a transfer price that differs from the item's cost.</p> <p>or</p> <p>Record additional transfer costs in the transfer price.</p> <p>In addition to the TRANSACTION_INV table, the IN_DEMAND_TPRC table stores the transfer price by cost elements.</p> <hr/> <p>Note: This transaction doesn't appear on the Transaction History record, but is calculated as part of the Transaction Costing process when costing IBU shipments and receipts.</p> <hr/>	Inventory, Fulfill Stock Orders, Shipping, Deplete On Hand Quantity

<i>Transaction Group</i>	<i>Description</i>	<i>Transaction Process</i>	<i>Menu Path</i>
301	InterCompany Cost of Goods.	<p>Issuing material to an inventory business unit that is associated with another general ledger, where intercompany processing is indicated.</p> <p>In addition to the TRANSACTION_INV table, the IN_DEMAND_TPRC table stores the transfer price by cost elements.</p> <hr/> <p>Note: This transaction doesn't appear on the Transaction History record, but is calculated as part of the Transaction Costing process when costing InterCompany shipments (transaction group 035).</p>	Inventory, Fulfill Stock Orders, Shipping, Deplete On Hand Quantity
302	ShipOnBehalf Gain/Loss	<p>Issuing material for a customer shipment based on a Sales Order that is taken in an Order Management Business Unit. The Order Management and Billing units must post to a different General Ledger business unit than is posted by the inventory unit. Gain or loss is recorded when the transfer price differs from the item cost or additional transfer costs are applied.</p> <p>In addition to the TRANSACTION_INV table, the IN_DEMAND_TPRC table stores the transfer price by cost elements.</p>	Inventory, Fulfill Stock Orders, Shipping, Deplete On Hand Quantity

Transaction Group	Description	Transaction Process	Menu Path
400	Std Cost Variance Receipts.	<p>Receive a standard cost item from a purchase order into inspection or stock. If the purchase order price differs from the standard cost of the item, a PPV entry is calculated.</p> <hr/> <p>Note: This transaction doesn't appear on the Transaction History record, but is calculated as part of the Transaction Costing process when costing purchase receipts to inspection or stock.</p> <hr/> <p>Or</p>	Cost Accounting, Inventory and Mfg Accounting, Create Accounting Entries, Cost Accounting Creation
		<p>Receive an actual cost item from a purchase order into inspection or stock. Later, if the purchase order price differs from the voucher price record the difference in an expense account rather than update the inventory receipt and depletion transactions. This option is only valid if you have selected the Writeoff PPV and ERV check box on the Cost Profile page.</p> <hr/> <p>Or</p>	
		<p>For standard cost items, voucher an invoice in Accounts Payable, match, post and run the Landed Cost Extract process. If the invoice price differs from the purchase order price, a PPV entry is posted.</p> <hr/> <p>Note: This transaction doesn't appear on the Transaction History record, but is calculated as part of the Vouchering and Matching process.</p> <hr/>	<ul style="list-style-type: none"> • Accounts Payable, Batch Processes, Vouchers, Matching • Accounts Payable, Batch Processes, Vouchers, Voucher Posting • Accounts Payable, Batch Processes, Extracts and Loads, Extract Landed Cost

<i>Transaction Group</i>	<i>Description</i>	<i>Transaction Process</i>	<i>Menu Path</i>
402	Std Cost Exchange Rate Var.	<p>Accounts for any differences between the exchange rate that is specified on a purchase order and the exchange rate that is used during the Vouchering process.</p> <hr/> <p>Note: This transaction doesn't appear on the Transaction History record, but is calculated as part of the Vouchering and Matching process.</p>	<ul style="list-style-type: none"> Accounts Payable, Batch Processes, Vouchers, Matching Accounts Payable, Batch Processes, Vouchers, Voucher Posting Accounts Payable, Batch Processes, Extracts and Loads, Extract Landed Cost
407	Subcontract Standard Cost PPV2	For subcontracted purchases using standard costing, this is the purchase price variance that records the price difference between the purchase order and the voucher.	Cost Accounting, Inventory and Mfg Accounting, Create Accounting Entries, Cost Accounting Creation
408	Subcontract Standard Cost PPV2 ERV	For subcontracted purchases using standard costing, this is the purchase price variance that records the exchange rate difference between the purchase order and the voucher.	Cost Accounting, Inventory and Mfg Accounting, Create Accounting Entries, Cost Accounting Creation
461	PO Voucher Variance	Run the Transaction Costing process to record the difference between a user adjusted cost and the vouchered cost. This variance is recorded for purchased items using standard or actual cost. The variance between the PO price and the user adjusted cost is recorded in transaction group 400 for standard cost items.	Cost Accounting, Inventory and Mfg Accounting, Create Accounting Entries, Cost Accounting Creation

Understanding Earned Conversion Cost Transactions

Earned conversion cost transactions account for the labor, machine, and subcontracting costs that are earned and also the manufacturing overhead that is applied when completing assemblies at an operation or to stock. These transaction groups include:

<i>Transaction Group</i>	<i>Description</i>	<i>Transaction Process</i>	<i>Menu Path</i>
240	Earned Labor.	Recording completions or scrap for an assembly at an operation.	<ul style="list-style-type: none"> • Production Control, Process Production, Complete Production, Record Completions and Scrap • Production Control, Process Production, Subcontract Production, Receive Subcontract Assembly • Production Control, Process Production, Complete Production, Process Completions and Scrap
211	WIP Revalue (Conversion Costs).	Revaluation of WIP inventory. If conversion costs are recorded prior to the standards change, the costs are revalued as part of the WIP revaluation calculation.	Cost Accounting, Item Costs, Update Costs, Cost Update/ Revalue

Understanding Production Variance Transactions

Production variance transactions represent material variances and conversion variances that are incurred on a production ID or schedule when production is closed for accounting. These transaction groups include:

<i>Transaction Group</i>	<i>Description</i>	<i>Transaction Process</i>	<i>Menu Path</i>
261	Material Variances	Material variances incurred on a production ID or schedule when production is closed for accounting.	Cost Accounting, Inventory and Mfg Accounting, Create Accounting Entries, Cost Accounting Creation
262	Conversion Variances	Conversion variances incurred on a production ID or schedule when production is closed for accounting.	Cost Accounting, Inventory and Mfg Accounting, Create Accounting Entries, Cost Accounting Creation
263	Rework Expense	Variance incurred on a production ID when you repair or rework previously completed assemblies.	Cost Accounting, Inventory and Mfg Accounting, Create Accounting Entries, Cost Accounting Creation

Transaction Group	Description	Transaction Process	Menu Path
264	Outside Processing PPV	For standard cost makeable items, this transaction group records the variance between the standard cost and the purchase order price of the subcontracted service.	Cost Accounting, Inventory and Mfg Accounting, Create Accounting Entries, Cost Accounting Creation
265	Teardown Variance	Variance incurred on a production ID when you break an assembly down into its component parts and return the components to inventory.	Cost Accounting, Inventory and Mfg Accounting, Create Accounting Entries, Cost Accounting Creation
415	RTV Variances	Records the difference between the inventory value of goods being returned and the amount of the supplier refund recorded in accounts payable.	Cost Accounting, Inventory and Mfg Accounting, Create Accounting Entries, Cost Accounting Creation
661	Actual Cost Variances	For actual cost makeable items, this transaction group records the variance between the actual cost of the components and the standard cost of the end items.	Cost Accounting, Inventory and Mfg Accounting, Create Accounting Entries, Cost Accounting Creation
664	Subcontract Variance	For actual cost makeable items, this transaction group records the variance between the purchase order price and the voucher price of the subcontracted service for actual cost components.	Cost Accounting, Inventory and Mfg Accounting, Create Accounting Entries, Cost Accounting Creation

Understanding Production Scrap Cost Transactions

Production scrap cost transactions account for the cost of assemblies that scrapped in process while recording operation and assembly completions. The information that appears here is derived from the Assembly Scrap Cost record (SF_SCRAPCOST). The transaction groups that are used to record scrap are:

Transaction Group	Description	Transaction Process	Menu Path
212	WIP Revaluation (Scrap)	Revaluation of WIP inventory. If assembly scrap is recorded prior to the standards change, the scrap costs are revalued as part of the WIP revaluation calculation.	Cost Accounting, Item Costs, Update Standard Costs, Cost Update/Revalue, Update Production

<i>Transaction Group</i>	<i>Description</i>	<i>Transaction Process</i>	<i>Menu Path</i>
250	Assembly Scrap	Recording scrap for an assembly at an operation.	<ul style="list-style-type: none"> • Production Control, Process Production, Complete Production, Record Completions and Scrap • Process Production, Subcontract Production, Receive Subcontract Assembly • Production Control, Process Production, Complete Production, Process Completions and Scrap

Understanding Production Actual Cost Transactions

Production actual cost transactions account for the actual cost of production when the make item uses an actual or average cost method. Actual production costs include the actual cost of materials, conversion costs, conversion overhead costs, subcontracted components, and additional costs. The transaction groups that are used to record production actual costs are:

<i>Transaction Group</i>	<i>Description</i>	<i>Transaction Process</i>	<i>Menu Path</i>
601	Wt Avg Upd Production Var.	<p>Run the Transaction Costing process for a production ID or production schedule that is closed for accounting.</p> <p>If the make (end) item is average costed, then this transaction group accounts for average cost updates due to new cost information on receipts from manufacturing, usually when the estimated manufacturing cost from partial receipts from work in process are updated to a finalized manufacturing cost once the production order or production schedule is complete.</p>	Cost Accounting, Inventory and Mfg Accounting, Created Accounting Entries, Inventory Transaction Costing, Transaction Costing

Transaction Group	Description	Transaction Process	Menu Path
605	Wt Avg Upd Prod Writeoffs.	<p>Run the Transaction Costing process for a production ID or production schedule that is closed for accounting.</p> <p>If the make (end) item is average costed, then this transaction group creates a writeoff when the average cost of the item needs to be updated, due to new cost information on receipts from manufacturing, but there is not enough quantity currently in stock to absorb the updated costs.</p>	Cost Accounting, Inventory and Mfg Accounting, Created Accounting Entries, Inventory Transaction Costing, Transaction Costing
606	Avg Rev Compl Write-off	<p>Run the Transaction Costing process for a production ID or production schedule that is closed for accounting.</p> <p>If the make (end) item uses the perpetual weighted average method, then this transaction group creates a writeoff, when needed, to clear the production costs from WIP.</p>	Cost Accounting, Inventory and Mfg Accounting, Created Accounting Entries, Inventory Transaction Costing, Transaction Costing
622	Actual Waste Cost.	<p>Run the Transaction Costing process for a production ID or production schedule that is closed for accounting.</p> <p>If the make (end) item is actual or average costed and a waste by-product is produced, then this transaction group credits an expense account and debits the finished goods inventory account.</p>	Cost Accounting, Inventory and Mfg Accounting, Created Accounting Entries, Inventory Transaction Costing, Transaction Costing

Transaction Group	Description	Transaction Process	Menu Path
630	Overhead	<p>Run the Transaction Costing process for a production ID or production schedule that has been closed for accounting.</p> <p>If the make (end) item is actual or average costed, then this transaction group debits WIP and credits a manufacturing overhead cost absorption account for overhead costs of the production. These costs are applied using material, labor, and machine amounts as the basis for allocating overhead charges to production outputs.</p>	Cost Accounting, Inventory and Mfg Accounting, Created Accounting Entries, Inventory Transaction Costing, Transaction Costing
640	Actual Labor Costs.	<p>Run the Transaction Costing process for a production ID or production schedule that has been closed for accounting.</p> <p>If the make (end) item is actual or average costed and the operation sequence is complete, then this transaction group credits earned labor account and debits WIP with the actual labor costs.</p>	Cost Accounting, Inventory and Mfg Accounting, Created Accounting Entries, Inventory Transaction Costing, Transaction Costing
645	Actual Machine Costs.	<p>Run the Transaction Costing process for a production ID or production schedule that is closed for accounting.</p> <p>If the make (end) item is actual or average costed and the operation sequence is complete, then this transaction group credits earned machine account and debits WIP with the actual machine costs.</p>	Cost Accounting, Inventory and Mfg Accounting, Created Accounting Entries, Inventory Transaction Costing, Transaction Costing
651	Production Cost Writeoff.	<p>Run the Transaction Costing process for a production ID or production schedule that is closed for accounting.</p> <p>This transaction group is used when there is an overriding adjustment and additional costs hit WIP. This transaction group writes off those WIP costs which do not belong in finished goods.</p>	Cost Accounting, Inventory and Mfg Accounting, Created Accounting Entries, Inventory Transaction Costing, Transaction Costing

<i>Transaction Group</i>	<i>Description</i>	<i>Transaction Process</i>	<i>Menu Path</i>
661	Actual Cost Variances	<p>Run the Transaction Costing process for a production ID or production schedule that is closed for accounting.</p> <p>If the make (end) item is standard costed and one or more of the components uses actual or average cost, then this transaction group relieves WIP for the difference between the actual cost of the component consumption transaction and the standard cost of the component which was used to build up the standard cost of the end item. The offset is posted to a period variances ChartField.</p> <p>Although the inputs to standard cost end items can have standard costs themselves, the input items can still use any cost profile for accounting purposes. As components are depleted, the cost on the depletion becomes part of the actual cost of the output items.</p>	Cost Accounting, Inventory and Mfg Accounting, Created Accounting Entries, Inventory Transaction Costing, Transaction Costing
664	Subcontracted Cost.	<p>Run the Transaction Costing process for a production ID or production schedule that is closed for accounting.</p> <p>This transaction group records the variance between subcontracted costs on the purchase order and the actual subcontracted costs on the voucher. This transaction group is used only for actual or average cost items.</p>	Cost Accounting, Inventory and Mfg Accounting, Created Accounting Entries, Inventory Transaction Costing, Transaction Costing

Understanding Standard Cost Revaluation Transactions

Standard cost revaluation transactions are the transactions that occur when you change standard costs and update the production cost record with the new version of costs. At that time, the system:

- Calculates the change in inventory value by determining the change in cost and multiplying that difference by the quantity on hand in inspection, storage areas, and WIP locations.

- Determines the change in WIP inventory by calculating the change in cost of components remaining in process, as well as the associated labor, machine, subcontracting, and overhead costs that are earned to that point.

The WIP revaluation information that is displayed here is associated with the revaluation of the components issued to the production ID or schedule as well as the revaluation of the assembly item itself. Detail information is derived from the Posted Item Cost Variance record (CE_ITEMCVAR_PST). The transaction groups are:

<i>Transaction Group</i>	<i>Description</i>	<i>Transaction Process</i>	<i>Menu Path</i>
200	Inventory Revalue.	Once production costs are updated, this transaction accounts for the change in inventory value in storage areas or WIP locations.	Cost Accounting, Item Costs, Update Standard Costs, Cost Update/Revalue, Update Production
201	Inventory Reval - Inspection.	Once production costs are updated, this transaction accounts for the change in inventory value in inspection locations.	Cost Accounting, Item Costs, Update Standard Costs, Cost Update/Revalue, Update Production
210	WIP Revalue (Comps, Assy).	Revaluation of WIP. This transaction accounts for the change in component and assembly costs that are still in process.	Cost Accounting, Item Costs, Update Standard Costs, Cost Update/Revalue, Update Production

Understanding Average Cost Adjustment Transactions

Average cost value adjustment transactions occur when adjusting the cost of the perpetual weighted average cost or the retroactive perpetual weighted average cost items and the resulting change in inventory value. Value adjustments for items using perpetual weighted average costing or retroactive perpetual weighted average costing can be:

- Manually created using the Adjust Average Cost page or the Adjust Retro Costs page.
- System created by the Transaction Costing subprocess within the Cost Accounting Creation process.

These transactions are displayed in this table:

<i>Transaction Group</i>	<i>Description</i>	<i>Transaction Process</i>	<i>Menu Path</i>
205	Value Adjustment.	Records an adjustment to change the value of the current inventory stock for a specific item using perpetual average or retroactive perpetual average costing. This transaction group applies only to perpetual average and retroactive perpetual average items.	<ul style="list-style-type: none"> Cost Accounting, Item Costs, Update Costs, Adjust Average Cost Cost Accounting, Item Costs, Update Costs, Adjust Retroactive Averages
401	Wt Avg Updates from AP.	Records an adjustment to update the perpetual weighted average cost with posted purchase price variances (PPV).	Cost Accounting, Inventory and Mfg Accounting, Create Accounting Entries, Inventory Transaction Costing. Select the Apply Perpetual Average Adjs check box.
403	Wt Avg Cost Updates - ERV.	Records an adjustment to update the perpetual weighted average cost with posted exchange rate variances (ERV).	Cost Accounting, Inventory and Mfg Accounting, Create Accounting Entries, Inventory Transaction Costing. Select the Apply Perpetual Average Adjs check box.
405	Wt Avg Update Writeoffs.	Records an adjustment to account for any PPV or ERV not applied into the perpetual weighted average cost.	Cost Accounting, Inventory and Mfg Accounting, Create Accounting Entries, Inventory Transaction Costing. Select the Apply Perpetual Average Adjs check box.

Understanding Actual Cost Adjustment Transactions

Actual cost value adjustment transactions occur when adjusting the cost of the actual cost items and the resulting change in inventory value. Actual cost items are adjusted using the Adjust Actual Cost component. The transaction is:

<i>Transaction Group</i>	<i>Description</i>	<i>Transaction Process</i>	<i>Menu Path</i>
206	Value Adjust/ActCost Items.	Records an adjustment to change the value of the current inventory stock for a specific item using actual costing.	Cost Accounting, Item Costs, Update Costs, Adjust Actual Cost

Understanding Non-stock Shipment Transactions

Non-stock shipment transactions are the transactions that occur when you specify a non-stocked item on a sales order in PeopleSoft Order Management and mark it for billing. The transaction is:

<i>Transaction Group</i>	<i>Description</i>	<i>Transaction Process</i>	<i>Menu Path</i>
032	Non Stock Shipments	Designate a nonshippable item as ready for billing.	Order Management, Quotes and Orders, Create OM Billing Entries, Mark Lines for Billing

Using Costing Flow Diagrams

This diagram illustrates how the Transaction Costing process (within the Cost Accounting Creation process) calculates the cost of each inventory transaction.



The Transaction Costing process:

1. Expands the inventory transactions in TRANSACTION_INV into the PeopleSoft Cost Management CM_TRANSACTION table adding a separate row for each business unit and cost book combination. Interunit transactions are expanded for compound accounting entries and stored in the CM_INTRANSIT record. *Shipment on Behalf of* transactions are stored in the CM_SHIPONBEHALF and CM_SHIPONB_BOOK tables. *Interunit Expensed Issue Returns* are stored in the TRANS_INV_CM table. For interunit transfers, interunit expensed issues, and shipment on behalf of transactions, the IN_DEMAND_TPRC table is used in combination with the TRANSACTION_INV table.

2. Places putaway transactions into CM_RECEIPTS and dummy deplete rows in CM_DEPLETE to complete the join for CM_ONHAND_VW.
3. Inserts all cost adjustments from PeopleSoft Manufacturing production IDs, Payable vouchers, and user-entered cost adjustments. Stores the actual cost value adjustments in the record CM_USER_CST_ADJ where the adjustment then flows into the CM_RECEIPT_COST record to be picked up by the Accounting Line Creation process. Stores the value adjustments for items using perpetual average and retroactive perpetual average costing in the record CM_COST_ADJ, and then expands the adjustment by cost book into the CM_COST_ADJB record. The Accounting Line Creation process picks up the data from the CM_COST_ADJB record.
4. Adds depletion transactions into CM_DEPLETION table.
5. Matches up each depletion transaction in CM_DEPLETION with a qualifying putaway from CM_ONHAND_VW. These depleted depletions are inserted into the CM_DEPLETE table.
6. Calculates the cost of receipts and placed them into CM_RECEIPT_COST, CM_VARIANCES, and CM_VARIANC_COST tables.
7. Calculates the cost of depletions in CM_DEPLETE table and placed them in the CM_DEPLETE_COST table. In addition, it also calculates the gain or loss on interunit transfers and places them in the CM_TRANSVAR and CM_TRANSVAR_COST tables.
8. Calculates the cost of make items produced in PeopleSoft Manufacturing. The end item costs are computed and placed in CE_ACTUAL_COST table.

This diagram illustrates how the Accounting Line Creation process creates the accounting entries for each inventory transaction.

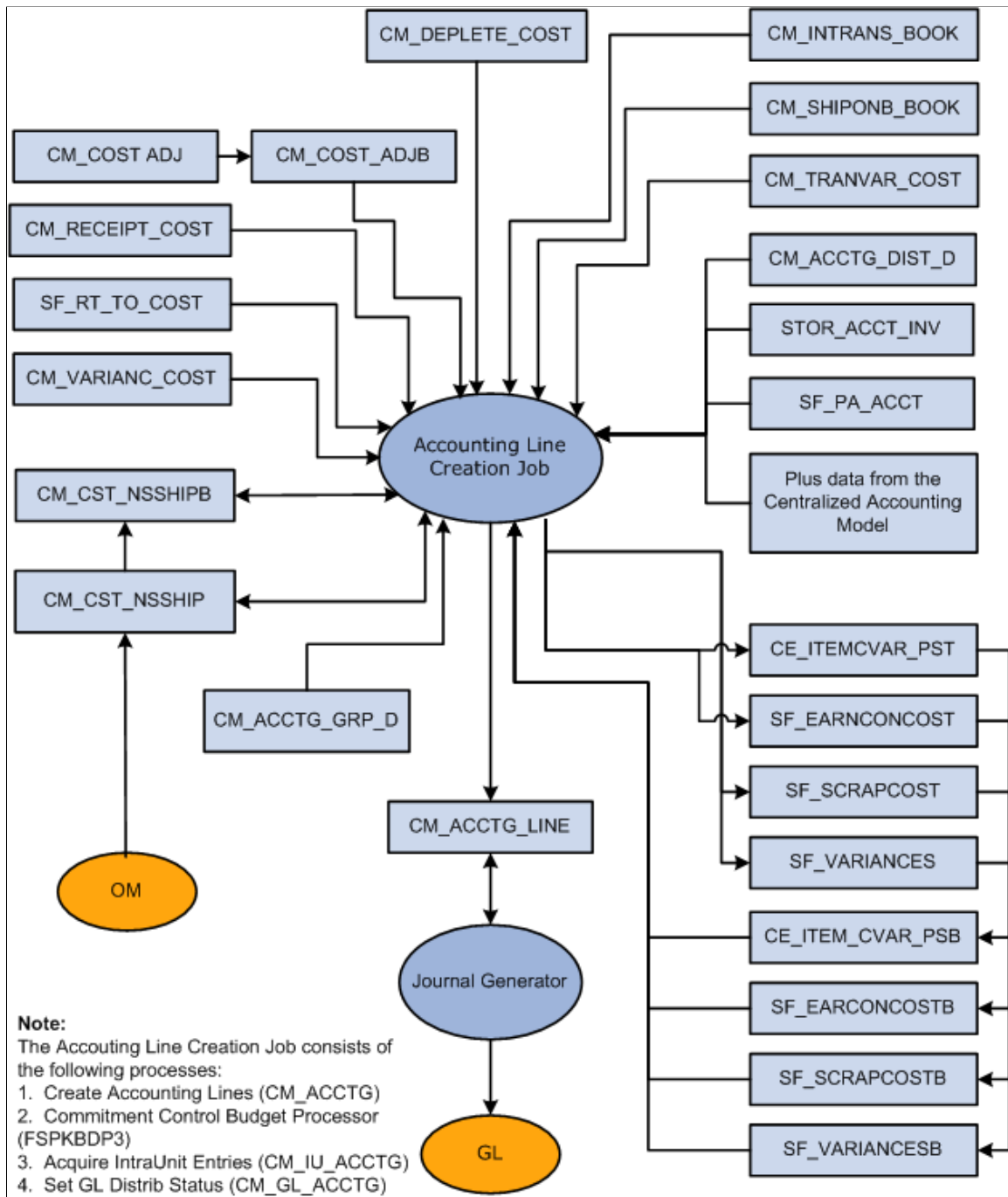

Scenarios for PeopleSoft Cost Management

Understanding Troubleshooting

This topic presents scenarios of how to use some of the features within PeopleSoft Cost Management. These real-life examples describe some of the intended uses of these features; enabling you to understand how these features might be applied to your own organization.

Note: The real-life scenarios described within this documentation may not conform to the business rules and procedures within your organization. These scenarios should not be construed as consulting or implementation advice for your specific industry or your individual organization. The information here should be adapted or even disregarded based on the needs of your organization. PeopleSoft does not guarantee that the information included here will work as intended within your customized environment.

Example: Calculating Transaction Costing Based on the Cost Profile

These examples illustrate how the costing structure operates. Transactions for PeopleSoft Inventory and PeopleSoft Manufacturing are inserted into the PeopleSoft Transaction History (TRANSACTION_INV) table. The Transaction Costing process within the Cost Accounting Creation process uses the transaction data along with the costing structure to determine the cost for each transaction.

These diagrams illustrate how the Transaction Costing process uses the cost profile setup (receipt cost, cost flow, and deplete cost methods) to calculate transactions cost for:

- Lot control items.
- FIFO and LIFO items.
- Average cost items.
- Standard cost items.

Related Links

[Understanding Transaction Costing and Accounting Entry Creation](#)

[Understanding the Accounting Structure](#)

Costing Lot Controlled Items

This example illustrates the records that are used while costing lot controlled items. For this example, this information is used:

Inventory Business Unit	US008
Item ID	A
Cost Book	FIN
From Cost Profile	
Receipt Cost Method (CM_TYPE)	Actual
Cost Flow (CM_FLOW)	Lot ID
Deplete Cost Method (CM_METHOD)	Actual

This diagram illustrates the cost flow for a lot controlled item.

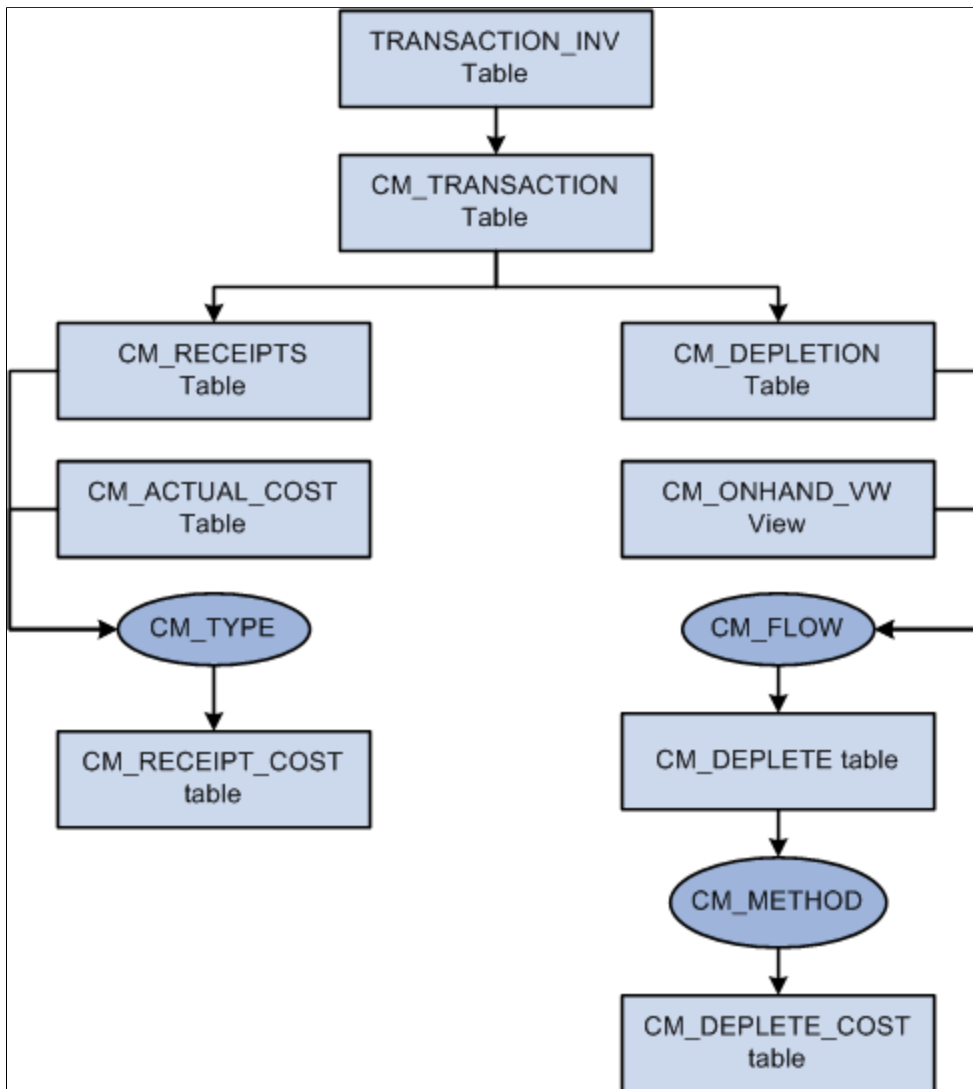

The TRANSACTION_INV Table

Transactions for PeopleSoft Inventory and PeopleSoft Manufacturing are inserted into the PeopleSoft Transaction History (TRANSACTION_INV) table. In this example, there are three transactions stocking item A into the US008 inventory business unit (020 Putaway transactions), and two transactions shipping item A out of the US008 business unit (030– Usage and Shipment transactions).

<i>Business Unit</i>	<i>Item</i>	<i>Date/Time</i>	<i>Transaction</i>	<i>Lot ID</i>	<i>Qty</i>
US008	A	T1	020–Putaway	1	10
US008	A	T3	020–Putaway	2	5
US008	A	T5	030–Usages & Shipments	1	6
US008	A	T7	020–Putaway	3	5
US008	A	T9	030–Usages & Shipments	3	5

The CM_TRANSACTION Table

The Transaction Costing process expands the transactions in TRANSACTION_INV into the PeopleSoft Cost Management CM_TRANSACTION table, adding a separate row for each business unit and cost book combination.

The CM_RECEIPTS Table

The Transaction Costing process places 020– Putaway transactions into CM_RECEIPTS.

<i>Business Unit</i>	<i>Item</i>	<i>Date/Time</i>	<i>Cost Book</i>	<i>Lot ID</i>	<i>Qty</i>
US008	A	T1	FIN	1	10
US008	A	T3	FIN	2	5
US008	A	T7	FIN	3	5

The CM_DEPLETION Table

The Transaction Costing process places 030– Usage & Shipment transactions into CM_DEPLETION.

<i>Business Unit</i>	<i>Item</i>	<i>Date/Time</i>	<i>Cost Book</i>	<i>Lot ID</i>	<i>Qty</i>
US008	A	T5	FIN	1	6
US008	A	T9	FIN	3	5

The CM_ACTUAL_COST Table

Item putaway costs are computed and placed in CM_ACTUAL_COST table.

<i>Business Unit</i>	<i>Item</i>	<i>Date/Time</i>	<i>Cost Element</i>	<i>Unit Cost</i>
US008	A	T1	100	10.00
US008	A	T1	200	1.00
US008	A	T3	100	20.00
US008	A	T3	200	2.00
US008	A	T7	100	25.00
US008	A	T7	200	5.00

The CM_RECEIPT_COST Table

Data from the CM_RECEIPTS table and the CM_ACTUAL_COST table are used to calculate the receipt costs for the CM_RECEIPT_COST table. This is based on the cost type entered for the cost book on the Inventory Definition - Business Unit Books page.

<i>Business Unit</i>	<i>Item</i>	<i>Date/Time</i>	<i>Cost Book</i>	<i>Cost Element</i>	<i>Unit Cost</i>
US008	A	T1	FIN	100	10.00
US008	A	T1	FIN	200	1.00
US008	A	T3	FIN	100	20.00
US008	A	T3	FIN	200	2.00

Business Unit	Item	Date/Time	Cost Book	Cost Element	Unit Cost
US008	A	T7	FIN	100	25.00
US008	A	T7	FIN	200	5.00

The CM_ONHAND_VW Table

The CM_ONHAND_VW table matches receipts (putaways) with depletions (usage and shipments) based on the Cost Flow field on the Cost Profiles page.

Bus Unit	Item	Date/Time	Cost Book	T0 QTY	T2 QTY	T4 QTY	T6 QTY	T8 QTY	T10 QTY
US008	A	T1	FIN	0	10	10	4	4	4
US008	A	T3	FIN	0	0	5	5	5	5
US008	A	T7	FIN	0	0	0	0	5	0

The CM_DEplete Table

The process matches up each depletion transaction in CM_DEPLETION with a qualifying putaway from CM_ONHAND_VW. These depleted depletions are inserted into the CM_DEplete table. The Cost Flow field on the Cost Profiles page determines how receipts are matched with depletions. For lot-controlled items, the cost of the specific lot is used. This offers you a specific method of tracking quantities and costs by lot.

Business Unit	Item	Date/Time	Cost Book	Rec Date/Time	Qty
US008	A	T5	FIN	T1	6
US008	A	T9	FIN	T7	5

The CM_DEplete_COST Table

The process calculates the cost of depletions in the CM_DEplete table and placed them in the CM_DEplete_COST table. This is based on the Deplete Cost Method defined on the Cost Profiles page.

Business Unit	Item	Date/Time	Cost Book	Rec Date/ Time	Cost Element	Unit Cost
US008	A	T5	FIN	T1	100	10.00
US008	A	T5	FIN	T1	200	1.00
US008	A	T9	FIN	T7	100	25.00
US008	A	T9	FIN	T7	200	5.00

Costing FIFO/LIFO Items

This example illustrates costing using the FIFO/LIFO methods. For this example, this information is used:

Inventory Business Unit	US010	US010
Item ID	A	A
Cost Book	FIN	TAX
From Cost Profile		
Receipt Cost Method (CM_TYPE)	Actual	Actual
Cost Flow (CM_FLOW)	FIFO	LIFO
Deplete Cost Method (CM_METHOD)	Actual	Actual

This diagram illustrates the cost flow for a FIFO or LIFO item.

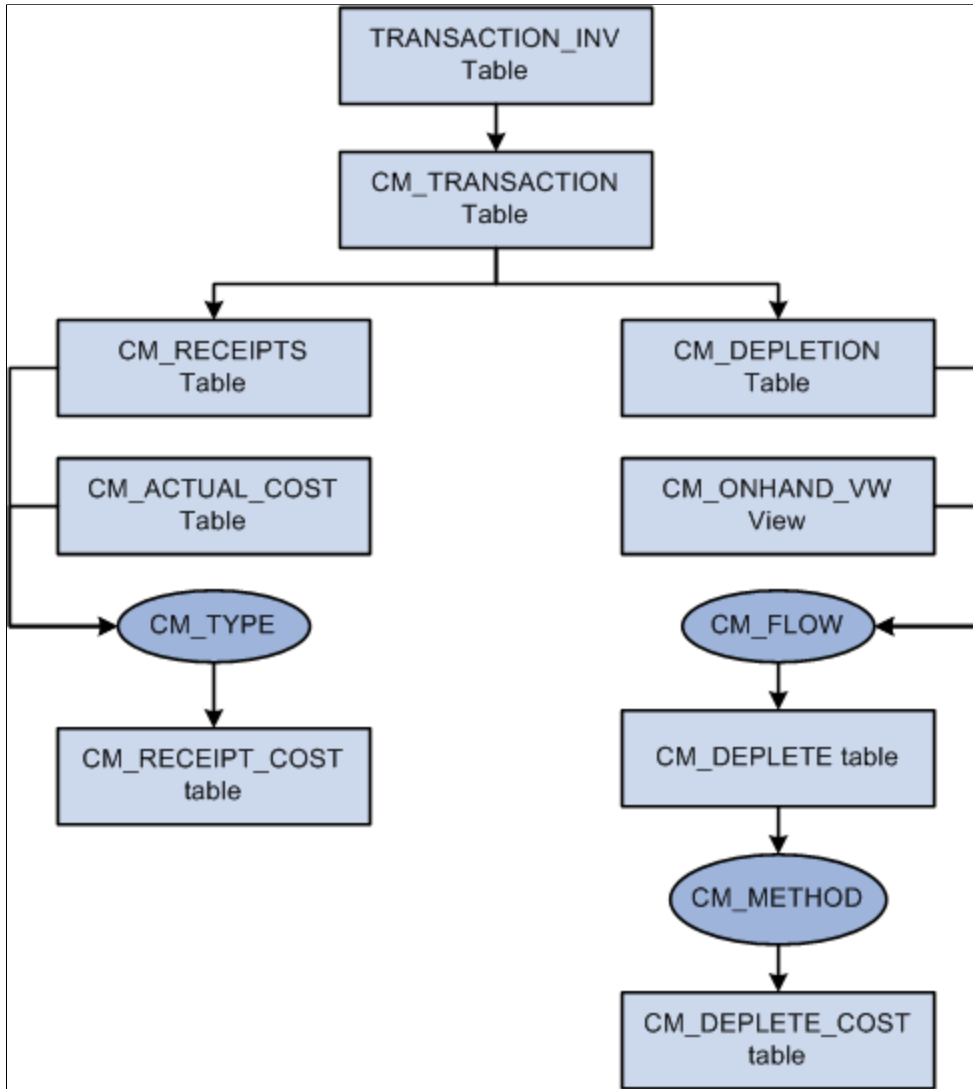

The TRANSACTION_INV Table

Transactions for PeopleSoft Inventory and PeopleSoft Manufacturing are inserted into the PeopleSoft Transaction History (TRANSACTION_INV) table. In this example, there are three transactions stocking item A into the US010 inventory business unit (020 Putaway transactions), and two transactions shipping item A out of the US010 business unit (030– Usage and Shipment transactions).

<i>Business Unit</i>	<i>Item</i>	<i>Date/Time</i>	<i>Transaction</i>	<i>Qty</i>
US010	A	T1	020–Putaway	10
US010	A	T3	020–Putaway	5

<i>Business Unit</i>	<i>Item</i>	<i>Date/Time</i>	<i>Transaction</i>	<i>Qty</i>
US010	A	T5	030–Usages & Shipments	6
US010	A	T7	020–Putaway	5
US010	A	T9	030–Usages & Shipments	5

The CM_TRANSACTION Table

The Transaction Costing process expands the transactions in TRANSACTION_INV into the PeopleSoft Cost Management CM_TRANSACTION table, adding a separate row for each business unit and cost book combination.

The CM_RECEIPTS Table

The Transaction Costing process places 020– Putaway transactions into CM_RECEIPTS.

<i>Business Unit</i>	<i>Item</i>	<i>Date/Time</i>	<i>Cost Book</i>	<i>Qty</i>
US010	A	T1	FIN	10
US010	A	T1	TAX	10
US010	A	T3	FIN	5
US010	A	T3	TAX	5
US010	A	T7	FIN	5
US010	A	T7	TAX	5

The CM_DEPLETION Table

The Transaction Costing process places 030– Usage & Shipment transactions into CM_DEPLETION.

<i>Business Unit</i>	<i>Item</i>	<i>Date/Time</i>	<i>Cost Book</i>	<i>Qty</i>
US010	A	T5	FIN	6

<i>Business Unit</i>	<i>Item</i>	<i>Date/Time</i>	<i>Cost Book</i>	<i>Qty</i>
US010	A	T5	TAX	6
US010	A	T9	FIN	5
US010	A	T9	TAX	5

The CM_ACTUAL_COST Table

Item putaway costs are computed and placed in CM_ACTUAL_COST table.

<i>Business Unit</i>	<i>Item</i>	<i>Date/Time</i>	<i>Cost Element</i>	<i>Unit Cost</i>
US010	A	T1	100	10.00
US010	A	T1	200	1.00
US010	A	T3	100	20.00
US010	A	T3	200	2.00
US010	A	T7	100	25.00
US010	A	T7	200	5.00

The CM_RECEIPT_COST Table

Data from the CM_RECEIPTS table and the CM_ACTUAL_COST table are used to calculate the receipt costs for the CM_RECEIPT_COST table. This is based on the cost type entered for the cost book on the Inventory Definition - Business Unit Books page.

<i>Business Unit</i>	<i>Item</i>	<i>Date/Time</i>	<i>Cost Book</i>	<i>Cost Element</i>	<i>Unit Cost</i>
US010	A	T1	FIN	100	10.00
US010	A	T1	FIN	200	1.00
US010	A	T1	TAX	100	10.00

Business Unit	Item	Date/Time	Cost Book	Cost Element	Unit Cost
US010	A	T1	TAX	200	1.00
US010	A	T3	FIN	100	20.00
US010	A	T3	FIN	200	2.00
US010	A	T3	TAX	100	20.00
US010	A	T3	TAX	200	2.00
US010	A	T7	FIN	100	25.00
US010	A	T7	FIN	200	5.00
US010	A	T7	TAX	100	25.00
US010	A	T7	TAX	200	5.00

The CM_ONHAND_VW Table

The CM_ONHAND_VW table matches receipts (putaways) with depletions (usage and shipments) based on the Cost Flow field on the Cost Profiles page.

Bus Unit	Item	Date/Time	Cost Book	T0 QTY	T2 QTY	T4 QTY	T6 QTY	T8 QTY	T10 QTY
US010	A	T1	FIN	0	10	10	4	4	0
US010	A	T1	TAX	0	10	10	9	9	9
US010	A	T3	FIN	0	0	5	5	5	4
US010	A	T3	TAX	0	0	5	0	0	0
US010	A	T7	FIN	0	0	0	0	5	5
US010	A	T7	TAX	0	0	0	0	5	0

The CM_DEplete Table

The process matches up each depletion transaction in CM_DEPLETION with a qualifying putaway from CM_ONHAND_VW. These depleted depletions are inserted into the CM_DEplete table. The Cost Flow field on the Cost Profiles page determines how receipts are matched with depletions.

<i>Business Unit</i>	<i>Item</i>	<i>Date/Time</i>	<i>Cost Book</i>	<i>Rec Date/Time</i>	<i>Qty</i>
US010	A	T5	FIN	T1	6
US010	A	T5	TAX	T3	5
US010	A	T5	TAX	T1	1
US010	A	T9	FIN	T1	4
US010	A	T9	FIN	T3	1
US010	A	T9	TAX	T7	5

The CM_DEplete_COST Table

The process calculates the cost of depletions in the CM_DEplete table and placed them in the CM_DEplete_COST table. This is based on the Deplete Cost Method defined on the Cost Profiles page.

<i>Business Unit</i>	<i>Item</i>	<i>Date/Time</i>	<i>Cost Book</i>	<i>Rec Date/Time</i>	<i>Cost Element</i>	<i>Unit Cost</i>
US010	A	T5	FIN	T1	100	10.00
US010	A	T5	FIN	T1	200	1.00
US010	A	T5	TAX	T3	100	20.00
US010	A	T5	TAX	T3	200	2.00
US010	A	T5	TAX	T1	100	10.00
US010	A	T5	TAX	T1	200	1.00
US010	A	T9	FIN	T1	100	10.00

<i>Business Unit</i>	<i>Item</i>	<i>Date/Time</i>	<i>Cost Book</i>	<i>Rec Date/ Time</i>	<i>Cost Element</i>	<i>Unit Cost</i>
US010	A	T9	FIN	T1	200	1.00
US010	A	T9	FIN	T3	100	20.00
US010	A	T9	FIN	T3	200	2.00
US010	A	T9	TAX	T7	100	25.00
US010	A	T9	TAX	T7	200	5.00

Costing Average Cost Items

This example details the perpetual and periodic average cost methods that are used in PeopleSoft Cost Management. For this example, this information is used:

<i>Inventory Business Unit</i>	<i>US011</i>	<i>US011</i>
Item ID	A	A
Cost Book	FIN	TAX
From Cost Profile		
Receipt Cost Method (CM_TYPE)	Actual	Actual
Cost Flow (CM_FLOW)	FIFO	FIFO
Deplete Cost Method (CM_METHOD)	Perpetual Average	Periodic Average
Cost Element Option	Production	N/A

For the TAX cost book, assume that the average is calculated only once, at the end of the period (periodic).

For the FIN cost book, assume that the average is calculated after each putaway.

Perpetual Average Is Calculated:

<i>Date/Time</i>	<i>Cost Element</i>	<i>Existing Onhand Stock</i>	<i>Shipments</i>	<i>Actual Cost of New Receipt</i>	<i>New Average Cost per Unit</i>
T1	100	None		10 units @ 10/unit	10.00/unit
T1	200	None		10 units @ 1/unit	1.00/unit
T3	100	10 units @ 10/unit		5 units @ 20/unit	13.33/unit
T3	200	10 units @ 1/unit		5 units @ 2/unit	1.33/unit
T5	100		6 units shipped		
T5	200		6 units shipped		
T7	100	9 units @ 13.3/unit		5 units @ 25/unit	17.50/unit
T7	200	9 units @ 1.33/unit		5 units @ 5/unit	2.64/unit

Periodic Average is Calculated:

<i>Date/Time</i>	<i>Cost Element</i>	<i>Actual Cost of New Receipt</i>	<i>Total Average Cost</i>	<i>Avg Cost/Unit to Cost all Shipments within Period</i>
T1	100	10 units @ 10/unit	100.00	
T1	200	10 units @ 1/unit	10.00	
T3	100	5 units @ 20/unit	100.00	
T3	200	5 units @ 2/unit	10.00	
T5	100	5 units @ 25/unit	125.00	
T5	200	5 units @ 5/unit	25.00	

<i>Date/Time</i>	<i>Cost Element</i>	<i>Actual Cost of New Receipt</i>	<i>Total Average Cost</i>	<i>Avg Cost/Unit to Cost all Shipments within Period</i>
Totals		20 units	325.00 for cost element 100 45.00 for cost element 200	16.25/unit for cost element 100 2.25/unit for cost element 200

This diagram illustrates the cost flow for a perpetual and periodic average cost item.

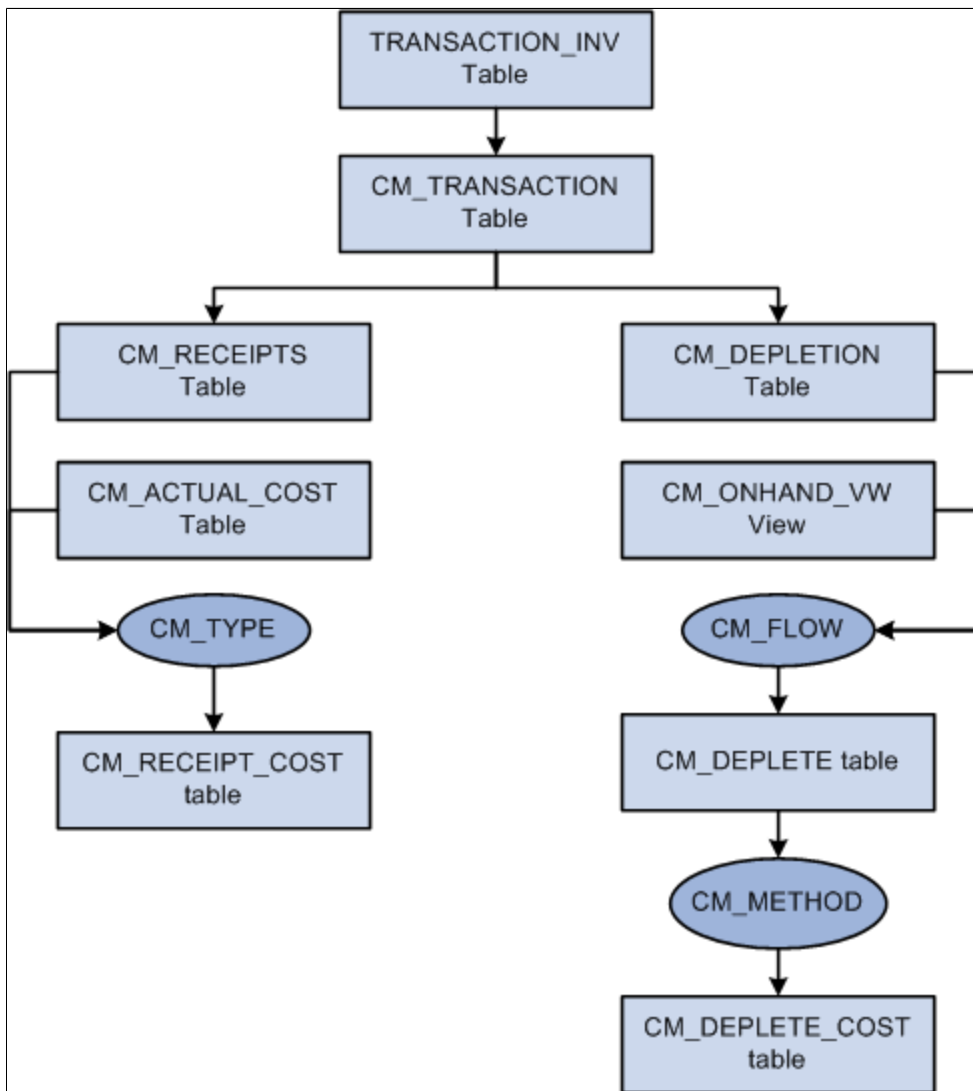

The TRANSACTION_INV Table

Transactions for PeopleSoft Inventory and PeopleSoft Manufacturing are inserted into the PeopleSoft Transaction History (TRANSACTION_INV) table. In this example, there are three transactions stocking item A into the US011 inventory business unit (020 Putaway transactions), and two transactions shipping item A out of the US011 business unit (030– Usage and Shipment transactions).

<i>Business Unit</i>	<i>Item</i>	<i>Date/Time</i>	<i>Transaction</i>	<i>Qty</i>
US011	A	T1	020–Putaway	10
US011	A	T3	020–Putaway	5
US011	A	T5	030–Usages & Shipments	6
US011	A	T7	020–Putaway	5
US011	A	T9	030–Usages & Shipments	5

The CM_TRANSACTION Table

The Transaction Costing process expands the transactions in TRANSACTION_INV into the PeopleSoft Cost Management CM_TRANSACTION table, adding a separate row for each business unit and cost book combination.

The CM_RECEIPTS Table

The Transaction Costing process places 020– Putaway transactions into CM_RECEIPTS.

<i>Business Unit</i>	<i>Item</i>	<i>Date/Time</i>	<i>Cost Book</i>	<i>Qty</i>
US011	A	T1	FIN	10
US011	A	T1	TAX	10
US011	A	T3	FIN	5
US011	A	T3	TAX	5
US011	A	T7	FIN	5
US011	A	T7	TAX	5

The CM_DEPLETION Table

The Transaction Costing process places 030– Usage & Shipment transactions into CM_DEPLETION.

Business Unit	Item	Date/Time	Cost Book	Qty
US011	A	T5	FIN	6
US011	A	T5	TAX	6
US011	A	T9	FIN	5
US011	A	T9	TAX	5

The CM_ACTUAL_COST Table

Item putaway costs are computed and placed in CM_ACTUAL_COST table.

Business Unit	Item	Date/Time	Cost Element	Unit Cost
US011	A	T1	100	10.00
US011	A	T1	200	1.00
US011	A	T3	100	20.00
US011	A	T3	200	2.00
US011	A	T7	100	25.00
US011	A	T7	200	5.00

The CM_RECEIPT_COST Table

Data from the CM_RECEIPTS table and the CM_ACTUAL_COST table are used to calculate the receipt costs for the CM_RECEIPT_COST table. This is based on the cost type entered for the cost book on the Inventory Definition - Business Unit Books page.

Business Unit	Item	Date/Time	Cost Book	Cost Element	Unit Cost
US011	A	T1	FIN	100	10.00
US011	A	T1	FIN	200	1.00

Business Unit	Item	Date/Time	Cost Book	Cost Element	Unit Cost
US011	A	T1	TAX	100	10.00
US011	A	T1	TAX	200	1.00
US011	A	T3	FIN	100	20.00
US011	A	T3	FIN	200	2.00
US011	A	T3	TAX	100	20.00
US011	A	T3	TAX	200	2.00
US011	A	T7	FIN	100	25.00
US011	A	T7	FIN	200	5.00
US011	A	T7	TAX	100	25.00
US011	A	T7	TAX	200	5.00

The CM_ONHAND_VW Table

The CM_ONHAND_VW table matches receipts (putaways) with depletions (usage and shipments) based on the Cost Flow field on the Cost Profiles page.

Bus Unit	Item	Date/Time	Cost Book	T0 QTY	T2 QTY	T4 QTY	T6 QTY	T8 QTY	T10 QTY
US011	A	T1	FIN	0	10	10	4	4	0
US011	A	T1	TAX	0	10	10	4	4	0
US011	A	T3	FIN	0	0	5	5	5	4
US011	A	T3	TAX	0	0	5	5	5	4
US011	A	T7	FIN	0	0	0	0	5	5

<i>Bus Unit</i>	<i>Item</i>	<i>Date/Time</i>	<i>Cost Book</i>	<i>T0 QTY</i>	<i>T2 QTY</i>	<i>T4 QTY</i>	<i>T6 QTY</i>	<i>T8 QTY</i>	<i>T10 QTY</i>
US011	A	T7	TAX	0	0	0	0	5	5

The CM_DEplete Table

The process matches up each depletion transaction in CM_DEPLETION with a qualifying putaway from CM_ONHAND_VW. These depleted depletions are inserted into the CM_DEplete table. The Cost Flow field on the Cost Profiles page determines how receipts are matched with depletions.

<i>Business Unit</i>	<i>Item</i>	<i>Date/Time</i>	<i>Cost Book</i>	<i>Rec Date/Time</i>	<i>Qty</i>
US011	A	T5	FIN	T1	6
US011	A	T5	TAX	T1	6
US011	A	T9	FIN	T1	4
US011	A	T9	FIN	T3	1
US011	A	T9	TAX	T1	4
US011	A	T9	TAX	T3	1

The CM_DEplete_COST Table

The process calculates the cost of depletions in the CM_DEplete table and placed them in the CM_DEplete_COST table. This is based on the Deplete Cost Method defined on the Cost Profiles page.

<i>Business Unit</i>	<i>Item</i>	<i>Date/Time</i>	<i>Cost Book</i>	<i>Rec Date/Time</i>	<i>Cost Element</i>	<i>Unit Cost</i>
US011	A	T5	FIN	T1	100	13.3333
US011	A	T5	FIN	T1	200	1.3333
US011	A	T5	TAX	T1	100	16.2500
US011	A	T5	TAX	T1	200	2.2500

Business Unit	Item	Date/Time	Cost Book	Rec Date/ Time	Cost Element	Unit Cost
US011	A	T9	FIN	T1	100	17.5000
US011	A	T9	FIN	T1	200	2.6428
US011	A	T9	FIN	T3	100	17.5000
US011	A	T9	FIN	T3	200	2.6428
US011	A	T9	TAX	T1	100	16.2500
US011	A	T9	TAX	T1	200	2.2500
US011	A	T9	TAX	T3	100	16.2500
US011	A	T9	TAX	T3	200	2.2500

Costing Standard Cost Items

This diagram details the standard cost method used in PeopleSoft Cost Management. For this example, this information is used:

Inventory Business Unit	US009	US009
Item ID	A	A
Cost Book	FIN	TAX
From Cost Profile		
Receipt Cost Method (CM_TYPE)	Standard	Actual
Cost Flow (CM_FLOW)	FIFO	LIFO
Deplete Cost Method (CM_METHOD)	Standard	Actual

Standard costs used for item A:

<i>Inventory Business Unit</i>	<i>US009</i>	<i>US009</i>
Item ID	A	A
Cost Element	100	200
Unit Cost	18.00	3.00

This diagram illustrates the cost flow for a standard cost item.

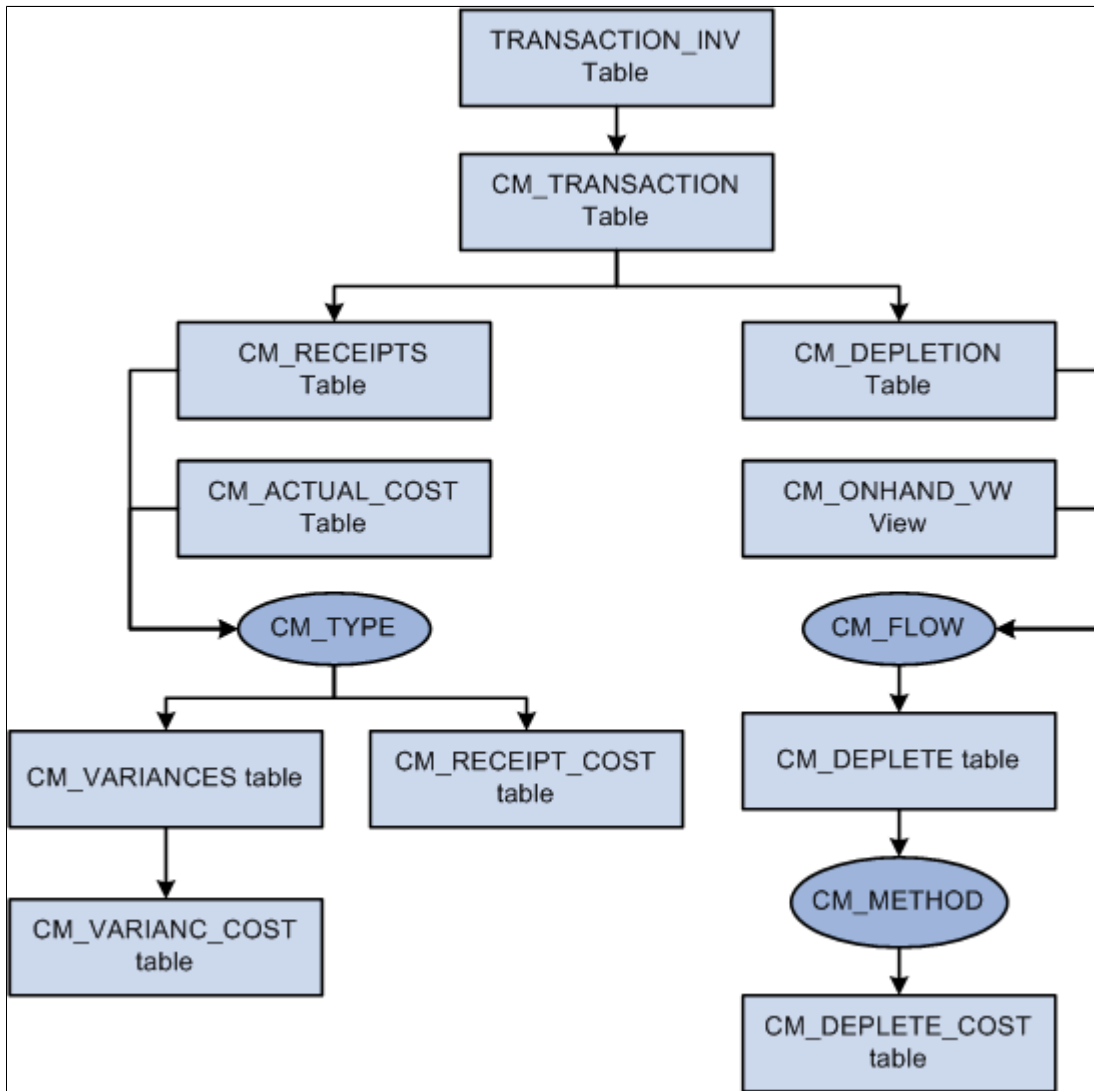

The TRANSACTION_INV Table

Transactions for PeopleSoft Inventory and PeopleSoft Manufacturing are inserted into the PeopleSoft Transaction History (TRANSACTION_INV) table. In this example, there are three transactions stocking item A into the US009 inventory business unit (020 Putaway transactions), and two transactions shipping item A out of the US009 business unit (030– Usage and Shipment transactions).

<i>Business Unit</i>	<i>Item</i>	<i>Date/Time</i>	<i>Transaction</i>	<i>Qty</i>
US009	A	T1	020–Putaway	10
US009	A	T3	020–Putaway	5
US009	A	T5	030–Usages & Shipments	6
US009	A	T7	020–Putaway	5
US009	A	T9	030–Usages & Shipments	5

The CM_TRANSACTION Table

The Transaction Costing process expands the transactions in TRANSACTION_INV into the PeopleSoft Cost Management CM_TRANSACTION table, adding a separate row for each business unit and cost book combination.

The CM_RECEIPTS Table

The Transaction Costing process places 020– Putaway transactions into CM_RECEIPTS.

<i>Business Unit</i>	<i>Item</i>	<i>Date/Time</i>	<i>Cost Book</i>	<i>Qty</i>
US009	A	T1	FIN	10
US009	A	T1	TAX	10
US009	A	T3	FIN	5
US009	A	T3	TAX	5
US009	A	T7	FIN	5
US009	A	T7	TAX	5

The CM_DEPLETION Table

The Transaction Costing process places 030– Usage & Shipment transactions into CM_DEPLETION.

Business Unit	Item	Date/Time	Cost Book	Qty
US009	A	T5	FIN	6
US009	A	T5	TAX	6
US009	A	T9	FIN	5
US009	A	T9	TAX	5

The CM_ACTUAL_COST Table

Item putaway costs are computed and placed in CM_ACTUAL_COST table.

Business Unit	Item	Date/Time	Cost Element	Unit Cost
US009	A	T1	100	10.00
US009	A	T1	200	1.00
US009	A	T3	100	20.00
US009	A	T3	200	2.00
US009	A	T7	100	25.00
US009	A	T7	200	5.00

The CM_RECEIPT_COST Table

Data from the CM_RECEIPTS table and the CM_ACTUAL_COST table are used to calculate the receipt costs for the CM_RECEIPT_COST table. This is based on the cost type entered for the cost book on the Inventory Definition - Business Unit Books page.

Business Unit	Item	Date/Time	Cost Book	Cost Element	Unit Cost
US009	A	T1	FIN	100	18.00
US009	A	T1	FIN	200	3.00

Business Unit	Item	Date/Time	Cost Book	Cost Element	Unit Cost
US009	A	T1	TAX	100	10.00
US009	A	T1	TAX	200	1.00
US009	A	T3	FIN	100	18.00
US009	A	T3	FIN	200	3.00
US009	A	T3	TAX	100	20.00
US009	A	T3	TAX	200	2.00
US009	A	T7	FIN	100	18.00
US009	A	T7	FIN	200	3.00
US009	A	T7	TAX	100	25.00
US009	A	T7	TAX	200	5.00

The CM_VARIANCES Table

Data from the CM_RECEIPTS table and the CM_ACTUAL_COST table are used to complete the CM_VARIANCES table. This is based on the cost type entered for the cost book on the Inventory Definition - Business Unit Books page.

Business Unit	Item	Date/Time	Cost Book	Qty
US009	A	T1	FIN	10
US009	A	T3	FIN	5
US009	A	T7	FIN	5

The CM_VARIANC_COST Table

Data from the CM_VARIANCES table is used to complete the CM_VARIANC_COST table.

Business Unit	Item	Date/Time	Cost Book	Cost Element	Unfav (fav) Unit Variance
US009	A	T1	FIN	100	(8.00)
US009	A	T1	FIN	200	(2.00)
US009	A	T3	FIN	100	2.00
US009	A	T3	FIN	200	(1.00)
US009	A	T7	FIN	100	7.00
US009	A	T7	FIN	200	2.00

The CM_ONHAND_VW Table

The CM_ONHAND_VW table matches receipts (putaways) with depletions (usage and shipments) based on the Cost Flow field on the Cost Profiles page.

Bus Unit	Item	Date/ Time	Cost Book	T0 QTY	T2 QTY	T4 QTY	T6 QTY	T8 QTY	T10 QTY
US009	A	T1	FIN	0	10	10	4	4	0
US009	A	T1	TAX	0	10	10	9	9	9
US009	A	T3	FIN	0	0	5	5	5	4
US009	A	T3	TAX	0	0	5	0	0	0
US009	A	T7	FIN	0	0	0	0	5	5
US009	A	T7	TAX	0	0	0	0	5	0

The CM_DEplete Table

The process matches up each depletion transaction in CM_DEPLETION with a qualifying putaway from CM_ONHAND_VW. These depleted depletions are inserted into the CM_DEplete table. The Cost Flow field on the Cost Profiles page determines how receipts are matched with depletions.

Business Unit	Item	Date/Time	Cost Book	Rec Date/Time	Qty
US009	A	T5	FIN	T1	6
US009	A	T5	TAX	T3	5
US009	A	T5	TAX	T1	1
US009	A	T9	FIN	T1	4
US009	A	T9	FIN	T3	1
US009	A	T9	TAX	T7	5

The CM_DEPLETE_COST Table

The process calculates the cost of depletions in the CM_DEPLETE table and placed them in the CM_DEPLETE_COST table. This is based on the Deplete Cost Method defined on the Cost Profiles page.

Business Unit	Item	Date/Time	Cost Book	Rec Date/Time	Cost Element	Unit Cost
US009	A	T5	FIN	T1	100	18.00
US009	A	T5	FIN	T1	200	3.00
US009	A	T5	TAX	T3	100	20.00
US009	A	T5	TAX	T3	200	2.00
US009	A	T5	TAX	T1	100	10.00
US009	A	T5	TAX	T1	200	1.00
US009	A	T9	FIN	T1	100	18.00
US009	A	T9	FIN	T1	200	3.00
US009	A	T9	FIN	T3	100	18.00

<i>Business Unit</i>	<i>Item</i>	<i>Date/Time</i>	<i>Cost Book</i>	<i>Rec Date/Time</i>	<i>Cost Element</i>	<i>Unit Cost</i>
US009	A	T9	FIN	T3	200	3.00
US009	A	T9	TAX	T7	100	25.00
US009	A	T9	TAX	T7	200	5.00

Example: Determining Your Cost Structure Strategy

These examples illustrate the different strategies for setting up the books and profiles, along with the steps that are necessary for each option. When deciding on an approach, be sure to consider future as well as current accounting and management requirements. The scenarios for cost structure strategies include:

- Using one cost profile and one book.
- Using different cost profiles in a business unit.
- Using different cost profiles in different business units.
- Using multiple simultaneous costing methods in one business unit.

Using One Cost Profile and One Book

This method is employed for environments where all items use the same cost method. Additionally, if the financial reporting requirements are simple, you can utilize the single book/single profile setup. For example, if all the items use the same costing method for all business units and you want to use one cost book, the steps to set up PeopleSoft Cost Management are simple and straightforward:

- Define a single cost book.
- Define a single cost profile.
- Define a single standard cost group and assign the book and cost profile to that cost group.
- As items are created at the SetID level, assign them the standard cost group.
- Define the PeopleSoft Inventory business units, and point to a corresponding PeopleSoft General Ledger business unit. Add the book to the PeopleSoft Inventory business units and point it to the primary ledgers that are in the default ledger groups for the PeopleSoft General Ledger business unit. If you manufacture items by using actual or average costing, also enter a cost type on the inventory business unit.

Now you are ready to add items to the PeopleSoft Inventory business unit. As you add items, the cost profile appears as the default value. No further set up is necessary.

Using Different Cost Profiles in a Business Unit

This option allows you to select a costing method on an item-by-item basis. This method may be utilized in environments where you might want to track the cost of selected items by lot or serial ID and others by FIFO or LIFO actual costs and still others by using a weighted average. In this instance, you need to create cost profiles for all the costing methods you want to employ and standard cost groups to categorize the items according to the various costing methods. To do this, perform these steps:

- Define a single cost book.
- Define the cost profiles.
- Define standard cost groups to categorize items according to the costing methods that are employed. Assign the book to each cost group. Select the appropriate cost profile for the cost group.
- As items are created at the SetID level, assign them to the appropriate standard cost group.
- Define the PeopleSoft Inventory business units, and point to a corresponding PeopleSoft General Ledger business unit. Add the book to the PeopleSoft Inventory business units and point it to the primary ledgers in the Default Ledger Groups for the PeopleSoft General Ledger business unit. If you manufacture items by using actual or average costing, also enter a cost type on the inventory business unit.

Now you are ready to add items to the PeopleSoft Inventory business unit. As you add items, the cost profile appears as the default value. No further set up is necessary.

This diagram illustrates how to select a cost method on an item-by-item basis.

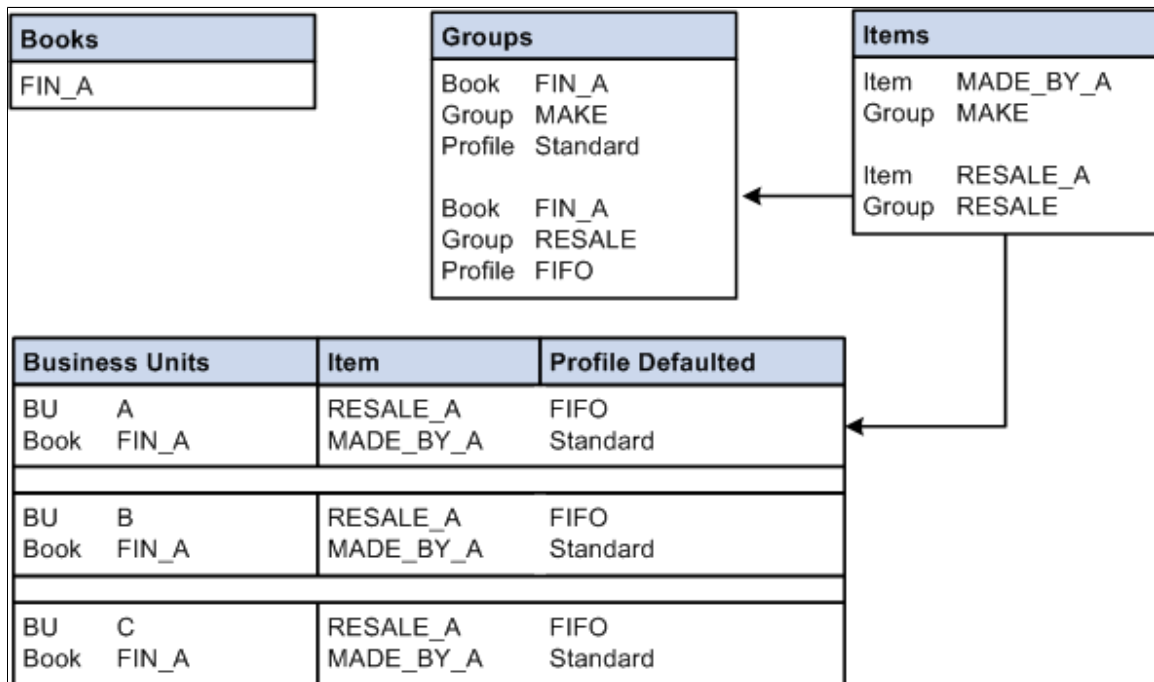

Using Different Cost Profiles in Different Business Units

This scenario allows you to cost an item differently in each business unit. You could, for example, use the standard cost method for all of the items that are in one business unit and FIFO actual in another. To set up this scenario:

- Define two or more books at the SetID level. Each book could represent a costing method. By using the preceding example, you could set up a book called FIN_A and FIN_B.
- Define the different costing profiles that are used in each business unit. Examples are STD and FIFO.
- Define a standard cost group. You could create a single group or multiple groups, depending on whether all items use the same costing method within a business unit.
- Assign both books to the standard cost group, and then assign a profile to each book. For example, cost group MAKE is assigned Book FIN_A and FIN_B. FIN_A uses the STD profile and FIN_B uses the FIFO profile.
- Define the items at the SetID. Assign the items to a standard cost group (MAKE in this example).
- Assign a book to a PeopleSoft Inventory business unit depending on the costing method that is used in the business unit. For this example, FIN_A is assigned to BU A; FIN_B is assigned to BU B.
- Add items to each business unit. As items are added to BU A, they are assigned a costing profile of STD. As items are added to BU B, they are assigned a costing profile of FIFO.

This diagram illustrates how to cost an item differently in different business units.

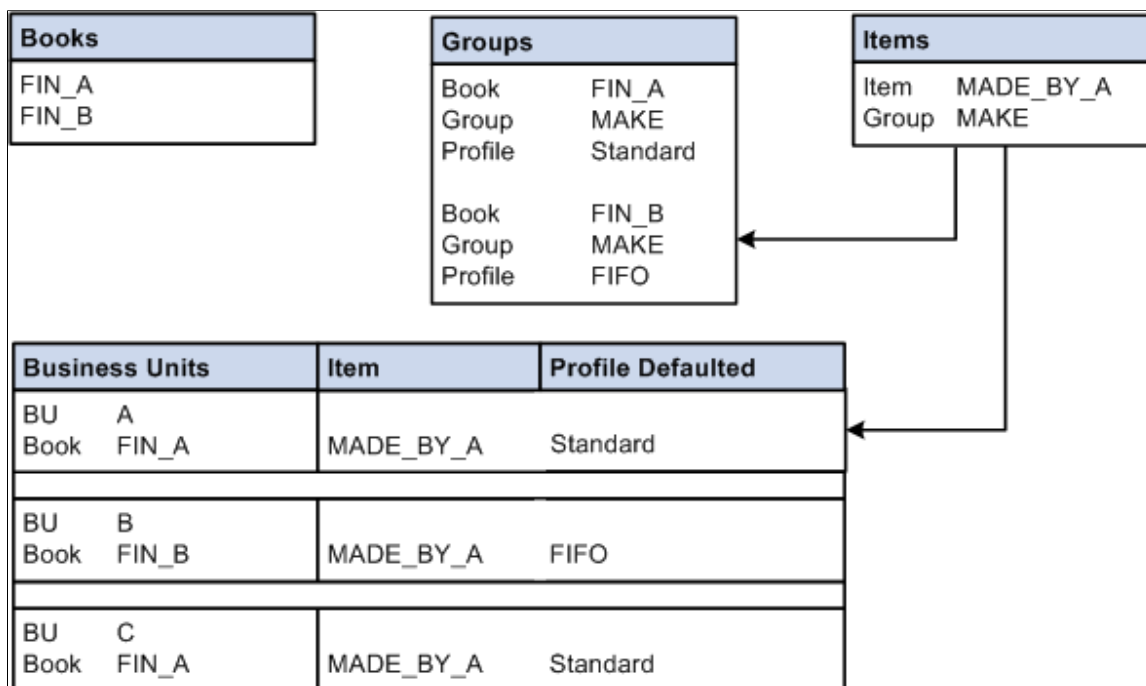

Using Multiple Simultaneous Costing Methods in One Business Unit

To support varying requirements for financial, government, and management reporting, you can maintain multiple books within a PeopleSoft Inventory business unit, with each book based on different costing

methods. You can cost an item differently in the business unit's financial reporting book than you do in the tax or management reporting books. For example, you could use the actual LIFO method cost for tax reporting, and at the same time use the periodic average cost method for customer profitability analysis. When you use simultaneous costing methods, you generate accounting entries for each book.

The setup for using multiple books within a single business unit is similar to the setup in the preceding example. However, both books are defined in a single PeopleSoft Inventory business unit. As items are added to the business unit, they inherit the profiles for all the books. When transactions for the items are costed and the Accounting Line Creation process (CM_ALC) is run, accounting entries are created for each book using the appropriate costing method.

PeopleSoft Cost Management Reports

PeopleSoft Cost Management Reports: A to Z

This table lists the PeopleSoft Cost Management reports sorted alphanumerically by report ID. If you need more information about a report, refer to the report details at the end of this topic:

<i>Report ID and Report Name</i>	<i>Description</i>	<i>Navigation</i>	<i>Run Control Page</i>
CES5001 Update Production Costs	Lists all updates to the frozen standard costs that are used in production and associated with a specified cost type and version. Sort by standard cost group and item ID, descending variance, or item ID. When applied, these costs update the production standard cost record and revalue inventory by using the standard cost method in all storage areas including stores, inspection, finished goods, and work in process (WIP), as well as in process inventory. Options include printing the report without revaluing inventory, revaluing inventory and printing the report, or revaluing inventory without printing a report. The Report Only option previews the financial impact of the standard cost changes without affecting the current standard costs.	Cost Accounting > Item Costs > Update Costs > Cost Update/Revalue > Update Production Select the Report Only- No Updates option or the Revalue Inventory and Report option.	RUN_CES5001

Report ID and Report Name	Description	Navigation	Run Control Page
<p>CES6000 Compare Cost Versions</p>	<p>Use to compare the item costs that are derived from a regular cost version to those of an engineering or simulation cost version, to analyze the impact of engineering changes to an item's cost, or to view the cost impact of changing the bill of materials (BOM) or process.</p> <p>If you want to analyze the impact of BOM, routing, labor, machine, or overhead rate changes on item costs, you can roll up costs for a separate cost type and version. To see the impact of the changes, you can compare two different cost types for an item or two versions of a single cost type.</p>	<p>Cost Accounting > Item Costs > Reports > Compare Cost Versions > Compare Cost Version</p>	<p>RUN_CES6000</p>
<p>CMS1000 Average Cost Adjustments</p>	<p>Reports adjustments and updates to perpetual average costs and retroactive perpetual average costs. The report includes adjustments entered directly on the Adjust Average Cost page (CM_COST_ADJ) and the Adjust Retro Costs page (CM_COST_ADJ_RETRO) as well as the purchase price variance (PPV) and exchange rate variance (ERV) updates that occur automatically when the Transaction Costing process runs.</p>	<p>Cost Accounting > Item Costs > Reports > Average Cost Adjustments > Average Cost Adjustment/PPV</p>	<p>RUN_CMS1000</p>
<p>CMS2000 Item Cost Profiles</p>	<p>Lists cost profiles for items that are in a selected business unit.</p>	<p>Cost Accounting > Inventory and Mfg Accounting > Reports > Item Cost Profiles</p>	<p>RUN_CMS2000</p>
<p>CMS2001 Overridden Cost Profiles</p>	<p>Lists business unit items where the cost profile is different from what is specified in the cost profile group.</p>	<p>Cost Accounting > Inventory and Mfg Accounting > Reports > Override Cost Profiles</p>	<p>RUN_CMS2001</p>
<p>CMS2002 Item without Profiles</p>	<p>Lists business unit items that are not associated with a cost profile.</p>	<p>Cost Accounting > Inventory and Mfg Accounting > Reports > Items without Cost Profiles</p>	<p>RUN_CMS2002</p>

Report ID and Report Name	Description	Navigation	Run Control Page
CMS2010 On Hand Value Report	Lists on-hand quantity and value at the summary or detail level. Can be used for items with any cost method. The report can calculate WIP as of any point in time and is accurate to the extent that the Transaction Costing, Accounting Line Creation, and Journal Generator processes have been run. The report can also store snapshots of previously generated report data for historical reporting. Select the items that are to appear on the report by business unit, cost book, cost profile, item information, or accounting period. In addition, you can use it to compare the on-hand value by using floor and ceiling costs or last price used.	Cost Accounting > Inventory and Mfg Accounting > Reports > Inventory Value History	RUN_CMS2010A RUN_CMS2010 RUN_CMS2011
CMS2015 Movement by Receipt	Summarizes depletions, and shows on-hand quantity and value by receipt line. The unit costs that are used to calculate receipt and depletion costs reflect costs at transaction time.	Cost Accounting > Inventory and Mfg Accounting > Reports > Movement by Receipt	RUN_CMS2015
CMS2016 Movement by Depletion	For each depletion line, this report prints the receipt that the system uses to deplete that transaction, by business unit, book, and item. The depletion cost is calculated based on the cost at processing time. The report does not display on-hand quantity or value.	Cost Accounting > Inventory and Mfg Accounting > Reports > Movement by Depletion	RUN_CMS2016

Report ID and Report Name	Description	Navigation	Run Control Page
<p>CMS2018 WIP Value History Report</p>	<p>Lists the inventory value of all actual WIP costs at a summary or detail level. The report can calculate WIP as of any point in time and is accurate to the extent that the Transaction Costing, Accounting Line Creation, and Journal Generator processes have been run. The report can also store snapshots of previously generated report data for historical reporting. Select the items that are to appear on the report by business unit, cost book, cost profile, item information, or accounting period.</p> <hr/> <p>Note: The WIP Value History report is only for production with items using a cost method of actual or perpetual average. For production using a cost method of standard, the WIP Value Inventory Report (SFS1000) can be used to review WIP Value for standard-costed assemblies.</p>	<p>Cost Accounting > Inventory and Mfg Accounting > Reports > WIP Value History</p>	<p>RUN_CMS2018A RUN_CMS2018B RUN_CMS2018C</p>
<p>CMS3000 Estimated vs. Actual Landed Costs</p>	<p>Lists the purchase price variances (PPV) for landed cost components.</p>	<p>Purchasing > Receipts > Reports > Estimate/Actual Landed Cost</p>	<p>RUN_CMS3000</p>
<p>CMS3010 Total Purchase Variance</p>	<p>Lists the purchase price variances (PPV) and exchange rate variances (ERV) for landed cost components.</p>	<p>Purchasing > Receipts > Reports > Total Purchase Variance</p>	<p>RUN_CMS3010</p>
<p>CMS3020 Standard Purchase Variance</p>	<p>For frozen standard items only, lists the purchase price variances (PPV) that are recognized at receipt of the item.</p>	<p>Purchasing > Receipts > Reports > Standard Purchase Variance</p>	<p>RUN_CMS3020</p>

Report ID and Report Name	Description	Navigation	Run Control Page
CMS9010 On Hand Balance Validation	Verifies that the quantities tracked by PeopleSoft Cost Management are the same as the quantities tracked by PeopleSoft Inventory. This report serves as an audit tool to help verify that every change to PeopleSoft Inventory quantity balances has been accounted for in the PeopleSoft Cost Management system.	Cost Accounting > Inventory and Mfg Accounting > Reports > On Hand Balance Validation	RUN_CMS9010
ENS1011 Costed Routing Report or Costed Eng Routing Report	Displays costs by item routing, including conversion and overheard conversion costs that are attached to the item routing by task or work center. Material costs can also be displayed if a BOM code is entered. Enter unit, item ID, cost type, cost version, routing code, and BOM code. All routing codes and BOM codes are available; the Cost Rollup process does not have to be run to retrieve the costs.	<ul style="list-style-type: none"> • Manufacturing Definitions > Resources and Routings > Routings > Costed Routing Report • Engineering > Routings > Costed Eng Routing Report 	RUN_ENS1011
INS7000 Inventory Value	Provides realtime, on-hand quantities and values for items using standard costing or perpetual weighted average costing. This report is not intended for actual cost items.	Cost Accounting > Inventory and Mfg Accounting > Reports > Current Inventory Value	RUN_INS7000
INS7050 Accounting Register	Lists accounting transactions with item information, transaction dates, and the posted ChartFields.	Cost Accounting > Inventory and Mfg Accounting > Reports > Accounting Register	RUN_INS7050
INS7100 Transaction Register	Lists all transactions by item ID.	Cost Accounting > Inventory and Mfg Accounting > Reports > Item Transaction Register	RUN_INS7100

Report ID and Report Name	Description	Navigation	Run Control Page
<p>SFS1000 WIP Inventory Value</p>	<p>(standard cost items only) Lists the value of all WIP items by production type sorted by account, item ID, or production area. Lists the value of all items that are in various stages of assembly, including material that is consumed from the WIP locations or issued as part of a production kit. This report also lists labor, machine, overhead, and outside processing costs that are incurred up to the point that the WIP inventory value report is run. This report does not include the costs of any scrapped components or assemblies, or assemblies that are completed to stock. You can select owned items and consigned items. Includes a line for waste costs.</p>	<p>Production Control > Close and Analyze Production > WIP Inventory Value Rpt</p>	<p>RUN_SFS1000</p>
<p>SFS1100 Close Production</p>	<p>Closes production schedules or production IDs, and calculates the variances that are incurred. Use the Report Only mode to view the production that can and cannot be closed as well as the variances that can be generated as a result of an accounting close. Combining numerous sort options assists in narrowing down the production close information that is reported.</p>	<p>Production Control > Close and Analyze Production > Close Production</p>	<p>RUN_SFS1100 RUN_SFS1100A</p>
<p>SFS1200 Reopen Production</p>	<p>Enables production to be reopened to record additional completions, material consumption, or actual hours. Use the Report Only mode to provide a preview of the financial impact of reopening production without creating reversing entries. Combining numerous sort options assists in narrowing down the production reopen information that is reported.</p>	<p>Production Control > Close and Analyze Production > Reopen Production</p>	<p>RUN_SFS1200</p>

Report ID and Report Name	Description	Navigation	Run Control Page
SFS1500 Production Variance Report	Lists variances for production IDs or production schedules for a specified production due date and shift and above a minimum monetary amount. Variances include configuration, usage, component yield, lot size, routing process, rework, teardown, production mix variance, and outside processing.	Production Control > Close and Analyze Production > Production Variance Report	RUN_SFS1500
SFS1600 Potential Production Variance Report	Lists potential production variances that exist in production above a monetary amount before closing for accounting production IDs and schedules. The report can be generated when in a production status of in process, pending complete, complete, and closed for labor. Variances include configuration, usage, component yield, lot size, routing process, rework, teardown, production mix variance, and outside processing.	Production Control > Close and Analyze Production > Potential Prdn Variance Rpts	RUN_SFS1600
SFS2005 Efficiency and Utilization Report	Details efficiency variances and utilization by work center. Within work centers, the production ID or schedule that utilizes the work center is specified. Efficiency variance is the difference between the actual hours that are expended for an operation and the earned hours for the operation. Utilization compares the available hours for a work center to the actual hours that are recorded for a work center.	Production Control > Close and Analyze Production > Efficiency and Utilization Rpt	RUN_SFS2005

Report ID and Report Name	Description	Navigation	Run Control Page
CM_EOM_VALUE Inventory Cost Balancing Report	Compares changes in Inventory values [item and account level] to those on Inventory distribution accounting lines, to identify variances, for a given accounting period.	Cost Accounting >Inventory and Mfg Accounting >Reports >Inventory Cost Balancing Rpt	CM_EOM_VALUE_1 CM_EOM_VALUE_2 CM_EOM_VALUE_3

Related Links

- [PeopleSoft Cost Management Selected Reports](#)
- [PeopleSoft Cost Management Reports: A to Z](#)

PeopleSoft Cost Management Selected Reports

This section provides detailed information about individual reports, including important fields. The reports are listed alphabetically by report ID.

Common Element Used in This Section

Field or Control	Description
As of Date	Determines which items to include in the report. Items open on the as of date are included.

CMS1000 - Average Cost Adjustment/PPV Report

The process page that you use to generate this report includes these fields:

Field or Control	Description
Date From/Date To	Specify a range of dates for all transactions that are to be included in the report. If you fail to enter a date from, the report includes all transactions that are on file from the start of history. If you fail to enter a date to, the report includes all transactions up to the end of the existing history.
Cost Adjustments	Select to include the cost adjustments that are made through the Adjust Average Cost page.

<i>Field or Control</i>	<i>Description</i>
PPV Updates	Select to include the adjustments that are made to the perpetual weighted average cost because of purchase price variances and exchange rate variances. These adjustments are made when you run the Transaction Costing process (within the Cost Accounting Creation process) after you select the Apply Perpetual Average Adjs check box.

Related Links

[Understanding Average and Actual Costing](#)

CMS2000 - Item Cost Profiles Report

Select a Cost Profile Group option:

<i>Field or Control</i>	<i>Description</i>
All	Items that are associated or not associated with a cost profile group.
None	Items that are not associated with any cost profile group.
Specific	Items that are associated with a specific cost group profile.

CMS2018 – WIP Value History Report

The process page that you use to generate this report includes these fields:

<i>Field or Control</i>	<i>Description</i>
Print, Don't Store Snapshot	Print the report that is to be generated, but do not store a snapshot of the report data for subsequent reprinting.
Print, Store Snapshot	Print the report that is to be generated, and store a snapshot of the report data for subsequent reprinting.
Don't Print, Store Snapshot	Generate the report and store a snapshot of the data, but do not print a report.
Print Stored Snapshot	Reprint a previously stored snapshot of the report.
Purge Stored Snapshot	Delete a previously stored snapshot of the report.

On the **Other Criteria** tab, select a report type of *Summary*, or *Detail*. The summary report shows totals by business unit, book, and item. The detail report displays costs broken down by business unit, book, item, and cost element.

CMS3000 - Estimated vs. Actual Landed Costs Report

The process page that you use to generate this report includes these fields:

Field or Control	Description
From Transaction Date/To	Specify a range of dates for all transactions that are to be included in the report.
View	Select to view data on the report by: <i>Component:</i> The cost component. Also called the miscellaneous charge code. <i>Group:</i> The landed cost group ID. This option groups one or more miscellaneous charge codes.

CMS3010 - Total Purchase Variance Report

The process page that is used to generate this report includes these fields:

Field or Control	Description
From Transaction Date/To	Specify a range of dates for all transactions that are to be included in the report.
View	Select to view data on the report by: <i>Component:</i> The cost component. Also called the miscellaneous charge code. <i>Group:</i> The landed cost group ID. This option groups one or more miscellaneous charge codes.
Tolerance %	You can enter tolerance percentage to report only variances exceeding a certain percentage of the standard component cost. The tolerance is defined by cost component (miscellaneous charge code) on the Misc Charge/Landed Cost Definition page.

CMS3020 - Standard Purchase Variance Report

The process page that you use to generate this report includes these fields:

Field or Control	Description
From Transaction Date/To	Specify a range of dates for all transactions that are to be included in the report.
Tolerance %	You can enter tolerance percentage to report only variances exceeding a certain percentage of the standard component cost. The tolerance is defined by cost component (miscellaneous charge code) on the Misc Charge/Landed Cost Definition page.

CMS9010 - On Hand Balance Validation Report

The report includes:

Field or Control	Description
Adjustments	<p>This column includes differences between onhand quantities in PeopleSoft Cost Management and PeopleSoft Inventory. Reasons for these differences include:</p> <ul style="list-style-type: none"> Inventory transactions from the TRANSACTION_INV table which have not yet been captured into PeopleSoft Cost Management. These uncostered transactions occur when inventory movement that has not yet been processed by the Transaction Costing process. Inventory items that have been picked but not shipped. The item's onhand quantity in PeopleSoft Inventory is updated, but a TRANSACTION_INV row has not been created. Instead, the information resided in the IN_DEMAND table and the DEMAND_PHYS_INV table. These <i>picked but not shipped</i> items must be included in the comparison of PeopleSoft Cost Management and PeopleSoft Inventory onhand quantities since they have already changed inventory quantities, but not the Cost Management quantities.

INS7000 - Inventory Value Report

Prior to running the inventory value report:

- Use the Complete Putaway process to put away all pending inventory in the appropriate storage areas, ensuring that the system has accounted for all inventory in the enterprise.
- Run the complete shipping and Deplete On Hand Qty processes to ensure that the item's quantities at the business unit level match the item's quantities at the location level.

You do not need to run the Transaction Costing process for this report to be accurate.

Field or Control	Description
Inventory Cost Type	Options are: <i>Perpetual Weight Avg Costed</i> (perpetual weight average costed), <i>All Costed Inventory Items</i> , and <i>Standard Costed</i> . This report is not intended for actual cost items.
Consigned Items	Select whether to include consigned items (this field is available only if any of the items that are to be reported are consigned). Options are: <i>Consigned Inventory Only</i> , <i>Exclude Consigned Inventory</i> , and <i>Include Consigned Inventory</i> .
Item Options	You can choose to report based on <i>All</i> or on a <i>Single Item ID</i> . If you select <i>All</i> , you can restrict the items that are reported by <i>Item Group</i> or by <i>Family</i> .

INS7050 - Accounting Register

The **Date Option** group box offers several choices:

Field or Control	Description
Today	Report transactions for today's date only.
As Of Date	Report transactions as of the date that is specified.
Date Range	Report transactions occurring between the two dates that are specified.

INS7100 - Transaction Register

The **Date Option** group box offers several choices:

Field or Control	Description
Today	Report transactions for today's date only.
As Of Date	Report transactions as of the date that is specified.
Date Range	Report transactions occurring between the two dates that are specified.

SFS1500 - Production Variance Report

The process page that you use to generate this report includes these fields:

Field or Control	Description
Variance Posting Date	The dates that production is closed for accounting.
Prdn Due Date/Shift	Enter a beginning and end production due date and shift. The Shift field value must be between 1 and 3.
Variance Tolerance Amount	Enter the minimum monetary amount on which you want to display report results. By specifying a minimum monetary amount, you can focus in on those production IDs or production areas with significant variances. Enter 0.00 to report all variances for the production that is selected.

SFS1600 - Potential Production Variance Report

The process page that you use to generate this report includes these field:

Field or Control	Description
Report Variance Above Amount	Enter the lower limit for variances that you want to see. If, for example, you enter 1000.00 here, only those production IDs and schedules with a variance over 1000.00 are reported. To see variances on all production, enter 0.00. A favorable or unfavorable variance above the specified amount is reported.

SFS2005 - Efficiency/Utilization Report

The process page that you use to generate this report includes these fields:

Field or Control	Description
Detail or Summary Report	A detail report displays the earned and actual labor reported by production ID or production schedule for the work center. The summary report displays earned and actual labor by work center without the production ID or production schedule detail.
Entry Date	Specify the date range for which you want to report efficiency variances and utilization. The report includes all earned labor or machine hours or all actual hours that are recorded within the dates that are specified.

