

Oracle® Key Vault Administrator's Guide



Release 21.3

F45655-02

October 2021

The Oracle logo, consisting of a solid red square with the word "ORACLE" in white, uppercase, sans-serif font centered within it.

ORACLE®

Oracle Key Vault Administrator's Guide, Release 21.3

F45655-02

Copyright © 2014, 2021, Oracle and/or its affiliates.

Primary Authors: Mark Doran, Patricia Huey

Contributing Authors: Hans Forbrich, Mark Fuller, James Womack

Contributors: Alexis Abell, Bharathi Baskaran, Swati Vijaya Bhaskar , Lalitha Chowdary, Shubham Goyal, Claudia Hüffer , Fahad Ibrar, Srivatsan Kannan, Usha Krishnamurthy, Shirley Kumamoto, Swapna Jawarikapisha, Peter Knaggs, Michael Leong, Hui Li, William Maroulis, Khushal Melana, Rahil Mir, Dongwon Park, Sunil Pulla, Vipin Samar, Radhika Siravara, Ajay Srivastava, Peter Wahl

This software and related documentation are provided under a license agreement containing restrictions on use and disclosure and are protected by intellectual property laws. Except as expressly permitted in your license agreement or allowed by law, you may not use, copy, reproduce, translate, broadcast, modify, license, transmit, distribute, exhibit, perform, publish, or display any part, in any form, or by any means. Reverse engineering, disassembly, or decompilation of this software, unless required by law for interoperability, is prohibited.

The information contained herein is subject to change without notice and is not warranted to be error-free. If you find any errors, please report them to us in writing.

If this is software or related documentation that is delivered to the U.S. Government or anyone licensing it on behalf of the U.S. Government, then the following notice is applicable:

U.S. GOVERNMENT END USERS: Oracle programs (including any operating system, integrated software, any programs embedded, installed or activated on delivered hardware, and modifications of such programs) and Oracle computer documentation or other Oracle data delivered to or accessed by U.S. Government end users are "commercial computer software" or "commercial computer software documentation" pursuant to the applicable Federal Acquisition Regulation and agency-specific supplemental regulations. As such, the use, reproduction, duplication, release, display, disclosure, modification, preparation of derivative works, and/or adaptation of i) Oracle programs (including any operating system, integrated software, any programs embedded, installed or activated on delivered hardware, and modifications of such programs), ii) Oracle computer documentation and/or iii) other Oracle data, is subject to the rights and limitations specified in the license contained in the applicable contract. The terms governing the U.S. Government's use of Oracle cloud services are defined by the applicable contract for such services. No other rights are granted to the U.S. Government.

This software or hardware is developed for general use in a variety of information management applications. It is not developed or intended for use in any inherently dangerous applications, including applications that may create a risk of personal injury. If you use this software or hardware in dangerous applications, then you shall be responsible to take all appropriate fail-safe, backup, redundancy, and other measures to ensure its safe use. Oracle Corporation and its affiliates disclaim any liability for any damages caused by use of this software or hardware in dangerous applications.

Oracle, Java, and MySQL are registered trademarks of Oracle and/or its affiliates. Other names may be trademarks of their respective owners.

Intel and Intel Inside are trademarks or registered trademarks of Intel Corporation. All SPARC trademarks are used under license and are trademarks or registered trademarks of SPARC International, Inc. AMD, Epyc, and the AMD logo are trademarks or registered trademarks of Advanced Micro Devices. UNIX is a registered trademark of The Open Group.

This software or hardware and documentation may provide access to or information about content, products, and services from third parties. Oracle Corporation and its affiliates are not responsible for and expressly disclaim all warranties of any kind with respect to third-party content, products, and services unless otherwise set forth in an applicable agreement between you and Oracle. Oracle Corporation and its affiliates will not be responsible for any loss, costs, or damages incurred due to your access to or use of third-party content, products, or services, except as set forth in an applicable agreement between you and Oracle.

Contents

Preface

Audience	xxi
Documentation Accessibility	xxi
Diversity and Inclusion	xxi
Related Documents	xxi
Conventions	xxii

Changes in This Release for Oracle Key Vault

Changes for Oracle Key Vault Release 21.3	xxiii
Changes for Oracle Key Vault Release 21.2	xxiv

1 Introduction to Oracle Key Vault

1.1	About Key and Secrets Management in Oracle Key Vault	1-1
1.2	Benefits of Using Oracle Key Vault	1-2
1.3	Oracle Key Vault Use Cases	1-4
1.3.1	Centralized Storage of Oracle Wallet Files and Java Keystores	1-4
1.3.2	Centralized Management of TDE Master Encryption Keys Using Online Master Keys	1-5
1.3.3	Storage of Credential Files	1-7
1.3.4	Online Management of Endpoint Keys and Secret Data	1-8
1.4	Who Should Use Oracle Key Vault	1-8
1.5	Major Features of Oracle Key Vault	1-9
1.5.1	Centralized Storage and Management of Security Objects	1-10
1.5.2	Management of Key Lifecycle	1-11
1.5.3	Reporting and Alerts	1-11
1.5.4	Separation of Duties for Oracle Key Vault Users	1-11
1.5.5	Persistent Master Encryption Key Cache	1-12
1.5.6	Backup and Restore Functionality for Security Objects	1-12
1.5.7	Management of Oracle Key Vault Using RESTful Service	1-13
1.5.8	Support for OASIS Key Management Interoperability Protocol (KMIP)	1-13
1.5.9	Database Release and Platform Support	1-13

1.5.10	Integration with External Audit and Monitoring Services	1-14
1.5.11	Integration of MySQL with Oracle Key Vault	1-14
1.5.12	Automatic Storage Management Cluster File System (ACFS) Encryption	1-14
1.5.13	Support for Oracle Cloud Database as a Service Endpoints	1-14
1.5.14	Oracle Key Vault Hardware Security Module Integration	1-14
1.5.15	Support for a Primary-Standby Environment	1-15
1.6	Oracle Key Vault Interfaces	1-15
1.6.1	Oracle Key Vault Management Console	1-16
1.6.2	Oracle Key Vault okvutil Endpoint Utility	1-16
1.6.3	Oracle Key Vault RESTful Services	1-16
1.6.4	Oracle Key Vault Client SDK	1-16
1.7	Overview of an Oracle Key Vault Deployment	1-17

2 Oracle Key Vault Concepts

2.1	Overview of Oracle Key Vault Concepts	2-1
2.2	Oracle Key Vault Deployment Architecture	2-2
2.3	Access Control Configuration	2-3
2.3.1	About Access Control Configuration	2-3
2.3.2	Access Grants	2-4
2.3.3	Access Control Options	2-4
2.4	Administrative Roles and Endpoint Privileges within Oracle Key Vault	2-5
2.4.1	Separation of Duties in Oracle Key Vault	2-5
2.4.2	Administrative Roles	2-6
2.4.2.1	About Administrative Roles in Oracle Key Vault	2-6
2.4.2.2	System Administrator Role Duties	2-7
2.4.2.3	Key Administrator Role Duties	2-8
2.4.2.4	Audit Manager Role Duties	2-8
2.4.3	Endpoint Privileges	2-8
2.4.3.1	About Endpoint Privileges in Oracle Key Vault	2-9
2.4.3.2	Create Endpoint Privilege Duties and Scope	2-9
2.4.3.3	Manage Endpoint Privilege Duties and Scope	2-10
2.4.3.4	Create Endpoint Group Privilege Duties and Scope	2-11
2.4.3.5	Manage Endpoint Group Privilege Duties and Scope	2-13
2.5	Naming Guidelines for Objects	2-14
2.6	Emergency System Recovery Process	2-15
2.7	Root and Support User Accounts	2-15
2.8	Endpoint Administrators	2-16
2.9	FIPS Mode	2-16

3 Oracle Key Vault Multi-Master Cluster Concepts

3.1	Oracle Key Vault Multi-Master Cluster Overview	3-1
3.2	Benefits of Oracle Key Vault Multi-Master Clustering	3-2
3.3	Multi-Master Cluster Architecture	3-3
3.3.1	Oracle Key Vault Cluster Nodes	3-4
3.3.2	Cluster Node Limitations	3-4
3.3.3	Cluster Subgroups	3-5
3.3.4	Critical Data in Oracle Key Vault	3-5
3.3.5	Oracle Key Vault Read-Write Nodes	3-6
3.3.6	Oracle Key Vault Read-Only Nodes	3-6
3.3.7	Cluster Node Mode Types	3-6
3.3.8	Operations Permitted on Cluster Nodes in Different Modes	3-7
3.4	Building and Managing a Multi-Master Cluster	3-7
3.4.1	About Building and Managing a Multi-Master Cluster	3-7
3.4.2	Creation of the Initial Node in a Multi-Master Cluster	3-8
3.4.3	Expansion of a Multi-Master Cluster	3-9
3.4.3.1	About the Expansion of a Multi-Master Cluster	3-9
3.4.3.2	Management of Cluster Reconfiguration Changes Using a Controller Node	3-9
3.4.3.3	Addition of a Candidate Node to the Multi-Master Cluster	3-10
3.4.3.4	Addition of More Nodes to a Multi-Master Cluster	3-10
3.4.4	Migration to the Cluster from an Existing Deployment	3-12
3.4.4.1	Conversion of an Oracle Key Vault Standalone Server to a Multi-Master Cluster	3-12
3.4.4.2	Conversion from a Primary-Standby Server to a Multi-Master Cluster	3-13
3.5	Oracle Key Vault Multi-Master Cluster Deployment Scenarios	3-13
3.5.1	Cluster Size and Availability in Deployments	3-14
3.5.2	Two-Node Cluster Deployment	3-14
3.5.3	Mid-Size Cluster Across Two Data Centers Deployment	3-15
3.6	Multi-Master Cluster Features	3-18
3.6.1	Cluster Inconsistency Resolution in a Multi-Master Cluster	3-19
3.6.2	Name Conflict Resolution in a Multi-Master Cluster	3-19
3.6.3	Endpoint Node Connection Lists (Endpoint Node Scan Lists)	3-19
3.7	Cluster Management Information	3-20

4 Managing Oracle Key Vault Multi-Master Clusters

4.1	About Managing Oracle Key Vault Multi-Master Clusters	4-2
4.2	Setting Up a Cluster	4-2
4.2.1	About Setting Up a Cluster	4-2
4.2.2	Creating the First (Initial) Node of a Cluster	4-2

4.2.3	Adding Nodes to a Cluster	4-3
4.2.3.1	Adding a Node to Create a Read-Write Pair	4-4
4.2.3.2	Adding a Node as a Read-Only Node	4-6
4.2.3.3	Creating an Additional Read-Write Pair in a Cluster	4-7
4.3	Terminating the Pairing of a Node	4-8
4.4	Disabling a Cluster Node	4-9
4.5	Enabling a Disabled Cluster Node	4-9
4.6	Deleting a Cluster Node	4-10
4.7	Force Deleting a Cluster Node	4-10
4.8	Managing Replication Between Nodes	4-11
4.8.1	Restarting Cluster Services	4-11
4.8.2	Disabling Node Replication	4-11
4.8.3	Enabling Node Replication	4-11
4.9	Cluster Management Information	4-12
4.10	Cluster Monitoring Information	4-13
4.11	Naming Conflicts and Resolution	4-15
4.11.1	About Naming Conflicts and Resolution	4-15
4.11.2	Naming Conflict Resolution Information	4-15
4.11.3	Changing the Suggested Conflict Resolution Name	4-16
4.11.4	Accepting the Suggested Conflict Resolution Name	4-16
4.12	Multi-Master Cluster Deployment Recommendations	4-17

5 Managing an Oracle Key Vault Primary-Standby Configuration

5.1	Overview of the Oracle Key Vault Primary-Standby Configuration	5-1
5.1.1	About the Oracle Key Vault Primary-Standby Configuration	5-2
5.1.2	Benefits of an Oracle Key Vault Primary-Standby Configuration	5-3
5.1.3	Difference Between Primary-Standby Configuration and Multi-Master Cluster	5-4
5.1.4	Primary Server Role in a Primary-Standby Configuration	5-4
5.1.5	Standby Server Role in a Primary-Standby Configuration	5-5
5.2	Configuring the Primary-Standby Environment	5-5
5.2.1	Step 1: Configure the Primary Server	5-5
5.2.2	Step 2: Configure the Standby Server	5-6
5.2.3	Step 3: Complete the Configuration on the Primary Server	5-8
5.3	Switching the Primary and Standby Servers	5-9
5.4	Restoring Primary-Standby After a Failover	5-10
5.5	Disabling (Unpairing) the Primary-Standby Configuration	5-11
5.6	Read-Only Restricted Mode in a Primary-Standby Configuration	5-12
5.6.1	About Read-Only Restricted Mode in a Primary-Standby Configuration	5-13
5.6.2	Primary-Standby with Read-Only Restricted Mode	5-14
5.6.3	Primary-Standby without Read-Only Restricted Mode	5-14

5.6.4	States of Read-Only Restricted Mode	5-15
5.6.4.1	About the States of Read-Only Restricted Mode	5-15
5.6.4.2	Read-Only Restricted State Functionality During a Primary Server Failure	5-16
5.6.4.3	Read-Only Restricted Mode Functionality During a Standby Server Failure	5-17
5.6.4.4	Read-Only Restricted State Functionality During a Network Failure	5-17
5.6.5	Enabling Read-Only Restricted Mode	5-17
5.6.6	Disabling Read-Only Restricted Mode	5-18
5.6.7	Recovering from Read-Only Restricted Mode	5-19
5.6.8	Read-Only Restricted Mode Notifications	5-20
5.7	Best Practices for Using Oracle Key Vault in a Primary-Standby Configuration	5-20

6 Deploying Oracle Key Vault on an Oracle Cloud Infrastructure VM Compute Instance

6.1	About Deploying Oracle Key Vault on an Oracle Cloud Infrastructure Compute Instance	6-1
6.2	Benefits of Using Oracle Key Vault in Oracle Cloud Infrastructure	6-2
6.3	Provisioning an Oracle Key Vault Compute Instance	6-3
6.3.1	About Provisioning an Oracle Key Vault Compute Instance	6-3
6.3.2	Launching the Oracle Key Vault Compute Instance	6-4
6.3.2.1	About Launching the Oracle Key Vault Compute Instance	6-4
6.3.2.2	Step 1: Ensure That You Have Prerequisites in Place	6-4
6.3.2.3	Step 2: Find the Oracle Key Vault Image	6-4
6.3.2.4	Step 3: Launch the Oracle Key Vault VM Compute Instance	6-5
6.3.2.5	Step 4: Perform Post-Launch and Post-Installation Tasks	6-5
6.4	General Management of an Oracle Key Vault Compute Instance	6-6
6.4.1	Starting, Restarting, or Stopping an Oracle Key Vault Compute Instance	6-7
6.4.2	System Settings in an Oracle Key Vault Compute Instance	6-7
6.4.3	Backup and Restore Operations for Oracle Key Vault Compute Instances	6-8
6.4.4	Terminating an Oracle Key Vault Compute Instance	6-8
6.5	Migrating Oracle Key Vault Deployments Between On-Premises and OCI	6-9
6.5.1	About Performing Migrations with Oracle Key Vault Compute Instance Data	6-9
6.5.2	Migrating Oracle Key Vault Deployments into OCI Using Backup and Restore	6-9
6.5.3	Migrating Oracle Key Vault Deployments Out of OCI Using Backup and Restore	6-10

7 Oracle Database Instances in Oracle Cloud Infrastructure

7.1	About Managing Oracle Cloud Infrastructure Database Instance Endpoints	7-1
7.2	Preparing a Database Instance on OCI to be an Oracle Key Vault Endpoint	7-2

7.2.1	About Preparing a Database Instance on OCI to be an Oracle Key Vault Endpoint	7-2
7.2.2	Configuring a Database Cloud Service Instance	7-2
7.2.3	Creating a Low Privileged Operating System User on Database as a Service	7-3
7.3	Using an SSH Tunnel Between Oracle Key Vault and Database as a Service	7-4
7.3.1	Creating an SSH Tunnel Between Oracle Key Vault and a DBaaS Instance	7-5
7.3.2	Managing a Reverse SSH Tunnel in a Multi-Master Cluster	7-8
7.3.3	Managing a Reverse SSH Tunnel in a Primary-Standby Configuration	7-8
7.3.4	Viewing SSH Tunnel Configuration Details	7-9
7.3.5	Disabling an SSH Tunnel Connection	7-9
7.3.6	How the Connection Works if the SSH Tunnel Is Not Active	7-11
7.3.7	Deleting an SSH Tunnel Configuration	7-11
7.4	Registering and Enrolling a Database as a Service Instance as an Oracle Key Vault Endpoint	7-12
7.4.1	About Registering and Enrolling a Database as a Service Instance as an Oracle Key Vault Endpoint	7-12
7.4.2	Step 1: Register the Endpoint in the Oracle Key Vault Management Console	7-13
7.4.3	Step 2: Prepare the Endpoint Environment	7-15
7.4.4	Step 3: Install the Oracle Key Vault Software onto the Endpoint for Registration and Enrollment	7-15
7.4.5	Step 4: Perform Post-Installation Tasks	7-17
7.5	Suspending Database Cloud Service Access to Oracle Key Vault	7-18
7.5.1	About Suspending Database Cloud Service Access to Oracle Key Vault	7-18
7.5.2	Suspending Access for a Database Cloud Service to Oracle Key Vault	7-19
7.6	Resuming Database Cloud Service Access to Oracle Key Vault	7-20
7.7	Resuming a Database Endpoint Configured with a Password-Based Keystore	7-21

8 Managing Oracle Key Vault Users

8.1	Managing User Accounts	8-1
8.1.1	About Oracle Key Vault User Accounts	8-1
8.1.2	How a Multi-Master Cluster Affects User Accounts	8-2
8.1.2.1	Multi-Master Cluster Effect on System Administrator Users	8-3
8.1.2.2	Multi-Master Cluster Effect on Key Administrator Users	8-3
8.1.2.3	Multi-Master Cluster Effect on Audit Manager Users	8-3
8.1.2.4	Multi-Master Cluster Effect on Administration Users	8-4
8.1.2.5	Multi-Master Cluster Effect on System Users	8-4
8.1.3	Creating an Oracle Key Vault User Account	8-5
8.1.4	Viewing User Account Details	8-7
8.1.5	Deleting an Oracle Key Vault User Account	8-7
8.2	Managing Administrative Roles and User Privileges	8-7
8.2.1	About Managing Administrative Roles and User Privileges	8-8

8.2.2	Granting or Changing an Administrative Role of a User	8-8
8.2.3	Granting the Create Endpoint Privilege	8-10
8.2.4	Granting the Manage Endpoint Privilege	8-10
8.2.5	Granting the Create Endpoint Group Privilege	8-11
8.2.6	Granting the Manage Endpoint Group Privilege	8-11
8.2.7	Granting a User Access to a Virtual Wallet	8-12
8.2.8	Revoking an Administrative Role or Endpoint Privilege from a User	8-13
8.3	Managing User Passwords	8-14
8.3.1	About Changing User Passwords	8-14
8.3.2	Changing Your Own Password	8-15
8.3.3	Changing Another User's Password	8-15
8.3.3.1	Changing a Password Manually	8-16
8.3.3.2	Changing a Password Through Email Notification	8-16
8.3.3.3	Changing the Support User Account Password	8-17
8.3.4	Controlling the Use of Password Reset Methods	8-18
8.3.4.1	About Controlling the Use of Password Reset Methods	8-18
8.3.4.2	Configuring the Use of Password Reset Operations	8-19
8.4	Managing User Email	8-19
8.4.1	Changing the User Email Address	8-19
8.4.2	Disabling Email Notifications for a User	8-19
8.5	Managing User Groups	8-20
8.5.1	About Managing User Groups	8-20
8.5.2	How a Multi-Master Cluster Affects User Groups	8-21
8.5.3	Creating a User Group	8-21
8.5.4	Adding a User to a User Group	8-23
8.5.5	Granting a User Group Access to a Virtual Wallet	8-23
8.5.6	Renaming a User Group	8-24
8.5.7	Changing a User Group Description	8-24
8.5.8	Removing a User from a User Group	8-24
8.5.9	Deleting a User Group	8-25

9 Managing LDAP User Authentication and Authorization in Oracle Key Vault

9.1	About Managing LDAP User Authentication and Authorization in Oracle Key Vault	9-1
9.2	Privilege Grants and Revokes for LDAP Users	9-3
9.3	Configuring the LDAP Directory Server Connection to Oracle Key Vault	9-4
9.3.1	Step 1: Prepare the LDAP Directory Server	9-4
9.3.2	Step 2: Create the LDAP Connection in Oracle Key Vault	9-4
9.3.3	Step 3: Map LDAP Groups to Oracle Key Vault User Groups	9-6
9.4	Logins to Oracle Key Vault as an LDAP User	9-7

9.4.1	About Logins to Oracle Key Vault as an LDAP User	9-7
9.4.2	Logging in to Oracle Key Vault as an LDAP User	9-7
9.5	Managing the LDAP Configuration	9-8
9.5.1	Enabling an LDAP Configuration	9-8
9.5.2	Modifying an LDAP Configuration	9-9
9.5.3	Testing an LDAP Configuration	9-10
9.5.4	Disabling an LDAP Configuration	9-10
9.5.5	Deleting an LDAP Configuration	9-10
9.6	Managing LDAP Groups	9-11
9.6.1	About Managing LDAP Groups	9-11
9.6.2	Creating an LDAP Group Mapping	9-12
9.6.3	Modifying an LDAP Group Mapping	9-13
9.6.4	Validating LDAP Group Mappings	9-14
9.6.5	Deleting LDAP Group Mappings	9-14
9.7	Managing Oracle Key Vault-Generated LDAP Users	9-14
9.7.1	About Managing LDAP Users	9-15
9.7.2	Finding Information About an Oracle Key Vault-Generated LDAP User	9-15
9.7.3	Validation of Oracle Key Vault-Generated LDAP Users	9-16
9.7.3.1	About the Validation of Oracle Key Vault-Generated LDAP Users	9-16
9.7.3.2	Validating Oracle Key Vault-Generated LDAP Users	9-16
9.7.4	Modifying an Oracle Key Vault-Generated LDAP User Account Wallet Privileges	9-17
9.7.4.1	About Modifying an Oracle Key Vault-Generated LDAP User Account Wallet Privileges	9-17
9.7.4.2	Modifying an Oracle Key Vault-Generated LDAP User Account Wallet Privileges (Key Administrators)	9-17
9.7.4.3	Modifying an Oracle Key Vault-Generated LDAP User Account Wallet Privileges (Regular Users)	9-18
9.7.5	Deleting Oracle Key Vault-Generated LDAP Users	9-18

10 Managing Oracle Key Vault Virtual Wallets and Security Objects

10.1	Managing Virtual Wallets	10-1
10.1.1	About Virtual Wallets	10-2
10.1.2	Creating a Virtual Wallet	10-2
10.1.3	Modifying a Virtual Wallet	10-4
10.1.4	Adding Security Objects to a Virtual Wallet	10-5
10.1.5	Removing Security Objects from a Virtual Wallet	10-6
10.1.6	Deleting a Virtual Wallet	10-6
10.2	Managing Access to Virtual Wallets from Keys & Wallets Tab	10-7
10.2.1	About Managing Access to Virtual Wallets from the Keys & Wallets Tab	10-7
10.2.2	Granting Access to Users, User Groups, Endpoints, and Endpoint Groups	10-8

10.2.3	Modifying Access to Users, User Groups, Endpoints, and Endpoint Groups	10-9
10.3	Managing Access to Virtual Wallets from User's Menu	10-9
10.3.1	Granting a User Access to a Virtual Wallet	10-10
10.3.2	Revoking User Access from a Virtual Wallet	10-10
10.3.3	Granting a User Group Access to a Virtual Wallet	10-11
10.3.4	Revoking User Group Access from a Virtual Wallet	10-11
10.4	Managing the State of a Key or a Security Object	10-11
10.4.1	About Managing the State of a Key or a Security Object	10-12
10.4.2	How a Multi-Master Cluster Affects Keys and Security Objects	10-12
10.4.3	Activating a Key or Security Object	10-13
10.4.4	Deactivating a Key or Security Object	10-13
10.4.5	Revoking a Key or Security Object	10-13
10.4.6	Destroying a Key or Security Object	10-14
10.5	Managing Details of Security Objects	10-14
10.5.1	About Managing the Details of Security Objects	10-14
10.5.2	Searching for Security Object Items	10-15
10.5.3	Viewing the Details of a Security Object	10-16
10.5.4	Adding or Modifying Details of a Security Object	10-19

11 Managing Oracle Key Vault Master Encryption Keys

11.1	Using the Persistent Master Encryption Key Cache	11-1
11.1.1	About the Persistent Master Encryption Key Cache	11-2
11.1.2	About Oracle Key Vault Persistent Master Encryption Key Cache Architecture	11-2
11.1.3	Caching Master Encryption Keys in the In-Memory and Persistent Master Encryption Key Cache	11-3
11.1.4	Storage Location of Persistent Master Encryption Key Cache	11-3
11.1.5	Persistent Master Encryption Key Cache Modes of Operation	11-4
11.1.5.1	Oracle Key Vault First Mode	11-4
11.1.5.2	Persistent Master Encryption Key Cache First Mode	11-4
11.1.6	Persistent Master Encryption Key Cache Refresh Window	11-5
11.1.7	Persistent Master Encryption Key Cache Parameters	11-5
11.1.7.1	PKCS11_CACHE_TIMEOUT Parameter	11-6
11.1.7.2	PKCS11_PERSISTENT_CACHE_TIMEOUT Parameter	11-6
11.1.7.3	PKCS11_PERSISTENT_CACHE_FIRST Parameter	11-7
11.1.7.4	PKCS11_CONFIG_PARAM_REFRESH_INTERVAL Parameter	11-7
11.1.7.5	PKCS11_PERSISTENT_CACHE_REFRESH_WINDOW Parameter	11-8
11.1.7.6	EXPIRE PKCS11 PERSISTENT CACHE ON DATABASE SHUTDOWN Parameter	11-8
11.1.8	Listing the Contents of the Persistent Master Key Cache	11-9
11.1.9	Oracle Database Deployments and Persistent Master Encryption Key Cache	11-11
11.2	Configuring an Oracle Key Vault to New TDE-Enabled Database Connection	11-11

11.2.1	About Configuring an Oracle Key Vault to New TDE-Enabled Database Connection	11-12
11.2.2	Limitations to Transparent Data Encryption Endpoint Integration	11-12
11.2.3	Step 1: Configure the Oracle Key Vault Server Environment	11-13
11.2.4	Step 2: Integrate Transparent Data Encryption with Oracle Key Vault	11-15
11.3	Migrating Existing TDE Wallets to Oracle Key Vault	11-16
11.3.1	About Migrating Existing TDE Wallets to Oracle Key Vault	11-16
11.3.2	Migrating an Existing TDE Wallet to Oracle Key Vault	11-17
11.3.3	Restoring Database Contents Previously Encrypted by TDE Using an Oracle Wallet	11-19
11.4	Uploading and Downloading Oracle Wallets	11-19
11.4.1	About Uploading and Downloading Oracle Wallets	11-20
11.4.2	Uploading Oracle Wallets	11-20
11.4.3	Downloading Oracle Wallets	11-21
11.4.4	Guidelines for Uploading and Downloading Oracle Wallets	11-22
11.5	Uploading and Downloading JKS and JCEKS Keystores	11-23
11.5.1	About Uploading and Downloading JKS and JCEKS Keystores	11-23
11.5.2	Uploading JKS or JCEKS Keystores	11-23
11.5.3	Downloading JKS or JCEKS Keystores	11-24
11.5.4	Guidelines for Uploading and Downloading JKS and JCEKS Keystores	11-25
11.6	Using a User-Defined Key as the TDE Master Encryption Key	11-25
11.6.1	About Using a User-Defined Key as the TDE Master Encryption Key	11-26
11.6.2	Step 1: Upload the User-Defined Key	11-26
11.6.3	Step 2: Activate the User-Defined Key as a TDE Master Encryption Key	11-28

12 Managing Oracle Key Vault Endpoints

12.1	Overview of Managing Endpoints	12-1
12.1.1	About Managing Endpoints	12-1
12.1.2	How a Multi-Master Cluster Affects Endpoints	12-3
12.2	Managing Endpoints	12-3
12.2.1	Types of Endpoint Enrollment	12-3
12.2.2	Endpoint Enrollment in a Multi-Master Cluster	12-4
12.2.3	Adding an Endpoint as an Oracle Key Vault System Administrator or Create Endpoint User	12-5
12.2.4	Adding Endpoints Using Self-Enrollment	12-9
12.2.4.1	About Adding Endpoints Using Self-Enrollment	12-9
12.2.4.2	Adding an Endpoint Using Self-Enrollment	12-9
12.2.5	Deleting, Suspending, or Reenrolling Endpoints	12-10
12.2.5.1	About Deleting Endpoints	12-10
12.2.5.2	Deleting One or More Endpoints	12-11
12.2.5.3	Deleting One Endpoint (Alternative Method)	12-11

12.2.5.4	Suspending an Endpoint	12-12
12.2.5.5	Reenrolling an Endpoint	12-13
12.3	Managing Endpoint Details	12-13
12.3.1	About Endpoint Details	12-14
12.3.2	Modifying Endpoint Details	12-14
12.3.3	Global Endpoint Configuration Parameters	12-15
12.3.3.1	About Global Endpoint Configuration Parameters	12-15
12.3.3.2	Setting Global Endpoint Configuration Parameters	12-16
12.3.4	Modifying Configuration Parameters for an Individual Endpoint	12-18
12.4	Default Wallets and Endpoints	12-18
12.4.1	Associating a Default Wallet with an Endpoint	12-18
12.4.2	Setting the Default Wallet for an Endpoint	12-19
12.5	Managing Endpoint Access to a Virtual Wallet	12-20
12.5.1	Granting an Endpoint Access to a Virtual Wallet	12-21
12.5.2	Revoking Endpoint Access to a Virtual Wallet	12-22
12.5.3	Viewing Wallet Items Accessed by Endpoints	12-23
12.6	Managing Endpoint Groups	12-23
12.6.1	How a Multi-Master Cluster Affects Endpoint Groups	12-24
12.6.2	Creating an Endpoint Group	12-24
12.6.3	Modifying Endpoint Group Details	12-26
12.6.4	Granting an Endpoint Group Access to a Virtual Wallet	12-27
12.6.5	Adding an Endpoint to an Endpoint Group	12-28
12.6.6	Removing an Endpoint from an Endpoint Group	12-29
12.6.7	Deleting Endpoint Groups	12-30

13 Enrolling and Upgrading Endpoints for Oracle Key Vault

13.1	About Endpoint Enrollment and Provisioning	13-1
13.2	Finalizing Enrollment and Provisioning	13-3
13.2.1	Step 1: Enroll the Endpoint and Download the Software	13-3
13.2.2	Step 2: Prepare the Endpoint Environment	13-5
13.2.3	Step 3: Install the Oracle Key Vault Software onto the Endpoint	13-5
13.2.4	Step 4: Perform Post-Installation Tasks	13-7
13.3	Environment Variables and Endpoint Provisioning Guidance	13-8
13.3.1	How the Location of JAVA_HOME Location Is Determined	13-8
13.3.2	Location of the okvclient.ora File and Environment Variables	13-9
13.3.3	Setting OKV_HOME for Non-Database Utilities to Communicate with Oracle Key Vault	13-9
13.3.4	Environment Variables in sqlnet.ora File	13-10
13.4	Endpoints That Do Not Use the Oracle Key Vault Client Software	13-10
13.5	Transparent Data Encryption Endpoint Management	13-10
13.6	Endpoint okvclient.ora Configuration File	13-11

13.7	Upgrading Endpoints	13-12
13.7.1	Upgrading Endpoint Software from an Endpoint	13-12
13.7.1.1	Step 1: Prepare the Endpoint Environment	13-13
13.7.1.2	Step 2: Download the Oracle Key Vault Software onto the Endpoint	13-13
13.7.1.3	Step 3: Install the Oracle Key Vault Software onto the Endpoint	13-14
13.7.1.4	Step 4: Perform Post-Installation Tasks	13-15
13.7.2	Upgrading Endpoint Software on an Enrolled Endpoint	13-17

14 Managing Keys for Oracle Products

14.1	Using a TDE-Configured Oracle Database in an Oracle RAC Environment	14-1
14.2	Using a TDE-Configured Oracle Database in an Oracle GoldenGate Environment	14-2
14.2.1	Oracle Wallets in an Oracle GoldenGate Environment	14-2
14.2.2	Configuring Online Master Keys in an Oracle GoldenGate Deployment	14-3
14.2.3	Migration of TDE Wallets in Oracle GoldenGate to Oracle Key Vault	14-3
14.3	Using a TDE-Configured Oracle Database in an Oracle Data Guard Environment	14-4
14.3.1	About Uploading Oracle Wallets in an Oracle Data Guard Environment	14-5
14.3.2	Uploading Oracle Wallets in an Oracle Data Guard Environment	14-5
14.3.3	Performing an Online Master Key Connection in an Oracle Data Guard Environment	14-6
14.3.4	Migrating Oracle Wallets in an Oracle Data Guard Environment	14-6
14.3.5	Reverse Migrating Oracle Wallets in an Oracle Data Guard Environment	14-7
14.3.6	Migrating an Oracle TDE Wallet to Oracle Key Vault for a Logical Standby Database	14-8
14.3.7	Checking the Oracle TDE Wallet Migration for a Logical Standby Database	14-8
14.4	Uploading Keystores from Automatic Storage Management to Oracle Key Vault	14-9
14.4.1	About Uploading Keystores from Automatic Storage Management to Oracle Key Vault	14-9
14.4.2	Uploading a Keystore from Automatic Storage Management to Oracle Key Vault	14-9
14.4.3	Copying a Keystore from Oracle Key Vault to Automatic Storage Management	14-11
14.5	MySQL Integration with Oracle Key Vault	14-11
14.6	Other Oracle Database Features That Oracle Key Vault Supports	14-12

15 Managing Online and Offline Secrets

15.1	Uploading and Downloading Credential Files	15-1
15.1.1	About Uploading and Downloading Credential Files	15-1
15.1.2	Uploading a Credential File	15-2
15.1.3	Downloading a Credential File	15-3
15.1.4	Guidelines for Uploading and Downloading Credential Files	15-3
15.2	Managing Secrets and Credentials for SQL*Plus	15-4

15.3	Managing Secrets and Credentials for SSH	15-5
15.4	Centrally Managing Passwords in Oracle Key Vault	15-5
15.4.1	About Centrally Managing Passwords in Oracle Key Vault	15-6
15.4.2	Creating and Sharing Centrally Managed Passwords	15-6
15.4.3	Example: Script for Using External Keystore Passwords in SQL*Plus Operations	15-9
15.4.4	Sharing Secrets with Other Databases	15-10
15.4.5	Changing Passwords for a Large Database Deployment	15-12

16 Oracle Key Vault General System Administration

16.1	Overview of Oracle Key Vault General System Administration	16-1
16.1.1	About Oracle Key Vault General System Administration	16-2
16.1.2	Viewing the Oracle Key Vault Dashboard	16-2
16.1.3	Using the Status Panes in the Dashboard	16-3
16.2	Configuring Oracle Key Vault in a Non-Multi-Master Cluster Environment	16-4
16.2.1	Configuring the Network Details	16-5
16.2.2	Configuring Network Access	16-6
16.2.3	Configuring DNS	16-7
16.2.4	Configuring the System Time	16-7
16.2.5	Configuring FIPS Mode	16-9
16.2.6	Configuring Syslog	16-10
16.2.7	Changing the Network Interface Mode	16-10
16.2.8	Configuring RESTful Services	16-12
16.2.9	Checking the Oracle Audit Vault Integration Status	16-13
16.2.10	Configuring the Oracle Key Vault Management Console Web Session Timeout	16-13
16.2.11	Restarting or Powering Off Oracle Key Vault	16-14
16.3	Configuring Oracle Key Vault in a Multi-Master Cluster Environment	16-14
16.3.1	About Configuring Oracle Key Vault in a Multi-Master Cluster Environment	16-14
16.3.2	Configuring System Settings for Individual Multi-Master Cluster Nodes	16-15
16.3.2.1	Configuring the Network Details for the Node	16-16
16.3.2.2	Configuring Network Access for the Node	16-16
16.3.2.3	Configuring DNS for the Node	16-17
16.3.2.4	Configuring the System Time for the Node	16-17
16.3.2.5	Configuring the FIPS Mode for the Node	16-18
16.3.2.6	Configuring Syslog for the Node	16-19
16.3.2.7	Changing the Network Interface Mode for the Node	16-19
16.3.2.8	Configuring Auditing for the Node	16-21
16.3.2.9	Configuring SNMP Settings for the Node	16-22
16.3.2.10	Checking the Oracle Audit Vault Integration for the Node	16-22
16.3.2.11	Restarting or Powering Off Oracle Key Vault from a Node	16-23

16.3.3	Managing Oracle Key Vault Multi-Master Clusters	16-23
16.3.3.1	Configuring the System Time for the Cluster	16-24
16.3.3.2	Configuring DNS for the Cluster	16-24
16.3.3.3	Configuring the Maximum Disable Node Duration for the Cluster	16-25
16.3.3.4	Configuring Syslog for the Cluster	16-25
16.3.3.5	Configuring RESTful Services for the Cluster	16-26
16.3.3.6	Configuring Auditing for the Cluster	16-26
16.3.3.7	Configuring SNMP Settings for the Cluster	16-26
16.3.3.8	Configuring the Oracle Key Vault Management Console Web Session Timeout for the Cluster	16-27
16.4	Managing System Recovery	16-27
16.4.1	About Managing System Recovery	16-28
16.4.2	Recovering Credentials for Administrators	16-28
16.4.3	Changing the Recovery Passphrase in a Non-Multi-Master Cluster Environment	16-28
16.4.4	Changing the Recovery Passphrase in a Multi-Master Cluster	16-29
16.4.4.1	Step 1: Initiate the Recovery Passphrase Change Across the Nodes	16-29
16.4.4.2	Step 2: Change the Recovery Passphrase	16-30
16.5	Support for a Primary-Standby Environment	16-31
16.6	Commercial National Security Algorithm Suite Support	16-31
16.6.1	About Commercial National Security Algorithm Suite Support	16-32
16.6.2	Running the Commercial National Security Algorithm Scripts	16-33
16.6.3	Performing Backup Restore Operations with CNSA	16-34
16.6.4	Upgrading a Standalone Oracle Key Vault Server with CNSA	16-34
16.6.5	Upgrading Primary-Standby Oracle Key Vault Servers to Use CNSA	16-36
16.7	Minimizing Downtime	16-37

17 Managing Certificates

17.1	Rotating Certificates	17-1
17.1.1	About Rotating Certificates	17-1
17.1.2	Advice for Managing Certificate Rotations	17-2
17.1.3	Factors That May Affect the Certificate Rotation Process	17-3
17.1.4	Rotating All Certificates	17-4
17.1.5	Checking the Overall Certificate Rotation Status	17-6
17.1.6	Checking the Certificate Rotation Status for Endpoints	17-6
17.1.7	Post-Certificate Rotation Tasks	17-7
17.2	Managing Console Certificates	17-7
17.2.1	About Managing Console Certificates	17-8
17.2.2	Step 1: Download the Certificate Request	17-8
17.2.3	Step 2: Have the Certificate Signed	17-9
17.2.4	Step 3: Upload the Signed Certificate to Oracle Key Vault	17-10

18 Backup and Restore Operations

18.1	About Backing Up and Restoring Data in Oracle Key Vault	18-1
18.2	Oracle Key Vault Backup Destinations	18-2
18.2.1	About the Oracle Key Vault Backup Destination	18-2
18.2.2	Creating a Remote Backup Destination	18-3
18.2.3	Changing Settings on a Remote Backup Destination	18-5
18.2.4	Deleting a Remote Backup Destination	18-6
18.3	Scheduled Backups and States	18-6
18.3.1	About Schedule Backup Types and States	18-7
18.3.2	Types of Oracle Key Vault Backups	18-7
18.3.3	Scheduled Backup States in Oracle Key Vault	18-8
18.4	Scheduling and Managing Oracle Key Vault Backups	18-8
18.4.1	Scheduling a Backup for Oracle Key Vault	18-9
18.4.2	Changing a Backup Schedule for Oracle Key Vault	18-10
18.4.3	Deleting a Backup Schedule from Oracle Key Vault	18-10
18.4.4	How Primary-Standby Affects Oracle Key Vault Backups	18-10
18.4.5	How Using a Cluster Affects Oracle Key Vault Backups	18-11
18.4.6	Protecting the Backup Using the Recovery Passphrase	18-11
18.5	Restoring Oracle Key Vault Data	18-11
18.5.1	About the Oracle Key Vault Restore Process	18-12
18.5.2	Procedure for Restoring Oracle Key Vault Data	18-12
18.5.3	Multi-Master Cluster and the Restore Operation	18-13
18.5.4	Primary-Standby and the Restore Operation	18-14
18.5.5	Certificates and the Restore Operation	18-14
18.5.6	Changes Resulting from a System State Restore	18-14
18.6	Backup and Restore Best Practices	18-15

19 Monitoring and Auditing Oracle Key Vault

19.1	Managing System Monitoring	19-1
19.1.1	Configuring Remote Monitoring to Use SNMP	19-1
19.1.1.1	About Using SNMP for Oracle Key Vault	19-2
19.1.1.2	Granting SNMP Access to Users	19-3
19.1.1.3	Changing the SNMP User Name and Password	19-4
19.1.1.4	Changing SNMP Settings on the Standby Server	19-4
19.1.1.5	Remotely Monitoring Oracle Key Vault Using SNMP	19-5
19.1.1.6	SNMP Management Information Base Variables for Oracle Key Vault	19-6
19.1.1.7	Example: Simplified Remote Monitoring of Oracle Key Vault Using SNMP	19-7

19.1.2	Configuring Email Notification	19-9
19.1.2.1	About Email Notification	19-10
19.1.2.2	Configuring Email Settings	19-10
19.1.2.3	Testing the Email Configuration	19-12
19.1.2.4	Disabling Email Notifications for a User	19-13
19.1.3	Configuring the Syslog Destination for Individual Multi-Master Cluster Nodes	19-13
19.1.3.1	Setting the Syslog Destination Setting for the Node	19-13
19.1.3.2	Clearing the Syslog Destination Setting for the Node	19-14
19.1.4	Capturing System Diagnostics	19-14
19.1.4.1	About Capturing System Diagnostics	19-14
19.1.4.2	Installing the Diagnostics Generation Utility	19-15
19.1.4.3	Generating a System Diagnostics File	19-16
19.1.4.4	Removing the Diagnostic Generation Utility Temporary Files	19-16
19.1.4.5	Removing the Diagnostic Generation Utility	19-16
19.2	Configuring Oracle Key Vault Alerts	19-17
19.2.1	About Configuring Alerts	19-17
19.2.2	Configuring Alerts	19-24
19.2.3	Viewing Open Alerts	19-26
19.3	Managing System Auditing	19-28
19.3.1	About Auditing in Oracle Key Vault	19-29
19.3.2	Oracle Key Vault Audit Trail	19-29
19.3.3	Enabling Auditing and Configuring Syslog to Store Audit Records	19-30
19.3.4	Viewing Audit Records	19-31
19.3.5	Exporting and Deleting Audit Records	19-31
19.3.6	Configuring Oracle Key Vault with Oracle Audit Vault	19-32
19.3.6.1	Integrating Oracle Audit Vault with Oracle Key Vault	19-32
19.3.6.2	Viewing Oracle Key Vault Audit Data Collected by Oracle Audit Vault	19-34
19.3.6.3	Suspending an Oracle Audit Vault Monitoring Operation	19-35
19.3.6.4	Resuming an Oracle Audit Vault Monitoring Operation	19-35
19.3.6.5	Deleting an Oracle Audit Vault Integration	19-35
19.3.6.6	Guidance for Integrating Oracle Audit Vault in a Multi-Master Cluster or Primary-Standby Environment	19-36
19.4	Using Oracle Key Vault Reports	19-37
19.4.1	About Oracle Key Vault Reports	19-37
19.4.2	Viewing Key Management Reports for Oracle Endpoints	19-38
19.4.3	Viewing Keys and Wallets Reports	19-39
19.4.4	Viewing Secrets Management Reports	19-39
19.4.5	Viewing Endpoint Reports	19-40
19.4.6	Viewing User Reports	19-41
19.4.7	Viewing System Reports	19-42

A Oracle Key Vault Multi-Master Cluster Operations

B Oracle Key Vault okvutil Endpoint Utility Reference

B.1	About the okvutil Utility	B-1
B.2	okvutil Command Syntax	B-1
B.3	okvutil changepwd Command	B-3
B.4	okvutil diagnostics Command	B-3
B.5	okvutil download Command	B-4
B.6	okvutil list Command	B-6
B.7	okvutil upload Command	B-8

C Troubleshooting Oracle Key Vault

C.1	Finding Log File Errors	C-2
C.2	Directory Permissions for Oracle Key Vault Migration	C-2
C.3	Error: Cannot Open Keystore Message	C-2
C.4	KMIP Error: Invalid Field	C-3
C.5	WARNING: Could Not Store Private Key Errors	C-3
C.6	Errors After Upgrading Oracle Key Vault	C-3
C.7	Error: Failed to Open Wallet	C-4
C.8	Transaction Check Error: Diagnostics Generation Utility	C-4
C.9	Fast-Start Failover (FSFO) Suspended (ORA-16818)	C-5
C.10	SSH Tunnel Add Failure	C-5
C.11	Error: Provision Command Fails if /usr/bin/java Does Not Exist	C-5
C.12	TDE Endpoint Integration Issues	C-6
C.13	Failover Situations in Primary-Standby Mode	C-6
C.13.1	About Failover Situations in Primary-Standby Mode	C-6
C.13.2	Failover Situations Without Read-Only Restricted Mode	C-7
C.13.2.1	Primary Server: Planned Shutdown During an Upgrade	C-7
C.13.2.2	Primary Server: Planned Shutdown During Maintenance	C-7
C.13.2.3	Standby Server: Planned Shutdown	C-8
C.13.2.4	Primary Server: Unplanned Shutdown	C-8
C.13.2.5	Standby Server: Unplanned Shutdown	C-9
C.13.3	Failover Situations with Read-Only Restricted Mode	C-9
C.13.3.1	Primary Server: Planned Shutdown During an Upgrade	C-10
C.13.3.2	Primary Server: Planned Shutdown During Maintenance	C-10
C.13.3.3	Standby Server: Planned Shutdown	C-10
C.13.3.4	Primary Server: Unplanned Shutdown	C-11
C.13.3.5	Standby Server: Unplanned Shutdown	C-11
C.14	Performing a Planned Shutdown	C-12

C.14.1	Primary Server Planned Shutdown	C-12
C.14.1.1	Performing a Primary Server Planned Shutdown During an Upgrade	C-12
C.14.1.2	Performing a Primary Server Planned Shutdown During Maintenance	C-12
C.14.2	Standby Server Planned Shutdown	C-13
C.14.2.1	Performing a Standby Server Planned Shutdown During an Upgrade	C-13
C.14.2.2	Performing a Standby Server Planned Shutdown During Maintenance	C-13

D Security Technical Implementation Guides Compliance Standards

D.1	About Security Technical Implementation Guides	D-1
D.2	Enabling and Disabling STIG Rules on Oracle Key Vault	D-2
D.2.1	Enabling STIG Rules on Oracle Key Vault	D-2
D.2.2	Disabling STIG Rules on Oracle Key Vault	D-2
D.3	Current Implementation of STIG Rules on Oracle Key Vault	D-2
D.4	Current Implementation of Database STIG Rules	D-3
D.5	Current Implementation of Operating System STIG Rules	D-6

Glossary

Index

Preface

Welcome to *Oracle Key Vault Administrator's Guide*. This guide explains how to install, configure, and use Oracle Key Vault.

- [Audience](#)
- [Documentation Accessibility](#)
- [Diversity and Inclusion](#)
- [Related Documents](#)
- [Conventions](#)

Audience

Oracle Key Vault Administrator's Guide is written for Oracle security administrators who are responsible for managing and centralizing encryption keys and other security objects.

Documentation Accessibility

For information about Oracle's commitment to accessibility, visit the Oracle Accessibility Program website at <http://www.oracle.com/pls/topic/lookup?ctx=acc&id=docacc>.

Access to Oracle Support

Oracle customers that have purchased support have access to electronic support through My Oracle Support. For information, visit <http://www.oracle.com/pls/topic/lookup?ctx=acc&id=info> or visit <http://www.oracle.com/pls/topic/lookup?ctx=acc&id=trs> if you are hearing impaired.

Diversity and Inclusion

Oracle is fully committed to diversity and inclusion. Oracle respects and values having a diverse workforce that increases thought leadership and innovation. As part of our initiative to build a more inclusive culture that positively impacts our employees, customers, and partners, we are working to remove insensitive terms from our products and documentation. We are also mindful of the necessity to maintain compatibility with our customers' existing technologies and the need to ensure continuity of service as Oracle's offerings and industry standards evolve. Because of these technical constraints, our effort to remove insensitive terms is ongoing and will take time and external cooperation.

Related Documents

For more information, see these Oracle resources:

- *Oracle Key Vault Root of Trust HSM Configuration Guide*

- *Oracle Key Vault RESTful Services Administrator's Guide*
- *Oracle Key Vault Developer's Guide*
- *Oracle Key Vault Licensing Information*
- *Oracle Key Vault Release Notes*
- [Key Management Interoperability Protocol Specification Version 1.1](#)

To download the product data sheet, frequently asked questions, links to the latest product documentation, product download, and other collateral, visit the Oracle Technology Network (OTN). You must register online before using OTN. Registration is free and can be done at

<https://www.oracle.com/database/technologies/security/key-vault.html>

Conventions

The following text conventions are used in this document:

Convention	Meaning
boldface	Boldface type indicates graphical user interface elements associated with an action, or terms defined in text or the glossary.
<i>italic</i>	Italic type indicates book titles, emphasis, or placeholder variables for which you supply particular values.
monospace	Monospace type indicates commands within a paragraph, URLs, code in examples, text that appears on the screen, or text that you enter.

Changes in This Release for Oracle Key Vault

This Oracle Key Vault release introduces new features that enhance the use of Oracle Key Vault in a large enterprise. Oracle Key Vault release 18.8 introduces the following new features.



Note:

This is the terminal release of Oracle Key Vault release 18.

- [Changes for Oracle Key Vault Release 21.3](#)
Oracle Key Vault release 21.3 introduces new features that affect this guide.
- [Changes for Oracle Key Vault Release 21.2](#)
Oracle Key Vault release 21.2 introduces new features that are related to installation and upgrade operations.

Changes for Oracle Key Vault Release 21.3

Oracle Key Vault release 21.3 introduces new features that affect this guide.

- [Enhancements for the Oracle Audit Vault Integration with Oracle Key Vault](#)
Starting in Oracle Key Vault release 21.3, the integration of the Oracle Audit Vault component of Oracle Audit Vault with Oracle Key Vault has been made more secure and easier to accomplish.
- [Alert for Fast Recovery Area Space Utilization](#)
Starting in Oracle Key Vault release 21.3, an alert will be generated when the Fast Recovery Area Space utilization of the Oracle Key Vault's embedded database exceeds the configured threshold value.
- [Cluster Redo Shipping Status Alert Message Change](#)
Starting in Oracle Key Vault release 21.3, the Cluster Redo Shipping Status alert notification message has changed.

Enhancements for the Oracle Audit Vault Integration with Oracle Key Vault

Starting in Oracle Key Vault release 21.3, the integration of the Oracle Audit Vault component of Oracle Audit Vault with Oracle Key Vault has been made more secure and easier to accomplish.

This enhancement includes the following changes in functionality:

- **Change in System Administrator and Audit Manager roles:** Users who have the System Administrator role no longer can perform the Oracle Audit Vault integration. Instead, for better separation of duty, only a user who has been granted the Audit Manager role can perform the integration. In previous releases, only users with the

System Administrator role could perform the integration. However, users who have the System Administrator role can check if the Audit Vault monitoring process is active.

- **Easier integration process:** A user with the Audit Manager role now can use the Oracle Key Vault management console to perform all the Oracle Audit Vault integration steps. In previous releases, an Oracle Key Vault administrator had to manually perform steps such as downloading and installing the Audit Vault agent to perform this integration.

Related Topics

- [Configuring Oracle Key Vault with Oracle Audit Vault](#)
A user who has the Audit Manager role can configure Oracle Key Vault to send audit records to Oracle Audit Vault for centralized audit reporting and alerting.

Alert for Fast Recovery Area Space Utilization

Starting in Oracle Key Vault release 21.3, an alert will be generated when the Fast Recovery Area Space utilization of the Oracle Key Vault's embedded database exceeds the configured threshold value.

By default, the configured threshold value is 70 and the alert is available for standalone, multi-master cluster, and primary-standby environments. The new alert enables you to better monitor the Fast Recovery Area space usage of the Oracle Key Vault's embedded database.

Related Topics

- [About Configuring Alerts](#)
System administrators can configure alerts from the Oracle Key Vault dashboard, but all users can see alerts for the security objects to which they have access.

Cluster Redo Shipping Status Alert Message Change

Starting in Oracle Key Vault release 21.3, the `Cluster Redo Shipping Status` alert notification message has changed.

In previous releases, users were alerted only when the redo-shipping status was active (up) or inactive (down). The message now, in addition to this information, indicates whether the node in the cluster is operating in read-only mode or is no longer in read-only mode.

Related Topics

- [About Configuring Alerts](#)
System administrators can configure alerts from the Oracle Key Vault dashboard, but all users can see alerts for the security objects to which they have access.

Changes for Oracle Key Vault Release 21.2

Oracle Key Vault release 21.2 introduces new features that are related to installation and upgrade operations.

- [Certificate and Secret Objects Expiration Alerts](#)
In Oracle Key Vault release 21.2, you can configure alert notifications for the expiration of certificate and secret objects.

- [New and Changed RESTful Services Utility Commands](#)
In Oracle Key Vault release 21.2, several new and changed `okv managed-object` RESTful services utility commands are available.
- [Changes in the Oracle Key Vault Management Console](#)
In Oracle Key Vault release 21.2, the Oracle Key Vault management console user interface has had minor changes throughout.

Certificate and Secret Objects Expiration Alerts

In Oracle Key Vault release 21.2, you can configure alert notifications for the expiration of certificate and secret objects.

In previous releases, expiration alerts for all managed objects shared a common configuration under the `Key Rotations` alert. Starting with this release, you can separately configure the expiration alerts for certificate and secret objects. The expiration alerts for the certificate and secret objects are no longer reported as `Key Rotations` alerts. Similar to alerts such as those for cluster components or user password expiration, you can set this type of alert to notify users when the deactivation date for a certificate or secret object is within its threshold value.

The new alerts for certificate and secret objects are as follows:

- `Certificate Object Expiration`
- `Secret Object Expiration`

The object expiration alerts are now raised only when the object is in the `PRE-ACTIVE` or `ACTIVE` state. Previously, they were raised regardless of the object state.

The object expiration alerts are now deleted when an object is revoked or destroyed. Previously, they were deleted when object was destroyed.

Related Topics

- [About Configuring Alerts](#)
System administrators can configure alerts from the Oracle Key Vault dashboard, but all users can see alerts for the security objects to which they have access.
- *Oracle Key Vault Installation and Upgrade Guide*

New and Changed RESTful Services Utility Commands

In Oracle Key Vault release 21.2, several new and changed `okv managed-object` RESTful services utility commands are available.

The new `okv managed-object` RESTful services commands, which add support for `get` and `register` operations for certificate requests, private keys, and public keys, are as follows:

- `okv managed-object certificate-request get`
- `okv managed-object certificate-request register`
- `okv managed-object private-key get`
- `okv managed-object private-key register`
- `okv managed-object public-key get`
- `okv managed-object public-key register`

The changed `okv managed-object RESTful services` commands are as follows:

- `okv managed-object certificate register`
- `okv managed-object object locate`

Related Topics

- *Oracle Key Vault RESTful Services Administrator's Guide*

Changes in the Oracle Key Vault Management Console

In Oracle Key Vault release 21.2, the Oracle Key Vault management console user interface has had minor changes throughout.

These changes are the result of modified terms, updates to the current release, and enhancements for better usability. The overall interface has not had major changes.

1

Introduction to Oracle Key Vault

Oracle Key Vault is a full-stack, security-hardened software appliance built to centralize the management of keys and security objects within the enterprise.

- [About Key and Secrets Management in Oracle Key Vault](#)
Oracle Key Vault is a fault-tolerant, highly available and scalable, secure and standards-compliant key and secrets management appliance, where you can store, manage, and share your security objects.
- [Benefits of Using Oracle Key Vault](#)
Oracle Key Vault helps you to fight security threats, centralize key storage, and centralize key lifecycle management.
- [Oracle Key Vault Use Cases](#)
The most typical use cases for Oracle Key Vault are centralized storage and management of security objects.
- [Who Should Use Oracle Key Vault](#)
Oracle Key Vault is designed for users who are responsible for deploying, maintaining, and managing security within the enterprise.
- [Major Features of Oracle Key Vault](#)
Oracle Key Vault enhances security in key management with a wide range of features that support different database deployments.
- [Oracle Key Vault Interfaces](#)
Oracle Key Vault provides both a graphical user interface and command-line interfaces.
- [Overview of an Oracle Key Vault Deployment](#)
There are three different Oracle Key Vault deployment options.

1.1 About Key and Secrets Management in Oracle Key Vault

Oracle Key Vault is a fault-tolerant, highly available and scalable, secure and standards-compliant key and secrets management appliance, where you can store, manage, and share your security objects.

A security object contains critical data that is provided by a user. Security objects that you can manage with Oracle Key Vault include encryption keys, Oracle wallets, Java keystores (JKS), Java Cryptography Extension keystores (JCEKS), and credential files. Credential files can include SSH private keys (used for public key authentication to remote servers (for example OCI compute instances)) or database account passwords for unattended execution of regularly scheduled maintenance scripts.

To increase key and secret availability, you can install Oracle Key Vault as a multi-master cluster with up to 16 (geographically distributed) nodes.

Oracle Key Vault centralizes key and secrets management across your organization quickly and efficiently. Built on Oracle Linux, Oracle Database, Oracle Database security features like Oracle Transparent Data Encryption, Oracle Database Vault, Oracle Virtual Private Database, and Oracle GoldenGate technology, Oracle Key Vault's centralized, highly available, and scalable security solution helps to overcome the biggest key-management challenges facing

organizations today. With Oracle Key Vault you can retain, back up, and restore your security objects, prevent their accidental loss, and manage their lifecycle in a protected environment.

Oracle Key Vault is optimized for the Oracle Stack (database, middleware, systems), and Advanced Security Transparent Data Encryption (TDE). In addition, it complies with the industry standard OASIS Key Management Interoperability Protocol (KMIP) for compatibility with KMIP-based clients.

Oracle Key Vault works with endpoints, which it treats as clients to store and manage security objects, share them with trusted peers, and retrieve them. An endpoint is a computer system such as a database server, an application server, and other information systems, where keys are used to access encrypted data and credentials are used to authenticate to other systems. You can use Oracle Key Vault to manage a variety of other endpoints, such as master encryption keys for Oracle Golden Gate encrypted trail files, MySQL TDE, encrypted ACFS file systems, ZDLRA, and many more KMIP-compliant endpoints. The Java and C software development kits make it easy to integrate other endpoints as well.

Related Topics

- [Support for OASIS Key Management Interoperability Protocol \(KMIP\)](#)
You can use Oracle Key Vault with a range of OASIS KMIP Version 1.1 profiles.

1.2 Benefits of Using Oracle Key Vault

Oracle Key Vault helps you to fight security threats, centralize key storage, and centralize key lifecycle management.

Deploying Oracle Key Vault in your organization will help you accomplish the following:

- Manage the lifecycle for endpoint security objects and keys, which includes key creation, rotation, deactivation, and removal.
- Prevent the loss of keys and wallets due to forgotten passwords or accidental deletion.
- Share keys securely between authorized endpoints across the organization.
- Enroll and provision endpoints easily using a single software package that contains all the necessary binaries, configuration files, and endpoint certificates for mutually authenticated connections (TLS 1.2) between endpoints and Oracle Key Vault.
- Work with other Oracle products and features in addition to Transparent Data Encryption (TDE), such as Oracle Real Application Clusters (Oracle RAC), Oracle Data Guard, pluggable databases, Oracle GoldenGate, MongoDB, and others. Oracle Key Vault facilitates the movement of encrypted data using Oracle Data Pump and transportable tablespaces, a key feature of Oracle Database.

Figure 1-1 Encrypted Data That Oracle Key Vault Can Protect

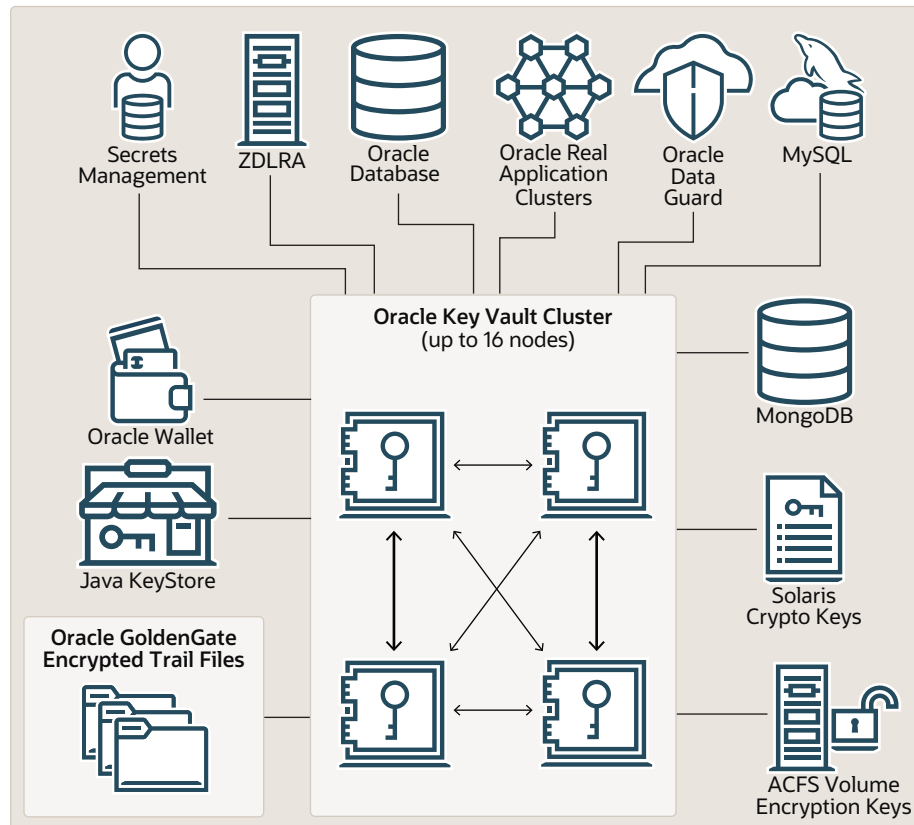

This figure illustrates how a multi-master cluster environment can be used to manage different kinds of encrypted data. It has the following components:

- **Oracle Database** refers to Oracle databases that are connected to the Oracle Key Vault. Typically, these databases are protected with Transparent Data Encryption (TDE).
- **Oracle wallets and Java keystores** are containers for keys and sensitive objects that you upload and download between Oracle Key Vault and endpoints.
- **Secrets Management** refers to other keystore files, which are security objects like certificates, and credential files like Kerberos keytab files, SSH key files, and server password files, that you upload to Oracle Key Vault from endpoints.
- **ZDLRA, MongoDB, MySQL, GoldenGate, Solaris Crypto Keys, and ACFS** are all sources of encrypted key data that can be protected by Oracle Key Vault.

You can deploy Oracle Key Vault in the following types of environments:

- Single Oracle Database instance
- Multiple Oracle databases on the same server
- Oracle Database using a multitenant environment
- Oracle GoldenGate
- Oracle Data Guard
- Oracle Exadata, engineered systems

- Oracle Exadata Cloud@Customer
- Oracle Autonomous Database (dedicated)

Other components of Oracle Key Vault can include the following:

- **Oracle Key Vault Management Console** refers to the Oracle Key Vault graphical user interface, where you can log in to manage your security objects and administer the Oracle Key Vault system.
- **Oracle Key Vault Backup** refers to a backup device, where security objects in Oracle Key Vault can be backed up on-demand or on-schedule.

An Oracle Key Vault multi-master cluster provides additional benefits, such as:

- Maximum key availability by providing multiple Oracle Key Vault nodes from which data may be retrieved
- Zero endpoint downtime during Oracle Key Vault multi-master cluster maintenance

1.3 Oracle Key Vault Use Cases

The most typical use cases for Oracle Key Vault are centralized storage and management of security objects.

- [Centralized Storage of Oracle Wallet Files and Java Keystores](#)
You can store security objects centrally in Oracle Key Vault, and manage them with automatic mechanisms for tracking, backup, and recovery.
- [Centralized Management of TDE Master Encryption Keys Using Online Master Keys](#)
You can use an online master key to centralize the management of TDE master encryption keys over a direct network connection.
- [Storage of Credential Files](#)
Oracle Key Vault can back up credential files other than Oracle wallets and Java keystores for long-term retention and recovery.
- [Online Management of Endpoint Keys and Secret Data](#)
You can use the RESTful key management interface to manage the storage and retrieval of keys.

1.3.1 Centralized Storage of Oracle Wallet Files and Java Keystores

You can store security objects centrally in Oracle Key Vault, and manage them with automatic mechanisms for tracking, backup, and recovery.

This will help you address many operational and security challenges posed by the manual tracking and management of security objects dispersed widely across multiple servers.

Oracle Key Vault stores copies of Oracle wallet files, Java keystores, and other security objects in a centralized location for long-term retention and recovery. These security objects can later be downloaded to a new wallet or keystore file and shared with trusted server peer endpoints.

The Oracle Key Vault endpoint software can read the format of Oracle wallet files and Java keystores to store their contents at the granularity of individual security objects. You can upload both password-protected and auto-login wallets, and then download

the wallet contents to a new wallet of either type. This enables users to manage security objects individually and add them to virtual wallets for sharing.

Oracle Key Vault can individually store and manage the security objects contained in:

- Oracle wallet files
Symmetric keys used for encryption (including TDE master encryption keys), passwords (Secure External Password Store), and X.509 certificates (network encryption).
Oracle Key Vault supports wallet files from all supported releases of the Oracle Database.
- Java keystores
Symmetric keys, asymmetric keys such as private keys, and X.509 certificates.
Oracle Key Vault supports both JKS and JCEKS types of Java keystores.

The following figure illustrates the centralized storage of Oracle wallet files and Java keystores.

Figure 1-2 Centralized Storage of Oracle Wallet Files and Java Keystores

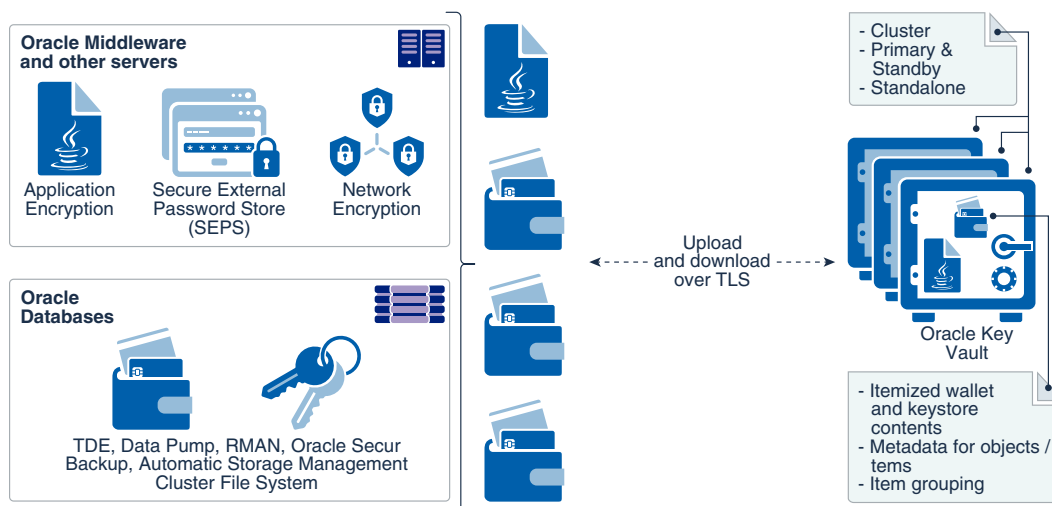

1.3.2 Centralized Management of TDE Master Encryption Keys Using Online Master Keys

You can use an online master key to centralize the management of TDE master encryption keys over a direct network connection.

This feature applies only to Oracle databases that use Transparent Data Encryption (TDE). The term [online master key](#) replaces the previous term TDE direct connection.

Online master keys enable you to centrally manage Transparent Data Encryption (TDE) master encryption keys over a network connection as an alternative to using local Oracle wallet files. The connection configuration entails using a PKCS#11 library to connect to Oracle Key Vault. After you perform the configuration, all future TDE master encryption keys will be stored and managed in Oracle Key Vault. There are two scenarios that you can use:

- If the database does not yet have TDE wallets
- If the database has already been configured for TDE

The online master key feature works as follows: TDE generates the master encryption key and stores it in Oracle Key Vault. Oracle Key Vault administrators have full control of the TDE master encryption keys. They can revoke access of the keys from certain endpoints, share the keys with other endpoints, and perform other operations. The online master key is also a convenient alternative to copying local wallet files to multiple endpoints manually. Sharing TDE master encryption keys, rather than maintaining local wallet copies, is especially useful when TDE is running on database clusters such as Oracle Real Application Clusters (Oracle RAC) or Oracle Data Guard. The following comparison illustrates the difference:

- Local wallet copy

In a Data Guard scenario, re-key operations on the primary database cause the managed recovery process on the standby databases to fail. You must copy the wallet to the standby database, and then an administrator must open the wallet (if the wallet is not an auto-login wallet). Afterward, you must restart the managed recovery process.

- Shared TDE key in a virtual wallet in Oracle Key Vault

In a database cluster, after a key rotation operation, Oracle Key Vault immediately shares the new TDE master encryption key with other nodes in the cluster. There is no need to copy the wallet manually to the other nodes. In a Data Guard configuration, after key rotation, the new keys are immediately available to the standby databases, making the key management operations seamless.

Centralized management facilitates copying encrypted data between databases using Oracle Data Pump export, import, and the transportable tablespaces features of Oracle Database when master encryption keys are stored in the wallet.

- In non-centralized management the wallet must be manually copied from source to target databases.
- In centralized management these master encryption keys are easily shared when you place them in a virtual wallet in Oracle Key Vault, and then grant each endpoint access to the virtual wallet.

You must open the wallet before encryption and decryption. After you close the wallet, then encrypted data in tables and tablespaces is unavailable to you. You should rotate the TDE master encryption key regularly to remain in compliance with the applicable regulations.

Oracle Key Vault supports the SQL statements that were used to administer earlier TDE releases, specifically the use of the `ALTER SYSTEM` and `ADMINISTER KEY MANAGEMENT` SQL statements.

Online master keys are supported on Oracle Database 11g release 2 or later versions.

The following figure illustrates the centralized management of online master keys.

Figure 1-3 Centralized Management of Online Master Keys

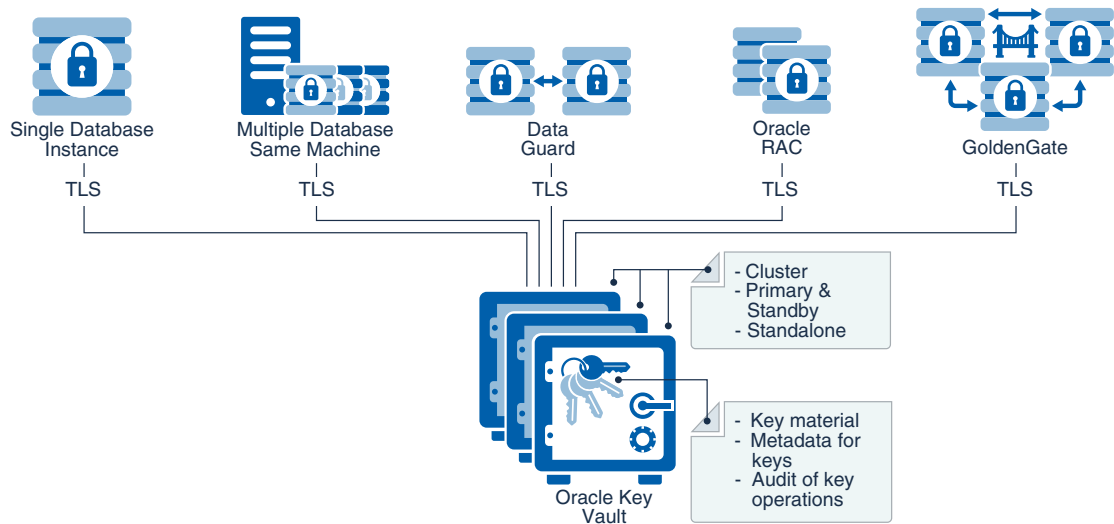

1.3.3 Storage of Credential Files

Oracle Key Vault can back up credential files other than Oracle wallets and Java keystores for long-term retention and recovery.

Oracle Key Vault does not interpret the actual content of a credential file. It simply stores the entire file as an opaque object (a file designed to prevent tools such as Oracle Key Vault from interpreting its contents) and provides a handle to the endpoint for retrieval at a later time. A credential file contains security objects such as keys, passwords, SSH keys, Kerberos keytab files, and X.509 certificates.

You can directly upload credential files to Oracle Key Vault, consolidate them in a central repository, and share them across endpoints in a trusted group. Oracle Key Vault backs up all credential files for continued and secure access at any time. Access control to credential files is managed by Oracle Key Vault endpoint administrators.

The following figure illustrates how credential files are backed up in Oracle Key Vault.

Figure 1-4 Backing Up Credential Files

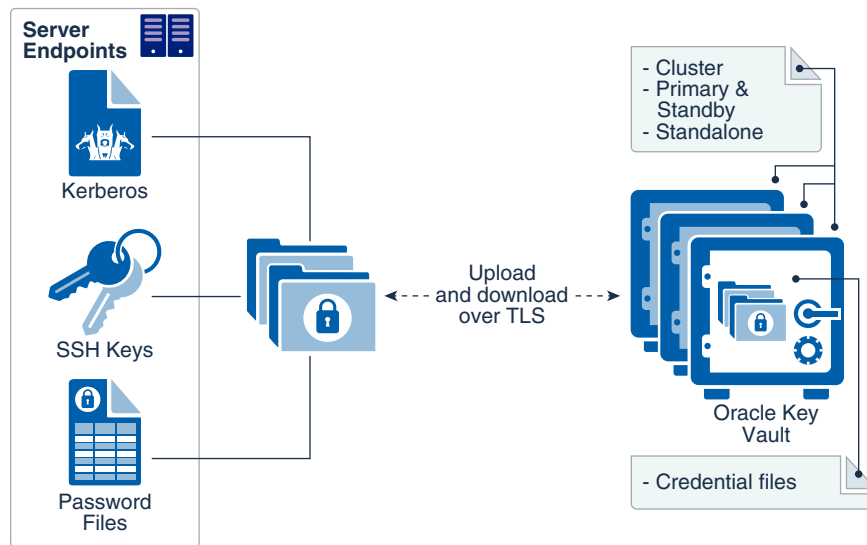

Related Topics

- [Uploading and Downloading Credential Files](#)
The `okvutil upload` and `okvutil download` commands can upload and download credential files.

1.3.4 Online Management of Endpoint Keys and Secret Data

You can use the RESTful key management interface to manage the storage and retrieval of keys.

Applications, scripts, and third-party software can use the new interfaces to manage their keys and secrets in the Oracle Key Vault. They can retrieve the secrets or keys at run time and also generate and store new secrets or keys in Oracle Key Vault at run time. All objects managed by the user or operations executed by the user using the RESTful utility have the same security and availability attributes and the same access control as those created by other Oracle Key Vault endpoint utilities such as `okvutil`.

1.4 Who Should Use Oracle Key Vault

Oracle Key Vault is designed for users who are responsible for deploying, maintaining, and managing security within the enterprise.

These users can be database, system, or security administrators, indeed any information security personnel responsible for protecting enterprise data in database servers, application servers, operating systems, and other information systems. They manage encryption keys, Oracle wallets, Java keystores, and other security objects on a regular basis.

Other users can include personnel responsible for Oracle databases, and servers that interact with Oracle Database, because Oracle Key Vault provides inherently tighter integration with Oracle database. These systems often deploy encryption on a large scale and may have a need to simplify key and wallet management.

1.5 Major Features of Oracle Key Vault

Oracle Key Vault enhances security in key management with a wide range of features that support different database deployments.

- [Centralized Storage and Management of Security Objects](#)
You can store and manage security objects, such as TDE master encryption keys, wallets and keystores, and certificates, using Oracle Key Vault.
- [Management of Key Lifecycle](#)
The management of the key lifecycle is critical for maintaining security and regulatory compliance, and consists of creation, backup, rotation, and expiration.
- [Reporting and Alerts](#)
Oracle Key Vault provides reports and alerts to track system activity in depth.
- [Separation of Duties for Oracle Key Vault Users](#)
Oracle Key Vault provides for separation of duties in the form of three console user roles and four endpoint privileges.
- [Persistent Master Encryption Key Cache](#)
The persistent master encryption key cache feature of the endpoint software enables databases to operate when the Oracle Key Vault server is unavailable.
- [Backup and Restore Functionality for Security Objects](#)
Oracle Key Vault enables you to back up all security objects including keys, certificates, and passwords.
- [Management of Oracle Key Vault Using RESTful Service](#)
You can use Oracle Key Vault RESTful services to automate many of the configuration, deployment, and administration tasks at scale.
- [Support for OASIS Key Management Interoperability Protocol \(KMIP\)](#)
You can use Oracle Key Vault with a range of OASIS KMIP Version 1.1 profiles.
- [Database Release and Platform Support](#)
Oracle Key Vault supports both full Oracle Database releases and bundle patches of Oracle Database.
- [Integration with External Audit and Monitoring Services](#)
You can use Oracle Key Vault with Oracle Audit Vault and Simple Network Management Protocol (SNMP).
- [Integration of MySQL with Oracle Key Vault](#)
Oracle Key Vault can manage MySQL TDE encryption keys.
- [Automatic Storage Management Cluster File System \(ACFS\) Encryption](#)
Oracle Key Vault supports key management for Automatic Storage Management (ASM) cluster file system (ACFS) encryption.
- [Support for Oracle Cloud Database as a Service Endpoints](#)
An Oracle Key Vault on-premises server can manage Transparent Data Encryption (TDE) master encryption keys for Oracle Cloud Database as a Service instance.
- [Oracle Key Vault Hardware Security Module Integration](#)
Oracle Key Vault can use a hardware security module (HSM) as a Root of Trust (RoT) that protects encryption keys.

- [Support for a Primary-Standby Environment](#)
To ensure that Oracle Key Vault can always access security objects, you can deploy Oracle Key Vault in a primary-standby (highly available) configuration.

Related Topics

- [Benefits of Oracle Key Vault Multi-Master Clustering](#)
The Oracle Key Vault multi-master cluster configuration addresses high availability better than primary-standby environments.

1.5.1 Centralized Storage and Management of Security Objects

You can store and manage security objects, such as TDE master encryption keys, wallets and keystores, and certificates, using Oracle Key Vault.

- TDE master encryption keys
For Oracle databases that use Transparent Data Encryption (TDE), Oracle Key Vault manages master encryption keys over a direct network connection using an online master encryption key as an alternative to using local wallet files. The keys stored in Oracle Key Vault can be shared across databases according to endpoint access control settings. This method of sharing keys without local wallet copies is useful when TDE is running on database clusters such as Oracle Real Application Clusters (Oracle RAC), Oracle Data Guard, or Oracle GoldenGate. You can easily migrate master encryption keys from Oracle wallets to Oracle Key Vault. Direct connections between TDE and Oracle Key Vault are supported for Oracle Database 11g release 2 or later.
- Oracle wallets and Java keystores
Oracle wallets and Java keystores are often widely distributed across servers and server clusters, with backup and distribution of these files performed manually. Oracle Key Vault itemizes and stores contents of these files in a master repository, yet allows server endpoints to continue operating with their local copies, while being disconnected from Oracle Key Vault. After you have archived wallets and keystores, you can recover them to their servers if their local copies are mistakenly deleted or their passwords are forgotten. Oracle Key Vault streamlines the sharing of wallets across database clusters such as Oracle RAC, Oracle Active Data Guard, and Oracle GoldenGate. Sharing wallets also facilitates the movement of encrypted data using Oracle Data Pump and the transportable tablespaces feature of Oracle Database, or when migrating (unplugging or plugging) a PDB. You can use Oracle Key Vault with Oracle wallets from all supported releases of Oracle middleware products and Oracle Database.
- Credential files
Applications store keys, passwords, and other types of sensitive information in credential files that are often widely distributed without appropriate protective mechanisms. Secure Shell (SSH) key files and Kerberos keytabs are examples of credential files. Oracle Key Vault backs up credential files for long-term retention and recovery, audits access to them, and shares them across trusted server endpoints.
- Certificate files
X.509 certificate files (common file extensions include .pem, .cer, .crt, .der, .p12) used to authenticate and validate user identities and encrypt data on communication channels may also be stored, shared, and managed in Oracle Key Vault.

1.5.2 Management of Key Lifecycle

The management of the key lifecycle is critical for maintaining security and regulatory compliance, and consists of creation, backup, rotation, and expiration.

Oracle Key Vault provides mechanisms for facilitating periodic key rotations, backup, and recovery, which ensure that you can stay in regulatory compliance, unlike other systems that create keys and passwords. You can create policies to track the key lifecycle, and configure Oracle Key Vault to report key lifecycle changes as they happen. In this manner, you will know when keys are due to expire, and can ensure that they are properly rotated and backed up.

Key lifecycle tracking is very important to maintain compliance with industry and governmental standards, such as the Payment Card Industry Data Security Standard (PCI DSS), which deal with highly sensitive data, and therefore have stringent requirements regarding the maximum lifetime of encryption keys and passwords.

1.5.3 Reporting and Alerts

Oracle Key Vault provides reports and alerts to track system activity in depth.

- Reports

The Oracle Key Vault audit and management reports provide detailed statistics on system, user, and endpoint activity, certificate, key and password expiry, entitlement and metadata of security objects. Audit reports capture all user and endpoint actions, the objects of the actions, and their final result.

- Alerts

You can configure the types of alerts that you want to receive. These include alerts for the expiration of keys, endpoint certificates, and user passwords, disk utilization, system backup, and primary-standby events. You can choose to send alerts to syslog to allow for external monitoring.

1.5.4 Separation of Duties for Oracle Key Vault Users

Oracle Key Vault provides for separation of duties in the form of three console user roles and four endpoint privileges.

The roles are System Administrator, Key Administrator, and Audit Manager. The endpoint privileges are Create Endpoint, Manage Endpoint, Create Endpoint Group, and Manage Endpoint Group.

Each user role possesses privileges for a type of task and may be assigned to one user (for a strict separation of duties) or combined so a single user performs multiple user roles according to the needs of the organization.

The user who is responsible for uploading and downloading security objects between Oracle Key Vault and the endpoint is referred to as the endpoint administrator. Only endpoint administrators can directly access security objects provided they have been granted access and only through installing the endpoint software. You cannot retrieve security objects using the Oracle Key Vault management console.

Related Topics

- [Administrative Roles and Endpoint Privileges within Oracle Key Vault](#)
Oracle Key Vault provides separation of duty compliant administrative roles and privileges that you can combine in various ways to meet enterprise needs.

1.5.5 Persistent Master Encryption Key Cache

The persistent master encryption key cache feature of the endpoint software enables databases to operate when the Oracle Key Vault server is unavailable.

The TDE master encryption key is cached in the persistent master encryption key cache in addition to the in-memory cache, to make the master encryption key available across database processes. It eliminates the need for databases to contact the Oracle Key Vault server for every new process, redo log switch, or database start-up operations.

The persistent master encryption key cache is not necessary in a multi-master cluster deployment. It is primarily used for standalone or primary-standby Oracle Key Vault deployments.

Related Topics

- [Using the Persistent Master Encryption Key Cache](#)
The persistent master encryption key cache feature enables databases to be operational when the Oracle Key Vault server is unavailable.

1.5.6 Backup and Restore Functionality for Security Objects

Oracle Key Vault enables you to back up all security objects including keys, certificates, and passwords.

It encrypts backups for better protection of the sensitive keys and security objects and supports storing them securely at a remote destination.

This feature prevents loss of your sensitive data in the case of server failure, because you can restore a new Oracle Key Vault server to a previous state from a backup.

Oracle Key Vault can transfer backup files to any remote location that implements the Secure Copy Protocol (SCP) or SSH Secure File Transfer Protocol (SFTP).

Users with the System Administrator role can perform the following backup and restore tasks in Oracle Key Vault:

- Managing incremental and full backups
- Creating, deleting, and modifying remote backup locations
- Setting up, modifying, or disabling the current backup schedule
- Initiating an immediate one-time backup
- Scheduling a future one-time backup

Oracle Key Vault performs hot backup operation which means that the system is not interrupted while the backup is being created.

Related Topics

- [Backup and Restore Operations](#)
Backups provide the ability to restore Oracle Key Vault to a previous state in the case of a failure.

1.5.7 Management of Oracle Key Vault Using RESTful Service

You can use Oracle Key Vault RESTful services to automate many of the configuration, deployment, and administration tasks at scale.

A large distributed enterprise deployment often requires automation through scripting to enable mass endpoint deployments, apply configuration changes, and perform routine management operations. The Oracle Key Vault RESTful services utility enables you perform all of these tasks in a way that facilitates faster deployment with less human intervention. You can use Oracle Key Vault RESTful services to automate the management of endpoints, wallets, access control, deployment operations, and backup operations at scale.

The Oracle Key Vault RESTful services utility also enables the automation of most key management functions at scale by providing a simplified interface to Key Management Interoperability Protocol (KMIP) operations. The RESTful services utility allows operations on managed objects such as keys, certificates, and other objects in a simple manner without requiring any client side development.

Related Topics

- *Oracle Key Vault RESTful Services Administrator's Guide*

1.5.8 Support for OASIS Key Management Interoperability Protocol (KMIP)

You can use Oracle Key Vault with a range of OASIS KMIP Version 1.1 profiles.

OASIS Key Management Interoperability Protocol (KMIP) standardizes key management operations between key management servers and endpoints provided by different vendors.

Oracle Key Vault implements the following OASIS KMIP Version 1.1 profiles:

- **Basic Discover Versions Server Profile:** Provides the server version to endpoints.
- **Basic Baseline Server KMIP Profile:** Provides core functionality to retrieve objects from the server.
- **Basic Secret Data Server KMIP Profile:** Provides endpoints the ability to create, store, and retrieve secret data (typically passwords) on the server.
- **Basic Symmetric Key Store and Server KMIP Profile:** Provides endpoints the ability to store and retrieve symmetric encryption keys on the server.
- **Basic Symmetric Key Foundry and Server KMIP Profile:** Provides endpoints the ability to create new symmetric encryption keys on the server.

Related Topics

- [Key Management Interoperability Protocol Specification Version 1.1](#)

1.5.9 Database Release and Platform Support

Oracle Key Vault supports both full Oracle Database releases and bundle patches of Oracle Database.

Oracle Key Vault supports Oracle Database releases 11g release 2 or later on Oracle Linux x86-64, Solaris, AIX, and HP-UX (IA) as endpoints without patching. Oracle Key Vault also supports the bundle patches of Oracle Database release 11g release 2 and 12c release 1 (12.1.0.2) or later on Windows Server 2012.

Related Topics

-

1.5.10 Integration with External Audit and Monitoring Services

You can use Oracle Key Vault with Oracle Audit Vault and Simple Network Management Protocol (SNMP).

Oracle Key Vault supports integration with Oracle Audit Vault for central storage of audit records generated. Oracle Key Vault also supports use of SNMP version 3 to monitor the health and availability of the system.

1.5.11 Integration of MySQL with Oracle Key Vault

Oracle Key Vault can manage MySQL TDE encryption keys.



Note:

MySQL Windows databases are not supported.

Related Topics

- [MySQL Integration with Oracle Key Vault](#)
You can manage TDE encryption keys in MySQL with Oracle Key Vault.

1.5.12 Automatic Storage Management Cluster File System (ACFS) Encryption

Oracle Key Vault supports key management for Automatic Storage Management (ASM) cluster file system (ACFS) encryption.

1.5.13 Support for Oracle Cloud Database as a Service Endpoints

An Oracle Key Vault on-premises server can manage Transparent Data Encryption (TDE) master encryption keys for Oracle Cloud Database as a Service instance.

Related Topics

- [Oracle Database Instances in Oracle Cloud Infrastructure](#)
Oracle Key Vault deployed on-premises can manage the TDE master encryption keys for Oracle Database instances running in Oracle Cloud Infrastructure (OCI).

1.5.14 Oracle Key Vault Hardware Security Module Integration

Oracle Key Vault can use a hardware security module (HSM) as a Root of Trust (RoT) that protects encryption keys.

HSMs are built with specialized tamper-resistant hardware which is harder to access than normal servers. This protects the RoT and makes it difficult to extract, lowering the risk of compromise. In addition, you can use HSMs in FIPS 140-2 Level 3 mode which can help meet certain compliance requirements.

Related Topics

- [Oracle Key Vault Root of Trust HSM Configuration Guide](#)

1.5.15 Support for a Primary-Standby Environment

To ensure that Oracle Key Vault can always access security objects, you can deploy Oracle Key Vault in a primary-standby (highly available) configuration.

This configuration also supports disaster recovery scenarios.

You can deploy two Oracle Key Vault servers in a primary-standby configuration. The primary server services the requests that come from endpoints. If the primary server fails, then the standby server takes over after a configurable preset delay. This configurable delay ensures that the standby server does not take over prematurely in case of short communication gaps.

The primary-standby configuration was previously known as the high availability configuration. The primary-standby configuration and the multi-master cluster configuration are mutually exclusive.

Oracle Key Vault supports primary-standby read-only restricted mode. When the primary server is affected by server, hardware, or network failures, primary-standby read-only restricted mode ensures that an Oracle Key Vault server is available to service endpoints, thus ensuring operational continuity. However, key and sensitive operations, such as generation of keys are disabled, while operations such as generation of audit logs are unaffected.

When an unplanned shutdown makes the standby server unreachable, the primary server is still available to the endpoints in read-only mode.

Related Topics

- [About the Oracle Key Vault Primary-Standby Configuration](#)
You configure a primary-standby environment by providing the primary and standby servers with each other's IP address and certificate, and then pairing them.

1.6 Oracle Key Vault Interfaces

Oracle Key Vault provides both a graphical user interface and command-line interfaces.

- [Oracle Key Vault Management Console](#)
The Oracle Key Vault management console is a browser-based graphical user interface that Key Vault administrators use to perform day-to-day tasks.
- [Oracle Key Vault `okvutil` Endpoint Utility](#)
Endpoint administrators can use the `okvutil` command-line utility to upload and download security objects between Oracle Key Vault and endpoints.
- [Oracle Key Vault RESTful Services](#)
You can use the Oracle Key Vault RESTful Services utility to automate processes for a large distributed enterprise deployment.
- [Oracle Key Vault Client SDK](#)

1.6.1 Oracle Key Vault Management Console

The Oracle Key Vault management console is a browser-based graphical user interface that Key Vault administrators use to perform day-to-day tasks.

It enables Oracle Key Vault administrators to manage keys and sensitive objects, wallets, endpoints, and users. The console can also configure settings for individual Oracle Key Vault servers, as well as multi-master clusters, primary-standby environments, backup, and recovery.

Related Topics

-

1.6.2 Oracle Key Vault okvutil Endpoint Utility

Endpoint administrators can use the `okvutil` command-line utility to upload and download security objects between Oracle Key Vault and endpoints.

The `okvutil` utility communicates with Oracle Key Vault over a mutually authenticated secure connection.

Related Topics

- [Oracle Key Vault okvutil Endpoint Utility Reference](#)
The `okvutil` utility enables you to perform tasks uploading and downloading security objects.

1.6.3 Oracle Key Vault RESTful Services

You can use the Oracle Key Vault RESTful Services utility to automate processes for a large distributed enterprise deployment.

This utility enables you to automate the management of endpoints, wallets, security objects, deployment operations, and backup operations using RESTful services that are JSON compliant.

Related Topics

- *Oracle Key Vault RESTful Services Administrator's Guide*

1.6.4 Oracle Key Vault Client SDK

Various Oracle and non-Oracle products can use the Oracle Key Vault client SDK to integrate directly with Oracle Key Vault.

The client SDK is available in both Java and C. It has a comprehensive set of high-level and low-level APIs and sample programs.

Related Topics

- *Oracle Key Vault Developer's Guide*

1.7 Overview of an Oracle Key Vault Deployment

There are three different Oracle Key Vault deployment options.

- A multi-master cluster configuration allows for up to 16 nodes for scalability and high availability. This is the recommended deployment. Usually, read-write pairs follow the deployment of Oracle Data Guard primary and standby databases, potentially stretching across geographically distributed data centers, or even stretching from on-premises into an Oracle Cloud Infrastructure (OCI) tenancy.
- A standalone deployment is simplest to deploy. However, it does not provide continuous availability of the key service in the event an Oracle Key Vault server becomes unavailable.
- A primary-standby configuration enables the deployment of a second Oracle Key Vault server as a passive standby to an active primary server. If a primary server becomes unavailable, then the standby server becomes the new primary Oracle Key Vault server to service read and write requests from the endpoints. This is the high availability mode that was introduced in Oracle Key Vault release 12.2.

You can use the following steps as a guideline to deploying Oracle Key Vault within your organization:

1. Understand important concepts described in [Oracle Key Vault Concepts](#) and [Oracle Key Vault Multi-Master Cluster Concepts](#).
2. Install and configure Oracle Key Vault as described in *Oracle Key Vault Installation and Upgrade Guide*.
3. Create a multi-master cluster by adding up to 16 Oracle Key Vault servers for maximum redundancy and reliability. This is described in [Managing Oracle Key Vault Multi-Master Clusters](#).

You must have a separate license for each Oracle Key Vault server installation in a multi-master cluster environment.

4. As an alternative to a multi-master cluster deployment, create a primary-standby configuration by adding a second Oracle Key Vault server. Enable primary-standby read-only restricted mode to ensure operational continuity of the endpoints. This is described in [Managing an Oracle Key Vault Primary-Standby Configuration](#).

You must have a separate license for each Oracle Key Vault server installation in a primary-standby environment.

5. Create users to manage the day-to-day tasks for Oracle Key Vault as described in [Managing Oracle Key Vault Users](#).
6. Register endpoints so that they can use Oracle Key Vault to store and manage their security objects described in [Managing Oracle Key Vault Endpoints](#).
7. Register endpoints in the cloud described in [Oracle Database Instances in Oracle Cloud Infrastructure](#).
8. Enroll endpoints so that you can upload or download security objects between the endpoints and Oracle Key Vault described in [Enrolling and Upgrading Endpoints for Oracle Key Vault](#).
9. Upload or add virtual wallets to Oracle Key Vault described in [Managing Oracle Key Vault Master Encryption Keys](#).

10. Use automating endpoint enrollment and provisioning for large-scale deployments in *Oracle Key Vault RESTful Services Administrator's Guide* .
11. Read about using Oracle Key Vault with other features, such as Oracle GoldenGate, in [Managing Keys for Oracle Products](#).
12. Automate key management to perform online key management with other software using RESTful services and client SDK, as described in *Oracle Key Vault RESTful Services Administrator's Guide* .
13. Learn how to perform periodic maintenance tasks such as administering and monitoring the system, as described in [Oracle Key Vault General System Administration](#).
14. Learn how to monitor Oracle Key Vault by performing tasks such as creating alerts, as described in [Monitoring and Auditing Oracle Key Vault](#).

2

Oracle Key Vault Concepts

To successfully deploy Oracle Key Vault, you must understand the deployment architecture, use cases, access control, administrative roles, and endpoints.

- [Overview of Oracle Key Vault Concepts](#)
Endpoints are computer systems such as database and application servers, and other information systems where keys and credentials access data.
- [Oracle Key Vault Deployment Architecture](#)
Oracle Key Vault is packaged as a software appliance preconfigured with an operating system, a database, and the Oracle Key Vault application.
- [Access Control Configuration](#)
Oracle Key Vault enables you to control access to security objects at various access levels.
- [Administrative Roles and Endpoint Privileges within Oracle Key Vault](#)
Oracle Key Vault provides separation of duty compliant administrative roles and privileges that you can combine in various ways to meet enterprise needs.
- [Naming Guidelines for Objects](#)
The naming guidelines affect the following Oracle Key Vault objects: users, user groups, endpoints, endpoint groups, and virtual wallets.
- [Emergency System Recovery Process](#)
During installation, you will be required to create a special recovery passphrase that Oracle Key Vault uses to recover from emergency situations.
- [Root and Support User Accounts](#)
Both the `root` and `support` user accounts are used with the command-line interface.
- [Endpoint Administrators](#)
An endpoint administrator owns and manages endpoints, which are entities such as Oracle databases that use Oracle Key Vault.
- [FIPS Mode](#)
FIPS mode enables Oracle Key Vault to adhere to FIPS 140-2 compliance.

2.1 Overview of Oracle Key Vault Concepts

Endpoints are computer systems such as database and application servers, and other information systems where keys and credentials access data.

These [endpoint](#) systems must store and manage their encryption keys and secrets efficiently, so that data is secure, accessible, and available to meet the day-to-day activities of the enterprise. Endpoints with pre-existing keys, or the capability to generate them, can use Oracle Key Vault as secure, external, long-term storage.

You must register and enroll an endpoint so that it can communicate with Oracle Key Vault. Enrolled endpoints can upload their keys, share them with other endpoints, and download them to access their data. Oracle Key Vault keeps track of all enrolled endpoints.

You can group [security objects](#) such as master encryption keys and credential files into a [virtual wallet](#) in Oracle Key Vault. The main purpose of a virtual wallet is to group related security objects so that they can be collectively shared with peers in an easy way. A privileged user can create a virtual wallet, add keys to the empty wallet, and then grant other users, endpoints, [user groups](#), and [endpoint groups](#) various levels of access to the wallet. A user must have access to security objects before being able to grant access on those same security objects to other users. The access level they grant can be equal to or less than their own. This flexibility is designed to meet the multiple and varying needs of any organization.

The owner of a security object is the entity that created the security object with full read, write, and modify access to the security object. The owner can add the security object to any number of wallets to be shared with other users at various access levels.

When an endpoint is registered with Oracle Key Vault, you can specify a default wallet for the endpoint. The default wallet ensures that endpoints are associated with a virtual wallet where the keys will be uploaded if no virtual wallet is specified at the time of wallet or key upload.

Multiple endpoints can have a common default wallet. The contents of this default wallet are shared across all the endpoints, without the need to put these endpoints into an endpoint group. This feature enables multiple endpoints to create keys, or upload an Oracle wallet directly to the default wallet.

Oracle Key Vault automatically audits all actions performed by users and endpoints.

2.2 Oracle Key Vault Deployment Architecture

Oracle Key Vault is packaged as a software appliance preconfigured with an operating system, a database, and the Oracle Key Vault application.

This way, you do not have to install and configure individual components. It is hardened for security according to operating system and database hardening best practices. The installation process does not include any unnecessary packages and software, and it enables only required ports and services.

The [endpoints](#) communicate with Oracle Key Vault over a mutually authenticated Transport Layer Security (TLS) connection using the OASIS Key Management Interoperability Protocol (KMIP).

The [Oracle Key Vault multi-master cluster](#) configuration can contain up to 16 nodes, two of which must be [read-write nodes](#) with the remaining being a combination of either [read-write pairs](#) or [read-only nodes](#). The multi-master configuration provides several benefits over a primary-standby configuration. The multi-master configuration and the primary-standby configuration are mutually exclusive.

The Oracle Key Vault primary-standby configuration defines one primary server and one standby server. The primary server is active and services requests from endpoints. If the primary fails to communicate with the standby for a time exceeding a configured time threshold, then the standby server takes over as primary. Communication related to data replication between the primary and standby servers is a mutually authenticated TLS connection. This was referred to as the primary-standby option (previously called high availability) in previous releases of Oracle Key Vault.

The following figure illustrates the deployment architecture of Oracle Key Vault.

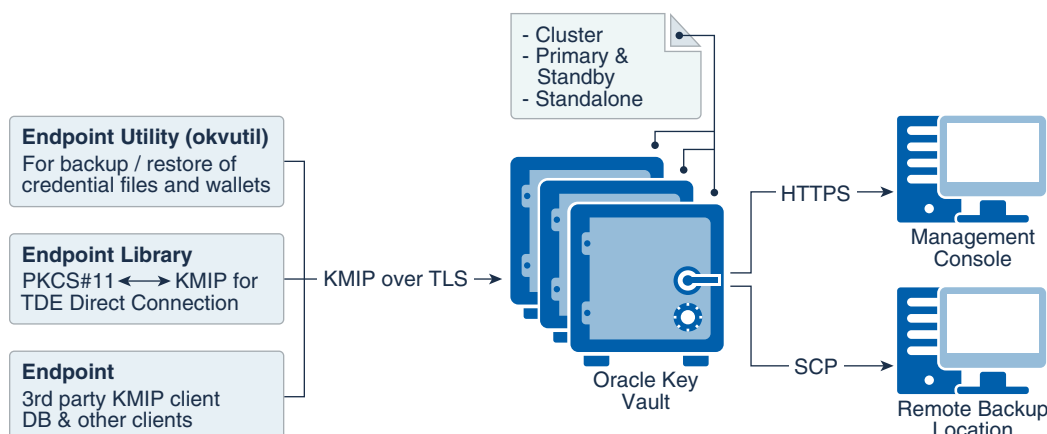
Figure 2-1 Oracle Key Vault Deployment Architecture

For multiple geographically distributed data centers with high load and extreme availability requirements, you should deploy Oracle Key Vault in a multi-master cluster configuration. The read-write pairs should span data centers. For single data centers where data does not leave the data center, consider using a 2-node cluster deployment (one read-write pair) of Oracle Key Vault, instead of a primary-standby deployment. It provides better resource utilization (no idle standby server) and is the ideal platform for a growing Oracle Key Vault cluster in case the demand increases over time. A standalone deployment of Oracle Key Vault is useful for testing and development environments.

Related Topics

- [Oracle Key Vault Multi-Master Cluster Overview](#)
The multi-master cluster nodes provide high availability, disaster recovery, load distribution, and geographic distribution to an Oracle Key Vault environment.
- [Benefits of an Oracle Key Vault Primary-Standby Configuration](#)
The benefits of an Oracle Key Vault primary-standby configuration include high availability, necessary for business-critical operations.

2.3 Access Control Configuration

Oracle Key Vault enables you to control access to security objects at various access levels.

- [About Access Control Configuration](#)
You can grant users access to security objects in Oracle Key Vault at a level appropriate to their function in the organization.
- [Access Grants](#)
You can grant access to virtual wallets directly or indirectly.
- [Access Control Options](#)
Access control options enable you to set the type of privileges that users have to read, write, and delete security objects.

2.3.1 About Access Control Configuration

You can grant users access to security objects in Oracle Key Vault at a level appropriate to their function in the organization.

You can set access control on [security objects](#) individually, or collectively when you group them into a [virtual wallet](#). Oracle Key Vault uses a virtual wallet to share a set of security objects with others. You can set access levels on a virtual wallet for an [endpoint](#) or [user](#), thus granting simultaneous access to all the security objects contained within the virtual wallet.

In addition to being able to grant access to users or endpoints individually, you can collectively grant access by using [user groups](#) or [endpoint groups](#). If multiple endpoints need access to a virtual wallet, it is simpler to add these endpoints to an endpoint group, and grant the endpoint group access to the virtual wallet. The alternative is to grant access to each endpoint individually. When you grant an endpoint group access to a virtual wallet, you are granting access to all the member endpoints in the endpoint group .

2.3.2 Access Grants

You can grant access to virtual wallets directly or indirectly.

- Grant users and endpoints access directly.
- Grant users and endpoints groups access indirectly through a group membership. When you grant a user or endpoint group access, you are granting all members of the group access. This is a convenient alternative to individually granting each user or endpoint access.

From the Oracle Key Vault management console, you can grant access mappings on a virtual wallet in the following two ways:

- From the **user**, **endpoint**, or their respective groups. You can start at the user, endpoint, or respective group and add the wallet and access mappings for this user.
- From the **virtual wallet**. You can start from the virtual wallet and add users, endpoints, and their respective groups that can access it at access mappings that you set.

Related Topics

- [Granting Access to Users, User Groups, Endpoints, and Endpoint Groups](#)
You can grant the **Read Only**, **Read and Modify**, and **Manage Wallet** access levels to users, user groups, endpoints, and endpoint groups.
- [Granting an Endpoint Access to a Virtual Wallet](#)
An endpoint must have the Read, Modify, and Manage Wallet privileges on the wallet before security objects can be uploaded or downloaded.
- [Granting a User Group Access to a Virtual Wallet](#)
You can modify the access level to a virtual wallet for a user group as functional needs change.

2.3.3 Access Control Options

Access control options enable you to set the type of privileges that users have to read, write, and delete security objects.

You can control access to virtual wallets by setting different access levels for users, user groups, endpoints, and endpoint groups corresponding to their role and function in the organization.

There are three access levels:

- **Read Only** grants read privileges on the security object.
- **Read and Modify** grants read and modify privileges on the security object.
- **Manage Wallet** grants the following privileges:
 - Adding or removing security objects from the virtual wallet. The user must have **Read and Modify** access on the security object to be added to the virtual wallet.
 - Granting others access to the wallet
 - Modifying wallet settings, such as its description
 - Deleting the wallet

2.4 Administrative Roles and Endpoint Privileges within Oracle Key Vault

Oracle Key Vault provides separation of duty compliant administrative roles and privileges that you can combine in various ways to meet enterprise needs.

- [Separation of Duties in Oracle Key Vault](#)
When you grant the Oracle Key Vault roles and system privileges to users, ensure that you adhere to separation of duty guidelines.
- [Administrative Roles](#)
The Oracle Key Vault administrative roles are System Administrator, Key Administrator, and Audit Manager.
- [Endpoint Privileges](#)
Oracle Key Vault provides privileges for creating and managing endpoints and endpoint groups.

2.4.1 Separation of Duties in Oracle Key Vault

When you grant the Oracle Key Vault roles and system privileges to users, ensure that you adhere to separation of duty guidelines.

Oracle Key Vault users can be assigned the administrative roles by function, so there is a clear separation of duties between the System Administrator role, the Key Administrator Role, and the Audit Manager role. The Create Endpoint, Manage Endpoint, Create Endpoint Group, and Manage Endpoint Group privileges enable users to manage a subset of endpoints or endpoint groups without requiring these users to be granted more powerful administrative roles. You also can create users that have no administrative privileges.

In a strict separation of duties environment, different users are responsible for different functions. For example, for endpoints, the operations to manage an endpoint and grant permissions to the endpoint must be done by different users. Only users with System Administrator role or Manage Endpoint privilege can enroll an endpoint and only users with Key Administrator role or Manage Endpoint Group privilege can add an endpoint to the endpoint group.

You can achieve a separation of duties in two ways:

- For each person who has been granted a role or a privilege, grant them the appropriate privileges for the functional area that they manage. For example, grant the System

Administrator role for system-related tasks such as user, backup/recovery, and endpoint management; the Key Administrator role to manage encryption keys, wallets, and endpoint groups (within the Oracle Key Vault interface); and the Audit Manager role to manage auditing-related tasks.

- Grant a user access to one object or function independently of all others using a fine-grained division of access control. For example, grant the Manage Endpoint privilege and Manage Endpoint Group privileges to different users based on their area of responsibility. These users do not need to have any of the administrative roles to perform their function.

You should ensure that every user who interacts with Oracle Key Vault has their own unique user account and password. Because the System Administrator and Key Administrator roles are powerful, also ensure that these users are trustworthy and that they are knowledgeable about the areas that they manage.

2.4.2 Administrative Roles

The Oracle Key Vault administrative roles are System Administrator, Key Administrator, and Audit Manager.

- [About Administrative Roles in Oracle Key Vault](#)
Oracle Key Vault provides the System Administrator, Key Administrator, and Audit Manager roles.
- [System Administrator Role Duties](#)
The Oracle Key Vault System Administrator is responsible for general system-related tasks.
- [Key Administrator Role Duties](#)
The Oracle Key Vault Key Administrator is responsible for managing security objects.
- [Audit Manager Role Duties](#)
The Oracle Key Vault Audit Manager is responsible for audit-related tasks.

2.4.2.1 About Administrative Roles in Oracle Key Vault

Oracle Key Vault provides the System Administrator, Key Administrator, and Audit Manager roles.

- **System Administrator role** provides privileges for creating and managing users, creating and managing endpoints, configuring system settings and alerts, and generally administering Oracle Key Vault. This is the most powerful role.
- **Key Administrator role** provides privileges for managing the key life cycle and controlling access to all security objects in Oracle Key Vault.
- **Audit Manager role** provides privileges for managing the audit life cycle and audit policies.

The System Administrator, Key Administrator, and Audit Manager roles are designed to be flexible to support various organizational needs and structures. Users who have these roles can grant their roles to other users. If one administrative user is performing two administrative functions, then that user will have two roles in Oracle Key Vault. This user can grant other users one or both the roles as needed. For example, if a user has both the System Administrator and Key Administrator role, then he or she

can grant another user both those roles or just one, depending on the needs of the organization.

One of the post-installation tasks is to create three administrative users for the three administrative roles. The installation process also prompts you to create a recovery passphrase. In a situation where there is no administrative user present, you will use the recovery passphrase to repeat the post-installation configuration, and create three administrative users in order to ensure continued operation and management of Oracle Key Vault.

You can grant management privileges to a user for any endpoint regardless of whether the user created the endpoint or the endpoint group. Another specific area that users can have privileges for is the management of virtual wallets. You can grant these users access to the virtual wallet appropriate to their function within the organization, thus limiting access to security objects to just those users who need it. In this manner, access to security objects is controlled, yet flexible to meet the evolving needs of the enterprise.

When you use the management console interface, your access to the various tabs, menus, and actions depends on your role and the objects that you have access to.

2.4.2.2 System Administrator Role Duties

The Oracle Key Vault System Administrator is responsible for general system-related tasks.

- Creating and managing users
- Adding and managing endpoints (you also can grant privileges to individual regular users to handle endpoints)
- Setting up the primary-standby servers
- Configuring alerts and key rotation reminders
- Scheduling backups
- Starting and stopping Oracle Key Vault
- Configuring SMTP server settings for email notification
- Enabling or disabling FIPS mode
- Configuring Oracle Key Vault to use a hardware security module
- Configuring SNMP for remote monitoring
- Enabling automated endpoint enrollment and key management through RESTful Services
- Checking if the Oracle Audit Vault monitoring process is running
- Creating SSH tunnels for Oracle Cloud Database as a Service endpoints
- Setting up a cluster
- Managing and monitoring a cluster
- Managing the cluster configuration
- Granting and revoking the System Administrator role to and from other users
- Granting and revoking the Create Endpoint and Manage Endpoint privileges to and from other users

2.4.2.3 Key Administrator Role Duties

The Oracle Key Vault Key Administrator is responsible for managing security objects.

- Managing the lifecycle of security objects
- Having full access on all virtual wallets and security objects
- Adding and managing endpoint groups (you also can grant privileges to individual regular users to handle endpoint groups)
- Controlling access to virtual wallets for users, endpoints, user groups, and endpoint groups
- Granting and revoking the Key Administrator role to and from other users
- Granting and revoking the Create Endpoint Group and Manage Endpoint Group privileges to and from other users

2.4.2.4 Audit Manager Role Duties

The Oracle Key Vault Audit Manager is responsible for audit-related tasks.

- Managing the audit trail as the only user who has privileges to export or delete Oracle Key Vault audit records
- Having read access on all security objects
- Managing audit settings
- Granting the Audit Manager role to other users
- Managing the Oracle Audit Vault integration with Oracle Key Vault

2.4.3 Endpoint Privileges

Oracle Key Vault provides privileges for creating and managing endpoints and endpoint groups.

- [About Endpoint Privileges in Oracle Key Vault](#)
Oracle Key Vault provides fine-grained endpoint-management privileges that enable users who do not have the System Administrator and Key Administrator roles to create and manage endpoints and endpoint groups.
- [Create Endpoint Privilege Duties and Scope](#)
The Create Endpoint system privilege enables user to create an endpoint.
- [Manage Endpoint Privilege Duties and Scope](#)
The Manage Endpoint object privilege on an endpoint enables a user to perform all endpoint management operations on the endpoint.
- [Create Endpoint Group Privilege Duties and Scope](#)
The Create Endpoint Group system privilege enables a user to create an endpoint group.
- [Manage Endpoint Group Privilege Duties and Scope](#)
The Manage Endpoint Group object privilege on an endpoint group enables a user to perform all endpoint group management operations on the endpoint group.

2.4.3.1 About Endpoint Privileges in Oracle Key Vault

Oracle Key Vault provides fine-grained endpoint-management privileges that enable users who do not have the System Administrator and Key Administrator roles to create and manage endpoints and endpoint groups.

These privileges are as follows:

- **Create Endpoint system privilege** enables a user to create endpoints.
- **Manage Endpoint object privilege** object privilege on an endpoint enables a user to perform all endpoint management operations on the endpoint.
- **Create Endpoint Group system privilege** enables a user to create endpoint groups.
- **Manage Endpoint Group object privilege** object privilege on an endpoint group enables a user to perform all endpoint group management operations on the endpoint group.

Only users who have the System Administrator or Key Administrator role can perform privilege grants and revokes for the endpoint privileges, as follows:

- **Create Endpoint and Manage Endpoint privileges:** System Administrator role
- **Create Endpoint Group and Manage Endpoint Group privileges:** Key Administrator role

The System Administrator and Key Administrator roles are powerful roles that enable users with these roles to modify or delete any objects in Oracle Key Vault that belong to other users. The endpoint and endpoint group privileges enable you to allow regular users who do not have these roles to create and manage a specific set of endpoints and endpoint groups. These users cannot perform operations on other endpoints or endpoint groups that they are not authorized to manage. These privileges help implement isolation among different sets of endpoints and endpoint groups that are managed by different users. For example, one set of users can be responsible for managing all cloud database endpoints, and other users can be responsible for managing all on-premises database endpoints.

These privileges are enforced when endpoint or endpoint group operations are executed from either the Oracle Key Vault management console or using Oracle Key Vault RESTful services command-line interface.

2.4.3.2 Create Endpoint Privilege Duties and Scope

The Create Endpoint system privilege enables user to create an endpoint.

When a user is granted the Create Endpoint privilege, Oracle Key Vault automatically grants the Manage Endpoint privilege to the user, unless the user already has the System Administrator role. The grant of Manage Endpoint enables the user to perform management operations on the endpoint that the user created.

When the user creates the endpoint, Oracle Key Vault automatically grants the user the Manage Endpoint privilege on this endpoint, which allows the user to manage the endpoints that they created without requiring additional privilege grants. However, the user's Manage Endpoint privilege on this endpoint can be revoked later.

If this is the first endpoint that the user created, and if that user does not hold the Manage Endpoint privilege on any other endpoint, then this user should log out, and then log back into the Oracle Key Vault management console session. Doing so enables the user to exercise the Manage Endpoint privilege on that endpoint.

Who Can or Cannot Grant or Revoke the Create Endpoint Privilege?

Only a user who has the System Administrator role can grant or revoke the Create Endpoint privilege. Users who have the Create Endpoint privilege cannot grant or revoke this privilege to or from any user. A user can only be granted the Create Endpoint privilege if that user does not have any administrative roles. When the user has this privilege, the user cannot be granted any administrative roles.

How the Create Endpoint Privilege Works with the Manage Endpoint Privilege

Even though the Manage Endpoint privilege is automatically granted to a user who has been granted the Create Endpoint privilege when this user creates an endpoint, the Manage Endpoint privilege can be revoked from this user at any time, so that this user is restricted to creating endpoints only but not modifying or deleting them.

System Administrator Role and the Create Endpoint Privilege

As in previous releases, System Administrators can still create endpoints. If the System Administrator role is revoked from a user, then the user can no longer create any endpoint. The user, however, can now be granted the Create Endpoint privilege to enable to enable the user to create endpoints.

Revocation of the Create Endpoint Privilege

A revoke of the Create Endpoint privilege prevents the user from being able to create more endpoints. Users cannot revoke the Create Endpoint privilege from themselves. The Create Endpoint privilege can be revoked from a user without affecting the user's Manage Endpoint privilege on one or more endpoints.

Deletion of Users Who Have Been Granted the Create Endpoint Privilege

The endpoint creator does not have perpetual ownership of the endpoint. The Manage Endpoint privilege on that endpoint granted to the endpoint's creator can be revoked, after which the endpoint creator cannot manage that endpoint anymore. Deletion of an endpoint's creator has no special significance other than the one that this user may have been granted the Manage Endpoint privilege at the time of the endpoint creation. If there are no other users with the Manage Endpoint privilege on that endpoint, then the System Administrator becomes responsible for managing that endpoint.

Related Topics

- [Manage Endpoint Privilege Duties and Scope](#)
The Manage Endpoint object privilege on an endpoint enables a user to perform all endpoint management operations on the endpoint.

2.4.3.3 Manage Endpoint Privilege Duties and Scope

The Manage Endpoint object privilege on an endpoint enables a user to perform all endpoint management operations on the endpoint.

The user who has the Manage Endpoint privilege on an endpoint can perform the following tasks:

- Perform all endpoint management operations (such as reenroll, suspend, resume, or delete) on the endpoint.
- Set the default wallet of that endpoint if the user also has full access on the subject wallet.

Who Can or Cannot Grant or Revoke the Manage Endpoint Privilege?

Only a user who has the System Administrator role can grant or revoke the Manage Endpoint privilege. Users who have the Manage Endpoint privilege cannot grant or revoke this privilege to or from other users. A user can only be granted the Manage Endpoint privilege if that user does not have any administrative roles. When the user has this privilege, the user cannot be granted any administrative roles.

System Administrator Role and Users Who Have the Manage Endpoint Privilege

As in previous releases, System Administrators can still manage endpoints, including endpoints that were created by users with the Create Endpoint privilege. If the System Administrator role is revoked from a user, then the user can no longer manage any endpoints including those he or she created previously with that role. The user must be explicitly granted the Manage Endpoint privilege on an endpoint so that the user can manage that endpoint.

Objects and Wallets Associated with an Endpoint

Objects that are created by an endpoint are always owned by the endpoint. The endpoint creator or users with the Manage Endpoint privilege do not get automatic or implicit access to any objects that were created by the endpoint.

A user with the Manage Endpoint privilege can set the endpoint's default wallet if the user also has full access on the wallet. Revocation of the wallet access from the user afterwards does not affect the endpoint's default wallet setting.

Revocation of the Manage Endpoint Privilege

The Manage Endpoint privilege can be revoked on the endpoint from a user without affecting the user's Create Endpoint privilege status. Users cannot revoke the Manage Endpoint privilege from themselves. If there are no users with the Manage Endpoint privilege for the endpoint, then managing that endpoint becomes the responsibility of users with the System Administrator role.

Deletion of Users Who Have Been Granted the Manage Endpoint Privilege

If the user who manages an endpoint is deleted, then the System Administrator or any other users who have the Manage Endpoint privilege for that endpoint can still manage the endpoint.

Related Topics

- [Create Endpoint Privilege Duties and Scope](#)
The Create Endpoint system privilege enables user to create an endpoint.

2.4.3.4 Create Endpoint Group Privilege Duties and Scope

The Create Endpoint Group system privilege enables a user to create an endpoint group.

When a user is granted the Create Endpoint Group privilege, Oracle Key Vault automatically grants the Manage Endpoint Group privilege to the user at the time the user creates an endpoint group. The grant of Manage Endpoint Group enables the user to perform management operations on the endpoint group that the user created, and perform wallet operations that affect the endpoint group.

If this is the first endpoint group that the user created, and if that user does not hold the Manage Endpoint Group privilege on any other endpoint group, then this user should log out, and then log back into the Oracle Key Vault management console session. Doing so enables the user to exercise the Manage Endpoint privilege on that endpoint group.

Who Can or Cannot Grant or Revoke the Create Endpoint Group Privilege?

Only a user who has the Key Administrator role can grant or revoke the Create Endpoint Group privilege. Users who have the Create Endpoint Group privilege cannot grant or revoke this privilege to or from other users. A user can only be granted the Create Endpoint Group privilege if that user does not have any administrative roles. When the user has this privilege, the user cannot be granted any administrative roles.

How the Create Endpoint Group Privilege Works with the Manage Endpoint Group Privilege

Even though the Manage Endpoint Group privilege is automatically granted to a user when the user creates an endpoint group, the Manage Endpoint Group privilege can be revoked for the endpoint group from this user at any time, so that this user can no longer modify or delete that endpoint group.

Key Administrator Role and Users Who Have the Create Endpoint Group Privilege

As in previous releases, Key Administrators can still create endpoint groups. If the Key Administrator role is revoked from a user, then the user can no longer create any endpoint group. The user, however, can now be granted Create Endpoint Group privilege to enable the user to create endpoint groups.

Revocation of the Create Endpoint Group Privilege

A revoke of the Create Endpoint Group privilege prevents the user from being able to create more endpoint groups. Users cannot revoke the Create Endpoint Group privilege from themselves. The Create Endpoint Group privilege can be revoked from a user without affecting the user's Manage Endpoint Group privilege on one or more endpoint groups.

Deletion of Users Who Have Been Granted the Create Endpoint Group Privilege

The endpoint group creator does not have perpetual ownership of the endpoint group. The Manage Endpoint Group privilege on that endpoint group granted to the endpoint group's creator can be revoked, after which the endpoint group creator cannot manage that endpoint group anymore. Deletion of an endpoint group's creator has no special significance other than the one that this user may have been granted the Manage Endpoint Group privilege at the time of the endpoint group creation. If there are no other users with the Manage Endpoint Group privilege on that endpoint group, then the Key Administrator becomes responsible for managing that endpoint group.

Related Topics

- [Manage Endpoint Group Privilege Duties and Scope](#)
The Manage Endpoint Group object privilege on an endpoint group enables a user to perform all endpoint group management operations on the endpoint group.

2.4.3.5 Manage Endpoint Group Privilege Duties and Scope

The Manage Endpoint Group object privilege on an endpoint group enables a user to perform all endpoint group management operations on the endpoint group.

The user who has the Manage Endpoint Group privilege on an endpoint group can perform all endpoint group management operations (such as adding or removing an endpoint to or from an endpoint group, deleting endpoint groups, and so on) on the endpoint group. This user inherits access to wallets from the endpoint group. This inheritance of wallet access permissions works in the same way as an endpoint or user inherits wallet permissions from an endpoint group or user group, respectively.

Who Can or Cannot Grant or Revoke the Manage Endpoint Group Privilege?

Only a user who has the Key Administrator role can grant or revoke the Manage Endpoint Group privilege. Users who have the Manage Endpoint Group privilege cannot grant or revoke this privilege to or from other users. A user can only be granted the Manage Endpoint Group privilege if that user does not have any administrative roles. When the user has this privilege, the user cannot be granted any administrative roles.

Key Administrator Role and Users Who Have the Manage Endpoint Group Privilege

As in previous releases, Key Administrators can still manage endpoint groups, including endpoint groups that were created by users with the Create Endpoint Group privilege. If the Key Administrator role is revoked from a user, then the user can no longer manage any endpoint groups including those he or she created previously with that role. The user must be explicitly granted the Manage Endpoint Group privilege on an endpoint group so that the user can manage that endpoint group.

Inheritance of Wallet Access from an Endpoint Group

- A user who has been granted the Manage Endpoint Group privilege on an endpoint group (this user is also called the endpoint group manager) inherits the access to wallets from the endpoint group. This inheritance of wallet access permissions works in the same way as an endpoint or user inherits wallet permissions from an endpoint group or user group, respectively.
Granting wallet access to an endpoint group results in implicitly giving the same wallet access to all the users who have the Manage Endpoint Group privilege on that endpoint group. These inherited privileges from an endpoint group are effective as long as the user is the endpoint group manager for the endpoint group. This rule ensures that all endpoint group managers of an endpoint group always have at least the same level of access to wallets that the endpoint group has. This way, when an endpoint is added to the endpoint group, its endpoint group managers remain fully aware of the wallet permissions that the endpoint is implicitly being granted, by virtue of adding an endpoint's membership into the endpoint group.
- A user's effective wallet access is the union of the following:
 - Direct wallet access grants to the user
 - Inherited wallet access grants from the user groups of which this user is a member
 - Inherited wallet access grants from the endpoint groups that this user is authorized to manage

How Wallets Are Affected by Revoke Operations

- Revoking a wallet's access from an endpoint group only results in the endpoint group's managers to lose the wallet access rights that were inherited from the respective endpoint group. The endpoint group's managers may continue to have access to the same wallet either from direct grants or from the inheritance of wallet access from user groups or other endpoint groups.
- Revoking the Manage Endpoint Group privilege on an endpoint group from a user (that is, an endpoint group manager) prevents the user from inheriting future wallet access rights from that endpoint group.
- An endpoint group's manager can revoke access of a wallet from the endpoint group (or from any other user, user group, endpoint, or endpoint group) if the user has the Manage Wallet Access privilege on that wallet even if this access was inherited from the endpoint group itself.

Revocation of the Manage Endpoint Group Privilege

The Manage Endpoint Group privilege can be revoked from a user without affecting the user's Create Endpoint Group privilege status. Users cannot revoke the Manage Endpoint Group privilege from themselves. If there are no users with the Manage Endpoint Group privilege for the endpoint, then managing that endpoint group becomes the responsibility of users with the Key Administrator role.

Deletion of Users Who Have Been Granted the Manage Endpoint Group Privilege

Deletion of an endpoint group's creator does not affect the endpoint groups that this user created. If the user who manages the endpoint group is deleted, then any other users who have the Manage Endpoint Group privilege for that endpoint group can still manage the endpoint group. If no such users exist, then a user who has the Key Administrator role becomes responsible for managing the endpoint group.

Related Topics

- [Create Endpoint Group Privilege Duties and Scope](#)
The Create Endpoint Group system privilege enables a user to create an endpoint group.

2.5 Naming Guidelines for Objects

The naming guidelines affect the following Oracle Key Vault objects: users, user groups, endpoints, endpoint groups, and virtual wallets.

The naming conventions for these objects are as follows:

- You can include the following characters in the names of endpoints, endpoint groups, user groups, and virtual wallets: letters (a–z, A–Z), numbers (0–9), underscores (_), periods (.), and hyphens (-).
- You can include the following characters in the names of users: letters (a–z, A–Z), numbers (0–9), and underscores (_).
- In most environments, the maximum number of bytes allowed for the name length is 120 bytes. If you are in a multi-master cluster environment that has any nodes that have not yet been upgraded to Oracle Key Vault release 18.5 or later, then use a maximum of 24 bytes for the object name.

- The names of users, user groups, endpoints, and endpoint groups are not case sensitive. For example, `pfitch` and `PFITCH` are considered the same user in Oracle Key Vault.
- The names of virtual wallets are case sensitive. For example, `wallet_hr` and `WALLET_HR` are considered two separate wallets in Oracle Key Vault.

2.6 Emergency System Recovery Process

During installation, you will be required to create a special recovery passphrase that Oracle Key Vault uses to recover from emergency situations.

These situations can arise due to administrative users not being immediately available, or something more commonplace such as forgotten passwords.

The recovery passphrase is needed in the following situations:

- If there is no administrative user available to log into Oracle Key Vault, then you can use the recovery passphrase to repeat the post-installation tasks and create new administrative users for system, key, and audit management.
- If you want to restore Oracle Key Vault from a previous backup, then you must have the recovery passphrase that is associated with that backup.
- You will be prompted for the recovery passphrase during the node induction process in the cluster mode.
- You will need it if you want to reset the recovery passphrase periodically.

For these reasons, it is very important to store the recovery passphrase in a safe and accessible place and keep track of older recovery passphrases. The recovery passphrase is the same passphrase that you use when you add nodes to a multi-master cluster.

The only way to recover from a lost recovery passphrase is to reinstall Oracle Key Vault.

Related Topics

- [Managing System Recovery](#)
System recovery includes tasks such as recovering lost administrative passwords.
- [Restoring Oracle Key Vault Data](#)
Oracle Key Vault data from a remote backup destination can be restored onto another Oracle Key Vault server.
-

2.7 Root and Support User Accounts

Both the `root` and `support` user accounts are used with the command-line interface.

The `root` user account is the super user account for the operating system that hosts Oracle Key Vault. You do not need the `root` account for normal Oracle Key Vault administration. Instead, you must use the `root` account when you want to upgrade to a later bundle patch or perform some command-line operations such as adding disk space. The `support` user is the only account that can remotely log in to the operating system hosting the Oracle Key Vault when SSH is enabled.

Be aware that if you enter the `root` or `support` passwords incorrectly three times, then the account is locked for a brief period.

2.8 Endpoint Administrators

An endpoint administrator owns and manages endpoints, which are entities such as Oracle databases that use Oracle Key Vault.

This user is typically a system, security, or database administrator, but can be any personnel charged with deploying, managing and maintaining security within an enterprise. Endpoint administrators are responsible for enrolling endpoints. (This user is different from the Oracle Key Vault users who have the Manage Endpoints and Manage Endpoint Group privileges.)

The endpoint administrator for an Oracle database endpoint is the database administrator, who is responsible for managing the database.

2.9 FIPS Mode

FIPS mode enables Oracle Key Vault to adhere to FIPS 140-2 compliance.

Federal Information Processing Standard (FIPS) publications are issued by the National Institute of Standards and Technology (NIST). The publication entitled *Security Requirements for Cryptographic Modules* (FIPS PUB 140-2) specifies the security requirements over several key areas that will be satisfied by a cryptographic module utilized within a security system protecting sensitive but unclassified information.

The Oracle Key Vault is FIPS 140–2 compliant. Selecting the option to install with FIPS 140–2 compliance performs all required changes during the installation. No additional modifications are necessary after the installation. You can also enable FIPS 140-2 compliance after the installation if it was not done during the initial installation of Oracle Key Vault. Enabling or disabling FIPS mode requires you to restart Oracle Key Vault.

Related Topics

- [Configuring the FIPS Mode for the Node](#)
All multi-master cluster nodes must use the same FIPS mode setting or you will receive an alert.

3

Oracle Key Vault Multi-Master Cluster Concepts

A multi-master cluster is a fully connected network of Oracle Key Vault servers called nodes.

- [Oracle Key Vault Multi-Master Cluster Overview](#)
The multi-master cluster nodes provide high availability, disaster recovery, load distribution, and geographic distribution to an Oracle Key Vault environment.
- [Benefits of Oracle Key Vault Multi-Master Clustering](#)
The Oracle Key Vault multi-master cluster configuration addresses high availability better than primary-standby environments.
- [Multi-Master Cluster Architecture](#)
An Oracle Key Vault node can be a read-write or a read-only node operating in different modes. Nodes can also form a subgroup.
- [Building and Managing a Multi-Master Cluster](#)
You initialize a multi-master cluster using a single Oracle Key Vault server.
- [Oracle Key Vault Multi-Master Cluster Deployment Scenarios](#)
All multi-master cluster nodes can serve endpoints actively and independently.
- [Multi-Master Cluster Features](#)
Oracle Key Vault provides features that help with inconsistency resolution and name conflict resolution in clusters, and endpoint node scan lists.
- [Cluster Management Information](#)
The Cluster Management page provides a concise overview of the cluster and the status of each node.

3.1 Oracle Key Vault Multi-Master Cluster Overview

The multi-master cluster nodes provide high availability, disaster recovery, load distribution, and geographic distribution to an Oracle Key Vault environment.

Oracle recommends that you use the Oracle Key Vault multi-master clusters deployment over other Oracle Key Vault deployments.

An Oracle Key Vault multi-master cluster provides a mechanism to create read-write pairs of Oracle Key Vault nodes for maximum availability and reliability. You can add read-only Oracle Key Vault nodes to the cluster to provide even greater availability to endpoints that need Oracle wallets, encryption keys, Java keystores, certificates, credential files, and other objects.

An Oracle Key Vault multi-master cluster is an interconnected group of Oracle Key Vault [nodes](#). Each node in the cluster is automatically configured to connect with all the other nodes, in a fully connected network. The nodes can be geographically distributed. Oracle Key Vault [endpoints](#) interact with any node in the cluster.

This configuration replicates data to all other nodes, reducing risk of data loss. To prevent data loss, you must configure pairs of nodes called [read-write pairs](#) to enable bi-directional

synchronous replication. This configuration enables an update to one node to be replicated to the other node, and verifies this on the other node, before the update is considered successful. Critical data can only be added or updated within the read-write pairs. All added or updated data is asynchronously replicated to the rest of the cluster.

After you have completed the upgrade process, every node in the Oracle Key Vault cluster must be at Oracle Key Vault release 18.1 or later, and within one release update of all other nodes. Any new Oracle Key Vault server that is to join the cluster must be at the same release level as the cluster.

The clocks on all the nodes of the cluster must be synchronized. Consequently, all nodes of the cluster must have the Network Time Protocol (NTP) settings enabled.

Every node in the cluster can serve endpoints actively and independently while maintaining an identical dataset through continuous replication across the cluster. The smallest possible configuration is a two node cluster, and the largest configuration can have up to 16 nodes with several pairs spread across several data centers.

3.2 Benefits of Oracle Key Vault Multi-Master Clustering

The Oracle Key Vault multi-master cluster configuration addresses high availability better than primary-standby environments.

To ensure high availability for geographically distributed [endpoints](#), Oracle Key Vault [nodes](#) that are deployed in different data centers operate in active-active multi-master cluster configurations to create and share keys. With an active-active configuration, there are no passive machines in the cluster, which allows for better resource utilization. An added benefit of the multi-master cluster configuration is load distribution. When multiple Oracle Key Vault nodes in multi-master configuration are deployed in a data center, they can actively share the key requests of the endpoint databases in that data center.

In a typical large scale deployment, Oracle Key Vault must serve a large number of endpoints, possibly distributed in geographically distant data centers.

In comparison to a multi-master deployment, standalone Oracle Key Vault deployments provide the least availability, while primary-standby deployments offer limited availability:

- A primary-standby configuration only has a single primary Oracle Key Vault server that can actively serve clients.
- If the server running in the standby role is unavailable, then the server running in the primary role is in read-only mode and does not allow any write operations.
- The primary-standby mode can support either high availability in the same data center or disaster recovery across data centers.
- If the persistent master encryption key cache is not enabled, then database downtime is unavoidable during maintenance windows.

The Oracle Key Vault multi-master cluster configuration addresses these limitations. You can geographically disperse nodes to provide simultaneous high availability and disaster recovery capability.

An Oracle Key Vault multi-master cluster configuration offers significant benefits as follows:

- Data compatibility between multi-master cluster nodes similar to a primary-standby deployment
Because all the nodes have an identical data set, the endpoints can retrieve information from any node. In a cluster, the unavailability of an Oracle Key Vault node does not affect the operations of an endpoint. If a given node is unavailable, then the endpoint interacts transparently with another node in the cluster.
- Fault tolerance
Successfully enrolled clients transparently update their own list of available Oracle Key Vault nodes in the cluster. This enables clients to locate available nodes at any given time, without additional intervention. As such, unexpected failure in nodes or network disruptions do not lead to service interruption for endpoints as long as at least one operational Oracle Key Vault read-write pair remains accessible to the endpoint. If all read-write pairs are unavailable to an endpoint, but a read-only restricted node is available, then the endpoint can still invoke read-only operations.
- Zero data loss
Data that has been added or updated at a read-write node is immediately replicated to its read-write peer and must be confirmed at the peer to be considered committed. It is then distributed across the cluster. Therefore, data updates are considered successful only if they are guaranteed to exist in multiple servers.
- No passive machines in the system
A primary-standby configuration requires a passive standby server. The Oracle Key Vault multi-master cluster contains only active servers. This allows for better utilization of hardware.
- Scaling up and scaling down
You can add extra Oracle Key Vault nodes to the cluster or remove existing nodes from the cluster without interrupting the overall Oracle Key Vault services to clients. This means the number of nodes in the cluster can be increased or decreased as required to meet the expected workload.
- Maintenance
Whenever hardware or software maintenance is required, Oracle Key Vault nodes can leave the cluster and return back to the cluster after maintenance. The remaining nodes continue to serve the clients. Properly planned maintenance does not cause any service downtime, avoiding interruption of service to endpoints.

3.3 Multi-Master Cluster Architecture

An Oracle Key Vault node can be a read-write or a read-only node operating in different modes. Nodes can also form a subgroup.

- [Oracle Key Vault Cluster Nodes](#)
An Oracle Key Vault node is an Oracle Key Vault server that operates as a member of a multi-master cluster.
- [Cluster Node Limitations](#)
Limitations to cluster nodes depend on whether the node is asynchronous or synchronous.
- [Cluster Subgroups](#)
A cluster subgroup is a group of one or more nodes of the cluster.

- [Critical Data in Oracle Key Vault](#)
Oracle Key Vault stores critical data that is necessary for the endpoints to operate. Read-only nodes can read critical data as well.
- [Oracle Key Vault Read-Write Nodes](#)
A read-write node is a node in which critical data can be added or updated using the Oracle Key Vault or endpoint software.
- [Oracle Key Vault Read-Only Nodes](#)
In a read-only node, users can add or update non-critical data but not add or update critical data. However, read-only nodes can read critical data.
- [Cluster Node Mode Types](#)
Oracle Key Vault supports two types of mode for cluster nodes: read-only restricted mode or read-write mode.
- [Operations Permitted on Cluster Nodes in Different Modes](#)
In an Oracle Key Vault multi-master cluster, operations are available or restricted based on the node and the operating mode of the node.

3.3.1 Oracle Key Vault Cluster Nodes

An Oracle Key Vault node is an Oracle Key Vault server that operates as a member of a multi-master cluster.

To configure an Oracle Key Vault server to operate as a member of the cluster, you must convert it to be a multi-master cluster node. The process is referred to as node induction. You initiate induction on the Cluster Management page of the Oracle Key Vault management console.

On induction, Oracle Key Vault modifies the **Cluster** tab to enable management, monitoring, and conflict resolution capabilities on the management console of the node. Cluster-specific features of the management console, such as cluster settings, audit replication, naming resolution, cluster alerts, and so on, are enabled as well.

The Primary-Standby Configuration page is not available on the Oracle Key Vault management console of a node. A node cannot have a passive standby server, nor can it become a passive standby server.

A node runs additional services to enable it to communicate with the other nodes of the cluster. Endpoints enrolled from a node are made aware of the cluster topology.

Each node in the cluster has a user-allocated node identifier. The node identifier must be unique in the cluster.

The Oracle Key Vault release in which the node was created will affect the byte length for the names of users, user groups, endpoints, endpoint groups, and virtual wallets. See [Naming Guidelines for Objects](#).

3.3.2 Cluster Node Limitations

Limitations to cluster nodes depend on whether the node is asynchronous or synchronous.

The nodes of a Oracle Key Vault multi-master cluster replicate data asynchronously between them. The only exception is replicating data to the [read-write peer](#). There are various limitations arising as a result of the asynchronous replicate operations. For example, the IP addresses of a node in the cluster are static and cannot be changed

after the node joins the cluster. If you want the node to have a different IP address, then delete the node from the cluster, and either add a new node with the correct IP address, or re-image the deleted node using the correct IP address before adding it back to the cluster.

You can perform only one cluster change operation (such as adding, disabling, or deleting a node) at a time.

Node IDs are unique across the cluster. You must ensure that the node ID is unique when you select the node during the induction process.

An Oracle Key Vault cluster does a best-effort job at preventing users from performing unsupported actions. It will try to remove node IDs that are in-use from the node induction drop-down on the user interface and prevent the user from adding a second read-write peer if one already exists. Similarly, a multi-master cluster will prevent the user from adding a second read-write peer if one already exists.

3.3.3 Cluster Subgroups

A cluster subgroup is a group of one or more nodes of the cluster.

A cluster can be conceptually divided into one or more cluster subgroups.

The node is assigned to a subgroup when you add the node to the multi-master cluster. **You can change the assignment at any time, so long as a certificate rotation operation is not in progress.** A node's cluster subgroup assignment is a property of the individual node, and members of a read-write pair may be in different cluster subgroups.

A cluster subgroup represents the notion of endpoint affinity. A node's cluster subgroup assignment is used to set the search order in the endpoint's node scan list. Nodes in the same cluster subgroup as an endpoint are considered local to the endpoint. You can check which node this refers to by checking the Cluster Subgroup column on the Endpoints page. The nodes within an endpoint's local subgroup are scanned first, before communicating with nodes that are not in the local subgroup.

The cluster topology can change when you add or remove new nodes to and from the cluster. Nodes can also be added or removed from the local cluster subgroup. Each endpoint may get updates to this information along with the response message for any successful non-empty operation which the endpoint initiated. The updated endpoint's node scan list is sent back to the endpoint periodically even if there is no change to cluster topology. This is to make up for any lost messages.

3.3.4 Critical Data in Oracle Key Vault

Oracle Key Vault stores critical data that is necessary for the endpoints to operate. Read-only nodes can read critical data as well.

The loss of this information can result in the loss of data on the [endpoint](#). Endpoint encryption keys, certificates, and similar [security objects](#) that Oracle Key Vault manages are examples of critical data in Oracle Key Vault. Critical data must be preserved in the event of an Oracle Key Vault server failure to ensure endpoint recovery and continued operations.

Oracle Key Vault data that can be re-created or discarded after an Oracle Key Vault server failure is non-critical data. Cluster configuration settings, alert settings, and email settings are examples of non-critical data.

3.3.5 Oracle Key Vault Read-Write Nodes

A read-write node is a node in which critical data can be added or updated using the Oracle Key Vault or endpoint software.

The critical data that is added or updated can be data such as keys, wallet contents, and certificates.

Oracle Key Vault read-write nodes always exist in pairs. Each node in the read-write pair can accept updates to critical and non-critical data, and these updates are immediately replicated to the other member of the pair, the read-write peer. A read-write peer is the specific member of one, and only one, read-write pair in the cluster. There is bi-directional synchronous replication between read-write peers. Replication to all nodes that are not a given node's read-write peer is asynchronous.

A node can be a member of, at most, one read-write pair. A node can have only one read-write peer. A node becomes a member of a read-write pair, and therefore a read-write node, during the induction process. A read-write node reverts to being a read-only node when its read-write peer is deleted, at which time it can form a new read-write pair.

A read-write node operates in read-write mode when it can successfully replicate to its read-write peer and when both peers are active. A read-write node is temporarily placed in read-only restricted mode when it is unable to replicate to its read-write peer or when its read-write peer is disabled.

An Oracle Key Vault multi-master cluster requires at least one read-write pair to be fully operational. It can have a maximum of 8 read-write pairs.

3.3.6 Oracle Key Vault Read-Only Nodes

In a read-only node, users can add or update non-critical data but not add or update critical data. However, read-only nodes can read critical data.

Critical data is updated only through replication from other nodes.

A read-only node is not a member of a read-write pair and does not have an active read-write peer.

A read-only node can induct a new server into a multi-master cluster. The new node can be another read-only node. However, a read-only node becomes a read-write node if it inducts another node as its read-write peer.

The first node in the cluster is a read-only node. Read-only nodes are used to expand the cluster. A multi-master cluster, after it has been built, does not need to have any read-only nodes. A multi-master cluster with only read-only nodes is not ideal because no useful critical data can be added to such a multi-master cluster.

3.3.7 Cluster Node Mode Types

Oracle Key Vault supports two types of mode for cluster nodes: read-only restricted mode or read-write mode.

- **Read-only restricted mode:** In this mode, only non-critical data can be updated or added to the node. Critical data can be updated or added only through

replication in this mode. There are two situations in which a node is in read-only restricted mode:

- A node is read-only and does not yet have a [read-write peer](#).
- A node is part of a read-write pair but there has been a breakdown in communication with its read-write peer or if there is a node failure. When one of the two nodes is non-operational, then the remaining node is set to be in the read-only restricted mode. When a read-write node is again able to communicate with its read-write peer, then the node reverts back to read-write mode from read-only restricted mode.
- **Read-write mode:** This mode enables both critical and non-critical information to be written to a node. A read-write node should always operate in the read-write mode.

You can find the mode type of the cluster node on the Monitoring page of the **Cluster** tab of the node management console. The **Cluster** tab of any node management console displays the mode type of all nodes in the cluster.

3.3.8 Operations Permitted on Cluster Nodes in Different Modes

In an Oracle Key Vault multi-master cluster, operations are available or restricted based on the node and the operating mode of the node.

Related Topics

- [Oracle Key Vault Multi-Master Cluster Operations](#)
There are restrictions and conditions for Oracle Key Vault multi-master cluster operations on cluster nodes.

3.4 Building and Managing a Multi-Master Cluster

You initialize a multi-master cluster using a single Oracle Key Vault server.

- [About Building and Managing a Multi-Master Cluster](#)
After the initial cluster is created in the Oracle Key Vault server, you can add the different types of nodes that you need for the cluster.
- [Creation of the Initial Node in a Multi-Master Cluster](#)
The initial node in a multi-master cluster must follow certain requirements before being made the initial node.
- [Expansion of a Multi-Master Cluster](#)
After you initialize the cluster, you can expand it by adding up to 15 more nodes, as either read-write pairs or read-only nodes.
- [Migration to the Cluster from an Existing Deployment](#)
You can migrate an existing Oracle Key Vault deployment to a multi-master cluster node.

3.4.1 About Building and Managing a Multi-Master Cluster

After the initial cluster is created in the Oracle Key Vault server, you can add the different types of nodes that you need for the cluster.

This Oracle Key Vault server seeds the cluster data and converts the server into the first cluster node, which is called the [initial node](#). The cluster is expanded when you induct additional Oracle Key Vault servers, and add them as [read-write nodes](#), or as simple [read-only nodes](#).

A multi-master cluster can contain a minimum of 2 nodes and a maximum of 16 nodes.

3.4.2 Creation of the Initial Node in a Multi-Master Cluster

The initial node in a multi-master cluster must follow certain requirements before being made the initial node.

You create a multi-master cluster by converting a single Oracle Key Vault server to become the initial node. The Oracle Key Vault server can be a freshly installed Oracle Key Vault server, or it can already be in service with existing data. A standalone server, or a primary server of a primary-standby configuration can be converted to the initial node of a cluster.

Before using the primary server of the primary-standby configuration, you must unpair the primary-standby configuration. For a primary-standby configuration, you can use either of the following methods to upgrade to a cluster:

- Method 1:
 1. Back up the servers.
 2. Upgrade both the primary and standby servers to the latest release.
 3. Unpair the paired primary and standby servers. (Before you unpair the servers, see *Oracle Key Vault Release Notes* for known issues regarding the unpair process.)
 4. Convert the primary server to be the first node of the cluster.
- Method 2:
 1. Back up the servers.
 2. Unpair the paired primary and standby servers.
 3. Upgrade the former primary server to the latest release.
 4. Convert the primary server to be the first node of the cluster.

The freshly installed servers must be of the same current version as the initial node. The initial node is special in that it provides the entirety of the data with which the cluster is initialized. This happens only once for the cluster when it is created. The data provided by the initial node will include but is not limited to the following components:

- Certificates, keys, wallets, and other security objects
- Users and groups
- Endpoint information
- Audits
- Reports

All other nodes added after the initial node must be created from freshly installed Oracle Key Vault servers.

The cluster name is chosen when the initial node is created. Once this name is chosen, you cannot change the cluster name.

The cluster subgroup of the initial node is also configured when the initial node is created. You must configure an Oracle Key Vault server that is converted to the initial node to use a valid Network Time Protocol (NTP) setting before you begin the conversion. The initial node always starts as a [read-only node](#) in [read-only restricted mode](#).

Related Topics

- [Creating the First \(Initial\) Node of a Cluster](#)
To create a cluster, you must convert an existing standalone Oracle Key Vault server to become the first node in the cluster.
- [Oracle Key Vault Release Notes](#)

3.4.3 Expansion of a Multi-Master Cluster

After you initialize the cluster, you can expand it by adding up to 15 more nodes, as either read-write pairs or read-only nodes.

- [About the Expansion of a Multi-Master Cluster](#)
Node induction is the process of configuring an Oracle Key Vault server to operate as a multi-master cluster node.
- [Management of Cluster Reconfiguration Changes Using a Controller Node](#)
A controller node is the node that controls or manages a cluster reconfiguration change, such as adding, enabling, disabling, or removing nodes.
- [Addition of a Candidate Node to the Multi-Master Cluster](#)
A freshly installed Oracle Key Vault server that is being added to a cluster is called a candidate node.
- [Addition of More Nodes to a Multi-Master Cluster](#)
You add nodes one at a time, first as a single read-only node, and then later as read-write paired nodes.

3.4.3.1 About the Expansion of a Multi-Master Cluster

Node induction is the process of configuring an Oracle Key Vault server to operate as a multi-master cluster node.

A [controller node](#) inducts an Oracle Key Vault server that has been converted to a [candidate node](#) into the cluster.

To expand a multi-master cluster, you use the induction process found on the **Cluster** tab of the Oracle Key Vault Management console. Nodes added to the Oracle Key Vault multi-master cluster are initialized with the current cluster data. You can add nodes either as [read-write peers](#), or as [read-only nodes](#).

Related Topics

- [Adding a Node to Create a Read-Write Pair](#)
After you create the initial node, you must add an additional read-write peer to the cluster.
- [Adding a Node as a Read-Only Node](#)
To add a new read-only cluster node, you add a newly configured server from any existing cluster node.

3.4.3.2 Management of Cluster Reconfiguration Changes Using a Controller Node

A controller node is the node that controls or manages a cluster reconfiguration change, such as adding, enabling, disabling, or removing nodes.

A node is only a controller node during the life of the change. During induction, the controller node provides the server certificate and the data that is used to initialize the candidate node. Another node can be the controller node for a subsequent cluster change. One controller

node can only control one cluster configuration change at a time. Oracle Key Vault does not permit multiple cluster operations at the same time.

Oracle recommends that you perform one cluster operation at a time. Each concurrent operation will have its own controller node.

The following table shows the role of the controller and controlled nodes during various cluster configuration.

Cluster Configuration Operation	Controller Node	Node Being Controlled
Induction as the first node	Any server	The controller node itself
Induction as a read-only node	Any node	Any server
Induction as a read-write node	Any node that does not have a read-write peer	Any server
Disable a node	Any node in the cluster	Any node in the cluster
Enable a node	Only the disabled node can re-enable itself, and it can also not re-enable any other node	The disabled node itself
Delete a node	Any node in the cluster	Any other node in the cluster
Force Delete a node	Any node in the cluster	Any other node in the cluster
Manage inbound replication	Any node in the cluster	The node itself

3.4.3.3 Addition of a Candidate Node to the Multi-Master Cluster

A freshly installed Oracle Key Vault server that is being added to a cluster is called a candidate node.

In the process of adding the server to a cluster, Oracle Key Vault converts the server to a candidate node before it becomes a node of the cluster. To induct an Oracle Key Vault server to a cluster, you must provide necessary information such as the controller certificate, the server IP address, and the recovery passphrase so that the new candidate can successfully and securely communicate with the controller node.

You can convert an Oracle Key Vault server to be a candidate node by using the **Cluster** tab of the Oracle Key Vault Management console. When a candidate node is inducted into a multi-master cluster, any pre-existing data on that node is wiped out and then replaced by a copy of the data from the cluster.

3.4.3.4 Addition of More Nodes to a Multi-Master Cluster

You add nodes one at a time, first as a single read-only node, and then later as read-write paired nodes.

When an Oracle Key Vault multi-master cluster is first created, and only contains one node, that **initial node** is a **read-only node**. After you have created the initial node, you can induct additional read-only nodes or a **read-write peer**. After these nodes have been added, you can further add read-only nodes or add a read-write peer.

Because the initial node is in **read-only restricted mode** and no critical data can be added to it, Oracle recommends that you induct a second node to form a **read-write pair** with the first node. You should expand the cluster to have read-write pairs so that both critical and non-critical data can be added to the read-write nodes.

The general process for adding nodes to a cluster is to add one node at a time, and then pair these so that they become read-write pairs:

1. Add the initial node (for example, N1). N1 is a read-only node.
2. Add the second node, N2. N2 will be in read-only restricted mode during the induction process.
If you are adding N2 as the read-write peer of N1, then both N1 and N2 will become read-write nodes when N2 is added to the cluster. Otherwise, N1 and N2 will remain read-only nodes after you add N2 to the cluster. If you want to add N2 as the read-write peer of N1, then you must set **Add Candidate Node as Read-Write Peer** to **Yes** on N1 during the induction process. If you do not want N2 to be paired with N1, then set **Add Candidate Node as Read-Write Peer** to **No**. This example assumes that N2 will be made a read-write peer of N1.
3. Add a third node, N3, which must be a read-only node if N1 and N2 were made read-write peers, because the other two nodes in the cluster already are read-write peers. In fact, you can add multiple read-only nodes to this cluster, but Oracle recommends that you not do this, because when write operations take place, the few read-write nodes that are in the cluster will be overloaded. For optimum performance and load balancing, you must have more read-write pairs.
4. To create a second read-write pair for the cluster, when you add the next node (N4), set **Add Candidate Node as Read-Write Peer** to **Yes** to add node N4 to be paired with node N3.
Node N4 must be added from N3 to make the second read-write pair, because N3 is the only node without a read-write peer at this point. After you complete this step, at this stage the cluster has two read-write pairs: the N1-N2 pair, and the N3-N4 pair.
5. To create the next pairing, add the next read-only node (for example, N5), followed by node N6.
Be sure to set **Add Candidate Node as Read-Write Peer** to **Yes** when you add N6. Node N6 must be added to N5 because at this point, N5 is the only node without a read-write peer. By the time you complete this step, there will be three read-write pairs in the cluster: the N1-N2 pair, the N3-N4 pair, and the N5-N6 pair.

A freshly installed Oracle Key Vault server at the same version as the other nodes in the cluster, that is, at release 18.1 or later is converted to a [candidate node](#). You should ensure that the candidate has Network Time Protocol (NTP) configured.

Any node in the cluster can be the [controller node](#) given no other cluster change operations are in progress. The candidate and the controller node exchange information that enables the controller node to ascertain the viability of induction. Induction replicates the cluster data set to the candidate node. After a successful induction, you can configure the node to use the cluster-wide configuration settings. A cluster data set includes but is not limited to the following components:

- Certificates, keys, wallets, and other security objects
- Users and user groups
- Endpoint and endpoint group information
- Audit data
- Cluster name and cluster node details
- Cluster settings

The controller node assigns the node ID and the cluster subgroup for the candidate node. If the controller node provides an existing cluster subgroup during induction, then the candidate node becomes part of that subgroup. If the controller node provides the name of the cluster

subgroup that does not exist, then the cluster subgroup is created as part of the induction process and the candidate node is added to the cluster subgroup. You can have all endpoints associated with one subgroup, if you want. For example, all endpoints in data center A can be in one subgroup, and all endpoints in data center B can be in another subgroup. Endpoints that are in the same subgroup will prioritize connecting to the nodes in that subgroup before connecting to nodes in other subgroups.

A read-write node can become a read-only node if its read-write peer is deleted. This read-only node can be used to form another read-write pair.

Related Topics

- [Adding a Node as a Read-Only Node](#)
To add a new read-only cluster node, you add a newly configured server from any existing cluster node.
- [Creating an Additional Read-Write Pair in a Cluster](#)
Any node can be read-write paired with only one other node, and there can be multiple read-write pairs in a cluster.

3.4.4 Migration to the Cluster from an Existing Deployment

You can migrate an existing Oracle Key Vault deployment to a multi-master cluster node.

- [Conversion of an Oracle Key Vault Standalone Server to a Multi-Master Cluster](#)
You can migrate a standalone Oracle Key Vault deployment that is at an older release to a multi-master deployment.
- [Conversion from a Primary-Standby Server to a Multi-Master Cluster](#)
You can migrate an Oracle Key Vault primary-standby deployment to a multi-master deployment.

3.4.4.1 Conversion of an Oracle Key Vault Standalone Server to a Multi-Master Cluster

You can migrate a standalone Oracle Key Vault deployment that is at an older release to a multi-master deployment.

First, you must upgrade the server to the latest Oracle Key Vault release. After you complete the upgrade, you then can convert it to an [initial node](#).

If your Oracle Key Vault server deployment is already at the current release, then you can directly convert it to an initial node.

The initial node will retain all the data of the existing Oracle Key Vault standalone deployment. After you create the initial node of the cluster, you can add more nodes to this cluster as necessary. Ensure that the new nodes that you add were installed at the current version of the initial node.

Related Topics

- [Oracle Key Vault Release Notes](#)
- [Creating the First \(Initial\) Node of a Cluster](#)
To create a cluster, you must convert an existing standalone Oracle Key Vault server to become the first node in the cluster.

3.4.4.2 Conversion from a Primary-Standby Server to a Multi-Master Cluster

You can migrate an Oracle Key Vault primary-standby deployment to a multi-master deployment.

First, you must unpair the primary-standby server configuration. Then you should upgrade the unpaired former primary server to the latest Oracle Key Vault release. (Alternatively, you can perform the upgrade and then unpair the primary-standby server configuration.) After completing these steps, you can convert the upgraded, former primary server to an [initial node](#).

If you have the latest release of Oracle Key Vault in a primary-standby deployment, you must also unpair it before you can move it to a multi-master cluster. Then, you can directly convert the former primary server to an initial node.

Before you perform this kind of migration, you should back up the servers that are currently used in the primary-standby deployment.

Related Topics

- [Disabling \(Unpairing\) the Primary-Standby Configuration](#)
You can disable the primary-standby configuration by unpairing the primary and standby servers.
- [Creating the First \(Initial\) Node of a Cluster](#)
To create a cluster, you must convert an existing standalone Oracle Key Vault server to become the first node in the cluster.
- [Creation of the Initial Node in a Multi-Master Cluster](#)
The initial node in a multi-master cluster must follow certain requirements before being made the initial node.

3.5 Oracle Key Vault Multi-Master Cluster Deployment Scenarios

All multi-master cluster nodes can serve endpoints actively and independently.

They can do this while striving to maintain an identical cluster data set through continuous replication across the cluster. Deployment scenarios of the multi-master cluster can range from a small two-node cluster to large 16-node deployments spanning across data centers.

- [Cluster Size and Availability in Deployments](#)
In general, the availability of the critical data to the endpoints increases with the increasing size of the cluster.
- [Two-Node Cluster Deployment](#)
A single read-write pair formed with two Oracle Key Vault nodes is the simplest multi-master cluster.
- [Mid-Size Cluster Across Two Data Centers Deployment](#)
A two-data center configuration provides high availability, disaster recovery, and load distribution.

3.5.1 Cluster Size and Availability in Deployments

In general, the availability of the critical data to the endpoints increases with the increasing size of the cluster.

You may be required to disable both nodes in a read-write pair from the cluster together to undergo maintenance such as patching or upgrade. If you have a cluster of only two nodes, then this means that the endpoints may have downtime.

A two-node cluster is suitable for development and test environments where the endpoint downtime is non-critical. For small deployments where critical data is added or updated infrequently or can be controlled, a three-node cluster is acceptable. Large scale deployments under heavy load should deploy at least two read-write pairs to ensure endpoint continuity.

A three-node cluster with one read-write pair and one [read-only node](#) fares better than a two-node cluster because it provides endpoint continuity so long as no critical data is added or updated.

A four-node, two read-write pair cluster provides continuity for all endpoint operations while the nodes are in maintenance.

The cluster should ideally be comprised of read-write pairs. If network latency or network interruptions across data centers is of little concern, then you should deploy read-write pairs across data centers. In case of a disaster, where one node of a read-write pair is lost, the keys are preserved in the read-write peer. However, if the network latency or interruptions are of concern, then you should place the read-write pair in the same data center. A disaster resulting in the loss of read-write pair may result in the loss of keys or other data if the disaster strikes before the created data is asynchronously replicated to other nodes.

3.5.2 Two-Node Cluster Deployment

A single read-write pair formed with two Oracle Key Vault nodes is the simplest multi-master cluster.

A two-node multi-master cluster looks similar to a standard primary-standby environment, in that there are only two nodes. The significant difference is that unlike the primary-standby configuration where the standby is passive, both nodes are active and can respond to endpoint requests at the same time.

Using a two-node multi-master cluster provides the following advantages over a primary-standby environment:

- Both nodes can be actively queried and updated by endpoints unlike the primary-standby configuration where only the primary server can be queried.
- A multi-master cluster can be expanded to three or more nodes without downtime.
- If the nodes are in separate data centers, then endpoints can prioritize interacting with nodes in the same subgroup, rather than reach across the network to the primary server node.

The following figure describes the deployment used for a two-node, single data center.

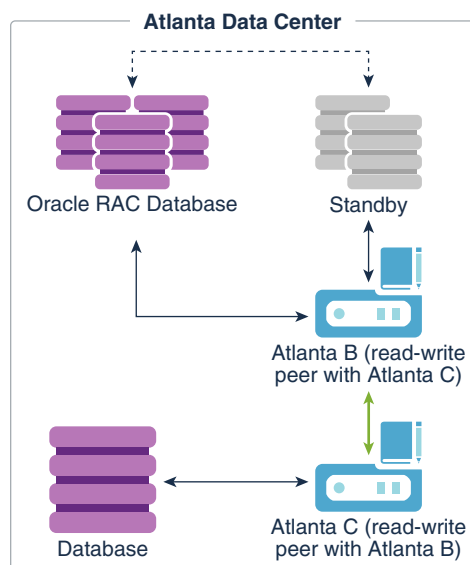
Figure 3-1 Oracle Key Vault Multi-Master Cluster Deployment in Single Data Center

In this scenario, the Atlanta Data Center hosts three databases, as follows:

- A single instance database
- A multi-instance Oracle Real Applications Clusters (Oracle RAC) database
- A multi-instance standby database for the Oracle RAC database

The Oracle RAC database and the associated standby database were enrolled using Atlanta B. Because Atlanta B and Atlanta C are in different cluster subgroups, the Oracle RAC database and associated standby database would have Atlanta B at the head of the endpoint node scan list and will prioritize connecting to Atlanta B over Atlanta C. Not shown is that each Oracle RAC instance would also be able to connect to Atlanta C.

There are two Oracle Key Vault servers, labeled Atlanta B and Atlanta C, presenting a read-write pair of Oracle Key Vault nodes. These nodes are connected by a bidirectional line indicating that these are read-write peers. Read-write peer nodes are synchronous, which enables an update to one node to be replicated to the other node, and verified this on the other node, before the update is considered successful.

The bottom database instance was enrolled using the Atlanta C node. To illustrate this connection, the database is connected by an arrow to Oracle Key Vault Atlanta C. Because Atlanta B and Atlanta C are in different cluster subgroups, for this database, Atlanta C would be at the head of the endpoint node scan list, meaning that the database would preferentially connect to Atlanta C.

In the event that either Oracle Key Vault node is offline (for example, for maintenance), then all endpoints will automatically connect to the other available Oracle Key Vault node.

3.5.3 Mid-Size Cluster Across Two Data Centers Deployment

A two-data center configuration provides high availability, disaster recovery, and load distribution.

At least two [read-write pairs](#) are required. A read-write pair is only created when you pair a new node with a read-only node as its read-write peer. As a best practice, you could configure the peers in different data centers if you are concerned about disaster recovery, or you could put the [read-write peers](#) in the same data center if you are concerned about network latency or network interruptions. Cluster nodes in the same data center should be part of the same cluster subgroup. You should ensure that all endpoints in a data center are in the same cluster subgroup as the nodes in that data center. This ensures that the nodes within a given data center are at the head of the endpoint node scan list for endpoints in the same data center.

For a large deployment, Oracle recommends that you have a minimum of four Oracle Key Vault servers in a data center for high availability. This enables additional servers to be available for key updates if one of the servers fails. When you register the database endpoints, balance these endpoints across the Oracle Key Vault servers. For example, if the data center has 1000 database endpoints to register, and you have Oracle Key Vault four servers to accommodate them, then enroll 250 endpoints with each of the four servers.

Each endpoint first contacts the Oracle Key Vault nodes in the local data center. If an outage causes all Oracle Key Vault nodes to be unavailable in one data center, then as long as connectivity to another data center is available, the endpoint node scan list will redirect the endpoints to available Oracle Key Vault nodes in another data center.

A possible deployment scenario with two data centers, each containing two read-write nodes, paired with read-write nodes in the other data center is shown in [Figure 3-2](#). A data center can also host one or more [read-only nodes](#) as needed for load balancing, reliability, or expansion purposes. In the scenario described in the following figure, each data center hosts a single read-only node.

Figure 3-2 Oracle Key Vault Multi-Master Cluster Deployment across Two Data Centers

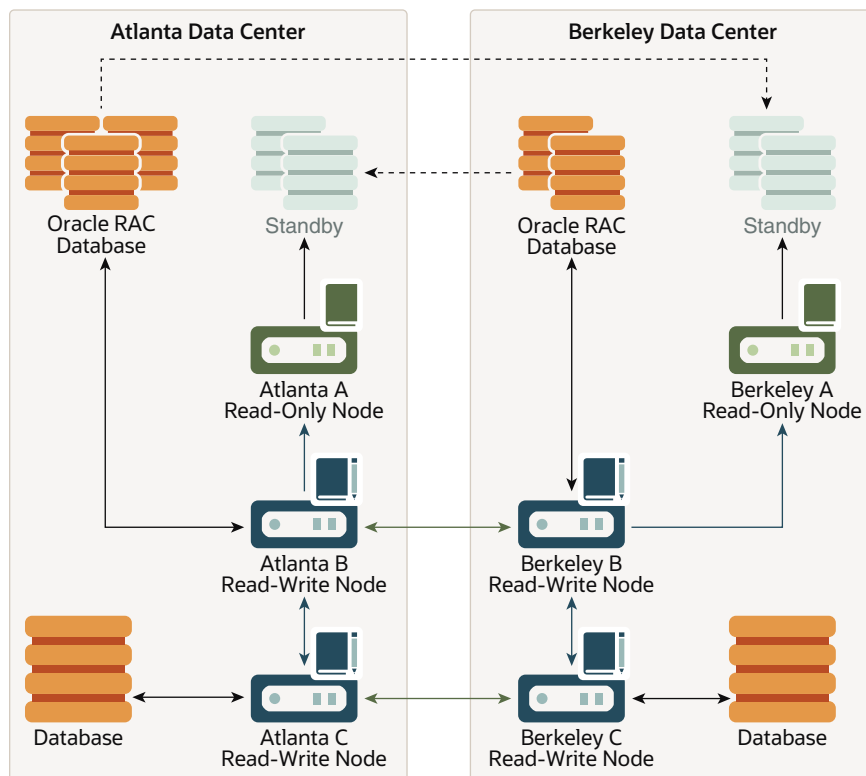

In this scenario, both the Atlanta Data Center and the Berkeley Data Center each hosts three databases, as follows:

- A single instance database
- A multi-instance Oracle RAC database
- A multi-instance standby database for the Oracle RAC database

The dotted lines connecting the Oracle RAC databases to the standby databases represent database transactions. Note that this data is unidirectional, going from the database to the standby only. The Atlanta Data Center Oracle RAC Database sends data to the Berkeley Standby database, and the Berkeley Oracle RAC Database sends data to the Atlanta Standby database.

Atlanta Data Center and Berkeley Data Center each have three Oracle Key Vault nodes, with two being read-write and one being read-only, and all in the same cluster. These nodes are configured as follows:

- Atlanta A Read-Only Node and Berkeley A Read-Only Node are read-only nodes, in which critical data additions or updates are unidirectional, going from the read-write node to the read-only node.
- Atlanta B Read-Write Node is a read-write peer with Berkeley B Read-Write Node. The connection between these two nodes is bidirectional and enables them to be in sync at all times.
- Atlanta C Read-Write Node is a read-write peer with Berkeley C Read-Write Node. The relationship between these two nodes operates in the same way as the relationship between the Atlanta B and Berkeley B nodes.

All of the nodes replicate data to and receive replicated data from all other nodes. To maintain legibility, only some of these connections are shown, specifically:

- The read-write pair connection between Atlanta B Read-Write Node and Berkeley B Read-Write Node across the two data centers, in which the data flow is bidirectional
- The read-write pair connection between Atlanta C Read-Write Node and Berkeley C Read-Write Node across the two data centers, in which the data flow is bidirectional
- The regular connection between Atlanta B Read-Write Node and Atlanta C Read-Write Node in the Atlanta Data Center, in which the data flow is bidirectional
- The regular connection between Berkeley B Read-Write Node and Berkeley C Read-Write Node in the Berkeley Data Center, in which the data flow is bidirectional
- The regular connection between Atlanta B Read-Write Node to Atlanta A Read-Only Node in the Atlanta Data Center, in which the critical data flow is unidirectional from the read-write node to the read-only node
- The regular connection between Berkeley B Read-Write Node and Berkeley A Read-Only Node in the Berkeley Data Center, in which the critical data flow is unidirectional from the read-write node to the read-only node

Nodes in the same data center have been assigned the same cluster subgroups. For example, nodes in the Atlanta Data Center have been given the cluster subgroup Atlanta, and nodes in the Berkeley Data Center have been given the cluster subgroup Berkeley. Endpoints that are in the Atlanta Data Center are enrolled using one of Oracle Key Vault nodes that are also in the Atlanta Data Center, so that the endpoints preferentially connect to the nodes within the same data center. The same is true, respectively, for the endpoints in the Berkeley Data Center. In [Figure 3-2](#), the following connections are shown, which imply the first entry in each client endpoint node scan list. Note that if an endpoint is in the same cluster

subgroup as at least one node in the cluster, the first entry in the endpoint node scan list will be randomly chosen from the nodes that are in the same cluster subgroup as the endpoint:

- In Atlanta Data Center:
 - The Oracle RAC Database connects to Atlanta B Read-Write Node, with the data going in a bidirectional flow.
 - The Atlanta A Read-Only Node connect to the Standby, with the data going from the read-only node to the standby in a unidirectional flow.
 - The Database connects to the Atlanta C Read-Write Node, with the data going in a bidirectional flow.
- In Berkeley Data Center:
 - The Oracle RAC Database connects to Berkeley B Read-Write Node, with the data going in a bidirectional flow.
 - The Berkeley A Read-Only Node connects to the Standby, with the data going from the read-only node to the standby in a unidirectional flow.
 - The Database connects to Berkeley C Read-Write Node, with the data going in a bidirectional flow.

In the event that Atlanta C Read-Write node cannot be reached or does not have the necessary key, the database that connected to it will connect to other Oracle Key Vault nodes to fetch the key.

Related Topics

- [Oracle Key Vault Read-Write Nodes](#)
A read-write node is a node in which critical data can be added or updated using the Oracle Key Vault or endpoint software.
- [Oracle Key Vault Read-Only Nodes](#)
In a read-only node, users can add or update non-critical data but not add or update critical data. However, read-only nodes can read critical data.

3.6 Multi-Master Cluster Features

Oracle Key Vault provides features that help with inconsistency resolution and name conflict resolution in clusters, and endpoint node scan lists.

- [Cluster Inconsistency Resolution in a Multi-Master Cluster](#)
Network outages can introduce inconsistency in data in a cluster, but when the outage is over and the network connection resumes, the data will become consistent again.
- [Name Conflict Resolution in a Multi-Master Cluster](#)
Naming conflicts can arise when an object has the same name as another object in a different node.
- [Endpoint Node Connection Lists \(Endpoint Node Scan Lists\)](#)
An endpoint node scan list is a list of nodes to which the endpoint can connect.

3.6.1 Cluster Inconsistency Resolution in a Multi-Master Cluster

Network outages can introduce inconsistency in data in a cluster, but when the outage is over and the network connection resumes, the data will become consistent again.

A node can be disconnected from other nodes in the cluster voluntarily or involuntarily. When a node becomes available to the cluster after being voluntarily disconnected, any data changes in the cluster are replicated to the node. Network disruptions, power outages, and other disconnects can happen any time for any Oracle Key Vault node, causing an involuntary disconnection from other nodes in the cluster. Such failures interrupt the data replication processes within a multi-master cluster. Temporary failures do not always introduce inconsistency to a cluster. As soon as the problem is addressed, the data replication process will resume from the moment it was halted. This ensures that even after some disconnections, disconnected Oracle Key Vault nodes will be able to synchronize themselves with the other nodes in the cluster eventually.

Any change made in a read-write node is guaranteed to be replicated to the other paired read-write node. Therefore, even if the read-write node suffers a failure, the data is available on at least one other node in the cluster.

3.6.2 Name Conflict Resolution in a Multi-Master Cluster

Naming conflicts can arise when an object has the same name as another object in a different node.

Users must specify names when creating virtual wallets, users, user groups, endpoints, and endpoint groups. A name conflict arises when two or more users create the same type of object with the same name on different nodes before the object has been replicated. If the object has been replicated on other nodes, then the system prevents the creation of objects with duplicate names. But replication in the Oracle Key Vault cluster is not instantaneous, so there is a possibility that during the replication window (which can be in the order of seconds), another object with the same name may have been created in this cluster. If this happens, it becomes a name conflict. Name conflicts have obvious drawbacks. For example, the system cannot distinguish between the references to two objects with duplicate names. Uniqueness in names is thus enforced to avoid inconsistencies in the cluster. All other object names must be unique within their object type, such as wallets, endpoint groups, user groups, and any other object type. For example, no two wallets may have the same name within the cluster. User names and endpoint names must not conflict.

While rare, a naming conflict can still arise. When this occurs, Oracle Key Vault detects this name conflict and raises an alert. Oracle Key Vault then will append `_OKVxx` (where `xx` is the node ID of the node on which the renamed object was created) to the name of the conflicting object that was created later. You can choose to accept this suggested object name or rename the object.

To accept or change a conflicting object name, click the **Cluster** tab, then **Conflict Resolution** from the left navigation bar to see and resolve all conflicts.

3.6.3 Endpoint Node Connection Lists (Endpoint Node Scan Lists)

An endpoint node scan list is a list of nodes to which the endpoint can connect.

An [endpoint](#) connects to an Oracle Key Vault server or node to manage or access wallets, keys, certificates, and credentials.

In a standalone situation the endpoint node scan list has one entry. In a primary-standby configuration, the endpoint can connect to one of two servers.

In an Oracle Key Vault multi-master cluster, the endpoint node scan list is the list of all the nodes in the cluster. There is a [read-only node](#) list and [read-write node](#) list. Node subgroup assignments and node modes influence the order of nodes in the endpoint node scan list. The list is made available to the endpoint at the time of endpoint enrollment. The list is maintained automatically to reflect the available nodes in the cluster. This list tracks changes to the cluster and makes them available to the endpoints. The following events will trigger a change to the endpoint node scan list:

- A change of cluster size, for example due to node addition or node removal
- A change to the mode of the node, for example when a node in read-only restricted mode changes to read-write mode
- An hour has passed since the last endpoint update
- A change to an endpoint's or a node's assigned cluster subgroup

The endpoint gets the updated scan list along with the next successful, non-empty response. Once the scan list is sent by the node, it marks the scan list as sent to the endpoint. It is possible that a scan list sent to the endpoint and marked sent in the node, may not be applied at the endpoint. As such the cluster periodically sends the scan list to the endpoint even if there are no changes to the cluster nodes or the modes of any of the cluster nodes.

3.7 Cluster Management Information

The Cluster Management page provides a concise overview of the cluster and the status of each node.

You can also manage the cluster from the cluster details section. When a node is performing a cluster operation it becomes the [controller node](#).

Be aware that because the replication across the cluster takes time, there may be a delay before the Cluster Management page refreshes with the new cluster status. The [replication lag](#) in the monitoring page will help estimate the delay.

To view the Cluster Management page, click the **Cluster** tab, and then **Management** from the left navigation bar.

Cluster Information

Cluster Name	Cluster1
Cluster Subgroups	Group1
Maximum Disable Node Duration	24 hrs ⓘ
Cluster Version	211.0.0.0

Current Node Information

Node Name	Node1_181
Node Type	Read-Write
Cluster Subgroup	Group1

Cluster Details
[Edit](#) [Add](#) [Delete](#) [Force Delete](#) [Disable](#)

Select Node	Node ID ↑	Name	IP Address	Mode	Status	Read-Write Peer	Cluster Subgroup	Join Date	Disable Date	Version
<input type="checkbox"/>	1	Node1_181	10.240.112.181	Read-Write	ACTIVE	Node2_182	Group1	07-JAN-2021 11:30:32	-	211.0.0.0
<input type="checkbox"/>	2	Node2_182	10.240.112.182	Read-Write	ACTIVE	Node1_181	Group1	07-JAN-2021 15:42:49	-	211.0.0.0

Cluster Information

- **Cluster Name:** The name of the cluster.
- **Cluster Subgroups:** All subgroups within the cluster.
- **Maximum Disable Node Duration:** The maximum time, in hours, that a node can be disabled before it can no longer be enabled.
- **Cluster Version:** The version of Oracle Key Vault in which the cluster is operating.

Current Node Information

- **Node Name:** The name of this node.
- **Node Type:** The type of node, such as whether it is read-only or read-write.
- **Cluster Subgroup:** The subgroup to which this node belongs.

Cluster Details

- **Select Node:** Used to select a node for a specific operation, such as delete, force delete, or disable.
- **Node ID:** The ID of the node.
- **Node Name:** The name of the node. Clicking the node name takes you to the Cluster Management page of that node.
- **IP Address:** The IP address of the node.
- **Mode:** The mode in which the node is operating, such as read-write or read-only restricted.
- **Status:** The status of the node, such as active, pairing, disabling, disabled, enabling, deleting, or deleted.
- **Read-Write Peer:** The read-write peer of the node. If blank, it has no read-write peer.
- **Cluster Subgroup:** The subgroup to which the node belongs. You can change this by 1) checking the check box next to a node, 2) clicking the **Edit** button, which displays a window, 3) entering a new cluster subgroup in the field, and 4) clicking **Save**.
- **Join Date:** The date and time that the node was added to the cluster or most recently enabled
- **Disable Date:** The date and time that the node was disabled.
- **Node Version:** The current version of the Oracle Key Vault node.

4

Managing Oracle Key Vault Multi-Master Clusters

You can create, configure, manage, and administer an Oracle Key Vault multi-master cluster by using the Oracle Key Vault management console.

- [About Managing Oracle Key Vault Multi-Master Clusters](#)
You can add or remove nodes from the cluster, disable or enable cluster nodes, and manage activities such as node conflicts and replication.
- [Setting Up a Cluster](#)
After you add an initial node to a cluster, you can add more nodes, thereby creating read-write pairs of nodes or read-only nodes.
- [Terminating the Pairing of a Node](#)
On the controller node, you can terminate the pairing process for a new node.
- [Disabling a Cluster Node](#)
You can temporarily disable a cluster node, which is required for upgrades and maintenance.
- [Enabling a Disabled Cluster Node](#)
You can enable any cluster node that was previously disabled. You must perform this operation from the disabled node.
- [Deleting a Cluster Node](#)
You can permanently delete a node from the cluster.
- [Force Deleting a Cluster Node](#)
You can permanently force delete a node from a cluster that is dead, unresponsive, or has exceeded the maximum disabled node time limit.
- [Managing Replication Between Nodes](#)
You can enable and disable node replication from the Oracle Key Vault management console.
- [Cluster Management Information](#)
The Cluster Management page provides a concise overview of the cluster and the status of each node.
- [Cluster Monitoring Information](#)
The Cluster Monitoring page provides the replication health of the cluster and the current node.
- [Naming Conflicts and Resolution](#)
Oracle Key Vault can resolve naming conflicts that can arise as users create objects such as endpoints, endpoint groups, and user groups.
- [Multi-Master Cluster Deployment Recommendations](#)
Oracle provides deployment recommendations for deployments that have two or more nodes.

4.1 About Managing Oracle Key Vault Multi-Master Clusters

You can add or remove nodes from the cluster, disable or enable cluster nodes, and manage activities such as node conflicts and replication.

4.2 Setting Up a Cluster

After you add an initial node to a cluster, you can add more nodes, thereby creating read-write pairs of nodes or read-only nodes.

- [About Setting Up a Cluster](#)
You create a multi-master cluster by converting a single Oracle Key Vault server to become the initial node.
- [Creating the First \(Initial\) Node of a Cluster](#)
To create a cluster, you must convert an existing standalone Oracle Key Vault server to become the first node in the cluster.
- [Adding Nodes to a Cluster](#)
After you have created a cluster to have the initial node, you can add more nodes to the cluster.

4.2.1 About Setting Up a Cluster

You create a multi-master cluster by converting a single Oracle Key Vault server to become the initial node.

This Oracle Key Vault server seeds the cluster data and converts the server into the first cluster node, which is called the initial node.

After the initial cluster is created in the Oracle Key Vault server, you can add the different types of nodes that you need for the cluster. The cluster is expanded when you induct additional Oracle Key Vault servers, and add them as read-write nodes, or as simple read-only nodes.

4.2.2 Creating the First (Initial) Node of a Cluster

To create a cluster, you must convert an existing standalone Oracle Key Vault server to become the first node in the cluster.

This first node is called the initial node. The standalone Oracle Key Vault server can also be a server that has been upgraded to Oracle Key Vault release 18.1 or later from a previous release, or it can also be the server that is unpaired from a primary-standby configuration. Check *Oracle Key Vault Release Notes* for known issues about unpair operations and upgrades.

You can use this node to add one or more nodes to the cluster. The node operates in read-only restricted mode until it is part of a read-write pair.

1. Perform a full backup of the Oracle Key Vault server to a remote destination.
2. Log into the Oracle Key Vault management console as a user who has the System Administrator role.

3. If the Oracle Key Vault server was upgraded from a release earlier than Oracle Key Vault release 12.2 (bundle patch 8), then generate and activate (rotate) a new certificate for the node.

If this step does not apply to your deployment, then you can bypass it.

4. Select the **Cluster** tab, and then select **Configure** from the left navigation bar.
5. In the Configure as Candidate Node page, enter the following settings:
 - **First Node of Cluster:** Select the **Yes** button.
 - **Node Name:** Enter a unique name for this node. This field is auto-populated with the Oracle Key Vault server name as the node name. You may specify another name. You cannot change this name later.
 - **Cluster Name:** Enter a name for this cluster of nodes. You cannot change this name later.
 - **Cluster Subgroup:** Enter a name for this sub-group of nodes, such as a data center name or a logical group name.
6. Click **Convert to Candidate Node**.

The conversion can take several minutes. After the conversion is complete, the Cluster Management page is displayed and the node is now operating in read-only restricted mode. At this stage, you can add another node to this cluster. In that case, the initial node will no longer be a candidate node: it will become the controller node and the new node will be the candidate node. The data on the controller node will overwrite the data on the candidate node.

Related Topics

- [Rotating All Certificates](#)
You can use the Oracle Key Vault management console to rotate certificates.
- [Managing Certificates](#)
In addition to Oracle Key Vault-generated certificates, you can manage third-party certificates.
- [Oracle Key Vault Release Notes](#)

4.2.3 Adding Nodes to a Cluster

After you have created a cluster to have the initial node, you can add more nodes to the cluster.

- [Adding a Node to Create a Read-Write Pair](#)
After you create the initial node, you must add an additional read-write peer to the cluster.
- [Adding a Node as a Read-Only Node](#)
To add a new read-only cluster node, you add a newly configured server from any existing cluster node.
- [Creating an Additional Read-Write Pair in a Cluster](#)
Any node can be read-write paired with only one other node, and there can be multiple read-write pairs in a cluster.

4.2.3.1 Adding a Node to Create a Read-Write Pair

After you create the initial node, you must add an additional read-write peer to the cluster.

You can configure any two nodes as a read-write pair. However, any single node can be read-write paired with only one other node.

To create a read-write pair using two nodes in a cluster, you pair a node (referred to as the controller node) with a newly configured server (referred to as the candidate node). Note that this will take some time: an hour or more, depending on the speed of your server, network, and volume of data in the cluster. Be aware that the controller node will be unable to service endpoints during certain parts of this operation.

1. Perform a full backup of the controller node to a remote destination before continuing.
2. Ensure that the following network requirements are in place:
 - There is good network connectivity between the servers that host the controller node and the candidate node.
 - The ports that are required for Oracle Key Vault are open in the network firewall. These ports are described in *Oracle Key Vault Installation and Upgrade Guide* .
3. As a user who has the System Administrator role, log in to the Oracle Key Vault management console of the node that you want to use as a controller node .

You can use any existing node, including the first node, that does not have a read-write peer to be the controller node for this operation. If necessary, add a read-only node first.

4. Select the **Cluster** tab, and then select **Management** from the left navigation bar.
5. Under Cluster Details, select **Add**.
6. In the Add Candidate Node to Cluster page, under Add Cluster Details, enter the recovery passphrase in the **Recovery Passphrase of the Cluster** field.

This value will be used later when you pair with the candidate node. The recovery passphrase is that of the first node of the cluster and will be used later across all the cluster nodes.

7. Enter the following details under Add Candidate Node Details.

While you enter these details, do not save any of this information or click the **Add Node** button until you reach Step 14.

- **Add Node as Read-Write Peer:** Select **Yes**.
- **Node ID:** Select a unique ID for the candidate node. Remember that after you create this ID, you cannot change it. **Node ID** is auto populated but you may change it. Ensure that the candidate node ID is unique in the cluster.
- **Node Name:** Enter a unique name of the candidate node. After you create this name, you cannot change it.
- **Cluster Subgroup:** Enter the sub-group name for the candidate node. You can provide an existing subgroup name. If you provide a subgroup name that does not exist, it will be created. (This field is auto-populated with the cluster subgroup name of the controller node.)

- **Cluster Name** is auto-populated and cannot be changed.
- **IP Address:** Enter the IP address of the candidate node.
- **Certificate of Candidate Node:** The next steps explain how you can find the certificate of the candidate node.

Do not exit this page.

8. In a new browser window, log into the Oracle Key Vault management console of the candidate node as a user who has the System Administrator role.
9. Select the **Cluster** tab, and then select **Configure** from the left navigation bar.
10. In the Configure as Candidate Node page, enter the following details:
 - **First Node of the Cluster:** Select **No**. Selecting **No** shows additional fields to enter.
 - **Recovery Passphrase of the Cluster:** enter the recovery passphrase of the cluster that you entered earlier for the controller node.
 - **IP Address:** enter the IP address of the controller node.
 - **Certificate of Controller Node:** Use these steps to enter certificate of controller node.
 - In the browser window for the controller node, scroll to the bottom of the screen. Select and copy the entire certificate value shown for **Certificate of Controller Node**.
 - In the browser window for the candidate node, paste the copied certificate from the controller node into the **Certificate of the Controller Node** field.
 - Check the recovery passphrase, the IP address, and the pasted in certificate very carefully to ensure that you copied it correctly. If there is an error, then after you click **Convert to Candidate Node**, you will need to terminate the pairing process or potentially reinstall Oracle Key Vault on this node.
11. Click **Convert to Candidate Node**.

The conversion can take several minutes. After the conversion is complete, the screen will refresh and the Adding Candidate Node to Cluster page is displayed. The certificate for the candidate node appears on this page.

12. Select and copy the entire candidate node certificate.
13. In the browser window of the controller node, paste the copied certificate from the candidate node into the **Certificate of Candidate Node** box.
14. Click **Add Node**.

This process will take an hour or more, depending on the speed of your server, network, and volume of data in the cluster. During this time, the network management interface of the Oracle Key Vault will be restarted and you might momentarily get a `Server Error 500` on the controller node. On the candidate node, errors may also appear, such as `Bad Gateway`. The candidate node will restart as part of the induction process. This is normal. During the pairing process, the status of the candidate node will display as `PAIRING` on all cluster nodes.

To view the status of any server, view the output on the management console.

After the candidate node restarts and completes the pairing process, you can log in to either cluster node to view the cluster status by selecting the Cluster tab. Both nodes will now show as `ACTIVE`. The candidate node may briefly display that it is in read-only restricted mode after it automatically restarts. This node is now a synchronously paired

cluster node and no longer a candidate node. After a node is part of a cluster, the console will display the node name, subgroup name, and cluster name in the top right area of the console header.

4.2.3.2 Adding a Node as a Read-Only Node

To add a new read-only cluster node, you add a newly configured server from any existing cluster node.

The existing cluster node is referred to as the controller node, and the newly configured server is referred to as the candidate node. This process will take an hour or more, depending on the speed of your server, network, and volume of data in the cluster.

1. Perform a server backup before continuing.
2. Ensure that the following network requirements are in place:
 - There is good network connectivity between the servers that host the controller node and the candidate node.
 - The ports that are required for Oracle Key Vault are open in the network firewall. These ports are described in *Oracle Key Vault Installation and Upgrade Guide*.
3. Log into the controller node Oracle Key Vault management console as a user who has the System Administrator role.

You can use any existing node as a controller for this operation.

4. Select the **Cluster** tab, and then select **Management** from the left navigation bar.
5. In the Cluster Details section click **Add**.
6. In the Add Cluster Details section, enter the cluster recovery passphrase in the **Recovery Passphrase of the Cluster** field.

This value will be used later when pairing with the candidate node.

7. Under **Add Candidate Node Details**, enter the following information:
 - **Add Node as Read-Write Peer**: Select **No**.
 - **Node ID**: Select a unique ID for the candidate node. Remember that after you create this ID, you cannot change it. **Node ID** is auto populated but you may change it. Ensure that the candidate node ID is unique in the cluster.
 - **Node Name**: Enter a unique name of the candidate node. After you create this name, you cannot change it.
 - **Cluster Subgroup**: Enter the subgroup name for the candidate node. You can provide an existing subgroup name. If you provide a subgroup name that does not exist, then it will be created.
 - **Cluster Name**: This name is populated automatically.
 - **IP Address**: Enter the IP address of the candidate node.

Do not exit this page.

8. In a new browser window, log into the Oracle Key Vault management console of the candidate node as a user who has the System Administrator role.
9. Select the **Cluster** tab, and then select **Configure** from the left navigation bar.

The Configure as Cluster Candidate page appears.

10. In the Configure as Candidate Node page, enter the following details:
 - **First Node of the Cluster:** Select **No**. Selecting **No** shows additional fields to enter.
 - **Recovery Passphrase of the Cluster:** enter the recovery passphrase of the cluster that you entered earlier for the controller node.
 - **IP Address:** enter the IP address of the controller node.
 - **Certificate of Controller Node:** Use these steps to enter certificate of controller node.
 - In the browser window for the controller node, scroll to the bottom of the screen. Select and copy the entire certificate value shown for **Certificate of Controller Node**.
 - In the browser window for the candidate node, paste the copied certificate from the controller node into the **Certificate of the Controller Node** field.
 - Check the recovery passphrase, the IP address, and the pasted in certificate very carefully to ensure that you copied it correctly. If there is an error, after you click **Convert to Candidate Node**, you will need to terminate the pairing process or potentially reinstall Oracle Key Vault on this node.
11. Click **Convert to Candidate**.

The conversion can take several minutes. After the conversion is complete, the screen will refresh and the Adding Candidate Node to Cluster page is displayed. The certificate for the candidate node appears on this page.

12. Select and copy the entire candidate node certificate.
13. In the browser window of the controller node, paste the copied certificate from the candidate node into the **Certificate of Candidate Node** box.
14. Click **Add Node**.

This process will take an hour or more, depending on the speed of your server, network, and volume of data in the cluster. During this time, the Oracle Key Vault console of the controller node will become unresponsive and can display an error such as `Server Error 500`. On the candidate node, errors may also appear, such as `Bad Gateway`. The candidate node will restart as part of the synchronization process. This is normal. During the pairing process, the status of the candidate node will display as `PAIRING` on all other cluster nodes not involved in this pairing process.

To view the status of any server, view the output on the server console.

After the candidate node restarts and completes the pairing process, you can log into either cluster node to view the cluster status by selecting the **Cluster** tab. Both nodes will now show as `ACTIVE`. The candidate node may briefly display that it is in read-only restricted mode after it automatically restarts. This node is now a read-only paired cluster node and no longer a candidate node. After a node is part of a cluster, the console will display the node name, sub-group name, and cluster name in the top right area of the console header.

4.2.3.3 Creating an Additional Read-Write Pair in a Cluster

Any node can be read-write paired with only one other node, and there can be multiple read-write pairs in a cluster.

1. Select a read-only cluster node as the controller node to pair with a new candidate node.

- Follow the steps to create a read-write pair of nodes in a cluster.

Related Topics

- [Adding a Node to Create a Read-Write Pair](#)
After you create the initial node, you must add an additional read-write peer to the cluster.

4.3 Terminating the Pairing of a Node

On the controller node, you can terminate the pairing process for a new node.

Be aware that when the controller node performs this operation, then it will experience network changes that will temporarily prevent it from serving endpoints.

- On the controller node, in the **Status** section of the Adding Candidate Node to Cluster page, click the **Abort** button.

The screenshot shows the 'Adding Candidate Node to Cluster' page. The 'Controller Node Information' section displays: Node Name: node1, Cluster Subgroup: austin, Cluster Name: oracle. Below this is a 'Certificate of Controller Node' field. The 'Status' section features an 'Abort' button and an 'Activity' table titled 'Current node processing'.

Id	Stage	Status
1	Transport channel opened with the candidate node	✓
2	Verified the candidate node details	✓
3	Generated the controller node details	✓
4	Generated backup of the controller node for cloning	✓
5	Clone bundle sent to the candidate node	
6	Data replication (downstream mining configuration) to the candidate node enabled	
7	Data replication to other cluster nodes enabled	
8	The candidate node successfully joined the cluster	

At the bottom of the Status section is a 'Details' button.

- A dialog with the message **Are you sure you want to ABORT the addition of the new node?** will appear. Select **OK**.

After the pairing process terminates, you will be returned to the **Add Node to Cluster** page on the controller node.

If you terminate the pairing of a candidate node from the controller node, then depending on how far the candidate node is into the induction process, you may or may not be able to return the candidate node to a standalone state. You can attempt to terminate the pairing process from the candidate node. If you are unable to terminate the pairing process from the candidate node, then the candidate node is no longer usable in its current state, and you must re-image the candidate node.

4.4 Disabling a Cluster Node

You can temporarily disable a cluster node, which is required for upgrades and maintenance.

However, be aware that a node can only be disabled for a set period of time. When it exceeds that time, it cannot be enabled again. The default maximum disable node duration time is 24 hours, but you can set it for as high as 240 hours. Note that as this value is increased, the average amount of disk space consumed by cluster-related data also increases.

Do not attempt disabling a node unless replication between all nodes is healthy. Failure to do so will result in a node stuck in the `DISABLING` state. To return such a node back to the `ACTIVE` state, you can cancel the disable operation by clicking the **Cancel Disable** button.

1. Log into any cluster Oracle Key Vault management console as a user who has the System Administrator role.
2. Select the **Cluster** tab, and then select **Management** from the left navigation bar.
3. Under Cluster Details, in the **Select Node** column, select the check box of the node to disable.
4. Click **Disable**.

On the node that is being disabled, the node status will display as `DISABLING` during the disabling process. The other nodes will display the status for this node as `DISABLED`. When the disabling process is complete, the node that you disabled displays the `DISABLED` status.

Related Topics

- [Configuring the Maximum Disable Node Duration for the Cluster](#)
You can set the maximum disable node duration time for the cluster in hours.

4.5 Enabling a Disabled Cluster Node

You can enable any cluster node that was previously disabled. You must perform this operation from the disabled node.

1. As a user who has the System Administrator role, log into the Oracle Key Vault management console of any active node in the cluster.
2. Select the **Cluster** tab, and then select **Management** from the left navigation bar.
3. In the Cluster Details section, note the dates in which the nodes have been disabled.
Oracle recommends that you enable the nodes in the reverse order in which they were disabled. Otherwise, the enabling action may not be able to complete.
4. In the Cluster Details section, under Name, click the name of the node that was disabled most recently.
Clicking the node name enables you to log in to this node. You can only enable disabled nodes from the disabled node itself.
5. Select **Enable**.
You do not need to check the check box of the disabled node in the Cluster Details table.
6. Repeat this step for each disabled node, from the most recent to the node that was disabled first.

4.6 Deleting a Cluster Node

You can permanently delete a node from the cluster.

Deleted nodes cannot be added back to any cluster, not just to the current cluster from which they were deleted. However, you can reinstall the Oracle Key Vault appliance software on this server and add the deleted node to a cluster. All data will be synchronized with the cluster before the node is deleted. A node cannot delete itself. Be aware that if a deleted node has a read-write peer, then this read-write peer node will experience network changes that will temporarily prevent it from serving endpoints.

1. As a user who has the System Administrator role, on a different node, log into the Oracle Key Vault management console.

A node cannot delete itself.

2. Select the **Cluster** tab, and then select **Management** from the left navigation bar.
3. Under Cluster Details, in the **Select Node** column, select the check box of the node to delete.
4. Click **Delete**.

The node status will display as `DELETING`. After it is deleted, it will show as `DELETED`, or later be removed from the cluster management page.

This action is immediate. The node status will display as `DELETING`. Do not shut down the deleted server until it no longer shows in the Cluster Details table on the Cluster Management page. However, Oracle recommends that you wait an hour after deleting a cluster node before reusing the node ID of the node that was deleted.

4.7 Force Deleting a Cluster Node

You can permanently force delete a node from a cluster that is dead, unresponsive, or has exceeded the maximum disabled node time limit.

Forcefully deleting a node that is still a part of a cluster may cause inconsistency in the cluster. Be aware that if the read-write peer of the node that was forcefully deleted is also removed from the cluster before confirming that all critical data from the forcefully deleted node has reached other nodes, then data loss can result. When you forcefully delete a node, ensure that the node to be deleted has first been shut down. A node cannot be deleted from its own management console. When you must forcefully delete a node, ensure that the node to be deleted has first been shut down. Deleted nodes cannot be added back to the cluster. However, you can reinstall the Oracle Key Vault appliance software on a server and then add the deleted node to a cluster. Be aware that if a deleted node has a read-write peer, then this read-write peer node will experience network changes that will temporarily prevent it from serving endpoints.

1. On a different node, log into the Oracle Key Vault management console as a user who has the System Administrator role.

A node cannot delete itself. Oracle recommends that if the node to be deleted has a read-write peer, to force delete the node from its read-write peer.

2. Select the **Cluster** tab, and then select **Management** from the left navigation bar.
3. Under Cluster Details, in the **Select Node** column, select the check box of the node to disable.

4. Click **Force Delete**.

The node status will display as `DELETING`. After it is deleted, it will show as `DELETED`, or later be removed from the cluster management page. Oracle recommends that you wait an hour after force deleting a cluster node before reusing the node ID of the node that was deleted.

4.8 Managing Replication Between Nodes

You can enable and disable node replication from the Oracle Key Vault management console.

- [Restarting Cluster Services](#)
While managing replication between nodes, you can restart a node's cluster services when the cluster service status for the node is down.
- [Disabling Node Replication](#)
You can disable the replication link between the current node and any other node in a cluster.
- [Enabling Node Replication](#)
You can enable the replication link between the current node and any other node in a cluster.

4.8.1 Restarting Cluster Services

While managing replication between nodes, you can restart a node's cluster services when the cluster service status for the node is down.

1. Log into Oracle Key Vault management console of any cluster node as a user who has the System Administrator role.
2. Select the **Cluster** tab, and then **Monitoring** from the left navigation bar.
3. In the Node State pane, click the **Restart Cluster Services** button.

4.8.2 Disabling Node Replication

You can disable the replication link between the current node and any other node in a cluster.

1. Log into Oracle Key Vault management console of any cluster node as a user who has the System Administrator role.
2. Select the **Cluster** tab, and then **Monitoring** from the left navigation bar.
3. Under Cluster Link State, select the check boxes for the nodes for which you want to disable replication.
4. Click **Disable**.
5. Click **OK** to confirm in the dialog box.

4.8.3 Enabling Node Replication

You can enable the replication link between the current node and any other node in a cluster.

1. As a user who has the System Administrator role, log in to the Oracle Key Vault management console of the node for which replication should be managed.
2. Select the **Cluster** tab, and then **Monitoring** from the left navigation bar.

3. Under Cluster Link State, select the check boxes for the nodes for which you want to enable replication.
4. Click **Enable**.
5. Click **OK** to confirm in the dialog box.

4.9 Cluster Management Information

The Cluster Management page provides a concise overview of the cluster and the status of each node.

You can also manage the cluster from the cluster details section. When a node is performing a cluster operation it becomes the **controller node**.

Be aware that because the replication across the cluster takes time, there may be a delay before the Cluster Management page refreshes with the new cluster status. The **replication lag** in the monitoring page will help estimate the delay.

To view the Cluster Management page, click the **Cluster** tab, and then **Management** from the left navigation bar.

Cluster Information

Cluster Name	Cluster1
Cluster Subgroups	Group1
Maximum Disable Node Duration	24 hrs ⌵
Cluster Version	211.0.0.0

Current Node Information

Node Name	Node1_181
Node Type	Read-Write
Cluster Subgroup	Group1

Cluster Details

Select Node	Node ID ↑	Name	IP Address	Mode	Status	Read-Write Peer	Cluster Subgroup	Join Date	Disable Date	Version
<input type="checkbox"/>	1	Node1_181	10.240.112.181	Read-Write	ACTIVE	Node2_182	Group1	07-JAN-2021 11:30:32	-	211.0.0.0
<input type="checkbox"/>	2	Node2_182	10.240.112.182	Read-Write	ACTIVE	Node1_181	Group1	07-JAN-2021 15:42:49	-	211.0.0.0

Cluster Information

- **Cluster Name:** The name of the cluster.
- **Cluster Subgroups:** All subgroups within the cluster.
- **Maximum Disable Node Duration:** The maximum time, in hours, that a node can be disabled before it can no longer be enabled.
- **Cluster Version:** The version of Oracle Key Vault in which the cluster is operating.

Current Node Information

- **Node Name:** The name of this node.
- **Node Type:** The type of node, such as whether it is read-only or read-write.
- **Cluster Subgroup:** The subgroup to which this node belongs.

Cluster Details

- **Select Node:** Used to select a node for a specific operation, such as delete, force delete, or disable.

- **Node ID:** The ID of the node.
- **Node Name:** The name of the node. Clicking the node name takes you to the Cluster Management page of that node.
- **IP Address:** The IP address of the node.
- **Mode:** The mode in which the node is operating, such as read-write or read-only restricted.
- **Status:** The status of the node, such as active, pairing, disabling, disabled, enabling, deleting, or deleted.
- **Read-Write Peer:** The read-write peer of the node. If blank, it has no read-write peer.
- **Cluster Subgroup:** The subgroup to which the node belongs. You can change this by 1) checking the check box next to a node, 2) clicking the **Edit** button, which displays a window, 3) entering a new cluster subgroup in the field, and 4) clicking **Save**.
- **Join Date:** The date and time that the node was added to the cluster or most recently enabled
- **Disable Date:** The date and time that the node was disabled.
- **Node Version:** The current version of the Oracle Key Vault node.

4.10 Cluster Monitoring Information

The Cluster Monitoring page provides the replication health of the cluster and the current node.

This page also provides a concise overview of the settings enabled in the cluster. You cannot update the settings on this page. Because the replication across the cluster takes time, there may be a delay before the Cluster Monitoring page refreshes with the new cluster state. Replication lag will help estimate the delay.

To view the cluster monitoring page, click the **Cluster** tab, and then **Monitoring** from the left navigation bar.

You can hover the mouse over the checkmarks or X's in the Cluster Settings State pane. It will display one of the following explanations of the state:

- Enabled in Cluster
- Enabled in Node
- Disabled in Cluster
- Disabled in Node

Cluster Link State						Enable	Disable
<input type="checkbox"/>	Node ID	Name	State	Heartbeat Lag (in seconds)	Replication Lag (in seconds)		
<input type="checkbox"/>	2	node2	↑	94.77	65		
						1 - 1 of 1	

Cluster Settings State								
<input type="checkbox"/>	Node ID	Name	Audit	FIPS	HSM	SNMP	SYSLOG	DNS
	1	node1	✓	✗	✗	✗	✗	✓
	2	node2	✓	✗	✗	✗	✗	✓
								1 - 2 of 2

Cluster Link State

- **Select Node:** Used to select nodes for a specific operation, such as enabling or disabling replication. You can click the checkbox on the label row to select all nodes.
- **Node ID:** The ID of the node.
- **Node Name:** The name of the node.
- **State:** The current state of the node. The server is either up or down.
- **Heartbeat Lag:** The amount of time since a heartbeat was last received from this node. This setting should be around 120 seconds or lower. If this value is consistently greater than 120 seconds, then it means that one or more replication links may be broken. After the replication problem is fixed, it will then trend back down towards 120 or lower.
- **Replication Lag:** The average time it takes for data to replicate from this node to the current node.
- **Enable:** Enables the replication between the current node and the node selected.
- **Disable:** Disables the replication between the current node and the node selected.

Cluster Settings State

- **Node ID:** The ID of the node.
- **Node Name:** The name of the node.
- **Audit:** Indicates if auditing is enabled or disabled.
- **FIPS:** Indicates if FIPS mode is enabled or disabled.
- **HSM:** Indicates if HSM integration is enabled or disabled.
- **SNMP:** Indicates if SNMP is enabled or disabled.
- **SYSLOG:** Indicates if syslog is enabled or disabled.
- **DNS:** Indicates if DNS is enabled or disabled.

4.11 Naming Conflicts and Resolution

Oracle Key Vault can resolve naming conflicts that can arise as users create objects such as endpoints, endpoint groups, and user groups.

- [About Naming Conflicts and Resolution](#)
If you create an object that has the same name as another object on another node, Oracle Key Vault resolves this conflict.
- [Naming Conflict Resolution Information](#)
The Cluster Conflict Resolution page provides a list of objects with names that conflict with objects created on different nodes.
- [Changing the Suggested Conflict Resolution Name](#)
You can change the suggested name for an object that conflicts with another object of the same type.
- [Accepting the Suggested Conflict Resolution Name](#)
You can accept the suggested name for an object name that conflicts with another object of the same type.

4.11.1 About Naming Conflicts and Resolution

If you create an object that has the same name as another object on another node, Oracle Key Vault resolves this conflict.

You can create a new object with a name that conflicts with an object of the same type created on another node. If a conflict happens, then Oracle Key Vault will make the name of the conflicting object unique by adding `_OKVxx`, where `xx` is the node ID of the node on which the object was created. You can choose to accept this new name or change the object name.

Users who have the System Administrator role can resolve the following naming conflicts:

- User names
- Endpoint names

Users who have the Key Administrator role can resolve the following naming conflicts:

- Endpoint groups
- Security objects
- User groups
- Wallets

If an object is stuck in the `PENDING` state and will not transition to `ACTIVE`, then check for any broken replication links in the cluster. You can find cluster links in the Oracle Key Vault management console by selecting the **Cluster** tab and then selecting **Monitoring**.

4.11.2 Naming Conflict Resolution Information

The Cluster Conflict Resolution page provides a list of objects with names that conflict with objects created on different nodes.

On this page, you can accept the suggested unique name or edit the object name. To view the Cluster Conflict Resolution page, click the **Cluster** tab, and then **Conflict**

Resolution from the left navigation bar. Alternatively, you can click on the **Click here for details** button on a Naming Conflict alert from the Alerts table on the Home page.

<input type="checkbox"/>	Unique Name	Supplied Name	Name Status	Created By	Creator Node	Description	Rename
<input type="checkbox"/>	Example_Wallet_OKV02	Example_Wallet	ACTIVE	OKVADMIN	node2		

1 - 1 of 1

Wallet Name Conflicts

- **Unique Name:** The unique name assigned to the object by the system.
- **Supplied Name:** The original name of the object that conflicts with another object of this type.
- **Name Status:** The status of the object. The status can be `PENDING` or `ACTIVE`.
- **Created By:** The user that created the conflicting object name.
- **Creator Node:** The node on which the conflicting object was created.
- **Description:** The description of the object as entered by the user.
- **Rename:** The button that links to the object page where it can be renamed. When you click the edit icon, the Wallet Overview page appears. Click **Make Unique** to give the wallet a unique name, and then click **Accept Rename**.
- **Accept:** Allows you to accept the suggested name for the selected objects.

4.11.3 Changing the Suggested Conflict Resolution Name

You can change the suggested name for an object that conflicts with another object of the same type.

1. As a user who has the appropriate administrator role, log in to the Oracle Key Vault management console.
2. Select the **Cluster** tab, and then **Conflict Resolution** from the left navigation bar.
3. Locate the object that requires a name change.
4. Click the edit icon to the right of the object, under **Rename**.
5. On the object overview page, enter the new name for the object.
6. Click **Save**.

4.11.4 Accepting the Suggested Conflict Resolution Name

You can accept the suggested name for an object name that conflicts with another object of the same type.

1. As a user who has the appropriate administrator role, log in to the Oracle Key Vault management console.

2. Select the **Cluster** tab, and then **Conflict Resolution** from the left navigation bar.
3. Select the objects for which you want to accept the suggested name.
4. Click **Accept**.

4.12 Multi-Master Cluster Deployment Recommendations

Oracle provides deployment recommendations for deployments that have two or more nodes.

Two-Node Deployment Recommendations

Use a two-node deployments for the following situations:

- Non-critical environments, such as test and development
- Simple deployment of read-write pairs with both nodes active, replacing classic primary-standby
- Single data center environments

Considerations for a two-node deployment:

- Availability is provided by multiple nodes.
- Maintenance will require downtime.
- Good network connectivity between data centers is mandatory.
- Take regular backups to remote destinations for disaster recovery.

Three-Node Deployment Recommendations

Use a three-node deployment for the following situations:

- Single data center environments with minimal downtime requirement
- Single read-write pair with additional read-only node to handle load
- One read-only node is available for zero downtime during maintenance

Considerations for a three-node deployment:

- Take regular backups to remote destinations for disaster recovery.

Four or More Node Deployment Recommendations

Use a deployment of four or more nodes for the the following situations:

- Large data centers distributed across geographical locations
- Deployment of read-write pairs with pair members spanning geography

Considerations for a large deployment:

- Availability is provided by multiple nodes.
- Additional read-only nodes can be used to handle load.
- Good network connectivity between data centers is mandatory.

5

Managing an Oracle Key Vault Primary-Standby Configuration

You can deploy Oracle Key Vault in a primary-standby server configuration.

- [Overview of the Oracle Key Vault Primary-Standby Configuration](#)
The Oracle Key Vault primary-standby configuration provides benefits based on the type of deployment your site needs.
- [Configuring the Primary-Standby Environment](#)
To configure a primary-standby environment, you must have the System Administrator role and have access to the two servers (one primary and one standby).
- [Switching the Primary and Standby Servers](#)
You can switch the roles of the primary and standby server for situations such as maintenance periods.
- [Restoring Primary-Standby After a Failover](#)
A failover takes place if the primary server fails.
- [Disabling \(Unpairing\) the Primary-Standby Configuration](#)
You can disable the primary-standby configuration by unpairing the primary and standby servers.
- [Read-Only Restricted Mode in a Primary-Standby Configuration](#)
The read-only restricted mode is the default mode in a primary-standby configuration.
- [Best Practices for Using Oracle Key Vault in a Primary-Standby Configuration](#)
Oracle provides guidelines for ensuring operational continuity and minimal downtime of Oracle Key Vault.

5.1 Overview of the Oracle Key Vault Primary-Standby Configuration

The Oracle Key Vault primary-standby configuration provides benefits based on the type of deployment your site needs.

- [About the Oracle Key Vault Primary-Standby Configuration](#)
You configure a primary-standby environment by providing the primary and standby servers with each other's IP address and certificate, and then pairing them.
- [Benefits of an Oracle Key Vault Primary-Standby Configuration](#)
The benefits of an Oracle Key Vault primary-standby configuration include high availability, necessary for business-critical operations.
- [Difference Between Primary-Standby Configuration and Multi-Master Cluster](#)
In both primary-standby and multi-master cluster configurations, one server will always operate in read-write mode.

- [Primary Server Role in a Primary-Standby Configuration](#)
A primary-standby deployment consists of two Oracle Key Vault servers operating in a primary-standby configuration.
- [Standby Server Role in a Primary-Standby Configuration](#)
In a primary-standby environment, one server runs in the standby server role.

5.1.1 About the Oracle Key Vault Primary-Standby Configuration

You configure a primary-standby environment by providing the primary and standby servers with each other's IP address and certificate, and then pairing them.

While pairing the primary and standby servers, you can select one as the primary server, and the other as the standby. A failover timeout that you set determines when the standby starts to take over as the primary server.

Note:

Oracle strongly recommends that you keep the primary and standby systems as identical as possible, because their roles can be reversed in maintenance periods and failure situations. These include the following:

- Oracle Key Vault software versions
- Disk size
- RAM size
- System clocks on both systems must be synchronized

If your deployment requires a primary-standby configuration, then Oracle recommends that you configure it *before* adding endpoints to Oracle Key Vault. This enables the endpoints to know about both the primary and standby servers. An endpoint that is added before the standby server configuration will not know about the standby server, unless you reenroll the endpoint. If you configure the primary-standby environment after adding endpoints, then you must reenroll the endpoints to ensure the endpoints recognize both servers that were previously enrolled with the primary and standby servers in standalone mode.

WARNING:

Configure primary-standby deployments before adding endpoints to ensure that the endpoints know about both nodes.

If you want to add SNMP support in a primary-standby environment, then ideally, configure SNMP on both the primary and the standby servers before pairing them. This is because the standby server is no longer accessible from the Oracle Key Vault management console, because all requests are forwarded to the primary server. However you can also add SNMP support to the standby after pairing the servers by accessing the standby using SSH.

If you want to use a third-party certificate in a primary-standby configuration, then you must install it on the primary and standby servers first, and then pair them.

If you want to enable FIPS mode in a primary-standby environment, then you must ensure that both the primary and standby servers use the same FIPS mode: either both are enabled, or both are disabled for FIPS mode. This is because the standby server is no longer accessible from the Oracle Key Vault management console, because all requests are forwarded to the primary server.

With persistent cache enabled, both the primary and the standby will cache the master encryption keys from Oracle Key Vault independently. Ensure that TDE operations have executed on the primary and standby servers after these servers have started to verify the persistent cache. The persistent cache feature also enables endpoints to be operational during primary-standby operations, such as configuration, switchovers, and failovers.

If enabled, read-only restricted mode ensures endpoint operational continuity (such as enabling the endpoints to fetch keys) if either the standby or primary server is not available. For example, if the standby shuts down, then the primary will go into read-only restricted mode and enable the endpoints to fetch keys and continue operations.

A primary-standby configuration is characterized by continuous synchronization between the primary server and the standby server. When synchronization is lost between the primary and standby servers, it is possible to encounter a split-brain scenario where two primary servers might be active simultaneously. In such a scenario, both servers record new data that diverges from the last synchronized state. When connectivity is restored between the primary and standby servers, it may not be possible to reconcile the changes on the two servers and data loss may occur.

You can enable or disable restricted mode when configuring the primary-standby environment by selecting the **Allow Read-Only Restricted Mode** option to **Yes** or **No** on the Configure Primary-Standby page.

When read-only restricted mode is enabled, the primary server enters read-only restricted mode if the standby server is unavailable. In read-only restricted mode, the primary server allows keys to be retrieved, but does not allow keys to be modified or new keys to be added. This ensures that endpoints still have access to their keys, and key data or metadata is not lost due to a split-brain scenario. However, the primary server still writes audit records, which may be lost if a split-brain scenario occurs with the standby server.

When read-only restricted mode is disabled, the primary server becomes unavailable and stops accepting new requests if the standby server is unavailable. Endpoints connected to Oracle Key Vault will be unable to retrieve keys from the server until connectivity is restored between primary and standby servers. You can use the persistent master encryption key cache feature to avoid endpoint downtime. With this feature, data integrity is ensured by allowing endpoints to communicate with one primary server at any given time. This avoids split-brain situations, and the risk of data loss associated with such situations.

Related Topics

- [Changing SNMP Settings on the Standby Server](#)
You change the SNMP settings from the command line on the standby server.

5.1.2 Benefits of an Oracle Key Vault Primary-Standby Configuration

The benefits of an Oracle Key Vault primary-standby configuration include high availability, necessary for business-critical operations.

Users performing business-critical operations must have data to be accessible and recoverable with minimum downtime. These requirements are met in a primary-standby configuration.

You achieve high availability by adding redundancy in the form of a standby server that can take over the functions of the primary server in case of failure. The standby server helps you eliminate single points of failure and reduce server downtime. This is a significant reason to deploy Oracle Key Vault in a primary-standby configuration. In a classic primary-standby configuration, the emphasis is on key preservation. In a multi-master cluster, emphasis is on both key preservation and availability of the keys.

You can create a cluster of Oracle Key Vault server nodes for greater availability and redundancy. A primary-standby configuration is limited to two servers, whereas a multi-master cluster can have up to 16 geographically distributed nodes. The primary-standby configuration and the multi-master configuration are mutually exclusive.

Related Topics

- [Oracle Key Vault Multi-Master Cluster Overview](#)
The multi-master cluster nodes provide high availability, disaster recovery, load distribution, and geographic distribution to an Oracle Key Vault environment.

5.1.3 Difference Between Primary-Standby Configuration and Multi-Master Cluster

In both primary-standby and multi-master cluster configurations, one server will always operate in read-write mode.

In a primary-standby configuration, when both servers are available, one of the servers operates in read-write mode in the primary server role, and the other operates in the standby server role. The endpoints only connect to the server running in the primary server role. The roles can be switched manually to support maintenance operations, or automatically due to server or connectivity failure. If either the primary or standby server becomes unavailable, then the remaining server operates in a read-only restricted mode, limiting normal updates while allowing audits and other internal updates.

In a multi-master cluster, the endpoints can connect to any Oracle Key Vault server. Some servers are configured as bi-directional read-write pairs in which information updated in either node must be successfully replicated to the other node immediately. If one of the nodes in a read-write pair becomes unavailable, the surviving node operates in read-only restricted mode until the other node is restored and synchronization resumes. A fully functional multi-master cluster must have at least one read-write pair.

When a successful update occurs in a read-write pair, the update is propagated to all other nodes in the cluster.

A primary-standby configuration and a multi-master cluster configuration are mutually exclusive and incompatible configurations. The specific configuration of an Oracle Key Vault deployment has no ramification on the endpoint side configuration.

5.1.4 Primary Server Role in a Primary-Standby Configuration

A primary-standby deployment consists of two Oracle Key Vault servers operating in a primary-standby configuration.

By default, endpoints only connect to the primary server until it becomes unavailable. At any time, only one server operates in the primary server role and that server actively accepts client connections. The other server operates in the standby server

role, which receives updates from the primary server. On failure of the server running in the primary server role, the standby assumes the primary role. There may be restrictions in operations if the primary-standby pair is not fully available and operational.

5.1.5 Standby Server Role in a Primary-Standby Configuration

In a primary-standby environment, one server runs in the standby server role.

This standby server does not accept client connections while in that role. The server receives updates only from the paired server running in primary server role. If the primary server is no longer available, including being available to the administrator, then the server running in the standby role switches to assume the primary server role. There may be restrictions in operations if the primary-standby pair is not fully available and operational.

5.2 Configuring the Primary-Standby Environment

To configure a primary-standby environment, you must have the System Administrator role and have access to the two servers (one primary and one standby).

- [Step 1: Configure the Primary Server](#)
To configure the primary server, you must enable it to connect to the standby server.
- [Step 2: Configure the Standby Server](#)
To configure the standby server, you must enable it to connect to the primary server.
- [Step 3: Complete the Configuration on the Primary Server](#)
After you configure the primary and standby servers, you can enable the primary-standby on the designated primary server.

5.2.1 Step 1: Configure the Primary Server

To configure the primary server, you must enable it to connect to the standby server.

If you plan to configure an HSM (such as Thales, Entrust, Utimaco, or other HSM with Oracle Key Vault), then you must first enable this HSM in Oracle Key Vault before configuring the primary server.

1. Open a web browser and enter the IP address of the designated primary server.
The Oracle Key Vault Management Console login screen is displayed.
2. Log in to the Oracle Key Vault management console as a user who has the System Administrator role.
3. Check if the server has FIPS mode enabled, and if necessary, enable or disable it.

You must ensure that both the primary and standby servers use the same FIPS mode setting: either both are enabled, or both are disabled, for FIPS mode. Changing the FIPS mode setting requires a restart of Oracle Key Vault.

- a. Select the **System** tab, and then select **Settings** in the left navigation bar.
- b. In the System Configuration section, click **FIPS**.
- c. In FIPS Mode dialog box, either select or clear the **Enable** check box, depending on whether both servers will use FIPS mode.
- d. Click **Save**.

In a moment, Oracle Key Vault will restart.

4. If you changed the FIPS mode, then log back into the designated primary server as a user who has the System Administrator role.
5. Select the **System** tab, and then **Settings** in the left navigation bar.
6. In the System Configuration area, click **Primary-Standby**.

The Primary-Standby page appears. The following are the fields on this page:

- **Current status:** Displays the IP address and status of the current server.
- **Fast Start Failover Threshold (in secs):** Displays the duration (in seconds) that will elapse before the server takes over from a failed peer server. The default is 60 seconds.

To avoid failover during brief or intermittent failures, increase the duration.

- **Configure this server as:** Displays whether the server is configured as a **Primary server** or **Standby server**.
- **Allow Read-Only Restricted Mode:** Displays the status of read-only restricted mode. The default is **Yes**.

When enabled, read-only restricted mode ensures operational continuity of the endpoints if the primary or standby Oracle Key Vault server is affected by server, hardware, or network failures

- **FIPS Mode:** Displays the current FIPS mode status of the server.
 - **Current Server Certificate:** Displays the server certificate.
7. Copy the following information, and then store it in a text file named `primary.txt`.

You will need this information when you configure the standby server.

- From the **Current status** field, copy the IP address and paste it in `primary.txt`.
- From the **Current Server Certificate** field, copy the server certificate and paste it on a new line in `primary.txt` after the IP address.

Save `primary.txt`.

Next, you are ready to configure the standby server.

Related Topics

- [Step 2: Configure the Standby Server](#)
To configure the standby server, you must enable it to connect to the primary server.
- *Oracle Key Vault Root of Trust HSM Configuration Guide*

5.2.2 Step 2: Configure the Standby Server

To configure the standby server, you must enable it to connect to the primary server.

If you plan to configure an HSM (such as SafeNet or Utimaco) with Oracle Key Vault, then you must first enable this HSM in Oracle Key Vault before configuring the standby server.

1. Open a web browser and enter the IP address of the designated standby server.
The Oracle Key Vault Management Console login screen is displayed.

2. Log in to the Oracle Key Vault management console as a user who has the System Administrator role.
3. Check if the server has FIPS mode enabled, and if necessary, enable or disable it.
You must ensure that both the primary and standby servers use the same FIPS mode setting: either both are enabled, or both are disabled, for FIPS mode. Changing the FIPS mode setting requires a restart of Oracle Key Vault.
 - a. Select the **System** tab, and then **Settings** in the left navigation bar.
 - b. In the System Configuration area, click **Primary-Standby**.
 - c. Either select or clear the **Enable** check box, depending on whether both servers will use FIPS mode.
 - d. Click **Save**.
In a moment, Oracle Key Vault will restart.
4. If you changed the FIPS mode, then log back into the designated standby server as a user who has the System Administrator role.
5. Select the **System** tab, and then **Settings** in the left navigation bar.
6. In the System Configuration area, click **Primary-Standby**.
The Configure Primary-Standby page is displayed.
7. Copy the following information, and store it in a text file named `standby.txt`.
You will need this information when you configure the primary server.
 - From the **Current status** field, copy the IP address and paste it in `standby.txt`.
 - From the **Current Server Certificate** field, copy the server certificate and paste it on a new line in `standby.txt` after the IP address.
 Save `standby.txt`.
8. In the **Configure this server as** field, select **Standby server**.
The **Primary server IP address** and **Primary server certificate** fields are displayed.
Ensure that **Yes** is selected in the **Allow Read-Only Restricted Mode** field.
Do not disable read only restricted mode unless necessary. If the primary-standby configuration is configured with read only restricted mode disabled, then you must enable it by reinstalling and configuring Oracle Key Vault again.
9. Copy the following information from `primary.txt`, and paste it in the **Configure Primary-Standby** page of the standby server:
 - Copy the IP address and paste it in the **Primary server IP address** field.
 - Copy the server certificate and paste it in the **Primary server certificate** field.
10. Click **Save**.
The **Settings Saved** page is displayed.
The **Reset** button enables you to delete the primary-standby configuration, if necessary.
11. Do not exit the management console.
At this stage, the primary-standby configuration is complete on the designated standby server. The next step is to enable primary-standby on the designated primary server.

Related Topics

- [Step 3: Complete the Configuration on the Primary Server](#)
After you configure the primary and standby servers, you can enable the primary-standby on the designated primary server.
- *Oracle Key Vault Root of Trust HSM Configuration Guide* Configuring HSM

5.2.3 Step 3: Complete the Configuration on the Primary Server

After you configure the primary and standby servers, you can enable the primary-standby on the designated primary server.

1. Ensure that you are logged in to the standby server as a user with the System Administrator Role and that the Oracle Key Vault management console Configure Primary-Standby page is displayed.

2. On the **Settings Saved** page, click the IP address of the primary server displayed at the top of the page.

The **Oracle Key Vault Management Console login screen** of the primary server is displayed.

3. Log in to the Oracle Key Vault management console as a user who has the System Administrator role.

4. Select the **System** tab, and then **Settings** in the left navigation bar.

5. In the System Configuration area, click **Primary-Standby**.

6. In the **Configure this server as** field, select **Primary server**.

The **Standby server IP address** and **Standby server certificate** fields are displayed.

Ensure that **Yes** is selected in the **Allow Read-Only Restricted Mode** field.

Do not disable read only restricted mode unless necessary. If the primary-standby configuration is configured with read only restricted mode disabled, then you must enable it by reinstalling and configuring Oracle Key Vault again.

7. Copy the following information from `standby.txt`, and paste it in the Configure Primary-Standby page of the primary server:

- Copy the IP address and paste it in the **Standby server IP address** field.
- Copy the server certificate and paste it in the **Standby server certificate** field.

8. Click **Initiate Pairing**.

9. In the confirmation message that is displayed, click **OK**. The **Operation in Progress** page is displayed.

 **Caution:**

Allow at least 10 minutes to elapse before performing the next step.

10. After at least 10 minutes have elapsed, click **Refresh**.

If the pairing of primary and standby servers is successful, then the current session is terminated. The **Oracle Key Vault Management Console login**

screen of the primary server is displayed. The primary-standby configuration is now complete.

11. Check that the configuration was successful.
 - a. Log in as the System Administrator.
 - b. Select the **System** tab, and then **Settings** in the left navigation bar.
 - c. In the System Configuration area, click **Primary-Standby**.
The Primary-Standby Status page appears.
 - d. Ensure that the **Status** label is set to **Primary-Standby mode is enabled**.
 - e. Ensure that the **Switchover Status** is correct. In this example, the status is correctly set to **TO STANDBY**.

At this stage, the primary-standby configuration should be complete and ready to use. Note the following:

- You cannot log in to the standby server using a web browser because all configuration is propagated from the primary.
- With the persistent cache enabled, endpoints will continue to operate while the primary-standby configuration is enabled. The **IP Address**, **Network Mask**, and **Gateway** fields in the Network Info page (found from selecting the **System** tab, and then **Settings** in the left navigation bar) will no longer be modifiable.
- To manage the primary-standby deployment, log in to the primary server using a web browser.

 **Caution:**

Ensure that you leave read-only restricted mode enabled while configuring primary-standby. Enabling it later requires a reinstall of the Oracle Key Vault server software on the standby server.

After configuring the primary-standby environment, do not change the system time on the primary server. The changed system time causes the standby server to go down, thus disrupting the functioning of the primary-standby configuration.

5.3 Switching the Primary and Standby Servers

You can switch the roles of the primary and standby server for situations such as maintenance periods.

During such maintenance periods, you might want to shut down a server to upgrade software or install patches. If you have persistent cache enabled and the persistent cache timeout is sufficiently tuned, then the endpoints will continue to be operational during the switchover, minimizing endpoint downtime.

1. Log in to the Oracle Key Vault management console of the primary node as a user with the System Administrator role.
2. Before switching the primary and standby servers, ensure that there are no primary-standby related alerts on the **Alerts** page.

To access the **Alerts** page, click the **Reports** tab, and then click **Alerts** in the left pane. Ensure that all primary-standby related alerts on the **Alerts** page are addressed before switching the primary and standby servers.

3. Select the **System** tab, and then **Settings** in the left navigation bar.
4. In the System Configuration area, click **Primary-Standby**.

The **Primary-Standby Status** page appears.

5. Click **Switch Roles** on the top right.

The **Switch Roles** button allows you to switch the roles of the primary server and the standby server. The primary server then assumes the role of the standby server, while the standby server assumes the role of the new primary server.

Click **OK** in the confirmation message.

An operation-initiated message is followed by the **Operation in Progress** page indicating that the switchover operation will take 10 minutes to complete successfully.

 **Caution:**

You must wait for a minimum period of 10 minutes for the switchover operation to complete successfully. If you refresh the UI before the switchover operation is complete, an error message is displayed. The error message is displayed until the switchover is completed successfully.

6. Ensure that at least 10 minutes have elapsed, and only then, click **Refresh**.

This logs you out of the current session and then opens a login page to the switched primary server. Otherwise, try accessing the new primary server's URL directly.

Both the primary and standby servers are restarted. However, you will only be able to log in to the new primary node's web console. The primary server is the active server, and all requests to the standby will be forwarded to the primary.

7. Log in to the primary server to see the IP address of the switched standby node.
8. Select the **System** tab, then **Settings** in the left navigation bar, and then click **Primary-Standby** in the System Configuration area.

The **Primary-Standby Status** page appears. The **Standby server IP address** field displays the IP address.

5.4 Restoring Primary-Standby After a Failover

A failover takes place if the primary server fails.

If the primary server is not available, then the standby server takes over the primary role. If the standby server does not hear from the primary server for a time exceeding the **Fast Start Failover Threshold** value, then it will assume that the primary is shut down and start the failover process. You can configure the value in the **Fast Start Failover Threshold** field from the Oracle Key Vault management console from the default of 60 seconds. If the failed server (the old primary) becomes available again, then in most cases it will automatically become the new standby server. If the primary

server fails permanently, then the standby server will take over as the primary. In this case, you must restore the primary-standby configuration.

1. Reinstall the Oracle Key Vault image on the failed server.
Ensure that you use the original IP address for the failed server.
2. Log on to the newly installed server and follow the steps to configure the primary-standby environment.

You can designate the new server as the standby server (because the cluster has a functional primary) and then pair it with the functioning primary.

3. If you want to restore the original configuration and set the new server as the primary, then click the **Switch Roles** option after you successfully pair the two nodes and enable primary-standby.

The **Switch Roles** button enables you to switch the roles of the primary server and the standby server. The primary server then assumes the role of the standby server, while the standby server assumes the role of the new primary server.

 **Note:**

When read-only restricted mode is disabled, the primary server's failover status goes into suspended state causing the standby server to wait indefinitely for the primary server to come back up. This is expected behavior to avoid a split-brain scenario where two primary servers are simultaneously active.

When read-only restricted mode is enabled, a primary or standby server failure causes the operational peer to enter read-only restricted mode, thus ensuring endpoint operational continuity.

Related Topics

- [Failover Situations in Primary-Standby Mode](#)
Failover situations can occur with or without read-only restricted mode or during a planned shutdown operation for both primary and standby servers.

5.5 Disabling (Unpairing) the Primary-Standby Configuration

You can disable the primary-standby configuration by unpairing the primary and standby servers.

After the two servers are unpaired, the primary and standby servers will operate in standalone mode. To prevent endpoints from connecting to the old standby (now standalone) Oracle Key Vault server, you must take the old standby off the network. See *Oracle Key Vault Release Notes* for guidance about setting the permissions of the `/var/lib/oracle/diag/rdbms/dbfwdb/dbfwdb/metadata_pv` directory beforehand. Check the *Release Notes* for additional issues related to unpair operations.

1. Log in to the primary server's management console as a user with System Administrator privileges.
2. Select the **System** tab, and then **Settings** in the left navigation bar.
3. In the System Configuration area, click **Primary-Standby**.

The Primary-Standby Status page appears with **Unpair** and **Switch Roles** on the top right. The **Unpair** and **Switch Roles** options do the following:

- The **Unpair** button allows you to disconnect the primary server from the standby server, if required.
- The **Switch Roles** button allows you to switch the roles of the primary server and the standby server, if required. The primary server then assumes the role of the standby server, while the standby server assumes the role of the new primary server.

4. Click **Unpair**.

A brief message with a green check appears indicating that the operation has been successfully initiated.

The Operation in Progress page appears, indicating a wait time of at least 10 minutes for the un-pairing to complete.

Wait 10 minutes.

5. After 10 minutes, click the **Refresh** button to be logged out of the current session.
6. Log back in to the management console of the primary server.
7. Select the **System** tab, then **Settings** in the left navigation bar, and then click **Primary-Standby** in the System Configuration area.

The Configure Primary-Standby page appears. The **Current status** field shows the server in standalone mode.

 **Caution:**

If you want to use the old standby (now standalone) Oracle Key Vault server as a standby in a new primary-standby deployment, or as part of a multi-master cluster, then you must re-install the Oracle Key Vault software

Related Topics

- [Oracle Key Vault Release Notes](#)

5.6 Read-Only Restricted Mode in a Primary-Standby Configuration

The read-only restricted mode is the default mode in a primary-standby configuration.

- [About Read-Only Restricted Mode in a Primary-Standby Configuration](#)
Primary-standby read-only restricted mode ensures endpoint operational continuity.
- [Primary-Standby with Read-Only Restricted Mode](#)
Read-only restricted mode is the default primary-standby mode in Oracle Key Vault.
- [Primary-Standby without Read-Only Restricted Mode](#)
When a primary-standby environment is configured without read-only restricted mode, the impact on endpoint operations differs.

- [States of Read-Only Restricted Mode](#)
A server using read-only restricted mode is affected by the failure in a primary server, a standby server, and the network.
- [Enabling Read-Only Restricted Mode](#)
Read-only restricted mode is enabled by default when primary-standby is configured.
- [Disabling Read-Only Restricted Mode](#)
Read-only restricted mode is enabled by default when primary-standby is configured.
- [Recovering from Read-Only Restricted Mode](#)
To recover an instance from read-only restricted mode after a network failure or standby server failure, manual intervention may be required.
- [Read-Only Restricted Mode Notifications](#)
When the primary or standby server enters read-only restricted mode, an alert is generated.

5.6.1 About Read-Only Restricted Mode in a Primary-Standby Configuration

Primary-standby read-only restricted mode ensures endpoint operational continuity.

This endpoint operational continuity is essential when the primary or standby Oracle Key Vault servers are affected by server, hardware, or network failures.

When an unplanned shutdown makes the primary or standby server offline, the endpoints can still connect to the surviving peer server to perform critical operations. Primary-standby read-only restricted mode ensures that operations that replicate data are blocked. Operations that replicate data are allowed when both primary and standby servers are back online, thus ensuring that no critical data is lost.

In a primary-standby Oracle Key Vault configuration, the single point of failure is eliminated when you replicate the primary server's data to the standby server. Read-only restricted mode enables the generation of non-critical data such as audit records. However, generation of critical data such as keys is disabled. When the primary server is down, operations that generate new critical data on the standby are disabled. The reverse is also true. When the standby server is down, operations that attempt to modify or create any data on the primary server are disabled.

In a primary-standby deployment without read-only restricted mode, most endpoint operations are blocked because endpoint operations generate audit records, which is data that needs replication, thus disrupting operational continuity.

The following are the benefits of using read-only restricted mode:

- Enables endpoint operational continuity when the primary or standby server is offline
- Ensures symmetrical behavior when the primary or standby server is offline

The following sections describe the behavior of:

5.6.2 Primary-Standby with Read-Only Restricted Mode

Read-only restricted mode is the default primary-standby mode in Oracle Key Vault.

Note:

You can disable read-only restricted mode during the primary-standby configuration. Oracle recommends that you configure primary-standby with read-only restricted mode enabled, which is the default mode. While configuring primary-standby, ensure that **Yes** is selected in the **Allow Read-Only Restricted Mode** field on the Configure Primary-Standby page.

Read-only restricted mode ensures endpoint operational continuity as well as symmetrical behavior when the primary or standby server is offline. Symmetrical behavior ensures that the online server seamlessly takes over from its failed peer, and continues to service the endpoints without any disruption. For more information about primary-standby failover situations with read-only restricted mode, see [Failover Situations with Read-Only Restricted Mode](#).

In read-only restricted mode, the surviving Oracle Key Vault server operates with limited functionality. Endpoint operations that add or modify critical data on the Oracle Key Vault server are blocked. However, endpoint operations that involve fetching of data are allowed. This ensures endpoint operational continuity and data integrity. For more information about blocked and allowed operations, see [About the States of Read-Only Restricted Mode](#).

For more information about read-only restricted mode, see [States of Read-Only Restricted Mode](#).

Note:

Read-only restricted mode has no impact on a standalone server.

5.6.3 Primary-Standby without Read-Only Restricted Mode

When a primary-standby environment is configured without read-only restricted mode, the impact on endpoint operations differs.

This impact depends on the type of failure encountered: primary failure, standby failure, or a network failure that prevents communication between the primary and standby servers. The following are the possible scenarios:

- **Primary server failure:** The standby server will failover and take over from the affected primary server. This allows the Oracle Key Vault service to remain operational. Data modifications are stored on the primary server until they can be replicated to the standby server. This ensures endpoint operational continuity when the primary server goes offline due to an unplanned shutdown.
- **Standby server failure:** The primary server is unavailable to the endpoints, because it is not possible to distinguish a standby server failure from a network failure that prevents communication between the primary and standby servers.

- **Power loss or network connectivity failure:** The primary and standby servers are unable to communicate. The standby server will failover and take over from the primary server. To avoid a split-brain scenario, only one of the servers is allowed to service the endpoints.

 **Note:**

A split-brain scenario in Oracle Key Vault occurs when the primary server fails, causing the standby server to failover and take over from the primary server. This causes a situation where the primary and standby servers are available to service the endpoints, and create new data. A split-brain scenario causes data on the primary and standby servers to go out of sync. This can lead to data loss and corruption, as well as loss of operational continuity. To avoid a split-brain scenario, only one of the servers is allowed to service the endpoints after a failover occurs.

In primary-standby without read-only restricted mode, one of the following situations is triggered when a failure occurs:

- Endpoints suffer a temporary operational disruption to avoid a split-brain scenario.
- The standby server accepts new requests and generates new data without attempting to synchronize the data with the failed primary server. Replication of data is temporarily disabled until the primary server is online, thus ensuring operational continuity.

5.6.4 States of Read-Only Restricted Mode

A server using read-only restricted mode is affected by the failure in a primary server, a standby server, and the network.

- [About the States of Read-Only Restricted Mode](#)
Read-only restricted mode puts the Oracle Key Vault instance into the read-only restricted mode state.
- [Read-Only Restricted State Functionality During a Primary Server Failure](#)
You can set a failover threshold value to determine when a standby server takes over for a failed primary server.
- [Read-Only Restricted Mode Functionality During a Standby Server Failure](#)
If a standby fails, the primary server waits for the duration in the **Fast Start Failover Threshold** field on the **Configure Primary-Standby** page.
- [Read-Only Restricted State Functionality During a Network Failure](#)
When a network failure affects communication between primary and standby servers, communication between certain endpoints and the primary server may also be affected.

5.6.4.1 About the States of Read-Only Restricted Mode

Read-only restricted mode puts the Oracle Key Vault instance into the read-only restricted mode state.

However, read-only restricted mode does not put the embedded Oracle Key Vault database into the read-only restricted mode state. In read-only restricted mode, the following behavior occurs when a primary or a standby server is unavailable:

- When the primary server is down, data cannot be replicated and so the standby server will failover and disable all operations that generate new data. However, the standby can fetch existing data.
- When the standby server is down, data cannot be replicated and so the primary server disables all operations that generate new data. However, the primary can fetch existing data.

Read-only restricted mode introduces the following deviations from normal functionality:

- All operations that generate new data are blocked. Operations that fetch existing data are allowed. Audit records for endpoint operations are generated as in normal operation. Internal system operations of the Oracle Key Vault database are not impacted. Functionality such as alerts continue to work normally.
- Endpoints are allowed to fetch keys from the Oracle Key Vault server. Endpoints cannot create new keys or modify existing keys.
- Administrators can log in to the Oracle Key Vault management console. Creation of an endpoint or a wallet, deletion of keys, and operations that modify or delete data are blocked.
- Unpairing of primary and standby Oracle Key Vault servers running in read-only restricted mode are allowed.
- Backup operations are blocked to avoid data mismatches between backups.

Table 5-1 Allowed and Blocked Operations in Read-Only Restricted Mode

Operation	Allowed or Blocked
Log in to Oracle Key Vault	Allowed
Endpoint operations such as fetching keys from the cache	Allowed
Endpoint operations that add, modify, or delete data such as rotation of keys on the database	Blocked
System operations such as enabling SSH access	Allowed
System operations that write data such as setting up a REST server and creating virtual wallets	Blocked
Oracle Key Vault management console access	Allowed
All Administrator and endpoint operations that add new data or modify existing data	Blocked
Backup operations	Blocked

In read-only restricted mode, if you attempt to execute operations that generate new data or modify existing data on the Oracle Key Vault server, the `Key Vault Server in read-only restricted Mode` error is displayed.

If you attempt to upload a wallet to the Java keystore, then you are prompted for the source Java keystore password. After entering the password, the `Key Vault Server in read-only restricted Mode` error is displayed.

5.6.4.2 Read-Only Restricted State Functionality During a Primary Server Failure

You can set a failover threshold value to determine when a standby server takes over for a failed primary server.

In the event of a primary server failure, the standby server waits for the duration specified in the **Fast Start Failover Threshold (in secs)** field on the Configure Primary-Standby page. If the primary server is not reachable after the specified duration has elapsed, the standby server enters read-only restricted mode. In read-only restricted mode, only operations that fetch data are allowed. Endpoint operations that add new data or modify existing data on the Oracle Key Vault server are blocked.

Related Topics

- [Configuring the Primary-Standby Environment](#)
To configure a primary-standby environment, you must have the System Administrator role and have access to the two servers (one primary and one standby).

5.6.4.3 Read-Only Restricted Mode Functionality During a Standby Server Failure

If a standby fails, the primary server waits for the duration in the **Fast Start Failover Threshold** field on the **Configure Primary-Standby** page.

If the standby server is not reachable after the specified duration has elapsed, the primary server enters read-only restricted mode. In read-only restricted mode, only operations that fetch data are allowed. Endpoint operations that add new data or modify existing data on the Oracle Key Vault server are blocked.

The primary server continues to provide limited service to the endpoints.

Related Topics

- [Configuring the Primary-Standby Environment](#)
To configure a primary-standby environment, you must have the System Administrator role and have access to the two servers (one primary and one standby).

5.6.4.4 Read-Only Restricted State Functionality During a Network Failure

When a network failure affects communication between primary and standby servers, communication between certain endpoints and the primary server may also be affected.

The primary server waits for the duration specified in the **Fast Start Failover Threshold** field on the Configure Primary-Standby page. If the standby server is not reachable after the specified duration has elapsed, the primary server enters read-only restricted mode.

The standby server will also wait for the same duration. If the primary server is not reachable after the specified duration has elapsed, the standby server enters read-only restricted mode. The standby server takes over as the new primary server, and provides service to endpoints that cannot communicate with the affected primary server.

Related Topics

- [Configuring the Primary-Standby Environment](#)
To configure a primary-standby environment, you must have the System Administrator role and have access to the two servers (one primary and one standby).

5.6.5 Enabling Read-Only Restricted Mode

Read-only restricted mode is enabled by default when primary-standby is configured.

Oracle recommends that you configure the primary-standby servers with read-only restricted mode enabled.

1. Unpair the primary server from the standby server, and then reinstall Oracle Key Vault on the standby server.
2. Perform post-installation tasks on the standby server.
3. Log in to the standby server Oracle Key Vault management console as a user who has the System Administrator role.
4. Select the **System** tab, and then **Settings** in the left navigation bar.
5. In the System Configuration area, click **Primary-Standby**.
On the Primary-Standby page, ensure that **Yes** is selected in the **Allow Read-Only Restricted Mode** field.
6. Log in to the primary server Oracle Key Vault management console as a user who has the System Administrator role.
7. On the Primary-Standby page, ensure that **Yes** is selected in the **Allow Read-Only Restricted Mode** field.
8. Click **Initiate Pairing**.

Read-only restricted mode takes effect if connectivity is lost between the primary and standby servers. Read-only restricted mode has no effect on a standalone server.

Related Topics

- *Oracle Key Vault Installation and Upgrade Guide*
- *Oracle Key Vault Installation and Upgrade Guide*
- [Configuring the Primary-Standby Environment](#)
To configure a primary-standby environment, you must have the System Administrator role and have access to the two servers (one primary and one standby).

5.6.6 Disabling Read-Only Restricted Mode

Read-only restricted mode is enabled by default when primary-standby is configured.

Oracle recommends that you configure primary-standby with read-only restricted mode enabled. Follow these steps if an existing primary-standby deployment with read-only restricted mode that is enabled must be converted to a deployment that has read-only restricted mode disabled.

1. Unpair the primary server from the standby server, and reinstall Oracle Key Vault on the standby server.
2. Perform post-installation tasks on the standby server.
3. Log in to the standby server Oracle Key Vault management console as a user who has the System Administrator role.
4. Select the **System** tab, and then **Settings** in the left navigation bar.
5. In the System Configuration area, click **Primary-Standby**.
On the Primary-Standby page, ensure that **No** is selected in the **Allow Read-Only Restricted Mode** field.
6. Log in to the primary server Oracle Key Vault management console as a user who has the System Administrator role.

7. On the Primary-Standby page, ensure that **No** is selected in the **Allow Read-Only Restricted Mode** field.
8. Click **Initiate Pairing**.

After read-only restricted mode is disabled, it does not take effect if connectivity is lost between the primary and standby servers. Read-only restricted mode has no effect on a standalone server.

Related Topics

- [Oracle Key Vault Installation and Upgrade Guide](#)
- [Oracle Key Vault Installation and Upgrade Guide](#)
- [Configuring the Primary-Standby Environment](#)
To configure a primary-standby environment, you must have the System Administrator role and have access to the two servers (one primary and one standby).

5.6.7 Recovering from Read-Only Restricted Mode

To recover an instance from read-only restricted mode after a network failure or standby server failure, manual intervention may be required.

You will need to unpair and reset the surviving instance, reinstate a new Oracle Key Vault server, and pair it as the new standby to the surviving server. The following are the possible scenarios:

- **Primary server failure:** Depending on the operational state of the primary server at the time of failure, it could be restarted and some functionality may be available. However, due to possible corruption of the embedded Oracle Key Vault database, recovery may not be possible. You would then need to reinstate the Oracle Key Vault instance because of the partial failure. If the failed server is unable to again pair with the peer server within 20 minutes, then you must instantiate the server.

Even though the endpoint processes communicating with the Oracle Key Vault servers retain the IP address of the last known reachable server, they must determine the IP address of the new Oracle Key Vault server when spawned. The endpoint processes attempt to communicate with the Oracle Key Vault server configured as the primary server in the configuration scripts, and then wait for a response before trying to reach the server configured as the standby server in the configuration scripts. To minimize downtime, Oracle recommends that you initiate a switchover after reinstating the failed primary server.

- **Standby server failure:** The primary server will run in the read-only restricted mode if there is a standby server failure. Reinstating the standby server if it does not automatically pair with the primary server.
- **Power loss or network connectivity failure:** When a network failure occurs, the primary and standby servers are unable to communicate, and both servers enter read-only restricted mode. The standby also attempts to failover to the primary server. Once communication is re-established between the primary and standby servers, the old primary server is automatically converted to the new standby. The data from the new primary server overwrites the old primary server's data, resulting in the loss of audit records from the old primary server. It is recommended that you enable syslog auditing to preserve the audit records that were overwritten on the old primary. Similar to recovering from primary server failure, Oracle recommends that you perform a switchover after recovery. You should also not enroll any new endpoints before the switchover.

Related Topics

- [Restoring Primary-Standby After a Failover](#)
A failover takes place if the primary server fails.

5.6.8 Read-Only Restricted Mode Notifications

When the primary or standby server enters read-only restricted mode, an alert is generated.

You can view these alerts on the **Alerts** page. If email notifications are configured, then an email notification is sent.

Related Topics

- [Viewing Open Alerts](#)
Users can view alerts depending on their privileges.
- [Configuring Email Notification](#)
You can use email notifications to directly notify administrators of Key Vault status changes without logging into the Oracle Key Vault management console.

5.7 Best Practices for Using Oracle Key Vault in a Primary-Standby Configuration

Oracle provides guidelines for ensuring operational continuity and minimal downtime of Oracle Key Vault.

- Configure your Transparent Data Encryption (TDE)-enabled databases to have an auto-login connection into Oracle Key Vault. *Oracle Database Advanced Security Guide* describes how to configure auto-login keystores.
- Apply the database patch for Bug 22734547 to tune the Oracle Key Vault heartbeat.
- Ensure that read-only restricted mode is enabled in primary-standby Oracle Key Vault deployments.
- Set the duration in the **Fast Start Failover Threshold** field on the Configure Primary-Standby page to a value that avoids unnecessary failover due to transient network interruptions.
- Configure syslog auditing to capture audit records in read-only restricted mode.
- Switch over to the original primary server in case the primary server is reinstated.
- Before attempting any unpair operations, check *Oracle Key Vault Release Notes* for known issues.
- Before attempting any switchover or unpair operations, check *Oracle Key Vault Release Notes* for any known issues.

Related Topics

- *Oracle Database Advanced Security Guide*
- *Oracle Key Vault Release Notes*

6

Deploying Oracle Key Vault on an Oracle Cloud Infrastructure VM Compute Instance

You can install Oracle Key Vault on an Oracle Cloud Infrastructure (OCI) VM compute instance from Oracle Cloud Marketplace.

- [About Deploying Oracle Key Vault on an Oracle Cloud Infrastructure Compute Instance](#)
Oracle Key Vault on Oracle Cloud Marketplace is the cloud-based version of Oracle Key Vault and provides flexible, continuous and scalable key management.
- [Benefits of Using Oracle Key Vault in Oracle Cloud Infrastructure](#)
Quick deployments and ease of use are among the benefits of using an Oracle Key Vault Oracle Cloud Infrastructure (OCI) compute instance.
- [Provisioning an Oracle Key Vault Compute Instance](#)
The provisioning process for an Oracle Key Vault compute instance entails launching the compute instance and performing post-launch and post-installation tasks.
- [General Management of an Oracle Key Vault Compute Instance](#)
You can perform many of the Oracle Key Vault compute instance general management tasks in the Oracle Key Vault management console.
- [Migrating Oracle Key Vault Deployments Between On-Premises and OCI](#)
You can migrate an Oracle Key Vault standalone, primary-standby or cluster deployment from an on-premises environment to OCI or back.

6.1 About Deploying Oracle Key Vault on an Oracle Cloud Infrastructure Compute Instance

Oracle Key Vault on Oracle Cloud Marketplace is the cloud-based version of Oracle Key Vault and provides flexible, continuous and scalable key management.

Oracle Key Vault is quick and easy to launch on a VM compute instance of any shape or size in your OCI tenancy. This eliminates the need to procure hardware and drastically shortens the time to provision a fully functional Oracle Key Vault deployment. Oracle Key Vault deployed on an OCI VM compute instance (referred to as an Oracle Key Vault compute instance) is private to your tenancy and is managed by you. After the launch, an Oracle Key Vault compute instance has the same look and feel as an on-premises Oracle Key Vault installation, with the same flexibility in configuration.

An Oracle Key Vault server that is deployed on Oracle Cloud Infrastructure (OCI) VM compute instance can operate in the following situations:

- A standalone environment
- Be paired with another Oracle Key Vault server in OCI or on-premises to form a primary-standby configuration
- Be paired with other nodes in OCI or on-premises to form a multi-master cluster

The Oracle Key Vault multi-master cluster nodes could be entirely in OCI forming a cloud-only Oracle Key Vault cluster or some of the nodes can exist on-premises, thus forming a hybrid Oracle Key Vault cluster. This flexible deployment provides scalability regardless of whether Oracle Key Vault nodes are deployed in on-premises or cloud environments.

The Oracle Key Vault compute instance deployment enables the use of Oracle Key Vault to manage the encryption keys of your OCI-based database deployments. This enables you to maintain control over your encryption keys in a cloud environment. You can have up to 16 Oracle Key Vault compute instances in a multi-master cluster, distributed across any of the Oracle Cloud regions, to provide key management services to your globally distributed, on-premises, hybrid, or cloud-only Oracle database deployments.

When you enroll endpoints with the Oracle Key Vault compute instance, you must ensure that they are in the same VCN as the Oracle Key Vault compute instance itself. The endpoints will communicate with the Oracle Key Vault compute instance using the private IP of the instance. You can optionally configure the Oracle Key Vault compute instance to have a public IP address that can be used to access the Oracle Key Vault management console. You must configure the network to ensure that connectivity exists between Oracle Key Vault compute instances as well as between endpoints and the Oracle Key Vault compute instances.

6.2 Benefits of Using Oracle Key Vault in Oracle Cloud Infrastructure

Quick deployments and ease of use are among the benefits of using an Oracle Key Vault Oracle Cloud Infrastructure (OCI) compute instance.

- **Key management for OCI-based database environment:** The Oracle Key Vault compute instance deployment provides key management to your OCI-based database environments as well as on-premises and hybrid database environments. This enables you to own, manage, and maintain control over encryption keys of your database environments in the cloud.
- **Quick deployment:** You can launch the Oracle Key Vault compute instance within minutes and without the need to manage hardware or set up virtual machines. After it is launched, the Oracle Key Vault compute instance can run stand-alone, or be added to a multi-master cluster, or used in primary-standby configuration. You can enroll endpoints with an Oracle Key Vault compute instance. This way, you can quickly set up a production environment. You can also use Oracle Key Vault compute instances to quickly set up a test and development environment to validate and experiment with various use-cases and deployment scenarios of Oracle Key Vault.
- **Scaling out a production environment during peak load or hardware unavailability:** If you use FastConnect or IPsec VPN in OCI, then you can extend the Oracle Key Vault cloud deployments to an on-premises environment. Using FastConnect or IPsec VPN, you can pair Oracle Key Vault nodes on-premises with Oracle Key Vault compute instances in OCI to form a hybrid cluster. You can use a hybrid cluster to run production Oracle Key Vault servers in OCI, or use them to expand the Oracle Key Vault cluster temporarily. Oracle Key Vault compute instances can be added quickly as new nodes to an on-premises, OCI or hybrid Oracle Key Vault cluster. This type of deployment provides spontaneous

elasticity to the Oracle Key Vault cluster, and can be used to address any temporary increase of load on nodes of the Oracle Key Vault cluster.

- **Reduced latency for hybrid database environments:** For use cases where the data is shared between on-premises and cloud databases, managing the keys in a hybrid Oracle Key Vault cluster provides for locality of reference. Because the keys are available on all nodes of the cluster, the cluster subgroups can be setup in such a way that the databases in the cloud can primarily fetch the keys from the cluster nodes in OCI and the on-premises databases can primarily fetch the keys from cluster nodes that are provisioned on-premises.
- **Simplified transition of on-premises to OCI-based Oracle Key Vault clusters:** If you are connected to OCI using FastConnect or IPSec VPN, then you can extend your on-premises Oracle Key Vault cluster by adding Oracle Key Vault compute instances to that cluster. The IP addresses of the Oracle Key Vault nodes in OCI are added to the scan lists of your database endpoints. Once you have the appropriate number of Oracle Key Vault nodes in your OCI tenancy, you can remove the on-premises Oracle Key Vault nodes from the cluster. Following the same procedure, it is possible to seamlessly transition from an Oracle Key Vault cluster in OCI back to an on-premises Oracle Key Vault cluster.
- **Engaging OCI infrastructure and services:** You can take advantage of the unique benefits of the Oracle Cloud Infrastructure. If you install multiple Oracle Key Vault compute instances in the same region, you can choose to deploy them in different availability domains (fault domains are selected automatically, but can be changed) to guarantee the highest possible availability of your key management service. Services such as DNS and NTP are also natively available in OCI. You do not have to set them up, thereby simplifying Oracle Key Vault provisioning.

6.3 Provisioning an Oracle Key Vault Compute Instance

The provisioning process for an Oracle Key Vault compute instance entails launching the compute instance and performing post-launch and post-installation tasks.

- [About Provisioning an Oracle Key Vault Compute Instance](#)
To provision the Oracle Key Vault compute instance, you choose an Oracle Key Vault image as your custom image.
- [Launching the Oracle Key Vault Compute Instance](#)
The launching process for the Oracle Key Vault compute instance should take roughly two to five minutes.

6.3.1 About Provisioning an Oracle Key Vault Compute Instance

To provision the Oracle Key Vault compute instance, you choose an Oracle Key Vault image as your custom image.

You will launch this image from the OCI Marketplace on a compute shape. After you complete the process, the Oracle Key Vault compute image becomes unique to your environment. The disk size of this image is 2 TB.

After you complete the launch, you can begin to use the Oracle Key Vault compute image immediately. The steps that you must perform after the launch are similar to the steps that you would perform for an on-premises Oracle Key Vault installation.

Related Topics

-

6.3.2 Launching the Oracle Key Vault Compute Instance

The launching process for the Oracle Key Vault compute instance should take roughly two to five minutes.

- [About Launching the Oracle Key Vault Compute Instance](#)
The launch process requires some minor preparation work on your system.
- [Step 1: Ensure That You Have Prerequisites in Place](#)
Before you can launch an Oracle Key Vault compute instance, you must ensure that you have prerequisites in place in the Oracle cloud.
- [Step 2: Find the Oracle Key Vault Image](#)
The Oracle Key Vault image is available on the Oracle Cloud Marketplace web site.
- [Step 3: Launch the Oracle Key Vault VM Compute Instance](#)
You perform the entire launching process in the Oracle Cloud Marketplace.
- [Step 4: Perform Post-Launch and Post-Installation Tasks](#)
After you launch Oracle Key Vault in an OCI compute instance, you first perform the post-launch task, followed by post-installation tasks.

6.3.2.1 About Launching the Oracle Key Vault Compute Instance

The launch process requires some minor preparation work on your system.

Before you begin the launch process, ensure that the endpoints that you plan to use are in the same VCN as the Oracle Key Vault instance will be. The endpoints will communicate with Oracle Key Vault using the private IP of the compute instance. Optionally, the Oracle Key Vault compute instance can have a public IP that can be used to access the Oracle Key Vault management console. You will also set up the network and configure it to ensure that network connectivity will exist between the endpoints and the OCI compute instances.

6.3.2.2 Step 1: Ensure That You Have Prerequisites in Place

Before you can launch an Oracle Key Vault compute instance, you must ensure that you have prerequisites in place in the Oracle cloud.

Ensure that the following are in place:

- You have an Oracle cloud account.
- You have access to your assigned Oracle cloud tenant.
- You have sufficient compute node resources within the Oracle cloud tenant.

6.3.2.3 Step 2: Find the Oracle Key Vault Image

The Oracle Key Vault image is available on the Oracle Cloud Marketplace web site.

1. Log in to the Oracle Cloud Marketplace web site.
<https://cloudMarketplace.oracle.com/marketplace/oci>

2. In the **Products** search field, enter `Oracle Key Vault` and then click **Go**.
3. Under the Search Results, click **Oracle Key Vault** to navigate to the Oracle Key Vault page.

6.3.2.4 Step 3: Launch the Oracle Key Vault VM Compute Instance

You perform the entire launching process in the Oracle Cloud Marketplace.

1. Click the **Get App** button.
2. If you already have an OCI account, select your home region, and then click **Sign In**. Otherwise, click **Sign Up** to create a new account.
3. In the **Get Version** menu, ensure that **Oracle Key Vault *current_version*** is displayed.
4. From the **Compartment** menu, select your compartment.
5. Select the **I have reviewed the terms and conditions** check box.
6. In the Oracle Key Vault page, select **Launch Instance**.
7. In the page that appears, click **Change Instance**.
8. For the shape, select **VM.Standard2.2** or bigger. If you are using an older standard, then select **VM.Standard1.4** or bigger. Then click **Select Shape**.

Next, you are ready to configure the network.

9. Upload your SSH public key.
10. Click **Advanced Options**, and then choose the **Network** tab.

Here you can replace the default private address with another one. Both of these addresses must be within the range of your current subnet. In addition, you can change the host name to match your naming convention. Otherwise, the host name will be constructed from `okv|MAC-address-of-NIC`.

11. In the Boot Volume area, do not select any settings.
12. Click **Create** to complete the shape creation.

In a moment, the Oracle Key Vault compute image starts and is made available as an Oracle Key Vault server.

At this stage, you must perform the post-launch and post-installation steps.

Related Topics

- [Oracle Key Vault Installation and Upgrade Guide](#)

6.3.2.5 Step 4: Perform Post-Launch and Post-Installation Tasks

After you launch Oracle Key Vault in an OCI compute instance, you first perform the post-launch task, followed by post-installation tasks.

The post-launch task is to set the installation passphrase. After you set this passphrase, you must perform the post-installation tasks, which are the same tasks that are required for an on-premises deployment. After you complete the post-installation tasks, you can start building your Oracle Key Vault cluster, set up the primary-standby configuration, or leave Oracle Key Vault in stand-alone mode.

1. Set the installation passphrase.
 - a. In a command prompt, log in as the `opc` user.

```
ssh opc@Oracle_Key_Vault_OCI_IP_address
```

- b. Set the installation passphrase by executing the following command:

```
set_installation_passphrase
```

- c. When prompted, enter and confirm the installation passphrase.

After you successfully enter the passphrase, the system deletes the `opc` account. After this deletion, logins to the Oracle Key Vault instance using SSH will be disabled.

Only during upgrades, or when directed by Oracle Support, you can temporarily enable SSH from the Oracle Key Vault management console. You can then use SSH to log into the Oracle Key Vault server as the `support` user using the same SSH public key as the `opc` user.

2. Perform the following post-installation tasks:

- Create the Oracle Key Vault administrator accounts, the recovery passphrase, and the `root` and `support` user passwords.
- Enter the NTP and DNS addresses, using one of the following choices:
 - The NTP server address in Oracle Cloud Infrastructure, which is `169.254.169.254`, and then leave the remaining fields empty.
 - In all three fields, enter any external NTP servers. For example:

```
0.north-america.pool.ntp.org
```

```
1.north-america.pool.ntp.org
```

```
2.north-america.pool.ntp.org
```

Related Topics

- [Oracle Key Vault Installation and Upgrade Guide](#)

6.4 General Management of an Oracle Key Vault Compute Instance

You can perform many of the Oracle Key Vault compute instance general management tasks in the Oracle Key Vault management console.

- [Starting, Restarting, or Stopping an Oracle Key Vault Compute Instance](#)
Depending on the action you need, you can use the Oracle Key Vault management console or the OCI console.
- [System Settings in an Oracle Key Vault Compute Instance](#)
Most system settings in an Oracle Key Vault compute instance are the same as an on-premises deployment, with a few exceptions.
- [Backup and Restore Operations for Oracle Key Vault Compute Instances](#)
You can back up and restore Oracle Key Vault data between OCI environments and on-premises environments.
- [Terminating an Oracle Key Vault Compute Instance](#)
You terminate an Oracle Key Vault compute instance from the OCI console.

6.4.1 Starting, Restarting, or Stopping an Oracle Key Vault Compute Instance

Depending on the action you need, you can use the Oracle Key Vault management console or the OCI console.

You can use the Oracle Key Vault management console or OCI console to restart and stop an Oracle Key Vault compute instance, but to start an already stopped instance, you must use the OCI console.

Select one of the following methods to restart or stop an Oracle Key Vault compute instance:

- From the Oracle Key Vault management console, you can restart or stop the Oracle Key Vault compute instance:
 1. Log into the Oracle Key Vault management console as a user with the System Administrator role.
 2. Select **System**, then **Status** from the left navigation bar.
 3. In the Status page, do one of the following:
 - To restart, click **Reboot**.
 - To stop, click **Power Off**.
- From the OCI console, you can start, restart, or stop the Oracle Key Vault compute instance:
 1. Open the navigation menu. Under Core Infrastructure, go to Compute and click **Instances**.
 2. Select the Oracle Key Vault compute instance that you want to stop or start.
 3. Click one of the following actions:
 - To start a stopped instance, click **Start**.
 - To gracefully shut down the instance by sending a shutdown command to the operating system, click **Stop**.
If the Oracle Key Vault compute instance takes a long time to shut down, it could be improperly stopped, resulting in data corruption. To avoid this, shut down the instance using the commands available in the operating system before you stop the instance using the console.
 - To gracefully restart the Oracle Key Vault compute instance by sending a shutdown command to the operating system, and then power the instance back on, click **Reboot**.

6.4.2 System Settings in an Oracle Key Vault Compute Instance

Most system settings in an Oracle Key Vault compute instance are the same as an on-premises deployment, with a few exceptions.

Settings for system features such as auditing, email, RESTful services, integration Oracle Key Vault with Oracle Audit Vault is the same in both on-premises and OCI deployments.

- You can configure an Oracle Key Vault host name in either the OCI console or in the Oracle Key Vault management console. However, remember that if you set the IP

address of the host in the OCI console, later on, you cannot change it in either the OCI console or the Oracle Key Vault management console.

- Oracle Cloud Infrastructure provides NTP and DNS services. For NTP, enter just one IP address into the first of three fields in the NTP section of the Oracle Key Vault management console System Settings page: 169.254.169.254. For the DNS settings, consult with your network team because there are multiple options depending how DNS is configured in your subnet and tenancy.
- The SSH tunnel settings are used when on-premises Oracle Key Vault clusters provide key management services to Oracle databases that are deployed in OCI. Do not establish an SSH tunnel in OCI-based Oracle Key Vault deployments.

6.4.3 Backup and Restore Operations for Oracle Key Vault Compute Instances

You can back up and restore Oracle Key Vault data between OCI environments and on-premises environments.

You can back up an Oracle Key Vault compute instance that is stored in an on-premises host: this is the same backup that will be restored. Another on-premises Oracle Key Vault server can be a backup location for a server that is being restored into an Oracle Key Vault compute instance.

Requirements are as follows:

- If you are performing a backup or restore operation from Oracle Key Vault compute instances to an OCI compute instance, then persistent network connectivity to the OCI compute instance from Oracle Key Vault compute instance must exist.
- If you want to perform a backup or restore operation between an Oracle Key Vault compute instance and an on-premises host, ensure that the VCN can span the on-premises hosts.

6.4.4 Terminating an Oracle Key Vault Compute Instance

You terminate an Oracle Key Vault compute instance from the OCI console.

When you terminate the compute instance, all data, including keys that protect endpoints, are permanently lost and cannot be recovered except from a backup. Even backups may not have the most recent keys. Terminating the instances can lead to loss of data for all endpoints. Exercise extreme caution before terminating an instance. Terminate the Oracle Key Vault compute instance only if you are sure that you have a copy of the keys in another, safe location or that you do not need them.

1. Log in to the OCI console.
2. Under Core Infrastructure, go to Compute, and then click **Instances**.
3. Select the name of the Oracle Key Vault compute instance that you want to remove.
4. Click **Terminate**, and then respond to the confirmation prompt.

Terminated instances temporarily remain in the list of instances with the status **Terminated**.

6.5 Migrating Oracle Key Vault Deployments Between On-Premises and OCI

You can migrate an Oracle Key Vault standalone, primary-standby or cluster deployment from an on-premises environment to OCI or back.

- [About Performing Migrations with Oracle Key Vault Compute Instance Data](#)
You can transition an Oracle Key Vault deployment from on-premises to OCI, and from OCI back to on-premises.
- [Migrating Oracle Key Vault Deployments into OCI Using Backup and Restore](#)
A user who has the System Administrator role can transition the Oracle Key Vault deployment from on-premises to OCI using backup and restore.
- [Migrating Oracle Key Vault Deployments Out of OCI Using Backup and Restore](#)
A user who has the System Administrator role can transition the Oracle Key Vault deployment from OCI to on-premises.

6.5.1 About Performing Migrations with Oracle Key Vault Compute Instance Data

You can transition an Oracle Key Vault deployment from on-premises to OCI, and from OCI back to on-premises.

You can quickly set up a production Oracle Key Vault deployment in OCI to address your immediate key management needs and then transition to the on-premises deployment. Alternately, Oracle Key Vault compute instances require little to no overhead of hardware and VM management. To eliminate this overhead, you may want to transition your on-premises Oracle Key Vault deployment to OCI.

You can use the Oracle Key Vault backup and restore features to migrate an Oracle Key Vault cluster from on-premises to OCI, and back. You can transition an on-premises Oracle Key Vault cluster deployment to OCI by adding Oracle Key Vault compute instances to the cluster and removing on-premises Oracle Key Vault nodes from the cluster. The cluster is fully transitioned to OCI when no on-premises Oracle Key Vault node is left in the cluster. Similarly, you can also transition an Oracle Key Vault cluster in OCI to on-premises.

6.5.2 Migrating Oracle Key Vault Deployments into OCI Using Backup and Restore

A user who has the System Administrator role can transition the Oracle Key Vault deployment from on-premises to OCI using backup and restore.

1. Log in to the on-premises Oracle Key Vault server as a user who has the System Administrator role.
2. Configure an OCI compute instance as the backup destination.
3. Back up the on-premises Oracle Key Vault server to an OCI compute instance.
4. Launch an Oracle Key Vault compute instance with same Oracle Key Vault version as the on-premises Oracle Key Vault server.

5. Log in to the Oracle Key Vault compute instance as a user who has the System Administrator role.
6. Restore the backup from the OCI compute instance to the newly installed Oracle Key Vault compute instance.
7. To set up an Oracle Key Vault multi-master cluster, convert the restored Oracle Key Vault compute instance as the first (initial) node of the cluster.
8. Configure additional Oracle Key Vault compute instances and add them to the cluster as needed.

Related Topics

- [Creating the First \(Initial\) Node of a Cluster](#)
To create a cluster, you must convert an existing standalone Oracle Key Vault server to become the first node in the cluster.
- [Setting Up a Cluster](#)
After you add an initial node to a cluster, you can add more nodes, thereby creating read-write pairs of nodes or read-only nodes.
- [Backup and Restore Operations](#)
Backups provide the ability to restore Oracle Key Vault to a previous state in the case of a failure.

6.5.3 Migrating Oracle Key Vault Deployments Out of OCI Using Backup and Restore

A user who has the System Administrator role can transition the Oracle Key Vault deployment from OCI to on-premises.

1. Log in to the Oracle Key Vault compute instance as a user who has the System Administrator role.
2. Back up the Oracle Key Vault compute instance to an on-premises system.
3. Install a new Oracle Key Vault server on-premises with same Oracle Key Vault version as the Oracle Key Vault compute instance.
4. Log in to the on-premise Oracle Key Vault server as a user who has the System Administrator role.
5. Restore the backup from the on-premises backup destination to the newly installed on-premises Oracle Key Vault server.
6. To set up an Oracle Key Vault multi-master cluster, convert the restored on-premises Oracle Key Vault server as the first (initial) node of the cluster.
7. Configure additional Oracle Key Vault compute instances and add them to the cluster as needed.

Related Topics

- [Creating the First \(Initial\) Node of a Cluster](#)
To create a cluster, you must convert an existing standalone Oracle Key Vault server to become the first node in the cluster.
- [Setting Up a Cluster](#)
After you add an initial node to a cluster, you can add more nodes, thereby creating read-write pairs of nodes or read-only nodes.

- **Backup and Restore Operations**
Backups provide the ability to restore Oracle Key Vault to a previous state in the case of a failure.

7

Oracle Database Instances in Oracle Cloud Infrastructure

Oracle Key Vault deployed on-premises can manage the TDE master encryption keys for Oracle Database instances running in Oracle Cloud Infrastructure (OCI).

- [About Managing Oracle Cloud Infrastructure Database Instance Endpoints](#)
This type of Oracle Key Vault server deployment meets compliance standards for the management of encryption keys.
- [Preparing a Database Instance on OCI to be an Oracle Key Vault Endpoint](#)
Oracle Key Vault supports the use of Oracle database instances on Oracle Cloud Infrastructure (OCI).
- [Using an SSH Tunnel Between Oracle Key Vault and Database as a Service](#)
An on-premises Oracle Key Vault communicates with an Oracle Cloud Database as a Service instance using a secure SSH tunnel.
- [Registering and Enrolling a Database as a Service Instance as an Oracle Key Vault Endpoint](#)
You can use the command line and the Oracle Key Vault management console to complete this task.
- [Suspending Database Cloud Service Access to Oracle Key Vault](#)
You can suspend one or more enrolled Database as a Service endpoints from access to Oracle Key Vault.
- [Resuming Database Cloud Service Access to Oracle Key Vault](#)
You can reinstate the connection between suspended Database Cloud Service endpoints and Oracle Key Vault.
- [Resuming a Database Endpoint Configured with a Password-Based Keystore](#)
Depending on the configuration, a Database as a Service endpoint can resume either automatically or must be manually resumed.

7.1 About Managing Oracle Cloud Infrastructure Database Instance Endpoints

This type of Oracle Key Vault server deployment meets compliance standards for the management of encryption keys.

The Oracle Database instances running in Oracle Cloud Infrastructure (OCI) can be deployed on VMshape, bare metal, or Exadata. This type of deployment provides physical separation of keys from the encrypted data, and gives on-premises administrators control and visibility of how encryption keys are used to access encrypted data in the cloud. This also meets compliance requirements where encryption keys must be managed on-premises or separate from systems containing encrypted data.

Related Topics

- [Managing a Reverse SSH Tunnel in a Multi-Master Cluster](#)
You can reverse an SSH tunnel in a multi-master cluster from more than one node to the cloud-based endpoint for redundancy.

7.2 Preparing a Database Instance on OCI to be an Oracle Key Vault Endpoint

Oracle Key Vault supports the use of Oracle database instances on Oracle Cloud Infrastructure (OCI).

- [About Preparing a Database Instance on OCI to be an Oracle Key Vault Endpoint](#)
To prepare an Oracle database instance on OCI to be an Oracle Key Vault endpoint, you must first configure the instance, and then create a low-privileged user.
- [Configuring a Database Cloud Service Instance](#)
A Database as a Service (DBaaS) instance must have the correct network configuration.
- [Creating a Low Privileged Operating System User on Database as a Service](#)
The low privileged user account, `okv`, will be responsible for configuring an SSH tunnel and communicating with the DBaaS instances.

7.2.1 About Preparing a Database Instance on OCI to be an Oracle Key Vault Endpoint

To prepare an Oracle database instance on OCI to be an Oracle Key Vault endpoint, you must first configure the instance, and then create a low-privileged user.

Oracle databases on Oracle Cloud Infrastructure (OCI) provide fully functional Oracle database instances that use computing and storage resources provided by Oracle Compute Cloud Service. It eliminates the need to purchase, build, and manage silos of server and storage systems. It also makes database resources and capabilities available online so users can consume them whenever and wherever they are needed.

7.2.2 Configuring a Database Cloud Service Instance

A Database as a Service (DBaaS) instance must have the correct network configuration.

You can find instructions for configuring a Database as a Service (DBaaS) instance in the Oracle Database Cloud Service (Database as a Service) documentation.

After you have configured the DBaaS instance, it should have the following default values:

- A public IP address
- Two users: `oracle` and `opc` (Oracle Public Cloud)
- SSH access to the `oracle` and `opc` users

7.2.3 Creating a Low Privileged Operating System User on Database as a Service

The low privileged user account, `okv`, will be responsible for configuring an SSH tunnel and communicating with the DBaaS instances.

By default, Database as a Service instances are provisioned with the `oracle` and `opc` users. These users have more privileges than necessary to create the SSH tunnel, so Oracle recommends that you create another low privileged operating system user named `okv` on the Database as a Service instance. Oracle Key Vault will use user `okv` to configure an SSH tunnel and communicate with the Database as a Service instances.

1. Log in to the Oracle Cloud Infrastructure (OCI) instance using public key authentication (default for Oracle OCI) as user `opc`.

```
$ ssh -i private_key_file opc@node_ip_address
```

In this specification:

- *private_key_file* is the path to your private key file (`~/.ssh/id_rsa`). This key is the counterpart to the public key that you uploaded when you provisioned the Oracle Cloud Infrastructure instance.
- *node_ip_address* is the public IP address of the Database as a Service compute node in `x.x.x.x` format.

If this is the first time you are connecting to the compute node, the SSH utility prompts you to confirm the public key.

2. In response to the prompt asking you to confirm the public key, enter `yes`.
3. Create the Oracle Key Vault user.

```
$ sudo adduser okv
```

4. Append the Oracle Key Vault user `okv` to the `AllowUsers` parameter in the SSH `sshd_config` configuration file in the `/etc/ssh/` directory.

```
$ sudo vi /etc/ssh/sshd_config
```

5. Add the following entry to the end of the file:

```
AllowUsers oracle opc okv
```

6. Restart the SSH daemon:

```
$ sudo /sbin/service sshd restart
```

7. Grant the Oracle Key Vault user `okv` permission to execute `/sbin/fuser` by following these steps:

- a. Change the file permission of the `/etc/sudoers` file.

```
sudo chmod 740 /etc/sudoers
```

- b. Edit the `/etc/sudoers` file.

```
sudo vi /etc/sudoers
```

- c. Add the following entry:

```
okv    ALL=(root) NOPASSWD:/sbin/fuser
```

- d. Save the `/etc/sudoers` file. Change the file permission of the `/etc/sudoers` file.

```
sudo chmod 440 /etc/sudoers
```

- e. The `/etc/sudoers` would look similar to the following:

```
## Allow root to run any commands anywhere
root    ALL=(ALL)        ALL
okv     ALL=(root) NOPASSWD: /sbin/fuser
```

8. Become the `okv` user.

```
$ su okv
```

9. Create the `authorized_keys` file and then set appropriate permissions for this file.

```
$ cd $HOME
$ mkdir ~/.ssh
$ chmod 700 ~/.ssh
$ touch ~/.ssh/authorized_keys
$ chmod 640 ~/.ssh/authorized_keys
```

10. Log in to the Oracle Key Vault instance as the `support` user, and switch from `root`, and then switch to `oracle`.

11. Execute the following command to upload the Oracle Key Vault public key into the `authorized_keys` file in the Oracle Cloud Infrastructure that you just created.

```
ssh-copy-id ~/.ssh/id_rsa.pub okv@node_ip_address
```

12. Confirm that the `okv` user in Oracle Key Vault can log in to the OCI instance without providing a password:

```
$ ssh okv@node_ip_address
```

7.3 Using an SSH Tunnel Between Oracle Key Vault and Database as a Service

An on-premises Oracle Key Vault communicates with an Oracle Cloud Database as a Service instance using a secure SSH tunnel.

- [Creating an SSH Tunnel Between Oracle Key Vault and a DBaaS Instance](#)
You can create a connection between Oracle Key Vault and a Database as a Service (DBaaS) instance by configuring an SSH tunnel.
- [Managing a Reverse SSH Tunnel in a Multi-Master Cluster](#)
You can reverse an SSH tunnel in a multi-master cluster from more than one node to the cloud-based endpoint for redundancy.
- [Managing a Reverse SSH Tunnel in a Primary-Standby Configuration](#)
A reverse SSH tunnel in a primary-standby configuration is similar to a reverse SSH tunnel on a standalone Oracle Key Vault server.
- [Viewing SSH Tunnel Configuration Details](#)
The Oracle Key Vault management console provides information about SSH tunnels that have been configured for Oracle Key Vault.
- [Disabling an SSH Tunnel Connection](#)
You can use the Oracle Key Vault management console to disable the Oracle Key Vault and Database as a Service instance connection.

- [How the Connection Works if the SSH Tunnel Is Not Active](#)
The SSH tunnel is kept alive even if there is no activity between Oracle Key Vault and the Database as a Service instance.
- [Deleting an SSH Tunnel Configuration](#)
You can use the Oracle Key Vault management console to delete the connection between Key Vault and a Database as a Service instance.

7.3.1 Creating an SSH Tunnel Between Oracle Key Vault and a DBaaS Instance

You can create a connection between Oracle Key Vault and a Database as a Service (DBaaS) instance by configuring an SSH tunnel.

You can configure the SSH tunnel only after you set up the Database as a Service instance. You must have the Database as a Service instance's public IP address and the name of the operating system user that you want to use to establish the tunnel.

1. Log in to the Oracle Key Vault management console as a user who has the System Administrator role.
2. Select the **System** tab, and then **Settings** in the left navigation bar.
3. In the Network Details area, select **SSH Tunnel**.

The SSH Tunnel Settings page appears.

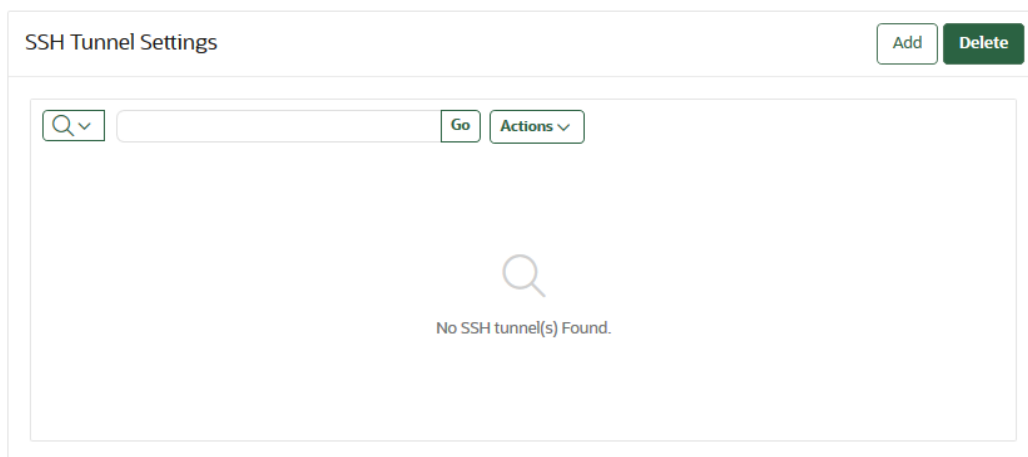

4. Click **Add**.

The Add SSH Tunnel page appears.

Cancel Add

SSH tunnels are used to connect endpoints on the Oracle Cloud to Oracle Key Vault.
Provide the public IP address, port number and username relating to the remote database cloud instance.

Ensure that the following SSH public key of Oracle Key Vault has been added to the list of trusted keys on the Oracle Database Cloud Service instance before adding the corresponding SSH tunnel here.

SSH Public Key

```
ssh-rsa
AAAAB3NzaC1yc2EAAAADAQABAAQCA137jzB2XvNXHQ2SXihELXLRVZ30bmzZ6z6n2xysh
Bh3xRp6iprbRDRTHg1KcS5kbvLY+mBPFUFTnAW41Dht2A/7quBjJgIo7DT6gekviZ+wtgyQM
M16IRIcZpzc/AAc6hD0vA9/eh8jzyDzSE3T9SOKL+W61K8OMNCF7Z6Vyska0VgnHOKc
/844swThasubKE+nTEM9OKIXVFznV7M17xeKN9INLzbsXh+HYQT7038IDdZ4j1OowcP0zEN
YQZee7AMCVLXzj8+OwgDHYZQn2z4VE9JL+e4x9Ff1a0eL1B1c++9z0eUWFpgeS8S17eTD
139UDTqyRU1h5 oracle@okv020017036cfd
```

Remote Host Details

Tunnel Name *

IP Address *

Port *

User Name *

5. Copy the text in **SSH Public Key** field and save it.

Remember that this is the public key that was copied into the OCI instance for user `okv` and was uploaded when you created a low privileged operating system user the Database as a Service instance. You will need to transport it to the Database as a Service instance and add it to the `authorized_keys` file of the Database as a Service user `okv` at `/home/okv/.ssh/authorized_keys`.

6. In the Remote Host Details page, enter information in the following fields:

- **Tunnel Name:** Choose a descriptive name that identifies the tunnel, based on the Database as a Service instance to be associated with it.
- **IP Address:** Enter the public IP address of the Database as a Service instance.
- **Port:** Enter a port number if you want to use a particular port number, or use the displayed default.
- **User Name:** Enter `okv` for the user name.

You can complete these fields only after you set up the Database as a Service instance and obtained the public IP address and user name.

7. Click **Add**.

The SSH Tunnel Settings page appears. It displays the SSH tunnel that you just created and any pre-existing SSH tunnels.

Add Delete

Go
Actions ▾

	Tunnel Name	IP Address	Port	Registration Time
<input type="checkbox"/>	dev_tunnel	192.0.2.63	5697	06-DEC-2020 18:34:26
<input type="checkbox"/>	test_tunnel	192.0.2.241	5697	06-DEC-2020 18:34:46

1 - 2 of 2

It lists the tunnels created with the name, IP address, port, and registration time of each.

- Click a tunnel name to see the **SSH Tunnel Details** page.

SSH Tunnel Details

Cancel
Disable
Delete

Tunnel Name	dev_tunnel
IP Address	192.0.2.63
Port	5697
User Name	okv
SSH Tunnel Status	↑

- To delete a tunnel, check the box by the tunnel that you want to delete and then click **Delete**.

You can delete more than one tunnel by selecting multiple boxes.

SSH Tunnel Settings

Add
Delete

Go
Actions ▾

	Tunnel Name	IP Address	Port	Registration Time
<input type="checkbox"/>	dev_tunnel	192.0.2.63	5697	06-DEC-2020 18:34:26

1 - 1 of 1

- Click **Disable** to disable the tunnel.

When you disable the tunnel, the endpoints that are associated with this tunnel will no longer be able to communicate with Oracle Key Vault.

SSH Tunnel Details

Cancel
Enable
Delete

Tunnel Name	dev_tunnel
IP Address	192.0.2.63
Port	5697
User Name	okv
SSH Tunnel Status	↓

11. In the confirmation dialog box, click **Yes**.

The **Disable** button is replaced by an **Enable** button.

Related Topics

- [Creating a Low Privileged Operating System User on Database as a Service](#)
The low privileged user account, `okv`, will be responsible for configuring an SSH tunnel and communicating with the DBaaS instances.

7.3.2 Managing a Reverse SSH Tunnel in a Multi-Master Cluster

You can reverse an SSH tunnel in a multi-master cluster from more than one node to the cloud-based endpoint for redundancy.

Oracle recommends that you configure three tunnels. Ideally, the cloud-based reverse SSH tunnels should be from different read-write pairs. Multiple SSH tunnels to the same endpoint are distinguished by the port number used. Oracle Key Vault suggests unique port numbers based on node ID. If you want to specify different port numbers, make port numbers for SSH tunnels from different nodes to the same endpoint unique.

In a multi-master cluster, multiple SSH tunnels are created from multiple nodes to the same endpoint. However, when you register and enroll endpoints, you will only see the tunnel from that node.

Be aware of the following:

- You should register and enroll the endpoint where there is a SSH tunnel created to that endpoint.
- You only see the tunnel from that node to endpoint in the following places:
 - During the registration, the option to select the SSH tunnel.
 - After registration, when you view endpoint details, only that tunnel is displayed.
 - When you submit the enrollment token and download the endpoint software, only that tunnel is displayed. However, the endpoint software downloaded has information about all tunnels to the endpoint. This means that the endpoint is able to use all the tunnels that were created before the endpoint is created.

All nodes which have an SSH tunnel created display their tunnel to the endpoint on the Endpoint Details page. They also list all tunnels that were created from that node on the SSH Tunnels page in the Oracle Key Vault management console.

7.3.3 Managing a Reverse SSH Tunnel in a Primary-Standby Configuration

A reverse SSH tunnel in a primary-standby configuration is similar to a reverse SSH tunnel on a standalone Oracle Key Vault server.

The SSH key of the primary and standby servers are the same after pairing. Tunnels created on an Oracle Key Vault server before primary-standby pairing as well as tunnels created on the primary after the primary-standby pairing are valid after primary-standby operations such as switchover, and failover, although the tunnels may be unavailable during the execution of these operations.

7.3.4 Viewing SSH Tunnel Configuration Details

The Oracle Key Vault management console provides information about SSH tunnels that have been configured for Oracle Key Vault.

1. Log in to the Oracle Key Vault management console as a user who has the System Administrator role.
2. Select the **System** tab, and then **Settings** in the left navigation bar.
3. In the Network Details area, select **SSH Tunnel**.

The SSH Tunnel Settings page appears.

<input type="checkbox"/>	Tunnel Name	IP Address	Port	Registration Time
<input type="checkbox"/>	dev_tunnel	192.0.2.63	5697	06-DEC-2020 18:34:26
<input type="checkbox"/>	test_tunnel	192.0.2.241	5697	06-DEC-2020 18:34:46

4. Click a tunnel name to see the **SSH Tunnel Details** page.

Tunnel Name	dev_tunnel
IP Address	192.0.2.63
Port	5697
User Name	okv
SSH Tunnel Status	↑

7.3.5 Disabling an SSH Tunnel Connection

You can use the Oracle Key Vault management console to disable the Oracle Key Vault and Database as a Service instance connection.

1. Log in to the Oracle Key Vault management console as a user who has the System Administrator role.
2. Select the **System** tab, and then **Settings** in the left navigation bar.
3. In the Network Details area, select **SSH Tunnel**.

The SSH Tunnel Settings page appears.

The screenshot shows the 'SSH Tunnel Settings' page. At the top right are 'Add' and 'Delete' buttons. Below is a search bar with a 'Go' button and an 'Actions' dropdown. The main content is a table with the following data:

<input type="checkbox"/>	Tunnel Name	IP Address	Port	Registration Time
<input type="checkbox"/>	dev_tunnel	192.0.2.63	5697	06-DEC-2020 18:34:26
<input type="checkbox"/>	test_tunnel	192.0.2.241	5697	06-DEC-2020 18:34:46

At the bottom right of the table area, it says '1 - 2 of 2'.

- Click a tunnel name to see the **SSH Tunnel Details** page.

The screenshot shows the 'SSH Tunnel Details' page for the 'dev_tunnel'. At the top right are 'Cancel', 'Disable', and 'Delete' buttons. The details are as follows:

Tunnel Name	dev_tunnel
IP Address	192.0.2.63
Port	5697
User Name	okv
SSH Tunnel Status	↑

- Click **Disable** to disable the tunnel.

When you disable the tunnel, the endpoints that are associated with this tunnel will no longer be able to communicate with Oracle Key Vault. A red down arrow appears next to the SSH Tunnel Status label.

The screenshot shows the 'SSH Tunnel Details' page for the 'dev_tunnel' after it has been disabled. At the top right are 'Cancel', 'Enable', and 'Delete' buttons. The details are as follows:

Tunnel Name	dev_tunnel
IP Address	192.0.2.63
Port	5697
User Name	okv
SSH Tunnel Status	↓

- In the confirmation dialog box, click **Yes**.
The **Disable** button is replaced by an **Enable** button.

7.3.6 How the Connection Works if the SSH Tunnel Is Not Active

The SSH tunnel is kept alive even if there is no activity between Oracle Key Vault and the Database as a Service instance.

If the tunnel stops, then it is automatically restarted. An alert will be sent if the tunnel is not available for any reason. An administrative user may elect to receive these alerts by email by configuring SMTP settings on Oracle Key Vault.

Related Topics

- [Configuring Email Settings](#)
You can configure the Simple Mail Transfer Protocol (SMTP) server properties to receive email notifications from Oracle Key Vault.

7.3.7 Deleting an SSH Tunnel Configuration

You can use the Oracle Key Vault management console to delete the connection between Key Vault and a Database as a Service instance.

1. Log in to the Oracle Key Vault management console as a user who has the System Administrator role.

2. Click **System**.

The Status page appears.

3. Select **SSH Tunnel Settings** from the left side bar.

The SSH Tunnel Settings page appears.

<input type="checkbox"/>	Tunnel Name	IP Address	Port	Registration Time
<input type="checkbox"/>	dev_tunnel	192.0.2.63	5697	06-DEC-2020 18:34:26
<input type="checkbox"/>	test_tunnel	192.0.2.241	5697	06-DEC-2020 18:34:46

4. To delete a tunnel, check the box by the tunnel that you want to delete and then click **Delete**.

You can delete more than one tunnel by selecting multiple boxes.

SSH Tunnel Settings				
<input type="button" value="Add"/> <input type="button" value="Delete"/>				
<input type="text" value="Q"/> <input type="button" value="Go"/> <input type="button" value="Actions"/>				
<input type="checkbox"/>	Tunnel Name	IP Address	Port	Registration Time
<input type="checkbox"/>	dev_tunnel	192.0.2.63	5697	06-DEC-2020 18:34:26
1 - 1 of 1				

7.4 Registering and Enrolling a Database as a Service Instance as an Oracle Key Vault Endpoint

You can use the command line and the Oracle Key Vault management console to complete this task.

- [About Registering and Enrolling a Database as a Service Instance as an Oracle Key Vault Endpoint](#)
You must enroll the Oracle Database as a Service instance before it can communicate with an Oracle Key Vault server.
- [Step 1: Register the Endpoint in the Oracle Key Vault Management Console](#)
The endpoint registration process downloads an `okvclient.jar` file, which contains the Oracle Key Vault software that the endpoint needs, to the local system.
- [Step 2: Prepare the Endpoint Environment](#)
The endpoint must have a compatible version of the Java Development Toolkit (JDK) and the Oracle Database environment variables must be set.
- [Step 3: Install the Oracle Key Vault Software onto the Endpoint for Registration and Enrollment](#)
To install the Oracle Key Vault software installation, you run the `okvclient.jar` file on the endpoint.
- [Step 4: Perform Post-Installation Tasks](#)
Post-installation tasks are important for a fully functioning Oracle Key Vault installation.

7.4.1 About Registering and Enrolling a Database as a Service Instance as an Oracle Key Vault Endpoint

You must enroll the Oracle Database as a Service instance before it can communicate with an Oracle Key Vault server.

The enrollment of Database as a Service endpoints is similar to the enrollment of on-premises endpoints with the following exceptions:

- Database as a Service endpoints should be registered with an endpoint type of "Oracle Database Cloud Service".

- Database as a Service endpoints have a primary tunnel IP associated with them. You must select the SSH tunnel with the same public IP address of the Database as a Service instance.
- The platform must be Linux. This is automatically selected and cannot be modified.
- You must download the jar file on-premises and transfer it to the Database as a Service instance using an out-of-band method like SCP or FTP.

7.4.2 Step 1: Register the Endpoint in the Oracle Key Vault Management Console

The endpoint registration process downloads an `okvclient.jar` file, which contains the Oracle Key Vault software that the endpoint needs, to the local system.

1. Log in to the Oracle Key Vault management console as a user who has the System Administrator role.
2. Select the **Endpoints** tab, and then **Endpoints** in the left navigation bar.
3. Click **Add**.

The Register Endpoint page appears.

The screenshot shows the 'Register Endpoint' form with the following fields and options:

- Endpoint Name ***: Text input field.
- Make Unique**: Check box with a help icon.
- Type ***: Dropdown menu showing 'Oracle Database'.
- Platform ***: Dropdown menu showing 'Linux'.
- Description**: Text area.
- Administrator Email**: Text input field.
- Cluster Subgroup ***: Dropdown menu showing 'austin (from Creator Node)'.

4. Enter the following endpoint details:
 - **Endpoint Name:** Enter a unique name for the endpoint.
 - **Make Unique:** If you are using a multi-master cluster, then choose whether to select the **Make Unique** check box. **Make Unique** helps to control naming conflicts with endpoint names across the multi-master cluster environment.
 - If you select **Make Unique**, then the endpoint will be active immediately for Oracle Key Vault operations.
 - If you do not select **Make Unique**, then the endpoint account will be created in the `PENDING` state. Oracle Key Vault will then begin a name resolution operation and may rename the endpoint name to a name that is unique across the clusters. If there is a naming collision, then you must recreate the endpoint with a unique name. An endpoint in the `PENDING` state cannot be used in any Oracle Key Vault operations.
 - **Type:** Select **Oracle Database Cloud Service**. When you select this option, the [Click here to add a SSH tunnel link](#) appears. Click this link to go to the Add SSH Tunnel page where you can add an SSH tunnel.

- **Platform:** Linux is automatically selected.
 - **Description:** Enter a meaningful description to identify the endpoint.
 - **Administrator Email** Optionally, enter the email address of an administrator who should receive endpoint-related alerts.
 - **Cluster Subgroup:** For a multi-master cluster environment, select the cluster subgroup for this endpoint.
5. Click **Register**.
After a short delay the Endpoints page displays the new endpoint in the **Registered** state with an **Enrollment Token**.
 6. Click **Endpoint Name**. The **Endpoint Details** page appears.
Associate a default wallet with the registered endpoint now before enrolling the endpoint.
 7. Copy the **Enrollment Token**.
You will need it to download the endpoint software and then enroll the endpoint (next step).
 8. Log out of Oracle Key Vault and open a new session.
The login page appears. **Do not log in**.
 9. Click **Endpoint Enrollment and Software Download** immediately below **Login**.
The Enroll Endpoint & Download Software page appears.

[Enroll Endpoint & Download Software](#)
[Download Endpoint Software Only](#)
[Download RESTful Service Utility](#)
[Download Software Development Kit](#)

To enroll an endpoint, enter your endpoint Enrollment Token and click 'Submit Token'. Update the endpoint details if necessary and click 'Enroll' to complete the enrollment. Download the endpoint package when prompted.

Enrollment Token	<input type="text" value="Ny7r2QYgPqyuxDwt"/>	<input type="button" value="Submit Token"/>
Endpoint Type	<input type="text" value="Oracle Database"/>	
Endpoint Platform	<input type="text" value="Linux"/>	
Email	<input type="text" value="hr_admin@example.com"/>	
Description	<input type="text" value="HR employees database"/>	

The fields are populated with the values that were chosen by the Oracle Key Vault system administrator while registering the endpoint. You can change these values while completing the enrollment of the endpoint. Note that you must select the **Primary SSH Tunnel** for Database as a Service endpoints from the drop-down list. This is the only difference in the enrollment process from on-premises endpoints.

10. In the **Enrollment Token** field, enter the endpoint token and then click **Submit Token** to validate the token.
11. Click **Enroll** to download the `okvclient.jar` file to your local system.
12. Move the `okvclient.jar` file to a secure directory on the Cloud Database as a Service instance with appropriate permissions in place so it cannot be read or copied by others.

```
$ scp -i path_to_private_key-file path_to_okvclient.jar_on_local_computer
oracle@node_ip_address:path_to_okvclient.jar_on_cloud_db_instance
```

In this specification:

- `path_to_okvclient.jar_on_local_computer` refers to the location of `okvclient.jar` on an on-premises local computer.
- `path_to_okvclient.jar_on_cloud_db_instance` refers to the location of `okvclient.jar` on the Oracle Cloud Database as a service instance.

Related Topics

- [Types of Endpoint Enrollment](#)
The first step in enrolling an endpoint is to add the endpoint to Oracle Key Vault.
- [Setting the Default Wallet for an Endpoint](#)
Setting a default wallet for an endpoint automatically uploads the endpoint's security objects to the wallet if another wallet is not explicitly specified.

7.4.3 Step 2: Prepare the Endpoint Environment

The endpoint must have a compatible version of the Java Development Toolkit (JDK) and the Oracle Database environment variables must be set.

1. Ensure that you have the necessary administrative privileges to install software on the endpoint.
2. Ensure that you have JDK 1.5 or later installed, and that the `PATH` environment variable includes the `java` executable (in the `JAVA_HOME/bin` directory).
Oracle Key Vault supports JDK versions 1.5, 1.6, 7, and 8. The 64-bit version of Java is required.
3. Run the shell utility `oraenv` or `source oraenv` command to set the correct environment variables on Oracle Database servers.
4. Check that the environment variables `ORACLE_BASE` and `ORACLE_HOME` are correctly set.

If you used `oraenv` to set these variables, then you must verify that `ORACLE_BASE` points to the root directory for Oracle Databases, and that `ORACLE_HOME` points to a sub-directory under `ORACLE_BASE` where an Oracle database is installed.

7.4.4 Step 3: Install the Oracle Key Vault Software onto the Endpoint for Registration and Enrollment

To install the Oracle Key Vault software installation, you run the `okvclient.jar` file on the endpoint.

1. Ensure that you are logged in to the endpoint server as the endpoint administrator.
2. Confirm that the target directory exists, and that it is empty.
3. Run the `java` command to install the `okvclient.jar` file.

```
$ java -jar /tmp/okvclient.jar -d /etc/ORACLE/KEYSTORES/okv
```

In this specification, `-d` specifies the directory location for the endpoint software and configuration files, in this case `/home/oracle/okvutil`.

-o is an optional argument that enables you to overwrite the symbolic link reference to `okvclient.ora` when `okvclient.jar` is deployed in a directory other than the original directory. This argument is used only when you reenroll an endpoint.

Later on, an administrator will need to set the `WALLET_ROOT` parameter to point to the `/etc/ORACLE/KEYSTORES` directory when the Oracle database must be configured to communicate with Oracle Key Vault.

4. When you are prompted for a password, then perform either of the following two steps.

The optional password goes into two places: `okvutil` and in `ADMINISTER KEY MANAGEMENT`. With `okvutil`, only users who know that password can upload or download content to and from Oracle Key Vault. With `ADMINISTER KEY MANAGEMENT`, it becomes the password that you must use in the `IDENTIFIED BY password` clause. If you choose not to give a password, then `okvutil` upload and download commands will not prompt for a password, and the password for `ADMINISTER KEY MANAGEMENT` becomes `NULL`.

The choices for handling the password are as follows:

- If you want to create a password-protected wallet, at minimum enter a password between 8 and 30 characters and then press **Enter**. For better security, Oracle recommends that you include uppercase letters, lowercase characters, special characters, and numbers in the password. The following special characters are allowed: (`.`), comma (`,`), underscore (`_`), plus sign (`+`), colon (`:`), space.

```
Enter new Key Vault endpoint password (<enter> for auto-login):
Key_Vault_endpoint_password
Confirm new endpoint password: Key_Vault_endpoint_password
```

A password-protected wallet is an Oracle wallet file that store the endpoint's credentials to access Oracle Key Vault. This password will be required whenever the endpoint connects to Oracle Key Vault.

- Alternatively, enter no password and then press **Enter**.

A successful installation of the endpoint software creates the following directories:

- `bin` directory, with these contents:
 - `okveps.x64` binary file
 - `okvutil` program
 - `root.sh` and `root.bat` scripts
- `conf` directory, with these contents:
 - `ewallet.p12` wallet file (Note that this wallet is the optional persistent cache. It is an auto-open wallet when the `okvclient.jar` file is installed without a password. It is protected with the Oracle Key Vault password if one is defined during the Oracle Key Vault client installation. It is protected with a random (unknown) password if that selection is made for this endpoint in the Oracle Key Vault management console.)
 - `logging.properties` configuration file
 - `okvclient.lck` lock file
 - `okvclient.ora` configuration file

- `okv.pc.lck` lock file
- `csdk` directory, with this subdirectory:
 - `lib`
- `jlib` directory, with the following file:
 - `okvutil.jar` Java library jar file
- `lib` directory with the following file:
 - `liborapkcs.so` library that the Oracle database uses to communicate with Oracle Key Vault
- `log` directory, which contains the following file:
 - `okvutil.deploy.log` log file
- `ssl` directory, with the following file:
 - `ewallet.p12`, which refers to a password-protected wallet. The `cwallet.sso` file refers to an auto-login wallet. These are TLS-related files and wallet files. The wallet files contain the endpoint credentials to connect to Oracle Key Vault.

7.4.5 Step 4: Perform Post-Installation Tasks

Post-installation tasks are important for a fully functioning Oracle Key Vault installation.

After you complete the installation, you can optionally configure a TDE connection for the endpoint, check the installation contents, and then delete the `okvclient.jar` file.

1. Optionally, configure a TDE connection for the endpoint.

The `liborapkcs.so` file contains the library that the Oracle database uses to communicate with Oracle Key Vault. If an endpoint uses online TDE master encryption key management by Oracle Key Vault, then you must perform this step.

Log in as the `root` user and then execute either of the following commands:

```
$ sudo /etc/ORACLE/KEYSTORES/okv/bin/root.sh
```

This command creates the directory tree `/opt/oracle/extapi/64/hsm/oracle/1.0.0`, changes ownership and permissions, then copies the PKCS#11 library into this directory.

2. Use a command such as `namei` or `ls -l` to confirm that a softlink was created in `$ORACLE_BASE/okv/$ORACLE_SID/okvclient.ora` to point to the real file in the `/conf` subdirectory of the installation target directory.

If the `ORACLE_BASE` environment variable has not been set, then the softlink was created in `$ORACLE_HOME/okv/$ORACLE_SID`.

3. Run the `okvutil list` command to verify that the endpoint software installed correctly, and that the endpoint can connect to the Oracle Key Vault server.

```
$ ./okvutil list
```

If the endpoint is able to connect to Key Vault, then the `No objects found` message appears. If a `Server connect failed` message appears, then you must troubleshoot the installation for possible issues. Check that environment variables are correctly set. To get help on the endpoint software, execute the following command:

```
$ java -jar okvclient.jar -h
```

Output similar to the following appears:

```
Production on Fri Apr 12 15:03:01 PDT 2019
Copyright (c) 1996, 2019 Oracle. All Rights Reserved.
Usage:
  java -jar okvclient.jar [-h | -help] [[-v | -verbose] [-d <destination
directory>] [-o]]

Options:
  -h or -help : Display command help.
  -v or -verbose : Turn on the verbose mode. Logs will be written to files
under
                  <destination directory>/log/ directory.
  -d <destination directory> : Specify the software installation directory.
  -o : Overwrite the current symbolic link to okvclient.ora.
```

7.5 Suspending Database Cloud Service Access to Oracle Key Vault

You can suspend one or more enrolled Database as a Service endpoints from access to Oracle Key Vault.

- [About Suspending Database Cloud Service Access to Oracle Key Vault](#)
When the DBaaS service is suspended, the Oracle Key Vault Server rejects all requests from the suspended endpoints.
- [Suspending Access for a Database Cloud Service to Oracle Key Vault](#)
After you suspend the Database as a Service access to Oracle Key Vault, you can resume the access when needed.

7.5.1 About Suspending Database Cloud Service Access to Oracle Key Vault

When the DBaaS service is suspended, the Oracle Key Vault Server rejects all requests from the suspended endpoints.

When you use an on-premises Oracle Key Vault to manage the online master keys for Database as a Service endpoints, the master encryption keys are never stored persistently in Oracle Cloud. This way, the on-premises Oracle Key Vault administrator can control access to the encrypted data in the cloud.

An on-premises Oracle Key Vault administrator can suspend Database as a Service endpoints with a single click. This means that the Oracle Key Vault Server rejects all requests from the suspended endpoints. Because the endpoint cannot request keys from the Oracle Key Vault server, its ability to access encrypted data is lost after the key cached in memory times out. For Oracle Database Cloud Service endpoints, this time out is 5 minutes by default.

The on-premises Oracle Key Vault administrator can resume a suspended endpoint. This means that the Oracle Key Vault server can start servicing requests from the reinstated endpoint. The reinstated endpoint can now retrieve keys from the Oracle Key Vault server and access sensitive data.

In a multi-master cluster, when a node is being enabled or disabled, the information may not yet have reached all nodes in the cluster. If an endpoint attempts to contact a

node whose information has not yet propagated throughout the cluster, an error may be returned.

 **Caution:**

The suspend operation is a disruptive operation as it results in operational discontinuity. Therefore, you should use it with care. Usually, you should suspend the database only if there is a strong indication of abnormal activity in the Database as a Service instance.

You can only suspend enrolled endpoints. You cannot suspend endpoints that are in the **Registered** state. If you try to suspend endpoints that are already suspended, no operation will be performed. The endpoints will continue to be in suspended state.

7.5.2 Suspending Access for a Database Cloud Service to Oracle Key Vault

After you suspend the Database as a Service access to Oracle Key Vault, you can resume the access when needed.

1. Log in to the Oracle Key Vault management console as a user who has the System Administrator role.
2. Select the **Endpoints** tab, and then **Endpoints** in the left navigation bar.
3. In the Endpoints page, check the boxes by the endpoints that you want to suspend.
4. Click **Suspend**.
5. In the confirmation dialog box, click **Yes**.
6. Click **Endpoints** to see the suspended endpoints.

The status of suspended endpoints is highlighted in red.

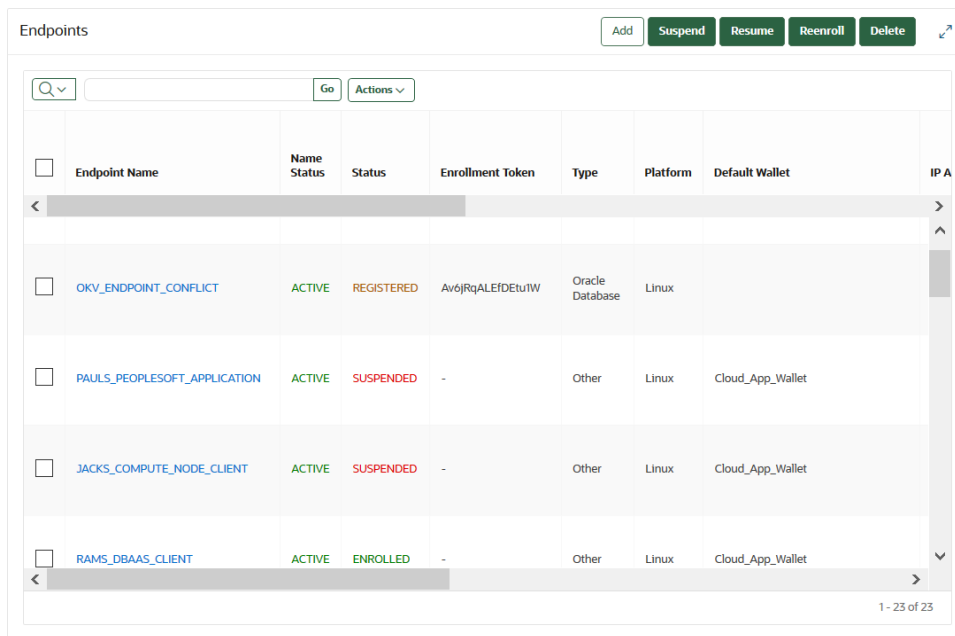

<input type="checkbox"/>	Endpoint Name	Name Status	Status	Enrollment Token	Type	Platform	Default Wallet	IP A
<input type="checkbox"/>	OKV_ENDPOINT_CONFLICT	ACTIVE	REGISTERED	Av6jRqALEfDEtu1W	Oracle Database	Linux		
<input type="checkbox"/>	PAULS_PEOPLESOFT_APPLICATION	ACTIVE	SUSPENDED	-	Other	Linux	Cloud_App_Wallet	
<input type="checkbox"/>	JACKS_COMPUTE_NODE_CLIENT	ACTIVE	SUSPENDED	-	Other	Linux	Cloud_App_Wallet	
<input type="checkbox"/>	RAMS_DBAAS_CLIENT	ACTIVE	ENROLLED	-	Other	Linux	Cloud_App_Wallet	

7.6 Resuming Database Cloud Service Access to Oracle Key Vault

You can reinstate the connection between suspended Database Cloud Service endpoints and Oracle Key Vault.

When you resume these endpoints, their status will change to **Enrolled**. Resuming enrolled endpoints does not change their enrolled status.

1. Log in to the Oracle Key Vault management console as a user who has the System Administrator role.
2. Select the **Endpoints** tab, and then **Endpoints** in the left navigation bar.
3. In the Endpoints page, check the boxes by the endpoints that you want to resume.
4. Click **Resume**.
5. In the confirmation dialog box, click **Yes**.
6. Click **Endpoints** to see the reenrolled endpoints. Their status is **Enrolled**.

Endpoints Add Suspend Resume Reenroll Delete ↗

Q Go Actions ▾

<input type="checkbox"/>	Endpoint Name	Name Status	Status	Enrollment Token	Type	Platform	Default Wallet	IP A
<input type="checkbox"/>	OKV_ENDPOINT_CONFLICT	ACTIVE	REGISTERED	Av6jRqALEfDEtuIW	Oracle Database	Linux		
<input type="checkbox"/>	PAULS_PEOPLESOFT_APPLICATION	ACTIVE	ENROLLED	-	Other	Linux	Cloud_App_Wallet	
<input type="checkbox"/>	JACKS_COMPUTE_NODE_CLIENT	ACTIVE	ENROLLED	-	Other	Linux	Cloud_App_Wallet	
<input type="checkbox"/>	RAMS_DBAAS_CLIENT	ACTIVE	ENROLLED	-	Other	Linux	Cloud_App_Wallet	

1 - 23 of 23

7.7 Resuming a Database Endpoint Configured with a Password-Based Keystore

Depending on the configuration, a Database as a Service endpoint can resume either automatically or must be manually resumed.

A Database as a Service endpoint that is configured with auto-login keystore support will begin operations as soon as one of the nodes configured with reverse SSH access restores connectivity to the DBCS endpoint. On the other hand, the Database as a Service endpoint configured with password keystore will not resume operations after the endpoint is resumed on the Oracle Key Vault server. The keystore on the Database as a Service instance was closed because Oracle Key Vault suspended the endpoint. You should open the password-based keystore on the Database as a Service instance to resume operations.

8

Managing Oracle Key Vault Users

Oracle Key Vault users administer the system, enroll endpoints, manage users and endpoints, control access to security objects, and grant other users administrative roles.

- [Managing User Accounts](#)
You can create Oracle Key Vault user accounts, grant these users Key Vault administrative roles, and add the users to user groups. You can also grant users system privileges for managing endpoints and endpoint groups.
- [Managing Administrative Roles and User Privileges](#)
Oracle Key Vault has predefined roles and privileges that you can grant to (or change) or revoke from users.
- [Managing User Passwords](#)
You or the user can change the user's password. You also can have passwords reset automatically.
- [Managing User Email](#)
Oracle Key Vault users should have their current email on file so that they can receive alerts such as system changes.
- [Managing User Groups](#)
You can organize users who have a common purpose into a named user group.

8.1 Managing User Accounts

You can create Oracle Key Vault user accounts, grant these users Key Vault administrative roles, and add the users to user groups. You can also grant users system privileges for managing endpoints and endpoint groups.

- [About Oracle Key Vault User Accounts](#)
Oracle Key Vault users fulfill multiple functions.
- [How a Multi-Master Cluster Affects User Accounts](#)
An Oracle Key Vault multi-master cluster environment affects users in various ways.
- [Creating an Oracle Key Vault User Account](#)
A user with the System Administrator role can create user accounts from the Oracle Key Vault management console.
- [Viewing User Account Details](#)
All administrative users can view the list of Oracle Key Vault user accounts and their details.
- [Deleting an Oracle Key Vault User Account](#)
Deleting an Oracle Key Vault user removes the user from any user groups the user was part of in Oracle Key Vault.

8.1.1 About Oracle Key Vault User Accounts

Oracle Key Vault users fulfill multiple functions.

An important user function is to register and enroll Oracle Key Vault endpoints, enabling the user to manage his or her [security objects](#) by using Oracle Key Vault.

There are three types of Oracle Key Vault users:

- Administrative users who have one or more of the three administrative roles: System Administrator, Key Administrator, or Audit Manager
- Users who have any of the following privileges: Create Endpoint, Manage Endpoint, Create Endpoint Group, Manage Endpoint Group
- Ordinary users who have none of the administrative roles, but who have access to security objects

Separation of duties in Oracle Key Vault means that users with an administrative role or privilege have access to functions pertaining to their role or privilege, but not other roles or privileges. For example, only a user with the System Administrator role has access to the full **System** tab, not users with the Key Administrator or Audit Manager roles. A user who has the Key Administrator role or a user with the Manage Endpoint Group privilege can add endpoint groups (but cannot add endpoints). The user interface elements needed to create endpoint groups are visible only to the users who have the privileges for managing endpoints and endpoint groups.

Users who have no administrative role can be granted access to security objects that are specific to their function. For example, you can grant a user access to a specific virtual wallet. This user can log into the Oracle Key Vault management console and add, manage, and delete his or her own security objects, but he or she cannot see system menus, details of other users and endpoints, their wallets, or audit reports.

Although the separation of user duties is recommended, you can have a single user perform all the administrative functions by granting that user all the administrative roles.

Oracle Key Vault does not permit the user name to be the same as the name of another user or an endpoint. If you are creating users in a multi-master cluster environment, there is a chance that user with the same name will be created in another node at the same time. In that case, Oracle Key Vault checks for naming conflicts and will automatically rename the user account that was created after the first user account of that name. You must either accept the generated name for the second user or drop the user and then recreate it with a different name.

8.1.2 How a Multi-Master Cluster Affects User Accounts

An Oracle Key Vault multi-master cluster environment affects users in various ways.

These can include expanding the activities that they can perform and ensuring that their names do not conflict with other objects in the cluster environment.

- [Multi-Master Cluster Effect on System Administrator Users](#)
The user who is granted the System Administrator role is responsible for managing the cluster configuration.
- [Multi-Master Cluster Effect on Key Administrator Users](#)
The user who is granted the Key Administrator role manages endpoint groups, user groups, wallets, and objects.
- [Multi-Master Cluster Effect on Audit Manager Users](#)
The user who is granted the Audit Manager role is responsible for configuring audit settings.

- [Multi-Master Cluster Effect on Administration Users](#)
Administrative users can have any combination of the administration roles, including the System Administrator, Key Administrator, and Audit Manager roles.
- [Multi-Master Cluster Effect on System Users](#)
System users are responsible for the operating system of each Oracle Key Vault appliance, server, and node.

8.1.2.1 Multi-Master Cluster Effect on System Administrator Users

The user who is granted the System Administrator role is responsible for managing the cluster configuration.

The System Administrator role in a multi-master cluster includes the following responsibilities:

- All system administrator responsibilities for a single Oracle Key Vault server
- Cluster initialization, converting the first Oracle Key Vault server to the initial node
- Adding and removing nodes from the cluster
- Disabling and enabling nodes in the cluster
- Managing cluster-wide system settings
- Monitoring cluster operations and cluster health indicators
- Enabling and disabling replication between nodes
- Monitoring and resolving data and naming conflicts
- Monitoring and reacting to cluster alerts
- Managing cluster settings

The user who has the System Administrator privilege can also create and then manage endpoints. A user with the Create Endpoint privilege can create his or her own endpoints, and a user with the Manage Endpoint privilege can manage his or her own endpoints.

8.1.2.2 Multi-Master Cluster Effect on Key Administrator Users

The user who is granted the Key Administrator role manages endpoint groups, user groups, wallets, and objects.

In a multi-master cluster, when these items are uploaded in separate nodes and in separate data centers, name conflicts can occur. The key administrator provides input to the system administrator to resolve these conflicts for wallets, KMIP objects, endpoint groups, and user groups.

A user with the Create Endpoint Group privilege can create his or her own endpoint groups, and a user with the Manage Endpoint Group privilege can manage his or her own endpoint groups.

Related Topics

- [Naming Conflicts and Resolution](#)
Oracle Key Vault can resolve naming conflicts that can arise as users create objects such as endpoints, endpoint groups, and user groups.

8.1.2.3 Multi-Master Cluster Effect on Audit Manager Users

The user who is granted the Audit Manager role is responsible for configuring audit settings.

In a multi-master cluster environment, this user can configure audit settings for the entire cluster and for individual nodes. The audit manager user can use different settings for different nodes, if necessary. However, this user can also unify audit settings across the entire cluster.

The audit manager can replicate audit trails between nodes, if necessary. However, this can result in significant traffic between nodes, so the audit manager can turn on or off the audit trail replication. By default, the audit trails replication is turned off.

8.1.2.4 Multi-Master Cluster Effect on Administration Users

Administrative users can have any combination of the administration roles, including the System Administrator, Key Administrator, and Audit Manager roles.

Administrative user information created in the Oracle Key Vault server that is used as the initial node seeds the cluster.

New servers added to a cluster will get administrative user information from the cluster. Administrator information that is created on the server for the purpose of inducting the server into the cluster will be removed.

Administrative users that are created in a node after the node joins an Oracle Key Vault cluster will have a cluster-wide presence. New administrative users that are added to the Oracle Key Vault cluster on different Oracle Key Vault nodes may have name conflicts. When the user account is created, Oracle Key Vault automatically resolves the administrative user name conflicts. User and endpoint conflicts will be displayed in the Conflicts Resolution page and administrators can choose to rename endpoint conflicts. If there is a user name conflict, then you must either accept the automatically generated user name, or delete and recreate the user. User accounts will not be available for use and will be placed in a `PENDING` state until the name resolution is completed. User accounts in the `PENDING` state cannot be deleted.

Related Topics

- [Naming Conflicts and Resolution](#)
Oracle Key Vault can resolve naming conflicts that can arise as users create objects such as endpoints, endpoint groups, and user groups.

8.1.2.5 Multi-Master Cluster Effect on System Users

System users are responsible for the operating system of each Oracle Key Vault appliance, server, and node.

Oracle Key Vault servers are first installed or later configured to become nodes of an Oracle Key Vault cluster. As part of the server configuration, the operating system users (`support` and `root`) are created. Those users will remain unchanged after the server joins a cluster.

Unless security requirements specify otherwise, the same `support` and `root` passwords should be used for all the Oracle Key Vault nodes. Unlike Oracle Key Vault administrative accounts that are replicated, the `support` and `root` accounts are operating system users, and their passwords are not automatically synchronized across the cluster. Therefore, each node can potentially have a different `support` or `root` user password, making it difficult to manage multiple nodes of the cluster.

8.1.3 Creating an Oracle Key Vault User Account

A user with the System Administrator role can create user accounts from the Oracle Key Vault management console.

1. Log in to the Oracle Key Vault management console as a user who has the System Administrator role.

2. Select the **Users** tab, and then **Manage Users** in the left navigation bar.

The Manage Users page appears with a list of existing users.

3. In the Manage Users page, click **Create**.

The Create User page appears.

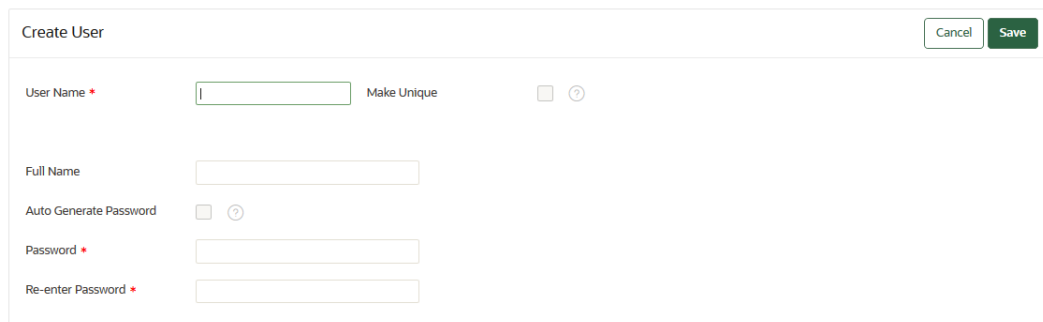

The screenshot shows the 'Create User' form with the following fields and options:

- User Name ***: A text input field with a 'Make Unique' checkbox and a refresh icon.
- Full Name**: A text input field.
- Auto Generate Password**: A checkbox with a refresh icon.
- Password ***: A text input field.
- Re-enter Password ***: A text input field.

Buttons: 'Cancel' (light gray) and 'Save' (green).

4. Enter a user name in **User Name**.

See [Naming Guidelines for Objects](#). Ensure that the user name is not the same as an Oracle Key Vault endpoint name.

5. If you are using a multi-master cluster, then choose whether to select the **Make Unique** check box.

Make Unique helps to control naming conflicts with user names across the multi-master cluster environment. When a server is converted to a cluster node, then the character limit for user names drops from 128 to 120 to allow for automatic renaming in case of a conflict. Users that were created before an Oracle Key Vault conversion to a cluster node are not affected by naming conflicts.

- If you select **Make Unique**, then the user account will be active immediately and this user can perform operations.
- If you do not select **Make Unique**, then the user account will be created in the `PENDING` state. Oracle Key Vault will then begin a name resolution operation and may rename the user account to a name that is unique across the cluster. If there is a naming collision, then the collision will be reported on the Conflicts page on any node in the cluster. The user account will then be renamed to a unique name. You will need to go to a read-write node of the cluster and either accept the renamed user account or change the user account name. If you change the user account name, then this will restart the name resolution operation and the user account will return to a `PENDING` state. A user account in the `PENDING` state cannot be used to perform most operations.

6. Optionally, add the user's full name in **Full Name**.

7. For the password, do one of the following:

- **Auto Generate Password:** Select this option to have a password automatically generated and sent to the user. The user will receive an email message with `Oracle Key Vault: System Generated User Password` in the subject line. When the user logs in to the Oracle Key Vault management console for the first time, he or she will be asked to change the password.
The SMTP server configuration must be configured to use this option.
- **Password and Re-enter password:** Enter a valid password. Passwords must have 8 or more characters and contain at least one of each of the following: an uppercase letter, lowercase letter, number, and special character. The special characters allowed are period (.), comma (,), underscore (_), plus sign (+), colon (:), and space.

8. Click **Save**.

The **Manage Users** page appears and lists the new user. If the user is in the `PENDING` state, then it remains in the Users being created section until it transitions to the `ACTIVE` state, similar to the following example.

User Name	Full Name	System Admin	Key Admin	Audit Manager	Creation Time	Created By	Creator Node
<input type="checkbox"/> RICKY					09-NOV-2020 15:12:40	OKVADMIN	node1
<input type="checkbox"/> ANDY					09-NOV-2020 15:12:13	OKVADMIN	node1
<input type="checkbox"/> SCOTT					09-NOV-2020 15:11:51	OKVADMIN	node1
<input type="checkbox"/> SIMRAN					09-NOV-2020 15:11:17	OKVADMIN	node1
<input type="checkbox"/> MIKE					09-NOV-2020 15:10:58	OKVADMIN	node1
<input type="checkbox"/> BOB					09-NOV-2020 15:10:32	OKVADMIN	node1
<input type="checkbox"/> OKVADMIN		✓	✓	✓	09-NOV-2020 08:53:47	SAM_SYSADMIN	node1
<input type="checkbox"/> ALICE_AUDADMIN				✓	09-NOV-2020 08:49:28		node1
<input type="checkbox"/> SAM_CVSADMIN		✓			09-NOV-2020		node1

User Name	Full Name	Created By	Creator Node
NANCY	Nancy Smith	OKVADMIN	node1

Related Topics

- [Naming Conflicts and Resolution](#)
Oracle Key Vault can resolve naming conflicts that can arise as users create objects such as endpoints, endpoint groups, and user groups.
- [Managing Administrative Roles and User Privileges](#)
Oracle Key Vault has predefined roles and privileges that you can grant to (or change) or revoke from users.
- [Configuring Email Notification](#)
You can use email notifications to directly notify administrators of Key Vault status changes without logging into the Oracle Key Vault management console.

8.1.4 Viewing User Account Details

All administrative users can view the list of Oracle Key Vault user accounts and their details.

Users without any of the three administrative roles can only see their own user details. The **User Details** page provides a consolidated view of the Oracle Key Vault user. This is the page where all user management tasks are performed.

1. Log in to the Oracle Key Vault management console.
2. Select the **Users** tab, and then **Manage Users** in the left navigation bar.

The **Manage Users** page appears with a list of existing users. You can sort and search the list by the column user name, full name, or roles.

3. Click on a user name to display the **User Details** page.

Related Topics

- [Administrative Roles and Endpoint Privileges within Oracle Key Vault](#)
Oracle Key Vault provides separation of duty compliant administrative roles and privileges that you can combine in various ways to meet enterprise needs.
- [Oracle Key Vault Installation and Upgrade Guide](#)

8.1.5 Deleting an Oracle Key Vault User Account

Deleting an Oracle Key Vault user removes the user from any user groups the user was part of in Oracle Key Vault.

The operation does not delete any security objects managed by the user. Administrators can only delete users that are not in the `PENDING` state.

1. Log in to the Oracle Key Vault management console as a user with the System Administrator role and the same roles as the user being deleted, should that user have any administrative roles.
2. Select the **Users** tab, and then **Manage Users** in the left navigation bar.
The **Manage Users** page appears with a list of existing users.
3. Check the boxes by the users you want to delete.
4. Click **Delete**.
5. In the confirmation dialog box, click **OK**.
6. Click **Save**.

8.2 Managing Administrative Roles and User Privileges

Oracle Key Vault has predefined roles and privileges that you can grant to (or change) or revoke from users.

- [About Managing Administrative Roles and User Privileges](#)
You can grant or change an administrative role or user privileges for a user account that you have added.
- [Granting or Changing an Administrative Role of a User](#)
You can use the Manage Users page to grant or change a user administrative role.

- [Granting the Create Endpoint Privilege](#)
The Create Endpoint privilege enables a user to create the user's own endpoints.
- [Granting the Manage Endpoint Privilege](#)
The Manage Endpoint privilege enables a user to manage the user's own endpoints.
- [Granting the Create Endpoint Group Privilege](#)
The Create Endpoint Group privilege enables a user to create the user's own endpoint groups.
- [Granting the Manage Endpoint Group Privilege](#)
The Manage Endpoint Group privilege enables a user to manage the user's own endpoint groups.
- [Granting a User Access to a Virtual Wallet](#)
A user with the Key Administrator role controls access to security objects for users, endpoints, and their respective groups.
- [Revoking an Administrative Role or Endpoint Privilege from a User](#)
You can use the Manage User page to revoke a role or an endpoint privilege from a user.

8.2.1 About Managing Administrative Roles and User Privileges

You can grant or change an administrative role or user privileges for a user account that you have added.

You must be a user with the System administrative role to grant, change, or revoke the Create Endpoint and Manage Endpoint privileges to or from other users. You must be a user with the Key Administrative role to grant, change, or revoke the Create Endpoint Group and Manage Endpoint Group privileges to or from other users. You can also revoke the privilege when it is no longer needed. Users with the Create Endpoint, Manage Endpoint, Create Endpoint Group, or Manage Endpoint Group privilege cannot grant this privilege to other users.

If you are using a multi-master cluster environment, then you cannot grant, change, and revoke administrative roles for users in the `PENDING` state.

If you are using a multi-master cluster environment, then you cannot grant, change, and revoke user privileges for users in the `PENDING` state

8.2.2 Granting or Changing an Administrative Role of a User

You can use the Manage Users page to grant or change a user administrative role.

1. Log in to the Oracle Key Vault management console as a user who has the same role that is to be granted.

For example, if the user needs the System Administrator role, then log in as a user who has been granted the System Administrator role.

2. Select the **Users** tab, and then **Manage Users** in the left navigation bar.

The Manage Users page appears displaying the list of users.

Manage Users Create Delete

Q | Go Actions

<input type="checkbox"/>	User Name	Full Name	System Admin	Key Admin	Audit Manager	Creation Time	Created By	Creator Node
<input type="checkbox"/>	ROHIT	Rohit Pavel			✓	09-NOV-2020 15:14:14	OKVADMIN	node1
<input type="checkbox"/>	JACK	Jack Smith		✓		09-NOV-2020 15:13:33	OKVADMIN	node1
<input type="checkbox"/>	RICKY	Ricky Layton			✓	09-NOV-2020 15:12:40	OKVADMIN	node1
<input type="checkbox"/>	ANDY	Andy Foster		✓		09-NOV-2020 15:12:13	OKVADMIN	node1
<input type="checkbox"/>	SCOTT	Scott O'Hara	✓			09-NOV-2020 15:11:51	OKVADMIN	node1

- Click the name of the user in the **User Name** column.

The User Details page appears. The User Details page provides a consolidated view of the Oracle Key Vault user. It displays the following user information: user name, email, administrative role, user privileges, membership in user groups, endpoints that the user has the Manage Endpoint privilege on, endpoint groups that the user has Manage Endpoint Group privilege on, and access to wallets.

User Details Cancel Reset Password Save

User Name: OKV_OLIVER

Roles

Roles Audit Manager
 Key Administrator
 System Administrator

Privileges ?

Create Endpoint ?
 Create Endpoint Group ?

Full Name:

User Group Membership Add Remove

Go

Access to Wallets Add Remove

Go

Actions

- To grant a role, check the **Roles** box for the role you want to grant.

To change a role, uncheck the box for the previous role and check the box by the new role. If you do not see the role listed that you want to grant, then you are logged in as a user who does not have that role and therefore do not have the privilege to grant it.

- Click **Save**.

You cannot grant or revoke administrator roles to an LDAP user directly. LDAP users can be granted administrative roles only through LDAP group mappings.

Related Topics

- [Privilege Grants and Revokes for LDAP Users](#)
LDAP users have limited access to Oracle Key Vault role and privilege grants.

8.2.3 Granting the Create Endpoint Privilege

The Create Endpoint privilege enables a user to create the user's own endpoints.

1. Log in to the Oracle Key Vault management console as a user who has the System Administrator role.
Users who have the Create Endpoint privilege cannot grant it to other users.
2. Select the **Users** tab, and then **Manage Users** in the left navigation bar.
The Manage Users page appears displaying the list of users.
3. Select the user to whom you want to grant the Create Endpoint privilege.
4. Under User Details, select the **Create Endpoint** check box.
5. Click **Save**.

After the user has been granted the Create Endpoint privilege, this user cannot be granted the System Management, Key Management, or Audit Manager roles until the Create Endpoint privilege or any other endpoint privilege that the user has been granted is revoked from the user. In addition, you cannot grant LDAP users the Create Endpoint privilege or any other endpoint privilege.

Related Topics

- [Privilege Grants and Revokes for LDAP Users](#)
LDAP users have limited access to Oracle Key Vault role and privilege grants.

8.2.4 Granting the Manage Endpoint Privilege

The Manage Endpoint privilege enables a user to manage the user's own endpoints.

1. Log in to the Oracle Key Vault management console as a user who has the System Administrator role.
Users who have the Manage Endpoint privilege cannot grant it to other users.
2. Select the **Users** tab, and then **Manage Users** in the left navigation bar.
The Manage Users page appears displaying the list of users.
3. Select the user to whom you want to grant the Manage Endpoint privilege.
4. In the Access on Endpoints area, click **Add**.
5. In the Add Endpoint Access to User page, under Select Endpoint, select the endpoint to which you want to grant the user the Manage Endpoint privilege.
6. Click **Save**.

After the user has been granted the Manage Endpoint privilege on the selected endpoints, this user cannot be granted the System Management, Key Management, or Audit Manager roles until the Manage Endpoint privilege or any other endpoint

privilege that the user has been granted is revoked. In addition, you cannot grant LDAP users the Manage Endpoint privilege or any other endpoint privilege.

Related Topics

- [Privilege Grants and Revokes for LDAP Users](#)
LDAP users have limited access to Oracle Key Vault role and privilege grants.

8.2.5 Granting the Create Endpoint Group Privilege

The Create Endpoint Group privilege enables a user to create the user's own endpoint groups.

1. Log in to the Oracle Key Vault management console as a user who has the Key Administrator role.
Users who have the Create Endpoint Group privilege cannot grant it to other users.
2. Select the **Users** tab, and then **Manage Users** in the left navigation bar.
The Manage Users page appears displaying the list of users.
3. Select the user to whom you want to grant the Create Endpoint Group privilege.
4. Under User Details, select the **Create Endpoint Group** check box.
5. Click **Save**.

After the user has been granted the Create Endpoint Group privilege, this user cannot be granted the System Management, Key Management, or Audit Manager roles until the Create Endpoint Group privilege or any other endpoint privilege that the user has been granted is revoked from the user. In addition, you cannot grant LDAP users the Create Endpoint Group privilege or any other endpoint privilege.

Related Topics

- [Privilege Grants and Revokes for LDAP Users](#)
LDAP users have limited access to Oracle Key Vault role and privilege grants.

8.2.6 Granting the Manage Endpoint Group Privilege

The Manage Endpoint Group privilege enables a user to manage the user's own endpoint groups.

1. Log in to the Oracle Key Vault management console as a user who has the Key Administrator role.
Users who have the Manage Endpoint Group privilege cannot grant it to other users.
2. Select the **Users** tab, and then **Manage Users** in the left navigation bar.
The Manage Users page appears displaying the list of users.
3. Select the user to whom you want to grant the Manage Endpoint Group privilege.
4. In the Access on Endpoint Groups area, click **Add**.
5. In the Add Endpoint Group Access to User page, in the Select Endpoint Group area, select the endpoint group to which you want to grant the user the Manage Endpoint Group privilege.
6. Click **Save**.

After the user has been granted the Manage Endpoint Groups privilege on the selected endpoint groups, this user cannot be granted the System Management, Key Management, or Audit Manager roles until the Manage Endpoint Groups privilege or any other endpoint privilege that the user has been granted is revoked from the user. In addition, you cannot grant LDAP users the Manage Endpoint Group privilege or any other endpoint privilege.

Related Topics

- [Privilege Grants and Revokes for LDAP Users](#)
LDAP users have limited access to Oracle Key Vault role and privilege grants.

8.2.7 Granting a User Access to a Virtual Wallet

A user with the Key Administrator role controls access to security objects for users, endpoints, and their respective groups.

Any user can be granted access to security objects in Oracle Key Vault at a level that is appropriate to their function in the organization.

You cannot grant access to a virtual wallet if the wallet is in the `PENDING` state.

1. Log in to the Oracle Key Vault management console as a user who has the Key Administrator role.
2. Select the **Users** tab, and then **Manage Users** in the left navigation bar.
The Manage Users page appears displaying the list of users.
3. Click the name of the user you want to grant access.
The **User Details** page appears.
4. Click **Add** in the **Access to Wallets** section.
The **Add Access to User** page appears.
5. Select the wallet under **Select Wallet**.
6. Set the access level to the selected wallet under **Select Access Level: Read Only, Read and Modify, or Manage Wallet**.
Set access levels when you grant access to the wallet, if you know the level to grant. You can also set or modify access levels from the wallet menu.
7. Click **Save**.

Related Topics

- [Access Control Configuration](#)
Oracle Key Vault enables you to control access to security objects at various access levels.
- [Managing Access to Virtual Wallets from Keys & Wallets Tab](#)
You can grant virtual wallet access to and revoke virtual wallet access from endpoint by using the **Keys & Wallets** tab.

8.2.8 Revoking an Administrative Role or Endpoint Privilege from a User

You can use the Manage User page to revoke a role or an endpoint privilege from a user.

- Depending on the administrative role or privilege that you want to revoke, log in to the Oracle Key Vault management console as follows:
 - Administrative roles:** Log in as a user who has the same role. You can only grant and revoke roles for which you are an administrator.
 - Create Endpoint or Manage Endpoint privilege:** Log in as a user who has the System Administrator role.
 - Create Endpoint Group or Manage Endpoint Group privilege:** Log in as a user who has the Key Administrator role.
- Select the **Users** tab, and then **Manage Users** in the left navigation bar.

The Manage Users page appears displaying the list of users.

<input type="checkbox"/>	User Name	Full Name	System Admin	Key Admin	Audit Manager	Creation Time	Created By	Creator Node
<input type="checkbox"/>	ROHIT	Rohit Pavel			✓	09-NOV-2020 15:14:14	OKVADMIN	node1
<input type="checkbox"/>	JACK	Jack Smith		✓		09-NOV-2020 15:13:33	OKVADMIN	node1
<input type="checkbox"/>	RICKY	Ricky Layton			✓	09-NOV-2020 15:12:40	OKVADMIN	node1
<input type="checkbox"/>	ANDY	Andy Foster		✓		09-NOV-2020 15:12:13	OKVADMIN	node1
<input type="checkbox"/>	SCOTT	Scott O'Hara	✓			09-NOV-2020 15:11:51	OKVADMIN	node1

- Click the user name whose role or endpoint privilege you want to revoke. The **User Details** page appears.
- Revoke privileges as follows:
 - Administrative roles or the Create Endpoint or Create Endpoint Group privileges:** Uncheck the box for the role or endpoint privilege.
 - Manage Endpoint privilege:** When logged in as a user with the System Administrator role, scroll down to the Access on Endpoint area, select the check box for the endpoint, and then click **Remove**.
 - Manage Endpoint Group privilege:** When logged in as a user with the Key Administrator role, scroll down to the Access on Endpoint Group area, select the check box for the endpoint group, and then click **Remove**.
- Click **Save**.

8.3 Managing User Passwords

You or the user can change the user's password. You also can have passwords reset automatically.

- [About Changing User Passwords](#)
Any valid Oracle Key Vault user can change his or her own password.
- [Changing Your Own Password](#)
Any user can change his or her own Oracle Key Vault account password.
- [Changing Another User's Password](#)
You can change another user's password if you have the System Administrator role or the identical administrative roles (at minimum) as the user whose password you want to reset.
- [Controlling the Use of Password Reset Methods](#)
You can restrict the ability of users to reset another user's password manually so that only password reset operations through email notifications are allowed.

8.3.1 About Changing User Passwords

Any valid Oracle Key Vault user can change his or her own password.

You can reset the password of another user if you have at minimum the same administrative roles as that user. For example, if you want to change the password of a user who has the Audit Manager role, then you also must have the Audit Manager role before you can change the password.

Consider the following users and roles:

User	System Admin	Key Admin	Audit Manager
OKV_ALL_JANE	Yes	Yes	Yes
OKV_SYS_KEYS_JOE	Yes	Yes	-
OKV_SYS_SEAN	Yes	-	-
OKV_KEYS_KATE	-	Yes	-
OKV_AUD_AUDREY	-	-	Yes
OKV_OLIVER	-	-	-

Suppose that user OKV_SYS_KEYS_JOE, who has the System Administrator and Key Administrator roles, is logged in and wants to change the other users' passwords. The following happens:

- OKV_KEYS_KATE: OKV_SYS_KEYS_JOE can change the password for OKV_KEYS_KATE because they have the Key Administrator role in common.
- OKV_AUD_AUDREY: OKV_SYS_KEYS_JOE cannot change OKV_AUD_AUDREY's password because OKV_SYS_KEYS_JOE does not have the Audit Manager role.
- OKV_ALL_JANE: OKV_SYS_KEYS_JOE cannot change the password for user OKV_ALL_JANE because he does not have the Audit Manager role.

- OKV_OLIVER: OKV_SYS_KEYS_JOE can change the password for user OKV_OLIVER, who has no roles at all.

Any user can change his or her own password.

Assuming you have privileges to do so, you can change the password of another user by using either of the following methods:

- Specify a new password for the other user and then notify this user of the new password by using any out-of-band method.
- Send the user a randomly generated one-time password to their email account.

Related Topics

- [Controlling the Use of Password Reset Methods](#)
You can restrict the ability of users to reset another user's password manually so that only password reset operations through email notifications are allowed.

8.3.2 Changing Your Own Password

Any user can change his or her own Oracle Key Vault account password.

1. Log in to the Oracle Key Vault management console.
2. Select the **Users** tab, and then **Change Password** in the left navigation bar.

The Change Password page appears for your account.

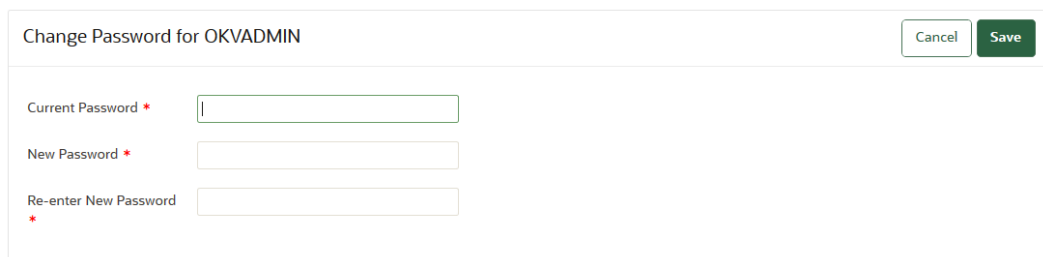

3. Enter your current password in **Current Password**.
4. Enter the new password in **New Password** and **Re-enter New Password**.
5. Click **Save**.

8.3.3 Changing Another User's Password

You can change another user's password if you have the System Administrator role or the identical administrative roles (at minimum) as the user whose password you want to reset.

- [Changing a Password Manually](#)
You can change the password manually for a user and then use any out-of-band method to notify the user of the new password.
- [Changing a Password Through Email Notification](#)
You can change a user's password by sending them a randomly generated one-time password to their email account.

- [Changing the Support User Account Password](#)
Before you perform the post-installation configuration task after the Oracle Key Vault installation, you can change the password for the `support` account in the server terminal console.

8.3.3.1 Changing a Password Manually

You can change the password manually for a user and then use any out-of-band method to notify the user of the new password.

This method of changing password is available only when the `Reset passwords using email only` option in the User Password Recovery tab of the System Recovery page is not checked.

1. Log in to the Oracle Key Vault management console as a user with the System Administrator role.
2. Select the **Users** tab, and then **Manage Users** in the left navigation bar.
The Manage Users page displays the list of users.
3. Click the user name whose password you want to change.
The **User Details** page appears.
4. Click **Reset Password**.

By default, the Auto Generate Password option is selected, so deselect it so that the you can manually change the password.

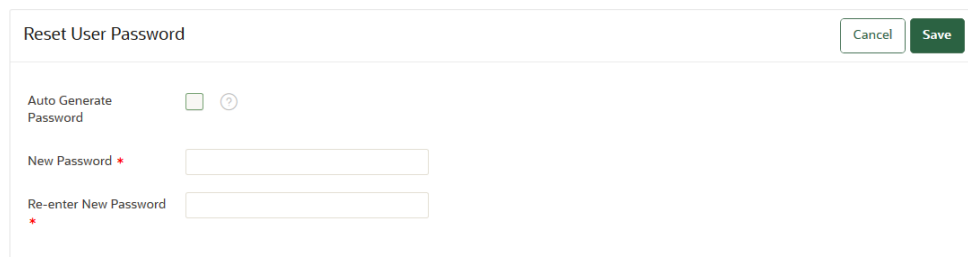

If the **Email Address** field appears instead of the password prompts, then the system has been configured to change passwords through email notification only.

5. Enter the new password in **New Password** and **Re-enter New Password**.
6. Click **Save**.

Related Topics

- [About Controlling the Use of Password Reset Methods](#)
You can configure Oracle Key Vault to only allow users to change another user's password by sending them a randomly generated one-time password through email.

8.3.3.2 Changing a Password Through Email Notification

You can change a user's password by sending them a randomly generated one-time password to their email account.

This one-time password can be sent directly from Oracle Key Vault to the user. You must configure SMTP in email settings in order to use this feature. Oracle recommends that you restrict password recovery functionality to use this method by

selecting the `Reset passwords using email only` option in the User Password Recovery tab of the System Recovery page.

1. Log in to the Oracle Key Vault management console.
2. Select the **Users** tab, and then **Manage Users** in the left navigation bar.
The Manage Users page appears displaying the list of users.
3. Click the user name of the user whose password you want to change.
The User Details page appears.
4. Click **Reset Password**.
The Reset User Password page appears.
5. Check the box by **Auto Generate Password**.
If SMTP is configured, then an email address field appears.
6. Enter the email address of the user.
7. Click **Send One-Time Password**.

If you check **Auto Generate Password** without configuring SMTP, the link **Click here to configure SMTP** appears. Click the link to configure email settings and repeat the steps in this topic.

Related Topics

- [Controlling the Use of Password Reset Methods](#)
You can restrict the ability of users to reset another user's password manually so that only password reset operations through email notifications are allowed.
- [Configuring Email Settings](#)
You can configure the Simple Mail Transfer Protocol (SMTP) server properties to receive email notifications from Oracle Key Vault.

8.3.3.3 Changing the Support User Account Password

Before you perform the post-installation configuration task after the Oracle Key Vault installation, you can change the password for the `support` account in the server terminal console.

After setting the password for the support account during the post-installation task, you can use SSH to change the support password. (When you install Oracle Key Vault, you create this account as part of the process.) The `support` user will be prompted to change their password when the next time they log in is past the expiration time of their passwords. The expiration times are 365 days with a warning at 120 days, and with STIG enabled, it is 60 days with a warning at 60 days.

1. Connect to the server console.
2. Enable SSH.

Log in to the Oracle Key Vault management console as a user who has the System Administrator role. Select the **System** tab, then **Settings**. In the Network Details area, click **SSH Access**. Select **IP address(es)** and then enter only the IP addresses that you need, or select **All**. Click **Save**.

3. As the `root` user, execute the following command to set the password for the support user:

```
passwd support
```

4. Enter and then re-enter the new password for the support user when prompted. After the password is set successfully, the following message is displayed on the console:

```
All authentication tokens updated successfully.
```

8.3.4 Controlling the Use of Password Reset Methods

You can restrict the ability of users to reset another user's password manually so that only password reset operations through email notifications are allowed.

- [About Controlling the Use of Password Reset Methods](#)
You can configure Oracle Key Vault to only allow users to change another user's password by sending them a randomly generated one-time password through email.
- [Configuring the Use of Password Reset Operations](#)
A user who has access to the system recovery passphrase can configure the use of password reset operations

8.3.4.1 About Controlling the Use of Password Reset Methods

You can configure Oracle Key Vault to only allow users to change another user's password by sending them a randomly generated one-time password through email.

The user performing a password change for another user must be either an Oracle Key Vault administrator or have the same or higher privileges as the user whose password needs to be reset.

By default, there are two ways to change another user's password:

- Manually, in which you create a new password for the user. In this scenario, both you and the user will know the password (until this user manually changes his or her own password)
- Automatically, in which you trigger an automatically-generated password for the user, who is then emailed the new password on a one-time basis. In this scenario, only the user knows his or her new password.

You can enable only automatic password generation through email notification and disable manual password reset operations. The email notification uses the email ID that is associated with the user's account. The benefit of this feature is that the newly generated password is known only to the user whose password needed to be reset, not to the user who initiated the user's password change. Users can still change their own passwords when this feature is enabled.

When this feature is disabled, then both methods of user creation are allowed: manual password reset operations, and automatic password reset operations.

8.3.4.2 Configuring the Use of Password Reset Operations

A user who has access to the system recovery passphrase can configure the use of password reset operations

1. Navigate to the Oracle Key Vault management console, but do not log in.
2. Below the login screen, click the **System Recovery** button.
3. When prompted, enter the system recovery passphrase.
4. Select the **User Password Recovery** tab.
5. In the User Password Recovery page, select the **Reset passwords using email only** option to enable or disable this option.
6. Click **Save**.

Related Topics

- [Changing a Password Through Email Notification](#)
You can change a user's password by sending them a randomly generated one-time password to their email account.

8.4 Managing User Email

Oracle Key Vault users should have their current email on file so that they can receive alerts such as system changes.

- [Changing the User Email Address](#)
After creating a user account, you can add or change the user's email address.
- [Disabling Email Notifications for a User](#)
You can disable email notifications for a user on the User Details page.

8.4.1 Changing the User Email Address

After creating a user account, you can add or change the user's email address.

1. Log in to the Oracle Key Vault management console as a user who has the System Administrator role.
2. Select the **Users** tab, and then **Manage Users** in the left navigation bar.
The Manage Users page appears displaying the list of users.
3. Click the user's name in the **User Name** column.
The User Details page appears.
4. Enter the email address in **Email**.
5. Click **Save**.

8.4.2 Disabling Email Notifications for a User

You can disable email notifications for a user on the User Details page.

1. Log in to the Oracle Key Vault management console as a user who has the System Administrator role.

2. Select the **Users** tab, and then **Manage Users** in the left navigation bar.
The Manage Users page appears displaying the list of users.
3. Click the user's name in the **User Name** column.
The **User Details** page appears:
4. Select the **Do not receive email alerts** check box.
5. Click **Save**.

8.5 Managing User Groups

You can organize users who have a common purpose into a named user group.

- [About Managing User Groups](#)
Users who have the Key Administrator role can create, modify, and delete user groups.
- [How a Multi-Master Cluster Affects User Groups](#)
User groups are used at the Oracle Key Vault server and cluster level to group user roles and permissions.
- [Creating a User Group](#)
You can create a user group when a set of users must manage a set of common security objects.
- [Adding a User to a User Group](#)
You can add an existing user to a user group if that user must manage the same security objects as the group.
- [Granting a User Group Access to a Virtual Wallet](#)
You can modify the access level to a virtual wallet for a user group as functional needs change.
- [Renaming a User Group](#)
Depending on its status, you can change the name of a user group.
- [Changing a User Group Description](#)
A group description is useful for identifying the purpose of the group.
- [Removing a User from a User Group](#)
Depending on the circumstances, you can remove a user from a user group.
- [Deleting a User Group](#)
You can delete a user group when the users in the group do not need to access the same security objects.

8.5.1 About Managing User Groups

Users who have the Key Administrator role can create, modify, and delete user groups.

This enables them to manage their access to [virtual wallets](#). After a user group is created, you can modify its details.

The main purpose of a user group is simplify access control to [security objects](#). If a set of users need access to a common set of security objects, then you can assign these users to a group and grant the group access instead of granting access to each user or based on each security object. When certain users do not need access to the security objects any longer, you can remove them from the group. You can add new

users to the group. You can modify the group's access level to security objects at any time.

8.5.2 How a Multi-Master Cluster Affects User Groups

User groups are used at the Oracle Key Vault server and cluster level to group user roles and permissions.

When new servers are inducted into the cluster, Oracle Key Vault replicates any user group information that is in the cluster. You can create new user groups in the cluster from a read-write pair.

User groups created in a node after the node is added to an Oracle Key Vault cluster will have a cluster-wide presence. User groups created on two different nodes could have name conflicts. Oracle Key Vault automatically resolves the user group name conflicts. These conflicts will be displayed in the Conflicts Resolution page and administrators can choose to rename them.

Note the following:

- You cannot change membership by adding or removing users when the user group is in a `PENDING` state. Similarly, users in a pending state cannot be added to, or removed from a user group in the `ACTIVE` state.
- You cannot change access mapping for users and user groups if a wallet is in the `PENDING` state. Similarly, users and user groups in a pending state cannot be added to, or removed from a wallet access mapping even when the wallet is in the `ACTIVE` state.

Related Topics

- [Naming Conflicts and Resolution](#)
Oracle Key Vault can resolve naming conflicts that can arise as users create objects such as endpoints, endpoint groups, and user groups.

8.5.3 Creating a User Group

You can create a user group when a set of users must manage a set of common security objects.

You can add users to the group when you create the group or later after creating the group.

1. Log in to the Oracle Key Vault management console as a user who has the Key Administrator role.
2. Select the **Users** tab, and then **Manage Access** in the left navigation bar.

The User Groups page appears displaying existing user groups.

<input type="checkbox"/>	User Group Name	Name Status	Description	Creation Time	Creator Node	Created By	Edit
<input type="checkbox"/>	AUDIT_ADMIN_USER_GROUP	ACTIVE	This group contains the list of users who have been granted AUDIT MANAGER role to them	09-NOV-2020 15:17:08	node1	OKVADMIN	
<input type="checkbox"/>	SYSTEM_ADMIN_USER_GROUP	ACTIVE	This group contains the list of users who have been granted SYSTEM ADMINISTRATOR role to them	09-NOV-2020 15:16:42	node1	OKVADMIN	
<input type="checkbox"/>	KEY_ADMIN_USER_GROUP	ACTIVE	This group contains the list of users who have been granted KEY ADMINISTRATOR role to them	09-NOV-2020 15:16:17	node1	OKVADMIN	
<input type="checkbox"/>	ALL_ADMIN_USER_GROUP	ACTIVE	This group contains the list of users who have been granted KEY ADMINISTRATOR, SYSTEM ADMINISTRATOR and AUDIT MANAGER roles to them	09-NOV-2020 15:15:52	node1	OKVADMIN	

1 - 4 of 4

3. Click **Create**.

The Create User Group page appears.

Create User Group

Name * Make Unique

Description

4. In the **Name** field, enter the name of the new group.

See [Naming Guidelines for Objects](#).

5. If you are using a multi-master cluster, then choose whether to select the **Make Unique** checkbox.

Make Unique helps to control naming conflicts with names across the multi-master cluster environment. User groups that were created before an Oracle Key Vault conversion to a cluster node are not affected by naming conflicts.

- If you select **Make Unique**, then the group name will be active immediately and this user group can be used in user operations. Clicking **Make Unique** also displays a list of users that you can add to the group.
- If you do not select **Make Unique**, then the user group will be created in the `PENDING` state. Oracle Key Vault will then begin a name resolution operation and may rename the user group to a name that is unique across the cluster. If there is a naming collision, then the collision will be reported on the Conflicts page on any node in the cluster. The user group will then be renamed to a unique name. You will need to go to a read-write node of the cluster and either accept the renamed user group or change the user group name. If you change the user group name, then this will restart the name resolution operation and the user group will return to a `PENDING` state. A user group in the `PENDING` state cannot be used to perform most operations.

6. In **Description**, optionally, enter a description for the user group.

7. Click **Save**.

Related Topics

- [Naming Conflicts and Resolution](#)
Oracle Key Vault can resolve naming conflicts that can arise as users create objects such as endpoints, endpoint groups, and user groups.

8.5.4 Adding a User to a User Group

You can add an existing user to a user group if that user must manage the same security objects as the group.

If both the user and user group are in the `ACTIVE` state, then you can add users to a group when you create the group or later after creating the groups.

1. Log in to the Oracle Key Vault management console as a user who has the Key Administrator role.
2. Select the **Users** tab, and then **Manage Access** in the left navigation bar.
The User Groups page appears displaying a list of existing user groups.
3. Click the pencil icon in the **Edit** for the user group.
The User Group Details page appears.
4. Click **Add** in the **User Group Members** pane.
The Add User Group Members page appears displaying the list of existing users who are not in the user group.
5. Check the boxes for the users you want to add.
6. Click **Save**.

8.5.5 Granting a User Group Access to a Virtual Wallet

You can modify the access level to a virtual wallet for a user group as functional needs change.

However, you can only modify the access level if the user group and wallet are in the `ACTIVE` state.

1. Log in to the Oracle Key Vault management console as a user who has the Key Administrator role.
2. Select the **Users** tab, and then **Manage Access** in the left navigation bar.
The User Groups page appears displaying a list of existing user groups.
3. Click the pencil icon in the **Edit** column, for the user group that you want to modify.
The User Group Details page appears.
4. Click **Add** in the **Access to Wallets** section.
The **Add Access to User Group** page appears.
5. Select the wallet in **Select Wallet**.
6. Set the access level to the selected wallet in **Select Access Level**.
Select **Read Only**, **Read and Modify**, or **Manage Wallet**.
7. Click **Save**.

Related Topics

- [Access Control Configuration](#)
Oracle Key Vault enables you to control access to security objects at various access levels.

8.5.6 Renaming a User Group

Depending on its status, you can change the name of a user group.

In a multi-master cluster, if the user group is in the `PENDING` state, then only the creator user can rename the user group.

1. Log in to the Oracle Key Vault management console as a user who has the Key Administrator role.
2. Select the **Users** tab, and then **Manage Access** in the left navigation bar.
The User Groups page appears.
3. On the **User Groups** page, select the pencil icon in the **Edit** column, for the user group that you want to modify.
The User Group Details page appears.
4. Enter a new name in the **Name** field.
See [Naming Guidelines for Objects](#). If this node is part of a multi-master cluster and you do not select **Make Unique**, then the user group will enter the `PENDING` state after being renamed.
5. Click **Save**.

8.5.7 Changing a User Group Description

A group description is useful for identifying the purpose of the group.

You can change this description at any time to match the purpose of the group. In a multi-master cluster, if the user group is in the `PENDING` state, then only the creator can modify the user group description.

1. Log in to the Oracle Key Vault management console as a user who has the Key Administrator role.
2. Select the **Users** tab, and then **Manage Access** in the left navigation bar.
The User Groups page appears.
3. On the **User Groups** page, select the pencil icon in the **Edit** column, for the user group that you want to modify.
The User Group Details page appears.
4. Enter a new description in the **Description** field.
5. Click **Save**.

8.5.8 Removing a User from a User Group

Depending on the circumstances, you can remove a user from a user group.

In a multi-master cluster, if both the user and the user group are in the `ACTIVE` state, then you can remove users from a user group. You may want to remove these users

when their function in the organization changes, and they no longer need to manage the same security objects as the group.

1. Log in to the Oracle Key Vault management console as a user who has the Key Administrator role.
2. Select the **Users** tab, and then **Manage Access** in the left navigation bar.
The User Groups page appears displaying a list of existing user groups.
3. Click the pencil icon in the **Edit** for the user group.
The User Group Details page appears.
4. In the User Group Members area, check the boxes for the users you want to remove.
5. Click **Remove**.
6. Click **OK** to confirm.

8.5.9 Deleting a User Group

You can delete a user group when the users in the group do not need to access the same security objects.

Removing a user group automatically deletes the group's access to wallets and security objects. In a multi-master cluster, if a user group is in the `PENDING` state, then only the creator can delete it.

1. Log in to the Oracle Key Vault management console to Oracle Key Vault as a user who has been granted the Key Administrator role.
2. Select the **Users** tab, and then **Manage Access** in the left navigation bar.
The User Groups page appears.
3. Check the boxes for the user groups that you want to delete.
4. Click **Delete**.
5. Click **OK** to confirm.

9

Managing LDAP User Authentication and Authorization in Oracle Key Vault

You can configure a connection between Oracle Key Vault and an LDAP server (currently Microsoft Active Directory) so that their users can access Oracle Key Vault.

- [About Managing LDAP User Authentication and Authorization in Oracle Key Vault](#)
You can configure Oracle Key Vault users to be centrally managed in the configured LDAP directory server.
- [Privilege Grants and Revokes for LDAP Users](#)
LDAP users have limited access to Oracle Key Vault role and privilege grants.
- [Configuring the LDAP Directory Server Connection to Oracle Key Vault](#)
Both the LDAP administrator and Oracle Key Vault administrator play a role in configuring the LDAP directory server connection to Oracle Key Vault.
- [Logins to Oracle Key Vault as an LDAP User](#)
An LDAP user who has been properly configured can log in to the Oracle Key Vault management console.
- [Managing the LDAP Configuration](#)
You can enable, validate, modify, disable, and delete the LDAP configuration.
- [Managing LDAP Groups](#)
You can modify or delete LDAP group mappings.
- [Managing Oracle Key Vault-Generated LDAP Users](#)
You cannot administer the actual LDAP user account in the LDAP directory server but you can administer the Oracle Key Vault-generated user account that is created the first time the LDAP user logs in to Oracle Key Vault.

9.1 About Managing LDAP User Authentication and Authorization in Oracle Key Vault

You can configure Oracle Key Vault users to be centrally managed in the configured LDAP directory server.

Oracle Key Vault supports only Microsoft Active Directory as an LDAP provider. This type of configuration enables you to manage authentication and authorization of Oracle Key Vault users in an LDAP directory server so that LDAP users can perform the following operations:

- Log in to the Oracle Key Vault management console and perform administrative tasks for which they are authorized.
- Run Oracle Key Vault RESTful services commands at the command line.

In a large enterprise, centrally managing users and their authorization not only brings operational efficiencies in user management but also significantly improves compliance, control, and security. For example, when terminating an employee, an LDAP administrator

can lock the user's account in the LDAP directory server to end the employee's access to various systems, including Oracle Key Vault.

By centrally managing Oracle Key Vault users in an LDAP directory server, you eliminate the need to maintain user account policies and password policies for LDAP users in each Oracle Key Vault instance. Instead, you can manage these policies centrally in the LDAP directory server.

This feature implements automatic provisioning of LDAP users in Oracle Key Vault. When an LDAP user successfully logs in to Oracle Key Vault the first time, Oracle Key Vault automatically creates an Oracle Key Vault user account for this user, based on the user account information from the LDAP directory server. You cannot modify this user account except for granting or revoking Oracle Key Vault privileges. Other changes to the user account, such as changing the user's password, must be performed to the actual account in its LDAP directory server. The automatic provisioning of users is not only beneficial for new Oracle Key Vault deployments but also when access to an existing Oracle Key Vault deployment must be granted to other employees, including provisioning of new employees.

To enable authentication and authorization of LDAP users with Oracle Key Vault, an Oracle Key Vault administrator must perform the following configuration in Oracle Key Vault:

1. Configure a connection to LDAP directory server.
2. Map one or more Oracle Key Vault administrative roles or user groups with LDAP groups.

Most of the configuration work is performed by an Oracle Key Vault administrator using the Oracle Key Vault management console.

The general process for using Oracle Key Vault in an LDAP directory server is as follows:

1. An administrator for the LDAP directory server identifies the LDAP users who need access to Oracle Key Vault, along with their authorization requirements in Oracle Key Vault. This administrator configures one or more LDAP groups, depending on the required separation of roles and duties of these users. This administrator then assigns specific users to respective LDAP groups.
2. To enable the Oracle Key Vault administrator to configure a connection to the LDAP directory server, the LDAP administrator creates an LDAP user account (called service directory user). Oracle Key Vault uses this user account to connect to the LDAP directory server and fetch the necessary information from the LDAP directory server during the user login process. The LDAP administrator provides the details of this LDAP user as well as the trust certificate of the LDAP directory server to an Oracle Key Vault administrator.
3. The Oracle Key Vault administrator uses the Oracle Key Vault management console to configure the connection between Oracle Key Vault and the LDAP directory server.
4. The Oracle Key Vault administrator then maps each LDAP group to the appropriate Oracle Key Vault user group or administrative role. These user groups must be granted the appropriate privileges that you want the LDAP user to have. The privileges of these users in Oracle Key Vault are determined based on the Oracle Key Vault administrative roles or user groups that are mapped to the user's LDAP groups. For example, if the Oracle Key Vault group has been granted the Audit Manager role, then the LDAP user will be indirectly granted the Audit Manager role.

5. The LDAP users are now able to log in to Oracle Key Vault and perform tasks for which they are authorized. After first successful login, a new user account is automatically created in Oracle Key Vault.
6. In addition to the administrative roles and privileges granted to the user through LDAP group mappings, you can directly grant privileges to LDAP user account after it has been created in Oracle Key Vault.

Authorization for an LDAP user session is a combination of the authorization granted through the LDAP groups as well as the authorization that is granted to the LDAP user locally. Authorization through LDAP groups is granted at the login time and is effective only for that session. During logon of an LDAP user, Oracle Key Vault fetches the user's LDAP groups from the directory server and determines mapped administrative roles and groups that are effective for the current user session. The set of these mapped user groups is referred to as **effective user group membership** of the LDAP user.

Note that you cannot add an LDAP user as a member of an Oracle Key Vault user group directly.

Any changes to the user's membership in the LDAP groups or to the mapping between the user's LDAP groups and Oracle Key Vault user groups or administrative roles do not affect the administrative roles and user group memberships that are currently effective for the existing user sessions. However, any changes to the privileges that have been granted to or revoked from the Oracle Key Vault user groups take effect immediately and apply to all existing sessions.

Note the following:

- You can perform the LDAP configuration with a Microsoft Active Directory version that supports the LDAP-v3 protocol.
- You can perform the LDAP configuration in a primary-standby environment. No special configuration is necessary.
- In multi-master cluster environments, the LDAP configuration is effective on all cluster nodes. You can configure node-specific configuration of LDAP directory server and hosts.
- For LDAP directory servers that support multiple domains, access to users from different domains is enabled by setting up multiple LDAP configurations, one for each domain.

9.2 Privilege Grants and Revokes for LDAP Users

LDAP users have limited access to Oracle Key Vault role and privilege grants.

Note the following restrictions with regard to LDAP users, Oracle Key Vault user groups, endpoint privileges, and wallet privileges:

- You cannot directly add an LDAP user as a member of an Oracle Key Vault user group.
- Because the endpoint privileges (Create Endpoint, Manage Endpoint, Create Endpoint Group, and Manage Endpoint Group) cannot be granted to Oracle Key Vault user groups, LDAP users cannot have access to these privileges.
- After the LDAP user is created in Oracle Key Vault, this user can be granted wallet privileges locally. However, the LDAP user cannot be directly granted endpoint or endpoint group privileges.
- Administrator roles cannot be directly granted to an LDAP user account in Oracle Key Vault. LDAP users cannot be granted endpoint privileges either directly or through an Oracle Key Vault user group.

9.3 Configuring the LDAP Directory Server Connection to Oracle Key Vault

Both the LDAP administrator and Oracle Key Vault administrator play a role in configuring the LDAP directory server connection to Oracle Key Vault.

- [Step 1: Prepare the LDAP Directory Server](#)
Before the Oracle Key Vault administrator can create a connection to an LDAP directory server, the LDAP administrator must perform preparation tasks.
- [Step 2: Create the LDAP Connection in Oracle Key Vault](#)
An Oracle Key Vault user who has the System Administrator role uses the Oracle Key Vault management console to create the LDAP connection.
- [Step 3: Map LDAP Groups to Oracle Key Vault User Groups](#)
An Oracle Key Vault user who has the Key Administrator role can map LDAP groups to Oracle Key Vault user groups or administrative roles.

9.3.1 Step 1: Prepare the LDAP Directory Server

Before the Oracle Key Vault administrator can create a connection to an LDAP directory server, the LDAP administrator must perform preparation tasks.

1. As the LDAP administrator (or a user who has the appropriate privileges), log in to the LDAP directory server.
2. Create or designate existing LDAP groups that you want to map to Oracle Key Vault.
3. Assign users to these LDAP groups.

The group will determine the privileges that its member users will have in Oracle Key Vault when the connection configuration is complete. If a user must have specific privileges that are not covered by any existing LDAP groups, then create a specific group for this user.

4. Create a service directory user account if such an account does not yet exist, and then provide this account name and its password to the Oracle Key Vault administrator.

This service directory user account will be used in the LDAP configuration that the Oracle Key Vault administrator will create. Oracle Key Vault will use this account to perform necessary LDAP actions, such as searches. If this user account changes in the future, then notify the Oracle Key Vault administrator immediately.

5. Obtain the trust certificate for the LDAP directory server and then provide this certificate to the Oracle Key Vault administrator.

This certificate will be used in the LDAP configuration that the Oracle Key Vault administrator will create.

9.3.2 Step 2: Create the LDAP Connection in Oracle Key Vault

An Oracle Key Vault user who has the System Administrator role uses the Oracle Key Vault management console to create the LDAP connection.

1. Log in to the Oracle Key Vault management console as a user who has the System Administrator role.
2. Select the **System** tab, then **Settings** from the left navigation bar.
3. In Network Services, click **LDAP** to display the Manage LDAP Configuration page.
4. Click **Add** to display the Add LDAP Configuration page.
5. Enter the following settings:
 - **Configuration Name:** Enter a name for the LDAP configuration. The maximum character length is 120 bytes.
 - **Directory Type:** Ensure that Microsoft Active Directory is selected from this list.
 - **Service Directory User Name:** Enter the service directory user account that the LDAP administrator provided. You can enter this name using any of the following formats:
 - **NetBIOS Domain Name\Account Name:** For example, `global\johndoe`
 - **User principal name:** For example, `johndoe@example.com`
 - **Service Directory User Password:** Enter the password that the LDAP administrator provided with the service directory user account. If the password changes in the LDAP directory server, you must update it in Oracle Key Vault.
 - **Hostname:** Enter either a host name or an IP address for the Microsoft Active Directory domain controller (server) that will service the client requests.
 - **LDAPS Port:** Enter the port number. 636, the default, is the standard port number for LDAP connections for Secure Sockets Layer (SSL) connections.
 - **Trusted Certificate:** Either paste the contents of the server trust certificate of the LDAP directory server that the LDAP administrator provided, or upload the certificate as a file.
 - **Domain Name:** This setting is auto-populated when you complete the preceding settings and click the **Get Domain Name** button. This is the name of the Microsoft Active Directory domain of which the specified host (domain controller) is a member. You cannot change this setting.
 - **Search Base DN:** This setting is auto-populated when you complete the preceding settings and click the **Get Domain Name** button. It represents a distinguished name of the search base object, which defines the location in the directory from which the LDAP search begins. This setting is useful for environments where the number of users and groups in a directory is very large, and if the users and groups that are relevant for managing Oracle Key Vault access are placed under this directory container. Setting the base DN to this directory container can help to improve performance for user and group searches. Optionally, modify this search base.
 - **Defunct LDAP Users Grace Period (in days):** Enter the duration in days after which the users deleted in LDAP directory server are automatically deleted from Oracle Key Vault. This value also defines the duration after which the users whose LDAP configuration no longer exists are deleted from Oracle Key Vault automatically. The default is 15 days.
6. Click **Test Connection** to ensure that the connection works.
7. Click **Add** to complete the configuration.

The Manage LDAP Configuration page appears, with the new configuration listed under LDAP Configuration Name.

Related Topics

- [Step 3: Map LDAP Groups to Oracle Key Vault User Groups](#)
An Oracle Key Vault user who has the Key Administrator role can map LDAP groups to Oracle Key Vault user groups or administrative roles.

9.3.3 Step 3: Map LDAP Groups to Oracle Key Vault User Groups

An Oracle Key Vault user who has the Key Administrator role can map LDAP groups to Oracle Key Vault user groups or administrative roles.

1. Log in to the Oracle Key Vault management console as a user who has the Key Administrator role.
2. Configure the Oracle Key Vault user groups that you want to map to the LDAP groups.

Ensure that these groups have the appropriate Oracle Key Vault privileges, and that you understand how privilege grants and revokes work for LDAP users.

3. Select the **Users** tab, and then **Manage LDAP Mappings** from the left navigation bar .
4. Click **Create** to display the Create LDAP Group Mapping page.
5. Enter the following settings:

- **Domain:** From the list, select the domain that is associated with the LDAP directory server configuration for which you want to define the mapping.

- **LDAP Group:** From the list, select the LDAP group.

- **Roles:** Optionally, grant the **Key Administrator** role to the LDAP group. (Remember that you cannot grant a role that is different from the role you currently have.)

If you want to grant the user the System Administrator or Audit Manager role, then a user who has the Key Administrator role first must create an LDAP group mapping (with or without any user group). After the LDAP group mapping is created, a user with the System Administrator or Audit Manager role then can edit the existing LDAP group mapping to map it with the corresponding administrative role.

- Under User Groups, select the Oracle Key Vault user groups that you want to map to the LDAP group.
You can find information about a user group by clicking its **Details** button.

6. Click **Create**.

The LDAP Access Mappings page appears, where the new mapping is included in the list.

7. Define more LDAP group mappings as necessary.

At this stage, the configuration is complete and LDAP users can log in to Oracle Key Vault.

Related Topics

- [Privilege Grants and Revokes for LDAP Users](#)
LDAP users have limited access to Oracle Key Vault role and privilege grants.

9.4 Logins to Oracle Key Vault as an LDAP User

An LDAP user who has been properly configured can log in to the Oracle Key Vault management console.

- [About Logins to Oracle Key Vault as an LDAP User](#)
After the LDAP directory server configuration with Oracle Key Vault is complete, LDAP users can log in to Oracle Key Vault if they have valid authorization.
- [Logging in to Oracle Key Vault as an LDAP User](#)
An LDAP user who is a member of an LDAP group that has been mapped to an Oracle Key Vault user group or administrative role can log in to the Oracle Key Vault management console.

9.4.1 About Logins to Oracle Key Vault as an LDAP User

After the LDAP directory server configuration with Oracle Key Vault is complete, LDAP users can log in to Oracle Key Vault if they have valid authorization.

The login is successful if:

- The user provides the correct LDAP credential.
- The user's LDAP groups from the LDAP directory server map to at least one of the Oracle Key Vault user groups or administrative roles.

At the login time, user's authorization is determined based on the LDAP groups of which this user is a member. The user is granted administrative roles or privileges of the user groups that are mapped to user's LDAP groups. When a user successfully logs into Oracle Key Vault for the first time, a new user account is automatically created in Oracle Key Vault. (Ensure that you understand how privilege grants and revokes work for LDAP users.)

In a multi-master cluster environment, an LDAP user can log in to any node in the cluster. The first time that the LDAP user logs in to a node, a single Oracle Key Vault-generated user account is created for this user. This account will apply to all nodes in the cluster.

Valid LDAP users can execute Oracle Key Vault RESTful services commands. *Oracle Key Vault RESTful Services Administrator's Guide* describes how to use the RESTful services.

Related Topics

- [Privilege Grants and Revokes for LDAP Users](#)
LDAP users have limited access to Oracle Key Vault role and privilege grants.

9.4.2 Logging in to Oracle Key Vault as an LDAP User

An LDAP user who is a member of an LDAP group that has been mapped to an Oracle Key Vault user group or administrative role can log in to the Oracle Key Vault management console.

1. Open a web browser.
2. Connect using an HTTPS connection and the IP address of Oracle Key Vault.

For example, to log in to a server whose IP address is 192.0.2.254, enter:

```
https://192.0.2.254
```

3. After the login screen appears, enter the following credentials:
 - **Domain:** From the list, select the domain of the LDAP user.
 - **User Name:** Enter your user name using one of the following formats:
 - **NetBIOS Domain Name\Account Name:** For example, `global\johndoe`. For convenience, when a user specifies the user name in the NetBIOS Domain Name or User Principal Name format (described next), the domain name in the drop-down list is automatically selected based on the pattern matching of the NetBIOS domain name or the domain name of the user principal name with the names of the configured domains. You can select the domain manually, as needed. The domain name Local is not an Active Directory domain. The use of the domain Local indicates that the user account was created locally.
 - **User principal name:** For example, `johndoe@example.com`
 - **Login name:** For example, `johndoe`. This name must match the `sAMAccountName` attribute of the LDAP user account.
 - **Password:** Enter your password.
4. Click **Login**.

LDAP users who have the appropriate Oracle Key Vault authorization can also execute the Oracle Key Vault RESTful services commands.

Related Topics

- [About Managing LDAP Users](#)
The LDAP user account in Oracle Key Vault is an automatically created account that is based on the LDAP user account in the configured LDAP directory server.
- *Oracle Key Vault RESTful Services Administrator's Guide*

9.5 Managing the LDAP Configuration

You can enable, validate, modify, disable, and delete the LDAP configuration.

- [Enabling an LDAP Configuration](#)
A user who has the System Administrator role can enable an LDAP configuration.
- [Modifying an LDAP Configuration](#)
A user who has the System Administrator role can modify an LDAP configuration.
- [Testing an LDAP Configuration](#)
A user who has the System Administrator role can test an LDAP configuration.
- [Disabling an LDAP Configuration](#)
A user who has the System Administrator role can disable an LDAP configuration.
- [Deleting an LDAP Configuration](#)
A user who has the System Administrator role can delete an LDAP configuration.

9.5.1 Enabling an LDAP Configuration

A user who has the System Administrator role can enable an LDAP configuration.

An LDAP configuration is effective only when it has been enabled. By default, after an LDAP configuration is created, it is enabled. In a multi-master cluster environment, the

enablement of an LDAP configuration apply to all nodes in the cluster and can be performed in any node.

1. Log in to the Oracle Key Vault management console as a user who has the System Administrator role.
2. Select the **System** tab, then **Settings** from the left navigation bar.
3. In Network Services, click **LDAP** to display the Manage LDAP Configuration page.
4. Select the check box for the LDAP configuration and then click the **Enable** button.
5. In the confirmation window, click **OK**.

9.5.2 Modifying an LDAP Configuration

A user who has the System Administrator role can modify an LDAP configuration.

In a multi-master cluster environment, changes to an LDAP configuration apply to all nodes in the cluster and can be performed in any node. However, be aware that a node-specific host configuration takes precedence over cluster-wide host configuration.

1. Log in to the Oracle Key Vault management console as a user who has the System Administrator role.
2. Select the **System** tab, then **Settings** from the left navigation bar.
3. In Network Services, click **LDAP** to display the Manage LDAP Configuration page.
4. Select the LDAP configuration name to display the Edit LDAP Configuration page.
5. Modify the following settings as necessary:
 - **Configuration Name:** Update the name of the configuration.
 - **Service Directory User Name:** Update the service directory user name.
 - **Service Directory User Password:** Update the service directory user's password.
 - **Trusted Certificate:** Either paste the contents of the server trust certificate of the LDAP directory server that the LDAP administrator provided, or upload the certificate as a file.
 - **Search Base DN:** Update the base DN that is used for searching users and groups
 - **Defunct LDAP Users Grace Period (in days):** Enter a new grace period value. The default is 15.
 - Under Servers, do the following:
 - To add a new server, click **Add** and then provide the **Hostname**, **Port**, and **Service Directory User Password**. To test the connection, click **Test Server**. Then click **Add**. You can only select a server that is in the same domain as the current server.
 - To remove a server, select its check box and then click **Delete**.
6. Click **Test Connection(s)** to ensure that the new configuration settings work.
7. Click **Save**.

9.5.3 Testing an LDAP Configuration

A user who has the System Administrator role can test an LDAP configuration.

In a multi-master cluster environment, you can test the LDAP configuration from any node in the cluster. The test connection validates the connection to LDAP hosts that are effective for the current cluster node. If node-specific LDAP hosts are configured, then the connection to those hosts is validated.

1. Log in to the Oracle Key Vault management console as a user who has the System Administrator role.
2. Select the **System** tab, then **Settings** from the left navigation bar.
3. In Network Services, click **LDAP** to display the Manage LDAP Configuration page.
4. Select the LDAP configuration name to display the Edit LDAP Configuration page.
5. Click **Test Connection(s)**.

9.5.4 Disabling an LDAP Configuration

A user who has the System Administrator role can disable an LDAP configuration.

Disabling an LDAP configuration effectively makes the configuration unavailable for use. Users from the disabled LDAP configuration are denied access when they try to log in into Oracle Key Vault. However, disabling an LDAP configuration does not affect users who are currently logged in using the configuration. In a multi-master cluster environment, the disablement of an LDAP configuration applies to all nodes in the cluster and can be performed in any node.

1. Log in to the Oracle Key Vault management console as a user who has the System Administrator role.
2. Select the **System** tab, then **Settings** from the left navigation bar.
3. In Network Services, click **LDAP** to display the Manage LDAP Configuration page.
4. Select the check boxes for the configurations to disable, and then click **Disable**.
5. In the confirmation window, click **OK**.

9.5.5 Deleting an LDAP Configuration

A user who has the System Administrator role can delete an LDAP configuration.

In a multi-master cluster environment, the deletion of an LDAP configuration applies to all nodes in the cluster and can be performed from any node. However, deleting an LDAP configuration does not log out users who are currently logged in using the configuration.

1. Log in to the Oracle Key Vault management console as a user who has the System Administrator role.
2. Select the **System** tab, then **Settings** from the left navigation bar.
3. In Network Services, click **LDAP** to display the Manage LDAP Configuration page.
4. Select the check boxes for the LDAP configurations that you want to delete and then click one of the following buttons:

- Click **Delete** if there are no mappings defined in Oracle Key Vault for any LDAP groups associated with the LDAP configuration.
 - Click **Force Delete** if there are group mappings defined for this LDAP configuration. You must have both the System Administrator and Key Administrator role to perform this operation. Otherwise, first delete all LDAP group mappings defined for the LDAP configuration before a user with the System Administrator role deletes the LDAP configuration.
5. In the confirmation window, select **OK**.

When you delete an LDAP configuration, the associated LDAP user accounts are not deleted immediately. Oracle Key Vault deletes these accounts after number of days that were specified in the **Defunct LDAP Users Grace Period** setting in the Edit LDAP Configuration page have passed. You can delete an LDAP user account any time. If you recreate the identical LDAP configuration before associated LDAP user accounts are deleted, then Oracle Key Vault will make these user accounts valid again.

9.6 Managing LDAP Groups

You can modify or delete LDAP group mappings.

- [About Managing LDAP Groups](#)
The LDAP group can be mapped to Oracle Key Vault administrator roles and one or more user groups.
- [Creating an LDAP Group Mapping](#)
After you have created an LDAP connection, you can create one or more LDAP group mappings.
- [Modifying an LDAP Group Mapping](#)
You can modify the mappings for an LDAP group after you have configured the LDAP connection.
- [Validating LDAP Group Mappings](#)
In the event that LDAP groups change in the LDAP directory server, a user who has the Key Administrator role can validate their mappings in Oracle Key Vault.
- [Deleting LDAP Group Mappings](#)
A user who has the Key Administrator role can delete one or more LDAP groups and associated mappings from Oracle Key Vault.

9.6.1 About Managing LDAP Groups

The LDAP group can be mapped to Oracle Key Vault administrator roles and one or more user groups.

A user with the Oracle Key Vault administrator role can modify an LDAP group's mapping with the Oracle Key Vault administrator roles or user groups depending upon the type of administrator role the user has. This user, however, cannot modify an LDAP group in the LDAP directory server. If an LDAP group mapping changes, then the authorization of the users who are members of the LDAP group changes as well.

Local Oracle Key Vault users cannot be members of an LDAP group.

9.6.2 Creating an LDAP Group Mapping

After you have created an LDAP connection, you can create one or more LDAP group mappings.

You can map LDAP groups to one or more Oracle Key Vault administrative roles and user groups.

1. Log in to the Oracle Key Vault management console as a user who has the Key Administrator role.
2. Select the **Users** tab, then **Manage LDAP Mappings** from the left navigation bar.
3. In the LDAP Group Mappings page, click **Create**.

The Create LDAP Group Mapping page appears.

4. Enter the following settings:
 - **Domain:** From the list, select the domain that is registered with Oracle Key Vault.
 - **LDAP Group:** Select from the following choices:
 - **Fetch All Groups** provides a listing of all available groups that you can add. Select the group from the menu following this label. If the number of LDAP groups exceeds the number of objects that can be returned in a single search result, then an error is returned. Narrow down your LDAP group search by using either the **Filter by CN (Common Name)** or **Specify DN (Distinguished Name)** options.
 - **Filter by CN (Common Name)** enables you to select from a filtered list by CN. In the field that appears when you select this choice, enter the CN prefix, and in the list following it, select as needed. For example, to search for all the LDAP groups that start with the common name **Admin**, enter **Admin**. If the number of LDAP groups that match the **Filter by CN (Common Name)** criteria exceeds the number of objects that can be returned in a single search result, then an error is returned. Narrow down your LDAP group search by further refining the **Filter by CN (Common Name)** search or use the **Specify DN (Distinguished Name)** option.
 - **Specify DN (Distinguished Name)** enables you to select from a filtered list by DN. In the field that appears when you select this choice, enter the complete DN for the group, and in the list following it, select as needed.
5. Under Roles, select one or more Oracle Key Vault roles to map to the LDAP group.
 - **Audit Manager**
 - **Key Administrator:**
 - **System Administrator**

A user with the Key Administrator role can create, modify, or delete an LDAP group mapping between an LDAP group and the Oracle Key Vault administrative roles and/or user groups. However, the Key Administrator user may not be able to map the other administrative roles, Audit Manager and System Administrator, if your site follows strict separation-of-duty guidelines. In such a case, the Key Administrator user will not have the other two roles, and hence cannot map an LDAP group to them. Only the users who are granted a specific role can grant this

role to LDAP users through the LDAP group mapping. Users with Audit Manager and System Administrator roles cannot create a new LDAP group mapping but they can modify an existing LDAP group mapping to map administrative roles that they have to an LDAP group.

6. Optionally, select a user group from the User Groups area to associate with the LDAP group.
7. Click **Create**.

After the LDAP group mapping is created, mapped role and user group assignments take effect when an LDAP group member user logs into Oracle Key Vault. Changes in the LDAP group mapping do not affect the authorization granted to the users in their existing sessions.

9.6.3 Modifying an LDAP Group Mapping

You can modify the mappings for an LDAP group after you have configured the LDAP connection.

1. Log in to the Oracle Key Vault management console as a user who has the role that is required for the privileges that must be granted to the LDAP users.

A user with the Key Administrator role can modify all of the mapping information. Users who have the System Administrator or Audit Manager role can see the basic information and only modify role assignments for the group, depending on what their own role is. For example, a System Administrator can grant or revoke only the System Administrator role.

2. Select the **Users** tab, then **Manage LDAP Mappings** from the left navigation bar.
3. Under LDAP Group Mappings, find the LDAP group whose privileges you want to change.
4. Select the **Edit** button for this LDAP group to display.
5. Under Roles, select from the available roles.
 - **Audit Manager**
 - **Key Administrator**
 - **System Administrator**

You cannot grant endpoint privileges to LDAP users.

6. Under User Groups, select from the available Oracle Key Vault user groups to associate with this LDAP group.
7. To remove an Oracle Key Vault user group from the mapping, select it from the User Groups Mapped list and then click **Remove User Groups**.
8. Optionally, select the **Details** button of the Oracle Key Vault group to modify the user group's settings and privileges.
9. Click **Save**.

Oracle Key Vault determines the LDAP user's authorization for the current session only at the login time. During the login process, Oracle Key Vault fetches the user's LDAP groups from the LDAP directory server and then determines the mapped Oracle Key Vault administrative roles and user groups for the current session. Any changes to the user's membership in the LDAP groups or changes to the mapping between the user's LDAP groups and Oracle Key Vault user groups or administrative roles do not affect user's authorization for existing

sessions. Note, however, that any changes to the privileges that are granted to the Oracle Key Vault user groups take effect immediately and apply to all existing sessions.

9.6.4 Validating LDAP Group Mappings

In the event that LDAP groups change in the LDAP directory server, a user who has the Key Administrator role can validate their mappings in Oracle Key Vault.

In a multi-master cluster environment, the validation of an LDAP group mapping applies to all nodes in the cluster and can be performed in any node.

1. Log in to the Oracle Key Vault management console as a user who has the Key Administrator role.
2. Select the **Users** tab, then **Manage LDAP Mappings** from the left navigation bar.
3. Under LDAP Group Mappings, select the check boxes for the group mappings that you want to validate.
4. Select the **Validate** button.
5. In the confirmation window, click **OK**.

9.6.5 Deleting LDAP Group Mappings

A user who has the Key Administrator role can delete one or more LDAP groups and associated mappings from Oracle Key Vault.

In a multi-master cluster environment, the LDAP group mapping deletion applies to all nodes in the cluster and can be performed in any node.

1. Log in to the Oracle Key Vault management console as a user who has the Key Administrator role.
2. Select the **Users** tab, then **Manage LDAP Mappings** from the left navigation bar.
3. In the LDAP Group Mappings page, select the check boxes for the LDAP groups that you want to delete.
4. Click **Delete**.
5. In the confirmation window, click **OK**.

9.7 Managing Oracle Key Vault-Generated LDAP Users

You cannot administer the actual LDAP user account in the LDAP directory server but you can administer the Oracle Key Vault-generated user account that is created the first time the LDAP user logs in to Oracle Key Vault.

- [About Managing LDAP Users](#)
The LDAP user account in Oracle Key Vault is an automatically created account that is based on the LDAP user account in the configured LDAP directory server.
- [Finding Information About an Oracle Key Vault-Generated LDAP User](#)
You can find information about the Oracle Key Vault-generated LDAP user accounts.

- [Validation of Oracle Key Vault-Generated LDAP Users](#)
You can find if an LDAP user account that is associated with the Oracle Key Vault-generated LDAP user account is a valid account.
- [Modifying an Oracle Key Vault-Generated LDAP User Account Wallet Privileges](#)
Users who have either the Key Administrator role or regular users who have privileges to manage wallets can modify the wallet privileges of Oracle Key Vault-generated LDAP user account.
- [Deleting Oracle Key Vault-Generated LDAP Users](#)
A user who has the System Administrator role can delete an LDAP user account from Oracle Key Vault.

9.7.1 About Managing LDAP Users

The LDAP user account in Oracle Key Vault is an automatically created account that is based on the LDAP user account in the configured LDAP directory server.

Oracle Key Vault creates this account the first time that the LDAP user logs in to Oracle Key Vault, capturing the first name, last name, and email attributes of the user. These values cannot be changed in Oracle Key Vault; they can only be changed in their LDAP directory server corresponding account by a privileged LDAP administrator. If these values change, then Oracle Key Vault updates the user account with these values the next time the LDAP user logs in to Oracle Key Vault. Except for granting and revoking wallet privileges to and from this user from Oracle Key Vault, the Oracle Key Vault administrator cannot make any changes to this account.

In a multi-master cluster environment, there is no need for user name conflict resolution because the uniqueness of the account is guaranteed by the LDAP directory server where the LDAP user account exists. If the LDAP user logs in to different nodes in the cluster, then an identical user account is created, and this account is uniform across the cluster. Each of these account creations is timestamped. The Oracle Key Vault synchronization process keeps the most recent account creation timestamp value (that is, from the node where this user was created last). Hence, throughout the cluster environment, the timestamp value is the same as the most recent user account creation timestamp.

9.7.2 Finding Information About an Oracle Key Vault-Generated LDAP User

You can find information about the Oracle Key Vault-generated LDAP user accounts.

You cannot change the LDAP user account in Oracle Key Vault; instead you must modify the account in the LDAP directory server where the user account exists. If you want to move the user to a different LDAP group, you must do this in the LDAP directory server.

1. Log in to the Oracle Key Vault management console as a user who has the System Administrator, Key Administrator, or Audit Manager role.
2. Select the **Users** tab, and then **Manage Users** from the left navigation bar.
3. In the Manage Users page, scroll down to the Manage LDAP Users section.

You can find the following information:

- The user's distinguished name (DN)
- The user's full name
- The name of the LDAP configuration

- The domain name for the user account
- Oracle Key Vault roles to which the user has been granted through the LDAP group
- Mapped groups for the user
- The effective membership of an LDAP user in Oracle Key Vault user groups
- The user's access to wallets

9.7.3 Validation of Oracle Key Vault-Generated LDAP Users

You can find if an LDAP user account that is associated with the Oracle Key Vault-generated LDAP user account is a valid account.

- [About the Validation of Oracle Key Vault-Generated LDAP Users](#)
An Oracle Key Vault-generated user account still exists in Oracle Key Vault if the LDAP user account has been deleted in the source LDAP directory server.
- [Validating Oracle Key Vault-Generated LDAP Users](#)
A user who has the System Administrator role can manually validate Oracle Key Vault-Generated LDAP users.

9.7.3.1 About the Validation of Oracle Key Vault-Generated LDAP Users

An Oracle Key Vault-generated user account still exists in Oracle Key Vault if the LDAP user account has been deleted in the source LDAP directory server.

A user who has the System Administrator role can find if the Oracle Key Vault-generated user account still exists in the source LDAP directory server by validating it in Oracle Key Vault. In a multi-master cluster environment, the validation of an Oracle Key Vault-Generated LDAP user account applies to all nodes in the cluster.

Oracle Key Vault periodically checks the validity of the LDAP user accounts and marks them as `NOT FOUND` if the following events take place:

- The LDAP user account does not exist in the LDAP directory server.
- The LDAP configuration that is associated with the LDAP user account is deleted.

Oracle Key Vault automatically deletes invalid LDAP user accounts after the number of days configured in the **Defunct LDAP Users Grace Period** setting (in the Edit LDAP Configuration page) have passed. You can delete an LDAP user account from Oracle Key Vault any time.

9.7.3.2 Validating Oracle Key Vault-Generated LDAP Users

A user who has the System Administrator role can manually validate Oracle Key Vault-Generated LDAP users.

1. Log in to the Oracle Key Vault management console as a user who has the System Administrator role.
2. Select the **Users** tab, then **Manage Users** from the left navigation bar.
3. In the Manage Users page, scroll down to the Manage LDAP Users section.
4. Select the check box of the LDAP users that you want to validate.
5. Click **Validate**.

If an LDAP account is not valid, then a `NOT FOUND` message appears.

9.7.4 Modifying an Oracle Key Vault-Generated LDAP User Account Wallet Privileges

Users who have either the Key Administrator role or regular users who have privileges to manage wallets can modify the wallet privileges of Oracle Key Vault-generated LDAP user account.

- [About Modifying an Oracle Key Vault-Generated LDAP User Account Wallet Privileges](#)
The wallet privileges that you can change are Read Only, Read and Modify, or Manage Wallet.
- [Modifying an Oracle Key Vault-Generated LDAP User Account Wallet Privileges \(Key Administrators\)](#)
A user who has the Key Administrator role can grant and revoke wallet privileges for any wallet to LDAP users in Oracle Key Vault.
- [Modifying an Oracle Key Vault-Generated LDAP User Account Wallet Privileges \(Regular Users\)](#)
A regular user who has privileges to manage wallets can grant and revoke privileges for these wallets to LDAP users in Oracle Key Vault.

9.7.4.1 About Modifying an Oracle Key Vault-Generated LDAP User Account Wallet Privileges

The wallet privileges that you can change are Read Only, Read and Modify, or Manage Wallet.

You cannot change the corresponding LDAP account in the LDAP directory, but you can change the wallet privileges of the Oracle Key Vault-generated LDAP user account. Changes to the privileges granted directly to the LDAP user account in Oracle Key Vault are applied immediately, even to the existing sessions of the same user. If the LDAP user account is modified on the LDAP server (such as a change in LDAP group membership of the user), then the changes take effect from the next user login. In a multi-master cluster environment, changes to an LDAP user apply to all nodes in the cluster and can be performed in any node.

9.7.4.2 Modifying an Oracle Key Vault-Generated LDAP User Account Wallet Privileges (Key Administrators)

A user who has the Key Administrator role can grant and revoke wallet privileges for any wallet to LDAP users in Oracle Key Vault.

1. Log in to the Oracle Key Vault management console as a user who has the Key Administrator role.
2. Select the **Users** tab, then **Manage Users** from the left navigation bar.
3. Under Manage Users, scroll down to the Manage LDAP Users section.
4. Select the name of the LDAP user account to display the LDAP User Details page.
5. In the Access to Wallets pane, do the following:
 - a. Click **Add** to display the Add Access to User page.

- b. Under Select Wallet, select the wallets to which you want to grant privileges to the LDAP user.
- c. Under Select Access Level, select **Read Only**, **Read and Modify**, or **Manage Wallet**.
- d. Click **Save**.

The wallet privilege is added as a direct privilege for this user, as opposed to a wallet privilege that is available through an LDAP group. If the user already has a wallet privilege from the LDAP group to which they are assigned, then the user has a union of the privileges from both the direct privilege grant and the LDAP group privilege grant.

6. Click **Save**.

9.7.4.3 Modifying an Oracle Key Vault-Generated LDAP User Account Wallet Privileges (Regular Users)

A regular user who has privileges to manage wallets can grant and revoke privileges for these wallets to LDAP users in Oracle Key Vault.

1. Log in to the Oracle Key Vault management console as a user who has privileges to manage wallets.
2. Select the **Keys & Wallets** tab, and then **Wallets** from the left navigation bar.
The Wallets page lists the wallets for which this user has privileges.
3. Select the **Edit** icon for the wallet whose privileges you want to modify.
The Wallet Access Settings area lists all the users who have privileges for this wallet.
4. In the Wallet Access Settings area, click **Add**.
5. In the Add Access to Wallets page, under Select Endpoint/User Group, select **Users** from the **Type** menu.
6. Select the check boxes for the user to whom you want to grant privileges.
7. In the Select Access Level area, select **Read Only**, **Read and Modify**, or **Manage Wallet**.
8. Click **Save**.

The wallet privilege is added as a direct privilege for this user, as opposed to a wallet privilege that is available through an LDAP group. If the user already has a wallet privilege from the LDAP group to which they are assigned, then the user has a union of the privileges from both the direct privilege grant and the LDAP group privilege grant.

9.7.5 Deleting Oracle Key Vault-Generated LDAP Users

A user who has the System Administrator role can delete an LDAP user account from Oracle Key Vault.

If an LDAP user account is deleted from the LDAP directory server, during a periodic check, Oracle Key Vault automatically first marks such user accounts as invalid (**NOT FOUND**) and then deletes these accounts after the **Defunct LDAP Users Grace Period** setting (on the Edit LDAP Configuration page) passes.

If you inadvertently delete an Oracle Key Vault-generated LDAP user account, then the next time the user logs in, the account is recreated. However, the user would no longer own any objects that they created before the deletion. In a multi-master cluster environment, the removal of an Oracle Key Vault-Generated LDAP user account applies to all nodes in the cluster and can be performed in any node.

1. Log in to the Oracle Key Vault management console as a user who has the System Administrator role.
 2. Select the **Users** tab, then **Manage Users** from the left navigation bar.
 3. In the Manage Users page, scroll down to the Manage LDAP Users section.
 4. Select the check box of the LDAP users that you want to remove.
 5. Click **Delete**.
 6. In the confirmation window, click **OK**.
- The user account is deleted immediately.

10

Managing Oracle Key Vault Virtual Wallets and Security Objects

You can create a virtual wallet to store security objects, and then share this wallet with trusted peers at different access levels.

- [Managing Virtual Wallets](#)
A virtual wallet is a container for security objects that you can create and then grant access to users.
- [Managing Access to Virtual Wallets from Keys & Wallets Tab](#)
You can grant virtual wallet access to and revoke virtual wallet access from endpoint by using the **Keys & Wallets** tab.
- [Managing Access to Virtual Wallets from User's Menu](#)
To manage access control on virtual wallets for users, endpoints, and their respective groups, you can use the **Users** menu or **Endpoints** menu.
- [Managing the State of a Key or a Security Object](#)
You can set the date to activate or deactivate keys or security objects, and change the state of some virtual wallet security objects.
- [Managing Details of Security Objects](#)
You can manage details about security objects, such as find details about these objects and modifying these details.

10.1 Managing Virtual Wallets

A virtual wallet is a container for security objects that you can create and then grant access to users.

- [About Virtual Wallets](#)
A virtual wallet is a container for security objects.
- [Creating a Virtual Wallet](#)
You can create a virtual wallet and add security objects to it at the same time.
- [Modifying a Virtual Wallet](#)
You can modify a virtual wallet and add security objects to it at the same time.
- [Adding Security Objects to a Virtual Wallet](#)
You can add new security objects to a virtual wallet at any time as needed.
- [Removing Security Objects from a Virtual Wallet](#)
You cannot remove security objects from virtual wallets at any time as needed.
- [Deleting a Virtual Wallet](#)
Deleting a virtual wallet removes the wallet as a container, but does not delete the security objects that were contained in it.

10.1.1 About Virtual Wallets

A virtual wallet is a container for security objects.

These security objects can be public and private encryption keys, including Transparent Data Encryption (TDE) keystores, Oracle wallets, Java keystores, certificates, secret data, and credential files. You can use a virtual wallet to group security objects for sharing with multiple users who need them to access encrypted data.

Any user can create a virtual wallet. After you create a virtual wallet, you can add keys and other security objects to the wallet. You can then grant other users, endpoints, user groups, and endpoint groups access to the virtual wallet at various levels of access. You can modify a virtual wallet and its wallet contents at any time. You can also modify virtual wallet user lists and their respective access level.

Other than the Key Administrator, access to the virtual wallet must be granted explicitly to users. Read, modify, and manage wallet permissions are required to add and remove objects from the wallet, and to grant or modify wallet access to other users and groups.

10.1.2 Creating a Virtual Wallet

You can create a virtual wallet and add security objects to it at the same time.

However, you can also create an empty virtual wallet, and add security objects to it later. You can modify access mappings on a virtual wallet at any time.

1. Log in to the Oracle Key Vault management console as a user with the Key Administrator role.
2. Select the **Keys & Wallets** tab, then **Wallets** in the left navigation bar.
3. In the Wallets page, click **Create**.

The Create Wallet page appears.

Create Wallet Cancel Save

Name Make Unique

Description

Add Wallet Contents

<input type="checkbox"/>	Display Name	Type	State	Creation Time	Endpoint	Width
<input type="checkbox"/>	Default template for EXPENSE_DB_RAC_INST1	Template	No State	09-NOV-2020 15:59:34	EXPENSE_DB_RAC_INST1	↑
<input type="checkbox"/>	Default template for ACME_UNITED_MODE	Template	No State	09-NOV-2020 16:03:34	ACME_UNITED_MODE	
<input type="checkbox"/>	Default template for LONDON_ENCRYPTED_FILE_SYSTEM	Template	No State	09-NOV-2020 16:07:14	LONDON_ENCRYPTED_FILE_SYSTEM	
<input type="checkbox"/>	TDE Master Encryption Key: MKID AZ5IL9vybE/uvzeldWC7nfAAAAA	Symmetric Key	Active	09-NOV-2020 16:07:14	XYZAPP_WEBAPP_MYSQL	

4. Enter a name for the wallet in the **Name** field and an identifying description in **Description**.

See [Naming Guidelines for Objects](#).

5. If you are using a multi-master cluster, then choose whether to select the **Make Unique** check box.

Make Unique helps to control naming conflicts with virtual wallet names across the multi-master cluster environment. Virtual wallets that were created before an Oracle Key Vault conversion to a cluster node are not affected by naming conflicts.

- If you select **Make Unique**, then the virtual wallet will be active immediately and this wallet can be used in operations.
 - If you do not select **Make Unique**, then the wallet will be created in the `PENDING` state. Oracle Key Vault will then begin a name resolution operation and may rename the wallet to a name that is unique across the cluster. If there is a naming collision, then the collision will be reported on the Conflicts page on any node in the cluster. The wallet will then be renamed to a unique name. You will need to go to a read-write node of the cluster and either accept the renamed wallet name or change the wallet name. If you change the wallet name, then this will restart the name resolution operation and the wallet will return to a `PENDING` state. A wallet in the `PENDING` state cannot be used to perform most operations.
6. In the Add Wallet Contents pane, check the boxes by the names of the listed security objects that you want to add to the wallet.

The Add Wallet Contents pane lists the security objects you have Read and Modify access to. If the list is empty, then you have no access to the security objects already in Oracle Key Vault. In this case, you would add security objects to the wallet after you upload them to Oracle Key Vault.

You can modify the columns in the table in the Wallet Contents pane to show more information. From the **Actions** menu, select **Select Columns**. In the Select Columns

dialog box, move the columns that you want to see to the Display in Report list, and then click **Apply**.

7. Click **Save** to create the new wallet with any associated security objects.

A **Wallet created successfully** message appears. The **Wallets** page appears and displays the new wallet in the list.

To see the contents in the wallet click the wallet name as the following figure shows.

The screenshot displays the Oracle Key Vault interface for managing virtual wallets. It includes a search bar, a 'Go' button, and an 'Actions' dropdown menu. The main table lists three wallets, each with a checkbox, name, status, description, creation time, creator, and node. Below the table are two panels: 'Wallet Contents' and 'Access Settings', both with search bars and 'Go' buttons. 'Wallet Contents' shows a table with columns for Display Name, Type, and Details. 'Access Settings' shows a table with columns for Subject Name and Access.

Wallet Name	Name Status	Description	Creation Time	Created By	Creator Node	Edit
<input type="checkbox"/> Cloud_App_Wallet	ACTIVE	This wallet contains the SSH private keys, public keys of the entities being managed on Oracle public cloud	09-NOV-2020 15:56:03	OKVADMIN	nodet	
<input type="checkbox"/> Peoplesoft_DB_Connect_Client_Wallet	ACTIVE	This wallet contains the passwords of DB users who login to Oracle DB.	09-NOV-2020 15:55:36	OKVADMIN	nodet	
<input type="checkbox"/> Data_Recovery_Manager_Wallet	ACTIVE	This wallet contains the SEPS (Secure External Password Store) wallet containing various client user credentials.	09-NOV-2020 15:55:09	OKVADMIN	nodet	

Display Name	Type	Details
Secret Data: Name Password_Name-Mon Nov 9 19:28:59 2020	Secret Data	61292193-9E26-4F8E-BF68-450FD3E6530C
Default template for PEOPLESOFT_DB_CONNECT_CLIENT	Template	7597DB9F-2BBB-455C-B978-D37278210780

Subject Name	Access
PEOPLESOFT_DB_CONNECT_CLIENT	Read, Write, Manage Wallet
KEY_ADMIN_USER_GROUP	Read
ALL_ADMIN_USER_GROUP	Read

Related Topics

- [Name Conflict Resolution in a Multi-Master Cluster](#)
Naming conflicts can arise when an object has the same name as another object in a different node.

10.1.3 Modifying a Virtual Wallet

You can modify a virtual wallet and add security objects to it at the same time.

1. Log in to the Oracle Key Vault management console as a user with the Key Administrator role.
2. Select the **Keys & Wallets** tab, then **Wallets** in the left navigation bar.
3. In the Wallets page, click the **Edit** button for the wallet that you want to modify.
4. In the Wallet Overview pane, enter a new name for the wallet in the **Name** field and an identifying description in **Description**.

See [Naming Guidelines for Objects](#).

5. If you are using a multi-master cluster, then choose whether to select the **Make Unique** check box.

Make Unique helps to control naming conflicts with virtual wallet names across the multi-master cluster environment. Virtual wallets that were created before an Oracle Key Vault conversion to a cluster node are not affected by naming conflicts.

- If you select **Make Unique**, then the virtual wallet will be active immediately and this wallet can be used in operations.
 - If you do not select **Make Unique**, then the wallet will be created in the `PENDING` state. Oracle Key Vault will then begin a name resolution operation and may rename the wallet to a name that is unique across the cluster. If there is a naming collision, then the collision will be reported on the Conflicts page on any node in the cluster. The wallet will then be renamed to a unique name. You will need to go to a read-write node of the cluster and either accept the renamed wallet name or change the wallet name. If you change the wallet name, then this will restart the name resolution operation and the wallet will return to a `PENDING` state. A wallet in the `PENDING` state cannot be used to perform most operations.
6. To modify endpoint access settings, in the Wallet Access Settings pane, click **Add** to add new endpoints or click **Remove** to remove existing endpoints.
 7. In the Wallet Contents pane, check the boxes by the names of the listed security objects that you want to remove from the wallet.

The Wallet Contents pane lists the security objects you have added to the wallet. If the list is empty, then you have no access to the security objects already in Oracle Key Vault. In this case, you would add security objects to the wallet after you upload them to Oracle Key Vault.

You can modify the columns in the table in the Wallet Contents pane to show more information. From the **Actions** menu, select **Select Columns**. In the Select Columns dialog box, move the columns that you want to see to the Display in Report list, and then click **Apply**.

Select **Add Objects** or **Remove Objects**.

8. Click **Save** to create the new wallet with any associated security objects.
9. To view the status of the modified wallet, click **Wallets** in the left navigation bar.

The Wallets page appears and displays the modified wallet in the list, with the status of `PENDING`.

Related Topics

- [Name Conflict Resolution in a Multi-Master Cluster](#)
Naming conflicts can arise when an object has the same name as another object in a different node.

10.1.4 Adding Security Objects to a Virtual Wallet

You can add new security objects to a virtual wallet at any time as needed.

In a multi-master cluster, you cannot add [security objects](#) to a virtual wallet when it is in the `PENDING` state.

1. Log in to the Oracle Key Vault management console as a user who has the **Manage Wallet** access on the virtual wallet or as a user with the Key Administrator role.
2. Select the **Keys & Wallets** tab, then **Wallets** in the left navigation bar.
3. In the Wallets page, click the pencil icon in the **Edit** column corresponding to the wallet you want to work with.

The Wallet Overview page appears. The Wallet Contents pane lists the security objects already in the wallet.

4. In the Wallet Contents page, click **Add Objects** to display the Add Wallet Contents pane.

The Add Wallet Contents page lists the security objects you have **Read and Modify** access to. If the list is empty, then you have no access to the security objects already in Oracle Key Vault. In this case, you would add security objects to the wallet after you upload them to Oracle Key Vault.

You can modify the columns in the table in the Add Wallet Contents page to show more information. From the **Actions** menu, select **Select Columns**. In the Select Columns dialog box, move the columns that you want to see to the Display in Report list, and then click **Apply**.

5. Check the boxes by the security objects that you want to add to the wallet.
6. Click **Save**.

A confirmation message appears, then the **Wallet Overview** page appears. **Wallet Contents** lists the new security objects added.

10.1.5 Removing Security Objects from a Virtual Wallet

You cannot remove security objects from virtual wallets at any time as needed.

In a multi-master cluster, you can remove security objects from a virtual wallet when it is in the `PENDING` state.

1. Log in to the Oracle Key Vault management console as a user who has the **Manage Wallet** access on the virtual wallet or as a user with the Key Administrator role.
2. Select the **Keys & Wallets** tab, then **Wallets** in the left navigation bar.
3. In the Wallets pane, click the pencil icon in the **Edit** column corresponding to the wallet that you want to work with.

The Wallet Overview page appears. The Wallet Contents pane lists the security objects already in the wallet.

4. Check the boxes by the security objects you want to remove from the wallet.
5. Click **Remove Objects**.

The Wallet Contents pane in the Wallet Overview page displays the revised list.

6. Click **OK** to confirm.

10.1.6 Deleting a Virtual Wallet

Deleting a virtual wallet removes the wallet as a container, but does not delete the security objects that were contained in it.

These security objects will continue to remain in Oracle Key Vault. Endpoints that have downloaded this virtual wallet will continue to retain their local copy. In a multi-master cluster, you cannot delete a virtual wallet when it is in the `PENDING` state.

1. Log in to the Oracle Key Vault management console as a user who has the Manage Wallet access on the virtual wallet, or as a user with the Key Administrator role.

2. Select the **Keys & Wallets** tab, then **Wallets** in the left navigation bar.
3. In the Wallets page, check the boxes next to the name of the wallet that you want to delete.
You can delete more than one virtual wallet at the same time.
4. Click **Delete**.
5. Click **OK** to confirm.

10.2 Managing Access to Virtual Wallets from Keys & Wallets Tab

You can grant virtual wallet access to and revoke virtual wallet access from endpoint by using the **Keys & Wallets** tab.

- [About Managing Access to Virtual Wallets from the Keys & Wallets Tab](#)
Access control is deciding which users and endpoints share virtual wallets and security objects, and what operations they can perform on those virtual wallets.
- [Granting Access to Users, User Groups, Endpoints, and Endpoint Groups](#)
You can grant the **Read Only**, **Read and Modify**, and **Manage Wallet** access levels to users, user groups, endpoints, and endpoint groups.
- [Modifying Access to Users, User Groups, Endpoints, and Endpoint Groups](#)
You can modify access settings on a virtual wallet for users, user groups, endpoints, and endpoint groups from the **Keys & Wallets** tab.

10.2.1 About Managing Access to Virtual Wallets from the Keys & Wallets Tab

Access control is deciding which users and endpoints share virtual wallets and security objects, and what operations they can perform on those virtual wallets.

You must have Manage Wallet access to a virtual wallet or be a Key Administrator to manage access control for users, endpoints, and their respective groups.

To manage access to virtual wallets, you can use the **Keys & Wallets** tab, where you select the wallet, you grant an endpoint, endpoint group, user, or user group access to the wallet.

Related Topics

- [Managing Access to Virtual Wallets from User's Menu](#)
To manage access control on virtual wallets for users, endpoints, and their respective groups, you can use the **Users** menu or **Endpoints** menu.

10.2.2 Granting Access to Users, User Groups, Endpoints, and Endpoint Groups

You can grant the **Read Only**, **Read and Modify**, and **Manage Wallet** access levels to users, user groups, endpoints, and endpoint groups.

After they have access to the wallet, they will have access to all the [security objects](#) in the wallet. In a multi-master cluster, you cannot grant access to endpoints, endpoint groups, users, or user groups while the virtual wallet is in the `PENDING` state.

1. Log in to the Oracle Key Vault management console as a user who has the **Manage Wallet** access on the virtual wallet, or as a user with the Key Administrator role.
2. Select the **Keys & Wallets** tab, then **Wallets** in the left navigation bar.
3. In the Wallets pane, click the pencil icon in the **Edit** column corresponding to the wallet to which you want to grant access.

The Wallet Overview page appears.

4. In the Wallet Access Settings pane, click **Add**.

The Add Access to Wallet page appears.

5. In the Add Access to Wallet page, under Select Endpoint/User Group, from the **Type** menu, select the entity type you want to grant access.

Possible values for **Type** are **Endpoint Groups**, **Endpoints**, **User Groups**, and **Users**.

The type you select determines the list that is displayed. For example, if you select **Endpoint Groups** as the **Type**, the list of Oracle Key Vault endpoint groups is displayed under the heading **Endpoint Groups**. If you select **Users**, the list of Oracle Key Vault users are displayed under the heading **Users**.

6. Select the check box in the **Name** table corresponding to the entity you want to grant access.

7. In the Select Access Level pane, select one of the following access levels: in the **Select Access Level** pane.
 - **Read Only** or **Read and Modify**
 - **Manage Wallet**
8. Click **Save**.

The Wallet Access Settings pane displays the new entity.

10.2.3 Modifying Access to Users, User Groups, Endpoints, and Endpoint Groups

You can modify access settings on a virtual wallet for users, user groups, endpoints, and endpoint groups from the **Keys & Wallets** tab.

In a multi-master cluster, you cannot modify access to endpoints, endpoint groups, users, or user groups while the virtual wallet is in the `PENDING` state.

1. Log in to the Oracle Key Vault management console as a user who has the Manage Wallet permission on the virtual wallet or as a user with the Key Administrator role.
2. Select the **Keys & Wallets** tab, then **Wallets** in the left navigation bar.
3. In the Wallets pane, click the pencil icon in the **Edit** column corresponding to the wallet name.

The Wallet Overview page appears, with Wallet Access Settings listing the entities that have access to the wallet and their access levels.

4. In Wallet Access Settings, click the pencil icon corresponding to the entity under **Subject Name**.

A Modify Access window appears. Wallet Access Settings lists all the entities that have access to this wallet under Subject Name, and can include users, endpoints, user groups, and endpoint groups.

5. Select the access settings that you want to modify, then click **Save**.

A message appears: **Successfully updated**. The Wallet Overview page appears and Wallet Access Settings displays the new access mapping for the entity.

6. Click **Save** in the Wallet Overview page.

10.3 Managing Access to Virtual Wallets from User's Menu

To manage access control on virtual wallets for users, endpoints, and their respective groups, you can use the **Users** menu or **Endpoints** menu.

- [Granting a User Access to a Virtual Wallet](#)
You can grant access to a virtual wallet by using the **Users** tab.
- [Revoking User Access from a Virtual Wallet](#)
You can revoke access to a virtual wallet for a user by using the **Users** tab.
- [Granting a User Group Access to a Virtual Wallet](#)
You can grant user group access to a virtual wallet by using the **Users** tab.
- [Revoking User Group Access from a Virtual Wallet](#)
You can remove user group access to a virtual wallet by using the **Users** tab.

Related Topics

- [Managing Endpoint Access to a Virtual Wallet](#)
You can grant an endpoint access to a virtual wallet, and revoke or modify access when it is no longer necessary.
- [Managing Access to Virtual Wallets from Keys & Wallets Tab](#)
You can grant virtual wallet access to and revoke virtual wallet access from endpoint by using the **Keys & Wallets** tab.

10.3.1 Granting a User Access to a Virtual Wallet

You can grant access to a virtual wallet by using the **Users** tab.

In a multi-master cluster, you cannot grant a user access to a virtual wallet while the virtual wallet is in the `PENDING` state.

1. Log in to the Oracle Key Vault management console as a user who has the Manage Wallet permission on the virtual wallet, or as a user with the Key Administrator role.
2. Select the **Users** tab, then **Manage Users** in the left navigation bar.
3. In the Manage Users pane, click the user's name in the **User Name** column.
4. In the Access to Wallets pane, click **Add**.
The Add Access to User page appears.
5. Select a virtual wallet from the available list.
6. In the Select Access Level pane select the desired access levels.
7. Click **Save**.

A message appears: **Access mapping successfully added**. You can check **Access to Wallets** in User Details for the user to see the wallet added.

Related Topics

- Access Control Options

10.3.2 Revoking User Access from a Virtual Wallet

You can revoke access to a virtual wallet for a user by using the **Users** tab.

In a multi-master cluster, you cannot revoke user access from a virtual wallet while the virtual wallet is in the `PENDING` state.

1. Log in to the Oracle Key Vault management console as a user who has the Manage Wallet access on the virtual wallet, or as a user with the Key Administrator role.
2. Select the **Users** tab, then **Manage Users** in the left navigation bar.
3. In the Manage Users pane, click the user's name under the **User Name** column.
4. In the Access to Wallets pane, check the box by the virtual wallet that you want to revoke access to.
5. Click **Remove**.
6. In the confirmation window, click **OK**.

A message appears: **Access Mapping(s) deleted successfully**. You can check **Access to Wallets** in User Details for the user to see the wallet deleted.

10.3.3 Granting a User Group Access to a Virtual Wallet

You can grant user group access to a virtual wallet by using the **Users** tab.

When you grant a user group access to a virtual wallet all members of the group will have access to the security objects within the wallet. In a multi-master cluster, you cannot grant a user group access to a virtual wallet while the virtual wallet is in the `PENDING` state.

1. Log in to the Oracle Key Vault management console as a user who has the Key Administrator role.
2. Select the **Users** tab, then **Manage Access** in the left navigation bar.
3. Click the pencil icon in the **Edit** column corresponding to the user group.
4. In the Access to Wallets pane, click **Add**.

The Add Access to User Group page appears.

5. In the Select Wallet pane, select the check boxes for one or more wallets.
6. In the Select Access Level pane, select the desired access levels.
7. Click **Save**.

A message appears: **Access mapping successfully added**. You can check **Access to Wallets** in User Groups for the user to see the wallet added.

10.3.4 Revoking User Group Access from a Virtual Wallet

You can remove user group access to a virtual wallet by using the **Users** tab.

In a multi-master cluster environment, you cannot revoke user group access from a virtual wallet while the virtual wallet is in the `PENDING` state.

1. Log in to the Oracle Key Vault management console as a user who has the Key Administrator role.
2. Select the **Users** tab, and then select **Manage Access** in the left sidebar.
The **User Groups** page appears.
3. Click the pencil icon in the **Edit** column corresponding to the user group.
The **User Group Details** page appears.
4. In the **Access to Wallets** pane, check the box by the virtual wallet you want to revoke access to.
5. Click **Remove**.
6. Click **OK** to confirm.

A message appears: **Access Mapping(s) deleted successfully**. You can check **Access to Wallets** in **User Groups** to see the wallet removed from the list.

10.4 Managing the State of a Key or a Security Object

You can set the date to activate or deactivate keys or security objects, and change the state of some virtual wallet security objects.

- [About Managing the State of a Key or a Security Object](#)
You can control the dates when a key or a security object is active, that is, when it can be used.
- [How a Multi-Master Cluster Affects Keys and Security Objects](#)
Keys that you create on one node of a multi-master cluster will take some time to appear on other nodes in the cluster.
- [Activating a Key or Security Object](#)
Keys can be in the **Active** or **Pre-Active** state.
- [Deactivating a Key or Security Object](#)
A key deactivates or expires when it passes the date that has been set for deactivation.
- [Revoking a Key or Security Object](#)
When you revoke a key, you can set its state to **Deactivated** or **Compromised**.
- [Destroying a Key or Security Object](#)
When a key is no longer used or compromised in some way, then you can destroy it.

10.4.1 About Managing the State of a Key or a Security Object

You can control the dates when a key or a security object is active, that is, when it can be used.

You also can revoke and destroy keys and security objects. Be aware that a multi-master cluster affects the activation or de-activation times of keys and security objects on different nodes, and that naming conflicts can arise.

Related Topics

- [How a Multi-Master Cluster Affects Keys and Security Objects](#)
Keys that you create on one node of a multi-master cluster will take some time to appear on other nodes in the cluster.

10.4.2 How a Multi-Master Cluster Affects Keys and Security Objects

Keys that you create on one node of a multi-master cluster will take some time to appear on other nodes in the cluster.

The time is defined by the replication lag between nodes. The replication lag value is displayed on the Cluster Link State pane of the Monitoring page, which can be accessed by choosing the **Cluster** tab.

If you add a Transparent Data Encryption (TDE) master encryption key to two different keystores on two different nodes, then it will be shown in both keystores.

Adjusting the activation date, deactivation date, process start date, and protect stop date has restrictions. For these dates, if changes are made to the [security object](#) very close to the current time, then state changes can happen because of replication lag.

As with the creation of any object in a multi-master cluster, a security object can have a name conflict with an object created on a different node. If there is a conflict, then Oracle Key Vault will suggest a unique name or allow you to rename it.

Related Topics

- [Naming Conflicts and Resolution](#)
Oracle Key Vault can resolve naming conflicts that can arise as users create objects such as endpoints, endpoint groups, and user groups.

10.4.3 Activating a Key or Security Object

Keys can be in the **Active** or **Pre-Active** state.

Most keys are in the **Active** state when they are created. However, for a key that will be used for securing data later than its creation date, you can set the **Process Start Date**. Currently, only keys uploaded with a third-party KMIP client can be in a **Pre-Active** state and have the **Date of Activation** field set. For all other keys, the **Date of Activation** date is system generated and cannot be set.

1. Log in to the Oracle Key Vault management console as a user who has read and modify access on this key.
2. Select the **Keys & Wallets** tab, then **Keys & Secrets** in the left navigation bar.
3. In the Keys & Secrets page, click the edit pencil icon under **Edit** corresponding to the item for which you want to set.
4. On the Object Details page for the item, click **Activate**.
5. Click **OK** to confirm.

10.4.4 Deactivating a Key or Security Object

A key deactivates or expires when it passes the date that has been set for deactivation.

1. Log in to the Oracle Key Vault management console as a user who has read and modify access on this key.
2. Select the **Keys & Wallets** tab, then **Keys & Secrets** in the left navigation bar.
3. In the Keys & Secrets page, click the edit pencil icon under **Edit** corresponding to the item to be deactivated.
4. In the Object Details page for the item, set the **Date of Deactivation** to the date by which you want the key to be deactivated.
5. Click **Save**.

10.4.5 Revoking a Key or Security Object

When you revoke a key, you can set its state to **Deactivated** or **Compromised**.

At this point, the key should no longer be used to encrypt new data. However, you can download and use the deactivated keys to decrypt old data.

1. Log in to the Oracle Key Vault management console as a user who has read and modify access on this key.
2. Select the **Keys & Wallets** tab, then **Keys & Secrets** in the left navigation bar.
3. In the Keys & Secrets page, click the edit pencil icon under **Edit** corresponding to the item that you want to revoke.
4. In the Object Details page, click **Revoke**.

5. In the Revoke Object page, from the **Revocation Reason** drop-down list, select a reason for the revocation.
6. Optionally, add more details in **Revocation Message**
7. Click **Save**.

10.4.6 Destroying a Key or Security Object

When a key is no longer used or compromised in some way, then you can destroy it.

Metadata for destroyed keys and [security objects](#) are kept in Oracle Key Vault even after they have been destroyed.

1. Log in to the Oracle Key Vault management console as a user who has read and modify access on this key.
2. Select the **Keys & Wallets** tab, then **Keys & Secrets** in the left navigation bar.
3. In the Keys & Secrets page, click the edit pencil icon under **Edit** corresponding to the item that you want to destroy.
4. On the Object Details page, click **Destroy**.
5. In the confirmation window, click **OK**.

10.5 Managing Details of Security Objects

You can manage details about security objects, such as find details about these objects and modifying these details.

- [About Managing the Details of Security Objects](#)
You can search for security objects within a virtual wallet, and add, modify, or remove these security objects.
- [Searching for Security Object Items](#)
You can search for individual security objects if you have privileges to view these objects.
- [Viewing the Details of a Security Object](#)
An administrative user with the Key Administrator role can view, add, and modify the details of a security object.
- [Adding or Modifying Details of a Security Object](#)
Only users who have the appropriate privileges can add or modify the details of a security object.

10.5.1 About Managing the Details of Security Objects

You can search for security objects within a virtual wallet, and add, modify, or remove these security objects.

Security objects are managed by Oracle Key Vault administrative users with a clear separation of duties. You must be an administrative user with the Key Administrator role to manage wallet privilege on the virtual wallet containing the security objects. A user with the Audit Manager role can view security objects, but cannot modify them, whereas individual security objects are not even viewable to a user with the System Administrator role.

You can set the deactivation date for security objects and have an alert notify you when the security object will expire. For example, if you configure an alert for an object expiration with a threshold of 7 days, its expiration alert will be raised when object's deactivation date is within the 7 days of its deactivation date. An email notification will be sent every 24 hours during this threshold period. The alert is raised only when the security object is in the `PRE-ACTIVE` or `ACTIVE` state. Oracle Key Vault deletes the expiration alerts for the security objects when the security object is revoked or destroyed.

Related Topics

- [About Configuring Alerts](#)

System administrators can configure alerts from the Oracle Key Vault dashboard, but all users can see alerts for the security objects to which they have access.

10.5.2 Searching for Security Object Items

You can search for individual security objects if you have privileges to view these objects.

1. Log in to the Oracle Key Vault management console as a user with the Key Administrator role, an Audit Manager role, or as a user with access to a virtual wallet.
2. Select the **Keys & Wallets** tab, then **Keys & Secrets** in the left navigation bar.

The Keys & Secrets page appears displaying all the security objects in a table.

<input type="checkbox"/>	Display Name	Type	Wallet Membership	Creating Endpoint	State
<input type="checkbox"/>	Default template for PEOPLESOFT_DB_CONNECT_CLIENT	Template	Peoplesoft_DB_Connect_Client_Walk	PEOPLESOFT_DB_CONNECT_CLIENT	No State
<input type="checkbox"/>	GoldenGate Master Key Name: OGG_MASTER_KEY_NAME, Version: 201	Symmetric Key		PRIMARY_OGG	Pre-Active
<input type="checkbox"/>	Default template for EXPENSE_DB_RAC_INST1	Template	HR_Application_Wallet	EXPENSE_DB_RAC_INST1	No State
<input type="checkbox"/>	Default template for WEBAPP_MYSQL	Template	WebApp_Wallet	WEBAPP_MYSQL	No State
<input type="checkbox"/>	Default template for ENCRYPTED_FILE_SYSTEM	Template	ASM_Cluster_File_System_Wallet	ENCRYPTED_FILE_SYSTEM	No State

By default, the table has the following columns for each security object:

- **Display Name** lists the name of the object.
- **Type:** Indicates the object type of security object. Valid values are **Symmetric Key**, **Public Key**, **Private Key**, **Template**, **Opaque Object**, **Certificate**, and **Secret Data**.
- **Wallet Membership:** The virtual wallet that contains the security object.
- **Creating Endpoint:** The endpoint that owns the security object.
- **State:** Indicates the state of the object. Valid values are **Active**, **Compromised**, **Deactivated**, **Destroyed**, **Destroyed Compromised**, and **Pre-Active**.
- **Creation Date:** Date and time that the security object was added to Oracle Key Vault.

- **Deactivation Date:** Date and time that the security object was deactivated.
- **Name:** Actual name of the object.
- **Unique Identifier:** A globally unique ID that identifies an item.
- **Edit:** A pencil icon links to the Object Details page for the security object.

You can modify these columns to show more information. From the **Actions** menu, select **Select Columns**. In the Select Columns window, move the columns that you want to see to the Display in Report list, and then click **Apply**.

3. If the security object does not appear, then search for it using the Search bar or the **Actions** menu.

Related Topics

-

10.5.3 Viewing the Details of a Security Object

An administrative user with the Key Administrator role can view, add, and modify the details of a security object.

The administrative user can perform these actions on the security object from its corresponding Object Details page. Object details are attributes of a specific security object and depend on the type of security object.

1. Log in to the Oracle Key Vault management console as a user with the Key Administrator role or as a user with access to the virtual wallet.
2. Select the **Keys & Wallets** tab, then **Keys & Secrets** in the left navigation bar.
3. In the Keys & Secrets page, search for the security object that you want.

The Keys & Secrets page shows a table that displays the security objects in Key Vault.

You can modify the columns in this table to show more information. From the **Actions** menu, select **Select Columns**. In the Select Columns dialog box, move the columns that you want to see to the Display in Report list, and then click **Apply**.

4. Click the pencil icon in the **Edit** column corresponding to the security object.

The Object Details page appears displaying the attributes of the security object. The following screen shows a partial view of all the activities that you can perform on this object.

Object Details

Display Name TDE Master Encryption Key: MKID Aa7JQ/p5I09zv5RKoticuG0AAAAAAAAAAAA
Unique Identifier 008512D5-9A5B-5339-B602-2DB5E48B5F22
Type Symmetric Key
State Active
Creator XYZAPP_WEBAPP_MYSQL
Last Modified 09-NOV-2020 19:00:07
Date of Creation 09-NOV-2020 19:00:07
Date of Activation 09-NOV-2020 19:00:07
Process Start Date
Protect Stop Date
Date of Deactivation

Wallet Membership

	Wallet Name	Description	Creation Time
<input type="checkbox"/>	XYZ_MYSQL_WALLET	This wallet contains the MySQL DB Symmetric keys for the management of XYZ Application.	09-NOV-2020 15:53:37

You can set the dates when the security object should be deactivated or not used on the Object Details page. The attributes shown in Object Details depend on the type of security object. The attributes for a **Symmetric Key** are different from those of **Private Key** or **Opaque Object**.

You can revoke or destroy a security object, and add or remove it to and from a wallet from the Object Details page.

The Wallet Membership pane in the Object Details page enables you to add the security object to a wallet or delete the security object from a wallet.

The Object Details page contains the following attributes:

- **Display Name:** A summary description to help identify the item to the user. For example, if the item is a TDE master encryption key, then the **Identifier** shows the prefix TDE master encryption key followed by the identifier used by the database to identify the key.
- **Unique Identifier:** This is a globally unique ID that identifies an item.
- **Type:** Indicates the object type of the item. Valid values are **Symmetric Key**, **Public Key**, **Private Key**, **Template**, **Opaque Object**, **Certificate**, and **Secret Data**.
- **State:** Indicates the status of the security objects. Values are as follows:
 - **Pre-active:** The object exists but is not yet usable for any cryptographic purpose.
 - **Active:** The object is available for use. Endpoints should examine the Cryptographic Usage Mask attribute to determine which uses are appropriate for this object.
 - **Deactivated:** The object is no longer active and should not be used to apply cryptographic protection (for example, encryption or signing). It may still be appropriate to use for decrypting or verifying previously protected data.
 - **Compromised:** The object is believed to be compromised and should not be used.

- **Destroyed:** The object is no longer usable for any purpose.
 - **Destroyed Compromised:** The object was compromised and destroyed. It is no longer usable for any purpose.
 - **Creator:** The endpoint that created the security object.
 - **Last Modified:** The date last modified.
 - **Date of Creation:** The date created.
 - **Date of Activation:** The date of activation.
 - **Process Start Date:** The date when the key may start to be used to encrypt data. It can be equal or later than the **Date of Activation** setting but cannot precede it.
 - **Protect Stop Date:** When this date is passed, the key should not be used to encrypt any more data. It cannot be later than the **Date of Deactivation** setting.
 - **Date of Deactivation:** The date of deactivation.
5. Click **Advanced** to view the cryptographic attributes of the security object. The following screen shows a partial view of all the activities that you can perform in Advanced.

Advanced

Cryptographic Algorithm: AES

Cryptographic Length: 256

Retrieved at least once: No

Key Usage:

Decrypt Derive Key

Encrypt Export

Generate Cryptogram Translate Decrypt

Translate Encrypt Translate Unwrap

Translate Wrap Unwrap Key

Validate Cryptogram Wrap Key

Contact Information:

Names Add Name Delete

<input type="checkbox"/>	Name	Type	Edit
<input type="checkbox"/>	ORACLE.SECURITY.DB.ENCRYPTION.Aa7JQ/p5i09zv5RKOTicuG0AAAAAAAAAAAAAAAAAAAAAAAAAAAA	Text String	
<input type="checkbox"/>	ORACLE.TDE.HSM.MK.06AEC943FA79234F73BF944A3AD89CB86D	Text String	
<input type="checkbox"/>	ORACLE.TDE.HSM.MK.Aa7JQ/p5i09zv5RKOTicuG0AAAAAAAAAAAA	Text String	

Attribute information and queries will vary depending on the item type. Examples of attributes are as follows:

- **Cryptographic Algorithms:** The encryption algorithm used by the item
- **Key Usage:** Operations that the key can be used for. Clients may or may not use these attributes. For example, Transparent Data Encryption does not consult the key usage attributes.
- **Names:** Labels attached by a user or endpoint to identify the key
- **Custom Attributes:** Additional attributes defined by the endpoint and not interpreted by Oracle Key Vault

- **Cryptographic Parameters:** Optional parameters for the encryption algorithm used by the item, such as block cipher mode and padding method
- **Cryptographic Length:** The length in bits of the key
- **Retrieved at Least Once:** Indicates if the object has been served to the client
- **Contact Information:** Used for contact purposes only
- **Digests:** Digest values of the security object
- **Link Details:** Links to related objects

Related Topics

- [Key Management Interoperability Protocol Specification Version 1.1](#)

10.5.4 Adding or Modifying Details of a Security Object

Only users who have the appropriate privileges can add or modify the details of a security object.

To modify the attributes of a [security object](#) you must be a user with the Key Administrator role, or you must have **Read and Modify** access on the security object. You can get **Read and Modify** access on a security object if you own the security object or if you have access to a virtual wallet that contains the security object.

1. Log in to the Oracle Key Vault management console as a user with the Key Administrator role or as a user with access to a virtual wallet.
2. Select the **Keys & Wallets** tab, then **Keys & Secrets** in the left navigation bar.
The Keys & Secrets page shows a table listing all the security objects in a table. You can modify the columns in this table to show more information. From the **Actions** menu, select **Select Columns**. In the Select Columns dialog box, move the columns that you want to see to the Display in Report list, and then click **Apply**.
3. Click the pencil icon corresponding to the security object.
The Object Details page appears.
4. In the Advanced pane, make the necessary changes.
5. Click **Save** in the top right corner of the pane.

11

Managing Oracle Key Vault Master Encryption Keys

Managing security objects includes uploading and downloading security objects, managing the persistent master encryption key cache, and using user-defined TDE keys.

- [Using the Persistent Master Encryption Key Cache](#)
The persistent master encryption key cache feature enables databases to be operational when the Oracle Key Vault server is unavailable.
- [Configuring an Oracle Key Vault to New TDE-Enabled Database Connection](#)
You can configure a connection between Oracle Key Vault and a database that has not yet been configured for Transparent Data Encryption.
- [Migrating Existing TDE Wallets to Oracle Key Vault](#)
A migrated TDE wallet can be used to restore database contents that were previously encrypted by TDE.
- [Uploading and Downloading Oracle Wallets](#)
To store and share Oracle wallets, you must upload them to Oracle Key Vault.
- [Uploading and Downloading JKS and JCEKS Keystores](#)
The `okvutil upload` and `okvutil download` commands can upload and download JKS and JCEKS keystores.
- [Using a User-Defined Key as the TDE Master Encryption Key](#)
You can import a generated key to be used as the Transparent Data Encryption (TDE) master encryption key in Oracle Key Vault.

11.1 Using the Persistent Master Encryption Key Cache

The persistent master encryption key cache feature enables databases to be operational when the Oracle Key Vault server is unavailable.

- [About the Persistent Master Encryption Key Cache](#)
The persistent master encryption key cache ensures the availability of TDE master encryption keys.
- [About Oracle Key Vault Persistent Master Encryption Key Cache Architecture](#)
The Oracle Key Vault persistent master encryption key cache is implemented in Oracle Key Vault's PKCS#11 library.
- [Caching Master Encryption Keys in the In-Memory and Persistent Master Encryption Key Cache](#)
After a master encryption key is created or fetched from a different location, it is stored in an Oracle Key Vault cache.
- [Storage Location of Persistent Master Encryption Key Cache](#)
The persistent master encryption key cache is created in the same location as the configuration file `okvclient.ora`.

- [Persistent Master Encryption Key Cache Modes of Operation](#)
The persistent master encryption key cache operates in two modes.
- [Persistent Master Encryption Key Cache Refresh Window](#)
The persistent master encryption key cache refresh window helps to extend the availability of the master encryption key.
- [Persistent Master Encryption Key Cache Parameters](#)
Oracle Key Vault provides parameters to configure the persistent master encryption key cache.
- [Listing the Contents of the Persistent Master Key Cache](#)
The `okvutil list` command can be used to list the master encryption keys that are cached in the persistent master encryption key cache.
- [Oracle Database Deployments and Persistent Master Encryption Key Cache](#)
The persistent master encryption key cache affects the integration of other Oracle features with Oracle Key Vault.

11.1.1 About the Persistent Master Encryption Key Cache

The persistent master encryption key cache ensures the availability of TDE master encryption keys.

It accomplishes this by reducing dependence on the state of the Oracle Key Vault server.

The TDE master encryption key is cached in the persistent master encryption key cache in addition to the in-memory cache, to make the master encryption key available across database processes. It eliminates the need for databases to contact the Oracle Key Vault server for every new process, redo log switch, or database startup operation.

The following are the benefits of ensuring availability of TDE master encryption keys:

- Continuous operation of endpoints during upgrade, primary-standby configuration, switchover, failover, and other procedures that require an Oracle Key Vault restart operation
- Less load on the Oracle Key Vault server when multiple sessions of a single database request the same master encryption key
- Improved scalability of Oracle Key Vault

11.1.2 About Oracle Key Vault Persistent Master Encryption Key Cache Architecture

The Oracle Key Vault persistent master encryption key cache is implemented in Oracle Key Vault's `PKCS#11` library.

When the persistent master encryption key cache feature is configured, the Oracle Key Vault `PKCS#11` library will create the persistent master encryption key cache when the first master encryption key is retrieved from Oracle Key Vault.

The persistent master encryption key cache is an auto-login wallet or a password-based wallet, depending on how Oracle Key Vault is installed:

- If the Oracle Key Vault client is installed with a password specified, then the persistent master encryption key cache is a password-based wallet.

- If the Oracle Key Vault client is installed without a password specified, then the persistent master encryption key cache is an auto-login wallet.

The `PKCS#11` library also implements an in-memory master encryption key cache. When the in-memory master encryption key cache feature is configured, the master encryption key is cached in the process memory of the process that loaded the library into memory. The in-memory and persistent master encryption key caches are independent of each other. You can enable and disable these caches independently.

For operations that involve encryption and decryption, `PKCS#11` attempts to look up the master encryption key in the in-memory master encryption key cache. If it does not find it, `PKCS#11` then it looks up the master encryption key in the persistent master encryption key cache. If the master encryption key is not found in the in-memory or the persistent master encryption key cache, then it is retrieved from the Oracle Key Vault server, if the server is online.

Related Topics

- [Step 3: Install the Oracle Key Vault Software onto the Endpoint](#)
To upgrade to the latest endpoint software for an enrolled endpoint, you can download the endpoint software without having to reenroll the endpoint.

11.1.3 Caching Master Encryption Keys in the In-Memory and Persistent Master Encryption Key Cache

After a master encryption key is created or fetched from a different location, it is stored in an Oracle Key Vault cache.

When the master encryption key is first fetched from the Oracle Key Vault server, or created in the Oracle Key Vault server, the master encryption key is stored in the in-memory master encryption key cache and in the persistent master encryption key cache.

Master encryption keys stored in the in-memory master encryption key cache are available for a limited time from the moment the key is placed into the persistent cache. The duration is defined by the `PKCS11_CACHE_TIMEOUT` parameter in the `okvclient.ora` file.

If the persistent cache exists, then it will be used. If the persistent cache does not exist, then Oracle Key Vault creates it. When the key is created, all future sessions will retrieve it from the in-memory master encryption key cache or persistent master encryption key cache.

Persistent master encryption keys that are stored in the persistent master encryption key cache are available for a limited time from the moment the key is placed into the persistent cache. You can define this time by setting the `PKCS11_PERSISTENT_CACHE_TIMEOUT` parameter in the `okvclient.ora` file.

When the endpoint deletes the master encryption key, the key will be removed from the in-memory master encryption key cache and persistent master encryption key cache.

11.1.4 Storage Location of Persistent Master Encryption Key Cache

The persistent master encryption key cache is created in the same location as the configuration file `okvclient.ora`.

The default location for the `okvclient.ora` file is the directory `$OKV_HOME/conf`.

It is important that the `ORACLE_HOME`, `ORACLE_BASE`, and `OKV_HOME` environment variables are consistently set across the deployment. If they are not consistent, then operations requiring the persistent cache may fail, and the persistent cache may be created in multiple locations.

If the environment variable `OKV_HOME` is set, then the persistent cache is created in `$OKV_HOME/conf`.

If `OKV_HOME` is not set, but `ORACLE_BASE` is set, then the persistent cache is created in `$ORACLE_BASE/okv/$ORACLE_SID`.

If neither `OKV_HOME` nor `ORACLE_BASE` is set, but `ORACLE_HOME` is set, then the persistent cache is created in `$ORACLE_HOME/okv/$ORACLE_SID`.

 **Note:**

Ensure that the directory in which the persistent cache is created is secure and has restricted permissions.

11.1.5 Persistent Master Encryption Key Cache Modes of Operation

The persistent master encryption key cache operates in two modes.

The difference between the two modes is the order in which the persistent master encryption key cache and Oracle Key Vault are looked up to retrieve the master encryption key.

- **Oracle Key Vault First Mode**
In Oracle Key Vault first mode, the endpoints attempt to retrieve the master encryption key from the Oracle Key Vault server.
- **Persistent Master Encryption Key Cache First Mode**
In persistent master encryption key cache first mode, the endpoints retrieve the master encryption key from the persistent master encryption key cache.

11.1.5.1 Oracle Key Vault First Mode

In Oracle Key Vault first mode, the endpoints attempt to retrieve the master encryption key from the Oracle Key Vault server.

If the Oracle Key Vault server is offline, then the endpoints attempt to retrieve the master encryption key from the persistent master encryption key cache.

The endpoints must determine the status of the Oracle Key Vault server, and if it is offline, then the endpoints attempt to retrieve the master encryption key from the persistent master encryption key cache. Hence, database operations that require access to master encryption keys will experience a delay.

11.1.5.2 Persistent Master Encryption Key Cache First Mode

In persistent master encryption key cache first mode, the endpoints retrieve the master encryption key from the persistent master encryption key cache.

If the master encryption key is not available in the persistent master encryption key cache, then the endpoints attempt to retrieve the master encryption key from the Oracle Key Vault server.

The modifications to the master encryption keys on the Oracle Key Vault server are not applied until the key expires in the persistent master encryption key cache.

11.1.6 Persistent Master Encryption Key Cache Refresh Window

The persistent master encryption key cache refresh window helps to extend the availability of the master encryption key.

The refresh window feature of the persistent master encryption key cache enables the database endpoint to make multiple attempts to refresh the expired master encryption key from the Oracle Key Vault server. In that sense, the endpoint waits for the Oracle Key Vault server to be back online for the master encryption key refresh to complete. Meanwhile, if the master encryption key refresh attempt fails, then the keys are retrieved from the persistent cache for the duration of the refresh window.

The refresh window feature of the persistent master encryption key cache therefore extends the duration for which the master encryption key is available after it is cached in the persistent master encryption key cache. At the same time, the endpoints can refresh the key during the refresh window instead of once at the end of the cache time. This addresses the possibility that persistent cache expires during the time when the Oracle Key Vault is unavailable, such as when a primary-standby switchover is in progress. The refresh window terminates and then the cache period begins as soon as the key is refreshed.

In the `okvclient.ora` file, you can use the `PKCS11_PERSISTENT_CACHE_REFRESH_WINDOW` parameter to extend the duration for which the master encryption key is available after it is cached in the persistent master encryption key cache. This value reflects the amount of time it takes for the Oracle Key Vault server to recover and return online. You must specify this value in minutes. The default value for `PKCS11_PERSISTENT_CACHE_REFRESH_WINDOW` is 30 (minutes).

Related Topics

- [PKCS11_PERSISTENT_CACHE_TIMEOUT Parameter](#)
The `PKCS11_PERSISTENT_CACHE_TIMEOUT` parameter sets how long the master encryption is available in the persistent cache.

11.1.7 Persistent Master Encryption Key Cache Parameters

Oracle Key Vault provides parameters to configure the persistent master encryption key cache.

- [PKCS11_CACHE_TIMEOUT Parameter](#)
The `PKCS11_CACHE_TIMEOUT` parameter sets how long a master encryption key is available in the in-memory cache.
- [PKCS11_PERSISTENT_CACHE_TIMEOUT Parameter](#)
The `PKCS11_PERSISTENT_CACHE_TIMEOUT` parameter sets how long the master encryption is available in the persistent cache.
- [PKCS11_PERSISTENT_CACHE_FIRST Parameter](#)
The `PKCS11_PERSISTENT_CACHE_FIRST` parameter sets the persistent master encryption key cache operation mode.

- [PKCS11_CONFIG_PARAM_REFRESH_INTERVAL Parameter](#)
The `PKCS11_CONFIG_PARAM_REFRESH_INTERVAL` parameter describes the frequency at which a long-running process will re-read the `okvclient.ora` configuration file.
- [PKCS11_PERSISTENT_CACHE_REFRESH_WINDOW Parameter](#)
The `PKCS11_PERSISTENT_CACHE_REFRESH_WINDOW` parameter extends time the master encryption key is available after it is cached in the persistent master encryption key cache.
- [EXPIRE PKCS11 PERSISTENT CACHE ON DATABASE SHUTDOWN Parameter](#)
The `EXPIRE PKCS11 PERSISTENT CACHE ON DATABASE SHUTDOWN` parameter ensures that the PKCS#11 persistent cache for a given endpoint database automatically expires upon shutdown of the endpoint database.

11.1.7.1 PKCS11_CACHE_TIMEOUT Parameter

The `PKCS11_CACHE_TIMEOUT` parameter sets how long a master encryption key is available in the in-memory cache.

You set the `PKCS11_CACHE_TIMEOUT` parameter in the `okvclient.ora` file. You must specify the value in minutes. When the specified duration of time elapses, the master encryption key expires. Expired master encryption keys are not deleted from the in-memory cache.

The default value for `PKCS11_CACHE_TIMEOUT` is 60 (minutes). Oracle recommends that you set the `PKCS11_CACHE_TIMEOUT` parameter in the Oracle Key Vault management console, where it is called `PKCS11 In-Memory Cache Timeout`.

Related Topics

- [Setting Global Endpoint Configuration Parameters](#)
You can set global endpoint configuration parameters in the Oracle Key Vault management console.

11.1.7.2 PKCS11_PERSISTENT_CACHE_TIMEOUT Parameter

The `PKCS11_PERSISTENT_CACHE_TIMEOUT` parameter sets how long the master encryption is available in the persistent cache.

You set the `PKCS11_PERSISTENT_CACHE_TIMEOUT` parameter in the `okvclient.ora` file. This time starts when the database retrieves the key from the Oracle Key Vault server and puts it in the cache. After this duration has elapsed, the master encryption key expires. At this time, the endpoint will attempt to contact the Oracle Key Vault server in order to retrieve the key, and if it succeeds, the key remains available for another duration specified by this parameter. If it is unable to retrieve the key, the key remains available for the amount of time dictated by the `PKCS11_PERSISTENT_CACHE_REFRESH_WINDOW` parameter, after which the database can no longer use the key without successfully retrieving it again from the Oracle Key Vault server. Expired master encryption keys are not deleted from persistent master encryption key cache.

The `Cache Start Time` and `Maximum Use Time` values displayed in the `OKV Persistent Cache` entries list is updated when the master encryption key is refreshed.

The default value for `PKCS11_PERSISTENT_CACHE_TIMEOUT` is 1440 (minutes).

You can disable the persistent master encryption key cache by setting both the `PKCS11_PERSISTENT_CACHE_REFRESH_WINDOW` and the `PKCS11_PERSISTENT_CACHE_TIMEOUT` parameters to 0 (zero).

Oracle recommends that you set this global parameter in the Oracle Key Vault management console.

 **Note:**

The parameter `PKCS11_PERSISTENT_CACHE_TIMEOUT` and its default value are included by default in the `okvclient.ora` file.

Related Topics

- [Setting Global Endpoint Configuration Parameters](#)
You can set global endpoint configuration parameters in the Oracle Key Vault management console.

11.1.7.3 PKCS11_PERSISTENT_CACHE_FIRST Parameter

The `PKCS11_PERSISTENT_CACHE_FIRST` parameter sets the persistent master encryption key cache operation mode.

You set the `PKCS11_PERSISTENT_CACHE_FIRST` parameter in the `okvclient.ora` file.

The following are the modes of operation:

- **Oracle Key Vault First Mode:** To enable Oracle Key Vault first mode, set the value of the `PKCS11_PERSISTENT_CACHE_FIRST` parameter to 0 (zero).
- **Persistent Master Encryption Key Cache First Mode:** Persistent master encryption key cache first mode is the default mode.

To enable persistent master encryption key cache first mode, set the value of the `PKCS11_PERSISTENT_CACHE_FIRST` parameter to 1.

Related Topics

- [Oracle Key Vault First Mode](#)
In Oracle Key Vault first mode, the endpoints attempt to retrieve the master encryption key from the Oracle Key Vault server.
- [Persistent Master Encryption Key Cache First Mode](#)
In persistent master encryption key cache first mode, the endpoints retrieve the master encryption key from the persistent master encryption key cache.

11.1.7.4 PKCS11_CONFIG_PARAM_REFRESH_INTERVAL Parameter

The `PKCS11_CONFIG_PARAM_REFRESH_INTERVAL` parameter describes the frequency at which a long-running process will re-read the `okvclient.ora` configuration file.

This parameter also describes the frequency at which a process will attempt to remove expired master encryption keys from the persistent cache.

When the process cannot use a key from the in-memory cache and instead reaches out to the persistent cache or the Oracle Key Vault server, if it has been longer than the value specified by `PKCS11_CONFIG_PARAM_REFRESH_INTERVAL` since `okvclient.ora` was last read,

the process will re-read `okvclient.ora`, start using any changed parameters, re-read the `okvclient.ora` configuration file, start using any changed parameters, and remove expired master encryption keys from the persistent cache. Note that if the parameter for the in-memory cache and if `PKCS11_CACHE_TIMEOUT`, is larger than `PKCS11_CONFIG_PARAM_REFRESH_INTERVAL`, then these operations will be performed at intervals described by the `PKCS11_CACHE_TIMEOUT` parameter instead.

You set the `PKCS11_CONFIG_PARAM_REFRESH_INTERVAL` parameter in `okvclient.ora`. You must specify this value in minutes. The default value for `PKCS11_CONFIG_PARAM_REFRESH_INTERVAL` is 10 (minutes).

You can disable this parameter by setting the `PKCS11_CONFIG_PARAM_REFRESH_INTERVAL` parameter to 0 (zero).

11.1.7.5 PKCS11_PERSISTENT_CACHE_REFRESH_WINDOW Parameter

The `PKCS11_PERSISTENT_CACHE_REFRESH_WINDOW` parameter extends time the master encryption key is available after it is cached in the persistent master encryption key cache.

You set the `PKCS11_PERSISTENT_CACHE_REFRESH_WINDOW` parameter in the `okvclient.ora`. You must specify the value in minutes. The default value for `PKCS11_PERSISTENT_CACHE_REFRESH_WINDOW` is 30 (minutes).

You can disable the persistent master encryption key cache by setting the `PKCS11_PERSISTENT_CACHE_REFRESH_WINDOW` and `PKCS11_PERSISTENT_CACHE_TIMEOUT` parameters to 0 (zero). Oracle recommends that you set these global parameters in the Oracle Key Vault management console.

Related Topics

- [Setting Global Endpoint Configuration Parameters](#)
You can set global endpoint configuration parameters in the Oracle Key Vault management console.

11.1.7.6 EXPIRE PKCS11 PERSISTENT CACHE ON DATABASE SHUTDOWN Parameter

The `EXPIRE PKCS11 PERSISTENT CACHE ON DATABASE SHUTDOWN` parameter ensures that the `PKCS#11` persistent cache for a given endpoint database automatically expires upon shutdown of the endpoint database.

When enabled, the `EXPIRE PKCS11 PERSISTENT CACHE ON DATABASE SHUTDOWN` protects the persistent cache by using a system-generated random password that is independent of the password that was set when an endpoint database was enrolled in Oracle Key Vault, even if an auto-login wallet was used. Having the persistent cache password protected provides better security.

Before you can use the `EXPIRE PKCS11 PERSISTENT CACHE ON DATABASE SHUTDOWN` parameter, ensure that the endpoint database has had the patch for bug 29869906: `AUTO-LOGIN OKV NEEDS PERSISTENT CACHE PROTECTION KEY FROM RDBMS` applied to it. This patch applies to Oracle Database releases 12.1 through 19c. Contact Oracle Support for more information.

You can set `EXPIRE PKCS11 PERSISTENT CACHE ON DATABASE SHUTDOWN` for individual endpoint databases that have been enrolled with Oracle Key Vault, or globally for all

endpoint databases that have been enrolled in Oracle Key Vault. This parameter is not available in the `okvclient.ora` configuration file for the database endpoint. To set this parameter, use the Oracle Key Vault management console.

After you have enabled `EXPIRE PKCS11 PERSISTENT CACHE ON DATABASE SHUTDOWN`, the `PKCS#11` persistent cache is created when keys are fetched from Oracle Key Vault. The cache remains available to the endpoint database only as long as the database instance is mounted or open. When the endpoint database is shut down, the `PKCS#11` persistent cache is no longer available, but is recreated the next time the endpoint database is started. The persistent cache does, however, remain available when an endpoint pluggable database (PDB) is closed and then re-opened.

Be aware that after you have enabled `EXPIRE PKCS11 PERSISTENT CACHE ON DATABASE SHUTDOWN` for a given endpoint database, you can no longer use the `okvutil list -t okv_persistent_cache` command to view the contents of the persistent cache. In addition, you must ensure that Oracle Key Vault is available when keys are fetched after the endpoint database is started.

Setting `EXPIRE PKCS11 PERSISTENT CACHE ON DATABASE SHUTDOWN` for Individual Endpoint Databases

1. Log in to the Oracle Key Vault management console as a user who has the System Administrator role.
2. Click the **Endpoints** tab.
3. On the Endpoints page, select the endpoint for which you want to set `EXPIRE PKCS11 PERSISTENT CACHE ON DATABASE SHUTDOWN`.
4. On the Endpoint Details page, scroll to the bottom and then set the **Expire PKCS11 Persistent Cache on Database Shutdown** checkbox.
5. Click **Save**.

Setting `EXPIRE PKCS11 PERSISTENT CACHE ON DATABASE SHUTDOWN` Globally

The following procedure will apply the `EXPIRE PKCS11 PERSISTENT CACHE ON DATABASE SHUTDOWN` to all current and future endpoint databases that have been enrolled with Oracle Key Vault.

1. Log in to the Oracle Key Vault management console as a user who has the System Administrator role.
2. Select the **Endpoints** tab, and then **Settings** from the left side bar..
3. In the Global Endpoint Configuration Parameters page, set the **Expire PKCS11 Persistent Cache on Database Shutdown** checkbox.
4. Click **Save**.

11.1.8 Listing the Contents of the Persistent Master Key Cache

The `okvutil list` command can be used to list the master encryption keys that are cached in the persistent master encryption key cache.

Oracle Key Vault automatically removes master encryption keys that are expired after you execute the `okvutil list` command on the persistent cache.

- Execute the `okvutil list` command, similar to the following example:

```
$ ./okvutil list -t okv_persistent_cache -l $ORACLE_HOME/okv/$ORACLE_SID
Enter Oracle Key Vault endpoint password: password
```

Output similar to the following appears:

```
OKV Persistent Cache entries:
Current Persistent Cache Timeout is 600 seconds
Version Unique ID                               TDE Master Key
Identifier      Cache Start Time      Maximum Use Time  Maximum Refresh
Window Status
02      55D745B1-2F30-667F-E053-0100007FAFDB
0636846AAAF88F74FC6BF1DB68538797B69 22:38:12 2019-08-03 600 seconds      0
seconds      Expired
02      55D745B1-2F2E-667F-E053-0100007FAFDB
063AC48E9433734F7EBF97180276E719C4 22:37:10 2019-08-03 600 seconds      180
seconds      Available
02      55D745B1-2F2D-667F-E053-0100007FAFDB
0604425983989C4F6ABF7BD9E1D55459C4 22:37:00 2019-08-03 600 seconds      180
seconds      Available
02      55D70FA4-81D1-5C8A-E053-0100007F8217
06172EACB79F4C4F32BFB7D50B0ACA7101 03:44:22 2019-08-03 300 seconds      0
seconds      Expired
02      55D745B1-2F2B-667F-E053-0100007FAFDB
06983C4664FFC04F6ABF72F961A15AD943 22:36:49 2019-08-03 600 seconds      300
seconds      Available
02      55D745B1-2F29-667F-E053-0100007FAFDB
0639E05D58B27B4FFDBFAEC5EAA08DB301 03:26:40 2019-08-03 300 seconds      0
seconds      Expired
02      55D745B1-2F28-667F-E053-0100007FAFDB
06A29F4039E1B74FDCBFA687E0608EEEBBA 03:19:17 2019-08-03 300 seconds      0
seconds      Expired
02      55D745B1-2F27-667F-E053-0100007FAFDB
0678287C2877B74FF3BF0BA33A17A59F94 03:19:21 2019-08-03 300 seconds      0
seconds      Expired
```

The following table describes the columns in the OKV Persistent Cache entries list:

Column Name	Description
Version	Persistent master encryption key cache version
Unique ID	KMIP identifier assigned to the master encryption key
TDE Master Key Identifier	Database ID assigned to the master encryption key
Cache Start Time	Time at which the master encryption key was cached
Maximum Use Time	Time until the master encryption key expires, in seconds, from the moment that the key was placed into the persistent master encryption key cache
Maximum Refresh Window	Extended duration for which the master encryption key is available after it is cached in the persistent master encryption key cache
Status	Indicates whether the master encryption key is available, refreshing or expired

11.1.9 Oracle Database Deployments and Persistent Master Encryption Key Cache

The persistent master encryption key cache affects the integration of other Oracle features with Oracle Key Vault.

- **Database restart when the Oracle Key Vault Server is offline:** When you configure Oracle Key Vault to use an auto-login wallet, the database connects to the Oracle Key Vault server when the database is restarted. If the Oracle Key Vault server is offline when the database restarts, then the database retrieves master encryption keys from the persistent master encryption key cache. Database operations resume normally if the master encryption keys are active and have not expired.

Ensure that the passwords of the persistent master encryption key cache and the Oracle Key Vault endpoint wallet are synchronized.

Note:

The persistent master encryption key cache must be deleted when the endpoint wallet credentials are modified.

- **Using the persistent master encryption key cache in an Oracle Real Application Cluster (Oracle RAC) environment:** In an Oracle RAC environment, each Oracle RAC node is a unique database endpoint, and uses a unique persistent master encryption key cache.

In an Oracle RAC Environment, you must query the database from each Oracle RAC node to cache the most recent version of the master encryption key in the persistent master encryption key cache of each Oracle RAC node.

- **Using persistent master encryption key cache in an Oracle Data Guard Environment:** Rotation of the master encryption key in the primary server's database caches the master encryption key in the persistent master encryption key cache of the primary server's database.

The standby server retrieves and caches the new master encryption key in the persistent master encryption key cache of the standby server's database after the new REDO logs from the primary server are applied on the standby server. To avoid disruptions, you should synchronize the primary and standby servers immediately after the rotation of the master encryption key in the primary server's database.

11.2 Configuring an Oracle Key Vault to New TDE-Enabled Database Connection

You can configure a connection between Oracle Key Vault and a database that has not yet been configured for Transparent Data Encryption.

- [About Configuring an Oracle Key Vault to New TDE-Enabled Database Connection](#)
You can configure a connection between Oracle Key Vault and a database that has not yet been configured for TDE.

- [Limitations to Transparent Data Encryption Endpoint Integration](#)
This type of Transparent Data Encryption (TDE) endpoint integration can have problems if the versions are incompatible.
- [Step 1: Configure the Oracle Key Vault Server Environment](#)
Before you can configure the connection, you must ensure that Oracle settings are correct.
- [Step 2: Integrate Transparent Data Encryption with Oracle Key Vault](#)
This integration enables Oracle Key Vault to directly manage the TDE master encryption keys.

11.2.1 About Configuring an Oracle Key Vault to New TDE-Enabled Database Connection

You can configure a connection between Oracle Key Vault and a database that has not yet been configured for TDE.

Before you start configuring the connection, ensure that the Oracle Key Vault client installation environment is the same as the database runtime environment. The environment variables `ORACLE_HOME`, `ORACLE_BASE`, and `ORACLE_SID` must be set to the same values in `svrctl` and operating system environment variables. This also applies if you are using the Oracle Key Vault RESTful services utility to enroll endpoints.

For information about configuring Oracle Data Guard so that it can work with TDE and Oracle Key Vault:

- [Oracle Database Advanced Security Guide](#), release 19c
- [Oracle Database Advanced Security Guide](#), release 18c
- [Oracle Database Advanced Security Guide](#), release 12.2.0.1

For information about configuring Oracle Real Application Clusters (Oracle RAC) to work with TDE and Oracle Key Vault:

- [Oracle Database Advanced Security Guide](#), release 19c
- [Oracle Database Advanced Security Guide](#), release 18c
- [Oracle Database Advanced Security Guide](#), release 12.2.0.1

11.2.2 Limitations to Transparent Data Encryption Endpoint Integration

This type of Transparent Data Encryption (TDE) endpoint integration can have problems if the versions are incompatible.

The limitations to TDE endpoint integration are as follows:

- All endpoints on the same computer must use the same version of the Oracle Key Vault library. There is only one location per computer for the `liborapkcs.so` file, which is `/opt/oracle/expapi/64/hsm/oracle/1.0.0/liborapkcs.so`.
- If you have multiple databases on the same host, and those databases share the same `sqlnet.ora` file, then you must migrate all databases at the same time. If each database has its own `sqlnet.ora` file (controlled by individual settings for the `TNS_ADMIN` parameter), then you can migrate the databases into Oracle Key Vault at independent points in time.

▲ Caution:

Oracle strongly recommends that you never remove keys from a wallet or the wallet itself after TDE is configured. Loss of keys will result in the loss of the database. This is true even in the following scenarios:

- If you had created or opened a keystore (wallet or Oracle Key Vault), even before setting the first key and before encrypting data in your database
- If all of the encrypted data has been decrypted
- If you have migrated your keys and wallets to a hardware security module

11.2.3 Step 1: Configure the Oracle Key Vault Server Environment

Before you can configure the connection, you must ensure that Oracle settings are correct.

These settings include Oracle environment variables and the Oracle `COMPATIBILITY` parameter.

1. Log in to the server where the database endpoint is installed.
2. Ensure that the `ORACLE_BASE` environment variable is set for the current operating system session, as well as in `srvctl` for Oracle Real Application Clusters (Oracle RAC)-enabled databases, before you start the database.

This step is very important. If the `ORACLE_BASE` environment variable is not present, then create a soft link from the `$ORACLE_BASE/okv/$ORACLE_SID/okvclient.ora` file to the `key_vault_endpoint_installation_dir/conf/okvclient.ora` file. In an Oracle Real Application Clusters environment, you must perform this step on all database instances.

3. Ensure that the `COMPATIBILITY` initialization parameter is set to `11.2.0.0` or later.
4. Enroll and provision the endpoint for the Transparent Data Encryption (TDE)-enabled database that contains the TDE data.

When you initially enroll the endpoint, select `ORACLE_DB` as the endpoint type for integration with TDE.

5. Ensure that the endpoint has access to the virtual wallet that you want to use by defining the wallet as the **default wallet** for that endpoint.

In Oracle RAC and Oracle Data Guard environments, the endpoints of all primary and standby instances share the same default wallet.

6. Depending on the Oracle Database release, configure the encryption wallet location.
 - For Oracle Database release 11.2.0.4 and 12.1.0.2, configure the `sqlnet.ora` file on this database to point to Oracle Key Vault as follows:

```
ENCRYPTION_WALLET_LOCATION=( SOURCE=( METHOD=HSM ) )
```

- For Oracle Database release 12.2.0.1, configure the `sqlnet.ora` file on this database to point to Oracle Key Vault as follows:

```
ENCRYPTION_WALLET_LOCATION=( SOURCE=( METHOD=OKV ) )
```

By default, the `sqlnet.ora` file is located in the `ORACLE_HOME/network/admin` directory or in the location set by the `TNS_ADMIN` environment variable.

- For Oracle Database release 18c or later, configure the following parameters:
 - Set `WALLET_ROOT` to define the installation directory of the Oracle Key Vault client. The directory that will be defined as `WALLET_ROOT` must have the following sub-directories (in lower case) in order for the database to auto-discover the correct keystore configuration:
 - * `/okv`: The Oracle Key Vault client software is installed into this directory.
 - * `/tde`: The TDE wallet (or the auto-open wallet for Oracle Key Vault) goes into this subdirectory.
 - * `/tde_seps`: This directory is for a wallet that will hide the keystore password (wallet or Oracle Key Vault) from the `ADMINISTER KEY MANAGEMENT` command when the `EXTERNAL STORE` clause is used to replace the password.
 - Set `TDE_CONFIGURATION` to `OKV` for Oracle Key Vault, or `OKV|FILE` for an auto-open connection into Oracle Key Vault.

Endpoints use the PKCS#11 library support to manage TDE master encryption keys. Execute the `root.sh` script (in the `okvclient_installation_directory/bin` directory) to deploy the PKCS#11 library that facilitates the communication between the endpoint and Oracle Key Vault.

At this stage, the Oracle database will use Oracle Key Vault for centralized key management. For all TDE commands and statements, use the Oracle Key Vault endpoint password that was specified during the installation of the endpoint software, unless the keystore password is hidden from the `ADMINISTER KEY MANAGEMENT` commands in a wallet that was created in the `WALLET_ROOT/tde_seps` directory.

7. Reconnect to the database if you are in SQL*Plus.

The changes will appear after you log out of the current SQL*Plus session and then connect again.

8. Query the `V$ENCRYPTION_WALLET` dynamic view to ensure that the `METHOD_DATA` setting in the `sqlnet.ora` file changed.

```
SELECT * FROM V$ENCRYPTION_WALLET;
```

The output of the query should now show `OKV`.

The TDE configuration is complete at this stage. You can now encrypt existing tablespaces or create new encrypted tablespaces in the database. Oracle does not recommend using TDE column encryption with any external key manager. If you have configured the `sqlnet.ora` file correctly along with the rest of the TDE configuration, then a TDE master encryption key is created in Oracle Key Vault when you set the encryption key by using one of the following SQL statements:

- `ALTER SYSTEM SET [ENCRYPTION] KEY IDENTIFIED BY "password";`
- `ADMINISTER KEY MANAGEMENT SET [ENCRYPTION] KEY IDENTIFIED BY "password" WITH BACKUP;`

With both of these SQL statements, the password was defined when the Oracle Key Vault client software was installed. If no password was defined at that time, then the password for these two statements is `NULL`.

11.2.4 Step 2: Integrate Transparent Data Encryption with Oracle Key Vault

This integration enables Oracle Key Vault to directly manage the TDE master encryption keys.

1. Ensure that you are logged into the server where the Oracle Key Vault client is installed.
2. Execute the `root` script from `okvclient_installation_directory/bin`.

This script implements the persistent master encryption key cache feature in the Oracle Key Vault PKCS#11 library, which improves the availability of the database during intermittent network disruptions or Oracle Key Vault upgrade.

- **UNIX:** The root script copies the PKCS#11 library into `/opt/oracle/extapi/64/hsm/oracle/1.0.0` and minimizes the file access privileges.
 - **Windows:** Run the `root.bat` script to copy the `liborapkcs.dll` file (located in the `lib` directory) to the `C:\oracle\extapi\64\hsm\oracle\1.0.0` directory. Provide the database version when prompted.
3. For password-protected wallets on the database, open the wallet. (Auto-login wallets are automatically opened.)

- **For Oracle Database release 11.2.0.4:** As a user who has been granted the `ALTER SYSTEM` system privilege:

```
ALTER SYSTEM SET [ENCRYPTION] WALLET OPEN IDENTIFIED BY
"Oracle_Key_Vault_endpoint_password";
```

- **For Oracle Database release 12.1.0.2 or later:** As a user who has been granted the `SYSKM` administrative privilege:

```
ADMINISTER KEY MANAGEMENT SET KEYSTORE OPEN IDENTIFIED BY
"Oracle_Key_Vault_endpoint_password";
```

4. Set the master encryption key.

- **For Oracle Database release 11.0.2:**

```
ALTER SYSTEM SET [ENCRYPTION] KEY IDENTIFIED BY
"Oracle_Key_Vault_endpoint_password";
```

- **For Oracle Database release 12.1.0.2 or later:**

```
ADMINISTER KEY MANAGEMENT SET [ENCRYPTION] KEY IDENTIFIED BY
"Oracle_Key_Vault_endpoint_password" WITH BACKUP;
```

Related Topics

- [Enrolling and Upgrading Endpoints for Oracle Key Vault](#)
After an endpoint is registered in Oracle Key Vault, an endpoint administrator enrolls and provisions the endpoint to manage security objects in Key Vault.
- [Managing Endpoints](#)
You can enroll, reenroll, suspend, and delete endpoints.
- [Granting Access to Users, User Groups, Endpoints, and Endpoint Groups](#)
You can grant the **Read Only**, **Read and Modify**, and **Manage Wallet** access levels to users, user groups, endpoints, and endpoint groups.

11.3 Migrating Existing TDE Wallets to Oracle Key Vault

A migrated TDE wallet can be used to restore database contents that were previously encrypted by TDE.

- [About Migrating Existing TDE Wallets to Oracle Key Vault](#)
The `sqlnet.ora` file enables the migration of existing TDE wallets to Oracle Key Vault.
- [Migrating an Existing TDE Wallet to Oracle Key Vault](#)
You can use the `okvutil upload` command to start the migration of a TDE-enabled database from an existing TDE wallet to Oracle Key Vault.
- [Restoring Database Contents Previously Encrypted by TDE Using an Oracle Wallet](#)
You perform the restoration process on the endpoint where you downloaded the Oracle wallet.

11.3.1 About Migrating Existing TDE Wallets to Oracle Key Vault

The `sqlnet.ora` file enables the migration of existing TDE wallets to Oracle Key Vault.

For Oracle Database release 12.2.0.1 or earlier, the `sqlnet.ora` file enables the migration of existing TDE wallets to Oracle Key Vault. For Oracle Database release 18c or later, you must set the parameters `TDE_CONFIGURATION` and `WALLET_ROOT` to migrate wallets to Oracle Key Vault.

When the Transparent Data Encryption (TDE) wallets already exist, you must modify the `sqlnet.ora` file or the `TDE_CONFIGURATION` parameter to recognize Oracle Key Vault before you can migrate the existing TDE wallets to Oracle Key Vault.

Along with the current TDE master encryption key, Oracle wallets maintain historical TDE master encryption keys that are replaced by each rekey operation that rotates the TDE master encryption key. These historical TDE master encryption keys help to restore Oracle Database backups that were previously made using one of the historical TDE master encryption keys. During the TDE migration from an Oracle wallet file to Oracle Key Vault, Key Vault generates new master encryption keys. After this master encryption key generation, Oracle Key Vault maintains all new keys.

Oracle recommends that you upload the Oracle wallet to Oracle Key Vault before you perform the migration. This enables you to keep a backup of the wallet with all of the historical key information, before you begin the migration. When the migration is complete, manually delete the old wallet on the client system.

If you are operating on an Oracle Real Application Clusters (Oracle RAC) configuration, ensure that you migrate from a shared TDE wallet (in Oracle Automatic Storage Management (Oracle ASM) or Oracle Automatic Storage Management Cluster File System (Oracle ACFS)) to Oracle Key Vault. Individual wallets for each Oracle RAC node are not supported.

Related Topics

- [Restoring Database Contents Previously Encrypted by TDE Using an Oracle Wallet](#)
You perform the restoration process on the endpoint where you downloaded the Oracle wallet.

11.3.2 Migrating an Existing TDE Wallet to Oracle Key Vault

You can use the `okvutil upload` command to start the migration of a TDE-enabled database from an existing TDE wallet to Oracle Key Vault.

1. Back up the database that you want to migrate.
2. Complete the enrollment of the endpoint.
3. If you have not done so already, then use the `okvutil upload` command to upload current and historical master encryption keys from the TDE wallet into the virtual wallet in Oracle Key Vault.

```
$ OKV_HOME/bin/okvutil upload -t WALLET -l /path/to/tde-wallet -g
name_of_wallet_in_Oracle_Key_Vault -v 4
```

This step allows you to delete the wallet after a successful migration, which is often a requirement of security policies that do not allow encryption keys on the encrypting server.

4. Configure the wallet location.
 - **For Oracle Database release 12.2.0.1 or earlier:** Edit the `METHOD` setting of the Oracle Database `sqlnet.ora` file for the migration to Oracle Key Vault:

```
ENCRYPTION_WALLET_LOCATION=(SOURCE=(METHOD=OKV)
(METHOD_DATA=(DIRECTORY=wallet_location)))
```

By default, the `sqlnet.ora` file is located in the `ORACLE_HOME/network/admin` directory or in the location set by the `TNS_ADMIN` environment variable.

- **For Oracle Database release 18c or later:** Set the `TDE_CONFIGURATION` parameter.

```
ALTER SYSTEM SET TDE_CONFIGURATION = "KEystore_CONFIGURATION=OKV|FILE" SCOPE =
BOTH;
```

The `WALLET_ROOT` parameter is already set, so you do not need to change it.

5. Reconnect to the database instance (or restart an Oracle RAC database) to capture the changes in the `sqlnet.ora` file.

If you are reconnecting to the database instance, then changes to the `TDE_CONFIGURATION` parameter in Oracle Database 18c or later are applied immediately, and no restart is necessary.

6. Query the `V$ENCRYPTION_WALLET` dynamic view to ensure that the `METHOD_DATA` setting in the `sqlnet.ora` file changed.

```
SELECT CON_ID, WALLET_TYPE, WALLET_ORDER, STATUS
FROM V$ENCRYPTION_WALLET
WHERE CON_ID <> 2;
```

The output of the query should now show `METHOD=OKV`.

7. If the endpoint is a an Oracle Release 11g release 2 database, then close the local Oracle wallet and open the HSM wallet as follows:
8. Close the local Oracle wallet using these steps:
 - a. Close the local Oracle wallet as follows:

If the auto-login wallet is open, execute the following commands:

```
oracle$ cd wallet_location
oracle$ mv cwallet.sso cwallet.sso.bak
sqlplus sys as sysdba
Enter password: password
SQL> ALTER SYSTEM SET WALLET CLOSE;
```

If the password-protected wallet is open, then execute the following statement in SQL*Plus:

```
ALTER SYSTEM SET WALLET CLOSE IDENTIFIED BY "wallet_password";
```

- b. In SQL*Plus, open the connection into Oracle Key Vault, where *Oracle_Key_Vault_password* is the password that was provided when the *okvclient.jar* file was installed:

```
ALTER SYSTEM SET WALLET OPEN IDENTIFIED BY "Oracle_Key_Vault_password";
```

9. Migrate from TDE wallets to Oracle Key Vault.

- **For Oracle Database 11g release 2:** If you entered a password for the wallet while installing the endpoint client software, then in SQL*Plus, execute this statement:

```
ALTER SYSTEM SET ENCRYPTION KEY
IDENTIFIED BY "Oracle_Key_Vault_password"
MIGRATE USING "wallet_password";
```

If you chose the auto-login option while installing the endpoint client software, then execute this statement:

```
ALTER SYSTEM SET ENCRYPTION KEY
IDENTIFIED BY "NULL"
MIGRATE USING "wallet_password";
```

- **For Oracle Database 12c or later:** As a user who has been granted the SYSKM administrative privilege:

```
ADMINISTER KEY MANAGEMENT SET ENCRYPTION KEY IDENTIFIED BY
"Oracle_Key_Vault_password" MIGRATE USING "wallet_password" WITH BACKUP;
```

Though the WITH BACKUP clause is required for the ADMINISTER KEY MANAGEMENT statement, it is ignored by TDE in Oracle Key Vault.

10. Open the wallet.

- **For Oracle Database 11g release 2:** If the endpoint requires a password to connect to Oracle Key Vault, then enter the password.

```
ALTER SYSTEM SET ENCRYPTION WALLET OPEN
IDENTIFIED BY "Oracle_Key_Vault_endpoint_password";
```

- **For Oracle Database 12c or later:**

```
ADMINISTER KEY MANAGEMENT SET KEystore OPEN
IDENTIFIED BY "Oracle_Key_Vault_endpoint_password";
```

11. After you complete the migration, if you are using an auto-login wallet, then re-enable it by renaming the *cwallet.sso.bak* file to *cwallet.sso*.

Related Topics

- [About Endpoint Enrollment and Provisioning](#)
Endpoints are Oracle Key Vault clients that use the server to store and manage security objects, share them with trusted peers, and retrieve them.

- [okvutil download Command](#)
The `okvutil download` command downloads security objects from Oracle Key Vault to the endpoint.

11.3.3 Restoring Database Contents Previously Encrypted by TDE Using an Oracle Wallet

You perform the restoration process on the endpoint where you downloaded the Oracle wallet.

When an Oracle database endpoint is converted from a local Oracle wallet file to using Oracle Key Vault, you may need to restore backups that were encrypted by using a key from this local wallet file.

In this case, you must download the necessary key from Oracle Key Vault to a local wallet file to be used when you decrypt the backup during the restore process. For example, suppose that the `Finance_DB` database had recently migrated to use an [online master key](#) to Oracle Key Vault after you have uploaded the premigration wallet. If a system failure forces you to restore from a database backup taken before the migration to Oracle Key Vault, then you can still restore the contents of the database by using an Oracle wallet downloaded from the Oracle virtual wallet that contains the `Finance_DB` wallet data that you had uploaded earlier.

1. Download this Oracle wallet from Oracle Key Vault by using the `okvutil download` command.
2. On the endpoint where you downloaded the Oracle wallet, edit the `sqlnet.ora` file to have the following setting:

```
ENCRYPTION_WALLET_LOCATION=(SOURCE=(METHOD=FILE)  
(METHOD_DATA=(DIRECTORY=wallet_file_path)))
```

Put the `ENCRYPTION_WALLET_LOCATION` setting on one line.

3. Open the downloaded wallet using the password you specified.
 - For Oracle Database 11g release 2, as a user who has been granted the `ALTER SYSTEM` system privilege:

```
ALTER SYSTEM SET ENCRYPTION WALLET OPEN IDENTIFIED BY "wallet_password";
```

- For Oracle Database 12c or later, as a user who has been granted the `SYSKM` administrative privilege:

```
ADMINISTER KEY MANAGEMENT SET KEYSTORE OPEN IDENTIFIED BY "wallet_password";
```

Opening the wallet enables the server to read the contents of the updated `sqlnet.ora` file. At this point, the endpoint server has been restored to a state where it now can run with the original version of the wallet.

Related Topics

- [okvutil download Command](#)
The `okvutil download` command downloads security objects from Oracle Key Vault to the endpoint.

11.4 Uploading and Downloading Oracle Wallets

To store and share Oracle wallets, you must upload them to Oracle Key Vault.

- [About Uploading and Downloading Oracle Wallets](#)
You use the `okvutil` utility to upload and download Oracle wallets.
- [Uploading Oracle Wallets](#)
The `okvutil upload` command uploads wallets to Oracle Key Vault.
- [Downloading Oracle Wallets](#)
The `okvutil download` command downloads an Oracle wallet from the Oracle Key Vault server to an endpoint.
- [Guidelines for Uploading and Downloading Oracle Wallets](#)
Oracle provides guidelines for uploading and downloading wallets to and from Oracle Key Vault.

11.4.1 About Uploading and Downloading Oracle Wallets

You use the `okvutil` utility to upload and download Oracle wallets.

After you upload a wallet to Oracle Key Vault, you can then create a new virtual wallet in Key Vault, and add security objects to it that you want to share. You must grant endpoints access to the virtual wallet before they can download it. You can use the `okvutil upload` and `okvutil download` commands to upload and download Oracle wallets between Oracle Key Vault and its endpoints. The `okvutil` utility is packaged with the endpoint software that you install at the endpoint.

The Oracle Key Vault `okvutil` software can read an Oracle wallet at the granularity level of an individual security object, and it supports security objects up to 128 KB in size. It therefore uploads the wallet contents as individual items. During download you can recreate the original wallet with the same set of security objects, or create a new wallet with different set of security objects.

You can upload and download both password-based wallets and auto-login wallets. The wallet contents can be downloaded later into a new wallet of either type. For example, an uploaded password-protected wallet can be downloaded as an auto-login wallet, or an uploaded auto-login wallet can be downloaded as a password-protected wallet.

You can use Oracle Key Vault to construct a new virtual wallet containing security objects from previously uploaded Oracle wallets. For example, given a previously uploaded Oracle wallet containing five symmetric keys and three opaque objects, you can create a new virtual wallet consisting of only three of the original five symmetric keys and one of the three original opaque objects. This virtual wallet can be downloaded like the original wallet to provide the endpoint with access to only a subset of the keys. This process does not modify the original wallet.

Related Topics

- [Oracle Key Vault `okvutil` Endpoint Utility Reference](#)
The `okvutil` utility enables you to perform tasks uploading and downloading security objects.

11.4.2 Uploading Oracle Wallets

The `okvutil upload` command uploads wallets to Oracle Key Vault.

Uploading the contents of a TDE wallet into Oracle Key Vault is a unique feature of Oracle Key Vault: If you plan to migrate the database to use Oracle Key Vault in online master key mode then you must upload the wallet content before the migration step.

That allows you to delete the file-based wallet after a successful migration from the database server, which is a requirement of the PCI-DSS. The upload operation uploads everything in the Oracle wallet, including security objects and their metadata so that the wallet can be reconstructed during the download process. The Oracle wallet typically contains TDE master encryption keys, historical TDE master encryption keys, SSL or TLS certificates and their metadata (stored in Oracle Key Vault as opaque objects), wallet metadata, as well as keys that you have explicitly added.

1. Ensure that the server containing the Oracle wallet has been enrolled and provisioned as an Oracle Key Vault endpoint.

2. Ensure that the endpoint has access to the virtual wallet that you want to use.

The endpoint must have read, modify, and manage wallet access to the virtual wallet in Oracle Key Vault.

3. Run the `okvutil upload` command to upload the wallet.

For example:

```
# okvutil upload -l /etc/oracle/wallets -t wallet -g HRWallet
Enter wallet password (<enter> for auto-login): password
Enter Oracle Key Vault endpoint password: Key_Vault_endpoint_password
Upload succeeded
```

In this example:

- `-l` specifies the directory location of the wallet that you are uploading.
- `-t` indicates the type, in this case, an Oracle wallet.
- `-g` specifies the Oracle Key Vault virtual wallet that was configured in Step 2, so that this wallet can be part of that virtual wallet.

At this point, the upload is complete. You can now share the virtual wallet with other users and endpoints.

Related Topics

- [Managing Endpoints](#)
You can enroll, reenroll, suspend, and delete endpoints.
- [Granting Access to Users, User Groups, Endpoints, and Endpoint Groups](#)
You can grant the **Read Only**, **Read and Modify**, and **Manage Wallet** access levels to users, user groups, endpoints, and endpoint groups.
- [okvutil upload Command](#)
The `okvutil upload` command uploads security objects to Oracle Key Vault.
- [Oracle Key Vault okvutil Endpoint Utility Reference](#)
The `okvutil` utility enables you to perform tasks uploading and downloading security objects.

11.4.3 Downloading Oracle Wallets

The `okvutil download` command downloads an Oracle wallet from the Oracle Key Vault server to an endpoint.

1. Ensure that the endpoint has Read access on the virtual wallet that you want to download.
2. Run the `okvutil download` command to download the wallet.

For example:

```
# okvutil download -l /etc/oracle/wallets/orcl/ -t WALLETT -g HRwallet
Enter new wallet password(<enter> for auto-login): Oracle_wallet_password
Confirm new wallet password: Oracle_wallet_password
Enter Oracle Key Vault endpoint password: Key_Vault_endpoint_password
```

In this example:

- `-l` is the location of the wallet to be created.
- `-t` indicates the type, in this case, an Oracle wallet.
- `-g` specifies the Oracle Key Vault virtual wallet that was configured in Step 1.

If the wallet already exists and you did not use the `-o` parameter to overwrite the existing wallet, then the following actions take place:

- The existing wallet is renamed to a backup name of the format `ewallet.p12.current_timestamp` where the *timestamp* is number of seconds since epoch.
- The newly downloaded wallet is given the name `ewallet.p12`.

3. Close and then reopen the wallet.

Closing and reopening the wallet makes the wallet content, including TDE master keys, available on a database encrypted with TDE, and loads the wallet contents into the TDE database. (Auto-login wallets are automatically opened the next time that they are accessed.)

- For Oracle Database 11g release 2:

```
ALTER SYSTEM SET ENCRYPTION WALLET CLOSE IDENTIFIED BY
"Oracle_wallet_password";
```

```
ALTER SYSTEM SET ENCRYPTION WALLET OPEN IDENTIFIED BY
"Oracle_wallet_password";
```

- For Oracle Database 12c or later:

```
ADMINISTER KEY MANAGEMENT SET KEYSTORE CLOSE IDENTIFIED BY
"Oracle_wallet_password";
```

```
ADMINISTER KEY MANAGEMENT SET KEYSTORE OPEN IDENTIFIED BY
"Oracle_wallet_password";
```

4. If you are operating in a shared server configuration such as Oracle RAC, then restart the database.

Related Topics

- [okvutil download Command](#)
The `okvutil download` command downloads security objects from Oracle Key Vault to the endpoint.
- [Granting Access to Users, User Groups, Endpoints, and Endpoint Groups](#)
You can grant the **Read Only**, **Read and Modify**, and **Manage Wallet** access levels to users, user groups, endpoints, and endpoint groups.

11.4.4 Guidelines for Uploading and Downloading Oracle Wallets

Oracle provides guidelines for uploading and downloading wallets to and from Oracle Key Vault.

- If there is a change to the content of the original wallet, such as a key rotation or a rekey operation, then upload the wallet again to Oracle Key Vault so that Key Vault has the latest copy of the wallet.
- Use care if you plan to use the `okvutil upload` and `okvutil download` commands, which provide an overwrite (`-o`) option. This option overwrites data in the virtual wallet that conflicts with the data to be uploaded. Before you use the `-o` option, you should create a local backup of the wallet file.
- Do not try to upload the same physical Oracle wallet to more than one virtual wallet on the Oracle Key Vault server. If you want to share an Oracle wallet with multiple endpoints, then create an endpoint group.

Related Topics

- [Managing Endpoint Groups](#)
An endpoint group is a named group of endpoints that share a common set of wallets.

11.5 Uploading and Downloading JKS and JCEKS Keystores

The `okvutil upload` and `okvutil download` commands can upload and download JKS and JCEKS keystores.

- [About Uploading and Downloading JKS and JCEKS Keystores](#)
You use the `okvutil` utility to upload and download JKS and JCEKS keystores.
- [Uploading JKS or JCEKS Keystores](#)
The `okvutil upload` command can upload a JKS or JCEKS to the Oracle Key Vault server.
- [Downloading JKS or JCEKS Keystores](#)
The `okvutil download` command can download an uploaded JKS or JCEKS keystore.
- [Guidelines for Uploading and Downloading JKS and JCEKS Keystores](#)
Oracle provides recommendations for when you upload and download JKS and JCEKS keystores.

11.5.1 About Uploading and Downloading JKS and JCEKS Keystores

You use the `okvutil` utility to upload and download JKS and JCEKS keystores.

You can upload JKS and JCEKS keystores to Oracle Key Vault for long-term retention, recovery, and sharing, and when you need them, download them to an endpoint.

Similar to wallets, when you upload a JKS or JCEKS keystore, Oracle Key Vault can read each item within the keystore. It uploads the keystore contents as individual items, and it supports an item up to 128 KB in size.

11.5.2 Uploading JKS or JCEKS Keystores

The `okvutil upload` command can upload a JKS or JCEKS to the Oracle Key Vault server.

1. Ensure that the server containing the Java keystore has been enrolled and provisioned as an Oracle Key Vault endpoint.
2. Ensure that access control has been configured for the endpoint.

If you are uploading the keystore to a virtual wallet, then ensure that the endpoint has the read, modify, and manage wallet access to this virtual wallet.

3. Run the `okvutil upload` command to upload the keystore.

The following examples show how to upload the JKS and JCEKS keystore to a virtual wallet.

This example shows how to upload a JKS keystore:

```
# okvutil upload -l /etc/oracle/fin_jks.jks -t JKS -g FinanceGrp
Enter source Java keystore password: Java_keystore_password
Enter Oracle Key Vault endpoint password: Key_Vault_endpoint_password
Upload succeeded
```

In this example:

- `-l` is the location of the Java keystore that is being uploaded.
- `-t` is the type of JKS or JCEKS keystore. Ensure that you upload the correct type of Java keystore when you upload or later on, when you download.
- `-g` is the virtual wallet in Oracle Key Vault where the Java keystore contents will be uploaded.

This example shows how to upload a JCEKS keystore:

```
# okvutil upload -l /etc/oracle/hr_jceks.jceks -t JCEKS -g HRGrp
Enter source Java keystore password: password
Enter Oracle Key Vault endpoint password: password
Upload succeeded
```

At this point, the upload is complete. You are now ready to share or download the Java keystore as needed.

Related Topics

- [Granting Access to Users, User Groups, Endpoints, and Endpoint Groups](#)
You can grant the **Read Only**, **Read and Modify**, and **Manage Wallet** access levels to users, user groups, endpoints, and endpoint groups.

11.5.3 Downloading JKS or JCEKS Keystores

The `okvutil download` command can download an uploaded JKS or JCEKS keystore.

1. Ensure that the endpoint has the read access on the virtual wallet that you want to download.
2. As an endpoint administrator, from the command line, run the `okvutil download` command to download the Java keystore.

For example:

```
# okvutil download -l /etc/oracle/new_java_files/hr_jceks.jceks -t JCEKS -g
HRGrp
Enter new Java keystore password: password
Confirm new Java keystore password: password
Enter Oracle Key Vault endpoint password: Key_Vault_endpoint_password
```

In this example:

- `-l` is the directory to which you want to download the uploaded Java keystore.

- `-t` is the type of JKS or JCEKS keystore. Ensure that you download the correct type of Java keystore.
- `-g` is the name of the object to download, which in this case is the JKS keystore `HRGrp`.

Related Topics

- [okvutil download Command](#)
The `okvutil download` command downloads security objects from Oracle Key Vault to the endpoint.
- [Granting Access to Users, User Groups, Endpoints, and Endpoint Groups](#)
You can grant the **Read Only**, **Read and Modify**, and **Manage Wallet** access levels to users, user groups, endpoints, and endpoint groups.

11.5.4 Guidelines for Uploading and Downloading JKS and JCEKS Keystores

Oracle provides recommendations for when you upload and download JKS and JCEKS keystores.

- If there is a change to the content of the original JKS or JCEKS keystore, then upload the keystore again to Oracle Key Vault so that Key Vault has the latest copy of the keystore.
- Use care if you plan to use the `okvutil upload` and `okvutil download` commands, which provide an overwrite (`-o`) option. This option overwrites data in the file. Before you use the `-o` option, you should create backups of the keystore files before downloading them.
- Do not try to upload the same physical JKS or JCEKS keystore to more than one virtual wallet on the Oracle Key Vault server. If you want to share a Java keystore with multiple endpoints, then create an endpoint group.

Related Topics

- [Managing Endpoint Groups](#)
An endpoint group is a named group of endpoints that share a common set of wallets.

11.6 Using a User-Defined Key as the TDE Master Encryption Key

You can import a generated key to be used as the Transparent Data Encryption (TDE) master encryption key in Oracle Key Vault.

- [About Using a User-Defined Key as the TDE Master Encryption Key](#)
Users who have the Key Administrator role can upload a user-defined key to the virtual wallet to which they have write access.
- [Step 1: Upload the User-Defined Key](#)
Use the `okvutil upload` command to upload user-defined master encryption keys to Oracle Key Vault.
- [Step 2: Activate the User-Defined Key as a TDE Master Encryption Key](#)
After you upload the user-defined key, you are ready to activate the key as a TDE master encryption key.

11.6.1 About Using a User-Defined Key as the TDE Master Encryption Key

Users who have the Key Administrator role can upload a user-defined key to the virtual wallet to which they have write access.

This enables it so that it can be used as the Transparent Data Encryption (TDE) master encryption key. This feature provides key administrators with more control on creation of the master encryption key used to encrypt TDE data encryption keys.

The `type` parameter of the `okvutil upload` command includes the option `TDE_KEY_BYTES`, which enables you to upload user-defined key bytes to Oracle Key Vault to be used as the TDE master encryption key. You must then activate the key as a TDE master encryption key by running the `ADMINISTER KEY MANAGEMENT SQL` statement on the database.

Related Topics

- *Oracle Database Advanced Security Guide*

11.6.2 Step 1: Upload the User-Defined Key

Use the `okvutil upload` command to upload user-defined master encryption keys to Oracle Key Vault.

The raw bytes data of the user-defined key is stored in a text file and uploaded to Oracle Key Vault.

The raw bytes data uploaded to Oracle Key Vault forms part of the `TDE Master Key` and the `TDE Master Key Identifier`. Additional metadata is added to the raw bytes data to enable the database to identify and activate the data as the `TDE Master Key` and the `TDE Master Key Identifier`. In the text file, the raw bytes data that forms the `TDE Master Key` is prefixed by `TDE Master Key`. The raw bytes data that forms the `TDE Master Key Identifier` is prefixed by `TDE Master Key Identifier`. `TDE Master Key Identifier` represents the master encryption key in the database. Once the key is activated, you should see the user-defined raw bytes that form the `TDE Master Key Identifier` as the subset of the `KEY_ID` column of the `V$ENCRYPTION_KEYS` view. In Oracle Key Vault, the `TDE Master Key` and `TDE Master Key Identifier` values are stored as managed KMIP objects with a symmetric key as a KMIP object type.

1. Create a text file containing the raw bytes data of the user-defined key.

Use the following format:

```
TDE Master Encryption Key Identifier:  
contiguous_TDE_Master_Encryption_Key_Identifier_bytes_encoded_in_32_  
hex_characters_(16_bytes_long)  
TDE Master Encryption Key:  
contiguous_TDE_Master_Encryption_Key_bytes_encoded_in_64_hex_charact  
ers_(32_bytes_long)
```

For example:

```
TDE Master Encryption Key Identifier: 1F1E1D1C1B1A10191817161514131210
TDE Master Encryption Key:
000102030405060708090A0B0C0D0E0F101112131415161718191A1B1C1D1E1F
```

2. Save the file as `tde_key_bytes.txt`.
3. Use the `okvutil upload` command to upload `tde_key_bytes.txt`.

The format of the `okvutil upload` command is:

```
okvutil upload [--overwrite] --location location --type type [--group
group] [--
description description] [--verbose verbosity_level]
```

Example:

```
$OKV_HOME/bin/okvutil upload -l /home/oracle/tde_key_bytes.txt -t
TDE_KEY_BYTES -g "FIN_DATABASE_VIRTUAL_WALLET" -d "This key was created
for Financial database use on 1st Mar 2019"
```

In this example:

- `-l` specifies the path to the `tde_key_bytes.txt` file.
- `-t` specifies the type of the object to upload. To upload a user-defined key, specify the type as `TDE_KEY_BYTES`.
- `-g` specifies the name of an Oracle Key Vault virtual wallet to which the key is added.
- `-d` specifies a description for the key.

When `-t` is `TDE_KEY_BYTES`, the description specified for `-d` is displayed as the tag in the `V$ENCRYPTION_KEYS` dynamic view.

4. Specify the required parameters and then press **Enter**.
5. Enter the Oracle Key Vault endpoint password and press **Enter**.

The message `Upload succeeded` is displayed.

```
$OKV_HOME/bin/okvutil upload -l /home/oracle/tde_key_bytes.txt -t
TDE_KEY_BYTES -g "FIN_DATABASE_VIRTUAL_WALLET" -d "This key was created
for Financial database use on 1st Mar 2019"
Enter Oracle Key Vault endpoint password:
Upload succeeded
```

The raw bytes data of the user-defined key is uploaded. The next step is to activate the user-defined key as a TDE master encryption key.

Related Topics

- [Step 2: Activate the User-Defined Key as a TDE Master Encryption Key](#)
After you upload the user-defined key, you are ready to activate the key as a TDE master encryption key.

11.6.3 Step 2: Activate the User-Defined Key as a TDE Master Encryption Key

After you upload the user-defined key, you are ready to activate the key as a TDE master encryption key.

The raw bytes data uploaded to Oracle Key Vault for the `TDE Master Key Identifier` is displayed as the `NAME` attribute of the KMIP object that is created as the corresponding TDE master encryption key in Oracle Key Vault.

1. Log in to the Oracle Key Vault management console as a user with the Key Administrator role or as a user with access to the virtual wallet.
2. Select the **Keys & Wallets** tab, then **Keys & Secrets** in the left navigation bar.
3. In the Object Details page, expand **Advanced**.

The required Key ID is displayed in the Names area. The Key ID is prefixed with `ORACLE.TDE.HSM.MK.`

For example:

```
ORACLE.TDE.HSM.MK.1F1E1D1C1B1A10191817161514131210
```

The TDE master encryption key identifiers contain the user defined raw bytes data prefixed by additional metadata.

4. Copy and store the key ID displayed after the prefix `ORACLE.TDE.HSM.MK`

For example:

```
1F1E1D1C1B1A10191817161514131210
```

5. Connect to the Oracle database as a user who has privileges to run the `ADMINISTER KEY MANAGEMENT SQL` statement.

For example:

```
sqlplus / as sysdba
```

6. Activate the key as a TDE master encryption key using the `ADMINISTER KEY MANAGEMENT` command.

```
ADMINISTER KEY MANAGEMENT USE KEY  
'1F1E1D1C1B1A10191817161514131210' IDENTIFIED BY "password";
```

You can query the `TAG` column of the `V$ENCRYPTION_KEYS` view for the identifier of the newly created key.

12

Managing Oracle Key Vault Endpoints

Oracle Key Vault endpoints are computer systems like database or application servers, where keys and credentials are used to access data.

- [Overview of Managing Endpoints](#)
You can manage endpoints in both standalone environments and multi-master clusters in mostly the same way, except that multi-master clusters have more restrictions.
- [Managing Endpoints](#)
You can enroll, reenroll, suspend, and delete endpoints.
- [Managing Endpoint Details](#)
Endpoint details refers to endpoint name, type, description, platform, and email, and adding the endpoint to a group, or upgrading the endpoint software.
- [Default Wallets and Endpoints](#)
You can use a default wallet, which is a type of virtual wallet, with an endpoint.
- [Managing Endpoint Access to a Virtual Wallet](#)
You can grant an endpoint access to a virtual wallet, and revoke or modify access when it is no longer necessary.
- [Managing Endpoint Groups](#)
An endpoint group is a named group of endpoints that share a common set of wallets.

12.1 Overview of Managing Endpoints

You can manage endpoints in both standalone environments and multi-master clusters in mostly the same way, except that multi-master clusters have more restrictions.

- [About Managing Endpoints](#)
You must register and enroll an endpoint to communicate with an Oracle Key Vault server.
- [How a Multi-Master Cluster Affects Endpoints](#)
You should be aware of how a multi-master cluster affects endpoints, both in the way an endpoint connects to it and with restrictions.

12.1.1 About Managing Endpoints

You must register and enroll an endpoint to communicate with an Oracle Key Vault server.

Afterward, keys in the endpoint can be uploaded to Oracle Key Vault and be shared with other endpoints and then downloaded from these endpoints so that users can access their data. Only a user with the System Administrator role or the Create Endpoint privilege can add an endpoint to Oracle Key Vault. After the endpoint is added, the endpoint administrator can enroll the endpoint by downloading and installing the endpoint software at the endpoint. The endpoint can then use the utilities packaged with the endpoint software to upload and download security objects to and from Oracle Key Vault.

All users can create virtual wallets but only a user with the Key Administrator role can grant endpoints access to security objects contained in virtual wallets. A Key Administrator user can grant access to any wallet in an endpoint. A user with the Key Administrator role or Create Endpoint Group privilege can also create endpoint groups to enable shared access to virtual wallets. Any user (including users who created the endpoint) who has the manage wallet permission on a wallet can grant access to that wallet to an endpoint. When you grant an endpoint group access to a virtual wallet, all the member endpoints will have access to the virtual wallet. For example, you can grant all the nodes in an Oracle Real Application Clusters (Oracle RAC) database access to a virtual wallet by putting them in an endpoint group. This saves you the step of granting each node access to the virtual wallet.

If you have a large deployment, Oracle recommends that you install at least four Oracle Key Vault servers, and when you enroll the endpoints, balance them across these four servers to ensure high availability. For example, if a data center has 1000 database endpoints to register, and you have four Oracle Key Vault servers to accommodate them, then enroll 250 endpoints across each of the four servers.

When you name an endpoint, you cannot use an Oracle Key Vault server user name as the endpoint name.

The administrative roles and privileges as they pertain to endpoints are as follows:

- **Endpoint creation:** A user with the System Administrator role can create endpoints anywhere in the Oracle Key Vault system. A user with the Create Endpoint privilege can create only their own endpoints.
- **Endpoint management:** A user with the System Administrator role can manage endpoints anywhere in the Oracle Key Vault system. A user with the Manage Endpoint privilege can manage only his or her own endpoints. This includes endpoints that the user was explicitly granted the Manage Endpoint privilege on, or endpoints that the user created and continues to have the Manage Endpoint privileges on. This management includes the following duties:
 - Managing the endpoint metadata such as the name, type, platform, description, and email notifications
 - Managing the endpoint life cycle, which consists of enrolling, suspending, reenrolling, and deleting endpoints
- **Endpoint group creation:** A user with the Key Administrator role can create endpoint groups anywhere in the Oracle Key Vault system. A user with the Create Endpoint Group privilege can only create his or her own endpoint groups.
- **Endpoint group management:** A user with the Key Administrator role can manage endpoint groups anywhere in the Oracle Key Vault system. A user with the Manage Endpoint Group privilege can manage only his or her own endpoint groups. The endpoint groups that a user can manage include those that the user was explicitly granted the Manage Endpoint Group privilege on, or those that the user created and continues to have the Manage Endpoint Group privilege on. This management includes the following duties:
 - Managing the endpoint group lifecycle, which consists of creating, modifying, and deleting endpoint groups
 - Managing the life cycle of security objects, which consists of creating, modifying and deleting security objects

Related Topics

- [Endpoint Privileges](#)
Oracle Key Vault provides privileges for creating and managing endpoints and endpoint groups.

12.1.2 How a Multi-Master Cluster Affects Endpoints

You should be aware of how a multi-master cluster affects endpoints, both in the way an endpoint connects to it and with restrictions.

In a multi-master configuration, when an endpoint attempts to make a connection to Oracle Key Vault, it performs the following actions:

- First, it obtains the list of server IPs from its configuration file (`okvclient.ora`).
- Next, it picks one at random, preferentially from those in the same cluster subgroup as the endpoint.

Be aware of the following restrictions with how endpoints work in multi-master clusters:

- An endpoint can only be enrolled from the same node where it was most recently created or reenrolled.
- You cannot assign a default wallet to an endpoint if one or both of them (wallet and endpoint) is in the `PENDING` state and if the assignment is attempted from a non-creator node. After both the endpoint and wallet are in the `ACTIVE` state, this restriction ends.

12.2 Managing Endpoints

You can enroll, reenroll, suspend, and delete endpoints.

- [Types of Endpoint Enrollment](#)
The first step in enrolling an endpoint is to add the endpoint to Oracle Key Vault.
- [Endpoint Enrollment in a Multi-Master Cluster](#)
Endpoints of a cluster are the client systems of the multi-master cluster.
- [Adding an Endpoint as an Oracle Key Vault System Administrator or Create Endpoint User](#)
A user who has been granted the System Administrator role or the Create Endpoint privilege can add an endpoint by using the **Endpoints** tab.
- [Adding Endpoints Using Self-Enrollment](#)
The self-enrollment process immediately sends the endpoint to the **Enrolled** status without the intermediate **Registered** status.
- [Deleting, Suspending, or Reenrolling Endpoints](#)
When endpoints no longer use Oracle Key Vault to store security objects, you can delete them, and then reenroll when they are needed.

12.2.1 Types of Endpoint Enrollment

The first step in enrolling an endpoint is to add the endpoint to Oracle Key Vault.

There are two methods for adding, also known as registering, an endpoint:

- Initiated by an administrator

An Oracle Key Vault user who has the System Administrator role initiates the enrollment from the Oracle Key Vault side by adding the endpoint to Oracle Key Vault. When the endpoint is added, a one-time enrollment token is generated. This token can be communicated to the endpoint administrator in two ways:

- Directly from Oracle Key Vault by email. To use email notification you must configure SMTP in email settings.
- Out-of-band method, such as email or telephone.

The endpoint administrator uses the enrollment token to download the endpoint software and complete the enrollment process. In a multi-master cluster, the same node that is used to add the endpoint must be used to enroll the endpoint.

After the enrollment token is used to enroll an endpoint, it cannot be used again for another enrollment. If you are reenrolling an endpoint, then the reenrollment process will generate a new one-time enrollment token for this purpose.

- **Self-enrolled**

Endpoints may enroll themselves during specific times without human administrative intervention. Endpoint self-enrollment is useful when the endpoints do not share [security objects](#), and use Oracle Key Vault primarily to store and restore their own security objects. Another use for endpoint self-enrollment is testing.

A self-enrolled endpoint is created with a generic endpoint name in this format: `ENDPT_001`. In a cluster, a self-enrolled endpoint is created with a generic endpoint name in this format: `ENDPT_XX_001`, where `XX` is a 2-digit node identifier or node number. Initially, a self-enrolled endpoint has access only to the security objects that it uploads or creates. It does not have access to any virtual wallets. You can later grant the endpoint access to virtual wallets after verifying its identity.

Endpoint self-enrollment is disabled by default, and must be enabled by a user with the System Administrator role. Oracle recommends that you enable self-enrollment for short periods, when you expect endpoints to self enroll, and then disable it when the self-enrollment period ends.

Related Topics

- [Configuring Email Notification](#)

You can use email notifications to directly notify administrators of Key Vault status changes without logging into the Oracle Key Vault management console.

12.2.2 Endpoint Enrollment in a Multi-Master Cluster

Endpoints of a cluster are the client systems of the multi-master cluster.

Endpoint enrollment is divided into two steps. First you create the endpoint and then you enroll it.

The Oracle Key Vault server that becomes the initial node can have endpoints already enrolled, especially if it was upgraded from a previous release. These existing endpoints initialize, or seed, the cluster. During induction, information about the endpoints that were enrolled in the cluster is replicated to the newly added node. Oracle Key Vault also removes information about the endpoints that were previously enrolled in all candidate nodes added to the cluster.

Endpoints can only be enrolled on a read-write node.

After you enroll the endpoint, the new endpoint will have a cluster-wide presence. You can add endpoints of the Oracle Key Vault multi-master cluster to any read-write node.



Note:

An endpoint must be enrolled on the same node where it was most recently added or reenrolled.

New endpoints added concurrently to the multi-master cluster on different nodes could have name conflicts. Oracle Key Vault automatically resolves the endpoint name conflicts, and then displays the conflicts in a Conflicts Resolution page. From here, a system administrator can choose to rename them.

Related Topics

- [Naming Conflicts and Resolution](#)
Oracle Key Vault can resolve naming conflicts that can arise as users create objects such as endpoints, endpoint groups, and user groups.

12.2.3 Adding an Endpoint as an Oracle Key Vault System Administrator or Create Endpoint User

A user who has been granted the System Administrator role or the Create Endpoint privilege can add an endpoint by using the **Endpoints** tab.

1. Log in to the Oracle Key Vault management console as a user who has the System Administrator role or the Create Endpoint privilege.
2. Select the **Endpoints** tab, then **Endpoints** in the left navigation bar.

The Endpoints page appears listing all the Oracle Key Vault endpoints.

<input type="checkbox"/>	Endpoint Name	Name Status	Status	Enrollment Token	Type	Platform	Default Wallet	IP Address	Description
<input type="checkbox"/>	LONDON_ENCRYPTED_FILE_SYSTEM	ACTIVE	REGISTERED	kqqr0xOGpOULcdv	Oracle ACFS	Linux	ASM_Cluster_File_System_Wallet		system managing the DB executables for LONDON server
<input type="checkbox"/>	XYZAPP_WEBAPP_MYSQL	ACTIVE	ENROLLED	-	MySQL Database	Linux	XYZ_MYSQL_WALLET	192.0.2.125	MySQL database managing the XYZ web application data
<input type="checkbox"/>	APPABC_DR_OGG	ACTIVE	ENROLLED	-	Oracle (non-database)	Linux	GoldenGate_Replication_App_Wallet	192.0.2.125	Disaster Recovery Replication site for ABC Application.
<input type="checkbox"/>	APPABC_PRIMARY_OGG	ACTIVE	ENROLLED	-	Oracle (non-database)	Linux	GoldenGate_Replication_App_Wallet	192.0.2.125	Primary Replication site for ABC Application.

The Endpoints page displays the list of registered and enrolled endpoints with the following endpoint details: name, type, description, platform, status, enrollment token, and alert. This listing of endpoints depends on who is logged in. For a user with the System Administrator role, all the endpoints will be listed. For a user with the Create

Endpoint privilege, only endpoints to which the user has access will appear. The buttons listed above the table also depend on the user's role or privilege status. The endpoint status can be either **Registered** or **Enrolled**:

- **Registered Status:** The endpoint has been added and the one-time enrollment token has been generated. This token will be displayed in the corresponding Enrollment Token column.
 - **Enrolled Status:** The one-time enrollment token has been used to download the endpoint software. The Enrollment Token column displays a dash (-) to indicate that the enrollment token has been used. If you do not have the System Administrator role (that is, you have the Manage Endpoint privilege), then you can only view enrollment tokens for those endpoints that the you can manage.
 - **Created By:** The user who created the endpoint. If the user no longer exists, or if the endpoint was created in a version before this information was stored, then this field will show ANONYMOUS.
 - **Creator Node:** The node on which the endpoint was created.
 - **Name Status:** The state of the endpoint. The state will be either ACTIVE or PENDING.
3. On the Endpoints page, click **Add**.

The Register Endpoint page appears. The **Make Unique** check box only appears in multi-master clusters mode.

The screenshot shows the 'Register Endpoint' form with the following fields and options:

- Endpoint Name ***: A text input field with a 'Make Unique' checkbox and a help icon to its right.
- Type ***: A dropdown menu currently set to 'Oracle Database'.
- Platform ***: A dropdown menu currently set to 'Linux'.
- Description**: A large text area for entering details.
- Administrator Email**: A text input field.
- Cluster Subgroup ***: A dropdown menu currently set to 'austin (from Creator Node)'.

Buttons for 'Cancel' and 'Register' are located in the top right corner of the form.

4. In the **Endpoint Name** field, enter a name for the endpoint. See [Naming Guidelines for Objects](#).
5. If you are using a multi-master cluster, then choose whether to select the **Make Unique** checkbox.

Make Unique helps to control naming conflicts with names across the multi-master cluster environment. Endpoints that were created before an Oracle Key Vault conversion to a cluster node are not affected by naming conflicts.

- If you select **Make Unique**, then the endpoint will be active immediately and users can use this endpoint.

- If you do not select **Make Unique**, then the endpoint will be created in the `PENDING` state. Oracle Key Vault will then begin a name resolution operation and may rename the endpoint to a name that is unique across the cluster. If there is a naming collision, then the collision will be reported on the Conflicts page on any node in the cluster. The endpoint will then be renamed to a unique name. You will need to go to a read-write node of the cluster and either accept the renamed endpoint or change the endpoint name. If you change the endpoint name, then this will restart the name resolution operation and the endpoint will return to a `PENDING` state. An endpoint in the `PENDING` state cannot be used to perform most operations.
- From the **Type** drop-down list, select the type of endpoint.
Supported types are **Oracle Database**, **Oracle Database Cloud Service**, **Oracle (non-database)**, **Oracle ACFS**, **MySQL Database**, and **Other**. An example of **Other** is a third-party KMIP endpoint. If you are using Oracle Advanced Security Transparent Data Encryption (TDE) and want to use Oracle Key Vault to manage a TDE master encryption key or wallet, then you must set **Type** to **Oracle Database**.
 - Complete the following endpoint information:
 - Platform:** Supported platform choices are **Linux**, **Solaris SPARC**, **Solaris x64**, **AIX**, **HP-UX**, and **Windows**.
 - Description:** Optionally, enter a useful identifying description such as the host name, IP address, function, or location of the endpoint.
 - Administrator Email:** Optionally, enter the email address of the endpoint administrator to have the enrollment token and other endpoint-related alerts sent directly from Oracle Key Vault. You must have SMTP configured to use the email notification feature.
 - Cluster Subgroup:** For a multi-master cluster environment, select a subgroup for the endpoint. If you select **No Cluster Subgroup**, then the endpoint will not be a part of any cluster subgroup. If you select the option suffixed with **(from Creator Node)**, the endpoint will be a part of the cluster subgroup to which its creator node belongs, even if the creator node's cluster subgroup changes. All other options assign an endpoint to an existing cluster subgroup, to which it will belong regardless of its creator node's cluster subgroup.
 - Click **Register**.

The Endpoints page appears listing the new endpoint with a status of **Registered**. The Enrollment Token column displays the one-time enrollment token.

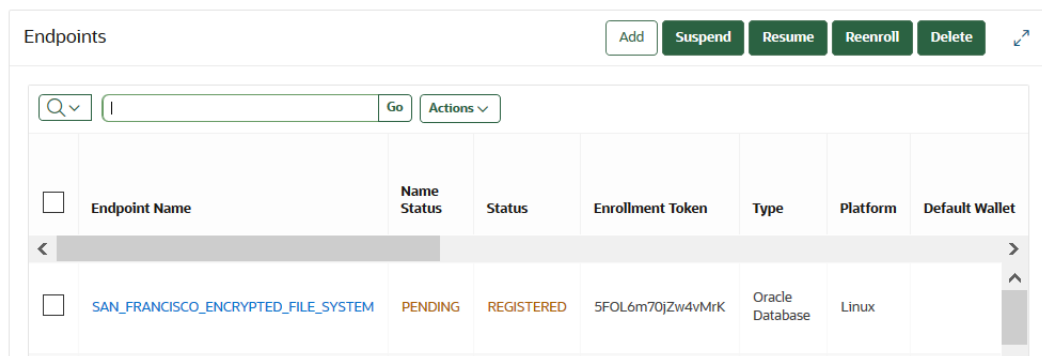

The screenshot shows the 'Endpoints' management console. At the top right, there are buttons for 'Add', 'Suspend', 'Resume', 'Reenroll', and 'Delete'. Below these is a search bar with a magnifying glass icon, a text input field containing 'I', and buttons for 'Go' and 'Actions'. The main area contains a table with the following columns: Endpoint Name, Name Status, Status, Enrollment Token, Type, Platform, and Default Wallet. One endpoint is listed with the name 'SAN_FRANCISCO_ENCRYPTED_FILE_SYSTEM', a 'PENDING' name status, a 'REGISTERED' overall status, an enrollment token '5FOL6m70jZw4vMrK', and is of type 'Oracle Database' on a 'Linux' platform.

<input type="checkbox"/>	Endpoint Name	Name Status	Status	Enrollment Token	Type	Platform	Default Wallet
<input type="checkbox"/>	SAN_FRANCISCO_ENCRYPTED_FILE_SYSTEM	PENDING	REGISTERED	5FOL6m70jZw4vMrK	Oracle Database	Linux	

- If you had logged in as a user with the Create Endpoint privilege, and if this is the first endpoint that you have registered, then log out of the Oracle Key Vault management console and log back in again.

Logging out and in again makes the full set of privileges for this endpoint available to you. After you log in, click the **Endpoints** tab, and then **Endpoints** in the left navigation window to access the Endpoints page.

- Click the endpoint name to see details for the endpoint.

The Endpoint Details page appears.

The screenshot shows the 'Endpoint Details' form. At the top right, there are four buttons: 'Cancel', 'Send Enrollment Token', 'Delete', and 'Save'. The form fields are as follows:

- Endpoint Name:** SAN_FRANCISCO_ENCRYPTED_FILE_SYSTEM. There is a 'Make Unique' checkbox and a help icon.
- Type:** Oracle Database (dropdown menu).
- Description:** HQ employees at Spear Street office (text area).
- Platform:** Linux (dropdown menu).
- Administrator Email:** sec_admin@example.com (text input).
- Status:** REGISTERED (text).
- Creation Time:** 04-DEC-2020 13:29:16 (text).
- Certificate Expiration Time:** 04-DEC-2022 13:29:16 (text).
- Self Enrolled:** No (text).
- Cluster Subgroup:** boston (dropdown menu).

The **Send Enrollment Token** button on the Endpoint Details page *only* appears for an endpoint whose **Status** is **Registered**. (If you are not a user with the System Administrator role, then you cannot view the enrollment token or the **Send Enrollment Token** button. If you have the Manage Endpoint privilege, then you can only view the token and have access to the **Send Enrollment Token** button.)

There are two ways to send the one-time enrollment token to the endpoint administrator:

- If you did configure SMTP and entered the email address, you can have Oracle Key Vault send the enrollment token directly to the endpoint administrator, shown in the next step, where you click the **Send Enrollment Token** button.
- If you did not configure SMTP or enter the email address, then you must use an out-of-band method to send the enrollment token to the endpoint administrator.

The endpoint must be enrolled and the endpoint jar file must be downloaded from the node on which the endpoint was most recently created or reenrolled.

- Click **Send Enrollment Token**.

At this stage, the endpoint's administrator can complete the enrollment process for the endpoint. When the enrollment token is used to download and install the endpoint software on the endpoint side, the endpoint status changes from **Registered** to **Enrolled**.

Related Topics

- [Configuring Email Notification](#)
You can use email notifications to directly notify administrators of Key Vault status changes without logging into the Oracle Key Vault management console.
- [Step 1: Enroll the Endpoint and Download the Software](#)
You must have the endpoint's enrollment token before you can download the endpoint software `okvclient.jar`.

12.2.4 Adding Endpoints Using Self-Enrollment

The self-enrollment process immediately sends the endpoint to the **Enrolled** status without the intermediate **Registered** status.

- [About Adding Endpoints Using Self-Enrollment](#)
Oracle Key Vault associates a self-enrolled attribute with all endpoints that are enrolled through endpoint self-enrollment.
- [Adding an Endpoint Using Self-Enrollment](#)
You can configure the self-enrollment process for endpoints from the Oracle Key Vault management console.

12.2.4.1 About Adding Endpoints Using Self-Enrollment

Oracle Key Vault associates a self-enrolled attribute with all endpoints that are enrolled through endpoint self-enrollment.

Self-enrolled endpoints go directly to **Enrolled** status without the intermediate **Registered** status when a user downloads the endpoint software. You can recognize self-enrolled endpoints by their system generated names in the format `ENDPT_001`. In a multi-master cluster, system generated endpoint names are in the format `ENDPT_node_id_sequential_number`, where `node_id` is a value such as `01` or `02`. For example, `ENDPT_01_001` can be the generated name of an endpoint.

Endpoint self-enrollment is disabled by default and must be enabled by a user who has the System Administrator role.

A best practice is to enable endpoint self-enrollment for limited periods when you expect endpoints to enroll. After the expected endpoints have been enrolled, you should disable endpoint self-enrollment.

12.2.4.2 Adding an Endpoint Using Self-Enrollment

You can configure the self-enrollment process for endpoints from the Oracle Key Vault management console.

1. Log in to the Oracle Key Vault management console as a user who has the System Administrator role.
2. Select the **Endpoints** tab, and then **Settings** from the left navigation bar.

The Endpoint Settings page appears.

Endpoint Settings
Save

Allow Endpoint Self Enrollment

Global Endpoint Configuration Parameters
Save Defaults
Save

Endpoint Certificate Validity (in days)

PKCS11 In-Memory Cache Timeout (in minutes)

PKCS11 Persistent Cache Timeout (in minutes)

PKCS11 Persistent Cache Refresh Window (in minutes)

PKCS11 Configuration Parameter Refresh Interval (in minutes)

Server Poll Timeout (in milliseconds)

PKCS11 Trace Directory Path

Expire PKCS11 Persistent Cache on Database Shutdown ?

3. Check the box to the right of **Allow Endpoint Self-Enrollment**.
4. Click **Save**.

Related Topics

- [Step 1: Enroll the Endpoint and Download the Software](#)
You must have the endpoint's enrollment token before you can download the endpoint software `okvclient.jar`.

12.2.5 Deleting, Suspending, or Reenrolling Endpoints

When endpoints no longer use Oracle Key Vault to store security objects, you can delete them, and then reenroll when they are needed.

- [About Deleting Endpoints](#)
Deleting an endpoint removes it permanently from Oracle Key Vault.
- [Deleting One or More Endpoints](#)
The Endpoints page enables you to delete a group of endpoints from Oracle Key Vault at one time.
- [Deleting One Endpoint \(Alternative Method\)](#)
The Endpoint Details page provides a consolidated view for the selected endpoint including a mechanism to delete the endpoint from Oracle Key Vault.
- [Suspending an Endpoint](#)
You can suspend an endpoint temporarily for security reasons, and then reinstate the endpoint once the threat has passed.
- [Reenrolling an Endpoint](#)
When you reenroll an endpoint, the enrollment process automatically upgrades the endpoint software.

12.2.5.1 About Deleting Endpoints

Deleting an endpoint removes it permanently from Oracle Key Vault.

However, [security objects](#) that were previously created or uploaded by that endpoint will remain in Oracle Key Vault. Similarly, security objects that are associated with that endpoint also remain. To permanently delete or reassign these security objects, you must be a user with the Key Administrator role or authorized to merge these objects by managing wallet privileges. The endpoint software previously downloaded at the endpoint also remains on the endpoint until the endpoint administrator removes it.

You cannot delete an endpoint that is in the `PENDING` state unless you are the user who created it. You must delete it on the node on which it was created.

12.2.5.2 Deleting One or More Endpoints

The Endpoints page enables you to delete a group of endpoints from Oracle Key Vault at one time.

You can also delete a single endpoint from this page.

1. Log in to the Oracle Key Vault management console as a user who has the System Administrator role or the Manage Endpoint privilege on that endpoint.

A user who has the Manage Endpoint privilege can only delete endpoints on which this user has been granted the Manage Endpoint privilege. To see which endpoints that a user can manage, select the **Users** tab, then select **Manage Users**. Check the User Details page for the user in question, and scroll down to the Access to Endpoints area.

2. Select the **Endpoints** tab, then **Endpoints** in the left navigation bar.

The Endpoints page lists all the endpoints currently registered or enrolled.

3. In the Endpoints page, select the check boxes to the left of the endpoints that you want to delete.
4. Click **Delete**.
5. In the confirmation window, click **OK**.

Related Topics

-

12.2.5.3 Deleting One Endpoint (Alternative Method)

The Endpoint Details page provides a consolidated view for the selected endpoint including a mechanism to delete the endpoint from Oracle Key Vault.

1. Log in to the Oracle Key Vault management console as a user who has the System Administrator role or the Manage Endpoint privilege on that endpoint.

A user who has the Manage Endpoint privilege can only delete endpoints on which this user has been granted the Manage Endpoint privilege. To see which endpoints that a user can manage, select the **Users** tab, then select **Manage Users**. Check the User Details page for the user in question, and scroll down to the Access to Endpoints area.

2. Select the **Endpoints** tab, then **Endpoints** in the left navigation bar.

The Endpoints page appears listing all the Oracle Key Vault endpoints.

3. Click the endpoint name that you want to delete.

The Endpoint Details page appears.

4. Click **Delete**.

5. In the confirmation window, click **OK**.

Related Topics

-

12.2.5.4 Suspending an Endpoint

You can suspend an endpoint temporarily for security reasons, and then reinstate the endpoint once the threat has passed.

When you suspend an endpoint, its status will change from **Enrolled** to **Suspended**. You cannot suspend an endpoint that is in the `PENDING` state unless you are the user who created it.

1. Log in to the Oracle Key Vault management console as a user who has the System Administrator role or the Manage Endpoint privilege.
A user who has the Manage Endpoint privilege can only suspend endpoints that he or she created.
2. Select the **Endpoints** tab, then **Endpoints** in the left navigation bar.
The Endpoints page appears listing all the Oracle Key Vault endpoints.
3. In the Endpoints page, select the check boxes to the left of the endpoints that you want to suspend.
4. Click **Suspend**.
5. In the confirmation window, click **OK**.

When you suspend an endpoint, its **Status** on the **Endpoints** page will be **Suspended**.

6. To enable the endpoint, perform Steps 1-3.

From the Endpoint Details pane click **Enable**. The endpoint **Status** on the **Endpoints** page will now read **Enrolled**.

The following rules apply to suspending an endpoint in a multi-master cluster:

- For regular endpoints, the endpoint will continue to operate until all suspend operation requests have reached all nodes in the cluster.
- You can suspend the endpoint on any node.
- For cloud-based endpoints, the endpoint will continue to operate until the suspend operation has reached all nodes from where the reverse SSH tunnel is established.
- You can potentially suspend the endpoint on any node from the cloud-based endpoint from where the reverse SSH tunnel is established.

Related Topics

-

12.2.5.5 Reenrolling an Endpoint

When you reenroll an endpoint, the enrollment process automatically upgrades the endpoint software.

You must also reenroll an endpoint to accommodate changes such as pairing a primary Oracle Key Vault server with a new secondary server in a primary-standby configuration. The action of reenrolling an endpoint will immediately disallow any connections from the endpoint's old deployment. If you are reenrolling an endpoint, Oracle recommends that you immediately download `okvclient.jar` and deploy it in a directory that is separate from the existing deployment. When you deploy the software, use the `-o` option to overwrite the symbolic link pointing to the old `okvclient.ora`. You cannot reenroll an endpoint that is in the `PENDING` state unless you are the user who created the endpoint.

1. Log in to the Oracle Key Vault management console as a user who has the System Administrator role or the Manage Endpoint privilege.

A user who has the Manage Endpoint privilege can only reenroll endpoints that he or she created.

2. Select the **Endpoints** tab, then **Endpoints** in the left navigation bar.

The Endpoints page appears listing all the Oracle Key Vault endpoints.

3. In the Endpoints page, check the boxes to the left of the endpoints that you want to reenroll.
4. Click **Reenroll**.

After you deploy the `okvclient.jar` file, the The endpoint software for Oracle Key Vault installed successfully message should appear. If instead the The endpoint software for Oracle Key Vault upgraded successfully message appears, then the reenrollment was performed in the old deployment directory, and as a result, the endpoint software was upgraded but not successfully reenrolled.

You can overwrite the symbolic link reference that points to `okvclient.ora` in the new directory by using the `okvclient.jar` option `-o`.

A new enrollment token will be generated for each reenrolled endpoint and appear in the corresponding Enrollment Token column. You can use this one-time token to reenroll the endpoint. You must download the endpoint jar file from the same node on which the endpoint was reenrolled.

Related Topics

- [Step 1: Enroll the Endpoint and Download the Software](#)
You must have the endpoint's enrollment token before you can download the endpoint software `okvclient.jar`.

12.3 Managing Endpoint Details

Endpoint details refers to endpoint name, type, description, platform, and email, and adding the endpoint to a group, or upgrading the endpoint software.

- [About Endpoint Details](#)
The Endpoint Details page provides a consolidated view of the endpoint.
- [Modifying Endpoint Details](#)
You can modify the endpoint name, endpoint type, description, platform, and email.

- [Global Endpoint Configuration Parameters](#)
Oracle Key Vault provides endpoint-specific configuration parameters that you can set in the Oracle Key Vault management console.
- [Modifying Configuration Parameters for an Individual Endpoint](#)
A user who has the System Administrator role or the Manage Endpoint privilege can set configuration parameters for individual endpoints.

12.3.1 About Endpoint Details

The Endpoint Details page provides a consolidated view of the endpoint.

To access this page, you can select the **Endpoints** tab and then click the name of an endpoint. From here you can modify endpoint details and complete endpoint management tasks. (The following screen shows a partial view.)

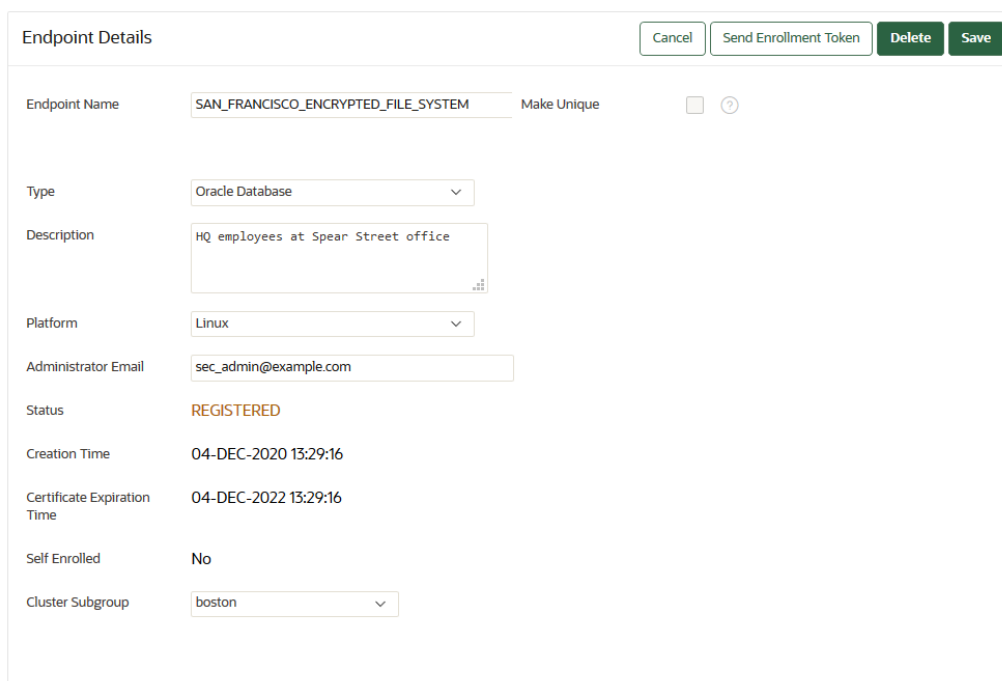

Endpoint Details		Cancel	Send Enrollment Token	Delete	Save
Endpoint Name	SAN_FRANCISCO_ENCRYPTED_FILE_SYSTEM	Make Unique	<input type="checkbox"/>	<input type="text"/>	
Type	Oracle Database				
Description	HQ employees at Spear Street office				
Platform	Linux				
Administrator Email	sec_admin@example.com				
Status	REGISTERED				
Creation Time	04-DEC-2020 13:29:16				
Certificate Expiration Time	04-DEC-2022 13:29:16				
Self Enrolled	No				
Cluster Subgroup	boston				

12.3.2 Modifying Endpoint Details

You can modify the endpoint name, endpoint type, description, platform, and email.

In a multi-master cluster, endpoint details can only be modified while the endpoint is in the `PENDING` state by the creator on the node on which it was created.

1. Log in to the Oracle Key Vault management console as a user who has the System Administrator role or the Manage Endpoint privilege.

A user who has the Manage Endpoint privilege can only modify endpoints that this user has created. To see which endpoints that a user can manage, select the **Users** tab, then select **Manage Users**. Check the User Details page for the user in question, and scroll down to the Access to Endpoints area.
2. Select the **Endpoints** tab, then **Endpoints** in the left navigation bar.

The Endpoints page appears listing all the Oracle Key Vault endpoints.

3. In the Endpoints page, click the name of the endpoint.

The Endpoint Details page appears.

The screenshot shows the 'Endpoint Details' form with the following fields and values:

- Endpoint Name: EPI
- Type: Oracle Database
- Description: (empty)
- Platform: Linux
- Administrator Email: (empty)
- Status: REGISTERED
- Creation Time: 07-JAN-2021 17:27:50
- Certificate Expiration Time: 07-JAN-2023 17:27:50
- Self Enrolled: No
- Cluster Subgroup: Group1 (from Creator Node)
- Strict IP Check:

4. In the Endpoint Details page, modify any of the following: **Endpoint Name**, **Type**, **Description**, **Platform**, **Administrator Email**, **Cluster Subgroup** (for multi-master cluster environments only), or **Strict IP Check**.

The **Strict IP Check** setting is enabled by default for any endpoint that was created in Oracle Key Vault. If you select this check box, then Oracle Key Vault checks if the endpoint is connecting to it using the same IP that was used when the endpoint software was first deployed. If you disable this check box, then Oracle Key Vault allows the endpoint to connect to it using any IP address. Oracle recommends that you enable this setting unless otherwise required.

See [Naming Guidelines for Objects](#).

5. Click **Save**.

12.3.3 Global Endpoint Configuration Parameters

Oracle Key Vault provides endpoint-specific configuration parameters that you can set in the Oracle Key Vault management console.

- [About Global Endpoint Configuration Parameters](#)
Users who have the System Administrator role can centrally update certain endpoint configuration parameters in the Oracle Key Vault management console.
- [Setting Global Endpoint Configuration Parameters](#)
You can set global endpoint configuration parameters in the Oracle Key Vault management console.

12.3.3.1 About Global Endpoint Configuration Parameters

Users who have the System Administrator role can centrally update certain endpoint configuration parameters in the Oracle Key Vault management console.

This feature enables system administrators to set certain endpoint configuration parameters globally, that is, for all endpoints, or on a per-endpoint basis. It simplifies the process of managing multiple endpoints for system administrators.

Endpoint-specific parameters take precedence over global parameters. Global parameters take effect when endpoint-specific parameters are cleared. Oracle Key Vault uses the default

system parameters if both global and endpoint specific parameters are cleared or not set from Oracle Key Vault management console.

The configuration parameter values set in the Oracle Key Vault management console are applied to endpoints dynamically. The next time that the endpoint contacts Oracle Key Vault server, the updated configuration parameters are applied to the endpoint. If there is an error, then the update is not applied. Both `okvutil` and the PKCS11 library can access and apply the endpoint configuration updates.

If you use the C, SDK, JAVA SDK, or RESTful services utility, then Oracle Key Vault does not update the endpoint configuration. In this case, use `okvutil` or the PKCS library to apply the endpoint configuration updates.

In a multi-master cluster, replication of configuration parameters depends on the replication lag. It is possible that an endpoint will not be able to get an update immediately because the node to which it is connected may not yet have received the new values of the parameters. The endpoint will refresh its configuration when it connects to a node that has new values or if it hasn't refreshed its configuration in the past hour.

**Note:**

Users who have the Manage Endpoint privilege can modify the configuration parameters individually for each endpoint to which they have access. To do so, go to the Details page for the endpoint, scroll to the bottom, and then modify the endpoints from there.

12.3.3.2 Setting Global Endpoint Configuration Parameters

You can set global endpoint configuration parameters in the Oracle Key Vault management console.

1. Log in to the Oracle Key Vault management console as a user who has the System Administrator role.
2. Select the **Endpoints** tab, and then **Settings** from the left navigation bar.

The Endpoint Settings page appears.

Endpoint Settings

Allow Endpoint Self Enrollment

Save

Global Endpoint Configuration Parameters

Save Defaults Save

Endpoint Certificate Validity (in days)

PKCS11 In-Memory Cache Timeout (in minutes)

PKCS11 Persistent Cache Timeout (in minutes)

PKCS11 Persistent Cache Refresh Window (in minutes)

PKCS11 Configuration Parameter Refresh Interval (in minutes)

Server Poll Timeout (in milliseconds)

PKCS11 Trace Directory Path

Expire PKCS11 Persistent Cache on Database Shutdown ⓘ

- In the **Global Endpoint Configuration Parameters** section, configure the following settings:
 - Endpoint Certificate Validity (in days)**: Specify the number of days for which the current endpoint certificate is valid.
 - PKCS 11 In-Memory Cache Timeout (in minutes)**: Specify the duration in minutes for which the master encryption key is available after it is cached in the in-memory cache. For more information about the PKCS 11 In-Memory Cache Timeout setting, see [PKCS11_CACHE_TIMEOUT Parameter](#).
 - PKCS 11 Persistent Cache Timeout (in minutes)**: Specify the duration in minutes for which the master encryption key is available after it is cached in the persistent master encryption key cache. For more information about the **PKCS 11 Cache Persistent Timeout** setting, see [PKCS11_PERSISTENT_CACHE_TIMEOUT Parameter](#).
 - PKCS 11 Persistent Cache Refresh Window (in minutes)**: Specify the duration in minutes to extend the period of time for which the master encryption key is available after it is cached in the persistent master encryption key cache. For more information about the **PKCS 11 Persistent Cache Refresh Window** setting, see [PKCS11_PERSISTENT_CACHE_REFRESH_WINDOW Parameter](#).
 - Server Poll Timeout (in milliseconds)**: Specify a timeout in seconds for a client's attempt to connect to an Oracle Key Vault server, before trying the next server in the list. The default value is 300 (milliseconds).
 - PKCS 11 Trace Directory Path**: Specify a directory to save the trace files.
 - Expire PKCS11 Persistent Cache on Database Shutdown**: Enables or disables the PKCS#11 persistent cache for a given endpoint database to automatically expire upon shutdown of the endpoint database. See [EXPIRE PKCS11 PERSISTENT CACHE ON DATABASE SHUTDOWN Parameter](#).
- Click **Save**.

12.3.4 Modifying Configuration Parameters for an Individual Endpoint

A user who has the System Administrator role or the Manage Endpoint privilege can set configuration parameters for individual endpoints.

A user with the System Administrator role can set configuration parameters for any endpoint. A user with the Manage Endpoint privilege can only set configuration parameters for the endpoints for which the user has the Manage Endpoint privilege.

1. Log in to the Oracle Key Vault management console as a user who has the System Administrator role or the Manage Endpoint privilege.
2. Select the **Endpoints** tab, and then **Endpoints** from the left navigation bar.
3. In the Endpoints page, select the endpoint that you want to modify.
4. In the Endpoint Details page, scroll down to the Endpoint Configuration Parameters area.
5. Modify the configuration parameters as necessary.

The configuration parameters are the same as the configuration parameters that can be modified globally.

6. Click **Save**.

Related Topics

- [Setting Global Endpoint Configuration Parameters](#)
You can set global endpoint configuration parameters in the Oracle Key Vault management console.

12.4 Default Wallets and Endpoints

You can use a default wallet, which is a type of virtual wallet, with an endpoint.

- [Associating a Default Wallet with an Endpoint](#)
A default wallet is a type of virtual wallet to which security objects are uploaded when a wallet is not explicitly specified.
- [Setting the Default Wallet for an Endpoint](#)
Setting a default wallet for an endpoint automatically uploads the endpoint's security objects to the wallet if another wallet is not explicitly specified.

12.4.1 Associating a Default Wallet with an Endpoint

A default wallet is a type of virtual wallet to which security objects are uploaded when a wallet is not explicitly specified.

Default wallets are useful for sharing with other endpoints such as nodes in an Oracle Real Application Clusters (Oracle RAC), or primary and standby nodes in Oracle Data Guard by having all endpoints use the same default wallet.

If you want to use the default wallet, then you must set this wallet after you register the endpoint before you enroll it. If you decide to use a default wallet after enrollment, then you must remove the default wallet and subsequently reenroll the endpoint.

An enrollment status of **registered** means that the endpoint has been added to Oracle Key Vault, but the endpoint software has not yet been downloaded and installed. When the status is **registered**, then you must associate the default wallet with the endpoint.

The endpoint's enrollment status becomes **enrolled** when you download and install the endpoint software to the endpoint. If you set the default wallet after you enroll the endpoint, then you must reenroll the endpoint to ensure that all future security objects created by the endpoint are automatically associated with that wallet.

In a multi-master cluster, you can only assign the default wallet on the same node where the endpoint and wallet were created when either are still in the `PENDING` state. After both are in the `ACTIVE` state, then there are no restrictions. After the default wallet is assigned and the endpoint is enrolled, the default wallet can be accessed from any node, as long as both are in the `ACTIVE` state and the information has been replicated to that node.

12.4.2 Setting the Default Wallet for an Endpoint

Setting a default wallet for an endpoint automatically uploads the endpoint's security objects to the wallet if another wallet is not explicitly specified.

Oracle requires that you set the default wallet right after registering the endpoint, and before downloading the endpoint software.

1. Log in to the Oracle Key Vault management console as a user who has the Key Administrator role or the Manage Endpoint privilege.

If you are logging on as a user with the Manage Endpoint privilege, then you must have full wallet access (Read/Write/Manage Wallet) on the wallet that you want to set as the endpoint's default wallet.

2. Select the **Endpoints** tab, then **Endpoints** in the left navigation bar.

The Endpoints page appears listing all the Oracle Key Vault endpoints.

3. In the Endpoints page, click the name of the endpoint that you want.
4. In the Default Wallet pane, select **Choose Wallet**.

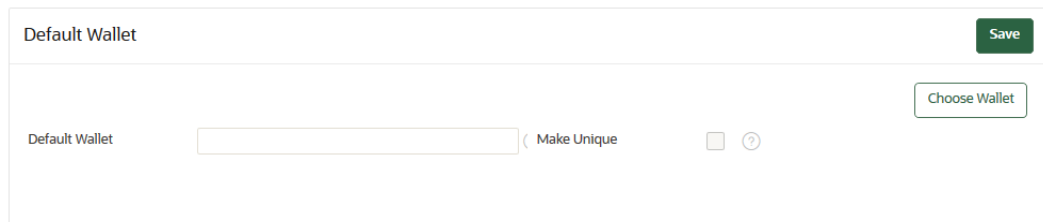

The Add Default Wallet page appears displaying a list of available wallets.

Add Default Wallet ✕

Cancel Select

Select Wallet

Q ▾ Go Actions ▾

	Wallet Name	Description	Creation Time	Creator Node
<input checked="" type="radio"/>	Cloud_App_Wallet	This wallet contains the SSH private keys, public keys of the entities being managed on Oracle public cloud	09-NOV-2020 15:56:03	node1
<input type="radio"/>	Peoplesoft_DB_Connect_Client_Wallet	This wallet contains the passwords of DB users who login to Oracle DB.	09-NOV-2020 15:55:36	node1
<input type="radio"/>	Data_Recovery_Manager_Wallet	This wallet contains the SEPS (Secure External Password Store) wallet containing various client user credentials.	09-NOV-2020 15:55:09	node1
<input type="radio"/>	Siebel_DG_Wallet	This wallet contains the TDE Master Encryption keys for the DB hosting the Siebel application data.	09-NOV-2020 15:54:49	node1
<input type="radio"/>	Solaris_OS_Wallet	This wallet contains SSH Keytabs for the different solaris OS users.	09-NOV-2020 15:54:28	node1
<input type="radio"/>	ASM_Cluster_File_System_Wallet	This wallet contains the ACFS Volume Encryption keys for the management of ACFS storage.	09-NOV-2020 15:54:09	node1
<input type="radio"/>	XYZ_MYSQL_WALLET	This wallet contains the MySQL DB Symmetric keys for the management of XYZ Application.	09-NOV-2020 15:53:37	node1
<input type="radio"/>	GoldenGate_Replication_App_Wallet	This wallet contains the GoldenGate Master keys for the replication application.	09-NOV-2020 15:52:53	node1

1 - 10 of 11 >

- Select a wallet from the list to be the default wallet by clicking the option to the left of the wallet, and then click **Select**.

The selected wallet name appears in the **Default Wallet** pane.

Default Wallet Save

Choose Wallet

Default Wallet (Make Unique ?

- Click **Save**.

12.5 Managing Endpoint Access to a Virtual Wallet

You can grant an endpoint access to a virtual wallet, and revoke or modify access when it is no longer necessary.

- [Granting an Endpoint Access to a Virtual Wallet](#)
An endpoint must have the Read, Modify, and Manage Wallet privileges on the wallet before security objects can be uploaded or downloaded.
- [Revoking Endpoint Access to a Virtual Wallet](#)
You can revoke access to a virtual wallet for an endpoint by using the **Endpoints** tab.
- [Viewing Wallet Items Accessed by Endpoints](#)
The term wallet items refers to the security objects to which the endpoint has access.

12.5.1 Granting an Endpoint Access to a Virtual Wallet

An endpoint must have the Read, Modify, and Manage Wallet privileges on the wallet before security objects can be uploaded or downloaded.

You can grant an endpoint access to a virtual wallet as soon as the endpoint has been added to Oracle Key Vault, when it is still in **registered** status.

1. Log in to the Oracle Key Vault management console as an administrator who has the Key Administrator role or the Manage Endpoint privilege on the endpoint.
2. Select the **Endpoints** tab, then **Endpoints** in the left navigation bar.
3. On the Endpoints page, select the endpoint that must have access to the virtual wallet.

The Endpoint Details page appears. Scroll down the page to the Access to Wallets pane.

<input type="checkbox"/>	Wallet Name	Access	Type
<input type="checkbox"/>	Cloud_App_Wallet	Read, Write, Manage Wallet	Direct
<input type="checkbox"/>	Cloud_App_Wallet	Read, Write	via Endpoint Group

1 - 2 of 2

4. In the Access to Wallets pane, which lists the wallets the endpoint already has access to, click **Add** to add another wallet to this list.

The Select Wallet page appears. A user with the Manage Endpoint privilege can only view the wallets to which this user has access.

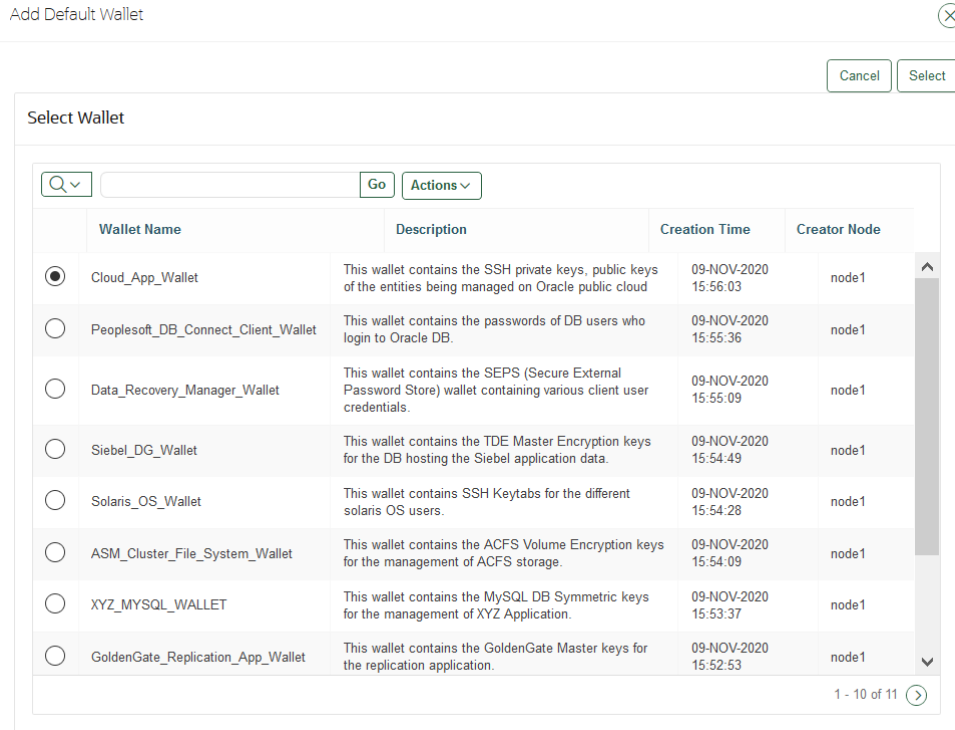

5. Select a wallet from the available list of wallets shown on the **Add Access to Endpoint** page.
6. In the Select Access Level pane, select the appropriate level of access.
7. Click **Save**.

Related Topics

- [Access Control Options](#)
Access control options enable you to set the type of privileges that users have to read, write, and delete security objects.

12.5.2 Revoking Endpoint Access to a Virtual Wallet

You can revoke access to a virtual wallet for an endpoint by using the **Endpoints** tab.

1. Log in to the Oracle Key Vault management console as an administrator who has the Key Administrator role or the Manage Endpoint privilege.

If you have the Manage Endpoint privilege on the given endpoint, then you must have the same or a higher level of access to the wallet.

2. Select the **Endpoints** tab, then **Endpoints** in the left navigation bar.
3. On the Endpoints page, select the endpoint name, which will display the Endpoint Details page.

Locate the Access to Wallets pane on this page. The Access to Wallets pane shows a list of wallets that the endpoint has access to.

4. Select the wallet that you want to revoke access to.
5. Click **Remove**.
6. In the confirmation window, click **OK**.

12.5.3 Viewing Wallet Items Accessed by Endpoints

The term wallet items refers to the security objects to which the endpoint has access.

1. Log in to the Oracle Key Vault management console as an administrator who has the Key Administrator role or the Manage Endpoint privilege.
2. Select the **Endpoints** tab, then **Endpoints** in the left navigation bar.
The Endpoints page appears listing all the Oracle Key Vault endpoints.
3. In the Endpoints page, click the name of the endpoint to access the Endpoint Details page, and then scroll down to the Access to Wallet Items pane.

The Access to Wallet Items pane lists the wallet items that the endpoint has access to.

<input type="checkbox"/>	Wallet Name	Access	Type
<input type="checkbox"/>	Cloud_App_Wallet	Read, Write, Manage Wallet	Direct
<input type="checkbox"/>	Cloud_App_Wallet	Read, Write	via Endpoint Group

1 - 2 of 2

12.6 Managing Endpoint Groups

An endpoint group is a named group of endpoints that share a common set of wallets.

- [How a Multi-Master Cluster Affects Endpoint Groups](#)
You can create endpoint groups on any node and they will have a cluster-wide presence.
- [Creating an Endpoint Group](#)
Endpoints that must share a common set of security objects stored in wallets can be grouped into an endpoint group.
- [Modifying Endpoint Group Details](#)
You can add endpoints and access mappings to an endpoint group after creating the endpoint group.
- [Granting an Endpoint Group Access to a Virtual Wallet](#)
You can grant an endpoint group access to a virtual wallet.
- [Adding an Endpoint to an Endpoint Group](#)
You can add an endpoint to a named endpoint group.
- [Removing an Endpoint from an Endpoint Group](#)
When you remove an endpoint from an endpoint group, this removes access to wallets that are associated with that endpoint group.

- [Deleting Endpoint Groups](#)
You can delete endpoint groups if their member endpoints no longer require access to the same virtual wallets.

12.6.1 How a Multi-Master Cluster Affects Endpoint Groups

You can create endpoint groups on any node and they will have a cluster-wide presence.

You can add, update, or delete endpoint groups in any node, but in read-write mode only.

The Oracle Key Vault server that becomes the initial node can have endpoint groups already created. These endpoint groups are used to initialize, or seed, the cluster. During induction, the endpoint groups in the cluster are replicated to a newly added node. Endpoint groups previously created in all other nodes added to the cluster will be removed during induction.

New endpoint groups added concurrently to the multi-master cluster on different nodes may have name conflicts. Oracle Key Vault automatically resolves any endpoint group name conflicts. These conflicts are displayed in a Conflicts Resolution page and key administrators can choose to rename them.

Related Topics

- [Naming Conflicts and Resolution](#)
Oracle Key Vault can resolve naming conflicts that can arise as users create objects such as endpoints, endpoint groups, and user groups.

12.6.2 Creating an Endpoint Group

Endpoints that must share a common set of security objects stored in wallets can be grouped into an endpoint group.

For example, endpoints using Oracle Real Application Clusters (Oracle RAC), Oracle GoldenGate, or Oracle Active Data Guard may need to share keys for access to shared data.

1. Log in to the Oracle Key Vault management console as a user who has the Key Administrator role or the Manage Endpoint Group privilege.

A user who has the Manage Endpoint Group privilege will only be able to manage the endpoint groups that he or she created.

2. Select the **Endpoints** tab, then **Endpoint Groups** in the left navigation bar.

The Endpoint Groups page appears.

Endpoint Groups

Create Delete ↗

Q Go Actions

<input type="checkbox"/>	Endpoint Group Name	Name Status	Description	Creation Time	Created By	Creator Node	Edit
<input type="checkbox"/>	CLOUD_APP_GROUP	ACTIVE	This group contains the members managing entities running on Oracle Public cloud	09-NOV-2020 15:47:24	OKVADMIN	node1	
<input type="checkbox"/>	SIEBEL_APPLICATION_DATAGUARD_GROUP	ACTIVE	This group contains all the primary and standby databases belonging to Siebel Application	09-NOV-2020 15:47:03	OKVADMIN	node1	
<input type="checkbox"/>	HR_APPLICATION_DB_GROUP	ACTIVE	This group contains all the related HR Application Databases	09-NOV-2020 15:46:44	OKVADMIN	node1	

1 - 3 of 3

Group Members

Q Go

Endpoint Name	Description
SIEBEL_PRIMARY_DB_AUSTIN	Primary Database deployed in Austin Datacenter for the Siebel application configured in Dataguard environment

Access to Wallets

Q Go

Wallet Name	Access
Siebel_DG_Wallet	Read, Write

1 - 1 of 1

3. Click **Create**.

The Create Endpoint Group page appears.

Create Endpoint Group

Cancel Save

Name * Make Unique ?

Description

4. Enter the name of the new group and a brief description.

Ensure that you follow the correct naming guidelines for objects.

5. If you are using a multi-master cluster, then choose whether to select the **Make Unique** check box.

Make Unique helps to control naming conflicts with names across the multi-master cluster environment. Endpoint groups that were created before an Oracle Key Vault conversion to a cluster node are not affected by naming conflicts.

- If you select **Make Unique**, then the endpoint group will be active immediately and users can use this endpoint group. Clicking **Make Unique** also displays a list of endpoints that you can add to the endpoint group.
- If you do not select **Make Unique**, then the endpoint group will be created in the `PENDING` state. Oracle Key Vault will then begin a name resolution operation and may rename the endpoint group to a name that is unique across the cluster. If there is a naming collision, then the collision will be reported on the Conflicts page on any node

in the cluster. The endpoint group will then be renamed to a unique name. You will need to go to a read-write node of the cluster and either accept the renamed endpoint group or change the endpoint name. If you change the endpoint group name, then this will restart the name resolution operation and the endpoint group will return to a `PENDING` state. An endpoint group in the `PENDING` state cannot be used to perform most operations.

6. Click **Save** to complete creating the endpoint group.

The new endpoint group now appears in the Endpoint Groups page.

7. If you had logged in as a user with the Create Endpoint Group privilege, and if this is the first endpoint group that you have created, then log out of the Oracle Key Vault management console and log back in again.

Logging out and an again makes the full set of privileges for this endpoint group available to you.

Related Topics

- [Naming Guidelines for Objects](#)
The naming guidelines affect the following Oracle Key Vault objects: users, user groups, endpoints, endpoint groups, and virtual wallets.
- [Modifying Endpoint Group Details](#)
You can add endpoints and access mappings to an endpoint group after creating the endpoint group.

12.6.3 Modifying Endpoint Group Details

You can add endpoints and access mappings to an endpoint group after creating the endpoint group.

An endpoint can belong to more than one endpoint group. You cannot add one endpoint group to another endpoint group.

1. Log in to the Oracle Key Vault management console as a user who has the Key Administrator role or the Manage Endpoint Group privilege.

A user who has the Manage Endpoint Group privilege can only modify endpoint groups that he or she created.

2. Select the **Endpoints** tab, then **Endpoint Groups** in the left navigation bar.

The Endpoint Groups page appears.

3. Click the edit pencil icon in the **Edit** column corresponding to the endpoint group.

The Endpoint Group Details page appears.

Endpoint Group Details Cancel Save

Name: Make Unique

Description:

Creation Time: 10-DEC-2020 21:31:59

Access to Wallets Add Remove

Search: Go Actions

<input type="checkbox"/>	Wallet Name	Access	Edit
<input type="checkbox"/>	Siebel_DG_Wallet	Read	

1 - 1 of 1

Endpoint Group Members Add Remove

Search: Go Actions

<input type="checkbox"/>	Endpoint Name	Type	Status	Description	Creation Time
<input type="checkbox"/>	SIEBEL_STANDBY_DB_FRANKFURT	Oracle Database	REGISTERED	Standby Database deployed in Frankfurt Datacenter for the Siebel application configured in Dataguard environment	10-DEC-2020 22:03:53
<input type="checkbox"/>	SIEBEL_STANDBY_DB_PHEONIX	Oracle Database	REGISTERED	Standby Database deployed in Phoenix Datacenter for the Siebel application configured in Dataguard environment	10-DEC-2020 22:03:19
<input type="checkbox"/>	SIEBEL_PRIMARY_DB_AUSTIN	Oracle Database	REGISTERED	Primary Database deployed in Austin Datacenter for the Siebel application configured in Dataguard environment	10-DEC-2020 22:02:07

1 - 3 of 3

4. Modify the endpoint name as necessary.
See [Naming Guidelines for Objects](#).
5. Modify the description as needed.
6. Add or remove access to wallets or endpoint group members by clicking **Add** or **Remove**.
7. Click **Save**.

12.6.4 Granting an Endpoint Group Access to a Virtual Wallet

You can grant an endpoint group access to a virtual wallet.

In a multi-master cluster, you cannot grant access to an endpoint group that is in the `PENDING` state to a virtual wallet.

1. Log in to the Oracle Key Vault management console as a user who has the Key Administrator role or the Manage Endpoint Group privilege.

A user who has the Manage Endpoint Group privilege can grant endpoint group access to wallets for only endpoint groups that the user created.

2. Select the **Endpoints** tab, then **Endpoint Groups** in the left navigation bar.

The Endpoint Groups page appears.

3. Click the pencil icon in the **Edit** column corresponding to the endpoint group.

The Endpoint Group Details page appears.

4. In the **Access to Wallets** pane, click **Add**.
5. Select a virtual wallet from the available list.
6. Select an **Access Level**:

- **Read Only**: This level grants the endpoint group read access to the virtual wallet and its items.

- **Read and Modify:** This level grants the endpoint group read and write access to the virtual wallet and its items.
7. Select the **Manage Wallet** check box if you want endpoints to:
 - Add or remove objects from the virtual wallet.
 - Grant other endpoints or endpoint groups access to the virtual wallet.
 8. Click **Save**.

Related Topics

- [Manage Endpoint Group Privilege Duties and Scope](#)
The Manage Endpoint Group object privilege on an endpoint group enables a user to perform all endpoint group management operations on the endpoint group.

12.6.5 Adding an Endpoint to an Endpoint Group

You can add an endpoint to a named endpoint group.

In a multi-master cluster, you cannot add an endpoint that is in the `PENDING` state to an endpoint group. Also, you cannot add an endpoint to an endpoint group that is in the `PENDING` state.

1. Log in to the Oracle Key Vault management console as an administrator who has the Key Administrator role or Manage Endpoint Group privilege.

A user who has the Manage Endpoint Group privilege can only add endpoints to endpoint groups that he or she created.

2. Select the **Endpoints** tab, then **Endpoints** in the left navigation bar.

The Endpoints page appears.

3. Select the endpoint you want to add to a group.

The Endpoint Details page appears.

4. Scroll to Endpoint Group Membership and then click **Add**.

The Add Endpoint Group Membership page appears.

<input type="checkbox"/>	Endpoint Group Name	Description	Creation Time
<input type="checkbox"/>	CLOUD_APP_GROUP	This group contains the members managing entities running on Oracle Public cloud	09-NOV-2020 15:47:24
<input type="checkbox"/>	SIEBEL_APPLICATION_DATAGUARD_GROUP	This group contains all the primary and standby databases belonging to Siebel Application	09-NOV-2020 15:47:03
<input type="checkbox"/>	HR_APPLICATION_DB_GROUP	This group contains all the related HR Application Databases	09-NOV-2020 15:46:44

A list of endpoint groups is displayed under **Endpoint Group Name**.

5. Check the boxes to the left of the endpoint groups you want to add the endpoint to.
6. Click **Save**.

The Endpoint Group Membership pane displays the checked endpoint group.

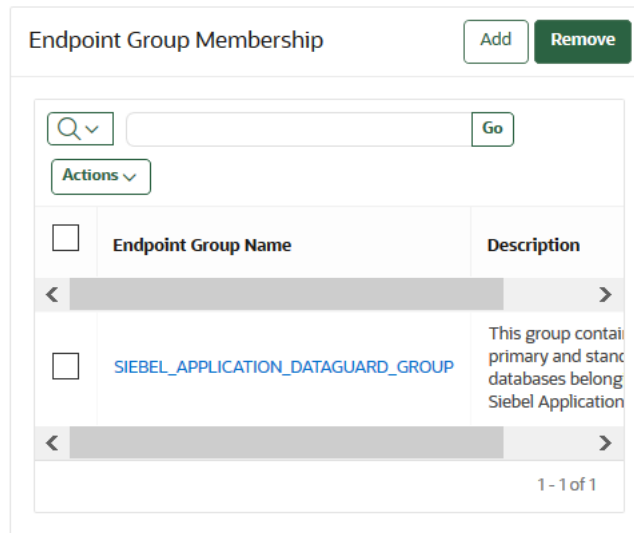

Related Topics

-

12.6.6 Removing an Endpoint from an Endpoint Group

When you remove an endpoint from an endpoint group, this removes access to wallets that are associated with that endpoint group.

The removal process completes the removal unless the endpoint has been separately granted access to the wallets, directly or through another endpoint group. In a multi-master cluster, you can remove multiple endpoints at the same time. In a multi-master cluster, you cannot remove an endpoint from an endpoint group that is in the `PENDING` state.

1. Log in to the Oracle Key Vault management console as a user who has the Key Administrator role or the Manage Endpoint Group privilege.

A user who has the Manage Endpoint Group privilege can only remove endpoints from endpoint groups that he or she created.

2. Select the **Endpoints** tab, then **Endpoint Groups** in the left navigation bar.

The Endpoint Groups page appears.

3. In Endpoint Groups, click the edit pencil icon next in the **Edit** column corresponding to the endpoint group.

The Endpoint Group Details page appears.

4. In the Endpoint Group Members pane, check the boxes to the left of the endpoint names to be removed.

5. Click **Remove**.

6. In the confirmation window, click **OK**.

12.6.7 Deleting Endpoint Groups

You can delete endpoint groups if their member endpoints no longer require access to the same virtual wallets.

This action removes the shared access of member endpoints to wallets, not the endpoints themselves. You can only delete an endpoint group that is in the `PENDING` state if it has no members or access to wallets.

1. Log in to the Oracle Key Vault management console as a user who has the Key Administrator role or the Manage Endpoint Group privilege.

A user who has the Manage Endpoint Group privilege can only remove endpoint groups that he or she created.

2. Select the **Endpoints** tab, then **Endpoint Groups** in the left navigation bar.

The Endpoint Groups page appears.

3. Check the boxes to the left of the endpoint group names that you want to delete.
4. Click **Delete**.
5. In the confirmation window, click **OK**.

13

Enrolling and Upgrading Endpoints for Oracle Key Vault

After an endpoint is registered in Oracle Key Vault, an endpoint administrator enrolls and provisions the endpoint to manage security objects in Key Vault.

- [About Endpoint Enrollment and Provisioning](#)
Endpoints are Oracle Key Vault clients that use the server to store and manage security objects, share them with trusted peers, and retrieve them.
- [Finalizing Enrollment and Provisioning](#)
To enroll and provision a registered endpoint an endpoint administrator must download and then install the `okvclient.jar` file.
- [Environment Variables and Endpoint Provisioning Guidance](#)
Environment variables such as `JAVA_HOME` and `OKV_HOME` must be correctly set so that Oracle Key Vault can access its utilities.
- [Endpoints That Do Not Use the Oracle Key Vault Client Software](#)
Third-party KMIP endpoints do not use the Oracle Key Vault software `okvutil` and `liborapkcs.so`.
- [Transparent Data Encryption Endpoint Management](#)
Oracle Key Vault can manage TDE keys by using the same PKCS#11 interface that TDE uses to communicate with an external keystore.
- [Endpoint `okvclient.ora` Configuration File](#)
Oracle Key Vault endpoint libraries and utilities use the `okvclient.ora` configuration file, which stores the configuration parameters associated with the endpoint.
- [Upgrading Endpoints](#)
You can perform endpoint upgrades from either the Oracle Key Vault management console login page or from the endpoint.

13.1 About Endpoint Enrollment and Provisioning

Endpoints are Oracle Key Vault clients that use the server to store and manage security objects, share them with trusted peers, and retrieve them.

These clients can be systems like Oracle database servers, Oracle middleware servers, operating systems, and other information systems.

An Oracle Key Vault system administrator first adds (or registers) the endpoint to Key Vault, and then sends the endpoint's enrollment token (generated during registration) to the endpoint administrator. The endpoint administrator verifies the enrollment token before enrolling and provisioning the endpoint. An enrolled endpoint can upload, download, and manage security objects using Key Vault.

Endpoint enrollment is a three-step process performed by two kinds of administrative users summarized in the following table.

Table 13-1 Summary of Endpoint Enrollment

Step #	Task	Performed by	Endpoint Status (as seen on Oracle Key Vault Management Console)
1.	<ol style="list-style-type: none"> 1. System administrator or user with Manage Endpoint privilege creates an endpoint. 2. If this is an Oracle database, a key administrator creates a virtual wallet. 3. System administrator adds or registers the endpoint to Oracle Key Vault. An enrollment token for the endpoint is generated. 4. System administrator sends the enrollment token to the endpoint administrator to complete the enrollment process. 	Users with the System Administrator role and Key Administrator role on Oracle Key Vault, or user with the Manage Endpoint privilege	Registered
2.	<ol style="list-style-type: none"> 1. Verify the enrollment token. 2. Submit enrollment token to download endpoint software <code>okvclient.jar</code> to the endpoint. 	Endpoint administrator using the Oracle Key Vault management console	Enrolled
3.	Install <code>okvclient.jar</code> on the endpoint.	Endpoint administrator on endpoint	Enrolled

Endpoint enrollment ensures that only authorized endpoints can communicate with Oracle Key Vault because the utilities needed to communicate are bundled with the `okvclient.jar` endpoint software file.

`okvclient.jar` contains the following:

- A Transport Layer Security (TLS) certificate and private key that the endpoint uses to authenticate itself to Oracle Key Vault
- A TLS certificate for Oracle Key Vault that serves as the root CA
- Endpoint libraries and utilities
- Additional information such as the Oracle Key Vault IP address that is used by `okvutil` to create the `okvclient.ora` configuration file

In an Oracle Real Application Clusters (RAC) environment, you must enroll and provision each Oracle RAC node as an endpoint. Each Oracle RAC-enabled database corresponds to one virtual wallet in Oracle Key Vault. Each Oracle RAC instance of that database corresponds to an endpoint in Oracle Key Vault. All endpoints for each database share the same wallet as their default wallet. You must download one distinct `okvclient.jar` for each instance.

Related Topics

- [Types of Endpoint Enrollment](#)
The first step in enrolling an endpoint is to add the endpoint to Oracle Key Vault.
- [Endpoint okvclient.ora Configuration File](#)
Oracle Key Vault endpoint libraries and utilities use the `okvclient.ora` configuration file, which stores the configuration parameters associated with the endpoint.
- [Oracle Key Vault okvutil Endpoint Utility Reference](#)
The `okvutil` utility enables you to perform tasks uploading and downloading security objects.

13.2 Finalizing Enrollment and Provisioning

To enroll and provision a registered endpoint an endpoint administrator must download and then install the `okvclient.jar` file.

- [Step 1: Enroll the Endpoint and Download the Software](#)
You must have the endpoint's enrollment token before you can download the endpoint software `okvclient.jar`.
- [Step 2: Prepare the Endpoint Environment](#)
You must ensure that you have the right version of the Java Development Toolkit (JDK) and that the Oracle environment variables are set.
- [Step 3: Install the Oracle Key Vault Software onto the Endpoint](#)
To upgrade to the latest endpoint software for an enrolled endpoint, you can download the endpoint software without having to reenroll the endpoint.
- [Step 4: Perform Post-Installation Tasks](#)
The post-installation procedures include optionally configuring a TDE connection for the endpoint, checking the installation contents, and deleting the `okvclient.jar` file.

13.2.1 Step 1: Enroll the Endpoint and Download the Software

You must have the endpoint's enrollment token before you can download the endpoint software `okvclient.jar`.

After registering the endpoint, the Oracle Key Vault system administrator sends this endpoint's enrollment token to the endpoint administrator by email or other out-of-band method.

1. Log in to the endpoint server as the endpoint administrator.
2. Connect to the Oracle Key Vault management console.

For example:

```
https://192.0.2.254
```

The login page to the Oracle Key Vault management console appears. **Do not log in.**

3. Click the **Endpoint Enrollment and Software Download** button, which is below the **Login** button.

The Enroll Endpoint & Download Software page appears.

4. If the endpoint was registered by an Oracle Key Vault system administrator, then do the following:
 - a. Enter the endpoint's enrollment token in **Enrollment Token**, and click **Submit Token**.

If the token is valid, then a valid token message appears below the **Enrollment Token** field. The **Endpoint Type**, **Endpoint Platform**, **Email** and **Description** fields are automatically populated with the values that were entered during endpoint registration.

If the token is invalid, then an invalid token message appears. Check the token and retry the download procedure.
 - b. Click **Enroll** at the top right corner of the page.
5. If the endpoint was registered by self-enrollment, then do the following:
 - a. Bypass the step of validating the token because self-enrolled endpoints have no enrollment token.
 - b. From the **Endpoint Type** list, select the type of endpoint: **Oracle Database**, **Oracle (non-database)**, or **Other**. If you are using Transparent Data Encryption (TDE), then you must enter Oracle Database.
 - c. From the **Endpoint Platform** list, select the platform: **Linux**, **Solaris SPARC**, **Solaris x64**, **AIX**, **HP-UX**, **Windows**.
 - d. In the **Email** field, enter the email address of the endpoint administrator, for notification purposes. This field is optional but recommended.
 - e. In the **Description** field, enter meaningful and identifying information for the endpoint. This field is also optional but strongly recommended.
 - f. Click **Enroll** at the top right corner of the page.
6. In the directory window that appears, follow the prompt to save the `okvclient.jar` endpoint software file.

You must navigate to the directory where you want to save the file.
7. Save the file to a secure directory with appropriate permissions in place so that it cannot be read or copied by others.
8. Verify that the file has been downloaded.

If the download fails, then you must obtain a new enrollment token from the key administrator for the endpoint and repeat these steps, starting with Step 4. Note

that if you did not download the file to the endpoint system, you must use an out-of-band method to copy the file to that system and install it there.

At this stage, you are ready to install the Oracle Key Vault `okvclient.jar` software file on the endpoint, starting with preparing the endpoint environment.

Related Topics

- [Step 2: Prepare the Endpoint Environment](#)
You must ensure that you have the right version of the Java Development Toolkit (JDK) and that the Oracle environment variables are set.

13.2.2 Step 2: Prepare the Endpoint Environment

You must ensure that you have the right version of the Java Development Toolkit (JDK) and that the Oracle environment variables are set.

1. Ensure that you have the necessary administrative privileges to install software on the endpoint.
2. Ensure that you have JDK 1.5 or later installed, and that the `PATH` environment variable includes the `java` executable (in the `JAVA_HOME/bin` directory).

Oracle Key Vault supports JDK versions 1.5, 1.6, 7, and 8. The 64-bit version of Java is required.
3. Run the shell utility `oraenv` or `source oraenv` command to set the correct environment variables on Oracle Database servers.
4. Check that the environment variables `ORACLE_BASE` and `ORACLE_HOME` are correctly set.

If you used `oraenv` to set these variables, then you must verify that `ORACLE_BASE` points to the root directory for Oracle Databases, and that `ORACLE_HOME` points to a sub-directory under `ORACLE_BASE` where an Oracle database is installed.

13.2.3 Step 3: Install the Oracle Key Vault Software onto the Endpoint

To upgrade to the latest endpoint software for an enrolled endpoint, you can download the endpoint software without having to reenroll the endpoint.

1. Ensure that you are logged in to the endpoint server as the endpoint administrator.
2. Navigate to the directory in which you saved the `okvclient.jar` file.
3. Confirm that the target directory exists, and that it is empty.
4. Run the `java` command to install the `okvclient.jar` file.

```
java -jar okvclient.jar -d c:\db\okv_home -v [-db112]
```

In this specification:

- `-d` specifies the directory location for the endpoint software and configuration files, in this case `c:\db\okv_home`.
- `-v` writes the installation logs to the `/home/oracle/okvutil/log/okvutil.deploy.log` file at the server endpoint.
- `-db112` applies only if the Oracle database is 11.2.0.4 and the endpoint platform is Windows.

`-o` is an optional argument that enables you to overwrite the symbolic link reference to `okvclient.ora` when `okvclient.jar` is deployed in a directory other than the original directory. This argument is used only when you re-enroll an endpoint.

If you are installing the `okvclient.jar` file on a Windows endpoint system that has Oracle Database release 11.2.0.4 **only**, then include the `-db112` option. (This option is not necessary for any other combination of endpoint platform or Oracle Database version.) For example:

```
java -jar okvclient.jar -d c:\db\okv_home\okvutil -v -db112
```

5. When you are prompted for a password, then perform either of the following two steps.

The optional password goes into two places: `okvutil` and in `ADMINISTER KEY MANAGEMENT`. With `okvutil`, only users who know that password can upload or download content to and from Oracle Key Vault. With `ADMINISTER KEY MANAGEMENT`, it becomes the password that you must use in the `IDENTIFIED BY password` clause. If you choose not to give a password, then `okvutil` upload and download commands will not prompt for a password, and the password for `ADMINISTER KEY MANAGEMENT` becomes `NULL`.

The choices for handling the password are as follows:

- If you want to create a password-protected wallet, at minimum enter a password between 8 and 30 characters and then press **Enter**. For better security, Oracle recommends that you include uppercase letters, lowercase characters, special characters, and numbers in the password. The following special characters are allowed: (`.`), comma (`,`), underscore (`_`), plus sign (`+`), colon (`:`), space.

```
Enter new Key Vault endpoint password (<enter> for auto-login):  
Key_Vault_endpoint_password  
Confirm new endpoint password: Key_Vault_endpoint_password
```

A password-protected wallet is an Oracle wallet file that store the endpoint's credentials to access Oracle Key Vault. This password will be required whenever the endpoint connects to Oracle Key Vault.

- Alternatively, enter no password and then press **Enter**.

A successful installation of the endpoint software creates the following directories:

- `bin`: contains the `okvutil` program, the `root.sh` and `root.bat` scripts, and the binary file `okveps.x64`
- `conf`: contains the configuration file `okvclient.ora`
- `jlib`: contains the Java library files
- `lib`: contains the file `liborapkcs.so`
- `log`: contains the log files
- `ssl`: contains the TLS-related files and wallet files. The wallet files contain the endpoint credentials to connect to Oracle Key Vault.

The `ewallet.p12` file refers to a password-protected wallet. The `cwallet.sso` file refers to an auto-login wallet.

13.2.4 Step 4: Perform Post-Installation Tasks

The post-installation procedures include optionally configuring a TDE connection for the endpoint, checking the installation contents, and deleting the `okvclient.jar` file.

1. Optionally, configure a TDE connection for the endpoint.

On UNIX platforms, the `liborapkcs.so` file contains the library that the Oracle database uses to communicate with Oracle Key Vault. On Windows platforms, the `liborapkcs.dll` file contains the library that the Oracle database uses to communicate with Oracle Key Vault.

If an endpoint uses online TDE master encryption key management by Oracle Key Vault, then you must perform this step.

- **On Oracle Linux x86-64, Solaris, AIX, and HP-UX (IA) installations:** Log in as the root user and then execute either of the following commands:

```
$ sudo bin/root.sh
```

Or:

```
$ su -  
# bin/root.sh
```

This command creates the directory tree `/opt/oracle/extapi/64/hsm/oracle/1.0.0`, changes ownership and permissions, then copies the PKCS#11 library into this directory.

- **On Windows installations:** Run the following command:

```
bin\root.bat
```

This command copies the `liborapkcs.dll` file to the `C:\oracle\extapi\64\hsm\oracle\1.0.0` directory.

2. Use a command such as `namei` or `ls -l` to confirm that a softlink was created in `$ORACLE_BASE/okv/$ORACLE_SID/okvclient.ora` to point to the real file in the `/conf` subdirectory of the installation target directory.

If the `ORACLE_BASE` environment variable has not been set, then the softlink was created in `$ORACLE_HOME/okv/$ORACLE_SID`.

3. Run the `okvutil list` command to verify that the endpoint software installed correctly, and that the endpoint can connect to the Oracle Key Vault server.

```
$ ./okvutil list
```

If the endpoint is able to connect to Key Vault, then the `No objects found` message appears. If a `Server connect failed` message appears, then you must troubleshoot the installation for possible issues. Check that environment variables are correctly set. To get help on the endpoint software, execute the following command:

```
java -jar okvclient.jar -h
```

Output similar to the following appears:

```
Production on Fri Apr 12 15:03:01 PDT 2019  
Copyright (c) 1996, 2019 Oracle. All Rights Reserved.  
Usage:
```

```
java -jar okvclient.jar [-h | -help] [[-v | -verbose] [-d <destination
directory>] [-o]]
```

Options:

```
-h or -help : Display command help.
-v or -verbose : Turn on the verbose mode. Logs will be written to files
under
                <destination directory>/log/ directory.
-d <destination directory> : Specify the software installation directory.
-o : Overwrite the current symbolic link to okvclient.ora.
```

13.3 Environment Variables and Endpoint Provisioning Guidance

Environment variables such as `JAVA_HOME` and `OKV_HOME` must be correctly set so that Oracle Key Vault can access its utilities.

- [How the Location of `JAVA_HOME` Location Is Determined](#)
The default location for the `okvclient.ora` file is the `$OKV_HOME/conf` directory.
- [Location of the `okvclient.ora` File and Environment Variables](#)
`$OKV_HOME` is the destination directory for the endpoint software specified with the `-d` option during installation.
- [Setting `OKV_HOME` for Non-Database Utilities to Communicate with Oracle Key Vault](#)
For non-database utilities, you must set the environment variable `OKV_HOME` to point to the destination directory for the endpoint software.
- [Environment Variables in `sqlnet.ora` File](#)
You must consider several points while using the `srvctl` utility on Oracle Database endpoints.

13.3.1 How the Location of `JAVA_HOME` Location Is Determined

The default location for the `okvclient.ora` file is the `$OKV_HOME/conf` directory.

When you provision endpoints you must know how the installation process determines the location of Java home and the `okvclient.ora` file.

The endpoint software installation process uses the following rules to determine the Java home location:

- If a user-defined `JAVA_HOME` environment variable exists, the installation process uses this value.
- If `JAVA_HOME` is not set, then the installation process looks for it in the `java.home` system property of the Java Virtual Machine (JVM).

After the `JAVA_HOME` path is determined, the installation process adds it to the `okvclient.ora` configuration file to be used by all `okvutil` commands.

You can force `okvutil` to use a different `JAVA_HOME` setting by using one of the following methods:

- Set the `JAVA_HOME` environment variable in the shell where you run `okvutil`:

```
setenv JAVA_HOME path_to_Java_home
```

Or:

```
export JAVA_HOME = path_to_Java_home
```

- Set the `JAVA_HOME` property directly in the `okvclient.ora` configuration file.

```
JAVA_HOME=path_to_Java_home
```

Restart the endpoint database after you set the `JAVA_HOME` variable in `okvclient.ora`.

You may need to periodically manually update the value of the `JAVA_HOME` environment variable setting in the `okvclient.ora` file. This can happen when a newer version of Java is installed and the previous version of Java is removed. To do this, first shut down the endpoint database, so that `okvclient.ora` is not overwritten by the database processes. Then, manually update the value of `JAVA_HOME` in `okvclient.ora`.

13.3.2 Location of the `okvclient.ora` File and Environment Variables

`$OKV_HOME` is the destination directory for the endpoint software specified with the `-d` option during installation.

The `okvclient.ora` file is a configuration file in the `$OKV_HOME/conf` directory .

In addition to the `$OKV_HOME/conf` file, the installation process creates a soft link to `okvclient.ora` for an existing database. The location of the soft link depends on the following:

- If the `$ORACLE_BASE` environment variable is set, then the installation process creates a symbolic link to the `okvclient.ora` configuration file (in `$OKV_HOME/conf`) in the `$ORACLE_BASE/okv/$ORACLE_SID` location.

If the `okvclient.ora` file already exists in the `$ORACLE_BASE/okv/$ORACLE_SID` location, then the installation process accepts the existing soft link to `okvclient.ora` as a valid soft link.

- If the `$ORACLE_BASE/okv/$ORACLE_SID` directory is not set, then the installation process tries to create it.
- If the `$ORACLE_HOME` environment variable is set but the `$ORACLE_BASE` variable is not set, then the installation process creates a symbolic link for the `$ORACLE_HOME/okv/$ORACLE_SID` location to point to the configuration file in the `$OKV_HOME/conf` directory.

13.3.3 Setting `OKV_HOME` for Non-Database Utilities to Communicate with Oracle Key Vault

For non-database utilities, you must set the environment variable `OKV_HOME` to point to the destination directory for the endpoint software.

You must manually set `OKV_HOME` because the installation process does not set this variable automatically. Setting `OKV_HOME` enables utilities to communicate with Oracle Key Vault. These include utilities such as Oracle Recovery Manager (RMAN) that access Oracle Key Vault for keys.

You must set `OKV_HOME` in all environments where you will run utilities such as RMAN. For example, if you spawn a new `xterm` window, then you will need to set `OKV_HOME` in this environment before running RMAN.

13.3.4 Environment Variables in sqlnet.ora File

You must consider several points while using the `srvctl` utility on Oracle Database endpoints.

- If you are using the `srvctl` utility, and if you want to include environment variables in the `sqlnet.ora` configuration file, then you must set these environment variables in both the operating system and the `srvctl` environment.
- For Oracle Database endpoints, if you are using the `srvctl` utility and setting environment variables in `sqlnet.ora`, then you must set them in both the operating system and the `srvctl` environment.
- The operating system and `srvctl` utility should have `$ORACLE_SID`, `$ORACLE_HOME` and `$ORACLE_BASE` set to the same values.

13.4 Endpoints That Do Not Use the Oracle Key Vault Client Software

Third-party KMIP endpoints do not use the Oracle Key Vault software `okvutil` and `liborapkcs.so`.

In this case you must manually set the Transport Layer Security (TLS) authentication as follows:

1. Extract the `ssl` directory from the `okvclient.jar` file.

```
jar xvf okvclient.jar ssl
```
2. Use the following files to set up the TLS authentication:
 - `ssl/key.pem`: Endpoint private key
 - `ssl/cert.pem`: Endpoint certificate
 - `ssl/cert_req.pem`: Certificate request corresponding to `cert.pem`
 - `ssl/CA.pem`: Trust anchor for verifying the Oracle Key Vault server certificate

13.5 Transparent Data Encryption Endpoint Management

Oracle Key Vault can manage TDE keys by using the same PKCS#11 interface that TDE uses to communicate with an external keystore.

Therefore, you do not need to patch the database to use Oracle Key Vault for storing and retrieving TDE master encryption keys. Oracle Key Vault supplies the PKCS#11 library to communicate with Oracle Key Vault.

Oracle Key Vault improves upon TDE key management. For example, you can directly upload the keys in the wallet to Oracle Key Vault for long-term retention, to be shared with other database endpoints within the same endpoint group. Therefore, you do not need to store the wallet indefinitely after migration. Migration in this context means that the database is configured to use Oracle Key Vault for wallet backup, and that the administrator intends to migrate to an [online master key](#) (formerly known as TDE direct connect).

You can continue to use the wallet, and upload wallet copies to Key Vault as part of every TDE key administration SQL operation, involving a `WITH BACKUP` SQL clause. However, be aware that TDE ignores the `WITH BACKUP` clause in an Oracle Key Vault online key deployment, even if it is required for the `ADMINISTER KEY MANAGEMENT` statement.

Oracle Database TDE are endpoints for Oracle Key Vault. Endpoint enrollment and installation ensure that the PKCS#11 library is installed in the correct location for TDE to pick up and use. When the PKCS#11 library is installed, all other configurations and operations are in effect.

[Example 13-1](#) shows examples of setting an encryption key.

Example 13-1 Setting an Encryption Key

```
ALTER SYSTEM SET ENCRYPTION KEY IDENTIFIED BY secret_passphrase -- For Oracle Database  
11g Release 2
```

```
ADMINISTER KEY MANAGEMENT SET ENCRYPTION KEY IDENTIFIED BY secret_passphrase WITH  
BACKUP; -- For Oracle Database 12c or later
```

Related Topics

- [Centralized Management of TDE Master Encryption Keys Using Online Master Keys](#)
You can use an online master key to centralize the management of TDE master encryption keys over a direct network connection.

13.6 Endpoint okvclient.ora Configuration File

Oracle Key Vault endpoint libraries and utilities use the `okvclient.ora` configuration file, which stores the configuration parameters associated with the endpoint.

The `okvclient.ora` file consists of key-value pairs separated by an equal sign (=). At minimum, set the following parameters in the endpoint configuration file:

- `SERVER=node1_IP:node1_port/node1_DN,node2_IP:node2_port/node2_DN,...`
This parameter specifies the IP address and port number of the Oracle Key Vault server, separated by a colon. If the port number is not specified, then it defaults to the standard KMIP port 5696.
- `STANDBY_SERVER=standby_server_IP:standby_server_port`
This is the standby server. If primary-standby is configured, then this parameter shows the standby IP address.
- `READ_SERVER=node1_IP:node1_port/node1_DN,node2_IP:node2_port/node2_DN,...`
This parameter specifies the list of read-only servers.
- `SSL_WALLET_LOC=directory`
This parameter specifies the location of the wallet containing TLS credentials for the endpoint.
- `SERVER_POLL_TIMEOUT=timeout_value`
You can use the `SERVER_POLL_TIMEOUT` parameter to specify a timeout for a client's attempt to connect to an Oracle Key Vault server before trying the next server in the list. The default value is 300 (milliseconds).

In Oracle Key Vault clients first establish a non-blocking TCP connection to Oracle Key Vault to quickly detect unreachable servers.

After the first attempt, the client makes a second and final attempt to connect to the server but this time waits for twice as long as the duration specified by the `SERVER_POLL_TIMEOUT` parameter. This is done to overcome possible network congestion or delays.

The `CONF_ID` value in an `okvclient.ora` file is a unique internal value that helps an Oracle database to find its virtual wallet in Oracle Key Vault. Do not modify any settings in the `okvclient.ora` file. Instead, set endpoint configuration parameters through the Oracle Key Vault management console. Depending on your privileges, you can set these for individual endpoints or globally, for all endpoints.

Related Topics

- [Managing Endpoint Details](#)
Endpoint details refers to endpoint name, type, description, platform, and email, and adding the endpoint to a group, or upgrading the endpoint software.

13.7 Upgrading Endpoints

You can perform endpoint upgrades from either the Oracle Key Vault management console login page or from the endpoint.

- [Upgrading Endpoint Software from an Endpoint](#)
You can upgrade the endpoint software from the Oracle Key Vault management console login window.
- [Upgrading Endpoint Software on an Enrolled Endpoint](#)
You should upgrade the endpoint software on an enrolled endpoint any time you upgraded to a new release of Oracle Key Vault.

13.7.1 Upgrading Endpoint Software from an Endpoint

You can upgrade the endpoint software from the Oracle Key Vault management console login window.

- [Step 1: Prepare the Endpoint Environment](#)
Ensure that you have the correct privileges and that the endpoint has the correct configuration, such as Oracle environment variables.
- [Step 2: Download the Oracle Key Vault Software onto the Endpoint](#)
You download the `okvclient.jar` file to local computer.
- [Step 3: Install the Oracle Key Vault Software onto the Endpoint](#)
You must be the endpoint administrator to install the Oracle Key Vault software onto the endpoint.
- [Step 4: Perform Post-Installation Tasks](#)
After you complete the installation, you can configure a TDE connection for the endpoint and verify that the endpoint software was installed correctly.

13.7.1.1 Step 1: Prepare the Endpoint Environment

Ensure that you have the correct privileges and that the endpoint has the correct configuration, such as Oracle environment variables.

These steps assume that the endpoint has already been enrolled in a previous release of Oracle Key Vault.

1. Ensure that you have the necessary administrative privileges to install software on the endpoint.
2. Ensure that you have JDK 1.5 or later installed, and that the `PATH` environment variable includes the `java` executable (in the `JAVA_HOME/bin` directory).

Oracle Key Vault supports JDK versions 1.5, 1.6, 7, and 8. The 64-bit version of Java is required.

3. Run the shell utility `oraenv` or `source oraenv` command to set the correct environment variables on Oracle Database servers.
4. Check that the environment variables `ORACLE_BASE` and `ORACLE_HOME` are correctly set.

If you used `oraenv` to set these variables, then you must verify that `ORACLE_BASE` points to the root directory for Oracle Databases, and that `ORACLE_HOME` points to a sub-directory under `ORACLE_BASE` where an Oracle database is installed.

13.7.1.2 Step 2: Download the Oracle Key Vault Software onto the Endpoint

You download the `okvclient.jar` file to local computer.

You can download the endpoint software without having to reenroll the endpoint.

1. Log in to the endpoint server as the endpoint administrator.
2. Connect to the Oracle Key Vault management console.

For example:

`https://192.0.2.254`

The login page to the Oracle Key Vault management console appears. **Do not log in.**

3. In the lower-right corner of the login page under **Login**, click **Endpoint Enrollment and Software Download**.

The **Enroll Endpoint & Download Software** page appears.

4. At the top of the page, click the **Download Endpoint Software Only** tab.

5. In the Download Endpoint Software Only page, select the endpoint platform from the **Platform** drop down menu and click **Download**.
6. Save the file `okvclient.jar` to a desired location.

Related Topics

- [Environment Variables and Endpoint Provisioning Guidance](#)
Environment variables such as `JAVA_HOME` and `OKV_HOME` must be correctly set so that Oracle Key Vault can access its utilities.
- [Centralized Management of TDE Master Encryption Keys Using Online Master Keys](#)
You can use an online master key to centralize the management of TDE master encryption keys over a direct network connection.

13.7.1.3 Step 3: Install the Oracle Key Vault Software onto the Endpoint

You must be the endpoint administrator to install the Oracle Key Vault software onto the endpoint.

1. Ensure that you are logged in to the endpoint server as the endpoint administrator.
2. Navigate to the directory in which you saved the `okvclient.jar` file.
3. Confirm that the target directory exists, and that it is empty.
4. Run the `java` command to install the `okvclient.jar` file.

```
java -jar okvclient.jar -d c:\db\okv_home -v [-db112]
```

In this specification:

- `-d` specifies the directory location for the endpoint software and configuration files, in this case `c:\db\okv_home`.
- `-v` writes the installation logs to the `/home/oracle/okvutil/log/okvutil.deploy.log` file at the server endpoint.
- `-db112` applies only if the Oracle database is 11.2.0.4 and the endpoint platform is Windows.

`-o` is an optional argument that enables you to overwrite the symbolic link reference to `okvclient.ora` when `okvclient.jar` is deployed in a directory other than the original directory. This argument is used only when you re-enroll an endpoint.

If you are installing the `okvclient.jar` file on a Windows endpoint system that has Oracle Database release 11.2.0.4 **only**, then include the `-db112` option. (This option is not necessary for any other combination of endpoint platform or Oracle Database version.) For example:

```
java -jar okvclient.jar -d c:\db\okv_home\okvutil -v -db112
```

5. When you are prompted for a password, then perform either of the following two steps.

The optional password goes into two places: `okvutil` and in `ADMINISTER KEY MANAGEMENT`. With `okvutil`, only users who know that password can upload or download content to and from Oracle Key Vault. With `ADMINISTER KEY MANAGEMENT`, it becomes the password that you must use in the `IDENTIFIED BY password` clause. If you choose not to give a password, then `okvutil` upload and download commands will not prompt for a password, and the password for `ADMINISTER KEY MANAGEMENT` becomes `NULL`.

The choices for handling the password are as follows:

- If you want to create a password-protected wallet, at minimum enter a password between 8 and 30 characters and then press **Enter**. For better security, Oracle recommends that you include uppercase letters, lowercase characters, special characters, and numbers in the password. The following special characters are allowed: (.), comma (,), underscore (_), plus sign (+), colon (:), space.

```
Enter new Key Vault endpoint password (<enter> for auto-login):
Key_Vault_endpoint_password
Confirm new endpoint password: Key_Vault_endpoint_password
```

A password-protected wallet is an Oracle wallet file that store the endpoint's credentials to access Oracle Key Vault. This password will be required whenever the endpoint connects to Oracle Key Vault.

- Alternatively, enter no password and then press **Enter**.

A successful installation of the endpoint software creates the following directories:

- `bin`: contains the `okvutil` program, the `root.sh` and `root.bat` scripts, and the binary file `okveps.x64`
- `conf`: contains the configuration file `okvclient.ora`
- `jlib`: contains the Java library files
- `lib`: contains the file `liborapkcs.so`
- `log`: contains the log files
- `ssl`: contains the TLS-related files and wallet files. The wallet files contain the endpoint credentials to connect to Oracle Key Vault.

The `ewallet.p12` file refers to a password-protected wallet. The `cwallet.sso` file refers to an auto-login wallet.

Related Topics

- [Environment Variables and Endpoint Provisioning Guidance](#)
Environment variables such as `JAVA_HOME` and `OKV_HOME` must be correctly set so that Oracle Key Vault can access its utilities.
- [Centralized Management of TDE Master Encryption Keys Using Online Master Keys](#)
You can use an online master key to centralize the management of TDE master encryption keys over a direct network connection.

13.7.1.4 Step 4: Perform Post-Installation Tasks

After you complete the installation, you can configure a TDE connection for the endpoint and verify that the endpoint software was installed correctly.

1. Optionally, configure a TDE connection for the endpoint.

On UNIX platforms, the `liborapkcs.so` file contains the library that the Oracle database uses to communicate with Oracle Key Vault. On Windows platforms, the `liborapkcs.dll` file contains the library that the Oracle database uses to communicate with Oracle Key Vault.

If an endpoint uses online TDE master encryption key management by Oracle Key Vault, then you must perform this step.

- **On Oracle Linux x86-64, Solaris, AIX, and HP-UX (IA) installations:** Log in as the `root` user and then execute either of the following commands:

```
$ sudo bin/root.sh
```

Or:

```
$ su -  
# bin/root.sh
```

This command creates the directory tree `/opt/oracle/extapi/64/hsm/oracle/1.0.0`, changes ownership and permissions, then copies the PKCS#11 library into this directory.

- **On Windows installations:** Run the following command:

```
bin\root.bat
```

This command copies the `liborapkcs.dll` file to the `C:\oracle\extapi\64\hsm\oracle\1.0.0` directory.

2. Use a command such as `namei` or `ls -l` to confirm that a softlink was created in `ORACLE_BASE/okv/ORACLE_SID/okvclient.ora` to point to the real file in the `conf` subdirectory of the installation target directory.

If the `ORACLE_BASE` environment variable has not been set, then the softlink was created in `ORACLE_HOME/okv/ORACLE_SID`.

3. Run the `okvutil list` command to verify that the endpoint software installed correctly, and that the endpoint can connect to the Oracle Key Vault server.

```
$ ./okvutil list
```

If the endpoint is able to connect to Key Vault, then the `No objects found` message appears. If a `Server connect failed` message appears, then you must troubleshoot the installation for possible issues. Check that environment variables are correctly set. To get help on the endpoint software, execute the following command:

```
java -jar okvclient.jar -h
```

Output similar to the following appears:

```
Production on Fri Apr 12 15:03:01 PDT 2019  
Copyright (c) 1996, 2019 Oracle. All Rights Reserved.  
Usage:  
  java -jar okvclient.jar [-h | -help] [[-v | -verbose] [-d <destination  
  directory>] [-o]]  
  
Options:  
  -h or -help : Display command help.  
  -v or -verbose : Turn on the verbose mode. Logs will be written to files  
  under  
                  <destination directory>/log/ directory.  
  -d <destination directory> : Specify the software installation directory.  
  -o : Overwrite the current symbolic link to okvclient.ora.
```

13.7.2 Upgrading Endpoint Software on an Enrolled Endpoint

You should upgrade the endpoint software on an enrolled endpoint any time you upgraded to a new release of Oracle Key Vault.

This ensures that you have the latest software on both the Oracle Key Vault server and the endpoint. Oracle highly recommends this for optimum performance. Oracle Key Vault servers can work with endpoint software from the previous major release, but may not work properly with endpoint software that is older. To upgrade the software on an already enrolled endpoint you can download and install the software `okvclient.jar` on the endpoint. You do not need to reenroll the endpoint.

1. Log in to the endpoint server as the endpoint administrator.
2. Connect to the Oracle Key Vault management console.

For example:

```
https://192.0.2.254
```

The login page to the Oracle Key Vault management console appears. ***Do not log in.***

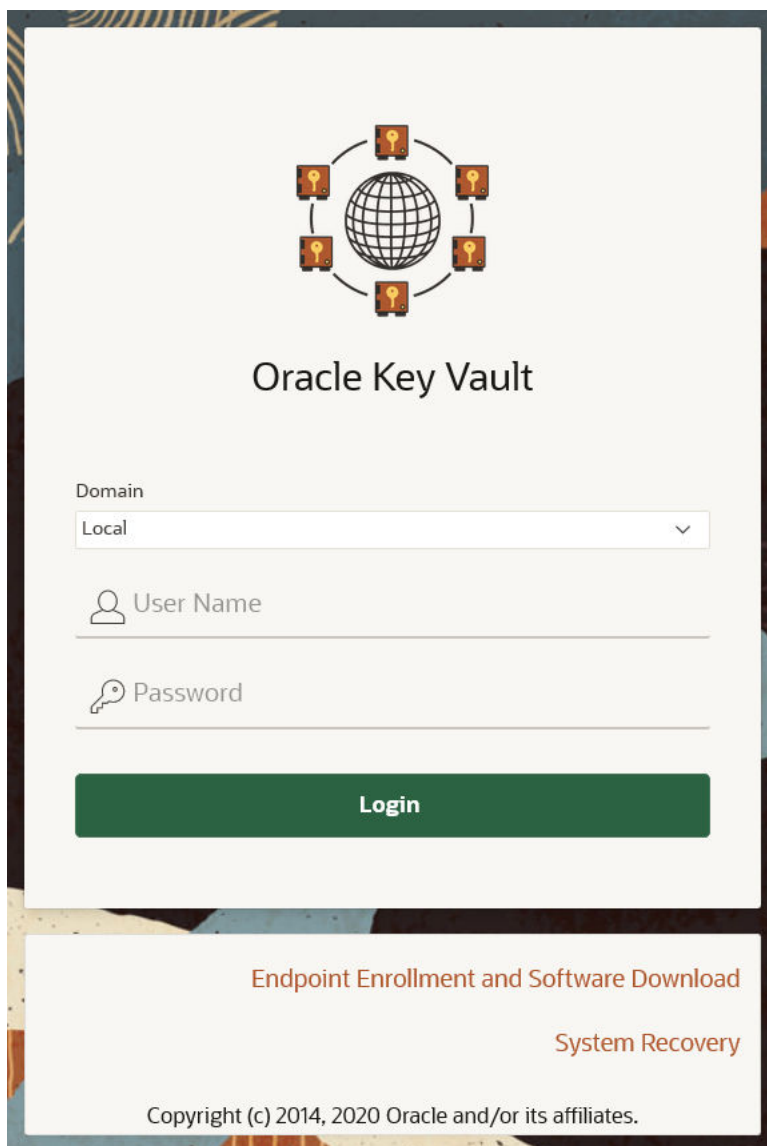

3. In the lower-right corner of the login screen, under **Login**, click **Endpoint Enrollment and Software Download**.
4. In the Enroll Endpoint & Download Software page, click **Download Endpoint Software Only**.

The Download Endpoint Software Only page appears.

5. Select the **Platform** from the drop-down list and then click **Download**.

A directory window appears, and prompts you to save the endpoint software file `okvclient.jar`. Navigate to the folder where you want to save the file.

6. Save the file to an appropriate directory.
7. Verify that the file is downloaded.

After you complete these steps, you can install the Oracle Key Vault software on the endpoint, using the same steps that can be used for an unenrolled endpoint. Oracle recommends that you extract the jar file in the existing endpoint directory because the upgrade endpoint software will not work otherwise. For example:

```
java -jar /path/to/okvclient.jar -d /path/to/existing/ep/files -v
```

Related Topics

- [Step 3: Install the Oracle Key Vault Software onto the Endpoint](#)
You must be the endpoint administrator to install the Oracle Key Vault software onto the endpoint.

14

Managing Keys for Oracle Products

You can use Oracle Key Vault with other Oracle features and products, such as Oracle GoldenGate or Oracle Data Guard.

- [Using a TDE-Configured Oracle Database in an Oracle RAC Environment](#)
Each Oracle Real Application Clusters (Oracle RAC) database has its own Oracle virtual wallet in Oracle Key Vault.
- [Using a TDE-Configured Oracle Database in an Oracle GoldenGate Environment](#)
Oracle Key Vault supports the use of Oracle wallets with Oracle GoldenGate shared secrets.
- [Using a TDE-Configured Oracle Database in an Oracle Data Guard Environment](#)
You can perform the activities such as uploading Oracle wallets or using online master keys in an Oracle Data Guard environment.
- [Uploading Keystores from Automatic Storage Management to Oracle Key Vault](#)
You can copy a keystore from Automatic Storage Management (ASM) to Oracle Key Vault and vice versa in a two-step process.
- [MySQL Integration with Oracle Key Vault](#)
You can manage TDE encryption keys in MySQL with Oracle Key Vault.
- [Other Oracle Database Features That Oracle Key Vault Supports](#)
You can deploy Transparent Data Encryption (TDE) in multiple topologies with other database features that move or use clustered deployments.

14.1 Using a TDE-Configured Oracle Database in an Oracle RAC Environment

Each Oracle Real Application Clusters (Oracle RAC) database has its own Oracle virtual wallet in Oracle Key Vault.

In an Oracle Real Application Clusters (Oracle RAC) environment, each Oracle RAC instance has its own endpoint in Oracle Key Vault; these endpoints share the same virtual wallet in Oracle Key Vault as their default wallet.

You can enable the cluster to share the virtual wallet by using either of the following approaches:

- If the Oracle RAC database is using TDE with individual wallets, then confirm that these wallets have the identical content. Execute the `mkstore -wrl /directory/to/TDE-wallet -list` command to compare the content of each wallet. If they all contain the same keys, then upload the content of one of them into the shared virtual wallet in Oracle Key Vault.
- If the Oracle RAC database is using TDE with a shared wallet (which is the recommended deployment), then upload that wallet to Oracle Key Vault.
- Establish an auto-open connection with Oracle Key Vault.

- Migrate the Oracle RAC database to Oracle Key Vault.

As with single-instance database environments, after you download a password-protected wallet, you must manually open it. If you have one wallet on the primary node and then download the wallet to the other nodes, then you must explicitly open the wallets on each of these nodes.

Each Oracle RAC node is a different endpoint of the database and has its own individual persistent cache. For Oracle RAC databases, you should initiate a query from each Oracle RAC node to cache the latest master encryption key in the Oracle RAC node for uninterrupted operations

Related Topics

- [About the Persistent Master Encryption Key Cache](#)
The persistent master encryption key cache ensures the availability of TDE master encryption keys.
- [Uploading Oracle Wallets](#)
The `okvutil upload` command uploads wallets to Oracle Key Vault.

14.2 Using a TDE-Configured Oracle Database in an Oracle GoldenGate Environment

Oracle Key Vault supports the use of Oracle wallets with Oracle GoldenGate shared secrets.

You can upload or migrate Oracle wallets that contain Oracle GoldenGate shared secrets and TDE master encryption keys to the Oracle Key Vault server.

- [Oracle Wallets in an Oracle GoldenGate Environment](#)
An Oracle GoldenGate shared secret can be in the same Oracle wallet where master encryption keys are stored.
- [Configuring Online Master Keys in an Oracle GoldenGate Deployment](#)
There are two configuration steps to using the online master key in an Oracle GoldenGate deployment.
- [Migration of TDE Wallets in Oracle GoldenGate to Oracle Key Vault](#)
Oracle wallets can contain both a TDE master encryption key and an Oracle GoldenGate shared secret.

14.2.1 Oracle Wallets in an Oracle GoldenGate Environment

An Oracle GoldenGate shared secret can be in the same Oracle wallet where master encryption keys are stored.

In an environment where Oracle Key Vault is not used and an Oracle TDE-enabled database is configured with an Oracle wallet with Oracle GoldenGate, this database (called the source database) stores an Oracle GoldenGate shared secret in the same Oracle wallet where master encryption keys are stored.

This means that when you configure the source database as an Oracle Key Vault endpoint, the Oracle GoldenGate shared secret is stored in Oracle Key Vault in the same virtual wallet where the master encryption keys are stored for the TDE-enabled source database.

When you migrate an Oracle wallet that contains an Oracle GoldenGate shared secret and TDE master encryption keys to Oracle Key Vault using the `okvutil` command-line utility, the default wallet for the TDE-enabled source database now stores the entire Oracle wallet migrated with shared secret and master encryption keys.

In addition, if the configured target database is an Oracle database, then you must ensure that this target database is TDE-enabled so that all the TDE commands can be replicated. The two Oracle TDE-enabled databases, source and target, do not need to have the same master encryption key in the Oracle wallet. If you configure this target database as a new Oracle Key Vault endpoint, then you can upload and download wallets to and from Oracle Key Vault as you normally would with any independent Oracle Key Vault endpoint. No additional configuration is necessary.

14.2.2 Configuring Online Master Keys in an Oracle GoldenGate Deployment

There are two configuration steps to using the online master key in an Oracle GoldenGate deployment.

1. Configure a connection between the source database in the GoldenGate deployment and Oracle Key Vault.
2. Configure the storage of Oracle GoldenGate secrets in the Oracle wallet on the source database.

At this stage, the configuration is complete. If you have configured the `sqlnet.ora` file correctly and completed the other configuration steps required for TDE on the source database, then when you set the encryption key (using either `ALTER SYSTEM SET ENCRYPTION KEY` or `ADMINISTER KEY MANAGEMENT SET ENCRYPTION KEY`), a TDE master encryption key is created in Oracle Key Vault. You can encrypt tables or create encrypted tablespaces in the database. The encrypted data created in the source database continues to be replicated on the target database after you perform this procedure. The other Oracle GoldenGate shared secrets are stored in Oracle Key Vault.

See Also:

- [Step 1: Configure the Oracle Key Vault Server Environment](#) for instructions to connect a source database in GoldenGate to Oracle Key Vault.
- *Oracle Database Advanced Security Guide* for more information on configuring the storage of Oracle GoldenGate secrets in the source database.

14.2.3 Migration of TDE Wallets in Oracle GoldenGate to Oracle Key Vault

Oracle wallets can contain both a TDE master encryption key and an Oracle GoldenGate shared secret.

In an Oracle GoldenGate environment with a TDE-configured database, an Oracle wallet contains both the TDE master encryption keys and the Oracle GoldenGate shared secret.

You can also configure target Oracle TDE-enabled databases that are used in this Oracle GoldenGate environment to use Oracle Key Vault or continue to use an Oracle wallet. You should treat these databases as you would any standalone TDE database endpoint.

After you complete this migration, the configuration is complete. If you have configured the `sqlnet.ora` file correctly and completed the other configuration required for TDE, then when you set the encryption key (using either `ALTER SYSTEM SET ENCRYPTION KEY` or `ADMINISTER KEY MANAGEMENT SET ENCRYPTION KEY`), a TDE master encryption key is created in Oracle Key Vault. You can continue to create and use encrypted tables or tablespaces in the database. The encrypted data created in the source database continues to be replicated on the target database after this procedure is performed.

Related Topics

- [Migration of TDE Wallets in Oracle GoldenGate to Oracle Key Vault](#)
Oracle wallets can contain both a TDE master encryption key and an Oracle GoldenGate shared secret.

14.3 Using a TDE-Configured Oracle Database in an Oracle Data Guard Environment

You can perform the activities such as uploading Oracle wallets or using online master keys in an Oracle Data Guard environment.

- [About Uploading Oracle Wallets in an Oracle Data Guard Environment](#)
The upload operation enables both a primary and standby to benefit from the use of Oracle wallets.
- [Uploading Oracle Wallets in an Oracle Data Guard Environment](#)
You can upload an Oracle wallet to an Oracle Data Guard environment.
- [Performing an Online Master Key Connection in an Oracle Data Guard Environment](#)
The procedure for performing a TDE direct connection in an Oracle Data Guard environment is the same as in a standard Oracle Database environment.
- [Migrating Oracle Wallets in an Oracle Data Guard Environment](#)
You can migrate an Oracle wallet in an Oracle Data Guard environment by using `okvutil` and `SQL*Plus`.
- [Reverse Migrating Oracle Wallets in an Oracle Data Guard Environment](#)
You can use `okvutil` and `SQL*Plus` to reverse migrate an Oracle wallet in an Oracle Data Guard environment.
- [Migrating an Oracle TDE Wallet to Oracle Key Vault for a Logical Standby Database](#)
You can migrate a TDE wallet to Oracle Key Vault to a logical standby database using Oracle Database release 12c or 18c.
- [Checking the Oracle TDE Wallet Migration for a Logical Standby Database](#)
You use `SQL*Plus` to check the migration.

14.3.1 About Uploading Oracle Wallets in an Oracle Data Guard Environment

The upload operation enables both a primary and standby to benefit from the use of Oracle wallets.

In an Oracle Data Guard environment with a TDE-enabled primary and standby databases using an Oracle wallet, you must physically copy the Oracle wallet file from the primary database to the standby and restart the managed recovery process after the initial TDE configuration or later, when you rekey the master encryption key on the primary database.

Whereas, when using Oracle Key Vault with a TDE-enabled Oracle Data Guard database, you must register the primary and standby databases in Oracle Key Vault as endpoints. You must ensure that the endpoints for the primary and all standby databases share the same virtual wallet.

This way, the primary and standby databases can benefit from centralized key management without the need of a manual copy of the wallet file from the primary database to the standby database.

In an Oracle Data Guard environment, for a persistent cache, a rekey operation on the primary database will cache the master encryption key in its own persistent cache. When the new redo logs from the primary are applied on the standby, only then will the standby fetch the new key from the Oracle Key Vault and cache it in the persistent cache of the standby. There is a time lag between the caching of the key in primary and the caching of the key in standby. Oracle recommends that you synchronize the primary and standby as soon as possible after the rekey operation. In addition, you should confirm the content of the persistent cache on the primary and standby databases with the following command:

```
$ okvutil list -t okv_persistent_cache -l /path_to_persistent_cache/
```

Related Topics

- [About the Persistent Master Encryption Key Cache](#)
The persistent master encryption key cache ensures the availability of TDE master encryption keys.

14.3.2 Uploading Oracle Wallets in an Oracle Data Guard Environment

You can upload an Oracle wallet to an Oracle Data Guard environment.

1. Register one endpoint each for the primary and standby databases.
2. Download the `okvclient.jar` file for each endpoint on the respective databases.
3. Ensure that the endpoint password is the same as the TDE wallet password if you must perform a migration or a reverse migration.
4. Ensure that both the primary and standby database endpoints use the same default virtual wallet.

Related Topics

- [Managing Endpoints](#)
You can enroll, reenroll, suspend, and delete endpoints.

14.3.3 Performing an Online Master Key Connection in an Oracle Data Guard Environment

The procedure for performing a TDE direct connection in an Oracle Data Guard environment is the same as in a standard Oracle Database environment.

Related Topics

- [Centralized Management of TDE Master Encryption Keys Using Online Master Keys](#)
You can use an online master key to centralize the management of TDE master encryption keys over a direct network connection.

14.3.4 Migrating Oracle Wallets in an Oracle Data Guard Environment

You can migrate an Oracle wallet in an Oracle Data Guard environment by using `okvutil` and SQL*Plus.

1. Use the `okvutil upload` command to upload the contents of the local Oracle wallet that is on the primary database to Oracle Key Vault.
2. Perform the steps to migrate the wallet, as described in [Migrating an Existing TDE Wallet to Oracle Key Vault](#).
3. Close the existing Oracle wallet on the standby database.

- For Oracle Database 11g release 2, as a user who has been granted the `ALTER SYSTEM` system privilege:

```
ALTER SYSTEM SET ENCRYPTION WALLET CLOSE  
IDENTIFIED BY "Key_Vault_endpoint_password";
```

- For Oracle Database 12c or later, as a user who has been granted the `SYSKM` administrative privilege:

```
ADMINISTER KEY MANAGEMENT SET KEYSTORE CLOSE  
IDENTIFIED BY "Key_Vault_endpoint_password";
```

4. Shut down the standby database.

For example:

```
SHUTDOWN IMMEDIATE
```

5. Restart the standby database.

For example:

```
STARTUP
```

6. Open the Oracle wallet.

- For Oracle Database 11g release 2, as a user who has been granted the `ALTER SYSTEM` system privilege:

```
ALTER SYSTEM SET ENCRYPTION WALLET OPEN  
IDENTIFIED BY "Key_Vault_endpoint_password";
```

- For Oracle Database 12c or 18c, as a user who has been granted the `SYSKM` administrative privilege:

```
ADMINISTER KEY MANAGEMENT SET KEYSTORE OPEN
IDENTIFIED BY "Key_Vault_endpoint_password";
```

7. Start the apply process on the standby database, as described in *Oracle Data Guard Concepts and Administration*.

Related Topics

- [okvutil upload Command](#)
The `okvutil upload` command uploads security objects to Oracle Key Vault.
- [Migrating Existing TDE Wallets to Oracle Key Vault](#)
A migrated TDE wallet can be used to restore database contents that were previously encrypted by TDE.
- *Oracle Data Guard Concepts and Administration*

14.3.5 Reverse Migrating Oracle Wallets in an Oracle Data Guard Environment

You can use `okvutil` and SQL*Plus to reverse migrate an Oracle wallet in an Oracle Data Guard environment.

1. Use the `okvutil download` command to download the Oracle wallet keys onto the primary database from Oracle Key Vault. Download these keys to a local keystore.
2. Perform a reverse migration, as described in *Oracle Database Advanced Security Guide*.
3. Close the existing Oracle wallet on the standby database.

- For Oracle Database 11g release 2:

```
ALTER SYSTEM SET ENCRYPTION WALLET CLOSE
IDENTIFIED BY "Key_Vault_endpoint_password";
```

- For Oracle Database 12c or 18c:

```
ADMINISTER KEY MANAGEMENT SET KEYSTORE CLOSE
IDENTIFIED BY "Key_Vault_endpoint_password";
```

4. Copy the Oracle wallet from the primary database to the standby database, as described in *Oracle Database Advanced Security Guide*.
5. Open the Oracle wallet on the standby database.

- For Oracle Database 11g release 2:

```
ALTER SYSTEM SET ENCRYPTION WALLET OPEN
IDENTIFIED BY "Key_Vault_endpoint_password";
```

- For Oracle Database 12c or 18c:

```
ADMINISTER KEY MANAGEMENT SET KEYSTORE OPEN
IDENTIFIED BY "Key_Vault_endpoint_password";
```

6. Start the apply process on the standby database, as described in *Oracle Data Guard Concepts and Administration*.

If the endpoint password and the local TDE wallet password are different, then use the auto-login HSM feature.

Related Topics

- [okvutil upload Command](#)
The `okvutil upload` command uploads security objects to Oracle Key Vault.

- *Oracle Data Guard Concepts and Administration*

14.3.6 Migrating an Oracle TDE Wallet to Oracle Key Vault for a Logical Standby Database

You can migrate a TDE wallet to Oracle Key Vault to a logical standby database using Oracle Database release 12c or 18c.

1. Register the primary and standby endpoints to have the same default virtual wallet.
2. If necessary, download and install the `okvclient.jar` file to each endpoint.
3. Perform the migration on the primary database.
4. Complete the SQL apply process on the logical standby and then restart the standby database, as described in *Oracle Data Guard Concepts and Administration*.
5. To check that the status that migration was successful, query the `V$ENCRYPTION_WALLET` dynamic view.

Related Topics

- [Migrating an Existing TDE Wallet to Oracle Key Vault](#)
You can use the `okvutil upload` command to start the migration of a TDE-enabled database from an existing TDE wallet to Oracle Key Vault.
- *Oracle Data Guard Concepts and Administration*

14.3.7 Checking the Oracle TDE Wallet Migration for a Logical Standby Database

You use SQL*Plus to check the migration.

In an Oracle Database Release 12c environment, after you have migrated an Oracle TDE wallet in a logical standby configuration, you can check the configuration.

1. In the standby database instance, log in to SQL*Plus.

For example:

```
sqlplus / as sysdba
```

2. Query the `WRL_TYPE` and `WALLET_ORDER` columns of the `V$ENCRYPTION_WALLET` dynamic view.

The `V$ENCRYPTION_WALLET` view tracks the primary keystore. If you have only a single wallet configured, then the `WALLET_ORDER` column is set to `SINGLE`. In a two-wallet or mixed configuration, the column is set to `PRIMARY` or `SECONDARY`, depending on where the active master encryption key is located.

For example, in the following, only a single wallet is configured:

```
SELECT WRL_TYPE, WALLET_ORDER FROM V$ENCRYPTION_WALLET;
```

```
WRL_TYPE          WALLET_ORDER
-----
FILE              SINGLE
```

In this query in a logical standby configuration, the active master encryption key has been migrated to an Oracle Key Vault virtual wallet:

```
SELECT WRL_TYPE, WALLET_ORDER FROM V$ENCRYPTION_WALLET;
```

WRL_TYPE	WALLET_ORDER
FILE	SECONDARY
HSM	PRIMARY

This query should show the HSM as the PRIMARY wallet in both the primary and standby database for the logical configuration.

14.4 Uploading Keystores from Automatic Storage Management to Oracle Key Vault

You can copy a keystore from Automatic Storage Management (ASM) to Oracle Key Vault and vice versa in a two-step process.

- [About Uploading Keystores from Automatic Storage Management to Oracle Key Vault](#)
Uploading a keystore from Oracle Automatic Storage Management (ASM) to Oracle Key Vault is a two-step process.
- [Uploading a Keystore from Automatic Storage Management to Oracle Key Vault](#)
You can use the `ADMINISTER KEY MANAGEMENT` statement to move a software keystore out of Automatic Storage Management (ASM).
- [Copying a Keystore from Oracle Key Vault to Automatic Storage Management](#)
You use both `okvutil download` and `SQL*Plus` to complete the copy process.

14.4.1 About Uploading Keystores from Automatic Storage Management to Oracle Key Vault

Uploading a keystore from Oracle Automatic Storage Management (ASM) to Oracle Key Vault is a two-step process.

1. Copy the keystore from ASM to the file system.
2. Upload the keystore from the file system to Oracle Key Vault.

Copying a keystore from ASM to the file system or vice versa requires the keystore merge operation that merges one software keystore to an existing key store. Therefore, in order to copy a keystore from a source path to a target path, a keystore must exist at the target path.

14.4.2 Uploading a Keystore from Automatic Storage Management to Oracle Key Vault

You can use the `ADMINISTER KEY MANAGEMENT` statement to move a software keystore out of Automatic Storage Management (ASM).

1. Initialize a target keystore on the file system with the following SQL statement:

```
ADMINISTER KEY MANAGEMENT CREATE KEYSTORE targetKeystorePath
IDENTIFIED BY targetKeystorePassword;
```

In this specification:

- *targetKeystorePath* is the directory path to the target keystore on the file system.
- *targetKeystorePassword* is a password that you create for the keystore.

For example:

```
ADMINISTER KEY MANAGEMENT CREATE KEYSTORE '/etc/ORACLE/KEYSTORE/DB1/'  
IDENTIFIED BY "destination_password";
```

In this specification, */etc/ORACLE/KEYSTORE/DB1/* is the path to the target keystore in the file system and *destination_password* is the keystore password.

You now can copy the keystore from ASM to the target keystore.

2. Copy the keystore from ASM to the target keystore that you just created.

This step requires that you merge the keystore from ASM to the file system as follows:

```
ADMINISTER KEY MANAGEMENT MERGE KEYSTORE srcKeystorePath  
IDENTIFIED BY srcKeystorePassword  
INTO EXISTING KEYSTORE targetKeystorePath  
IDENTIFIED BY targetKeystorePassword  
WITH BACKUP USING backupIdentifier;
```

In this specification:

- *srcKeystorePath* is the directory path to the source keystore.
- *srcKeystorePassword* is the source keystore password.
- *targetKeystorePath* is the path to the target keystore.
- *targetKeystorePassword* is the target keystore password.
- *backupIdentifier* is the backup identifier to be added to the backup file name.

For example:

```
ADMINISTER KEY MANAGEMENT MERGE KEYSTORE '+DATAFILE' IDENTIFIED BY  
"srcPassword" INTO EXISTING KEYSTORE '/etc/ORACLE/KEYSTORE/DB1/' IDENTIFIED  
BY "destination_password" WITH BACKUP USING "bkup";
```

The keystore is copied to the file system and can now be uploaded to Oracle Key Vault.

3. Upload keystore from file system to Oracle Key Vault by using the `okvutil upload` command.

```
$ okvutil upload -l location -t type
```

In this specification:

- *location* is the path to the target keystore in the file system
- *type* is `wallet`

For example:

```
$ okvutil upload -l /etc/ORACLE/KEYSTORE/DB1 -t wallet
```

14.4.3 Copying a Keystore from Oracle Key Vault to Automatic Storage Management

You use both `okvutil download` and SQL*Plus to complete the copy process.

To copy a keystore from Oracle Key Vault to Automatic Storage Management (ASM), use the reverse procedure from copying the keystore from ASM to Oracle Key Vault.

1. Initialize a target keystore on the file system, *if the keystore does not exist*.

If the keystore does exist on the file system, then bypass this step.

2. Copy the keystore from Oracle Key Vault to the target keystore on the file system using the `okvutil download` command.

```
$ okvutil download -l location -t type
```

In this specification:

- `location` is the path to the target keystore in the file system
- `type` is `wallet`

For example:

```
$ okvutil download -l /etc/ORACLE/KEYSTORE/DB1 -t wallet
```

3. Initialize a keystore on the ASM instance by using the following SQL statement:

```
ADMINISTER KEY MANAGEMENT CREATE KEYSTORE asmKeystorePath  
IDENTIFIED BY asmKeystorePassword;
```

In this specification:

- `asmKeystorePath` is the directory path for the keystore on the ASM file system.
- `asmKeystorePassword` is a password that you create for the keystore.

4. Copy the keystore to the initialized ASM keystore that you just created.

This step requires that you merge the keystore from the file system to ASM as follows:

```
ADMINISTER KEY MANAGEMENT MERGE KEYSTORE srcKeystorePath  
IDENTIFIED BY srcKeystorePassword  
INTO EXISTING KEYSTORE asmKeystorePath  
IDENTIFIED BY asmKeystorePassword  
WITH BACKUP USING backupIdentifier;
```

In this specification:

- `srcKeystorePath` is the directory path to the source keystore.
- `srcKeystorePassword` is the source keystore password.
- `asmKeystorePath` is the path to the ASM keystore.
- `asmKeystorePassword` is the ASM keystore password.
- `backupIdentifier` is the backup identifier to be added to the backup file name.

14.5 MySQL Integration with Oracle Key Vault

You can manage TDE encryption keys in MySQL with Oracle Key Vault.

Oracle Key Vault supports integration with MySQL from Release 12.2 or later.



Note:

MySQL Windows databases are not supported.

Oracle Key Vault can manage MySQL TDE encryption keys.

14.6 Other Oracle Database Features That Oracle Key Vault Supports

You can deploy Transparent Data Encryption (TDE) in multiple topologies with other database features that move or use clustered deployments.

Data movement and replication are major challenges for Oracle Advanced Security TDE because it must keep the master encryption key synchronized at both endpoints. To help with these challenges, Oracle Key Vault supports common Oracle Database features.

To move data, Oracle Key Vault supports the following:

- Oracle Recovery Manager (RMAN) backup and recovery operations
- Oracle Data Pump
- Transportable tablespaces (Oracle Database 12c or later)

For clustered deployments, Oracle Key Vault supports the following:

- Oracle Data Guard
- Oracle Real Application Clusters (Oracle RAC)
- Oracle GoldenGate

15

Managing Online and Offline Secrets

You can store and manage credential files in Oracle Key Vault as opaque objects that an endpoint can retrieve when needed.

- [Uploading and Downloading Credential Files](#)
The `okvutil upload` and `okvutil download` commands can upload and download credential files.
- [Managing Secrets and Credentials for SQL*Plus](#)
To manage passwords in SQL*Plus scripts for a large number of Oracle databases, you can upload the passwords to Oracle Key Vault.
- [Managing Secrets and Credentials for SSH](#)
You can perform public key authentication with private keys that are protected in Oracle Key Vault.
- [Centrally Managing Passwords in Oracle Key Vault](#)
You can centrally manage passwords in Oracle Key Vault by using external keystores or adding them to shared virtual wallets as secrets.

15.1 Uploading and Downloading Credential Files

The `okvutil upload` and `okvutil download` commands can upload and download credential files.

- [About Uploading and Downloading Credential Files](#)
You use the `okvutil` utility to upload and download credential files.
- [Uploading a Credential File](#)
The `okvutil upload` command can upload credential files.
- [Downloading a Credential File](#)
The `okvutil download` command can download credential files.
- [Guidelines for Uploading and Downloading Credential Files](#)
Oracle provides recommendations for when you upload and download credential files.

15.1.1 About Uploading and Downloading Credential Files

You use the `okvutil` utility to upload and download credential files.

Credential files are uploaded and stored as opaque objects in Oracle Key Vault, which means that Oracle Key Vault does not parse the contents of the file like an Oracle wallet or Java keystore. The upload process does not alter the credential file.

Examples of opaque objects are as follows:

- Files that contain X.509 certificates
- Kerberos keytabs

- Files containing passwords
- Files containing SSH keys

Uploading these credential files provides a central, secure location for long-term retention. After you have uploaded a credential file, you can download it in the same server location or share it with other trusted servers. Oracle Key Vault supports credential files up to 128 KB in size.

You can place the credential file anywhere in your server infrastructure (which includes database servers and application servers) that is accessible by an Oracle Key Vault endpoint.

15.1.2 Uploading a Credential File

The `okvutil upload` command can upload credential files.

1. Ensure that the server that contains the credential file has been enrolled and provisioned as an Oracle Key Vault endpoint.
2. Ensure that access control has been configured for the endpoint.

If you are uploading the credential file to a virtual wallet, then ensure that the endpoint has read, modify, and manage wallet access to the wallet.

3. Run the `okvutil upload` command.

For example:

```
# okvutil upload -l "/etc/oracle/app/creds/hr.keytab" -t kerberos -g
HRWallet -d "Kerberos keytab file for HR group, 06_11_14"
Enter Oracle Key Vault endpoint password: Key_Vault_endpoint_password
```

In this example:

- `-l` is the directory path to the `hr.keytab` credential file, which is being uploaded. Enclose the directory location in double quotation marks.
- `-t` specifies the type of credential file, which in this example is a Kerberos keytab file. In addition to `KERBEROS`, other types that you can specify are as follows:
 - `SSH` for an SSH key file
 - `OTHER` for other files that store secrets, such as uploaded or downloaded files
- `-g` adds the credential file to the virtual wallet `HRWallet`, which must already exist. This parameter enables you to upload the credential to a wallet that is specifically for the HR application users' needs, rather than to the default virtual wallet. In this example, `HRWallet` is the Oracle Key Vault virtual wallet to which access control was configured in Step 2.
- `-d` is an optional description. As a best practice, include a brief description of what the credential file is used for and the date you performed the upload. This information helps for future reference and tracking of the credential file. You can modify this description later on in the Oracle Key Vault management console if necessary.

Related Topics

- [okvutil upload Command](#)
The `okvutil upload` command uploads security objects to Oracle Key Vault.

- [Managing Endpoints](#)
You can enroll, reenroll, suspend, and delete endpoints.
- [Granting Access to Users, User Groups, Endpoints, and Endpoint Groups](#)
You can grant the **Read Only**, **Read and Modify**, and **Manage Wallet** access levels to users, user groups, endpoints, and endpoint groups.

15.1.3 Downloading a Credential File

The `okvutil download` command can download credential files.

1. Find the unique ID of the credential file that you must download, by using one of the following methods:
 - **Oracle Key Vault management console:** Log in as user who has the necessary access to the virtual wallet. In the Oracle Key Vault management console, from the **Keys & Wallets** tab, select **Keys, Secrets & Objects** to find the uploaded files. Note the unique ID of the uploaded file that you want to download. Credential files are listed as opaque objects.
 - **okvutil list command:** Run the `okvutil list` command from an endpoint that has access to the credential file or a virtual wallet that contains the credential file. Locate the unique ID of the credential file that you must download based on the description that you provided when you uploaded the file.
2. From the command line, run the `okvutil download` command to download the credential file.

For example:

```
# okvutil download -l "/etc/oracle/app/newcreds/hr.keytab" -t kerberos -i  
6ba7b810-9dad-11d1-80b4-00c04fd430c8  
Enter Oracle Key Vault endpoint password: Key_Vault_endpoint_password
```

In this example:

- `-l` is the directory to which you want to download the uploaded credential.
- `-t` specifies the type of credential file, which in this example is a Kerberos keytab file. In addition to `KERBEROS`, other types that you can specify are as follows:
 - `SSH` for an SSH key file
 - `OTHER` for other files that store secrets, such as uploaded or downloaded files
- `-i` is the unique ID of the credential file.

Related Topics

- [okvutil upload Command](#)
The `okvutil upload` command uploads security objects to Oracle Key Vault.

15.1.4 Guidelines for Uploading and Downloading Credential Files

Oracle provides recommendations for when you upload and download credential files.

- After you complete the upload, upload the credential file again the next time it is changed. Otherwise, the uploaded (and subsequent downloaded version) file will be outdated. Periodically, you should compare the last modification date of the credential file with the timestamp of the uploaded version.

- Use care if you use the `okvutil upload` and `okvutil download` commands, which provide an overwrite (`-o`) option. This option overwrites the uploaded credential file. You may want to create backups of the credential files before beginning the upload and download processes.
- You can share one credential file among multiple server endpoints. Add the credential file as an opaque object to a virtual wallet using the `-g` option of the `okvutil upload` command. Grant access of that virtual wallet to all the server endpoints. Optionally, define an endpoint group and then make all the server endpoints members of that endpoint group. Grant this endpoint group access to that virtual wallet. Afterward, all the members of the group will have access to that wallet.

Related Topics

- [About Configuring Alerts](#)
System administrators can configure alerts from the Oracle Key Vault dashboard, but all users can see alerts for the security objects to which they have access.

15.2 Managing Secrets and Credentials for SQL*Plus

To manage passwords in SQL*Plus scripts for a large number of Oracle databases, you can upload the passwords to Oracle Key Vault.

Many large sites use automated scripts to log in to Oracle databases to perform regular maintenance activities such as Oracle Recovery Manager (Oracle RMAN) backups, batch loading into an Oracle Database data warehouse, and similar tasks. Usually these scripts must connect as a highly privileged user. Logging in as a highly privileged user means that the scripts must have access to the user's password. Hard-coding a clear-text password into a script is, of course, very poor security. And if the user's password changes, then none of the scripts can work. One solution to avoiding the use of clear-text passwords in scripts is to put the passwords into an auto-open wallet (called the secure external password store) and then instruct the client application to retrieve the password from there. However, this idea only works if you only have a few databases. But if you have hundreds of databases, then the passwords are difficult to manage and require an update for each secure external password store.

If you have a large number of Oracle databases, you can store passwords centrally and then retrieve them securely for database connections. This capability has the following advantages:

- Eliminates clear-text passwords from your maintenance scripts
- Simplifies password changes
- Does not require extra entries in the `sqlnet.ora` file
- Makes the secure external password store obsolete

Related Topics

- [Sharing Secrets with Other Databases](#)
Sharing information in Oracle Key Vault requires a virtual wallet in Oracle Key Vault, and multiple databases connecting into their own endpoints that have access to the shared wallet.

15.3 Managing Secrets and Credentials for SSH

You can perform public key authentication with private keys that are protected in Oracle Key Vault.

In many IT departments, public key authentication is the default approach to securely log into remote servers without having an administrator having to remember the password, for both on-premise or cloud-based hosts. If you are using Oracle Cloud Infrastructure (Oracle OCI), then the password of the user `opc` is unknown, so public key authentication is the only way to log into an OCI compute instance. This method is convenient, but not without risk. If the private key is lost, then remotely logging in is no longer possible. In addition, the process of provisioning a new public key is time consuming. Another problem is that because the private key uniquely identifies its owner, if it is stolen, copied, or compromised, then an intruder can easily cause a great deal of trouble, with the evidence pointing at the owner, not the intruder.

As a solution to these problems, consider uploading the SSH private keys into Oracle Key Vault by using the `okvutil upload` command. The benefits are as follows:

- Because the SSH keys are not on your host computer, they cannot be copied or stolen, and furthermore, they are safe from disk or file corruptions.
- The SSH keys are included in Oracle Key Vault backup operations, so losing them is impossible.
- Oracle Key Vault provides continuous and fault-tolerant availability by allowing up to 16 Oracle Key Vault servers to connect to one multi-master cluster. Read-write pairs guarantee that highly sensitive information (such as encryption keys or passwords) are replicated to at least one or more Oracle Key Vault servers.

Related Topics

- [okvutil upload Command](#)
The `okvutil upload` command uploads security objects to Oracle Key Vault.

15.4 Centrally Managing Passwords in Oracle Key Vault

You can centrally manage passwords in Oracle Key Vault by using external keystores or adding them to shared virtual wallets as secrets.

- [About Centrally Managing Passwords in Oracle Key Vault](#)
You can store passwords centrally in Oracle Key Vault and retrieve these passwords securely (for example, when logging into an Oracle database).
- [Creating and Sharing Centrally Managed Passwords](#)
To create and share centrally managed passwords (external keystore passwords) for large database deployments, you first must use an Oracle Key Vault client and RESTful services commands.
- [Example: Script for Using External Keystore Passwords in SQL*Plus Operations](#)
You can create a script that retrieves the UUID of uploaded passwords by the user name and then inserts the password into the SQL*Plus command.
- [Sharing Secrets with Other Databases](#)
Sharing information in Oracle Key Vault requires a virtual wallet in Oracle Key Vault, and multiple databases connecting into their own endpoints that have access to the shared wallet.

- [Changing Passwords for a Large Database Deployment](#)
For better security, on a regular basis, you should change passwords that are used by both humans and automated processes.

15.4.1 About Centrally Managing Passwords in Oracle Key Vault

You can store passwords centrally in Oracle Key Vault and retrieve these passwords securely (for example, when logging into an Oracle database).

Storing passwords centrally in Oracle Key Vault has the following benefits:

- It eliminates the need for clear text passwords in your maintenance scripts.
- It eliminates the need for the secure external password store.
- It simplifies password changes.
- It does not require changes to the `sqlnet.ora` file.

Database administrators often use automated scripts to perform regular maintenance such as Oracle Recovery Manager (Oracle RMAN) backups, loading data into Oracle Data Warehouse, or refreshing materialized views. These scripts log in to the Oracle Database with the passwords of highly privileged users, which unfortunately is a poor security practice in that it entails hard-coded clear-text passwords in the script. And of course if the password changes, then all the scripts must be changed as well. One way to remove the need for clear-text passwords is to put the passwords into an auto-open wallet (called the secure external password store) and instruct the client to retrieve the password from there. This practice works well for a few databases, but if you have hundreds of databases, it is difficult to manage. Furthermore, password changes require you to update every secure external password store. By storing passwords in a central location, you eliminate this problem.

15.4.2 Creating and Sharing Centrally Managed Passwords

To create and share centrally managed passwords (external keystore passwords) for large database deployments, you first must use an Oracle Key Vault client and RESTful services commands.

1. Ensure that you have installed the Oracle Key Vault RESTful command-line interface.

If you do not have the RESTful command-line interface installed, then you can download it from the Oracle Key Vault management console as follows:

```
curl -O -k https://Oracle_Key_Vault_IP_address:5695/  
okvrestclipackage.zip
```

2. Install an Oracle Key Vault client that does not use a password.

If you already have an Oracle Key Vault client installed (for example, for TDE key management), then do not use this endpoint. Instead, install an additional endpoint for secrets management. You must use an Oracle Key Vault client that is not password protected.

To install the Oracle Key Vault client without a password, execute the following RESTful commands:

```
okv admin endpoint create --endpoint endpoint_name
--description "Secrets management for endpoint_name" --type ORACLE_NON_DB
--platform platform_OS
```

```
okv admin endpoint provision --endpoint endpoint_name
--location installation_directory --auto-login TRUE
```

For this use case, executing the `root` script is not needed.

3. Upload the passwords for your database accounts to Oracle Key Vault.

- a. Create text files that contain the names and passwords for each account that you want to upload. For example, suppose you have two maintenance scripts that log into the database. The first script uses an RMAN account `nightly_backup`, which logs into the PDB as Oracle Recovery Manager (Oracle RMAN) with the `SYSBACKUP` administrative privilege. The second script uses the `refresh_dwh` account, which refreshes a data warehouse by connecting to a PDB.

The following shows the password text files for each account.

```
$ more backup_pwd
hV3t0ksxoSQIEe4VoF237o7t
```

```
$ more refresh_pwd
NfKmXHAI65kxqVqx2yiOd49s
```

- b. Register user names and passwords in Oracle Key Vault.

First, the `nightly_backup` account is uploaded, followed by the `refresh_dwh` account. Oracle Key Vault returns the universally unique ID (UUID) of each of these managed objects. First, the registration:

- Register the secret for the first managed object.
First, generate JSON input:

```
okv managed-object secret register --generate-json-input > ./
reg_backup.json
```

Edit the options and attributes in the generated JSON input file, `reg_backup.json`:

```
{
  "service" : {
    "category" : "managed-object",
    "resource" : "secret",
    "action" : "register",
    "options" : {
      "object" : "./backup_pwd",
      "type" : "PASSWORD",
      "mask" : "ENCRYPT",
      "attributes" : {
        "name" : "NIGHTLY_BACKUP"
```

```

    }
  }
}

```

Perform the registration.

```

okv managed-object secret register --from-json ./
reg_backup.json

```

- Register the secret for the second managed object.
First, generate JSON input:

```

okv managed-object secret register --generate-json-input > ./
reg_refresh.json

```

Edit the options and attributes in the generated JSON input file,
reg_refresh.json:

```

{
  "service" : {
    "category" : "managed-object",
    "resource" : "secret",
    "action" : "register",
    "options" : {
      "object" : "./refresh_pwd",
      "type" : "PASSWORD",
      "mask" : "ENCRYPT",
      "attributes" : {
        "name" : "REFRESH_DWH"
      }
    }
  }
}

```

Perform the registration.

```

okv managed-object secret register --from-json ./
reg_refresh.json

```

4. On Linux, securely delete the file that contain passwords.

```

shred -xzu ./backup_pwd

```

5. Use the returned UUID values from the previous step to activate the secrets.

```

$ okv managed-object object activate --uuid 581D9330-5458-4FD2-BFF4-
C0BF602644F4

```

```

$ okv managed-object object activate --uuid 9E8AB7E0-0915-4FB4-BFE1-
A85696525EA4

```

After you complete this configuration, you can create a script that retrieves the password for these users from Oracle Key Vault and inserts the password into the SQL*Plus commands.

Related Topics

- [Example: Script for Using External Keystore Passwords in SQL*Plus Operations](#)
You can create a script that retrieves the UUID of uploaded passwords by the user name and then inserts the password into the SQL*Plus command.

15.4.3 Example: Script for Using External Keystore Passwords in SQL*Plus Operations

You can create a script that retrieves the UUID of uploaded passwords by the user name and then inserts the password into the SQL*Plus command.

The benefit of this script is that no matter how many administrative or maintenance scripts log into that database, the script stays the same. For each new user account, you only upload the password and attributes file for the user, and then activate the secret.

For example, a script called `log-me-in.sh` can be as follows:

```
#!/bin/bash
set +x
user="${1}"
export TWO_TASK="${2}"
PRIV="${3}"
KMIP_ID=$(okv managed-object object locate --name $user | jq -r
'value.uuid')
pwd=$(okv managed-object secret get --uuid ${KMIP_ID:1:36} | jq -r
'value.object')
if [ "${PRIV}" == 'AS SYSBACKUP' ]; then
    rman target ''''${user}/${pwd}@${TWO_TASK} ${PRIV}''''
else
    sqlplus "${user}/${pwd}"
fi
```

You can make this file immutable by applying extended attributes. For example, in Linux as the `root` user, use the following `chattr` command:

```
# chattr +i log-me-in.sh
```

To execute this script, use the following syntax:

```
$ ./log-me-in.sh user_name hostname:port/service 'AS privilege'
```

For example to log in the `nightly_backup` user:

```
$ ./log-me-in.sh nightly_backup sales19c.us.example.com:1521/
finpdb.us.example.com 'AS SYSBACKUP'
```

Output similar to the following appears:

```
Recovery Manager: Release 19.0.0.0.0 - Production on Fri Jun 26  
12:22:04 2020  
Version 19.7.0.0.0
```

```
Copyright (c) 1982, 2019, Oracle and/or its affiliates. All rights  
reserved.
```

```
connected to target database: sales19c:finpdb (DBID=3200396863)
```

```
RMAN>
```

The following example command logs in as the `refresh_dwh` user:

```
$ ./log-me-in.sh refresh_dwh sales19c.us.example.com:1521/  
finpdb.us.example.com
```

```
SQL> SHOW USER  
REFRESH_DWH
```

If the owner of the target schema allows the `refresh_dwh` account user to log in, then the schema owner must grant the `CONNECT THROUGH` privilege to `refresh_dwh`, as follows:

1. In SQL*Plus, execute the `ALTER USER` statement to create the proxy. For example:

```
ALTER USER HR GRANT CONNECT THROUGH refresh_dwh;
```

2. In the script, change the last line (`sqlplus "${user}" / "${pwd}"`) to include the proxy. For example, to include HR:

```
sqlplus "${user}" [HR] / "${pwd}"
```

Related Topics

- [Creating and Sharing Centrally Managed Passwords](#)
To create and share centrally managed passwords (external keystore passwords) for large database deployments, you first must use an Oracle Key Vault client and RESTful services commands.

15.4.4 Sharing Secrets with Other Databases

Sharing information in Oracle Key Vault requires a virtual wallet in Oracle Key Vault, and multiple databases connecting into their own endpoints that have access to the shared wallet.

1. Log in to the server from which you want to share the secret (the source server).
2. Create a virtual wallet and make it the default wallet of the endpoint.

For example, to make a default wallet for an endpoint called `secrets_db_name`:

```
okv manage-access wallet create --wallet shared_secrets
okv manage-access wallet set-default --wallet shared_secrets --endpoint
secrets_db_name
```

3. Add the secret (password) to the shared virtual wallet.

```
okv managed-object wallet add-member --uuid 994CB3E5-C5B3-4F75-BFED-
CB41AE15D0B1 --wallet shared_secrets
```

994CB3E5-C5B3-4F75-BFED-CB41AE15D0B1 is the UUID for the secret. In the event that you have forgotten the UUID, you can retrieve it. For example, to retrieve the UUID for `nightly_backup`:

```
$ okv managed-object object locate --name nightly_backup
```

4. Log in to the server that will use the shared secret (the destination server).
5. Create an endpoint, and then make the `shared_secrets` wallet the default wallet of that new endpoint:

```
okv admin endpoint create --endpoint secrets_db_name --description
"Endpoint for Secrets Management in db_name" --type ORACLE_NON_DB --
platform LINUX64
okv manage-access wallet set-default --wallet shared_secrets --endpoint
secrets_db_name
okv admin endpoint provision --endpoint secrets_db_name --location /
directory/for/new/endpoint/ --auto-login TRUE
```

6. Securely copy the script that you created (for example, `log-me-in.sh`) from its source server to the destination server that will use the shared secret.

```
$ scp log-me-in.sh destination_server:/remote_path
```

7. In the destination server, use the following syntax to execute the script:

```
$ ./log-me-in.sh user_name hostname:port/service 'AS privilege'
```

For example:

```
$ ./log-me-in.sh nightly_backup 192.0.2.1:1521/hr_pdb 'AS SYSBACKUP'
```

Output similar to the following should appear:

```
Recovery Manager: Release 19.0.0.0.0 - Production on Fri Jun 26 13:10:49
2020
Version 19.7.0.0.0
```

```
Copyright (c) 1982, 2019, Oracle and/or its affiliates. All rights
reserved.
```

```
connected to target database: hr_db:hr_pdb (DBID=1932795327)
```

```
RMAN>
```

Related Topics

- [Example: Script for Using External Keystore Passwords in SQL*Plus Operations](#)
You can create a script that retrieves the UUID of uploaded passwords by the user name and then inserts the password into the SQL*Plus command.

15.4.5 Changing Passwords for a Large Database Deployment

For better security, on a regular basis, you should change passwords that are used by both humans and automated processes.

To change the passwords that are stored in Oracle Key Vault, you revoke and destroy the old password, and then upload and activate the new password. Finally, you must change the password in SQL*Plus.

1. Log in to a server that has access to the stored password.
2. Retrieve the UUID of this password.

```
$ okv managed-object object locate --name nightly_backup
```

UUID output similar to the following appears:

```
994CB3E5-C5B3-4F75-BFED-CB41AE15D0B1
```

3. Use this UUID to revoke this password.

```
$ okv managed-object object revoke --code CESSATION_OF_OPERATION --  
uuid 994CB3E5-C5B3-4F75-BFED-CB41AE15D0B1
```

You must provide a code for revoking the password. Possible values are as follows:

- UNSPECIFIED
- KEY_COMPROMISE
- CA_COMPROMISE
- AFFILIATION_CHANGED
- SUPERSEDED
- CESSATION_OF_OPERATION
- PRIVILEGE_WITHDRAWN

4. Destroy this password.

```
$ okv managed-object object destroy --uuid 994CB3E5-C5B3-4F75-BFED-  
CB41AE15D0B1
```

5. In the Oracle Key Vault management console, delete the secret.

6. Create a text file to contain the new password, similar to the original password text file that was used to configure the original external keystore password.

```
$ more backup_pwd
cn0KpOnY9vNec2sLVHFfJwR6
```

7. Upload the new password and attributes, and then activate the new secret.

- a. Generate JSON output.

```
okv managed-object secret register --generate-json-input >
reg_secret.json
```

- b. Check the generated output.

```
$ more reg_secret.json

{
  "service" : {
    "category" : "managed-object",
    "resource" : "secret",
    "action" : "register",
    "options" : {
      "object" : "./backup_pwd",
      "type" : "PASSWORD",
      "mask" : "ENCRYPT",
      "attributes" : {
        "name" : "NIGHTLY_BACKUP"
      }
    }
  }
}
```

- c. Perform the registration.

```
okv managed-object secret register --from-json ./reg_secret.json
```

- d. Activate the secret.

```
$ okv managed-object object activate --uuid 0739649D-3058-4F34-
BF84-50B2BD652C2D
```

8. On Linux, securely delete the file that contain passwords.

```
shred -xz backup_pwd
rm backup_pwd
```

9. In each Oracle database that shares the secret, log in to SQL*Plus and use the `password` command to change the password.

For example:

```
SYS> password nightly_backup
Changing password for nightly_backup
New password: cn0KpOnY9vNec2sLVHFfJwR6
```

Retype new password: cn0KpOnY9vNec2sLVHFnJwR6
Password changed

Related Topics

- [Destroying a Key or Security Object](#)
When a key is no longer used or compromised in some way, then you can destroy it.

16

Oracle Key Vault General System Administration

General system administration refers to system management tasks for the Oracle Key Vault server, such as configuring network details and services.

- [Overview of Oracle Key Vault General System Administration](#)
System administrators can perform most general administration tasks in the Oracle Key Vault management console, including finding the current status of the overall system.
- [Configuring Oracle Key Vault in a Non-Multi-Master Cluster Environment](#)
On the system Settings page, you can configure settings for either a standalone environment or a primary-standby environment.
- [Configuring Oracle Key Vault in a Multi-Master Cluster Environment](#)
When you configure Oracle Key Vault in a multi-master cluster environment, you can configure either individual nodes or the entire multi-master cluster environment.
- [Managing System Recovery](#)
System recovery includes tasks such as recovering lost administrative passwords.
- [Support for a Primary-Standby Environment](#)
To ensure that Oracle Key Vault can always access security objects, you can deploy Oracle Key Vault in a primary-standby (highly available) configuration.
- [Commercial National Security Algorithm Suite Support](#)
You can use scripts to perform Commercial National Security Algorithm (CNSA) operations for Oracle Key Vault HSM backup and upgrade operations.
- [Minimizing Downtime](#)
Business-critical operations require data to be accessible and recoverable with minimum downtime.

16.1 Overview of Oracle Key Vault General System Administration

System administrators can perform most general administration tasks in the Oracle Key Vault management console, including finding the current status of the overall system.

- [About Oracle Key Vault General System Administration](#)
System administrators configure the Oracle Key Vault system settings.
- [Viewing the Oracle Key Vault Dashboard](#)
The dashboard presents the current state of the Oracle Key Vault at a high level and is visible to all users.
- [Using the Status Panes in the Dashboard](#)
The status panes on the dashboard provide useful high level information, such as links to alerts.

16.1.1 About Oracle Key Vault General System Administration

System administrators configure the Oracle Key Vault system settings.

The Oracle Key Vault system settings include administration, local and remote monitoring, email notification, backup and recovery operations, and auditing. You must have the appropriate role for performing these tasks. Users who have the System Administrator role can perform most of the administrative tasks, and users with the Audit Manager role can configure audit settings, export audit records, and integrate Oracle Key Vault with Oracle Audit Vault. In most cases, you will perform these tasks in the Oracle Key Vault management console.

To quickly find information about the current state of the Oracle Key Vault system at a high level, you can view the Oracle Key Vault dashboard.

Related Topics

- [Managing Oracle Key Vault Users](#)
Oracle Key Vault users administer the system, enroll endpoints, manage users and endpoints, control access to security objects, and grant other users administrative roles.
- [Managing Oracle Key Vault Endpoints](#)
Oracle Key Vault endpoints are computer systems like database or application servers, where keys and credentials are used to access data.
- [Managing Oracle Key Vault Virtual Wallets and Security Objects](#)

16.1.2 Viewing the Oracle Key Vault Dashboard

The dashboard presents the current state of the Oracle Key Vault at a high level and is visible to all users.

- Click the **Home** tab to display the dashboard. By default, this page appears when you log in to the Oracle Key Vault management console.

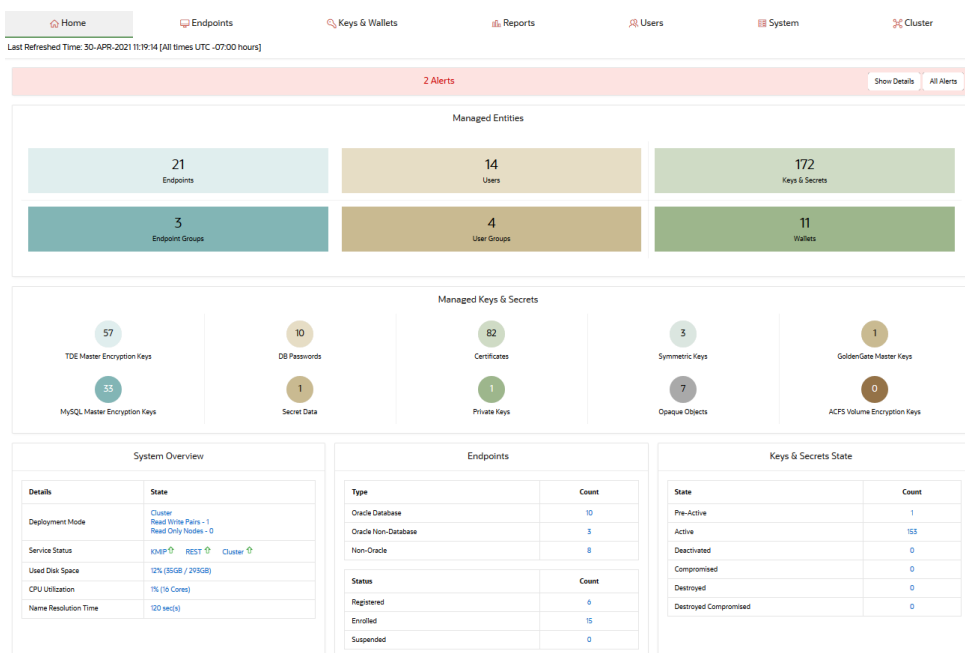

16.1.3 Using the Status Panes in the Dashboard

The status panes on the dashboard provide useful high level information, such as links to alerts.

1. Log in to the Oracle Key Vault management console.
The dashboard appears in the **Home** tab.
2. To take corrective action on a particular alert:
 - a. Click Show Details to find a summary of the alerts.
 - b. Click the link that corresponds to the alert. The appropriate page appears.
 - c. Take the corrective action for the alert as necessary.
3. To configure the alerts that you want to see on the dashboard:
 - a. Click the **Reports** tab, and then click **Alerts** from the left side bar to display the Alerts page.
 - b. Click **Configure** from the top right to display the Configure Alerts page.
 - c. Select the **Alert Type**, check **Enabled**, set the **Limit**, and then click **Save**.
4. To view managed content, click appropriate button in the panes that follow the alerts.

These panes on the dashboard display aggregated information about security objects and other areas of the product that are currently stored and managed in Oracle Key Vault. The contents are as follows:

- Tabs at the top of the page for you to perform various tasks. For example, to create a new endpoint, you click the **Endpoints** tab.
- Alerts enables you to access alerts. Find more information by clicking **Show Details** or **All Alerts**.
- Managed Entities enables you to find the status of these categories: Endpoints; Endpoint Groups; Users; User Groups; Keys, Secrets & Objects; Wallets. Each categories indicates how many of that category's item is configured. For example, if the system has 23 endpoints, then 23 appears above the Endpoints label. To find and modify the details of these endpoints, click the Endpoints label.
- Managed Keys, Secrets & Objects shows the different details of each of the supported security objects: TDE Master Encryption Keys, MySQL Master Encryption Keys, DB Passwords, Secret Data, Symmetric Keys, Opaque Objects, GoldenGate Master Keys, ACFS Volume Encryption Keys. Similar to the Managed Entities contents, to find and modify the details about a security object, click on its label.
- System Overview provides information about the installation: Deployment Mode, Service Status, Used Disk Space, and CPU Utilization.
- Endpoints provides a status and count of the Type (Oracle Database, Oracle Non-Database, Non-Oracle) and Status (Registered, Enrolled, Suspended) of the registered endpoints.
- Keys, Secrets State provides a status and count of these objects: Pre-Active, Active, Deactivated, Compromised, Destroyed, Destroyed Compromised.

Throughout this page, the item type and item state are displayed at the last time refreshed.

Related Topics

- [Searching for Security Object Items](#)
You can search for individual security objects if you have privileges to view these objects.

16.2 Configuring Oracle Key Vault in a Non-Multi-Master Cluster Environment

On the system Settings page, you can configure settings for either a standalone environment or a primary-standby environment.

- [Configuring the Network Details](#)
In a non-multi-master cluster environment, you can configure the network details from any Oracle Key Vault management console.
- [Configuring Network Access](#)
In a non-multi-master cluster, you can configure the network services from any Oracle Key Vault management console.
- [Configuring DNS](#)
In a non-multi-master cluster environment, you can enter up to three DNS server IP addresses.
- [Configuring the System Time](#)
Oracle strongly recommends that you synchronize Oracle Key Vault with an NTP time source.
- [Configuring FIPS Mode](#)
In a non-multi-master cluster environment, you can enable or disable FIPS mode for Oracle Key Vault.
- [Configuring Syslog](#)
In a non-multi-master cluster environment, you can enable syslog for specific destinations and transmit the records either using Transmission Control Protocol (TCP) or User Datagram Protocol (UDP).
- [Changing the Network Interface Mode](#)
You can switch between dual NIC mode and classic mode for the network interface.
- [Configuring RESTful Services](#)
RESTful services allow you to automate the management of endpoints, wallets, security objects, deployment operations, and backup operations.
- [Checking the Oracle Audit Vault Integration Status](#)
Oracle Key Vault can send audit records to Oracle Audit Vault for centralized audit reporting and alerting.
- [Configuring the Oracle Key Vault Management Console Web Session Timeout](#)
In a non-multi-master cluster environment, you can configure a timeout value in minutes for the Oracle Key Vault management console Web session.
- [Restarting or Powering Off Oracle Key Vault](#)
You can manually restart or power off Oracle Key Vault as required for maintenance or for patch and upgrade procedures.

16.2.1 Configuring the Network Details

In a non-multi-master cluster environment, you can configure the network details from any Oracle Key Vault management console.

If you have a high availability configuration, then you must unpair the primary and standby Oracle Key Vault servers before changing the IP address. After you have changed the IP address of the primary or standby Oracle Key Vault server, pair the two servers again. After you complete the pairing process, reenroll the Oracle Key Vault endpoints to ensure that they are updated with the new IP addresses for both the primary and the standby Oracle Key Vault servers.

1. Log into the Oracle Key Vault management console as a user who has the System Administrator role.
2. Select the **System** tab, and then **Settings** from the left navigation bar.
3. In Network Details area, click **Network Info**.

The Network Details area appearance depends on whether you are using Classic mode or Dual NIC mode.

Field	Value
Host Name *	okv00001700af2d
IP Address *	192.0.2.112
Network Mask *	255.255.255.0
Gateway	192.0.2.1
MAC Address	00:00:17:00:AF:2D

4. Update the values for the following fields:
 - **Host Name:** Enter the name of the server.
 - **IP Address:** Enter the IP address of the server.
 - **Network Mask:** Enter the network mask of the server.
 - **Gateway:** Enter the network gateway of the server.

The fields in this pane are automatically populated with the IP address and host name of your Oracle Key Vault server. But if you want, then you can update the **Host Name**, **IP Address**, **Network Mask**, and the **Gateway** for the Oracle Key Vault installation.

You cannot change the **MAC Address** and **Network Mode** settings. If you are using Dual NIC mode, then the same applies: you cannot change the **Bonding Mode**, **Active Interface**, and **Backup Interface** settings, but these values are useful if you want to check their status.

5. Click **Save**.

16.2.2 Configuring Network Access

In a non-multi-master cluster, you can configure the network services from any Oracle Key Vault management console.

You can enable services for **Web Access** and **SSH Access** (Secure Shell Access) for all, none, or a subset of clients, determined by their IP addresses.

1. Log into the Oracle Key Vault management console as a user who has the System Administrator role.
2. Select the **System** tab, and then **Settings** from the left navigation bar.
3. In the Network Details area, select **Web Access**.

Web Access

Web Access allowed from *

IP address(es) All

<IP Address1> <IP Address2> ...

Cancel Save

4. Select one of the following options:
 - **All** to select all IP addresses
 - **IP Address(es)** to select a set of IP addresses that you specify in the next field, separating each IP address by a space. The **IP address(es)** web access option enables you to restrict access to the Oracle Key Vault management console to a limited set of IP addresses that you specify to meet your organizational needs.
5. Click **Save**.
6. To set the SSH access, in the Settings page under Network Details, select **SSH Access**.

Enabling **SSH Access** gives you access to Oracle Key Vault from the command line. This helps you diagnose problems not immediately apparent from the management console. You must log in as the user `support`, with the support password that you created during installation. SSH access is used only under the direction of Oracle Support, or when you upgrade.

As a best practice, enable SSH access for short durations, solely for diagnostic, troubleshooting, or upgrade purposes, and then disable it as soon as you are done.

Enabling or disabling SSH access will enable or disable the **inbound** SSH connection to the Oracle Key Vault server. Enabling or disabling SSH access in this manner has no bearing on the SSH Tunnel settings or any other outbound SSH connections that the Oracle Key Vault server itself establishes. SSH connections can still be established by the Oracle Key Vault to other servers as in the case of SSH Tunnel settings.

7. In the SSH Access window, enter the following settings:
 - **Disabled** to disable all IP addresses SSH access
 - **IP Address(es)** to select a set of IP addresses that you specify in the next field, separating each IP address by a space.
 - **All** to enable SSH access from all IP addresses.
8. Click **Save**.

16.2.3 Configuring DNS

In a non-multi-master cluster environment, you can enter up to three DNS server IP addresses.

You can configure up to three domain name service (DNS) servers with IP addresses that Oracle Key Vault will use to resolve host names. This is useful if you only know the host name and not the IP address of a server that Oracle Key Vault needs to access. For example, while configuring the SMTP server for email notifications, you can optionally enter the host name instead of the IP address, after you set up DNS.

1. Log into the Oracle Key Vault management console as a user who has the System Administrator role.
2. Select the **System** tab, and then **Settings** from the left navigation bar.
3. In the Network Services area, click **DNS**.

4. Enter up to three IP addresses for DNS servers.
You must at minimum configure the DNS setting for Server 1. While only the first value is required, two entries are recommended for fault tolerance.
5. Click **Save**.

16.2.4 Configuring the System Time

Oracle strongly recommends that you synchronize Oracle Key Vault with an NTP time source.

Synchronizing Oracle Key Vault with a time source is important for reliable time stamps in audit records, and the activation, deactivation, protectStop, and processStart dates for keys and secrets.

You can configure Oracle Key Vault to use an NTP server to remain synchronized with the current time. (Fields for up to three servers are provided.) If an NTP server is not available, then you can set the current time manually. You should use the calendar icon to set the date and time so that these values are stored in the correct format.

1. Log into the Oracle Key Vault management console as a user who has the System Administrator role.
2. Ensure that you have configured DNS for NTP servers that will use host names.
3. Select the **System** tab, and then **Settings** from the left navigation bar.
4. In the Network Services area, click **NTP** to display the System Time window.

The following screen shows a partial view of the System Time window. As a best practice, use host names of NTP servers, not IP addresses, and configure all three servers.

System Time

System Time

Set Manually
 Use Network Time Protocol

Synchronize After Save Synchronize Periodically

NTP Server 1

Address

Server Time (in UTC) 24-JUN-2021 21:20:32 (-0.000074 seconds difference)

NTP Server 2

Address

Server Time (in UTC)

NTP Server 3

5. Choose **Use Network Time Protocol**.
6. Enter values for the following fields:

- **Synchronize After Save:** This setting immediately synchronizes the system time to one of the given NTP servers after you save the settings.
 - **Synchronize Periodically:** This setting synchronizes the system time at a predetermined interval.
 - **Server 1:** Enter the IP address of an NTP server. You must supply an IP address for Server 1. To test the NTP server, click **Test Server**. To immediately synchronize the system time with this server, click **Apply Server**.
 - **Server 2:** Enter the IP address of a second NTP server. This value is optional. To test the NTP server, click **Test Server**. To immediately synchronize the system time with this server, click **Apply Server**.
 - **Server 3:** Enter the IP address of a third NTP server. This value is optional. To test the NTP server, click **Test Server**. To immediately synchronize the system time with this server, click **Apply Server**.
7. Click **Save**.

Related Topics

- [Configuring DNS](#)
In a non-multi-master cluster environment, you can enter up to three DNS server IP addresses.

16.2.5 Configuring FIPS Mode

In a non-multi-master cluster environment, you can enable or disable FIPS mode for Oracle Key Vault.

In a primary-standby environment, ensure that both servers are consistent in their FIPS mode setting: either both are enabled, or both are disabled.

1. Log into the Oracle Key Vault management console as a user who has the System Administrator role.
2. Select the **System** tab, and then **Settings** from the left navigation bar.
3. In the System Configuration area, click **FIPS**.

FIPS Mode

Enable ?

Cancel Save

4. Do one of the following:
 - To enable FIPS mode, select the **Enable** check box.
 - To disable FIPS mode, clear the **Enable** check box.

Enabling or disabling FIPS mode will take a few minutes and will also restart the system automatically.

5. Click **Save**.
After you click **Save**, a confirmation dialog box will appear.

- In the confirmation dialog box, click **OK** to apply the changes and restart the Oracle Key Vault system.

If you click **OK**, be aware that the operation cannot be canceled. The restart operation takes place immediately.

16.2.6 Configuring Syslog

In a non-multi-master cluster environment, you can enable syslog for specific destinations and transmit the records either using Transmission Control Protocol (TCP) or User Datagram Protocol (UDP).

All system related alerts are sent to syslog.

- Log into the Oracle Key Vault management console as a user who has the System Administrator role.
- Select the **System** tab, and then **Settings** from the left navigation bar.
- In the Monitoring and Alerts area, click **Syslog**.

The screenshot shows the Syslog configuration page. At the top, there is a 'Syslog' header with a close button (X). Below the header, there is a 'Save' button. The main content area contains two radio buttons: 'TCP' (which is selected) and 'UDP'. Below the radio buttons is a text input field labeled 'Syslog Destinations' with the placeholder text '<IP Address1>:<port1> <IP Address2>:<port2> ...'.

- Select one of the following protocols:
 - TCP**: Enables syslog using the TCP protocol.
 - UDP**: Enables syslog using the UDP protocol.
- Enter the syslog destination IP addresses and port numbers in the **Syslog Destinations** field, in the format *IP_address:port*.
You can enter multiple destinations, separated by a space.
- Click **Save**.

16.2.7 Changing the Network Interface Mode

You can switch between dual NIC mode and classic mode for the network interface.

You can both switch the network mode and update the IP information. If you are using either a primary-standby or a multi-master configuration, then you cannot change the mode and the IP information. You first configured the network interface mode when you installed the Oracle Key Vault appliance software.

- Log in to the Oracle Key Vault server as the `support` user.

2. Switch to the root user.

```
su - root
```

3. At the command line, execute the following script:

```
/usr/local/okv/bin/okv_configure_network
```

4. In the Select Network Mode window, select the network interface that you want to use, and then select **OK**.

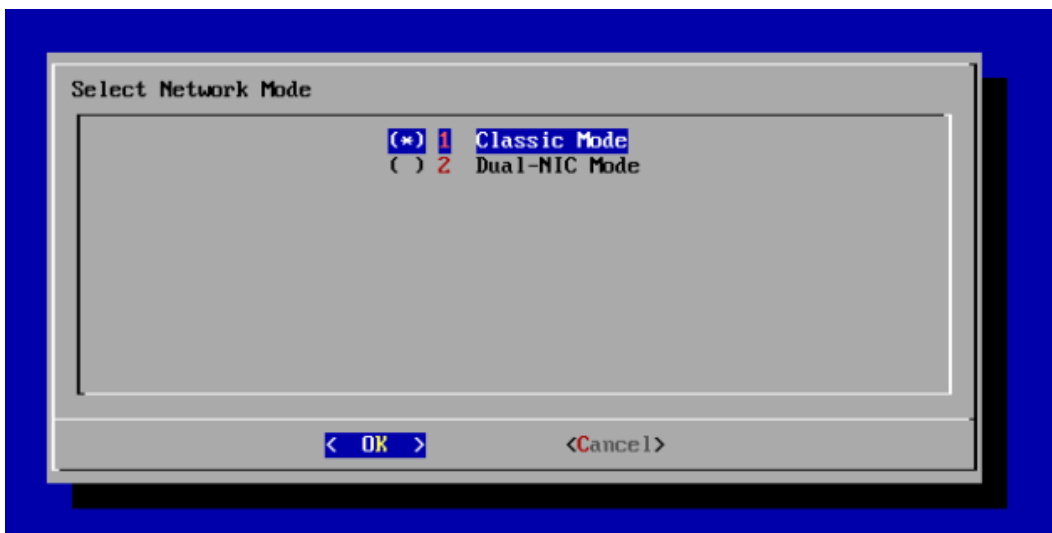

5. For the network mode, if you want Classic mode, then follow these steps:

Classic mode, the only mode available before 21.x releases of Oracle Key Vault, allows one network interface to be used. If you later decide to switch to dual NIC mode, then you can do so, but only if you are using a standalone configuration. You cannot change the mode if you are using a multi-master cluster or primary-standby configuration. Choose this option if the server has only one network card.

- a. Select **1** to choose Classic mode and then select **OK**.
- b. In the Select default network interface screen, select from the available options, and then select **OK**.
- c. In the Network settings screen, enter the **IP address**, **Network mask**, and **Gateway** settings for the default network interface. The network administrator for your site can provide this information.
- d. Select **OK**.

6. If you want the dual NIC network mode, then follow these steps:

Dual NIC mode enables you to configure Oracle Key Vault to use two network interfaces, or ethernet ports. It is useful as a guard against physical or software failures and adds redundancy to the network layer. Select the dual NIC mode if there is a greater need for operational continuity and to avoid eviction from the cluster due to prolonged unavailability of the network. Dual NIC mode helps to prevent situations where a node may lose connectivity and risk missing changes that have been made to data in the cluster.

- a. Select **2** to select Dual-NIC mode and then select **OK**.

- b. In the Select Bond Mode screen, select from the bond mode choices for the two network interfaces that you plan to use, and then select **OK**.
 - **Round Robin** configures the network interfaces such that network packets are transmitted and received sequentially from the first available interface through the last. This bonding mode is the default. This mode provides fault tolerance and load balancing and requires the links to be connected to a network switch with EtherChannel support.
 - **Active-Backup** configures the network interfaces as active and backup. Only one interface in the bond is active. A different interface becomes active if, and only if, the active interface fails. The network communication happens over the active interface. This mode provides fault tolerance and does not require any switch support.
 - **802.3ad** creates aggregation groups that share the same speed and duplex settings. Network packets are transmitted and received on all interfaces. This mode provides fault tolerance and load balancing and requires a switch that supports IEEE 802.3ad dynamic link aggregation.
- c. In the Select two network interfaces screen, select the two network interfaces that you want, and then select **OK**.
- d. In the Network settings screen, enter the **IP address**, **Network mask**, **Gateway**, and **Hostname** settings for the default network interface. The network administrator for your site can provide this information. For the host name, use only lowercase characters. The host name can be the fully qualified host name or the short host name.
- e. Select **OK**.

You do not need to restart Oracle Key Vault after changing the network mode.

Related Topics

-

16.2.8 Configuring RESTful Services

RESTful services allow you to automate the management of endpoints, wallets, security objects, deployment operations, and backup operations.

RESTful services also support regular key management activities.

1. Log into the Oracle Key Vault management console as a user who has the System Administrator role.
2. Select the **System** tab, and then **Settings** from the left navigation bar.
3. In the System Configuration area, click **RESTful Services**.

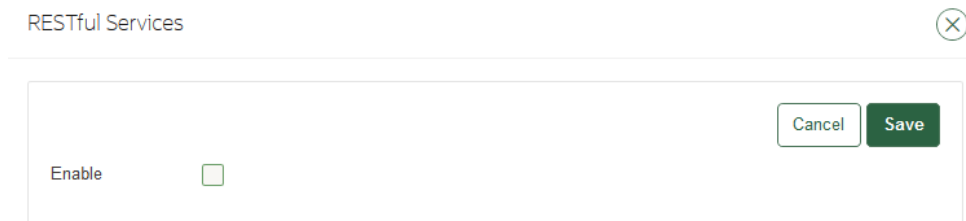

RESTful Services

Enable

Cancel Save

4. Select the **Enable** checkbox in the RESTful Services section.

To disable RESTful services, clear the **Enable** checkbox.

5. Click **Save**.

16.2.9 Checking the Oracle Audit Vault Integration Status

Oracle Key Vault can send audit records to Oracle Audit Vault for centralized audit reporting and alerting.

1. Log into the Oracle Key Vault management console as a user who has the System Administrator role or the Audit Manager role.
2. Depending on the roles that you have, navigate as follows:
 - **If you have the System Administrator role but not the Audit Manager role, or if you have both the System Administrator role and the Audit Manager roles:** Select the **System** tab, and then **Settings** from the left navigation bar. In the Monitoring and Alerts area, click **Audit Vault**.
 - **If you only have the Audit Manager role:** Select the **System** tab, and then in the left navigation bar, select **Audit Vault Integration**.
3. Select the **Monitoring** tab.

The Monitoring pane indicates if the monitoring is active. If Oracle Key Vault is not integrated with Oracle Audit Vault, then only the Deployment pane appears. If you want to have Audit Vault integrated, then log on as a user who has the Audit Manager role to perform the integration.

Related Topics

- [Configuring Oracle Key Vault with Oracle Audit Vault](#)
A user who has the Audit Manager role can configure Oracle Key Vault to send audit records to Oracle Audit Vault for centralized audit reporting and alerting.

16.2.10 Configuring the Oracle Key Vault Management Console Web Session Timeout

In a non-multi-master cluster environment, you can configure a timeout value in minutes for the Oracle Key Vault management console Web session.

1. Log into any Oracle Key Vault management console as a user who has the System Administrator role.
2. Select the **System** tab, and then **Settings** from the left navigation bar.
3. In the System Configuration area, click **Console Timeout**.
4. Enter the value in minutes for the timeout.

The default value is 10. The range you can enter is 1 through 100.

5. Click **Save**.

After you click **Save**, for the currently active user Web session as well as for other active sessions, this setting takes effect when the session is extended, the user refreshes the page, or the user navigates to another page. The user session remains active as long as the user clicks a button, moves the mouse or presses a key, or is performing other activities. If the user session is idle for more than the management console timeout duration, then the user is logged out and the login screen appears.

Just before the Web session ends, starting earlier if the timeout value is larger, the user will be notified and is given the option to extend the session for the same length of time that was set for timeout value. For example, if the timeout was set to 20 minutes, then the user can extend the session for another 20 minutes.

16.2.11 Restarting or Powering Off Oracle Key Vault

You can manually restart or power off Oracle Key Vault as required for maintenance or for patch and upgrade procedures.

1. Log into the Oracle Key Vault management console as a user who has the System Administrator role.
2. Select the **System** tab, and then **Status** from the left navigation bar.
3. Go to the top of the Status page.



4. Do one of the following:
 - To restart, click **Reboot**.
 - To power off, click **Power Off**.

16.3 Configuring Oracle Key Vault in a Multi-Master Cluster Environment

When you configure Oracle Key Vault in a multi-master cluster environment, you can configure either individual nodes or the entire multi-master cluster environment.

- [About Configuring Oracle Key Vault in a Multi-Master Cluster Environment](#)
You have the option of configuring settings for individual nodes or the entire multi-master cluster.
- [Configuring System Settings for Individual Multi-Master Cluster Nodes](#)
You can set or change settings that apply to the cluster node.
- [Managing Oracle Key Vault Multi-Master Clusters](#)
You can create, configure, manage, and administer an Oracle Key Vault multi-master cluster by using the Oracle Key Vault management console.

16.3.1 About Configuring Oracle Key Vault in a Multi-Master Cluster Environment

You have the option of configuring settings for individual nodes or the entire multi-master cluster.

Some of the settings for individual nodes and the entire cluster are the same. For example, you can set the DNS for an individual node or for an entire cluster. Any values that are set and saved to an individual node will not be overridden by cluster settings. When you set a value for the entire cluster, it may take several minutes for changes to propagate to other nodes.

When you start the configuration, you have the choice of setting the following **View Settings** menu options:

- **Node only** means that the setting can be set only on that node and will apply to only node.
- **Cluster only** means that the setting is a cluster-wide setting and updating it will change the settings across the cluster.
- **Both** means that the setting can be set at both node level and cluster level. For these settings, you can navigate between node and cluster settings by using the right arrow button that is present in the respective setting page. For example, if you select **DNS**, then you can configure DNS settings for both individual nodes and for the entire cluster, in one operation.
- **All** shows all the available settings without any filter.

16.3.2 Configuring System Settings for Individual Multi-Master Cluster Nodes

You can set or change settings that apply to the cluster node.

Examples of these settings are the network details, network services, system time, FIPS mode, syslog, and Oracle Audit Vault integration. Values set for the node override the cluster setting. However, you can clear any individual node setting to revert to the cluster setting.

- [Configuring the Network Details for the Node](#)
In a multi-master cluster, you can change the host name for a node.
- [Configuring Network Access for the Node](#)
In a multi-master cluster, you can configure network access for a node.
- [Configuring DNS for the Node](#)
When you configure the DNS for a multi-master cluster node, you should enter more than one DNS IP address.
- [Configuring the System Time for the Node](#)
In a multi-master cluster, you can synchronize Oracle Key Vault with an NTP time source. All nodes of the cluster should operate on the same system time (or coordinated system time) for the inter node replication to work correctly.
- [Configuring the FIPS Mode for the Node](#)
All multi-master cluster nodes must use the same FIPS mode setting or you will receive an alert.
- [Configuring Syslog for the Node](#)
In a multi-master cluster node, you can enable syslog for specific destinations and transmit the records either using Transmission Control Protocol (TCP) or User Datagram Protocol (UDP).
- [Changing the Network Interface Mode for the Node](#)
You can switch between dual NIC mode and classic mode for the network interface for a node in a multi-master cluster environment.
- [Configuring Auditing for the Node](#)
You can enable or disable audit settings for a node.
- [Configuring SNMP Settings for the Node](#)
You can enable or disable SNMP access for a multi-master cluster node.

- [Checking the Oracle Audit Vault Integration for the Node](#)
Oracle Key Vault can send audit records from a node to Oracle Audit Vault for centralized audit reporting and alerting.
- [Restarting or Powering Off Oracle Key Vault from a Node](#)
You can manually restart or power off an Oracle Key Vault node as required for maintenance or for patch and upgrade procedures.

16.3.2.1 Configuring the Network Details for the Node

In a multi-master cluster, you can change the host name for a node.

1. Log into any Oracle Key Vault management console for the node as a user who has the System Administrator role.
2. Select the **System** tab, and then **Settings** from the left navigation bar.
3. In the Network Details area, select **Network Info**.
4. In the **Host Name** field, enter the name of the host name for the node.
You cannot modify the **IP Address**, **Network Mask**, **Gateway**, and **MAC Address** fields, which are automatically populated.
5. Click **Save**.

16.3.2.2 Configuring Network Access for the Node

In a multi-master cluster, you can configure network access for a node.

1. Log into the Oracle Key Vault management console for the node as a user who has the System Administrator role.
2. Select the **System** tab, and then **Settings** from the left navigation bar.
3. In the Network Details area, select **Web Access**.

4. Select one of the following options:
 - **All** to select all IP addresses
 - **IP Address(es)** to select a set of IP addresses that you specify in the next field, separating each IP address by a space. The **IP address(es)** web access option enables you to restrict access to the Oracle Key Vault management console to a limited set of IP addresses that you specify to meet your organizational needs.

5. Click **Save**.
6. To set the SSH access, in the Settings page under Network Details, select **SSH Access**.
 Enabling **SSH Access** gives you access to Oracle Key Vault from the command line. This helps you diagnose problems not immediately apparent from the management console. You must log in as the user `support`, with the support password that you created during installation. SSH access is used only under the direction of Oracle Support, or when you upgrade.
 As a best practice, enable SSH access for short durations, solely for diagnostic, troubleshooting, or upgrade purposes, and then disable it as soon as you are done.
 Enabling or disabling SSH access will enable or disable the **inbound** SSH connection to the Oracle Key Vault server. Enabling or disabling SSH access in this manner has no bearing on the SSH Tunnel settings or any other outbound SSH connections that the Oracle Key Vault server itself establishes. SSH connections can still be established by the Oracle Key Vault to other servers as in the case of SSH Tunnel settings.
7. In the SSH Access window, enter the following settings:
 - **Disabled** to disable all IP addresses SSH access
 - **IP Address(es)** to select a set of IP addresses that you specify in the next field, separating each IP address by a space.
 - **All** to enable SSH access from all IP addresses.
8. Click **Save**.

16.3.2.3 Configuring DNS for the Node

When you configure the DNS for a multi-master cluster node, you should enter more than one DNS IP address.

1. Log into the Oracle Key Vault management console for the node as a user who has the System Administrator role.
2. Select the **System** tab, and then **Settings** from the left navigation bar.
3. In the Network Services area, click **DNS**.
4. In the DNS window, ensure that you are on Node Details - Effective on this Node page.
 If you are on the Cluster Details page, then click the arrow on the right to toggle back to Node Details - Effective on this Node.
5. In the Node Details - Effective on this Node window, enter up to three DNS server IP addresses.
 You must at minimum configure the DNS setting for Server 1. While only the first value is required, two entries are recommended for fault tolerance.
6. Click **Save**.

16.3.2.4 Configuring the System Time for the Node

In a multi-master cluster, you can synchronize Oracle Key Vault with an NTP time source. All nodes of the cluster should operate on the same system time (or coordinated system time) for the inter node replication to work correctly.

1. Log into the Oracle Key Vault management console for the node as a user who has the System Administrator role.

2. Ensure that you have configured DNS for NTP servers that will use host names.
3. Select the **System** tab, and then **Settings** from the left navigation bar.
4. In the Network Services area, click **NTP**.

In cluster mode, you must use the Network Time Protocol (NTP), so you cannot change the selection from **Use Network Time Protocol** to **Set Manually**.

5. In the System Time window, ensure that you are on Node Details - Effective on this Node page.

If you are on the Cluster Details page, then click the arrow on the right to toggle back to Node Details - Effective on this Node.

6. In the Node Details - Effective on this Node page, enter values for the following fields:
 - **Synchronize After Save:** This setting immediately synchronizes the system time for the node to the reference time after you save the settings. Use this setting only when there is a large difference between the NTP reference time and the local system time. Note that the system clock can be forced to jump backwards, instead of being adjusted slowly over time.
 - **Synchronize Periodically:** This setting synchronizes the system time for the node at a predetermined interval.
 - **Server 1:** Enter the host name of the first NTP server (for example, `0.north-america.pool.ntp.org`). To test the NTP server, click **Test Server**. To persist the changes to the NTP configuration, click **Apply Server**.
 - **Server 2:** Enter the host name of the second NTP server (for example, `1.north-america.pool.ntp.org`). To test the NTP server, click **Test Server**. To persist the changes to the NTP configuration, click **Apply Server**.
 - **Server 3:** Enter the host name of the third NTP server. (for example, `2.north-america.pool.ntp.org`). To test the NTP server, click **Test Server**. To persist the changes to the NTP configuration, click **Apply Server**.
7. Click **Save** (or **Save to Cluster**).

16.3.2.5 Configuring the FIPS Mode for the Node

All multi-master cluster nodes must use the same FIPS mode setting or you will receive an alert.

1. Log into the Oracle Key Vault management console for the node as a user who has the System Administrator role.
2. Select the **System** tab, and then **Settings** from the left navigation bar.
3. In the System Configuration area, click **FIPS**.
4. In the FIPS Mode window, do one of the following:
 - To enable FIPS mode, select the **Enable** check box.
 - To disable FIPS mode, clear the **Enable** check box.

Enabling or disabling FIPS mode will take a few minutes and will also restart the system automatically.

5. Click **Save**.

After you click **Save**, Oracle Key Vault will restart automatically.

16.3.2.6 Configuring Syslog for the Node

In a multi-master cluster node, you can enable syslog for specific destinations and transmit the records either using Transmission Control Protocol (TCP) or User Datagram Protocol (UDP).

1. Log into the Oracle Key Vault management console for the node as a user who has the System Administrator role.
2. Select the **System** tab, and then **Settings** from the left navigation bar.
3. In the Monitoring and Alerts area, click **Syslog**.
4. In the Syslog window, ensure that you are on Node Details - Effective on this Node page. If you are on the Cluster Details page, then click the arrow on the right to toggle back to Node Details - Effective on this Node.
5. In the Node Details - Effective on this Node page, select one of the following protocols:
 - **TCP**: Enables syslog using the TCP protocol.
 - **UDP**: Enables syslog using the UDP protocol.
6. Enter the syslog destination IP addresses and port numbers in the **Syslog Destinations** field, in the format *IP_address:port*.
You can enter multiple destinations, separated by a space.
7. Click **Save**.

Related Topics

- [Managing System Auditing](#)
Auditing entails tasks such as capturing audit records in a syslog file or downloading the audit records to a local file.

16.3.2.7 Changing the Network Interface Mode for the Node

You can switch between dual NIC mode and classic mode for the network interface for a node in a multi-master cluster environment.

If you are using a primary-standby configuration, then you cannot change this mode. You first configured the network interface mode when you installed the Oracle Key Vault appliance software. Note that the cluster node must be disabled before you can change its network mode.

1. Log in to the Oracle Key Vault management console as a user who has the System Management role.
2. Disable the cluster node.
3. At the command line, connect as the `support` user.
4. Switch to the root user.

```
su - root
```

5. At the command line, execute the following script:

```
/usr/local/okv/bin/okv_configure_network
```

6. In the Select Network Mode window, select the network interface that you want to use, and then select **OK**.

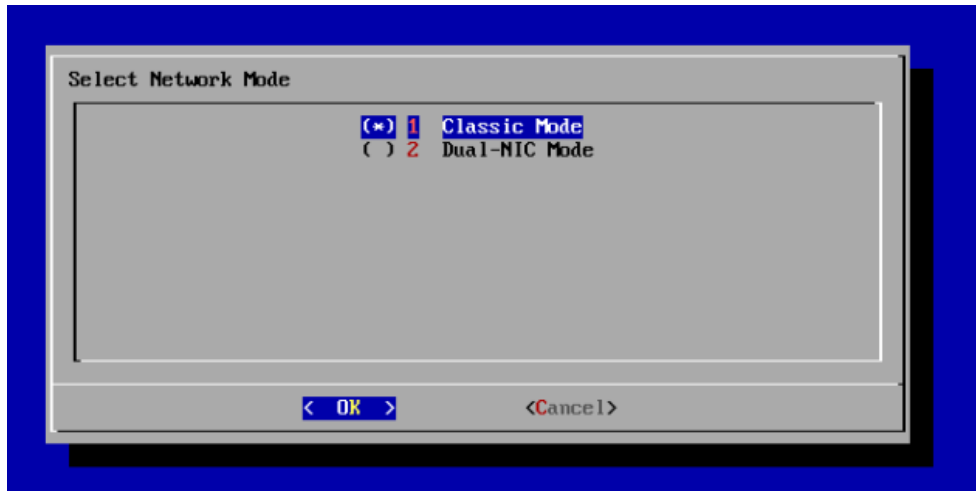

7. For the network mode, if you want Classic mode, then follow these steps:

Classic mode, the only mode available before 21.x releases of Oracle Key Vault, allows one network interface to be used. If you later decide to switch to dual NIC mode, then you can do so, but only if you are using a standalone configuration. You cannot change the mode if you are using a multi-master cluster or primary-standby configuration. Choose this option if the server has only one network card.

 - a. Select **1** to choose Classic mode and then select **OK**.
 - b. In the Select default network interface screen, select from the available options, and then select **OK**.
 - c. In the Network settings screen, enter the **IP address**, **Network mask**, and **Gateway** settings for the default network interface. The network administrator for your site can provide this information.
 - d. Select **OK**.
8. If you want the dual NIC network mode, then follow these steps:

Dual NIC mode enables you to configure Oracle Key Vault to use two network interfaces, or ethernet ports. It is useful as a guard against physical or software failures and adds redundancy to the network layer. Select the dual NIC mode if there is a greater need for operational continuity and to avoid eviction from the cluster due to prolonged unavailability of the network. Dual NIC mode helps to prevent situations where a node may lose connectivity and risk missing changes that have been made to data in the cluster.

 - a. Select **2** to select Dual-NIC mode and then select **OK**.
 - b. In the Select Bond Mode screen, select from the bond mode choices for the two network interfaces that you plan to use, and then select **OK**.
 - **Round Robin** configures the network interfaces such that network packets are transmitted and received sequentially from the first available interface through the last. This bonding mode is the default. This mode provides fault tolerance and load balancing and requires the links to be connected to a network switch with EtherChannel support.
 - **Active-Backup** configures the network interfaces as active and backup. Only one interface in the bond is active. A different interface becomes

active if, and only if, the active interface fails. The network communication happens over the active interface. This mode provides fault tolerance and does not require any switch support.

- **802.3ad** creates aggregation groups that share the same speed and duplex settings. Network packets are transmitted and received on all interfaces. This mode provides fault tolerance and load balancing and requires a switch that supports IEEE 802.3ad dynamic link aggregation.
- c. In the Select two network interfaces screen, select the two network interfaces that you want, and then select **OK**.
 - d. In the Network settings screen, enter the **IP address**, **Network mask**, **Gateway**, and **Hostname** settings for the default network interface. The network administrator for your site can provide this information. For the host name, use only lowercase characters. The host name can be the fully qualified host name or the short host name.
 - e. Select **OK**.
9. Re-enable the disabled cluster node.

You do not need to restart Oracle Key Vault after changing the network mode.

Related Topics

- [Disabling a Cluster Node](#)
You can temporarily disable a cluster node, which is required for upgrades and maintenance.
- [Enabling a Disabled Cluster Node](#)
You can enable any cluster node that was previously disabled. You must perform this operation from the disabled node.
- *Oracle Key Vault Installation and Upgrade Guide*

16.3.2.8 Configuring Auditing for the Node

You can enable or disable audit settings for a node.

1. Log into the Oracle Key Vault management console for the node as a user who has the Audit Manager role.
2. Select the **System** tab, and then **Settings** from the left navigation bar.
3. In the Monitoring and Alerts area, click **Auditing**.

You can enable or disable the following auditing categories:

- **Enable Auditing:** This setting will turn the auditing on or off. Turning off this setting will not generate audit records.
 - **Replicate Audit Records:** This setting applies only to a cluster configuration. It indicates if the audit records are replicated across the cluster nodes.
 - **Send Audit Records to Syslog:** This setting writes the audit records to syslog. To enable this setting, you must first configure the syslog destination.
4. In the Audit Settings window for each of these categories, ensure that you are on Node Details - Effective on this Node page.

If you are on the Cluster Details page, then click the arrow on the right to toggle back to Node Details - Effective on this Node.

5. In the Node Details - Effective on this Node page, select **Yes** or **No** for each category.
6. Click **Save**.

Related Topics

- [Managing System Auditing](#)
Auditing entails tasks such as capturing audit records in a syslog file or downloading the audit records to a local file.

16.3.2.9 Configuring SNMP Settings for the Node

You can enable or disable SNMP access for a multi-master cluster node.

1. Log into any Oracle Key Vault management console as a user who has the System Administrator role.
2. Select the **System** tab, and then **Settings** from the left navigation bar.
3. In the Monitoring and Alerts area, click **SNMP**.
4. In the SNMP window, ensure that you are on Node Details - Effective on this Node page.

If you are on the Cluster Details page, then click the arrow on the right to toggle back to Node Details - Effective on this Node.

5. In the Node Details - Effective on this Node page, select who has SNMP access to the multi-master cluster by choosing one of the options:
 - **All**: Allows SNMP access from all IP addresses.
 - **Disabled**: Allows no SNMP access.
 - **IP address(es)**: Allows SNMP access from the list of IP addresses supplied in the address box. Enter a space-separated list of IP addresses.
6. Enter values for the following fields:
 - **Username**: Enter the SNMP user name.
 - **Password**: Enter the SNMP password.
 - **Reenter Password**: Enter the SNMP password again.
7. Click **Save**.

Alternatively, you can select **Delete** to remove the SNMP setting.

16.3.2.10 Checking the Oracle Audit Vault Integration for the Node

Oracle Key Vault can send audit records from a node to Oracle Audit Vault for centralized audit reporting and alerting.

1. Log into the Oracle Key Vault management console for the node as a user who has the System Administrator role or the Audit Manager.
2. Depending on the roles that you have, navigate as follows:
 - **If you have the System Administrator role but not the Audit Manager role, or if you have both the System Administrator role and the Audit Manager roles**: Select the **System** tab, and then **Settings** from the left navigation bar. In the Monitoring and Alerts area, click **Audit Vault**.

- **If you only have the Audit Manager role:** Select the **System** tab, and then in the left navigation bar, select **Audit Vault Integration**.
3. Select the **Monitoring** tab.

The Monitoring pane indicates if the monitoring is active. If Oracle Key Vault is not integrated with Oracle Audit Vault, then only the Deployment pane appears. If you want to have Audit Vault integrated, then log on as a user who has the Audit Manager role to perform the integration.

Related Topics

- [Configuring Oracle Key Vault with Oracle Audit Vault](#)

A user who has the Audit Manager role can configure Oracle Key Vault to send audit records to Oracle Audit Vault for centralized audit reporting and alerting.

16.3.2.11 Restarting or Powering Off Oracle Key Vault from a Node

You can manually restart or power off an Oracle Key Vault node as required for maintenance or for patch and upgrade procedures.

When you restart or power-off Oracle Key Vault nodes, only the current node is restarted or powered-off. The other nodes in the cluster are unable to send information to and from the nodes that are powered off. When the nodes are restarted, there will be a period needed for the restarted nodes to catch up on activities that took place while they were down.

1. Log into the Oracle Key Vault management console for the node as a user who has the System Administrator role.
2. Select the **System** tab, and then **Status** from the left navigation bar.
3. At the top of the Status page, do one of the following to restart or power off the node:
 - To restart, click **Reboot**.
 - To power off, click **Power Off**.

16.3.3 Managing Oracle Key Vault Multi-Master Clusters

You can create, configure, manage, and administer an Oracle Key Vault multi-master cluster by using the Oracle Key Vault management console.

- [Configuring the System Time for the Cluster](#)

In a multi-master cluster, you can synchronize Oracle Key Vault with an NTP time source.
- [Configuring DNS for the Cluster](#)

When you configure the DNS for a cluster, you can enter up to three DNS server IP addresses.
- [Configuring the Maximum Disable Node Duration for the Cluster](#)

You can set the maximum disable node duration time for the cluster in hours.
- [Configuring Syslog for the Cluster](#)

In a multi-master cluster environment, you can enable syslog for specific destinations and transmit the records either using Transmission Control Protocol (TCP) or User Datagram Protocol (UDP).
- [Configuring RESTful Services for the Cluster](#)

You can enable or disable RESTful Services for the cluster.

- [Configuring Auditing for the Cluster](#)
You can enable or disable audit settings for the cluster.
- [Configuring SNMP Settings for the Cluster](#)
You can enable or disable SNMP access for a multi-master cluster.
- [Configuring the Oracle Key Vault Management Console Web Session Timeout for the Cluster](#)
You can configure a timeout value in minutes for the Oracle Key Vault management console for all nodes in a multi-master cluster.

16.3.3.1 Configuring the System Time for the Cluster

In a multi-master cluster, you can synchronize Oracle Key Vault with an NTP time source.

All nodes of the cluster should operate on the same system time (or coordinated system time) for the inter-node replication to work correctly.

1. Log into any Oracle Key Vault management console as a user who has the System Administrator role.
2. Ensure that you have configured DNS for NTP servers that will use host names.
3. Select the **System** tab, and then **Settings** from the left navigation bar.
4. In the Network Services area, click **NTP**.
5. In the System Time page, click the arrow to the left to toggle to the Cluster Details page.
6. In the Cluster Details page, enter values for the following fields:
 - **Synchronize After Save:** This synchronizes the time across the cluster after you save the settings. Use this setting only when there is a large difference between the NTP reference time and the local system time. Note that the system clock can be forced to jump backwards, instead of being adjusted slowly over time.
 - **Synchronize Periodically:** This synchronizes the time across the cluster at a predetermined interval. Once selected and applied, this option cannot be deselected.
 - **Server 1:** Enter the host name of the first NTP server (for example, 0.north-america.pool.ntp.org). To test the NTP server, click **Test Server**. To immediately synchronize the system time with this server, click **Apply Server**.
 - **Server 2:** Enter the host name of the second NTP server (for example, 1.north-america.pool.ntp.org). To test the NTP server, click **Test Server**. To persist the changes to the NTP configuration, click **Apply Server**.
 - **Server 3:** Enter the host name of the third NTP server. (for example, 2.north-america.pool.ntp.org). To test the NTP server, click **Test Server**. To persist the changes to the NTP configuration, click **Apply Server**.
7. Click **Save**.

16.3.3.2 Configuring DNS for the Cluster

When you configure the DNS for a cluster, you can enter up to three DNS server IP addresses.

1. Log into any Oracle Key Vault management console as a user who has the System Administrator role.
2. Select the **System** tab, and then **Settings** from the left navigation bar.
3. In the Network Services area, click **DNS**.
4. In the DNS window, click the arrow to the left to toggle to the Cluster Details page.
5. In the Cluster Details page, enter up to three DNS Server IP addresses.

You must at minimum configure the DNS setting for Server 1. While only the first value is required, two entries are recommended for fault tolerance.

6. Click **Save**.

16.3.3.3 Configuring the Maximum Disable Node Duration for the Cluster

You can set the maximum disable node duration time for the cluster in hours.

1. Log into any Oracle Key Vault management console as a user who has the System Administrator role.
2. Select the **System** tab, and then **Settings** from the left navigation bar.
3. In the System Configuration area, click **Maximum Disable Node Duration**.
4. In the Maximum Disable Node Duration window, enter a value, in hours, for the duration that a node can be disabled before it is evicted from the cluster.

Note that as this value is increased, the average amount of disk space consumed by cluster-related data also increases.

5. Click **Save**.

16.3.3.4 Configuring Syslog for the Cluster

In a multi-master cluster environment, you can enable syslog for specific destinations and transmit the records either using Transmission Control Protocol (TCP) or User Datagram Protocol (UDP).

1. Log into any Oracle Key Vault management console as a user who has the System Administrator role.
2. Select the **System** tab, and then **Settings** from the left navigation bar.
3. In the Monitor and Alerts area, click **Syslog**.
4. In the Syslog page, click the arrow to the left to toggle to the Cluster Details page.
5. In the Cluster Details page, select one of the following protocols:
 - **TCP**: Enables syslog using the TCP protocol.
 - **UDP**: Enables syslog using the UDP protocol.
6. Enter the syslog destination IP addresses and port numbers in the **Syslog Destinations** field, in the format *IP_address:port*.

You can enter multiple destinations, separated by a space.

7. Click **Save**.

Related Topics

- [Managing System Auditing](#)
Auditing entails tasks such as capturing audit records in a syslog file or downloading the audit records to a local file.

16.3.3.5 Configuring RESTful Services for the Cluster

You can enable or disable RESTful Services for the cluster.

1. Log into any Oracle Key Vault management console as a user who has the System Administrator role.
2. Select the **System** tab, and then **Settings** from the left navigation bar.
3. In the System Configuration area, click **RESTful Services**.
4. In the RESTful Services window, select the **Enable** check box.
5. Click **Save**.

16.3.3.6 Configuring Auditing for the Cluster

You can enable or disable audit settings for the cluster.

1. Log into any Oracle Key Vault management console as a user who has the Audit Manager role.
2. Select the **System** tab, and then **Settings** from the left navigation bar.
3. In the Monitoring and Alerts area, click **Auditing**.

You can enable or disable the following auditing categories:

- **Enable Auditing:** This setting will turn the auditing on or off. Turning off this setting will not generate audit records.
 - **Replicate Audit Records:** This setting applies only to a cluster configuration. It indicates if the audit records are replicated across the cluster nodes.
 - **Send Audit Records to Syslog:** This setting writes the audit records to syslog. To enable this setting, you must first configure the syslog destination.
4. In the Audit Settings page, for each of these categories, click the arrow to the left to toggle to the Cluster Details page.
 5. In the Cluster Details page, select **Yes** or **No** for each category.
 6. Click **Save**.

Related Topics

- [Managing System Auditing](#)
Auditing entails tasks such as capturing audit records in a syslog file or downloading the audit records to a local file.

16.3.3.7 Configuring SNMP Settings for the Cluster

You can enable or disable SNMP access for a multi-master cluster.

1. Log into any Oracle Key Vault management console as a user who has the System Administrator role.
2. Select the **System** tab, and then **Settings** from the left navigation bar.

3. In the Monitoring and Alerts area, click **SNMP**.
 4. Select who has SNMP access to the multi-master cluster by choosing one of the options:
 - **All**: Allows SNMP access from all IP addresses.
 - **Disabled**: Allows no SNMP access.
 - **IP address(es)**: Allows SNMP access from the list of IP addresses supplied in the address box. Enter a space-separated list of IP addresses.
 5. Enter values for the following fields:
 - **Username**: Enter the SNMP user name.
 - **Password**: Enter the SNMP password.
 - **Reenter Password**: Enter the SNMP password again.
 6. Click **Save**.
- Alternatively, you can select **Delete** to remove the SNMP setting.

16.3.3.8 Configuring the Oracle Key Vault Management Console Web Session Timeout for the Cluster

You can configure a timeout value in minutes for the Oracle Key Vault management console for all nodes in a multi-master cluster.

1. Log into any Oracle Key Vault management console as a user who has the System Administrator role.
2. Select the **System** tab, and then **Settings** from the left navigation bar.
3. In the System Configuration area, click **Console Timeout**.
4. In the Management Console Timeout window, enter the value in minutes for the timeout. The default value is 10. The range you can enter is 1 through 100.
5. Click **Save**.

After you click **Save**, the setting is applied to all nodes in the cluster. For the currently active user Web session as well as for other active sessions, this setting takes effect when the session is extended, the user refreshes the page, or the user navigates to another page. The user session remains active as long as the user clicks a button, moves the mouse or presses a key, or is performing other activities. If the user session is idle for more than the management console timeout duration, then the user is logged out and the login screen appears.

Just before the Web session ends, the user will be notified, starting earlier if the timeout value is larger, and is given the option to extend the session for the same length of time that was set for timeout value. For example, if the timeout was set to 20 minutes, then the user can extend the session for another 20 minutes.

16.4 Managing System Recovery

System recovery includes tasks such as recovering lost administrative passwords.

- [About Managing System Recovery](#)
To perform system recovery, you use the recovery passphrase.

- [Recovering Credentials for Administrators](#)
You can recover the system by adding credentials for administrative users.
- [Changing the Recovery Passphrase in a Non-Multi-Master Cluster Environment](#)
Periodically changing the recovery passphrase is a good security practice.
- [Changing the Recovery Passphrase in a Multi-Master Cluster](#)
Changing the recovery passphrase in a multi-master cluster is a two-step process.

16.4.1 About Managing System Recovery

To perform system recovery, you use the recovery passphrase.

In an emergency when no administrative users are available, or you must change the password of administrative users, you can recover the system with the current recovery passphrase of Oracle Key Vault. In addition, you can change the recovery passphrase to keep up with security best practices.

16.4.2 Recovering Credentials for Administrators

You can recover the system by adding credentials for administrative users.

1. From a web browser using HTTPS, enter the IP address of the Oracle Key Vault server.
2. In the Oracle Key Vault login page, **do not log in**.
3. Click the **System Recovery** link at the lower right corner of the login page.
A new login page appears with a single field: **Recovery Passphrase**.
4. In the **Recovery Passphrase** field, enter the recovery passphrase and then click **Login**.
5. In the page that appears, select the **Administrator Recovery** tab.
6. Fill out the fields in the Key Administrator, System Administrator, and Audit Manager panes to assign these roles to new user accounts.
7. Click **Save**.

16.4.3 Changing the Recovery Passphrase in a Non-Multi-Master Cluster Environment

Periodically changing the recovery passphrase is a good security practice.

A user with the System Administrator role should perform a new backup whenever the recovery passphrase changes, so that there is always a backup protected with the current recovery passphrase. This ensures that you will have at least one backup with the latest data.

1. Perform a server backup.
2. From a web browser, enter the IP address of your Oracle Key Vault server.
3. In the Oracle Key Vault login page, **do not log in**.
4. Click the **System Recovery** link at the lower right corner of the login page.
A new login page appears with a single field: **Recovery Passphrase**.

5. In the **Recovery Passphrase** field, enter the recovery passphrase and then click **Login**.
6. In the page that appears, select the **Administrator Recovery** tab.
7. Select the **Recovery Passphrase** tab.
8. In the Recovery Passphrase page, enter and re-enter a new password for the recovery passphrase.
9. Click **Submit**.
10. Perform a server backup.

16.4.4 Changing the Recovery Passphrase in a Multi-Master Cluster

Changing the recovery passphrase in a multi-master cluster is a two-step process.

To change the recovery passphrase for a multi-master cluster, you must first initiate the change throughout the nodes in the multi-master cluster environment before changing the recovery passphrase.

- [Step 1: Initiate the Recovery Passphrase Change Across the Nodes](#)
You must initiate the change for the recovery passphrase so that all nodes in the multi-master cluster will be notified of the impending change.
- [Step 2: Change the Recovery Passphrase](#)
After the multi-master cluster nodes have been notified of the impending recovery passphrase change, you can change the recovery passphrase.

16.4.4.1 Step 1: Initiate the Recovery Passphrase Change Across the Nodes

You must initiate the change for the recovery passphrase so that all nodes in the multi-master cluster will be notified of the impending change.

A user with the System Administrator role should perform a new backup whenever the recovery passphrase changes. This is so that there is always a backup protected with the current recovery passphrase. This ensures that you will have at least one backup with the latest data.

1. Perform a server backup.
2. Ensure that all nodes are in the `ACTIVE` state and replication has been verified between all nodes. Ensure that there are no cluster operations going on (such as adding a node).
3. From a web browser, enter the IP address of a multi-master cluster node that is not in read-only restricted mode.
4. In the Oracle Key Vault login page, **do not log in**.
5. Click the **System Recovery** link at the lower right corner of the login page.
A new login page appears with a single field: **Recovery Passphrase**.
6. In the **Recovery Passphrase** field, enter the recovery passphrase and then click **Login**.
7. Click the **Recovery Passphrase** tab.
8. Click the **Initiate Change** button.
9. Log out.
10. Wait 3 to 4 minutes before continuing.

During this time, all nodes will be notified that a passphrase change will be performed. To cancel a passphrase change, click the **Reset** button.

All nodes will determine if more than one passphrase change has been initiated. If more than one passphrase change has been initiated, conflict resolution will be performed.

After you cancel a passphrase change by using the **Reset** button, Oracle recommends that you remedy the issue and again initiate a passphrase change, making sure to then change the passphrase on every node in the cluster.

Related Topics

- [Step 2: Change the Recovery Passphrase](#)
After the multi-master cluster nodes have been notified of the impending recovery passphrase change, you can change the recovery passphrase.

16.4.4.2 Step 2: Change the Recovery Passphrase

After the multi-master cluster nodes have been notified of the impending recovery passphrase change, you can change the recovery passphrase.

1. From a Web browser, enter the IP address of a multi-master cluster node in the Oracle Key Vault installation.

You can find a list of available nodes in the Oracle Key Vault management console by selecting the Clusters tab and then checking the Cluster Details section.
2. In the Oracle Key Vault login page, **do not log in**.
3. Click the **System Recovery** link at the lower right corner of the login page.

A new login page appears with a single field: **Recovery Passphrase**.
4. In the **Recovery Passphrase** field, enter the recovery passphrase and then click **Login**.
5. Click the **Recovery Passphrase** tab.
6. Enter the new recovery passphrase in the two fields.
7. Click **Submit**.
8. Repeat these steps for each node in the cluster.

 **Note:**

HSM reverse migrate cannot run when the recovery passphrase is being changed.

▲ Caution:

It is your responsibility to keep the recovery passphrase the same on all nodes in the cluster. If you set the recovery passphrase differently on cluster nodes it will negatively impact cluster functionality, such as adding nodes and HSM-enabling nodes. In addition to the addition of nodes and nodes being HSM-enabled, certificate rotation in a multi-master cluster depends on all nodes having the same recovery passphrase.

Related Topics

- [Step 1: Initiate the Recovery Passphrase Change Across the Nodes](#)
You must initiate the change for the recovery passphrase so that all nodes in the multi-master cluster will be notified of the impending change.

16.5 Support for a Primary-Standby Environment

To ensure that Oracle Key Vault can always access security objects, you can deploy Oracle Key Vault in a primary-standby (highly available) configuration.

This configuration also supports disaster recovery scenarios.

You can deploy two Oracle Key Vault servers in a primary-standby configuration. The primary server services the requests that come from endpoints. If the primary server fails, then the standby server takes over after a configurable preset delay. This configurable delay ensures that the standby server does not take over prematurely in case of short communication gaps.

The primary-standby configuration was previously known as the high availability configuration. The primary-standby configuration and the multi-master cluster configuration are mutually exclusive.

Oracle Key Vault supports primary-standby read-only restricted mode. When the primary server is affected by server, hardware, or network failures, primary-standby read-only restricted mode ensures that an Oracle Key Vault server is available to service endpoints, thus ensuring operational continuity. However, key and sensitive operations, such as generation of keys are disabled, while operations such as generation of audit logs are unaffected.

When an unplanned shutdown makes the standby server unreachable, the primary server is still available to the endpoints in read-only mode.

Related Topics

- [About the Oracle Key Vault Primary-Standby Configuration](#)
You configure a primary-standby environment by providing the primary and standby servers with each other's IP address and certificate, and then pairing them.

16.6 Commercial National Security Algorithm Suite Support

You can use scripts to perform Commercial National Security Algorithm (CNSA) operations for Oracle Key Vault HSM backup and upgrade operations.

- [About Commercial National Security Algorithm Suite Support](#)
You can configure Oracle Key Vault for compliance with the Commercial National Security Algorithm (CNSA) Suite.

- [Running the Commercial National Security Algorithm Scripts](#)
You configure Oracle Key Vault to use the Commercial National Security Algorithm (CNSA) suite by running CNSA scripts.
- [Performing Backup Restore Operations with CNSA](#)
After you restore a backup of the Oracle Key Vault that was configured to use the enhanced Commercial National Security Algorithm (CNSA) Suite, use `/usr/local/okv/bin/okv_cnsa` to reconfigure CNSA compliance.
- [Upgrading a Standalone Oracle Key Vault Server with CNSA](#)
You can upgrade a standalone Oracle Key Vault while using Commercial National Security Algorithm (CNSA) compliance by upgrading and then executing the `okv_cnsa` script.
- [Upgrading Primary-Standby Oracle Key Vault Servers to Use CNSA](#)
You can upgrade Oracle Key Vault primary-standby servers while using Commercial National Security Algorithm (CNSA) compliance by upgrading and then executing the `okv_cnsa` script.

16.6.1 About Commercial National Security Algorithm Suite Support

You can configure Oracle Key Vault for compliance with the Commercial National Security Algorithm (CNSA) Suite.

This compliance applies to TLS connections to and from the Oracle Key Vault appliance.

The CNSA suite is a list of strong encryption algorithms and key lengths, that offer greater security and relevance into the future.

Oracle Key Vault release 12.2 BP3 or later do not provide complete compliance across every component in the system. You will be able to switch to the CNSA algorithms, where available by means of the following scripts that are packaged with the Oracle Key Vault ISO:

- `/usr/local/okv/bin/okv_cnsa` makes configuration file changes to update as many components as possible to use the enhanced algorithms.
- `/usr/local/okv/bin/okv_cnsa_cert` regenerates CNSA compliant public key pairs and certificates.

 **Note:**

The `/usr/local/okv/bin/okv_cnsa` and `/usr/local/okv/bin/okv_cnsa_cert` scripts are both disruptive because they replace the old key pairs with new ones. This has consequences for the following operations:

- **Endpoint Enrollment:** Enroll endpoints after running this script when possible. If you had endpoints enrolled before running the CNSA script, you must reenroll them so that fresh CNSA compliant keys are generated using CNSA algorithms.
- **Primary-Standby:** Run the CNSA scripts on both Oracle Key Vault instances before pairing them in a primary-standby configuration when possible. If you had primary-standby before you run the CNSA scripts, then you must re-configure primary-standby as follows: unpair the primary and standby servers, reinstall the standby server, run the CNSA scripts individually on each server, and then pair them again.

 **Limitations:**

- CNSA compliance is not supported for all components in the Oracle Key Vault infrastructure (for example, SSH or Transparent Data Encryption (TDE)).
- The Firefox browser is not supported for use with the Oracle Key Vault management console when CNSA is enabled. This is because the Firefox browser does not support CNSA-approved cipher suites.

16.6.2 Running the Commercial National Security Algorithm Scripts

You configure Oracle Key Vault to use the Commercial National Security Algorithm (CNSA) suite by running CNSA scripts.

1. Back up Oracle Key Vault.
2. If necessary, enable SSH access.

Log in to the Oracle Key Vault management console as a user who has the System Administrator role. Select the **System** tab, then **Settings**. In the Network Details area, click **SSH Access**. Select **IP address(es)** and then enter only the IP addresses that you need, or select **All**. Click **Save**.

3. SSH into the Oracle Key Vault server as the `support` user, entering the `support` user password that was created during post-installation, when prompted.

```
$ ssh support@okv_instance
```

4. Change to the `root` user:

```
$ su root
```

5. Run the scripts as follows:

```
root# /usr/local/okv/bin/okv_cnsa
root# /usr/local/okv/bin/okv_cnsa_cert
```

6. Disable SSH access and then restart the Oracle Key Vault server.

Log in to the Oracle Key Vault management console as a user who has the System Administrator role. Select the **System** tab, then **Settings**. In the Network Details area, click **SSH Access**. Select **Disabled**. Click **Save**. Restart the Oracle Key Vault server by selecting the **System** tab, then **Status**.

The scripts update the `/usr/local/okv/etc/okv_security.conf` with the following line:

```
USE_ENHANCED_ALGORITHMS_ONLY="1"
```

Related Topics

- [Backup and Restore Operations](#)
Backups provide the ability to restore Oracle Key Vault to a previous state in the case of a failure.

16.6.3 Performing Backup Restore Operations with CNSA

After you restore a backup of the Oracle Key Vault that was configured to use the enhanced Commercial National Security Algorithm (CNSA) Suite, use `/usr/local/okv/bin/okv_cnsa` to reconfigure CNSA compliance.

1. Perform the backup restore operations.
2. Wait until the restore operation is complete and the system has restarted.
Do not proceed without completing this step.
3. SSH into the Oracle Key Vault server as the `support` user:

```
$ ssh support@okv_instance
```

4. Switch to the `root` user:

```
$ su root
```

5. Run the following CNSA script :

```
root# /usr/local/okv/bin/okv_cnsa
```

Related Topics

- [Backup and Restore Operations](#)
Backups provide the ability to restore Oracle Key Vault to a previous state in the case of a failure.

16.6.4 Upgrading a Standalone Oracle Key Vault Server with CNSA

You can upgrade a standalone Oracle Key Vault while using Commercial National Security Algorithm (CNSA) compliance by upgrading and then executing the `okv_cnsa` script.

1. Ensure that you have backed up the server you are upgrading so your data is safe and recoverable.
Do not proceed without completing this step.
2. Log into the Oracle Key Vault management console as a user who has the System Administrator role.
3. If necessary, enable SSH access.

Log in to the Oracle Key Vault management console as a user who has the System Administrator role. Select the **System** tab, then **Settings**. In the Network Details area, click **SSH Access**. Select **IP address(es)** and then enter only the IP addresses that you need, or select **All**. Click **Save**.

4. Ensure you have enough space in the destination directory for the upgrade ISO files.
5. Log in to the Oracle Key Vault server through SSH as user `support`, then switch user `su` to `root`.
6. Copy the upgrade ISO file to the destination directory using Secure Copy Protocol or other secure transmission method.

```
scp remote_host:remote_path/okv-upgrade-disc-  
new_software_release_number.iso /var/lib/oracle/destination_directory_for_iso_file
```

In this specification:

- `remote_host` is the IP address of the computer containing the ISO upgrade file.
- `remote_path` is the location of the ISO upgrade file.

7. Make the upgrade accessible by using the mount command:

```
root# /bin/mount -o loop,ro /var/lib/oracle/okv-upgrade-disc-  
new_software_release_number.iso /images
```

8. Clear the cache using the `clean all` command:

```
root# yum -c /images/upgrade.repo clean all
```

9. Execute the following upgrade ruby script:

```
root# /usr/bin/ruby/images/upgrade.rb --confirm
```

If the system is successfully upgraded, then the command will display the following message:

```
Remove media and reboot now to fully apply changes
```

If you see an error message, then check the log file `/var/log/messages` for additional information.

10. Run the first CNSA script, which is available from the Oracle Key Vault ISO files location:

```
root# /usr/local/okv/bin/okv_cnsa
```

11. Restart the Oracle Key Vault server:

```
root# /sbin/reboot
```

On the first restart of the computer after the upgrade, the system will apply the necessary changes. This can take a few hours. Do not shut down the system during this time.

The upgrade is completed when the screen with heading: `Oracle Key Vault Server release_number` installation has completed. The `release_number` value should reflect the upgraded release.

12. Confirm that Oracle Key Vault has been upgraded to the correct version.
 - a. Log in to the Oracle Key Vault management console as a user who has the System Administrator role.
 - b. Select the **System** tab, and then select **Status**.
 - c. Verify that the version displayed is that of the new software release.

The release number is also at the bottom of each page, to the right of the copyright information.

13. Disable SSH access.

Log in to the Oracle Key Vault management console as a user who has the System Administrator role. Select the **System** tab, then **Settings**. In the Network Details area, click **SSH Access**. Select **Disabled**. Click **Save**.

Related Topics

- <https://apps.nsa.gov/iaarchive/programs/iad-initiatives/cnsa-suite.cfm>
- <https://cryptome.org/2016/01/CNSA-Suite-and-Quantum-Computing-FAQ.pdf>

16.6.5 Upgrading Primary-Standby Oracle Key Vault Servers to Use CNSA

You can upgrade Oracle Key Vault primary-standby servers while using Commercial National Security Algorithm (CNSA) compliance by upgrading and then executing the `okv_cnsa` script.

You must perform the upgrade standby and primary servers in one session with as little time between the standby and primary upgrade as possible. The upgrade time is approximate and a function of the volume of data stored and managed by Oracle Key Vault. For large volumes of data, the upgrade time may be longer than several hours.

1. Prepare for the upgrade.
 - While the upgrade is in progress, do not change any settings or perform any other operations that are not part of the upgrade instructions below.
 - Upgrade the Oracle Key Vault server during a planned maintenance window because the upgrade process requires the endpoints to be shut down during the upgrade, if no persistent cache has been configured. With persistent cache enabled, endpoints will continue to be operational during the upgrade process.
 - Ensure that both the primary and standby systems have 8 GB memory.
2. Ensure that you have backed up the server you are upgrading so your data is safe and recoverable.

Ensure that in the time between the backup and shutting down the Oracle Key Vault servers for upgrade, that no databases perform a set or rekey operation (for example, using the `ADMINISTER KEY MANAGEMENT` statement), since these new keys will not be included in the backup.

Do not proceed without completing this step.

3. First, upgrade the standby server while the primary server is running.

Follow Steps 2 through Step 11 of the standalone server upgrade process for CNSA.
4. Ensure that the upgraded standby Oracle Key Vault server is restarted and running.
5. Upgrade the primary Oracle Key Vault server following Steps 1 through 11 of the standalone server upgrade.

After both the standby and primary Oracle Key Vault servers are upgraded, the two servers will automatically synchronize.

6. Log in to the Oracle Key Vault management console as a user with the System Administrator role.
7. Select the **System** tab, and then **Status**.
8. Verify that the **Version** field displays the new software version release number.

Related Topics

- [Upgrading a Standalone Oracle Key Vault Server with CNSA](#)
You can upgrade a standalone Oracle Key Vault while using Commercial National Security Algorithm (CNSA) compliance by upgrading and then executing the `okv_cnsa` script.

16.7 Minimizing Downtime

Business-critical operations require data to be accessible and recoverable with minimum downtime.

You can configure Oracle Key Vault to ensure minimum downtime in the following ways:

- **Configuring a multi-master cluster:** You can configure a multi-master cluster by adding redundancy in the form of additional nodes. The client can access any available node. In the event of a failure of any node, a client will automatically connect to another node in the endpoint node scan list. This reduces and potentially eliminates downtime.
- **Configuring a primary-standby environment:** A primary-standby environment is configured by adding redundancy in the form of a standby server. The standby server takes over from the primary server in the event of a failure, thus eliminating single points of failure, and minimizing downtime.
- **Enabling read-only restricted mode:** Primary-standby read-only restricted mode ensures endpoint operational continuity when primary or standby Oracle Key Vault servers are affected by server, hardware, or network failures. When an unplanned shutdown causes the standby server to become unreachable, the primary server is still available to the endpoints.

If primary-standby read-only restricted mode is disabled, then the primary server will become unavailable and stop accepting requests in the event of a standby failure. Endpoints connected to Oracle Key Vault are unable to retrieve keys until connectivity is restored between primary and standby servers.

To ensure endpoint operational continuity in the event of a primary or standby server failure, enable read-only restricted mode.

- **Enabling persistent master encryption key cache:** The persistent master encryption key cache ensures that the endpoints can access keys in the event of a primary or standby server failure. While the surviving server is taking over from the failed peer, the endpoints can retrieve keys from the persistent cache and continue operations normally.
- **Apply the TDE heartbeat database patch on endpoints:** Apply the database patch for Bug 22734547 to tune the Oracle Key Vault heartbeat.

Oracle strongly recommends that you back up Oracle Key Vault data regularly on a schedule. This practice ensures that backups are current and hold the most recent data. You can use this backup to restore a new or existing Oracle Key Vault server and enable it to be fully operational with minimum downtime and data loss.

If the Oracle Key Vault installation uses an online master key (formerly known as TDE direct connect), then during an upgrade, ensure that you upgrade database endpoints in parallel to reduce total downtime.

Related Topics

- [Using the Persistent Master Encryption Key Cache](#)
The persistent master encryption key cache feature enables databases to be operational when the Oracle Key Vault server is unavailable.

17

Managing Certificates

In addition to Oracle Key Vault-generated certificates, you can manage third-party certificates.

- [Rotating Certificates](#)
You can rotate both Oracle Key Vault-generated certificates or third-party certificates.
- [Managing Console Certificates](#)
You can use the Oracle Key Vault management console to manage console certificates.

17.1 Rotating Certificates

You can rotate both Oracle Key Vault-generated certificates or third-party certificates.

- [About Rotating Certificates](#)
The certificate rotation process captures all certificates in the Oracle Key Vault server. This operation does not rotate the console certificates.
- [Advice for Managing Certificate Rotations](#)
Oracle Key Vault provides advice on the best ways to rotate certificates.
- [Factors That May Affect the Certificate Rotation Process](#)
Factors that affect the certificate rotation process occur in all Oracle Key Vault environments.
- [Rotating All Certificates](#)
You can use the Oracle Key Vault management console to rotate certificates.
- [Checking the Overall Certificate Rotation Status](#)
You can use the Oracle Key Vault management console to check the overall status of a certificate rotation.
- [Checking the Certificate Rotation Status for Endpoints](#)
You can use the Oracle Key Vault management console to check the status of a certificate rotation for endpoints.
- [Post-Certificate Rotation Tasks](#)
After you have completed the certificate rotation, you should perform post-rotation tasks.

17.1.1 About Rotating Certificates

The certificate rotation process captures all certificates in the Oracle Key Vault server. This operation does not rotate the console certificates.

A certificate in Oracle Key Vault lasts 730 days. If you do not rotate the certificate (both server and endpoint certificates), then the endpoints that use the certificate cannot connect to the Oracle Key Vault server. When this happens, you must reenroll the endpoint. To avoid this scenario, you can configure an alert to remind you to rotate the certificate before the 730-day limit is up. The rotation process handles the rotation for all certificates in one operation. You can find how much time the Oracle Key Vault server certificate has before it expires by checking the **OKV Server Certificate Expiration** setting on the Configure Alerts page in the Oracle Key Vault management console. To find the expiry time of the endpoints' certificates, you must navigate to the Endpoints page and check the **Certificate Expires** field.

 **Note:**

If you do not rotate certificates before their expiration date, then all endpoints will experience downtime. In addition, upgrades and communication between the Oracle Key Vault multi-master cluster nodes will also fail. Ensure that you rotate certificates well in advance of their expiration date. You can find the expiration date of your site's certificates by selecting the **System** tab, then **Status**, and then checking the **Server Certificate Expiration Date** field.

In addition to standalone environments, you can rotate certificates in primary-standby and multi-master cluster environments. In both, Oracle Key Vault automatically synchronizes the certificates in both systems in a primary-standby configuration, and in all nodes in a multi-master cluster configuration. You do not have to perform any extra configuration.

Related Topics

- [Configuring Alerts](#)
You can configure alerts in the Reports page of the Oracle Key Vault management console.

17.1.2 Advice for Managing Certificate Rotations

Oracle Key Vault provides advice on the best ways to rotate certificates.

- The default alert time for a certificate expiration is 90 days, but Oracle recommends that you set it to 60 days or earlier. A certificate rotation can take time, so setting the value to a higher number enables an administrator to receive the alert early enough to plan for downtime and to take action.
- Do not initiate a certificate rotation while a node addition is in progress.
- Do not try node operations (such as adding or disabling nodes) while a certificate rotation is in process.
- You cannot initiate certificate rotation unless all nodes in the cluster are active. You can check if a node is active by checking the Cluster Monitoring page. (Click the **Cluster** tab, and then select **Monitoring** from the left navigation bar.)
- In a primary-standby configuration, do not perform certificate rotation if the primary server is in read-only restricted mode. Only initiate a certificate rotation when both servers in the configuration are active and synchronized with each other.
- If you are performing certificate rotation on a system that was upgraded from a previous release, ensure that you upgrade the endpoints as well. Endpoints whose software has not been upgraded will not receive updated credentials.
- You cannot perform a certificate rotation while a backup operation or a restore operation is in progress.
- Before performing a certificate rotation, back up the Oracle Key Vault system.
- In order for the certificate rotation process to fully complete, you must delete and reenroll all endpoints that are *not* in the Enrolled state. If you no longer need the endpoint, then you only need to delete it.

- In a multi-master cluster environment, do not perform any major operations in a single-node cluster where the single remaining node is in read-only restricted mode.
- After the certificate rotation is completed, you must download the RESTful services utility again so that you can have access to the updated software with the latest server certificate.
Important: Do not use this feature if the certificates have already expired. Contact Oracle Support if you have tried using the RESTful services utility when certificates have expired.
- Do not attempt to upgrade the systems if certificates have already expired. Doing so would cause the upgrades to fail.
- Contact Oracle Support if certificates have expired and you have tried endpoint operations, using the RESTful services utility, taking backups, node operations, and so on.

17.1.3 Factors That May Affect the Certificate Rotation Process

Factors that affect the certificate rotation process occur in all Oracle Key Vault environments.

- Each cluster node only generates certificates for a small set of endpoints. These endpoints are those whose creator node (the node on which the certificates are generated) it is. (You can find an endpoint's creator node in the Oracle Key Vault management console by going to the Endpoints page, and then looking for the creator node for each endpoint.) If all endpoints were created before an upgrade from Oracle Key Vault release 12.2, then it is possible that they may all be associated with one single cluster node. This can make the rotation process slower than if the endpoints had been created on different cluster nodes.
- During the rotation process, Oracle Key Vault rotates endpoints in batches on each node of the cluster, with a maximum number of endpoints that are allowed to be in the rotated state at any one time. At least one of those rotated endpoints must receive its new certificates and acknowledge receipt (involving at least two communications with the server) before the server moves on to processing another endpoint. If all endpoints are considered to have been created on a single Oracle Key Vault cluster node, then the rotation process may degenerate to rotating a few endpoints at a time across the cluster.
- In order to receive the new certificates, the endpoint must reach out to the node on which its certificates have been generated (that is, the creator node).
- In a multi-master cluster configuration, whenever the endpoint attempts to make a connection to Oracle Key Vault, it performs the following actions:
 - First, it obtains the list of server IPs from its configuration file (`okvclient.ora`).
 - Next, it picks one at random from those in the cluster subgroup to which the endpoint belongs.
The endpoint reaches out to a random Oracle Key Vault cluster node, and not necessarily to its creator node. This means that even if the Oracle Key Vault management console shows that the endpoint has had its certificates rotated, the endpoint may not receive the new certificates for some considerable period of time, despite making repeated attempts to reach out to the Oracle Key Vault cluster. An endpoint can only successfully receive an update if it has at least one object uploaded to the Oracle Key Vault server. You can check if the endpoint has objects by executing the `okvutil list` command.
- If a given endpoint does not receive its rotated certificates due to network or other issues, or is in the `SUSPENDED` state, Oracle recommends that you reenroll the endpoint, or even

delete it. This will allow the certificate rotation process to continue on to completion. You can find the current certificate rotation status by going to the Endpoints page and looking for Common Name of Certificate Issuer.

Related Topics

- [Deleting, Suspending, or Reenrolling Endpoints](#)
When endpoints no longer use Oracle Key Vault to store security objects, you can delete them, and then reenroll when they are needed.

17.1.4 Rotating All Certificates

You can use the Oracle Key Vault management console to rotate certificates.

The rotation process is initiated when you generate the server certificate. When you activate the process of rotating the certificates, in a multi-master cluster environment, the certificates in all endpoints are rotated as well. After the endpoints have received their new certificates, Oracle Key Vault rotates its own server certificates. Perform the steps in this topic to complete the rotation process throughout the Oracle Key Vault environment.

Before beginning certificate rotation, ensure that the recovery passphrase is the same across all multi-master cluster nodes.

1. Back up Oracle Key Vault.
2. Log in to Oracle Key Vault management console as a user who has the System Administrator role.

In a primary-standby environment, log in to the primary Oracle Key Vault server. In a multi-master cluster environment, you can log in to any node in the cluster. Oracle recommends that you initiate the rotation from one node at a time. **Do not perform multiple rotations on different nodes at once.**

3. Select the **System** tab, then **Settings** from the left navigation side bar.
4. In the Certificates area, click **Server Certificate**.
By default, **Server Certificate** is selected.
5. In the Manage Server Certificate window, select **Generate Server Certificate**.
6. In the confirmation dialog box, select **OK**.

This creates a new CA certificate, but does not enable it. At this stage, endpoints can still use their old credentials to connect using the previous certificate. The Old Certificate area shows the details of the currently active CA. The New Certificate area shows that the certificate has been rotated and displays its common name. If you want to cancel the rotation process, click **Abort** to cancel the process and clean up the new CA directory that was generated.

In a multi-master cluster environment:

- After the certification rotation process is initiated, the details of the new certificate that was generated are shown on the node on which you initiated the rotation. After a few minutes, if you refresh the Manage Server Certificate page on all of the other nodes, this page should show that a message saying that the new certificate is being propagated to that node.
- The certificate will be propagated to all nodes, but not activated. ("Activated" means that the new certificate will not be put into use until the next step of this

process.) Depending on the number of nodes in the cluster, it may take some time to complete the propagation process.

- You can cancel the certificate rotation only up to the point that 1) all nodes in the cluster have received the certificates, and 2) each node has notified the other nodes that it has received the certificate. At this point, the **Abort** button will disappear and only **Activate Certificate** remains. The certificate activation process can only take place when all nodes in the cluster no longer have the **Abort** button appearing.
 - Periodically refresh the Manage Server Certificate page, in case there have been changes to the status. For example, you should refresh this page if you want to determine that the **Abort** button is no longer showing and the **Activate Certificate** button has appeared. To access this page, select the **System** tab, select **Settings** in the left navigation bar, and then select **Manage Server Certificate** in the Certificates area.
7. In the Manage Server Certificate window, when the **Activate Certificate** button appears and is enabled, click it.

Clicking **Activate Certificate** begins the process of putting the new Oracle Key Vault CA into use. When it completes, the endpoints should be able to connect to the Oracle Key Vault server using either the new or the old Oracle Key Vault CA. This process may take a few minutes to complete. You cannot cancel the rotation process after you click **Activate Certificate**.

In a multi-master cluster environment, **Activate Certificate** applies the certificate to all nodes in the cluster. The certificate activation process can only take place when all nodes in the cluster no longer have the **Abort** button appearing. It takes a few minutes for the remaining nodes to be updated. Ensure that you click **Activate Certificate** on only one node before you refresh the Manage Server Certificates page on the other nodes. Wait a few minutes for the screen to refresh. (You only need to click **Activate Certificate** on one node, not multiple nodes.) Note that the Manage Server Certificates page on all nodes other than the one that you clicked **Activate Certificate** on may show no change in status for a few minutes, until the process starts to take effect on those nodes.

8. In the confirmation dialog box, click **OK**.

A message appears saying that the automatic certificate update of the endpoints is in progress. In the background, Oracle Key Vault starts regenerating certificates for its endpoints, for a few endpoints at a time (so that not all endpoints are updated at once). To check if the credentials for an endpoint have been updated, click the **Check Endpoint Progress** button. The Endpoints page appears. If, for a given endpoint, the **Common Name of Certificate Issuer** field shows the common name of the old CA, the new credentials have not yet been generated. However, if, for existing endpoints, the field shows **Updating to Current Certificate Issuer**, the process has begun. Endpoints should be able to retrieve updated credentials a few minutes after this status has changed.

After the new credentials have been generated for a given endpoint, when the endpoint next makes a connection to the Oracle Key Vault server, the new credentials for the certificate are sent over to the endpoint. After an endpoint has received its updated credentials from the Oracle Key Vault server, it must try to connect to the Oracle Key Vault server to let the server know that it has successfully received the credentials. You should periodically check the status of replication across the cluster by viewing either the Cluster Monitoring page or the Cluster Management page. (To access either of these pages, click the **Cluster** tab, and then select either **Management** or **Monitoring** in the left navigation bar.) When the endpoint successfully receives the credentials, the value in the **Common Name of Certificate Issuer** field for that endpoint on the Endpoints page should reflect the common name of the new Oracle Key Vault CA certificate.

After all the endpoints have been updated to using the new CA, the Oracle Key Vault server begins the process of fully rotating its own server certificates in the background. The process can be deemed to be complete when the Manage Server Certificate page no longer shows two certificates listed, but only a single one reflecting the new CA certificate. The **OKV Server Expiration Date** field in the System Status page should reflect the expiration time of the new CA certificate as well. In a multi-master cluster environment, you can initiate another certificate rotation only after all the nodes have completed their certification rotation process. In a multi-master cluster environment, after the process of activation has begun, the Manage Server Certificate page on each node only shows the status of rotation on that individual node. For example, it switches from showing two certifications listed to one when the process of rotation on that node has completed. To check if rotation is complete across the cluster, you must go to each individual node and check the Manage Server Certificate page on that node. After you complete the rotation, you should configure an alert for the next time the new certificate should be rotated.

Related Topics

- [Backup and Restore Operations](#)
Backups provide the ability to restore Oracle Key Vault to a previous state in the case of a failure.
- [Configuring Alerts](#)
You can configure alerts in the Reports page of the Oracle Key Vault management console.

17.1.5 Checking the Overall Certificate Rotation Status

You can use the Oracle Key Vault management console to check the overall status of a certificate rotation.

After all the endpoints have been updated to using the new certificate, the Oracle Key Vault server begins the process of fully rotating its own server certificates in the background.

1. Log in to Oracle Key Vault management console as a user who has the System Administrator role.
2. Select the **System** tab, then **Settings** in the left navigation side bar.
3. In the Certificates area, select **Server Certificate**.
By default, **Server Certificate** is selected.
4. Check the Manage Server Certificate page.

The certificate rotation process is deemed complete when the Manage Server Certificate page no longer shows two certificates listed, but only a single one that reflects the new certificate. The OKV Server Expiration Date field in the System Status page should reflect the expiration time of the new certificate certificate as well. In a multi-master cluster environment, you can initiate another certificate rotation only after all the nodes have completed their certification rotation process.

17.1.6 Checking the Certificate Rotation Status for Endpoints

You can use the Oracle Key Vault management console to check the status of a certificate rotation for endpoints.

1. Log in to Oracle Key Vault management console as a user who has the System Administrator role.
2. Select the **Endpoints** tab.
3. Select **Endpoints**.

On the Endpoints page, you can see a status of the rotation process for the certificate (**Updating to current certificate issuer**) in the Endpoints page. When it is complete, it will show the name of the common name of the new Oracle Key Vault CA.

If there are errors with the certificate rotation of an endpoint, then Oracle recommends that you reenroll the endpoint.

17.1.7 Post-Certificate Rotation Tasks

After you have completed the certificate rotation, you should perform post-rotation tasks.

Do the following:

- If you had previously downloaded the Oracle Key Vault RESTful services software utility (`okvrestclipackage.zip`), then download it again so that you can continue to use the RESTful services utility. Ensure that you have fully rotated the certificate (across all nodes in a multi-master cluster environment and in the servers of a primary-standby environment) before you download `okvrestclipackage.zip`.

To do so, select the **Endpoint Enrollment and Software Download** link on the Oracle Management console login page. Select the **Download RESTful Service Utility** tab, and then click **Download** to download the `okvrestclipackage.zip` file to a secure location.

If you are using KMIP REST, then you do not need to perform this step because the `okvutil` endpoint that contains the `okvclient.ora` has received the updates.

- Back up all systems across the Oracle Key Vault configuration. It is important that you perform this backup operation after the certificate rotation is complete. Later on, if you rotate certificates in your configuration (so that the endpoints have been updated to using new certificates as well), but then restore the Oracle Key Vault server from a backup that was taken **before** the certificate rotation was performed, then the endpoints will not be able to connect to the restored Oracle Key Vault system.
- If the Oracle Key Vault public key has changed, re-copy the public key that appears in the **Public Key** field and then paste it in the appropriate configuration file, such as `authorized_keys`, on the destination server. Be aware that certain events may trigger a change of the public key, which means that Oracle Key Vault cannot use the backup destination until the new public key is re-copied from Oracle Key Vault to the appropriate configuration file. These events include but are not limited to certificate rotation, changing the IP address, and conversion to a cluster node.

17.2 Managing Console Certificates

You can use the Oracle Key Vault management console to manage console certificates.

- [About Managing Console Certificates](#)
Oracle Key Vault enables you to install a certificate signed by a Certificate Authority (CA) for more secure connections.
- [Step 1: Download the Certificate Request](#)
When you request the console certificate, you can suppress warning messages.

- [Step 2: Have the Certificate Signed](#)
After you download the Oracle Key Vault `certificate.csr` file, you can have it signed.
- [Step 3: Upload the Signed Certificate to Oracle Key Vault](#)
In addition to uploading the signed certificate, you can optionally choose to deactivate and re-activate the certificate.
- [Console Certificates in Special Use Case Scenarios](#)
Depending on the situation, you must perform additional steps when you use console certificates.

17.2.1 About Managing Console Certificates

Oracle Key Vault enables you to install a certificate signed by a Certificate Authority (CA) for more secure connections.

You can upload a certificate that was signed by a third-party CA to Oracle Key Vault to prove its identity, encrypt the communication channel, and protect the data that is exchanged throughout the Oracle Key Vault system.

To install a console certificate, you must generate a certificate request, get it signed by a CA, and then upload the signed certificate back to Oracle Key Vault.

17.2.2 Step 1: Download the Certificate Request

When you request the console certificate, you can suppress warning messages.

These warning messages appear when the browser detects a mismatch between the attributes of the server certificate and the attributes of the login session to the Oracle Key Vault management console.

1. Log in to the Oracle Key Vault management console as a user who has the System Administrator role.
2. Select the **System** tab, and then **Settings** from the left navigation bar.
3. In the Certificates area, click **Console Certificate**.
4. In the Console Certificate page, click **Generate Certificate Request**.

Generate Certificate Request



Generate Certificate Request

Cancel
Submit and Download

Common Name okv00001700af2c [Change](#)

Common Name is a fully qualified domain name (FQDN)
which matches the hostname in the URL used to access this Oracle Key Vault
Server.

Suppress warnings for IP based URL access

Organization Name *

Country / Region *

Organizational Unit

City

State/Province

Email

5. If you need to change the host name of the Oracle Key Vault server, which appears next to **Common Name**, then click **Change**.

The Network Details window appears, where you can change the **Host Name** setting. Click **Save** afterward.

6. Check the box to the left of text **Suppress warnings for IP based URL access** if you want to suppress browser warnings for server IP address changes.
7. Enter the required fields marked with an asterisk, **Organization Name** and **Country / Region**.

You must enter values for these fields in order to proceed without errors. You may enter values in the rest of the optional fields as needed.

8. Click **Submit and Download** to the top right.

A directory window appears, where you can save the `certificate.csr` file. Select a directory and save the file to a secure location.

17.2.3 Step 2: Have the Certificate Signed

After you download the Oracle Key Vault `certificate.csr` file, you can have it signed.

- Use any out-of-band method to have the `certificate.csr` file signed by a CA of your choice.

Afterward, you can upload the signed certificate back to Oracle Key Vault using the management console.

17.2.4 Step 3: Upload the Signed Certificate to Oracle Key Vault

In addition to uploading the signed certificate, you can optionally choose to deactivate and re-activate the certificate.

1. Log in to the Oracle Key Vault management console as a user who has the System Administrator role.
2. Select the **System** tab, and then **Settings** from the left navigation bar.
3. In the Certificates area, click **Console Certificate**.
4. Click **Upload Certificate** at the top right to display the **Upload Certificate** page.
5. Select **Choose File** to display a directory window on your local system.
6. Navigate to the directory where you stored the signed certificate and select it. When you are done, you will see the file name to the right of text **Choose File**.

After you select the certificate, you will see the file name to the right of **Choose File**.

7. Click **Upload**.

If the certificate is installed with no errors, then you will see its details appear in a new Uploaded Certificate Details panel just below **Console Certificate**.

At this stage, if you need to, you can deactivate the certificate by clicking **Deactivate** on the top right of the **Uploaded Certificate Details** section. When you deactivate the certificate, the **Deactivate** button is replaced by an **Apply Certificate** button. You can click this button to re-activate the certificate.

17.2.5 Console Certificates in Special Use Case Scenarios

Depending on the situation, you must perform additional steps when you use console certificates.

- **Primary-standby environments:** If you want to use a console certificate in a primary-standby configuration, then you must install it on the primary and standby servers first, and then pair them.
- **Restored data from a backup:** If you install a console certificate, perform a backup, and then restore another Oracle Key Vault appliance from that backup, you must re-install the console certificate on the new server before you can use it. The restore process does not copy the console certificate.

18

Backup and Restore Operations

Backups provide the ability to restore Oracle Key Vault to a previous state in the case of a failure.

- [About Backing Up and Restoring Data in Oracle Key Vault](#)
You can use Oracle Key Vault to back up and restore Oracle Key Vault data.
- [Oracle Key Vault Backup Destinations](#)
A backup destination is the location where Oracle Key Vault data will be copied to and stored.
- [Scheduled Backups and States](#)
Oracle Key Vault provides scheduled backup types depending on the backup destination, and different states that indicate the progress of the backup activity.
- [Scheduling and Managing Oracle Key Vault Backups](#)
You can schedule Oracle Key Vault backups to specific backup destinations and times.
- [Restoring Oracle Key Vault Data](#)
Oracle Key Vault data from a remote backup destination can be restored onto another Oracle Key Vault server.
- [Backup and Restore Best Practices](#)
Oracle provides best practices to keep backups current so that you can recover from catastrophic failures with minimum downtime and data loss.

18.1 About Backing Up and Restoring Data in Oracle Key Vault

You can use Oracle Key Vault to back up and restore Oracle Key Vault data.

You should back up data periodically to reduce downtime and recover from unexpected data losses and system failures. You can restore a new or existing Oracle Key Vault server from a backup.

You can perform backup and restore operations from the Oracle Key Vault management console or by using the Oracle Key Vault RESTful services commands. You must be a user who has the System Administrator role to back up and restore Oracle Key Vault data. You can schedule backups at periodic intervals to run automatically at designated times. You also can run these operations on-demand to save a current snapshot of the system.

Oracle strongly recommends that you back up Oracle Key Vault data regularly on a schedule. This practice ensures that backups are current and hold the most recent data. You can use this backup to restore a new or existing Oracle Key Vault server and be fully operational with minimum data loss.

Oracle Key Vault encrypts all backed up data. When you use a remote destination, this data is copied using the secure copy protocol (SCP) or the secure file transfer protocol (SFTP). You must therefore ensure that either SCP or SFTP is supported at the remote backup destination.

In an Oracle Key Vault multi-master cluster environment, the replication intrinsically creates copies of data on other nodes in the cluster. However, you can still perform backups and

backup-related operations on all individual Oracle Key Vault cluster nodes. Be aware that backups can still only be restored to standalone Oracle Key Vault servers. Therefore, backups in a cluster are taken for disaster recovery in case of a complete cluster failure and should all be on remote destinations.

18.2 Oracle Key Vault Backup Destinations

A backup destination is the location where Oracle Key Vault data will be copied to and stored.

- [About the Oracle Key Vault Backup Destination](#)
The backup destination enables the backup data to be available on Oracle Key Vault itself or on another server.
- [Creating a Remote Backup Destination](#)
You can use the Oracle Key Vault management console to create a remote backup destination.
- [Changing Settings on a Remote Backup Destination](#)
After you have created the backup destination, you can change the SCP or SFTP port number and details of the user account.
- [Deleting a Remote Backup Destination](#)
You can delete a remote backup destination (but not the local destination) to stop future backups to that destination server.

18.2.1 About the Oracle Key Vault Backup Destination

The backup destination enables the backup data to be available on Oracle Key Vault itself or on another server.

This ensures that you have all the relevant data to recover in case of a catastrophic failure with the Oracle Key Vault server or hardware.

The backup destination is usually another server or computer system that you have access to. You can add, delete, and modify a backup destination.

The backup operation copies Oracle Key Vault data to a backup destination of your choice. The backup destination stores the data until it is needed.

Oracle Key Vault provides two types of backup destinations: local and remote. The local backup destination resides on the Oracle Key Vault server itself, the remote one resides externally in a different server or computer system. You can create more than one backup destination for greater availability.

Local and remote backup destinations have the following characteristics:

- **Local backup destination:** The local backup destination, `LOCAL`, is present by default and cannot be removed. Backups to the local backup destination are local backups.

Backups to `LOCAL` are useful to save a current state of Oracle Key Vault. Because these backups are stored on disk, they could be lost in the case of hardware or other catastrophic failure. They will also not be available after a failover or switchover in a primary-standby configuration. You cannot restore the backups to a primary-standby without first unpairing the primary from the standby, nor can you

restore the backups to a cluster configuration. Therefore, you should back up the data to a remote destination when using these configurations.

A `LOCAL` destination can store only the last full backup and the cumulative incremental backups after that full backup. After a new full backup of the periodic backup to `LOCAL` completes, the previous periodic full or cumulative incremental backups are deleted.

- **Remote backup destinations:** Remote backup destinations reside on external servers and can be dispersed geographically for disaster recovery purposes. Backups to remote backup destinations are remote backups.

Each backup destination on the external server is associated with a backup catalog file called `okvbackup.mgr` that Oracle Key Vault maintains at the backup destination. The `okvbackup.mgr` file catalogs the backups performed and is used to restore data.

 **Note:**

You cannot use another Oracle Key Vault server as a remote backup destination.

 **Caution:**

- Oracle Key Vault may not be able to find the backups if you delete or modify the backup catalog file. Therefore, do not delete or modify this file.
- Do not configure the same remote backup destination directory for different Oracle Key Vault servers as backup destinations, because backups that happen concurrently from different Oracle Key Vault servers will overwrite each other's catalog file, with the result that Oracle Key Vault may not be able to locate the backups correctly.
- After you restore a backup that contains a remote backup destination, do not continue to use that remote backup destination. Delete any backup jobs that are configured to send backups to that destination. Continuing to use this backup destination could corrupt the backup catalog file. Oracle Key Vault may not be able to locate backups correctly.
- Configure each node in a multi-master cluster to send their backups to a different backup destination.

Related Topics

- [Types of Oracle Key Vault Backups](#)
Oracle Key Vault provides two types of backup jobs that can be scheduled: one-time backups and periodic backups.

18.2.2 Creating a Remote Backup Destination

You can use the Oracle Key Vault management console to create a remote backup destination.

To create a remote backup destination, you must provide a user account, a unique existing directory location on an external server, and an authentication method (password or key-

based). Oracle Key Vault needs this information to make a secure connection with the remote server.

1. Log in to the Oracle Key Vault management console as a user with the System Administrator role.
2. Select the **System** tab, and then **Settings** from the left navigation bar.
3. In the System Configuration area, click **Backup and Restore**.
4. In the System Backup page, select **Manage Backup Destinations**.

The Manage Backup Destinations window appears.

	Name	Transfer Type	Hostname	Port	Authentication Method	User Name	Filepath
<input type="checkbox"/>	LOCAL	-	localhost			-	-

5. Click **Create**.

The Create Backup Destination window appears.

Destination Name *

Transfer Method scp sftp

Hostname *

Port * 22

Destination Path *

User Name *

Authentication Method Key-based Authentication Password Authentication

Public Key

```
ssh-rsa
AAAAB3NzaC1yc2EAAAADAQABAAQCKHsy7KIQRNCHagpBst2
u6C30Yce0y2okfQkaPrcUahKTvWUisEggZhk4Au3lucL4nDe/Q
Spt6qvj79i5TMI+aHjd8yXW0Y6gIGem1
/uzTqQgeKdyYJKA5B7YjJ+E
/9mS0q1VZaQhDyZmdUSK7jcyw3C01oU1UNebUmu23KLn7eVdN4
LTI0H+keOXTyLB1Cj0vym1U+MhHBS045ad9k8auqJoymj0XGR
W711T23.TE7y9T7a2Vv2rC21-Dv0NvYvYf1QvYDvV2a2w7H2aHT
```

6. Enter the following information for the backup location:
 - **Destination Name:** Enter a descriptive name to identify the backup destination.
 - **Transfer Method:** Choose between `scp` and `sftp` to copy files to the remote destination.
 - **Hostname:** Enter the host name or IP address of the remote server for the backup destination. If you enter the host name, then ensure that DNS is configured to translate the host name to its corresponding IP address. Do not include spaces, single quotation marks, or double quotation marks in a host name that is in a remote backup destination.
 - **Port:** Enter the SCP or SFTP port number on the external server. The default is 22.
 - **Destination Path:** Enter the path to an existing directory on the external server where the backup file will be copied. You cannot modify this directory

location after the backup destination is created. This path must not be the destination for backups from another Oracle Key Vault server. Do not include spaces, single quotation marks, or double quotation marks destination path that is in a remote backup destination.

- **Username** Enter the user name of the user account that can be used to establish an SCP or SFTP connection to the remote server. Ensure that this user has write permissions on the directory that is specified in **Destination Path**. Do not include spaces, single quotation marks, or double quotation marks in a user name that is in a remote backup destination.
- **Authentication Method:** Choose one of the following:
 - **Key-based Authentication:** Copy the public key that appears and paste it in the appropriate configuration file, such as `authorized_keys`, on the destination server. Be aware that certain events may trigger a change of the public key, which means that Oracle Key Vault cannot use the backup destination until the new public key is re-copied from Oracle Key Vault to the appropriate configuration file. These events include but are not limited to certificate rotation, changing the IP address, and conversion to a cluster node.
 - **Password Authentication:** The password of the user account entered in the **Username** field.

7. Click **Save**.

Oracle Key Vault validates the input that you supplied to create the backup destination by creating empty test files under both `/tmp` and the directory that you supplied in the **Destination Path** field. If the validation fails, then the backup destination is not created. If this happens, then check values for the user account on the remote server (user name and password or key) and ensure that the directory has write permissions for the user. Finally, ensure that the remote server is active.

18.2.3 Changing Settings on a Remote Backup Destination

After you have created the backup destination, you can change the SCP or SFTP port number and details of the user account.

You cannot change any other setting.

1. Log in to the Oracle Key Vault management console as a user who has the System Administrator role.
2. Select the **System** tab, and then **Settings** from the left navigation bar.
3. In the System Configuration area, click **Backup and Restore**.
4. Select **Manage Backup Destinations**.

The Manage Backup Destinations page appears displaying `LOCAL` and remote backup destinations.

5. Click a remote backup destination name to edit the backup destination.

The Edit Backup Destination page appears.

6. Modify the following information:
 - **Port:** Change the SCP or SFTP port number on the external server.
 - **Destination Public Key:** This field shows the public key information that Oracle Key Vault currently has stored in its `known_hosts` file for the remote server. If the remote server's public key changes, then Oracle Key Vault cannot copy backups to or from

the remote server. In order to store the new public key in the `known_hosts` file, click the **Reset Dest Public Key** button, which will retrieve and save the new public key from the remote server. After you click **Reset Dest Public Key**, verify that the correct public key was saved.

- **Username:** Enter the user name of the user account that can be used to establish an SCP or SFTP connection to the remote server. Ensure that the new user has write permissions on the directory that is specified in **Destination Path**, because this path cannot be changed.
- **Authentication Method:** Choose one of the following:
 - **Password Authentication:** The password of the user account entered in the **Username** field.
 - **Key-based Authentication:** If the Oracle Key Vault public key has changed, re-copy the public key that appears in the **Public Key** field and then paste it in the appropriate configuration file, such as `authorized_keys`, on the destination server. Be aware that certain events may trigger a change of the public key, which means that Oracle Key Vault cannot use the backup destination until the new public key is re-copied from Oracle Key Vault to the appropriate configuration file. These events include but are not limited to certificate rotation, changing the IP address, and conversion to a cluster node.

7. Click **Save**.

Oracle Key Vault validates the input that you supplied to update the backup destination. If the validation fails, then the backup destination is not updated. If this happens, then check values for the user account on the remote server (user name and password) and ensure that the directory has write permissions for the user. Finally, ensure that the remote server is active.

18.2.4 Deleting a Remote Backup Destination

You can delete a remote backup destination (but not the local destination) to stop future backups to that destination server.

Deleting a remote backup destination from Oracle Key Vault does not remove the backups on the destination.

1. Log in to the Oracle Key Vault management console as a user who has the System Administrator role.
2. Select the **System** tab, and then **Settings** from the left navigation bar.
3. In the System Configuration area, click **Backup and Restore**.
4. Select **Manage Backup Destinations**.
5. In the Manage Backup Destinations page, check the boxes for the backup destinations that you want to delete.
6. Click **Delete**.

18.3 Scheduled Backups and States

Oracle Key Vault provides scheduled backup types depending on the backup destination, and different states that indicate the progress of the backup activity.

- [About Schedule Backup Types and States](#)
You can schedule backups in Oracle Key Vault for specific times and backup destinations.
- [Types of Oracle Key Vault Backups](#)
Oracle Key Vault provides two types of backup jobs that can be scheduled: one-time backups and periodic backups.
- [Scheduled Backup States in Oracle Key Vault](#)
Scheduled backups have four states, which indicate whether the backup is scheduled, in progress, completed, or paused.

18.3.1 About Schedule Backup Types and States

You can schedule backups in Oracle Key Vault for specific times and backup destinations.

The backup process starts at the scheduled time and generates a system backup, which is a file that is stored on the backup destination. There is one backup file for each completed backup.

No backup can start if another backup is in progress. You can change the schedule of backups as needs change. You can continue working with Oracle Key Vault while the backup is in progress.

A system restart will terminate any ongoing backup. If you must restart the system during the time a backup is scheduled to occur, then you can pause the backup and resume the backup after the system restarts.

18.3.2 Types of Oracle Key Vault Backups

Oracle Key Vault provides two types of backup jobs that can be scheduled: one-time backups and periodic backups.

- **One-time backup:** A one-time backup makes a full backup of the Oracle Key Vault system. You can schedule multiple one-time backup jobs, each with its own start time.
You should make one-time local backups before making significant configuration changes to Oracle Key Vault, in case you need to recover from configuration failures.
`LOCAL` destinations can only store the last one-time backup. When a one-time backup to `LOCAL` completes, the previous backup is deleted.
- **Periodic backup:** After you schedule a periodic backup, Oracle Key Vault takes a full backup at the designated start time and then puts the backup schedule in the `ACTIVE` state. After the backup period passes, another backup starts. If it has been less than 7 days since the last full backup, then the next backup will be a cumulative incremental backup, which holds changes since the last full backup. If it has been more than 7 days since the last full backup, then the next backup will be a full backup.
For example, if the backup period is one day, then every seventh one is a full backup. If the backup period is 8 days, then all backups are full backups. If the backup period is 12 hours, then there are 13 cumulative backups before a full backup.
You should schedule periodic backups with a period of 1 day or less to minimize data loss.
A `LOCAL` destination can store only the last full backup and the cumulative incremental backups after that full backup. After the periodic backup schedule takes a new full backup to `LOCAL`, previous periodic full and cumulative backups in `LOCAL` are deleted.

Cumulative incremental backups are faster than full backups. Only one periodic backup can be scheduled at any time.

Related Topics

- [Scheduled Backup States in Oracle Key Vault](#)
Scheduled backups have four states, which indicate whether the backup is scheduled, in progress, completed, or paused.

18.3.3 Scheduled Backup States in Oracle Key Vault

Scheduled backups have four states, which indicate whether the backup is scheduled, in progress, completed, or paused.

- **ACTIVE:** The backup is scheduled and will start at the next start time. (The start time is indicated in the Start Time column on the Scheduled Backups page.)
- **PAUSED:** All future backups are on hold and will not start even if the start time has passed. They will start when they are explicitly resumed. You can change the state from active to paused and back. Put a scheduled backup in the paused state for these situations:
 - When communication between Oracle Key Vault and the remote destination is broken
 - If the remote destination is unavailable
 - If you want to defer the backup
- **ONGOING:** The backup is in progress.
- **DONE:** The backup is complete.

18.4 Scheduling and Managing Oracle Key Vault Backups

You can schedule Oracle Key Vault backups to specific backup destinations and times.

You must create the backup destinations that you will use beforehand, and you can modify or delete backup schedules.

- [Scheduling a Backup for Oracle Key Vault](#)
You can schedule a one-time or a periodic backup to a local or remote backup destination.
- [Changing a Backup Schedule for Oracle Key Vault](#)
You cannot change the schedule of a backup in progress.
- [Deleting a Backup Schedule from Oracle Key Vault](#)
You can delete a backup schedule from the Oracle Key Vault management console.
- [How Primary-Standby Affects Oracle Key Vault Backups](#)
In a primary-standby deployment, you must perform backups on the primary server.
- [How Using a Cluster Affects Oracle Key Vault Backups](#)
In a multi-master cluster environment, be aware of how the backup process works in individual nodes and the entire cluster.

- [Protecting the Backup Using the Recovery Passphrase](#)
Oracle Key Vault uses the recovery passphrase to control who can restore system backups.

18.4.1 Scheduling a Backup for Oracle Key Vault

You can schedule a one-time or a periodic backup to a local or remote backup destination.

You can start a one-time backup to start immediately without setting a time. However, do not schedule backup operations if a certificate rotation or cluster operation is in progress.

1. Log in to the Oracle Key Vault management console as a user who has the System Administrator role.
2. Select the **System** tab, and then **Settings** from the left navigation bar.
3. In the System Configuration area, click **Backup and Restore**.
4. In the Backup page, click **Backup**.

The Backup page appears. The following image shows how it appears when **PERIODIC** is selected.

The screenshot shows the 'Backup' configuration page in the Oracle Key Vault management console. The page has a title 'Backup' and two buttons: 'Cancel' and 'Schedule'. The form contains the following fields:

- Name**: A text input field.
- Start Time**: A date and time picker showing '07-DEC-2020 15:36' with a calendar icon and a 'Now' button.
- Destination**: A dropdown menu currently set to 'LOCAL'.
- Type**: Two radio buttons, 'ONE-TIME' and 'PERIODIC'. The 'PERIODIC' option is selected.
- Days**: A text input field with the value '0'.
- Hours**: A dropdown menu with the value '00'.
- Mins**: A dropdown menu with the value '00'.

5. In the **Name** field, enter a name for the backup.
6. If you want to perform a periodic backup, then do the following:
 - a. In the **Start Time** field, use the Calendar icon to specify the start time for the backup. If you want the first backup to perform immediately after you click **Schedule**, then select **Now**.
 - b. For **Type**, select **PERIODIC**.
The additional fields **Days**, **Hours**, and **Mins** appear.
 - c. In the **Days**, **Hours**, and **Mins** fields, specify the interval at which periodic backups will occur.
 - d. For **Destination**, select the backup destination.
 - e. Click **Schedule** to add the scheduled backup to the Scheduled Backup(s) page.
7. If you want to perform a one-time backup, then do the following:
 - a. In the **Start Time** field, use the Calendar icon to specify the start time for the backup. If you want the backup to perform immediately after you click **Schedule**, then select **Now**.
 - b. For **Type**, select **ONE-TIME**.
 - c. For **Destination**, select the destination backup from the list.
 - d. Click **Schedule** to add the scheduled backup to the Scheduled Backup(s) page.

18.4.2 Changing a Backup Schedule for Oracle Key Vault

You cannot change the schedule of a backup in progress.

To change the backup schedule the state must be active or paused.

1. Log in to the Oracle Key Vault management console as a user who has the System Administrator role.
2. Select the **System** tab, and then **Settings** from the left navigation bar.
3. In the System Configuration area, click **Backup and Restore**.
4. Click the name of the scheduled backup in the Scheduled Backup(s) page.
5. Enter the **Start Time** or manually enter or click the calendar icon to choose the **Start Time** of the backup schedule.

You can only change the scheduled start time if it has not already passed. This means that the state cannot be ongoing or done. For a periodic backup you can change the start time if the scheduled start time has not passed.

6. If you are changing a periodic backup schedule, then in the **Days**, **Hours**, and **Mins** fields, specify the interval at which periodic backups will occur.
7. Select **Save**.

18.4.3 Deleting a Backup Schedule from Oracle Key Vault

You can delete a backup schedule from the Oracle Key Vault management console.

1. Log in to the Oracle Key Vault management console as a user who has the System Administrator role.
2. Select the **System** tab, and then **Settings** from the left navigation bar.
3. In the System Configuration area, click **Backup and Restore**.
4. Check the boxes of scheduled backups listed in the Scheduled Backup(s) page.
5. Click **Delete** to delete the selected backup schedules.

18.4.4 How Primary-Standby Affects Oracle Key Vault Backups

In a primary-standby deployment, you must perform backups on the primary server.

Because the standby synchronizes its state with the primary, you do not need to back up the standby.

Be aware of the following behavior for failover or switchover operations in a primary-standby deployment:

- Any backups in progress will terminate if there is a failover or a primary-standby switchover. Backups to `LOCAL` are private to the Oracle Key Vault server and therefore the local backup on the primary server is not available after a failover or switchover.
- Backups scheduled with password authentication start as usual after the failover or switchover.

- Because backups can only be restored to standalone servers, you must unpair primary-standby deployments before you can perform a backup restore operation on the former primary.

18.4.5 How Using a Cluster Affects Oracle Key Vault Backups

In a multi-master cluster environment, be aware of how the backup process works in individual nodes and the entire cluster.

- In an Oracle Key Vault multi-master cluster environment, the replication intrinsically creates copies of data on other nodes in the cluster. However, you can still perform backups and backup-related operations on all individual Oracle Key Vault cluster nodes.
- Backups in a cluster are taken for disaster recovery in case of a complete cluster failure and should all be done on remote destinations.
- Backups can still only be restored to standalone Oracle Key Vault servers. Because a cluster node cannot be switched back to a standalone server, only remote backups should be taken.

18.4.6 Protecting the Backup Using the Recovery Passphrase

Oracle Key Vault uses the recovery passphrase to control who can restore system backups.

To restore a backup, use the Oracle Key Vault recovery passphrase from the time when the backup was initiated. This is necessary even if the recovery passphrase was changed after the backup completed. Oracle recommends that you make a new backup every time the recovery passphrase is changed to ensure that there is always a copy of the backup that is protected by the most recent recovery passphrase.

Related Topics

- [Emergency System Recovery Process](#)
During installation, you will be required to create a special recovery passphrase that Oracle Key Vault uses to recover from emergency situations.

18.5 Restoring Oracle Key Vault Data

Oracle Key Vault data from a remote backup destination can be restored onto another Oracle Key Vault server.

This restore operation minimizes downtime and data loss.

- [About the Oracle Key Vault Restore Process](#)
The restore process replaces the database with the backup data.
- [Procedure for Restoring Oracle Key Vault Data](#)
You can restore Oracle Key Vault data to a standalone server using the Oracle Key Vault management console.
- [Multi-Master Cluster and the Restore Operation](#)
In a multi-master cluster deployment, you must consider several factors before you restore data to Oracle Key Vault.
- [Primary-Standby and the Restore Operation](#)
In a primary-standby deployment, you must consider several factors before you restore data to Oracle Key Vault.

- [Certificates and the Restore Operation](#)
A third-party certificate installed at the time of a backup will not be copied when you restore another server from this backup.
- [Changes Resulting from a System State Restore](#)
Restoring an Oracle Key Vault server brings the system state back to the time when the backup last performed.

18.5.1 About the Oracle Key Vault Restore Process

The restore process replaces the database with the backup data.

You must restore Oracle Key Vault data to a server only after ensuring that all scheduled backups on the server are completed.

Restoring data to an Oracle Key Vault server replaces the data in the server with that of the backup. The data restored is only as current as the backup. The restore operation replaces the Oracle Key Vault server with the backup. This means that some data can be lost. You might need to restore the endpoint database. Any data that is not in the backup that is getting restored will be lost. Backups can only be restored to the same version of Oracle Key Vault at which the backup was taken.

The maximum life of a backup is 1 year.

You must have the recovery passphrase that was in effect at the time of the backup in order to restore data from a backup. If you have not changed the recovery passphrase since installing Oracle Key Vault, then you must use the recovery passphrase that you created during the post-installation process.

Restoring data in Oracle Key Vault entails the following general steps:

1. Setting up the backup environment, which includes, after installing Oracle Key Vault, configuring backup destinations.
2. Performing the restore operation by determining the backup to use from a local or remote backup destination, and then providing the recovery passphrase to begin the restore process.

Related Topics

-

18.5.2 Procedure for Restoring Oracle Key Vault Data

You can restore Oracle Key Vault data to a standalone server using the Oracle Key Vault management console.

Before you restore, ensure that you have the correct recovery passphrase. You will need to enter this passphrase during the restore process. In addition, do not perform a restore operation while a certificate rotation process is in progress.

1. Log in to the Oracle Key Vault management console as a user who has the System Administrator role.
2. Select the **System** tab, and then **Settings** from the left navigation bar.
3. In the System Configuration area, click **Backup and Restore**.
4. In the System Backup page, click **Restore**.

The Restore page appears.

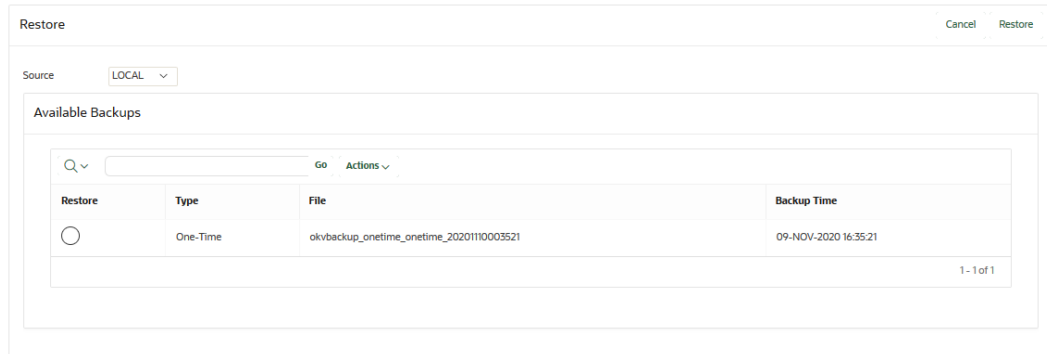

5. Select **Source** from the drop-down list.
Values are either **LOCAL** or the names of configured remote destinations.
6. Select **Restore** next to the backup you want to restore from.
7. Click **Restore** to initiate the restore or recovery process.
You are prompted for the recovery passphrase.
8. Enter the recovery passphrase and then click **Restore** to begin.
The system will restore from the backup and then restart.
9. After the restore is complete and the system has restarted, delete any paused periodic backup jobs and then re-create them, using a new backup destination.
Oracle recommends that you delete such jobs in order to avoid corrupting the backup catalog file.
10. If your site uses the Commercial National Security Algorithm (CNSA) suite, then re-install these algorithms on the Oracle Key Vault server after the restore operation is complete.
11. If you had integrated Oracle Audit Vault with Oracle Key Vault before the restoration process, then do the following:
 - a. Log in to the Audit Vault Server console as an administrator and then delete the target and agent for Oracle Key Vault.
 - b. Log in to the Oracle Key Vault management console and then re-integrate Oracle Audit Vault with Oracle Key Vault.

Related Topics

- [Performing Backup Restore Operations with CNSA](#)
After you restore a backup of the Oracle Key Vault that was configured to use the enhanced Commercial National Security Algorithm (CNSA) Suite, use `/usr/local/okv/bin/okv_cnsa` to reconfigure CNSA compliance.
- [Integrating Oracle Audit Vault with Oracle Key Vault](#)
You can perform this integration from the Oracle Key Vault management console.

18.5.3 Multi-Master Cluster and the Restore Operation

In a multi-master cluster deployment, you must consider several factors before you restore data to Oracle Key Vault.

- You must restore only if all nodes in the cluster are lost.

- You must restore the backup to a standalone Oracle Key Vault server that has the same IP address as the node from which the backup was taken. Not doing so may affect the ability of endpoints to connect to the restored backup.
- After the restore operation, you must now use the restored server as the first node of a new cluster.

18.5.4 Primary-Standby and the Restore Operation

In a primary-standby deployment, you must consider several factors before you restore data to Oracle Key Vault.

- You must perform the restore operation only if both the primary and standby data are lost.
- You must restore the backup on a standalone Oracle Key Vault server only, even if the backup was taken from the primary.
- If you restore a backup taken from the primary node, you must use a freshly installed Oracle Key Vault server as the new standby.
- If the standby server has taken over as primary, and the former primary is lost, then there is no need to restore data from a backup to a new standby server. Just add a new standby server to the primary-standby deployment, which will automatically synchronize with the new primary.

Related Topics

- [Performing Backup Restore Operations with CNSA](#)
After you restore a backup of the Oracle Key Vault that was configured to use the enhanced Commercial National Security Algorithm (CNSA) Suite, use `/usr/local/okv/bin/okv_cnsa` to reconfigure CNSA compliance.

18.5.5 Certificates and the Restore Operation

A third-party certificate installed at the time of a backup will not be copied when you restore another server from this backup.

You must re-install the third-party certificate on the new server in order to use it.

If you perform a certificate rotation in your configuration (so that the endpoints have been updated to using new certificates as well), but then restore the Oracle Key Vault server from a backup that was taken **before** the certificate rotation was performed, then the endpoints will not be able to connect to the restored Oracle Key Vault system.

Related Topics

- [Managing Certificates](#)
In addition to Oracle Key Vault-generated certificates, you can manage third-party certificates.

18.5.6 Changes Resulting from a System State Restore

Restoring an Oracle Key Vault server brings the system state back to the time when the backup last performed.

Therefore, any changes that were made after the backup was made do not exist on the restored system. For example, if a user's password was changed after the backup

operation, the new password will not be available in the restored system. The restored system will have the password that was in effect when the backup was made.

**Note:**

Restoring also changes the recovery passphrase to the one that was in effect during the backup.

You should change the user passwords, enroll the endpoints created after backup, and make other similar changes, if required. You should confirm that everything is configured correctly after restoring.

If you are not certain that you restored the correct backup, then you can restore a different one, provided that Oracle Key Vault continues to remain a standalone server. To restore another backup, first configure the remote destination of this backup on the restored Oracle Key Vault itself, and then start the restore process. You do not need to reinstall the Oracle Key Vault appliance.

When the Oracle Key Vault server has been restored and is functional, you can continue to back up Oracle Key Vault data to new remote destinations.

Oracle recommends that you change user passwords after a restore operation and backup the Oracle Key Vault.

18.6 Backup and Restore Best Practices

Oracle provides best practices to keep backups current so that you can recover from catastrophic failures with minimum downtime and data loss.

- Ensure that the recovery passphrase at the time of backup is accessible because you will need it to restore data from a backup.
- Back up data any time you change the recovery passphrase.
- Ensure that you create at least one remote backup destination in a primary-standby deployment. Because the local backup resides on the Oracle Key Vault server itself, it will be lost in a failover or switchover situation.
- Do not edit or delete the backup catalog file that is associated with a remote backup destination, even if you stop using the backup destination. If you ever need to restore from a backup on this server, you will need the backup catalog file.
- If you use the same remote server for multiple backup destinations, then ensure that the directories are unique so that you have distinct backup catalog files associated with each backup destination. If you fail to do this, then the backup catalog file will be overwritten during subsequent backups and become unusable.
- When you restore a backup, do so to a standalone Oracle Key Vault server that has the same IP address as the Oracle Key Vault server on which the backup was taken. Failing to do so may result in endpoints not being able to connect to the restored backup.
- Before you restore data, ensure that all scheduled backups are complete.
- To create remote backup destinations successfully:
 - Ensure that the servers used as remote backup destinations are enabled and active.

- Ensure that there is connectivity between Oracle Key Vault and remote server that you plan to use as a backup destination.
 - Ensure that the remote server designated as a backup destination supports the secure copy protocol (SCP) or the SSH file transfer protocol (SFTP).
 - Validate the user account credentials on the remote server before you create the backup destination on Oracle Key Vault.
 - Ensure that the destination directory has write permissions.
 - Create more than one remote backup destination on multiple servers for redundancy.
 - Ensure that the destination directories are unique if you are using the same remote server for multiple backup destinations. You must do this to prevent later backups from overwriting previous ones.
- Perform a one-time backup once every seven days.
 - Schedule a periodic backup with a period of one day. This ensures that you have a full backup once in seven days.
 - Perform a local one-time backup before system changes. You can use this backup as a restore point.
 - Backup before and after upgrading Oracle Key Vault server software.
 - Backup before and after performing critical operations such as rotating certificates.
 - Change the backup destination after each upgrade. If at all possible do not reuse the backup destination.

19

Monitoring and Auditing Oracle Key Vault

Oracle Key Vault administrators can monitor and audit the Oracle Key Vault system, configure alerts and use reports.

- [Managing System Monitoring](#)
System monitoring refers to tasks such as configuring SNMP connections, email notifications, the syslog destination, and system diagnostics.
- [Configuring Oracle Key Vault Alerts](#)
You can select the type of alerts that you want to see in the Oracle Key Vault dashboard.
- [Managing System Auditing](#)
Auditing entails tasks such as capturing audit records in a syslog file or downloading the audit records to a local file.
- [Using Oracle Key Vault Reports](#)
Oracle Key Vault collects statistical information on a range of activities that impact Key Vault operations.

19.1 Managing System Monitoring

System monitoring refers to tasks such as configuring SNMP connections, email notifications, the syslog destination, and system diagnostics.

- [Configuring Remote Monitoring to Use SNMP](#)
With Simple Network Management Protocol (SNMP) enabled, system administrators can remotely monitor the Oracle Key Vault appliance and its services.
- [Configuring Email Notification](#)
You can use email notifications to directly notify administrators of Key Vault status changes without logging into the Oracle Key Vault management console.
- [Configuring the Syslog Destination for Individual Multi-Master Cluster Nodes](#)
On each node, you can forward syslog entries to a remote service such as Splunk or SIEM.
- [Capturing System Diagnostics](#)
To troubleshoot problems that may arise, you can generate a system diagnostics file.

19.1.1 Configuring Remote Monitoring to Use SNMP

With Simple Network Management Protocol (SNMP) enabled, system administrators can remotely monitor the Oracle Key Vault appliance and its services.

The collected data can be further processed and presented for the needs of the enterprise.

- [About Using SNMP for Oracle Key Vault](#)
You can use the Simple Network Management Protocol (SNMP) to monitor devices on a network for resource usage.

- [Granting SNMP Access to Users](#)
You can grant any user, including users who are not Oracle Key Vault administrators, access to SNMP data.
- [Changing the SNMP User Name and Password](#)
You can change the SNMP user name and password for a node at any time.
- [Changing SNMP Settings on the Standby Server](#)
You change the SNMP settings from the command line on the standby server.
- [Remotely Monitoring Oracle Key Vault Using SNMP](#)
SNMP enables you to monitor the vital components of Oracle Key Vault remotely without having to install new software in Oracle Key Vault.
- [SNMP Management Information Base Variables for Oracle Key Vault](#)
Oracle Key Vault provides a set of SNMP Management Information Base (MIB) variables that you can track.
- [Example: Simplified Remote Monitoring of Oracle Key Vault Using SNMP](#)
In Linux, you can simplify the SNMP commands you manually enter to find Oracle Key Vault information, yet still have useful and detailed output.

19.1.1.1 About Using SNMP for Oracle Key Vault

You can use the Simple Network Management Protocol (SNMP) to monitor devices on a network for resource usage.

Monitoring Oracle Key Vault is an important aspect how critical Oracle Key Vault's availability is when hundreds or thousands of Oracle and MySQL databases store their TDE master encryption keys in an Oracle Key Vault multi-master cluster. The types of resource usage that you should monitor include memory, CPU utilization, and processes. Even though Oracle Key Vault provides continuous key availability by allowing up to 16 (geographically distributed) instances to be connected to a single cluster, the health of each individual node contributes to the performance and availability of the entire cluster.

You can use Simple Network Management Protocol (SNMP) third-party tool to monitor remote systems that access Oracle Key Vault. The benefits of using SNMP to monitor Oracle Key Vault are as follows:

- There is no need to allow SSH access to Oracle Key Vault. (SSH access should only be enabled for the window of time in which it is being used.)
- You do not need to install additional tools to perform an SNMP monitoring operation.

Oracle Key Vault uses SNMP version 3 for user authentication and data encryption features. Unlike SNMP versions 1 and 2 that communicate in readable, insecure plaintext, SNMP 3 authenticates users and encrypts data on the communication channel between the monitoring server and the target. The information from Oracle Key Vault is unreadable to an intruder, even if the communication channel is intercepted.

In addition, with SNMP enabled on Oracle Key Vault, you can determine whether the key management server (KMIP daemon) is running. To track this information, you must use a third-party SNMP client to poll the Oracle Key Vault instance, because Oracle Key Vault does not provide SNMP client software.

Oracle Key Vault audits the creation and modification of SNMP credentials.

You must be a user with the System Administrator role to configure the SNMP account with a user name and password. These SNMP credentials are needed to access SNMP data.

In a multi-master cluster, the SNMP account with a user name and password can be set for all nodes of the cluster at once. It can also be set for each individual node.

 **Note:**

You must ensure that the SNMP username and password is *not* the same username and password as any of the Oracle Key Vault administrative user accounts with the System Administrator, Key Administrator, or Audit Manager role.

19.1.1.2 Granting SNMP Access to Users

You can grant any user, including users who are not Oracle Key Vault administrators, access to SNMP data.

1. Log in to the Oracle Key Vault management console as a user with the System Administrator role.
2. Select the **System** tab, and then select **Settings** from the left navigation bar.
3. In the Monitoring and Alerts area, click **SNMP**.

The Monitoring page appears.

Monitoring Settings 

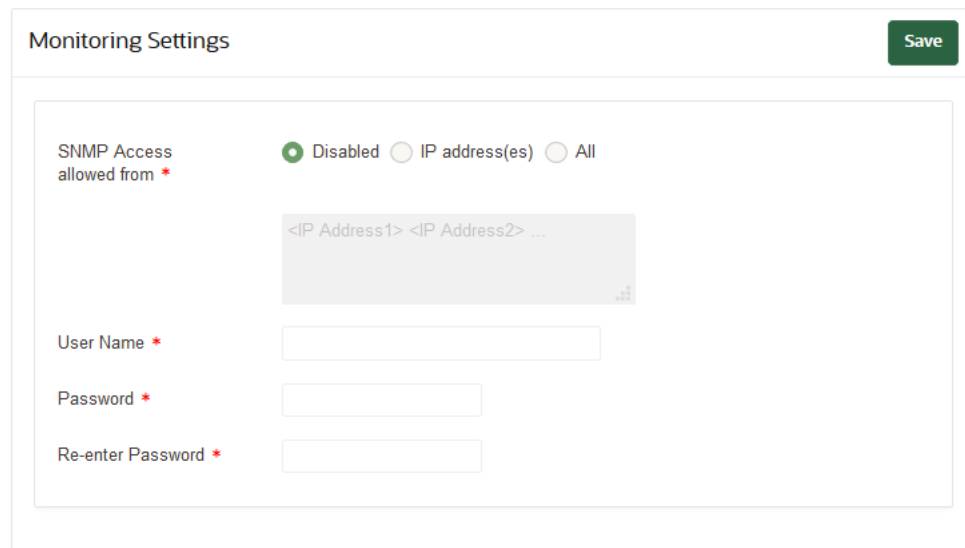

The screenshot shows the 'Monitoring Settings' page. At the top right is a 'Save' button. Below it, the 'SNMP Access allowed from' section has three radio buttons: 'Disabled' (selected), 'IP address(es)', and 'All'. Below these is a text input field containing '<IP Address1> <IP Address2> ...'. Further down are three text input fields labeled 'User Name *', 'Password *', and 'Re-enter Password *'.

4. In the Monitoring Settings page, enter the following information:
 - **SNMP Access allowed from:** Select **All** to enable a client at any IP address to poll Oracle Key Vault for information, **Disabled** to prevent any client, regardless of the client IP address, to poll Oracle Key Vault for information, or **IP Address(es)** if you want to restrict polling to clients with specific IP addresses. If you select **IP Address(es)**, then enter the IP addresses of the users you want to grant access to in

the IP Address field. Separate multiple IP addresses by a space. You cannot enter a range of IP addresses. You must list each IP address individually.

- **User Name:** Enter a name to associate with the SNMP configuration that will perform the monitoring.
- **Password and Re-enter Password:** Enter a secure password for this user that is at least 8 or more characters and contains at least one of each of the following: an uppercase letter, a lowercase letter, a number, and a special character from the set: period (.), comma (,), underscore (_), plus sign (+), colon (:), space. The SNMP password must **not** be the same as the password used to login into the Oracle Key Vault management console in any of the administrative roles.

5. Click **Save**.

19.1.1.3 Changing the SNMP User Name and Password

You can change the SNMP user name and password for a node at any time.

1. Log in to the Oracle Key Vault management console as a user who has the System Administrator role.
2. Select the **System** tab, and then select **Settings** from the left navigation bar.
3. In the Monitoring and Alerts area, click **SNMP**.
4. In the **User Name**, **Password**, and **Re-enter Password** fields, enter the user name and password information.
5. Click **Save**.

19.1.1.4 Changing SNMP Settings on the Standby Server

You change the SNMP settings from the command line on the standby server.

To add SNMP support in a primary-standby environment, you should configure SNMP on both the primary and standby servers before pairing them. This is because the standby server is no longer accessible from the Oracle Key Vault management console because all requests are forwarded to the primary server. However, you can change SNMP settings on the standby server in a primary-standby environment.

1. Log in to the standby server as the `support` user.
2. Switch to the root user.

```
su -
```

3. Go to the Oracle Key Vault bin directory.

```
cd /usr/local/okv/bin/
```

4. Run the `stbby_snmp_enable` script.

```
./stbby_snmp_enable parameter "options"
```

In this specification:

- *parameter* can be the following:
 - `-a`, which sets the SNMP access. It accepts the following *options*:
 - * all grants SNMP access.

- * `disabled` disables SNMP access.
- * `IP_addresses` specifies one or more IP addresses to be granted SNMP access. Separate each IP address with a space.
- `-u` sets the user's SNMP name.
- `-p` sets the user's SNMP password.
- `options` is only used with the `-a` parameter.

The following examples show how to change SNMP settings on a standby server:

To grant SNMP access to all IP addresses and assign a user name `snmpuser` and password `password`:

```
./stdby_snmp_enable -a "all" -u "snmpuser" -p "password"
```

To disable SNMP access from all IP addresses:

```
./stdby_snmp_enable -a "disabled"
```

To grant SNMP access to certain IP addresses and assign user name `snmpuser` and password `password`:

```
./stdby_snmp_enable -a "192.0.2.1 192.0.2.3 192.0.2.3" -u "snmpuser" -p "password"
```

19.1.1.5 Remotely Monitoring Oracle Key Vault Using SNMP

SNMP enables you to monitor the vital components of Oracle Key Vault remotely without having to install new software in Oracle Key Vault.

Though there are third-party tools that graphically display the information that SNMP extracts from Oracle Key Vault, the examples shown here are given with `snmpwalk` and `snmpget` from the command line on a remote computer that has a network connection into the SNMP account in Oracle Key Vault.

1. Log in to the remote host that will monitor Oracle Key Vault.
2. Confirm that the `UCD-SNMP-MIB` is installed on the remote host from which Oracle Key Vault is monitored.
3. Query the object ID for an Oracle Key Vault-supported SNMP Management Information Base (MIB) variable.

For example, suppose you wanted to track the number of processes running for the SNMP host. You can use a third-party SNMP client utility to query the status of the KMIP MIB whose object ID is `1.3.6.1.4.1.2021.2`, as follows:

```
third_party_snmp_client_command -v 3 OKV_IP_address -u SNMP_user -a SHA -A  
SNMP_password -x AES -X SNMP_password -l authPriv iso.3.6.1.4.1.2021.2.1.2
```

The output is similar to the following:

```
iso.3.6.1.4.1.2021.2.1.2.1 = STRING: "mwecsvc"           <== Event collector  
iso.3.6.1.4.1.2021.2.1.2.2 = STRING: "httpd"         <== httpd  
iso.3.6.1.4.1.2021.2.1.2.3 = STRING: "kmipd"         <== KMIP daemon  
iso.3.6.1.4.1.2021.2.1.2.4 = STRING: "ora_pmon_dbfwdb" <== embedded DB
```

```

iso.3.6.1.4.1.2021.2.1.2.5 = STRING: "ServiceManager"      <== Golden Gate
Service Manager (Monitors other processes and reports status)
iso.3.6.1.4.1.2021.2.1.2.6 = STRING: "adminsrvr"       <== Golden Gate
Admin Server (Communicates with the DB to perform certain maintenance/admin
tasks)
iso.3.6.1.4.1.2021.2.1.2.7 = STRING: "distsrvr"       <== Golden Gate
Distribution Server (Sends the OGG changes to other nodes)
iso.3.6.1.4.1.2021.2.1.2.8 = STRING: "recvsrvr"       <== Golden Gate
Receiver Server

```

Related Topics

- [SNMP Management Information Base Variables for Oracle Key Vault](#)
Oracle Key Vault provides a set of SNMP Management Information Base (MIB) variables that you can track.

19.1.1.6 SNMP Management Information Base Variables for Oracle Key Vault

Oracle Key Vault provides a set of SNMP Management Information Base (MIB) variables that you can track.

The following table lists the MIB variables that are supported.

Table 19-1 MIBs That SNMP Tracks for Oracle Key Vault

MIB Variable	Object ID	Description
hrSystemUptime	1.3.6.1.2.1.25.1.1	Tracks the amount of time that an Oracle Key Vault instance has been running
ifAdminStatus.x	1.3.6.1.2.1.2.2.1.7	Tracks if the Oracle Key Vault network interface (x) are running, not running, or being tested. Values are as follows: <ul style="list-style-type: none"> • 1: Instance is running • 2: Instance is down • 3: Instance is being tested
memAvailReal	1.3.6.1.4.1.2021.4.6	Tracks the available RAM
memTotalReal	1.3.6.1.4.1.2021.4.5	Tracks the total amount of RAM being used
ssCpuRawIdle	1.3.6.1.4.1.2021.11.53	For CPU monitoring; tracks the number of ticks (typically 1/100s) spent idle
ssCpuRawInterrupt	1.3.6.1.4.1.2021.11.56	For CPU monitoring; tracks the number of ticks (typically 1/100s) spent processing hardware interrupts
ssCpuRawKernel	1.3.6.1.4.1.2021.11.55	For CPU monitoring; tracks the number of ticks (typically 1/100s) spent processing kernel-level code
ssCpuRawNice	1.3.6.1.4.1.2021.11.51	For CPU monitoring; tracks the number of ticks (typically 1/100s) spent processing reduced-priority code

Table 19-1 (Cont.) MIBs That SNMP Tracks for Oracle Key Vault

MIB Variable	Object ID	Description
ssCpuRawSystem	1.3.6.1.4.1.2021.11.52	For CPU monitoring; tracks the number of ticks (typically 1/100s) spent processing system-level code
ssCpuRawUser	1.3.6.1.4.1.2021.11.50	For CPU monitoring; tracks the number of ticks (typically 1/100s) spent processing user-level code
ssCpuRawWait	1.3.6.1.4.1.2021.11.54	For CPU monitoring; tracks the number of ticks (typically 1/100s) spent waiting for input-output (IO)
UCD-SNMP-MIB.prTable	1.3.6.1.4.1.2021.2	Tracks the number of processes running under a certain name. Names we monitor are <code>httpd</code> (the http server), <code>kmipd</code> (the kmip daemon), and <code>ora_pmon_dbfwdb</code> (an indicator if the DB is down)
nsExtendOutputFull	1.3.6.1.4.1.8072.1.3.2.3.1.2	For monitoring Fast Recovery Area Space utilization; tracks the total limit, space used, and space free. The alert also shows the certificate expiration and the status of the Oracle Audit Vault agent. For the certificate expiration, the time zone that is shown for the date and time is in GMT. The output may be inconsistent if Oracle Key Vault is in the middle of a certification rotation.

**See Also:**

For more information refer to the Net-SNMP documentation at <http://www.net-snmp.org>

19.1.1.7 Example: Simplified Remote Monitoring of Oracle Key Vault Using SNMP

In Linux, you can simplify the SNMP commands you manually enter to find Oracle Key Vault information, yet still have useful and detailed output.

The configuration in this section assumes that you have granted SNMP access to a trusted user. It also assumes that you have installed the SNMP Management Information Base (MIB) variables on the remote host that will monitor Oracle Key Vault.

For example, a lengthy version of the `snmpwalk` command for an SNMP user named `snmp_admin` is as follows:

```
snmpwalk -v3 OKV_IP_address -n "" -l authPriv -u snmp_admin -a SHA -A  
snmp_user_password -x AES -X snmp_user_password
```

This command lists the vital services that are running on Oracle Key Vault. However, you can modify the command (and other SNMP commands) to be not only shorter, but to show additional information, such as whether the services are running or not running.

To simplify this type of command, you can edit the `/etc/snmp/snmp.conf` configuration file so that the SNMP commands you enter will automatically include commonly used settings, such as the default user or the default security level. The example in this topic omits password parameters so that users can enter the password at the command line interactively.

1. Log in to the remote host that will monitor Oracle Key Vault.
2. Edit the `/etc/snmp/snmp.conf`, which appears as follows:

```
# As the snmp packages come without MIB files due to license reasons,  
# loading MIBs is disabled by default. If you added the MIBs you  
# can reenale loading them by commenting out the following line.  
mibs :
```

3. Comment out the `# mibs :` line and then add the following lines, as follows:

```
# loading MIBs is disabled by default. If you added the MIBs you  
# can reenale loading them by commenting out the following line.  
# mibs :  
defSecurityName snmp_admin  
defSecurityLevel authPriv  
defAuthType SHA  
defPrivType AES
```

In this example:

- `defSecurityName`: Enter the name of the user to whom you granted SNMP access. This example uses `snmp_admin`.
 - `defSecurityLevel`: Enter the default security level to use. This example uses `authPriv`, which enables communication with authentication and privacy.
 - `defAuthType`: Enter the default authorization type. This example uses `SHA`.
 - `defPrivType`: Enter the default privilege type. This example uses `AES`.
4. Restart `snmpd` to load the configuration file.
For example, for Linux 7:

```
systemctl restart snmpd
```

For Linux 6:

```
service snmpd restart
```

5. To run the simplified version of the `snmpwalk` command that was shown earlier, enter the following command:

```
snmpwalk okv_ip_address prNames -A snmp_user_pwd -X snmp_user_pwd
```

In this command, `prNames` refers to "process names", which displays the names of processes instead of numbers. For example:

```
$ snmpwalk 192.0.2.254 prNames -A snmp_user_pwd -X snmp_user_pwd
UCD-SNMP-MIB::prNames.1 = STRING: mwecsvc
UCD-SNMP-MIB::prNames.2 = STRING: httpd
UCD-SNMP-MIB::prNames.3 = STRING: kmipd
UCD-SNMP-MIB::prNames.4 = STRING: ora_pmon_dbfwdb
UCD-SNMP-MIB::prNames.5 = STRING: ServiceManager
UCD-SNMP-MIB::prNames.6 = STRING: adminsvr
UCD-SNMP-MIB::prNames.7 = STRING: distsvr
UCD-SNMP-MIB::prNames.8 = STRING: recvsrvr
```

An example of running the `snmptable` command now becomes the following.

```
snmptable okv_ip_address prTable -A snmp_user_pwd -X snmp_user_pwd
```

Output similar to the following appears.

```
SNMP table: UCD-SNMP-MIB::prTable
prIndex      prNames prMin prMax prCount prErrorFlag prErrMessage prErrFix
prErrFixCmd
      1      mwecsvc    1    1      1      noError      noError
      2      httpd      1   20      9      noError      noError
      3      kmipd      1    2      2      noError      noError
      4 ora_pmon_dbfwdb  1    1      1      noError      noError
      5 ServiceManager  1    1      1      noError      noError
      6      adminsvr   1    1      1      noError      noError
      7      distsvr   1    1      1      noError      noError
      8      recvsrvr  1    1      1      noError      noError
```

The next example shows how you would now run the `snmpdf` command:

```
snmpdf okv_ip_address -A snmp_user_pwd -X snmp_user_pwd
```

Output similar to the following appears.

Description	Size (kB)	Used	Available	Used%
/	20027260	7247856	12779404	36%
/usr/local/dbfw/tmp	6932408	15764	6916644	0%
/var/log	5932616	19932	5912684	0%
/tmp	1999184	3072	1996112	0%
/var/lib/oracle	143592160	35023900	108568260	24%

19.1.2 Configuring Email Notification

You can use email notifications to directly notify administrators of Key Vault status changes without logging into the Oracle Key Vault management console.

- [About Email Notification](#)
Email notifications alert users of status changes and are used to complete the processes of endpoint enrollment and user password reset operations.
- [Configuring Email Settings](#)
You can configure the Simple Mail Transfer Protocol (SMTP) server properties to receive email notifications from Oracle Key Vault.

- [Testing the Email Configuration](#)
Oracle Key Vault management console enables you to send test emails to test the email configuration.
- [Disabling Email Notifications for a User](#)
You can use the Oracle Key Vault management console to enable or disable email notifications.

19.1.2.1 About Email Notification

Email notifications alert users of status changes and are used to complete the processes of endpoint enrollment and user password reset operations.

To enable email notification you must set your email preferences in Oracle Key Vault. You can choose the events that you want updates to. The events include Oracle Key Vault system status like disk utilization, backup, and primary-standby, or user and endpoint status like expiration of user passwords, endpoint certificates, and keys, or cluster status like the heartbeat lag, naming conflicts, cluster-wide HSM status, and others.

Oracle Key Vault supports anonymous and insecure connections to the SMTP server. By default, Oracle Key Vault uses the default Java `truststore` packaged with Oracle Key Vault's Java library to validate the server certificate. Optionally, you can upload a custom `truststore` in order to use a specific certificate or certificate chain at the same time you configure SMTP settings.

You can modify the SMTP server configuration at any time. If a custom SMTP certificate was used initially, and you later decide to use the default, you can modify the trust store setting to default, instead of custom.

For example:

- The enrollment token generated during endpoint enrollment can be mailed directly to the endpoint administrator from Oracle Key Vault.
- An Oracle Key Vault system administrator can send the random temporary password directly to the user when the user password is reset.

To enable email notifications successfully, there must be a connection between Oracle Key Vault and the SMTP server.

You can disable email notifications at any time.

19.1.2.2 Configuring Email Settings

You can configure the Simple Mail Transfer Protocol (SMTP) server properties to receive email notifications from Oracle Key Vault.

1. Log in to the Oracle Key Vault management console as a user with the System Administrator role.
2. Select the **System** tab, and then select **Settings** from the left navigation bar.
3. In the Network Services area, click **Email**.

The Email Settings page appears.

Email Settings



SMTP Server Address * ?

SMTP Port *

Name * ?

From Address *

Require Secure Connection

Require Credentials

Custom SMTP Server Certificate

Send Test Email

Email Address

4. In the Email Settings page, enter the following values:

- **SMTP Server Address:** Enter a valid SMTP server address or host name for the user account. This setting should match the SMTP server setting of the user's email account. Ensure that the SMTP server or hostname is reachable from Oracle Key Vault. If you enter the SMTP hostname, you must configure DNS from the **System Settings** menu, so the host name can be resolved.
- **SMTP Port:** Enter the SMTP port number of the outgoing SMTP server, usually 465. This port number can be another number, if expressly configured that way in your organization.
- **Name:** Enter an alias for the SMTP user that will appear in the From field of the email.
- **From Address:** Enter the email address that you want to provide as a sender.
- If the SMTP server requires a secure connection, select **Require Secure Connection**. If you are using anonymous relay on Microsoft Exchange Server, or an external SMTP server such as Gmail or Office 365, do not select **Require Secure Connection**. Ensure that your firewall rules allow forwarding of SMTP requests to an external SMTP server.

If **Require Secure Connection** is selected, the **Authentication Protocol** field is displayed with two options, **SSL** and **TLS**. Select the authentication protocol for the email server, either **SSL** or **TLS**. The default is **TLS**.

- If you have an SMTP user account, then check the box **Require Credentials**. When checked, the input fields **User Name**, **Password**, and **Re-enter Password** appear:
 - Enter the username of the SMTP user account.

- Enter the password for the SMTP user account.
- Reenter the password for the SMTP user account.

▲ Caution:

Oracle strongly recommends that you have a secure connection to the SMTP server, because auto-generated tokens are sent over email for operations such as the creation of administrative users and Oracle Key Vault system alerts.

Do not check **Require Credentials** for non-secure connections.

- If **Custom SMTP Server Certificate** is checked, then the field **Upload Certificate File** appears with the **Choose File** button to its right. Select this option if you want to upload a custom SMTP server's certificate to establish a TLS session between SMTP and Oracle Key Vault. This is how you can add a custom truststore in cases where the default Java truststore does not contain a necessary certificate. After Upload Certificate File, click **Browse** to upload a custom certificate file.
5. Click **Configure**.

On successful configuration, a `SMTP successfully configured` message is displayed.

If the configuration fails, then check that the SMTP server settings of the user email account are correct. Error messages highlight the field where the error has occurred to help isolate the problem.

19.1.2.3 Testing the Email Configuration

Oracle Key Vault management console enables you to send test emails to test the email configuration.

You can test the email configuration of the SMTP user account any time *after* you save the configuration. If you change an existing SMTP configuration, then you must save the configuration before you can test it.

1. Log in to the Oracle Key Vault management console as a user who has the System Administrator role.
2. Select the **System** tab, and then select **Settings** from the left navigation bar.
3. In the Network Services area, click **Email**.
4. In the Email Settings window, configure the user's SMTP settings.
5. Save the configuration by clicking **Configure**.

You must save the configuration before you can test it.

6. In the **Send Test Email** section, enter the user email address in the **Email Address** field. Then click **Test**.

An email is sent to the user with `Oracle Key Vault: Test Message` in the subject line.

Depending on the Oracle Key Vault server timestamp, the email notification may not show up as the latest email.

The email notification may also not show up in your inbox, in which case you must check the spam folder.

If the email notification is not received, click the **Reports** tab and select **System Reports** from the left sidebar. On the **System Reports** page, click **Notification Report**. Check the list to determine the issue encountered while sending the email notification.

Related Topics

- [Configuring Email Settings](#)
You can configure the Simple Mail Transfer Protocol (SMTP) server properties to receive email notifications from Oracle Key Vault.

19.1.2.4 Disabling Email Notifications for a User

You can use the Oracle Key Vault management console to enable or disable email notifications.

An Oracle Key Vault user may elect not to receive email alerts. Only a user with the System Administrator role, or a user managing his own account can disable email notifications.

1. Log in to the Oracle Key Vault management console as a user with the System Administrator role.
2. Select the **Users** tab.
The Manage Users page appears.
3. Click user name of the user.
The User Details page appears.
4. Check the box to the left of text **Do not receive email alerts**.
5. Click **Save**.

19.1.3 Configuring the Syslog Destination for Individual Multi-Master Cluster Nodes

On each node, you can forward syslog entries to a remote service such as Splunk or SIEM.

- [Setting the Syslog Destination Setting for the Node](#)
You can set the syslog destination to use either Transmission Control Protocol (TCP) or User Datagram Protocol (UDP).
- [Clearing the Syslog Destination Setting for the Node](#)
You can clear the syslog destination setting for the node and then reset the node to the cluster setting.

19.1.3.1 Setting the Syslog Destination Setting for the Node

You can set the syslog destination to use either Transmission Control Protocol (TCP) or User Datagram Protocol (UDP).

1. Log into the Oracle Key Vault management console for the node as a user who has the System Administrator role.
2. Select the **System** tab, and then **Settings** from the left navigation bar.
3. In the Monitoring and Alerts area, click **Syslog**.

4. In the **Syslog** window, select one of the following options:
 - **TCP**: Enables syslog using the TCP protocol.
 - **UDP**: Enables syslog using the UDP protocol.
5. Enter the syslog destination IP addresses and port numbers in the **Syslog Destinations** field, in the format *IP_address:port*.

You can enter multiple destinations, each separated by a space.
6. Click **Save**.

19.1.3.2 Clearing the Syslog Destination Setting for the Node

You can clear the syslog destination setting for the node and then reset the node to the cluster setting.

1. Log into the Oracle Key Vault management console for the node as a user who has the System Administrator role.
2. Select the **System** tab, and then **Settings** from the left navigation bar.
3. In the Monitoring and Alerts area, click **Syslog**.
4. In the Syslog window, click **Delete**.

19.1.4 Capturing System Diagnostics

To troubleshoot problems that may arise, you can generate a system diagnostics file.

- [About Capturing System Diagnostics](#)

The Oracle Key Vault diagnostics file provides advanced debug and troubleshooting information for problems that you may encounter while using Oracle Key Vault.
- [Installing the Diagnostics Generation Utility](#)

You can use the Oracle Key Vault management console to download instructions for installing and using the diagnostics generation utility.
- [Generating a System Diagnostics File](#)

The system diagnostics file that you download is in a `.zip` file.
- [Removing the Diagnostic Generation Utility Temporary Files](#)

Removing the diagnostic generation utility temporary files frees up space on your server.
- [Removing the Diagnostic Generation Utility](#)

If you no longer need to generate system diagnostic reports, then you can remove the diagnostic generation utility.

19.1.4.1 About Capturing System Diagnostics

The Oracle Key Vault diagnostics file provides advanced debug and troubleshooting information for problems that you may encounter while using Oracle Key Vault.

You can download this file and provide it to Oracle support for further analysis and debugging. The diagnostics file includes information about free space and disk usage reported is space available to Oracle Key Vault and not based on total disk size.

Diagnostics reporting is not enabled by default. You must enable the feature to generate diagnostics reports. After you have enabled diagnostics, you can configure the necessary information to be captured in diagnostics reports. You then can customize and package diagnostics reports with flexibility. Be aware that the first time you run the diagnostic utility or after the Oracle Key Vault system's internal database has been restarted, it can take longer that it will in future runs because it must gather all the diagnostic information in the system.

If you plan to perform an upgrade of Oracle Key Vault, then you must remove the diagnostic generation utility before performing the upgrade.

19.1.4.2 Installing the Diagnostics Generation Utility

You can use the Oracle Key Vault management console to download instructions for installing and using the diagnostics generation utility.

The instructions also explain how you can customize the output in the reports to accommodate different categories.

1. Log in to the Oracle Key Vault management console as a user who has the System Administrator role.
2. Select **System**.

The Status page appears.

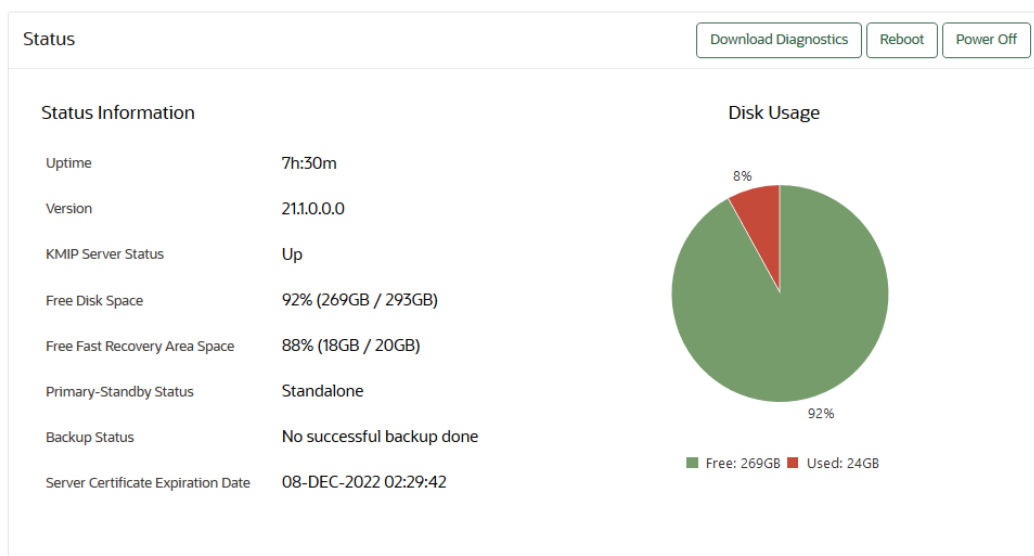

3. Click **Download Diagnostics**.

If the diagnostics generation utility is not installed, then you will be prompted to download the `diagnostics-not-enabled.readme` file.

4. Save the `diagnostics-not-enabled.readme` file to a local directory.
5. Follow the directions in this readme file to install and run the diagnostics generation utility, and to customize the report output.

The readme file includes the following instructions, but you should double-check this file in case these instructions have changed:

- a. Use SSH as to connect as user `support` , then switch user (`su`) to `root` .
- b. Install the diagnostics generation utility:

```
/usr/local/dbfw/bin/priv/dbfw-diagnostics-package.rb --install
```

- c. Enable the collection of diagnostics:

```
/usr/local/dbfw/bin/priv/dbfw-diagnostics-package.rb --enable ALL
```

19.1.4.3 Generating a System Diagnostics File

The system diagnostics file that you download is in a `.zip` file.

1. Log in to the Oracle Key Vault management console as a user who has the System Administrator role.
2. Select the **System** tab and then **Status** from the left navigation bar.
3. Click **Download Diagnostics**.

You should be prompted to download a `.zip` file, which will contain the diagnostics reports. If you are prompted to download the `diagnostics-not-enabled.readme` file, then the diagnostics generation utility has not been installed and you will need to install it.

4. Download the `.zip` file that contains the diagnostic reports to a secure location.

Related Topics

- [Installing the Diagnostics Generation Utility](#)
You can use the Oracle Key Vault management console to download instructions for installing and using the diagnostics generation utility.

19.1.4.4 Removing the Diagnostic Generation Utility Temporary Files

Removing the diagnostic generation utility temporary files frees up space on your server.

After you have run diagnostic reports, temporary files will accumulate. You should periodically remove these files. You can execute the command to remove these files from any directory.

1. Log in to the server where you downloaded and installed the diagnostic generation utility.
2. Use SSH as to connect as user `support` , then switch user (`su`) to `root` .
3. Execute the following command:

```
/usr/local/dbfw/bin/priv/dbfw-diagnostics-package.rb --clean
```

This command removes any `.zip` files that are found in the `/usr/local/dbfw/tmp` directory.

19.1.4.5 Removing the Diagnostic Generation Utility

If you no longer need to generate system diagnostic reports, then you can remove the diagnostic generation utility.

If you plan to upgrade Oracle Key Vault, then you must remove the diagnostic generation utility before you perform the upgrade. Removing this utility does not remove its temporary files.

1. Log in to the server where you downloaded and installed the diagnostic generation utility.

2. Use SSH as to connect as user `support` , then switch user (`su`) to `root` .
3. Execute the following command:

```
/usr/local/dbfw/bin/priv/dbfw-diagnostics-package.rb --remove
```

19.2 Configuring Oracle Key Vault Alerts

You can select the type of alerts that you want to see in the Oracle Key Vault dashboard.

- [About Configuring Alerts](#)
System administrators can configure alerts from the Oracle Key Vault dashboard, but all users can see alerts for the security objects to which they have access.
- [Configuring Alerts](#)
You can configure alerts in the Reports page of the Oracle Key Vault management console.
- [Viewing Open Alerts](#)
Users can view alerts depending on their privileges.

19.2.1 About Configuring Alerts

System administrators can configure alerts from the Oracle Key Vault dashboard, but all users can see alerts for the security objects to which they have access.

Email notifications must be enabled for users to receive alerts.

The Oracle Key Vault dashboard is the first page you see on logging into the management console. You can navigate to this page by clicking the **Home** tab. All users can see the alerts on security objects they have access to, but only users with the System Administrator role can configure alerts.

Oracle Key Vault offers several types of alerts that you can configure with appropriate thresholds according to your requirements. The alert types that appear are based on the type of environment that you are using: standalone, primary-standby, or multi-master cluster. You can also configure alerts for an HSM-enabled Oracle Key Vault server.

You can configure the following alerts, which are listed in ascending order:

Table 19-2 Available Alerts

Alert Type	Environment	Multi-master Cluster Applicability	Purpose of Alert	When Alert Is Deleted
Certificate Object Expiration	Standalone, primary-standby, and multi-master cluster environments	Cluster-wide	<p>Raised when a certificate object's deactivation date is within the threshold value (default 7 days).</p> <p>This alert is raised only if the certificate object is in the PRE-ACTIVE or ACTIVE state.</p> <p>When an expiration alert is within its threshold, an email notification is sent once every 24 hours until the certificate object expires.</p>	Deleted if the certificate object is no longer expiring within the threshold value as a result of changes to either object's deactivation date or the configured threshold value. This alert is also deleted when a certificate object is revoked or destroyed.
Cluster FIPS Not Consistent	Multi-master cluster only	Cluster-wide	Raised when at least one, but not all, ACTIVE nodes in the cluster are in FIPS mode	Deleted when all cluster nodes are in FIPS mode or all nodes are not in FIPS mode
Cluster Heartbeat Lag	Multi-master cluster only	Node specific	Raised when a node has not received a heartbeat from another ACTIVE node in the cluster for over the threshold value (default 5 minutes)	Deleted when a node has once again received a heartbeat from the other node in the configured threshold period, as long as the node had received a heartbeat from the other node within the last Maximum Disable Node Duration period of time. This alert is also deleted when a node involved has been deleted from the cluster.

Table 19-2 (Cont.) Available Alerts

Alert Type	Environment	Multi-master Cluster Applicability	Purpose of Alert	When Alert Is Deleted
Cluster HSM Not Consistent	Multi-master cluster only	Cluster-wide	Raised when at least one, but not all, ACTIVE nodes in the cluster are HSM-enabled	Deleted when all nodes are HSM-enabled or all nodes are not HSM-enabled
Cluster Naming Conflict	Multi-master cluster only	Cluster-wide	Raised when a naming conflict has been automatically resolved by Oracle Key Vault	Deleted when the object is deleted or renamed, or has had the new name explicitly accepted
Cluster Redo Shipping Status	Multi-master cluster only	Node specific	Raised when a read-write node is unable to ship redo to its read-write peer, and as a result, is in read-only restricted mode. In addition to redo-shipping inactive status information, the alert indicates that the node in the cluster is operating in read-only mode.	Deleted when a read-write node is once again able to ship redo to its read-write peer, or when the node is deleted. The email notification states that the redo-shipping status is back up and the node in the cluster is no longer operating in read-only mode.
Cluster Replication Lag	Multi-master cluster only	Node specific	Raised when incoming replication lag is greater than the threshold value (default 60 seconds)	Deleted when replication lag falls below the threshold value, or when any node in the replication link is deleted
Disk Utilization	Standalone, primary-standby, and multi-master cluster environments	Node specific	Raised when the free disk space percentage of the <code>/var/lib/oracle</code> partition is lower than the threshold value (default 25 percent)	Deleted when free disk space is once again higher than the threshold

Table 19-2 (Cont.) Available Alerts

Alert Type	Environment	Multi-master Cluster Applicability	Purpose of Alert	When Alert Is Deleted
Endpoint Certificate Expiration	Standalone, primary-standby, and multi-master cluster environments	Cluster-wide	<p>Raised when an endpoint's certificate is expiring within the threshold value (default 30 days).</p> <p>When an expiration alert is within its threshold, an email notification is sent once every 24 hours until the endpoint's certificate expires.</p>	Deleted when the endpoint's certificate is no longer expiring within the threshold value or when the endpoint is deleted
Failed System Backup	Standalone, primary-standby, and multi-master cluster environments	Node specific	Raised when the last backup did not complete successfully	Deleted when the most recent backup completed successfully
Fast Recovery Area Space Utilization	Standalone, primary-standby, and multi-master cluster environments	Node specific	<p>Raised when Fast Recovery Area Space utilization of Oracle Key Vault's embedded database exceeds the configured threshold value (default 70 percent).</p> <p>To remedy this problem, try the following:</p> <ul style="list-style-type: none"> • Reduce the Maximum Disable Node Duration setting of the cluster node. • Minimize the duration when peer node is not available. Consider deleting the node from the cluster and adding it back later. 	Deleted when Fast Recovery Area Space utilization of Oracle Key Vault's embedded database is once again within the configured threshold
Invalid HSM Configuration	Standalone, primary-standby, and multi-master cluster environments	Node specific	Raised when there is an error in the HSM configuration (checked by default every 5 minutes)	Deleted when there is no longer an error in the HSM configuration

Table 19-2 (Cont.) Available Alerts

Alert Type	Environment	Multi-master Cluster Applicability	Purpose of Alert	When Alert Is Deleted
Key Rotations	Standalone, primary-standby, and multi-master cluster environments	Cluster-wide	<p>Raised when a key's deactivation date is within the threshold value (default 7 days)</p> <p>This alert is raised only if the key object is in the PRE-ACTIVE or ACTIVE state.</p> <p>When an expiration alert is within its threshold, an email notification is sent once every 24 hours until the certificate object expires.</p>	Deleted if the key object is no longer expiring within the threshold value as a result of changes to either object's deactivation date or the configured threshold value. This alert is also deleted when a key object is revoked or destroyed.
OKV Server Certificate Expiration	Standalone, primary-standby, and multi-master cluster environments	Node specific	<p>Raised when the Oracle Key Vault server certificate is expiring within the threshold value (default 90 days).</p> <p>When an expiration alert is within its threshold, an email notification is sent once every 24 hours until the certificate expires.</p> <p>Be aware that if the server certificate expires, then endpoints will no longer be able to communicate with the Oracle Key Vault server. This will result in downtime.</p>	Deleted when the server certificate is no longer expiring within the threshold value
Primary-Standby Data Guard Broker Status	Primary-standby only	-	Raised when the Oracle Data Guard Broker status is not ENABLED	Deleted when the broker status is once again ENABLED or when Oracle Key Vault is no longer in primary-standby mode

Table 19-2 (Cont.) Available Alerts

Alert Type	Environment	Multi-master Cluster Applicability	Purpose of Alert	When Alert Is Deleted
Primary- Standby Data Guard Fast- Start Failover Status	Primary- standby only	-	Raised when the fast- start failover status is not SYNCHRONIZED	Deleted when the fast-start failover status is once again SYNCHRONIZED or when Oracle Key Vault is no longer in a primary- standby configuration
Primary- Standby Destination Failure	Primary- standby only	-	Raised when the switchover status is FAILED DESTINATION	Deleted when the switchover status is no longer FAILED DESTINATION or when Oracle Key Vault is no longer in a primary- standby configuration
Primary- Standby Restricted Mode	Primary- standby only	-	Raised when in primary- standby environment and the primary is running in read-only restricted mode	Deleted when the primary is no longer in read-only restricted mode or when Oracle Key Vault is no longer in a primary- standby configuration
Primary- Standby Role Change	Primary- standby only	-	Raised when there is a role change	Deleted when Oracle Key Vault is no longer in a primary- standby configuration

Table 19-2 (Cont.) Available Alerts

Alert Type	Environment	Multi-master Cluster Applicability	Purpose of Alert	When Alert Is Deleted
Secret Object Expiration	Standalone, primary-standby, and multi-master cluster environments	Cluster-wide	Raised when a secret object's deactivation date is within the threshold value (default 7 days). This alert is raised only if the object is in the PRE-ACTIVE or ACTIVE state. When an expiration alert is within its threshold, an email notification is sent once every 24 hours until the secret object expires.	Deleted if the secret object is no longer expiring within the threshold value as a result of changes to either object's deactivation date or the configured threshold value. This alert is also deleted when a secret object is revoked or destroyed.
SSH Tunnel Failure	Standalone, primary-standby, and multi-master cluster environments	Node specific	Raised when an SSH tunnel is not available	Deleted when the SSH tunnel is once again available or when the SSH tunnel is deleted
System Backup	Standalone, primary-standby, and multi-master cluster environments	Node specific	Raised when the last successful backup is over the threshold value (default 14 days)	Deleted when the last successful backup was within the threshold value
User Password Expiration	Standalone, primary-standby, and multi-master cluster environments	Cluster-wide	Raised when a user's password will expire within the threshold value (default 14 days). When an expiration alert is within its threshold, an email notification is sent once every 24 hours until the password expires.	Deleted when a user's password will no longer expire within the threshold value, or when the user is deleted

Related Topics

- [Configuring the Maximum Disable Node Duration for the Cluster](#)
You can set the maximum disable node duration time for the cluster in hours.
- [Managing Certificates](#)
In addition to Oracle Key Vault-generated certificates, you can manage third-party certificates.
- [Oracle Key Vault Root of Trust HSM Configuration Guide](#)

19.2.2 Configuring Alerts

You can configure alerts in the Reports page of the Oracle Key Vault management console.

1. Log in to the Oracle Key Vault management console as a user who has the System Administrator role.
2. Access the Alerts page by using one of the following methods:
 - Select the **System** tab, then **Settings**, and in the Monitoring and Alerts area, click **Alerts**.
 - Select the **Reports** tab, and then select **Alert** from the left navigation bar. In the Alerts page, click **Configure**.
 - On the Home page, expand **Alerts** at the top of the page, and then click **All Alerts**. Then click **Configure**.

The Configure Alerts page appears, listing various alert types and for some, configurable threshold limit and unit (such as the days until expiration for key rotations alert type). If you are using a multi-master cluster, then the Configure Alerts page will provide cluster-specific alerts, such as the cluster heartbeat lag, redo shipping status, or whether naming conflicts resolution is enabled. The following image shows how the Configure Alerts page appears in a multi-master cluster environment.

Configure Alerts
Save

Alert Type	Enabled	Limit	
Key Rotations	<input checked="" type="checkbox"/>	7	Days until expiration
Endpoint Certificate Expiration	<input checked="" type="checkbox"/>	60	Days until expiration
User Password Expiration	<input checked="" type="checkbox"/>	14	Days until expiration
Disk Utilization	<input checked="" type="checkbox"/>	25	Percent free space
System Backup	<input checked="" type="checkbox"/>	14	Days since last successful backup
Failed System Backup	<input checked="" type="checkbox"/>		-
Primary-Standby Role Change	<input checked="" type="checkbox"/>		-
Primary-Standby Destination Failure	<input checked="" type="checkbox"/>		-
SSH Tunnel Failure	<input checked="" type="checkbox"/>		-
Primary-Standby Restricted Mode	<input checked="" type="checkbox"/>		-
Primary-Standby Data Guard Fast-Start Failover Status	<input checked="" type="checkbox"/>		-
Primary-Standby Data Guard Broker Status	<input checked="" type="checkbox"/>		-
OKV Server Certificate Expiration	<input checked="" type="checkbox"/>	90	Days until expiration
Invalid HSM Configuration	<input checked="" type="checkbox"/>	5	Minutes between HSM configuration verifications
Certificate Object Expiration	<input checked="" type="checkbox"/>	7	Days until expiration
Secret Object Expiration	<input checked="" type="checkbox"/>	7	Days until expiration
Fast Recovery Area Space Utilization	<input checked="" type="checkbox"/>	70	Percent space used

Copyright (c) 2014, 2021 Oracle and/or its affiliates.

21.3.0.0.0

[Set Screen Reader Mode On](#)

3. Check the boxes in the **Enabled** column to the right of the alert types to enable the alert. Then set the threshold value in the box under **Limit**. This value determines when the alert will be sent. You can uncheck the boxes by alerts that you do not want to appear in the dashboard.
4. Click **Save**.

Related Topics

- [Viewing the Oracle Key Vault Dashboard](#)
The dashboard presents the current state of the Oracle Key Vault at a high level and is visible to all users.

19.2.3 Viewing Open Alerts

Users can view alerts depending on their privileges.

Users with the System Administrator role can view all alerts. Users without system administrator privileges can only view alerts related to objects they can access.

1. Log in to the Oracle Key Vault management console as a user who has the System Administrator role.
2. Access the Alerts page by using one of the following methods:
 - Select the **System** tab, then **Settings**, and in the Monitoring and Alerts area, click **Alerts**.
 - Select the **Reports** tab, and then select **Alerts** from the left navigation bar.
 - On the Home page, expand **Alerts** at the top of the page, and then click **All Alerts**.

The Home page is also a convenient way to go immediately to how to solve a problem that an alert raises. Under **Alerts**, click **Show Details**, and then in the listing of alert types, click the appropriate link. For example, alerts describing upcoming key expirations will take you to the Alerts configuration page, where only alerts for key rotations are displayed. From there, you can examine the details of keys that are expiring.

The Alerts page appears displaying all the alerts that have not been resolved. To resolve an issue, click the link under the Object column. In the following example, the first alert type, System Backup, has the object **Node 1**. Clicking this link displays the System Backup page, where you can configure the needed backup.

When you resolve the issue stated in the alert message, the alerts are automatically removed. To delete an alert message, select it and then click **Delete**. If the issue that caused the alert still exists, then the alert will be regenerated and appear again in this list.

<input type="checkbox"/>	Alert Type	Object	Time	Message
<input type="checkbox"/>	SSH Tunnel Failure	192.168.0.15:5697	13-JUL-2021 10:42:15	SSH tunnel (IP 192.168.0.15) is not available on Node FirstNode
<input type="checkbox"/>	System Backup	Node SecondNode	13-JUL-2021 10:42:15	No successful backup done on Node SecondNode
<input type="checkbox"/>	System Backup	Node FirstNode	13-JUL-2021 10:42:15	No successful backup done on Node FirstNode
<input type="checkbox"/>	User Password Expiration	OKVADMIN	13-JUL-2021 10:42:15	User OKVADMIN password expiration: 16-JUL-21

Oracle Key Vault sends all system alerts to the syslog. The following is an example of a system alert in syslog:

```
Mar 29 18:36:29 okv080027361e7e logger[13171]: No successful backup done for 4 day(s)
```

The following table lists the conditions that trigger alerts, and the accompanying system alert message:

Condition	System Alert Message
Certificate Object Expiration	Certificate object <i>unique_ID</i> expiration: <i>date</i>
Cluster FIPS Not Consistent	At least one, but not all, active OKV nodes are in FIPS Mode.
Cluster Heartbeat Lag	Replication lag from node <i>node_name</i> to node <i>current_node_name</i> exceeds <i>threshold_value</i> seconds
Cluster HSM Not Consistent	At least one, but not all, active OKV nodes are HSM-enabled.
Cluster Naming Conflict	Naming conflict for <i>object_type</i> : <i>object_name</i> The label <i>object_type</i> can be endpoint, endpoint group, user, or user group, with <i>object_name</i> being the corresponding object.
Cluster Redo Shipping Status	<p>Any of the following messages:</p> <ul style="list-style-type: none"> • No heartbeats received from node <i>source_node</i> to node <i>current_node</i>. • Last heartbeat from node <i>source_node</i> to node <i>current_node</i> was more than <i>threshold</i> minutes ago. • Last heartbeat from node <i>source_node</i> to node <i>current_node</i> was more than one hour ago. • Last heartbeat from node <i>source_node</i> to node <i>current_node</i> was more than six hours ago. • Last heartbeat from node <i>source_node</i> to node <i>current_node</i> was more than <i>Maximum_Disable_Node_Duration</i> hours (50% of the Maximum Disable Node Duration) ago. Take immediate action to restore communication from node <i>source_node</i> to avoid issues in the cluster. • Last heartbeat from node <i>source_node</i> to node <i>current_node</i> was more than <i>Maximum_Disable_Node_Duration</i> hours (75% of the Maximum Disable Node Duration) ago. Take immediate action to restore communication from node <i>source_node</i> to avoid issues in the cluster. • Last heartbeat from node <i>source_node</i> to node <i>current_node</i> was more than <i>Maximum_Disable_Node_Duration</i> hours (Maximum Disable Node Duration) ago. Node <i>current_node</i> may not have received all records from node <i>source_node</i> even if replication is restored.

Condition	System Alert Message
Cluster Replication Lag	Replication lag from node <i>node_name</i> to node <i>node_name</i> is greater than <i>threshold</i> seconds. Current lag is <i>current</i> seconds.
Disk utilization	Free disk space is below <i>threshold_value</i> (currently <i>current_value</i>)
Endpoint certificate expiration	Endpoint <i>endpoint_name</i> certificate expiration <i>date</i>
Failed system backup	Most recent backup failed!
Fast Recovery Area Space Utilization	Fast Recovery Area space usage exceeds <i>threshold_value%</i> (currently <i>current_value%</i>)
Invalid HSM Configuration	HSM configuration error. Please refer to the HSM Alert section in the Oracle Key Vault HSM Integration Guide
Key rotations	Key <i>unique_ID</i> expiration: <i>date</i>
Primary-standby destination failure	One or more standby servers are in an error state. HA destination failure.
Primary-standby Oracle Data Guard Broker status	Data Guard Broker is disabled
Primary-standby Oracle Data Guard fast-start failover status	HA FSFO is not synchronized. FSFO status is <i>HA_status</i>
Primary-standby restricted mode	HA running in read-only restricted mode
Primary-standby role change	HA role changed. Primary IP Address: <i>IP_address</i>
Secret Object Expiration	Secret object <i>unique_ID</i> expiration : <i>date</i>
SSH tunnel failure	SSH tunnel (IP <i>IP_address</i>) is not available
System backup	No successful backup for <i>number</i> day(s)
User password expiration	User <i>user_name</i> password expiration: <i>date</i>

19.3 Managing System Auditing

Auditing entails tasks such as capturing audit records in a syslog file or downloading the audit records to a local file.

- [About Auditing in Oracle Key Vault](#)
Oracle Key Vault records and time-stamps all endpoint and user activity.
- [Oracle Key Vault Audit Trail](#)
The Oracle Key Vault audit trail captures information about activities that are performed in Oracle Key Vault, such as the name of an action and who performed it.

- [Enabling Auditing and Configuring Syslog to Store Audit Records](#)
You can enable or disable auditing and then configure the Oracle Key Vault syslog to store audit records if the System Administrator has enabled this functionality.
- [Viewing Audit Records](#)
To view audit records, access the Oracle Key Vault management console Audit Trail page.
- [Exporting and Deleting Audit Records](#)
Oracle Key Vault audit records are stored in a `.csv` file.
- [Configuring Oracle Key Vault with Oracle Audit Vault](#)
A user who has the Audit Manager role can configure Oracle Key Vault to send audit records to Oracle Audit Vault for centralized audit reporting and alerting.

19.3.1 About Auditing in Oracle Key Vault

Oracle Key Vault records and time-stamps all endpoint and user activity.

The audit records include endpoint groups and user groups, from endpoint enrollment and user password reset, to the management of keys and wallets, and changes to system settings and SNMP credentials. The audit trail captures details on who initiated which action, with what keys and tokens, and the result of the action. In addition, it records the success or failure of each action.

Only a user who has the Audit Manager role can manage the audit trail for Oracle Key Vault activity. Each user can see audit records of the objects that the user can access.

Auditing in Oracle Key Vault is enabled by default.

A user with the Audit Manager role can see and manage all the audit records. Other users can see only those audit records that pertain to security objects that they have created, or have been granted access to.

The audit manager can export audit records to view system activity off line. After exporting the records, the audit manager can delete them from the system to free up resources.

Related Topics

- [Audit Manager Role Duties](#)
The Oracle Key Vault Audit Manager is responsible for audit-related tasks.

19.3.2 Oracle Key Vault Audit Trail

The Oracle Key Vault audit trail captures information about activities that are performed in Oracle Key Vault, such as the name of an action and who performed it.

The following lists the contents of the Oracle Key Vault audit trail.

Table 19-3 Oracle Key Vault Audit Trail

Column Name	Description
Subject	Captures the name of entity that performed the operation
Subject Type	Type of entity, User or Endpoint
Operation	Name of the operation performed

Table 19-3 (Cont.) Oracle Key Vault Audit Trail

Column Name	Description
Object	Captures the name of object on which the operation is performed
Object Type	Type of object on which the operation is performed (for example, User, Endpoint)
Time	Timestamp of the operation
Result	Result of the operation indicating whether it was successful or failure
Node ID	ID of the Oracle Key Vault cluster node on which the operation was performed
Node Name	Name of the Oracle Key Vault cluster node on which the operation was performed
Node IP Address	IP address of the Oracle Key Vault cluster node on which the operation was performed

19.3.3 Enabling Auditing and Configuring Syslog to Store Audit Records

You can enable or disable auditing and then configure the Oracle Key Vault syslog to store audit records if the System Administrator has enabled this functionality.

1. Log in to the Oracle Key Vault management console as a user who has the Audit Manager role.
2. Access the Audit Settings page by using one of the following methods:
 - Select the **Systems** tab, then **Settings** in the left navigation bar. In the Monitoring and Alerts area, click **Audit**.
 - Select the **Reports** tab, then **Audit Trail** in the left navigation bar. In the Audit Trail page, click **Audit Settings**.

The Audit Settings page appears. The categories that you can configure are as follows:

- Enable Auditing
 - Replicate Audit Records
 - Send Audit Records to Syslog
3. For each category, do the following:
 - a. In a multi-master cluster environment, click the right-hand arrow that appears over the **Save** button to toggle between the current node and the entire cluster.
 - b. Select either the **Yes** or **No** option for the auditing.
 - c. Click **Save**.
 4. If syslog is configured, then perform additional steps as needed.

If syslog is not configured, then the Syslog forwarding to remote machines not enabled error message appears. If this error appears, then enable syslog.

- a. Select the **System** tab, and then select **Settings**.
- b. In the Monitoring and Alerts area, select **Syslog**.
- c. In a multi-master cluster environment, toggle between Node Details - Effective on this Node and Cluster Details by clicking the arrow under the **Save** button.
- d. Select the protocol to use to transfer syslog files: **TCP** or **UDP**.
- e. Enter the IP address of the remote system where the syslog files will be stored.
- f. Click **Save**.

19.3.4 Viewing Audit Records

To view audit records, access the Oracle Key Vault management console Audit Trail page.

The reports page shows the Audit Trail page by default. The Audit Trail page lists all system activity with details on who performed an operation, when the operation was performed, what object was used to perform the operation, and the result.

1. Log in to the Oracle Key Vault management console as a user who has the Audit Manager role.
2. Click the **Reports** tab, and then **Audit Trail** from the left navigation bar.

The Audit Trail page appears. Optionally, filter records by selecting the table column heads, and from the drop-down list, select the type of sort order that you want.

19.3.5 Exporting and Deleting Audit Records

Oracle Key Vault audit records are stored in a `.csv` file.

A user with the Audit Manager role can export the audit trail to a `.csv` file that can be downloaded to the user's local system. The `.csv` file contains the same details found in the audit trail on the Reports page. The timestamp in the `.csv` file reflects the time zone of the particular Oracle Key Vault server whose records were exported. After you export the records, you can delete them from the Oracle Key Vault server to free up space.

1. Log in to the Oracle Key Vault management console as a user who has the Audit Manager role.
2. Click the **Reports** tab, then **Audit Trail** in the left navigation bar.

The Audit Trail appears.

3. Click **Export/Delete Audit Records** on the top right.

The **Export/Delete Audit Records** page appears.

Export/Delete Audit Records

Done Export Delete

Select records up to: 08-DEC-2020

Number of records to be exported/deleted: 57 out of 57 records

4. Select the date by clicking the calendar icon.

Based on the date that you select, the number of records appears after the **Number of records to be exported/deleted** label.

5. Click **Export** to download the audit records in `.csv` file format to a local folder.
After you export the records, you can delete them from Oracle Key Vault to free up resources.
6. Click **Delete** to remove the audit records.
7. Click **OK** to delete or **Cancel** to stop.

19.3.6 Configuring Oracle Key Vault with Oracle Audit Vault

A user who has the Audit Manager role can configure Oracle Key Vault to send audit records to Oracle Audit Vault for centralized audit reporting and alerting.

- [Integrating Oracle Audit Vault with Oracle Key Vault](#)
You can perform this integration from the Oracle Key Vault management console.
- [Viewing Oracle Key Vault Audit Data Collected by Oracle Audit Vault](#)
You can use the Oracle Audit Vault Server console to view data that is collected by Oracle Key Vault and Oracle Audit Vault.
- [Suspending an Oracle Audit Vault Monitoring Operation](#)
You can suspend an Oracle Audit Vault monitoring operation from the Oracle Key Vault management console.
- [Resuming an Oracle Audit Vault Monitoring Operation](#)
You can resume a suspended Oracle Audit Vault monitoring operation from the Oracle Key Vault management console.
- [Deleting an Oracle Audit Vault Integration](#)
You can delete an Oracle Audit Vault integration by using the Oracle Key Vault management console.
- [Guidance for Integrating Oracle Audit Vault in a Multi-Master Cluster or Primary-Standby Environment](#)
You must follow special guidelines to integrate Oracle Audit Vault with Oracle Key Vault in a multi-master cluster or primary-standby environment.

19.3.6.1 Integrating Oracle Audit Vault with Oracle Key Vault

You can perform this integration from the Oracle Key Vault management console.

- [Step 1: Check the Environment](#)
Before you begin the integration, you should ensure that the required components are all in place.
- [Step 2: Configure Oracle Key Vault as a Registered Host and a Secured Target with Oracle Audit Vault](#)
A user who has the Audit Manager role must configure the Oracle Key Vault server as a secured target on the Oracle Audit Vault server.

19.3.6.1.1 Step 1: Check the Environment

Before you begin the integration, you should ensure that the required components are all in place.

1. Ensure that Oracle Audit Vault is properly installed and configured.
This activity requires administrative access to the Oracle Audit Vault server in order to register Oracle Key Vault as a secured target.

2. Ensure that you have the credentials of the Oracle Audit Vault administrator in order to register Oracle Key Vault as a secured target in Oracle Audit Vault server. This user does not need to be a super administrator.
3. Enable SSH access to Oracle Audit Vault.

Log in to the Oracle Audit Vault Server console as a user who has the Super Administrator role. Select the **Settings** tab, then **System**. In the Configuration area, click **System Settings** and then **Web/SSH/SNMP**. Turn on **SSH Access**, select **IP addresses** and then enter only the IP addresses that you need, or select **All**. Click **Save**.

19.3.6.1.2 Step 2: Configure Oracle Key Vault as a Registered Host and a Secured Target with Oracle Audit Vault

A user who has the Audit Manager role must configure the Oracle Key Vault server as a secured target on the Oracle Audit Vault server.

In a multi-master cluster environment, perform these steps on each node. Each node will send the audit records that were generated from that node to the Oracle Audit Vault server.

1. Log in to the Oracle Key Vault management console as a user who has the Audit Manager role.
2. Select the **System** tab, and then **Audit Vault Integration** from the left navigation bar.

If you also have the System Administrator role, then the navigation will be slightly different. Click **System**, then in the left navigation pane, select **Settings**. In the Monitoring and Alerts area, click **Audit Vault**.

3. In the Deployment pane, enter the following settings:
 - **Hostname:** Enter the host name or IP address of the Oracle Audit Vault server.
 - **Public Host Key:** Enter the public host key of the Oracle Audit Vault server by following the guidelines mentioned in the help text.
 - **Support User Password:** Enter the support user password of the Oracle Audit Vault server.
 - **Administrator Name:** Enter the user name of the Oracle Audit Vault server user who has the Administrator role.
 - **Administrator Password:** Enter the password of the Oracle Audit Vault server user who has the Administrator role.
 - **Recovery Passphrase:** Enter the recovery passphrase of the Oracle Key Vault server.

The screenshot shows the 'Deployment' configuration page in the Oracle Audit Vault Server console. It is divided into two main sections: 'Audit Vault Details' and 'Key Vault Details'.
Audit Vault Details:
 - Hostname: 192.0.2.74
 - Public Host Key: ssh_host_ed25519_key.pub (with a 'Clear' button)
 - Support User Password: [Redacted]
 - Administrator Name: ADMINUSER2
 - Administrator Password: [Redacted]
Key Vault Details:
 - Recovery Passphrase: [Redacted]
 - A green 'Deploy' button is located at the bottom right of the 'Key Vault Details' section.

4. Click **Deploy**.

The integration may take about 10 minutes to complete. Do not attempt to re-initiate the Audit Vault integration during this interval. The Oracle Key Vault server may become unavailable for some time until the integration completes.

After the integration completes, a **Monitoring** tab appears and will show the Audit Vault agent status.

19.3.6.2 Viewing Oracle Key Vault Audit Data Collected by Oracle Audit Vault

You can use the Oracle Audit Vault Server console to view data that is collected by Oracle Key Vault and Oracle Audit Vault.

1. Log in to the Oracle Audit Vault Server console as an auditor.
2. Select the **Reports** tab.
3. Select **Activity Reports**.
4. Select **All Activity**.
5. Filter the target to get all records belonging to `okv_db_Oracle_Key_Vault_IP_address`.

Assuming that you filtered for the target `okv_db_192.0.2.78`, the report could be similar to the following:

	Target	User	Client Host	Client Program	Event	Object	Event Status	Event Time ⌵
	okv db 192.0.2.78	CLIENT1			GET ATTRIBUTES	1FC88514-A83C-4F87-BF61-82B0A4BC2246	SUCCESS	9/30/2021 7:17:37 AM
	okv db 192.0.2.78	CLIENT1			GET ATTRIBUTE LIST	1FC88514-A83C-4F87-BF61-82B0A4BC2246	SUCCESS	9/30/2021 7:17:37 AM
	okv db 192.0.2.78	CLIENT1			GET ATTRIBUTE LIST	1FC88514-A83C-4F87-BF61-82B0A4BC2246	SUCCESS	9/30/2021 7:17:37 AM

19.3.6.3 Suspending an Oracle Audit Vault Monitoring Operation

You can suspend an Oracle Audit Vault monitoring operation from the Oracle Key Vault management console.

1. Log in to the Oracle Key Vault management console as a user who has the Audit Manager role.
2. Select the **System** tab, and then **Audit Vault Integration** in the left navigation bar.
If you also have the System Administrator role, then the navigation will be slightly different. Click **System**, then in the left navigation pane, select **Settings**. In the Monitoring and Alerts area, click **Audit Vault**.
3. Select the **Monitoring** tab.
4. In the Audit Vault pane, click **Suspend**.

19.3.6.4 Resuming an Oracle Audit Vault Monitoring Operation

You can resume a suspended Oracle Audit Vault monitoring operation from the Oracle Key Vault management console.

1. Log in to the Oracle Key Vault management console as a user who has the Audit Manager role.
2. Select the **System** tab, and then **Audit Vault Integration** in the left navigation bar.
If you also have the System Administrator role, then the navigation will be slightly different. Click **System**, then in the left navigation pane, select **Settings**. In the Monitoring and Alerts area, click **Audit Vault**.
3. Select the **Monitoring** tab.
4. In the Audit Vault pane, click **Resume**.

19.3.6.5 Deleting an Oracle Audit Vault Integration

You can delete an Oracle Audit Vault integration by using the Oracle Key Vault management console.

1. Log in to the Oracle Key Vault management console as a user who has the Audit Manager role.
2. Select the **System** tab, and then **Audit Vault Integration** in the left navigation bar.
If you also have the System Administrator role, then the navigation will be slightly different. Click **System**, then in the left navigation pane, select **Settings**. In the Monitoring and Alerts area, click **Audit Vault**.
3. Under Deployment, in the Audit Vault Details page, enter the following settings:
 - **Public Host Key:** Enter the public host key of the Oracle Audit Vault server by following the guidelines mentioned in the help text.
 - **Support User Password:** Enter the support user password of the Oracle Audit Vault server.
 - **Administrator Name:** Enter the user name of the Oracle Audit Vault server user who has the Administrator role.

- **Administrator Password:** Enter the password of the Oracle Audit Vault server user who has the Administrator role.

Deployment
Delete

Audit Vault Details

Hostname *

Public Host Key * 🔍 🗑️ Clear

ssh-ed25519
 AAAAC3NzaC1lZDI1NTE5AAAAIKzLyLFUz5f5Z
 RX2xqjdmTxPzrxIKi79Z3ITc5beDDcY

Support User Password *

Administrator Name * 📄

Administrator Password *

4. In the Deployment pane, click **Delete**.
5. Click **OK** to confirm.

Audit records that are already collected in Oracle Audit Vault are not affected when Oracle Key Vault integration with Oracle Audit Vault is deleted.

6. Because you no longer need to copy files from one server to another, disable SSH access to Oracle Audit Vault.

Log in to the Oracle Audit Vault Server console as a user who has the Super Administrator role. Select the **Settings** tab, then **System**. In the Configuration area, click **System Settings** and then **Web/SSH/SNMP**. Turn off **SSH Access**. Click **Save**.

19.3.6.6 Guidance for Integrating Oracle Audit Vault in a Multi-Master Cluster or Primary-Standby Environment

You must follow special guidelines to integrate Oracle Audit Vault with Oracle Key Vault in a multi-master cluster or primary-standby environment.

Multi-Master Cluster Environments

- If Oracle Key Vault is configured to use multi-master clusters, then you must perform the Oracle Audit Vault integration individually on each node. Each node will send audit records that are generated only on that node to Oracle Audit Vault irrespective of whether audit record replication is enabled.

Primary-Standby Environments

- Perform the integration only on the primary server, not the standby server.
- If you must perform a switchover operation, then note the following:
 - You must switch back to the primary server if you want to suspend, resume, or delete the integration. You do not need to perform additional steps.
 - To integrate the new primary server with Oracle Audit Vault, optionally, ensure that you use the same Oracle Audit Vault host name and administrator credentials that were used in the old primary server.

- If you perform an unpair operation after performing a switchover operation, then you must perform a new Oracle Audit Vault integration with the new primary server.
- If you delete the new integration, then the old integration becomes non-functional. You must then delete this old integration by switching back to the old primary server.
- If a failover operation occurs and the original primary server is no longer available, then you must perform a new Oracle Audit Vault integration with the new primary server.

19.4 Using Oracle Key Vault Reports

Oracle Key Vault collects statistical information on a range of activities that impact Key Vault operations.

- [About Oracle Key Vault Reports](#)
The reports cover system activity, certificate expiration, keys, passwords, entitlement status, and metadata.
- [Viewing Key Management Reports for Oracle Endpoints](#)
All users can view the key management reports for Oracle endpoints.
- [Viewing Keys and Wallets Reports](#)
The keys and wallets reports require different privileges for viewing, depending on the report.
- [Viewing Secrets Management Reports](#)
All users can view the secrets management reports.
- [Viewing Endpoint Reports](#)
You must have the System Management role or the Audit Manager role to view the four categories of endpoint reports.
- [Viewing User Reports](#)
You must have the System Management role, the Key Management role, or the Audit Manager role to view the four categories of user reports.
- [Viewing System Reports](#)
You must have the System Management role or the Audit Manager role to view the system reports.

19.4.1 About Oracle Key Vault Reports

The reports cover system activity, certificate expiration, keys, passwords, entitlement status, and metadata.

Oracle Key Vault provides six types of reports for endpoints, users, keys and wallets, and system. In a multi-master cluster, some reports contain additional information, such as the node ID, node name, and IP address.

The six report types are as follows:

- Key management reports for Oracle endpoints, which includes information about TDE master encryption keys, GoldenGate master keys, and ACFS volume encryption key details
- Keys and wallets reports list the access privileges granted to all keys and wallets, and the details of TDE master encryption keys managed by Oracle Key Vault
- Secrets management reports for database passwords, secret data, and opaque objects

- Endpoint reports contain details of all endpoint and endpoint group activity, certificate and password expiration, and access privileges
- User reports contain details of all user and user group activity, their certificate and password expiration, and access privileges
- System reports contain a history of system backups taken and scheduled, details of remote restoration points, and RESTful command-line interface usage

A user who has the Audit Manager role can view all reports, including reports that are accessible from the Audit Trail pages in the Oracle Key Vault management console. A user with the Key Administrator role can view user reports and keys and wallets reports. Users with the System Administrator role can view endpoint, user, and system reports.

Related Topics

- [Managing System Auditing](#)
Auditing entails tasks such as capturing audit records in a syslog file or downloading the audit records to a local file.

19.4.2 Viewing Key Management Reports for Oracle Endpoints

All users can view the key management reports for Oracle endpoints.

1. Log in to the Oracle Key Vault management console.
2. Click the **Reports** tab and then **Reports** from left navigation bar.
3. Expand **Key Management Reports for Oracle Endpoints Reports**.

The **Key Management Reports for Oracle Endpoints Reports** page appears displaying the four types of user reports.

Key Management Reports for Oracle Endpoints

Name	Description
TDE Master Encryption Key Details Report	Creation, ownership, state and database-specific details of TDE master encryption keys
TDE Master Encryption Key Endpoint Usage Report	TDE master encryption key use by the endpoints
DB Generated TDE Master Encryption Key Attribute Report	Database-generated TDE master encryption key creation and activation attributes
GoldenGate Master Key Details Report	Creation, ownership, state and GoldenGate-specific details of GoldenGate master keys
ACFS Volume Encryption Key Details Report	Creation, ownership, state and ACFS-specific details of ACFS volume encryption keys

Keys and Wallets Reports

Secrets Management Reports

Endpoint Reports

User Reports

System Reports

4. Click the report name to see the corresponding user report.

19.4.3 Viewing Keys and Wallets Reports

The keys and wallets reports require different privileges for viewing, depending on the report.

1. Log in to the Oracle Key Vault management console as a user who has the appropriate privileges.

Only a user who has the Key Administrator role or Audit Manager role can view the Wallet Entitlement Report. All users can view the remaining reports.

2. Click the **Reports** tab and then **Reports** from left navigation bar.
3. Expand **Keys and Wallets Reports**.

The **Keys and Wallets Reports** page appears displaying the reports.

▶ Key Management Reports for Oracle Endpoints

▼ Keys and Wallets Reports

Name	Description
Wallet Entitlement Report	Access privileges of all users, user groups, endpoints and endpoint groups on wallets and wallet items
Keys & Secrets Endpoint Usage Report	Details of key, secret data, opaque object, certificate and template use by the endpoints
Symmetric Key Details Report	Ownership, creation, state and wallet details of symmetric keys that are not TDE, GoldenGate or ACFS keys
Private Key Details Report	Ownership, creation, state and wallet details of all private keys
Certificate Details Report	Ownership, creation, state and wallet details of all certificate objects
Certificate Request Details Report	Ownership, creation and wallet details of all certificate requests

4. Click the report name to see the corresponding report.

19.4.4 Viewing Secrets Management Reports

All users can view the secrets management reports.

1. Log in to the Oracle Key Vault management console.
2. Click the **Reports** tab and then **Reports** from left navigation bar.
3. Expand **Secrets Management Reports**.

The **Secrets Management Reports** page appears displaying the reports.

Expand All Collapse All

▶ Key Management Reports for Oracle Endpoints

▶ Keys and Wallets Reports

▼ Secrets Management Reports

Name	Description
DB Password Details Report	Ownership, creation, state and wallet details of all objects uploaded from secure external password store (SEPS) wallets
Secret Data Details Report	Ownership, creation, state and wallet details of all secret data but DB password objects
Opaque Object Details Report	Ownership, creation and wallet details of all opaque objects

▶ Endpoint Reports

▶ User Reports

▶ System Reports

4. Click the report name to see the corresponding report.

19.4.5 Viewing Endpoint Reports

You must have the System Management role or the Audit Manager role to view the four categories of endpoint reports.

Oracle Key Vault offers four endpoint reports: Endpoint Activity, Endpoint Certificate Expiry, Endpoint Entitlement, and Endpoint Metadata.

1. Log in to the Oracle Key Vault management console as a user who has the System Management role or the Audit Manager role.
2. Click the **Reports** tab and then **Reports** from left navigation bar.
3. Expand **Endpoint Reports**.

Expand All Collapse All

▶ Key Management Reports for Oracle Endpoints

▶ Keys and Wallets Reports

▶ Secrets Management Reports

▼ Endpoint Reports

Name	Description
Activity Report	Statistics of all endpoint and endpoint group activity
Entitlement Report	Access privileges of all endpoints and endpoint groups on wallets and wallet items
Certificate Expiration Report	Certificate expiration state of endpoints
Metadata Report	Endpoint information and deployment configuration details

▶ User Reports

▶ System Reports

- Select the name of the report that you want to view.

For example, the Activity Report for endpoints appears similar to the following:

All Endpoint Activity Close

Q Go Actions

Endpoint Name	Operation	Object	Object Type	Time
HCM_DB_RAC_INST1	Get Attributes	889FF729-10AE-4FAD-BF93-96D28F90BA2C	KEY	07-DEC-17:54:0
HCM_DB_RAC_INST1	Get	889FF729-10AE-4FAD-BF93-96D28F90BA2C	KEY	07-DEC-17:53:51
HCM_DB_RAC_INST1	Get Attributes	889FF729-10AE-4FAD-BF93-96D28F90BA2C	KEY	06-DEC-20:17:53:51
HCM_DB_RAC_INST1	Get	889FF729-10AE-4FAD-BF93-96D28F90BA2C	KEY	06-DEC-20:17:53:51
HCM_DB_RAC_INST1	Get Attributes	889FF729-10AE-4FAD-BF93-96D28F90BA2C	KEY	05-DEC-17:53:51
HCM_DB_RAC_INST1	Get	889FF729-10AE-4FAD-BF93-96D28F90BA2C	KEY	05-DEC-17:53:41
HCM_DB_RAC_INST1	Get Attributes	889FF729-10AE-4FAD-BF93-96D28F90BA2C	KEY	04-DEC-20:17:53:51

1 - 200 of 624

Specific Endpoint Activity

Select Endpoint: ACME_UNITED_MODE

Operation	Count	Percentage
Locate	4	(67%)
Version	1	(17%)
Store Endpoint Metadata	1	(17%)

row(s) 1 - 3 of 3

Specific Endpoint Group Activity

Select Endpoint Group: CLOUD_APP_GROUP

Operation	Count	Percentage
Register	2	(67%)
Store Endpoint Metadata	1	(33%)

row(s) 1 - 2 of 2

19.4.6 Viewing User Reports

You must have the System Management role, the Key Management role, or the Audit Manager role to view the four categories of user reports.

Oracle Key Vault offers four user reports: User Activity, User Entitlement, User Expiry, and User Failed Login.

- Log in to the Oracle Key Vault management console as a user who has the System Management role, the Key Management role, or the Audit Manager role.
- Click the **Reports** tab and then **Reports** from left navigation bar.
- Expand **User Reports** to see user-specific reports.

The **User Reports** page appears displaying the four types of user reports.

- Key Management Reports for Oracle Endpoints
- Keys and Wallets Reports
- Secrets Management Reports
- Endpoint Reports
- User Reports

Name	Description
Activity Report	Statistics of all user and user group activity
Entitlement Report	Access privileges of all users and user groups on wallets and wallet items
Account Report	Password expiration and account status of the regular Oracle Key Vault users
Failed Login Report	Summary of all failed login attempts to Oracle Key Vault
- System Reports

4. Click the report name to see the corresponding user report.

19.4.7 Viewing System Reports

You must have the System Management role or the Audit Manager role to view the system reports.

Oracle Key Vault offers three system reports: Backup History, Backup Restoration Catalog, and RESTful API Usage. For a multi-master cluster configuration, the following additional reports are available: Cluster and Conflict Resolution.

1. Log in to the Oracle Key Vault management console as a user who has the System Management role or the Audit Manager role.
2. Click the **Reports** tab and then **Reports** from left navigation bar.
3. Expand **System Reports**.

The **System Reports** page appears displaying the system reports available.

Expand All Collapse All

▶ Key Management Reports for Oracle Endpoints

▶ Keys and Wallets Reports

▶ Secrets Management Reports

▶ Endpoint Reports

▶ User Reports

▼ System Reports

Name	Description
Cluster Report	Cluster node and service operation details
Conflict Resolution Report	Resolved name conflicts for wallets, endpoints, endpoint groups, users and user groups
Backup History Report	History of the processed system backups
Notification Report	Alert messages and notifications sent over email
RESTful Services Usage Report	Summary of the operations performed using RESTful Service

4. Click the report type to see the corresponding system report.

A

Oracle Key Vault Multi-Master Cluster Operations

There are restrictions and conditions for Oracle Key Vault multi-master cluster operations on cluster nodes.

Table A-1 Oracle Key Vault Multi-Master Cluster Operations on Cluster Nodes

Management Console Tab and Operation	Read-Only Node	Read-Write Node in Read-Only Restricted Mode	Read-Write Node in normal (Read-Write) Mode
Home tab	No restrictions	No restrictions	No restrictions
Endpoints tab Endpoints <ul style="list-style-type: none"> • Add, Delete • Suspend, Resume • Reenroll Endpoint Groups <ul style="list-style-type: none"> • Create Group • Delete Group Update Endpoint Settings	Updated only via replication from a read-write node	Updated only via replication from a read-write node	Directly updated using client tools on this node Also updated by replication from other read-write nodes
Keys & Wallets tab Wallets <ul style="list-style-type: none"> • Create, Delete, Edit Keys, Secrets & Objects <ul style="list-style-type: none"> • Delete • Edit <ul style="list-style-type: none"> – Update – Revoke, Destroy – Change Wallet Membership 	Updated only through replication from a read-write node	Updated only via replication from a read-write node	Updated using client tools on this node. Also updated by replication from other read-write nodes.
Reports tab Audit <ul style="list-style-type: none"> • Generate audit report • Export audit records • Delete audit records Reports <ul style="list-style-type: none"> • Generate any report Alerts <ul style="list-style-type: none"> • View alerts • Configure alerts 	No restrictions	No restrictions	No restrictions

Table A-1 (Cont.) Oracle Key Vault Multi-Master Cluster Operations on Cluster Nodes

Management Console Tab and Operation	Read-Only Node	Read-Write Node in Read-Only Restricted Mode	Read-Write Node in normal (Read-Write) Mode
Users tab Users <ul style="list-style-type: none"> • Create, Delete • Check Conflict Status Manage Access (User Groups) <ul style="list-style-type: none"> • Update • Add, Remove Wallet Access • Add, Remove Members Change Password	Updated only with replication from a read-write node	Updated only with replication from a read-write node	Updated using client tools on this node Also updated by replication from other read-write nodes There are additional considerations and restrictions based on the status of the user name and user group name.
System tab System Settings <ul style="list-style-type: none"> • Reboot, Poweroff • Edit Network Details • Edit Network Services • Edit System Time • Edit DNS • Enable FIPS Mode • Configure Syslog • Enable Audit Vault Integration 	Node is used to update these settings. The updates are local to the node.	Node is used to update these settings. The updates are local to the node.	Node is used to update these settings. The updates are local to the node. The DNS settings and System Time are not set for the cluster here.
System tab Cluster System Settings <ul style="list-style-type: none"> • Edit System Time • Edit DNS • Edit Max Disable Node Duration • Enable RESTful Services • Configure Syslog 	Updated only with replication from a read-write node	Updated only with replication from a read-write node	Updated using client tools on this node Also updated by replication from other read-write nodes
System tab Audit Settings, Scope 'Node' <ul style="list-style-type: none"> • Enable Auditing • Replicate Audit Records • Send Audit to Syslog 	Node is used to update these settings. The updates are local to the node.	Node is used to update these settings. The updates are local to the node.	Node is used to update these settings. The updates are local to the node.

Table A-1 (Cont.) Oracle Key Vault Multi-Master Cluster Operations on Cluster Nodes

Management Console Tab and Operation	Read-Only Node	Read-Write Node in Read-Only Restricted Mode	Read-Write Node in normal (Read-Write) Mode
System tab Audit Settings, Scope 'Cluster' <ul style="list-style-type: none"> • Enable Auditing • Replicate Audit Records • Send Audit to Syslog 	Updated only with replication from a read-write node	Updated only with replication from a read-write node	Updated using client tools on this node. Also updated by replication from other read-write nodes
System tab Email Settings <ul style="list-style-type: none"> • Edit 	Node is used to update these settings. The updates are local to the node.	Node is used to update these settings. The updates are local to the node.	Node is used to update these settings. The updates are local to the node.
System tab Monitoring Settings, Scope 'Node' <ul style="list-style-type: none"> • Enable Monitoring • Limit Access • Edit 	Node is used to update these settings. The updates are local to the node.	Node is used to update these settings. The updates are local to the node.	Node is used to update these settings. The updates are local to the node.
System tab Monitoring Settings, Scope 'Cluster' <ul style="list-style-type: none"> • Enable Monitoring • Limit Access • Edit 	Updated only with replication from a read-write node	Updated only with replication from a read-write node	Updated using client tools on this node. Also updated by replication from other read-write nodes
System tab System Backup <ul style="list-style-type: none"> • Configure • Perform Backup • Perform Restore 	Node is used to update these settings. The updates are local to the node. A backup can only be restored to a standalone Oracle Key Vault server. Restoring a backup implies that the entire cluster has failed and needs to be rebuilt.	Node is used to update these settings. The updates are local to the node. A backup can only be restored to a standalone Oracle Key Vault server. Restoring a backup implies that the entire cluster has failed and needs to be rebuilt.	Node is used to update these settings. The updates are local to the node. A backup can only be restored to a standalone Oracle Key Vault server. Restoring a backup implies that the entire cluster has failed and needs to be rebuilt.
System tab Console Certificate <ul style="list-style-type: none"> • Generate, Upload 	Node is used to update these settings. The updates are local to the node.	Node is used to update these settings. The updates are local to the node.	Node is used to update these settings. The updates are local to the node.
System tab SSH Tunnel Settings <ul style="list-style-type: none"> • Add, Delete • Edit 	Node is used to update these settings. The updates are local to the node.	Node is used to update these settings. The updates are local to the node.	Node is used to update these settings. The updates are local to the node.
System tab HSM <ul style="list-style-type: none"> • All operations 	Node is used to update these settings. The updates are local to the node.	Node is used to update these settings. The updates are local to the node.	Node is used to update these settings. The updates are local to the node.

Table A-1 (Cont.) Oracle Key Vault Multi-Master Cluster Operations on Cluster Nodes

Management Console Tab and Operation	Read-Only Node	Read-Write Node in Read-Only Restricted Mode	Read-Write Node in normal (Read-Write) Mode
Cluster tab Management section <ul style="list-style-type: none"> Add Node Delete Node Force Delete Node Disable Node Enable Node 	A node in the ACTIVE state may be used to add, delete, force delete, or disable a node. When adding a node, selecting Add Node as a Read-Write Peer creates a read-write pair. Only a disabled node may enable itself. Delete and force delete have special considerations as noted.	A node in the ACTIVE state may be used to add, delete, force delete, or disable a node. When adding a node, this node cannot be added as a read-write peer to the new node, as it is already in a read-write pair. Only a disabled node may enable itself. Delete and force delete have special considerations as noted.	A node in the ACTIVE state may be used to add, delete, force delete, or disable a node. When adding a node, this node cannot be added as a read-write peer to the new node, as it is already in a read-write pair. Only a disabled node may enable itself. Delete and force delete have special considerations as noted.
Cluster tab Monitoring <ul style="list-style-type: none"> View information Enable, Disable link state 	Node can access and update these settings. The updates are local to the node.	Node can access and update these settings. The updates are local to the node.	Node can access and update these settings. The updates are local to the node.
Cluster tab Conflict Resolution <ul style="list-style-type: none"> Edit Accept 	Node can access but not resolve conflicts. Updates are received only from active read-write nodes in the cluster through replication.	Node can access but not resolve conflicts. Updates are received only from active read-write nodes in the cluster through replication.	Node can access and resolve conflicts. Updates are propagated to all other nodes in the cluster.
Join read-write pair	Only through induction from a read-only node. Requires Add Node as Read-Write Peer set to Yes .	Not applicable. Since this node is already a member of a read-write pair, when replication is once again available from this node to its read-write peer, it will return to its read-write state.	Not applicable

B

Oracle Key Vault okvutil Endpoint Utility Reference

The `okvutil` utility enables you to perform tasks uploading and downloading security objects.

- [About the okvutil Utility](#)
The `okvutil` utility is a command-line utility that you can use to manage security objects.
- [okvutil Command Syntax](#)
The `okvutil` utility syntax provides short and long options for specifying commands.
- [okvutil changepwd Command](#)
The `okvutil changepwd` command changes the password associated with the credentials used to connect to Oracle Key Vault.
- [okvutil diagnostics Command](#)
The `okvutil diagnostics` command collects diagnostic and environmental information on an endpoint to troubleshoot deployment issues.
- [okvutil download Command](#)
The `okvutil download` command downloads security objects from Oracle Key Vault to the endpoint.
- [okvutil list Command](#)
The `okvutil list` command lists the available security objects that are uploaded.
- [okvutil upload Command](#)
The `okvutil upload` command uploads security objects to Oracle Key Vault.

B.1 About the okvutil Utility

The `okvutil` utility is a command-line utility that you can use to manage security objects.

The `okvutil` command-line utility enables you to locate, upload, and download security objects to and from Oracle Key Vault. You can also use `okvutil` to change the wallet password and collect system diagnostics.

The `okvutil` utility uses the Transport Layer Security (TLS) credentials provisioned for the endpoint to authenticate to Oracle Key Vault.

B.2 okvutil Command Syntax

The `okvutil` utility syntax provides short and long options for specifying commands.

Syntax

```
okvutil command arguments [-v verbosity_level]
```

Parameters

Table B-1 okvutil Command Syntax

Parameter	Description
command	Refers to any of the following commands: <code>upload</code> , <code>list</code> , <code>download</code> , <code>changepwd</code> , <code>diagnostics</code>
arguments	Refers to the arguments that you pass for the accompanying command.
<code>-v</code> , <code>--verbose</code>	Refers to verbosity level. Possible values are 0,1, and 2. Verbosity level 2 provides the highest the level of detail that is printed to standard output during command execution. The meaning of verbosity values are as follows: <ul style="list-style-type: none"> • <code>-v 0</code> disables verbose mode. • <code>-v 1</code> includes debug messages. • <code>-v 2</code> includes more detailed debug messages.
<code>-h</code> , <code>--help</code>	Use option to get help with any <code>okvutil</code> command. For example: <code>okvutil command --help</code>

Short and Long Forms of Specifying Options

You can specify the options in either a short form or a long form.

**Note:**

Endpoint platforms AIX and HP-UX (IA) support only short form options currently

- **Short form:** Only use one hyphen and the single-letter option name. For example:

```
-l /home/username
-t wallet
```

- **Long form:** Provide two hyphens and the full option name. For example:

```
--location /home/username
--type wallet
```

The examples in this guide use the short form.

How Password Prompts for okvutil Work

The `okvutil` commands prompt for passwords in the following situations:

- If you created a password-protected wallet during endpoint installation to access Oracle Key Vault.
- If you specify an Oracle wallet file or Java keystore file using the `-l` option, `okvutil` prompts you to provide the password for the wallet or keystore that `okvutil` is trying to upload to Oracle Key Vault.

B.3 okvutil changepwd Command

The `okvutil changepwd` command changes the password associated with the credentials used to connect to Oracle Key Vault.

Use this command if you used a password-protected wallet to store the Oracle Key Vault endpoint user credentials. The new password does not need to be the same password for the JCKS or wallet file when it was uploaded.

Syntax

Short format:

```
okvutil changepwd -l location -t type [-v verbosity_level]
```

Long format:

```
okvutil changepwd --location location --type type [--verbose verbosity_level]
```

Parameters

Table B-2 okvutil changepwd Command Options

Parameter	Description
-l, --location	Specifies the directory location of the wallet whose password you want to change.
-t, --type	Specifies the data type. Enter WALLETT.
-v, --verbose	Refers to the verbosity level from 0 (none), 1 (debug), 2 (detailed debug).

Example: Changing an Oracle Key Vault Endpoint Password

The following example shows how to use the `okvutil changepwd` command change the endpoint password. When you are prompted to create the new password, enter a password that is between 8 and 30 characters.

```
$ okvutil changepwd -l ./home/oracle/okvutil/ssl -t WALLETT
Enter wallet password: current_endpoint_password
Enter new wallet password: new_endpoint_password
Confirm new wallet password: new_endpoint_password
```

B.4 okvutil diagnostics Command

The `okvutil diagnostics` command collects diagnostic and environmental information on an endpoint to troubleshoot deployment issues.

The information is placed in a `diagnostics.zip` file, which can be given to Oracle support for further analysis and debugging.

The information gathered includes information on the following:

- The shell environment variables: OKV_HOME, ORACLE_HOME, ORACLE_BASE, ORACLE_SID, PATH, CLASSPATH
- Configuration and IP address of the Oracle Key Vault server from `okvclient.ora`

- Directory listing of OKV_HOME and its sub-directories
- Oracle Key Vault log files from the endpoint
- Listing of symbolic links created by the Oracle Key Vault endpoint installer
- Network settings and ping results

The `okvutil diagnostics` command does not collect sensitive information such as user credentials or security objects.

Syntax

Short format:

```
okvutil diagnostics [-v verbosity_level]
```

Long format:

```
okvutil diagnostics [--verbose verbosity_level]
```

Parameters

Table B-3 okvutil diagnostics Command Options

Parameter	Description
<code>-v, --verbose</code>	Refers to the verbosity level from 0 (none), 1 (debug), 2 (detailed debug)

Example: Collecting System Diagnostics

The following example shows how to execute the `okvutil diagnostics` command. After you execute the command, when the `Diagnostics complete` message appears, then the `diagnostics.zip` file will be available in the current directory.

```
$ okvutil diagnostics
Diagnostics collection complete.
ls
diagnostics.zip
```

B.5 okvutil download Command

The `okvutil download` command downloads security objects from Oracle Key Vault to the endpoint.

These security objects include Oracle wallets including auto-login wallets, Java keystores, credential files, and other types of key storage files.

You can only download the contents of a virtual wallet into a keystore (a container such as an Oracle wallet or a JCEKS keystore that can hold multiple security objects), and not into a credential file.

Some keystores only support the storage of certain types of security objects. An error occurs if you upload a DSA key from a Java keystore or later try to download it to a different type of keystore like an Oracle wallet.

Syntax

Short format:

```
okvutil download -l location -t type [-g group | -i object_id] [-o] [-v
verbosity_level]
```

Long format:

```
okvutil download --location location --type type [--group group | --item object_id] [--
overwrite] [--verbose verbosity_level]
```

Parameters

Table B-4 okvutil download Command Options

Parameter	Description
-l, --location	Specifies the file location to store the items that you want to download. Ensure that you have permission to create wallets in this location. Ensure that the file you download is no more than 120 KB. This setting is mandatory.
-t, --type	Specifies the data type of the object being downloaded from Oracle Key Vault. It must be a value from the following list: <ul style="list-style-type: none"> • WALLETT for an Oracle wallet • JKS for a Java keystore • JCEKS for a Java Cryptography Extension keystore (JCEKS) • SSH for an SSH key file, to be downloaded as an opaque object. • KERBEROS for a Kerberos keytab, to be downloaded as an opaque object. • OTHER for opaque objects, which are other files that store secrets. The WALLETT, JKS, and JCEKS types contain multiple objects. Oracle Key Vault downloads each of these objects individually. The SSH, KERBEROS, and OTHER types, being opaque objects, are downloaded as single files. This setting is not case-sensitive. This setting is mandatory.
-g, --group	Is the name of a virtual wallet from which you download an item for the WALLETT, JKS, and JCEKS types. The virtual wallet must already exist, and the user must have authorization to access it. The okvutil utility downloads the entire virtual wallet specified by the -g option, and stores it in a new wallet. There must be no existing wallet at the specified location. The okvutil utility will create one. okvutil prompts you to create and enter a password for the new wallet. Record this password for the future. Remember that the group name is case-sensitive. If the type is WALLETT, JKS, or JCEKS, then you can either include or omit the group setting. If the type is SSH, KERBEROS, or OTHER, then you must include the object_id option, but not include the group setting. In a multi-master cluster, only the default wallet assigned to the endpoint can be specified when the name status is PENDING.
-i, --item	Refers to the unique ID of the object that you want to download, such as secrets (for example, -i oracle.security.client.password1 for the first secure external password store (SEPS) entry inside a wallet).

Table B-4 (Cont.) okvutil download Command Options

Parameter	Description
<code>-o, --overwrite</code>	Downloads data into an existing <code>WALLET</code> , <code>JKS</code> , or <code>JCEKS</code> file specified by <code>-l</code> , which must exist. If a conflict arises between the data to download and the data that already exists in the container, then the new data overwrites the old data. The <code>-o, --overwrite</code> option does not apply to the other types (<code>SSH</code> , <code>KERBEROS</code> , and <code>OTHER</code>). Use care if you plan to specify this option. If you omit the <code>o</code> or <code>overwrite</code> option when you download wallets that already exist in the current directory, then the original wallet file is renamed to either <code>ewallet.pl2.timestamp.bak</code> or <code>owallet.sso.timestamp.bak</code> before the new wallet file is downloaded. For files that are not wallets (such as Java keystore files), an error appears, and you will need to rename the file or move it to a new location before performing the download.
<code>-v, --verbose</code>	Refers to the verbosity level from 0 (none), 1 (debug), 2 (detailed debug).

Example: Downloading a Virtual Wallet to a Java Keystore

The following example shows how to use the `okvutil download` command to download the Oracle Key Vault virtual wallet `FinanceWallet` to a Java keystore. This is useful if you are sharing the same Java key store across multiple application servers and want to use the same wallet.

```
$ okvutil download -l ./fin/okv/work -t JCEKS -g FinanceWallet
```

The command will prompt for a new password for the Java Keystore as below:

```
Enter new Java keystore password:
Confirm new Java keystore password:
Download succeeded
```

Related Topics

- [okvutil list Command](#)
The `okvutil list` command lists the available security objects that are uploaded.
- [Downloading Oracle Wallets](#)
The `okvutil download` command downloads an Oracle wallet from the Oracle Key Vault server to an endpoint.

B.6 okvutil list Command

The `okvutil list` command lists the available security objects that are uploaded.

When used without options or with the `-g group` option, it displays the unique ID, object type, and a descriptor for each item it lists from Oracle Key Vault.

Syntax

Short format:

```
okvutil list [-l location -t type | -g group] [-v verbosity_level]
```

Long format:

```
okvutil list [--location location --type type | --group group] [--verbose
verbosity_level]
```

Parameters

Table B-5 okvutil list Command Options

Parameter	Description
-l, --location	Specifies the location of an Oracle wallet file or a Java keystore. For an Oracle wallet, the location is the directory that contains the .p12 or .sso files. For all other types, the location is the path name of the file itself. If you omit the -l, --location option, then the default location is Oracle Key Vault. In this case, the okvutil list command lists all the available keys in the server. If you use this setting, then you must also include the -t, --type setting, described next.
-t, --type	Specifies one of the following types: <ul style="list-style-type: none"> • WALLETT for an Oracle wallet • JKS for the Java keystore • JCEKS for the Java Cryptography Extension keystore (JCEKS) • OKV_PERSISTENT_CACHE for the persistent cache of Oracle Key Vault (Note that this setting becomes unavailable if EXPIRE PKCS11 PERSISTENT CACHE ON DATABASE SHUTDOWN has been set for a given endpoint database.) <p>The WALLETT, JKS, and JCEKS types are containers for security objects which Oracle Key Vault lists individually. The SSH, KERBEROS, and OTHER are opaque objects, and are listed as single files.</p> <p>This setting is not case-sensitive.</p>
-g, --group	Lists the content from a single virtual wallet. This option only applies when you omit the -l, --location option to list the objects stored in Oracle Key Vault. Only the default wallet assigned to the endpoint can be specified when the name status is PENDING.
-v, --verbose:	Refers to the verbosity level from 0 (none), 1 (debug), 2 (detailed debug).

Example: Listing Security Objects for the Current Endpoint

The following example shows how to use the okvutil list command to list all the authorized security objects for the current endpoint. In the last three lines, the DB Connect Password entries refer to the password that was used to log in to the instance (for example, the password for user psmith on the database instance inst01).

```
$ okvutil list
Enter Oracle Key Vault endpoint password: password

Unique ID                                     Type      Identifier
F63E3F4A-C8FB-5560-E043-7A6BF00AA4A6       Symmetric Key  TDE Master Key:
062C4F5BAC53E84F2DBF95B96CE577B525
F63E3F4A-C8FC-5560-E043-7A6BF00AA4A6       Symmetric Key  TDE Master Key:
069A5253CF9A384F61BFDD9CC07D8A6B07
F63E3F4A-C8FD-5560-E043-7A6BF00AA4A6       Opaque Object  -
F63E3F4A-C8FE-5560-E043-7A6BF00AA4A6       Symmetric Key  TDE Master Key:
06A66967E70DB24FE6BFD75447F518525E
F63E3F4A-C8FF-5560-E043-7A6BF00AA4A6       Symmetric Key  TDE Master Key:
0636D18F2E3FF64F7ABF80900843F37456
F63E3F4A-C900-5560-E043-7A6BF00AA4A6       Opaque Object  -
F63E3F4A-C901-5560-E043-7A6BF00AA4A6       Symmetric Key  TDE Master Key:
0611E6ABD666954F2F8F8359DE172BA787
```

```

F63E3F4A-C902-5560-E043-7A6BF00AA4A6   Symmetric Key   TDE Master Key:
0657F27D64D1C04FAEBFE00B5105B3CBAD
F63E3F4A-C91B-5560-E043-7A6BF00AA4A6   Opaque Object  Certificate Request
F63E3F4A-C91C-5560-E043-7A6BF00AA4A6   Certificate     X509 DN:OU=Class 1
Public Primary Certification Authority,O=VeriSign\, Inc.,C=US
F63E3F4A-C903-5560-E043-7A6BF00AA4A6   Secret Data     DB Connect Password:
psmith@inst01
F63E3F4A-C904-5560-E043-7A6BF00AA4A6   Secret Data     DB Connect Password:
jdaley@inst02
F63E3F4A-C905-5560-E043-7A6BF00AA4A6   Secret Data     DB Connect Password:
tjones@inst03

```

Example: Listing the Contents of an Oracle Wallet File

This example shows the contents of an Oracle wallet file.

```

$ okvutil list -t WALLET -l /home/oracle/wallets
Enter target wallet password: Oracle_wallet_password

Dumping secret store of wallet:
ORACLE.SECURITY.DB.ENCRYPTION.MASTERKEY
ORACLE.SECURITY.DB.ENCRYPTION.Aa4JEUaCeE8qv0Dsmmwe5S4AAAAAAAAAAAAAAAAAAAAAAAAAAAA
A
ORACLE.SECURITY.ID.ENCRYPTION.
ORACLE.SECURITY.KB.ENCRYPTION.
ORACLE.SECURITY.TS.ENCRYPTION.BZuIPES7+k/
tv0ZwOlDeIp4CAwAAAAAAAAAAAAAAAAAAAAAAAAAAAA
Dumping cert store of wallet:

There are 1 Certificate Requests in the list

Certificate request:
  DN: CN=oracle
  Type: NZDST_CERT_REQ
  PUB key size: 2048

There are 0 Certificates in the list

There are 0 TPs in the list

```

B.7 okvutil upload Command

The `okvutil upload` command uploads security objects to Oracle Key Vault.

These security objects can be Oracle wallets including auto-login wallets, Java keystores, credential files, user-defined keys, and other types of key storage files.

You can upload Oracle wallets from all currently supported releases of Oracle Database and other Oracle software products that use Oracle wallets. The `okvutil upload` command opens the wallet or Java keystore and uploads each item found as an individual security object into Oracle Key Vault. If you are uploading credential files, then Oracle Key Vault uploads them as whole files called opaque objects.

Syntax

Short format:

```
okvutil upload [-o] -l location -t type [-g group] [-d description] [-v
verbosity_level]
```

Long format:

```
okvutil upload [--overwrite] --location location --type type [--group group] [--description description] [--verbose verbosity_level]
```

Parameters

Table B-6 okvutil upload Command Options

Parameter	Description
-o, --overwrite	If there are conflicts with the existing data in the Oracle Key Vault virtual wallet, then Key Vault replaces the existing data with new data that is sent by the endpoint. If there are no conflicts, then the overwrite operation is not necessary and is not performed. Use care if you plan to specify this option.
-l, --location	Specifies the location of an Oracle wallet file, Java keystore, or a text file containing user-defined and hex-encoded TDE master encryption identifier and key. For an Oracle wallet, the location is the directory that contains the .p12 or .sso files. If you are uploading a credential file as an opaque object, then ensure that this file is no larger than 120 kilobytes (KB).
-t, --type	Specifies the data type of the object being uploaded to Oracle Key Vault. It must be a value from the following list: <ul style="list-style-type: none"> • WALLET for an Oracle wallet • JKS for a Java keystore • JCEKS for a Java Cryptography Extension keystore (JCEKS) • SSH for an SSH key file, to be uploaded as an opaque object. The maximum size is 120 KB. • KERBEROS for a Kerberos keytab, to be uploaded as an opaque object. The maximum size is 120 KB. • TDE_KEY_BYTES for a user-defined key to be used as a TDE master encryption key. • OTHER for opaque objects, which are other files that store secrets. The maximum size is 120 KB. <p>The WALLET, JKS, and JCEKS types contain multiple objects. Oracle Key Vault uploads each of these objects individually. The SSH, KERBEROS, TDE_KEY_BYTES, and OTHER types, being opaque objects, are uploaded as single files.</p> <p>This setting is not case-sensitive.</p>
-g, --group	Is the name of a Key Vault virtual wallet to which the certificate store or secret store (or both) are added. This name is case-sensitive. The virtual wallet must already exist, and the user must have authorization to access it. If you omit this setting, then the default group, if there is one, is used. If there is no default group and you omit the -g, --group option, then the data uploaded will not be placed in a group. Only the default wallet assigned to the endpoint can be specified when the name status is PENDING.
-d, --description	Enables you to add a description, up to 2000 bytes. It is valid only if the -t type, --type parameter is set to SSH, KERBEROS, TDE_KEY_BYTES, or OTHER. Optional. Enclose this description in double quotation marks. If there are spaces within this description, then include escape characters with the quotation marks. For example: -d \"text with spaces\"
-v, --verbose	Refers to the verbosity level from 0 (none), 1 (debug), 2 (detailed debug).

Example: Uploading a Java Keystore Using the -v 2 Option

The following example shows how to use the `okvutil upload` command to upload a Java keystore. The `-v 2` option enables the command to list the items that are uploaded. The `okvutil` command prompts if necessary for passwords to connect to Oracle Key Vault and to open the Oracle wallet file.

```
$ okvutil upload -l ./fin_jceks.jck -t JCEKS -g fin_wal -v 2

okvutil version 18.3.0.0.0
Configuration file: /tmp/fin_okv/conf/okvclient.ora
Server: 192.0.2.254:5696
Standby Server: 127.0.0.1:5696
Uploading from /tmp/fin_okv/keystores/jks/keystore.jks
Enter source Java keystore password:
Uploading private key
Uploading trust point
Uploading trust point
Uploading private key
Uploading private key

Uploaded 3 private keys
Uploaded 0 secret keys
Uploaded 2 trust points

Upload succeeded
```

Example: Uploading a Password-Protected Wallet File

The following example shows how to use the `okvutil upload` command to upload a password-protected wallet file when there is no password for the endpoint to connect to Oracle Key Vault.

```
$ okvutil upload -l . -t WALLET -g FinanceWallet
Enter source wallet password: password

Upload succeeded
```

Example: Uploading a User-Defined Key to Use as a TDE Master Encryption Key

The following example shows how to upload a user-defined key.

```
$ okvutil upload -l /tmp/tde_key_bytes.txt -t TDE_KEY_BYTES -g
"FIN_DATABASE_VIRTUAL_WALLET" -d "\"This key was created for Financial database
use on 1st April 2020\""
```

Related Topics

- [Uploading Oracle Wallets](#)
The `okvutil upload` command uploads wallets to Oracle Key Vault.
- [Step 1: Upload the User-Defined Key](#)
Use the `okvutil upload` command to upload user-defined master encryption keys to Oracle Key Vault.
- [Adding Security Objects to a Virtual Wallet](#)
You can add new security objects to a virtual wallet at any time as needed.
- [Uploading Oracle Wallets](#)
The `okvutil upload` command uploads wallets to Oracle Key Vault.

C

Troubleshooting Oracle Key Vault

Oracle provides checklists and tips for commonly encountered errors that will help you install and deploy Oracle Key Vault.

- [Finding Log File Errors](#)
The Oracle Key Vault log files capture all the error messages sent by the server.
- [Directory Permissions for Oracle Key Vault Migration](#)
An Oracle Key Vault migration operation may fail even if the permissions for the `/opt/oracle` directory are set to 700.
- [Error: Cannot Open Keystore Message](#)
The `Cannot Open Keystore` error can appear when you try to upload a Java keystore to the Oracle Key Vault server.
- [KMIP Error: Invalid Field](#)
The `Invalid Field KMIP` error can occur when you are trying to upload Oracle wallets to virtual wallets on multiple endpoints.
- [WARNING: Could Not Store Private Key Errors](#)
If you upload two keystores with the same file name but different contents, a `WARNING: Could not store private key` error appears.
- [Errors After Upgrading Oracle Key Vault](#)
Some errors that appear after the upgrade can be ignored.
- [Error: Failed to Open Wallet](#)
An `Failed to Open Wallet` error can appear if you attempt to use an online master key.
- [Transaction Check Error: Diagnostics Generation Utility](#)
If you are trying to perform an upgrade of Oracle Key Vault, a transaction check error may appear.
- [Fast-Start Failover \(FSFO\) Suspended \(ORA-16818\)](#)
An `ORA-16818: Fast-Start Failover suspended` error can appear as a result of a fast start failover operation failing.
- [SSH Tunnel Add Failure](#)
While you are configuring the SSH tunnel, a `Failed to establish SSH tunnel`. Refer to Oracle documentation error may appear.
- [Error: Provision Command Fails if /usr/bin/java Does Not Exist](#)
The RESTful service command to provision an endpoint fails if the soft link `/usr/bin/java` does not exist or points to an incorrect Java directory.
- [TDE Endpoint Integration Issues](#)
Several issues related to Transparent Data Encryption (TDE) endpoint integration problems can arise.
- [Failover Situations in Primary-Standby Mode](#)
Failover situations can occur with or without read-only restricted mode or during a planned shutdown operation for both primary and standby servers.

- [Performing a Planned Shutdown](#)
A user who has the System Administrator role can perform planned shutdowns during an upgrade or a maintenance window.

Related Topics

- [Guidelines for Uploading and Downloading Oracle Wallets](#)
Oracle provides guidelines for uploading and downloading wallets to and from Oracle Key Vault.
- [Guidelines for Uploading and Downloading JKS and JCEKS Keystores](#)
Oracle provides recommendations for when you upload and download JKS and JCEKS keystores.
- [Guidelines for Uploading and Downloading Credential Files](#)
Oracle provides recommendations for when you upload and download credential files.

C.1 Finding Log File Errors

The Oracle Key Vault log files capture all the error messages sent by the server.

The error messages are written to the `/var/log/messages` file. The first debugging step is to read the `messages` file.

1. Log in to the Oracle Key Vault server.
2. As the `root` user, check for log file errors as follows:

```
root# vi /var/log/messages
```

C.2 Directory Permissions for Oracle Key Vault Migration

An Oracle Key Vault migration operation may fail even if the permissions for the `/opt/oracle` directory are set to `700`.

Running `root.sh` creates the directory structure for Oracle Database to get the PKCS#11 library that is under the `/opt/oracle` directory. There is a chance that the directory structure may already exist and could have permissions different from the one set by `root.sh`.

To remedy this problem, check if the `/opt/oracle` directory already exists and then ensure that the permissions for every directory in the `/opt/oracle/extapi/64/hsm/oracle/1.0.0/liborapkcs.so` path are set to `755`.

C.3 Error: Cannot Open Keystore Message

The `Cannot Open Keystore` error can appear when you try to upload a Java keystore to the Oracle Key Vault server.

To remedy this problem, try the following solutions:

- Ensure that the `PATH` environment variable has been correctly set.
- Check where the `keytool` and Java are pointing to, by entering the following commands in a shell:

```
which keytool  
which java
```

- Ensure that you are using Oracle Java.

C.4 KMIP Error: Invalid Field

The `Invalid Field` KMIP error can occur when you are trying to upload Oracle wallets to virtual wallets on multiple endpoints.

The KMIP error can occur for other scenarios, but this scenario is the most common.

The steps that result in this error are as follows:

1. You configure two or more endpoints (for example, Endpoint A and Endpoint B) to share a wallet (Oracle Wallet C), and hence also share the wallet keys.
2. You register Endpoints A and B with Oracle Key Vault.
3. You create a default wallet (Virtual Wallet A) for Endpoint A and then a default wallet (Virtual Wallet B) for Endpoint B. Each virtual wallet is accessible only to the corresponding endpoint. For example, Endpoint B has no access to Virtual Wallet A.
4. You upload Oracle Wallet C into Virtual Wallet A on Endpoint A.
5. You attempt to upload Oracle Wallet C from Endpoint B into Virtual Wallet B Endpoint B.

The KMIP error occurs because there are two copies of the same key being created and Endpoint B does not have visibility for both. If Endpoint A tries to upload the first key again, Oracle Key Vault detects this action and accounts for it. But because in Step 5, Endpoint B is not allowed to see the first key, Oracle Key Vault is unable to perform the necessary harmonization for the two Oracle wallets.

This is expected behavior. To avoid the `Invalid Field`, create an endpoint group so that you can share the wallet with multiple endpoints.

Related Topics

-

C.5 WARNING: Could Not Store Private Key Errors

If you upload two keystores with the same file name but different contents, a `WARNING: Could not store private key` error appears.

This error occurs if you use the same alias (`-alias slserver`) in each `keytool` command. When you download two such keystores that have the same alias, the `okvutil download` process ignores the second one because the JKS aliases must be unique.

- To remedy this problem, download the second keystore using a unique alias.

Related Topics

- [Downloading JKS or JCEKS Keystores](#)
The `okvutil download` command can download an uploaded JKS or JCEKS keystore.

C.6 Errors After Upgrading Oracle Key Vault

Some errors that appear after the upgrade can be ignored.

After you perform an upgrade of Oracle Key Vault on a standalone server, ORA-1109: database does not open, ORA-00313: open failed for members, and ORA-00312: online log 3 thread 1 error messages may appear in the `/var/log/messages` log file.

You can safely ignore these messages. Error messages also appear in the `/var/log/debug` file.

C.7 Error: Failed to Open Wallet

An Failed to Open Wallet error can appear if you attempt to use an online master key.

If you are attempting to use an online master key (previously called TDE direct connect) and encounter this error, then first check your environment variable `ORACLE_BASE`. In an Oracle Real Application Clusters environment, you must perform this step on all database instances.

You must also set the `ORACLE_SID`, `ORACLE_HOME`, and `OKV_HOME` environment variables needed by the PKCS #11 library as follows:

1. Log in to the server where the PKCS #11 library resides and then set the `ORACLE_SID`, `ORACLE_HOME`, and `OKV_HOME` environment variables.
2. Log in to the database instance using SQL*Plus as a user with the SYSDBA administrative privilege.

```
sqlplus sys / as sysdba
Enter password: password
```

3. Shut down the database.

For example:

```
SHUTDOWN IMMEDIATE
```

4. From the command line, restart the database service.

```
su - oracle
lsnrctl start
```

5. In SQL*Plus, restart the database.

```
STARTUP
```

Related Topics

- [How To Create a TDE Auto_Login Wallet For A Database With Oracle Key Vault OKV TDE Direct Connection / Online Master Key \(Doc ID 2120160.1\)](#)

C.8 Transaction Check Error: Diagnostics Generation Utility

If you are trying to perform an upgrade of Oracle Key Vault, a transaction check error may appear.

For example:

```
file /usr/local/dbfw/etc/dbfw-diagnostics-package.yml from install of
appliance-18.3.0.0.0-52_190425.2253.d.x86_64 conflicts with file from
package okv-diagnostic-12.2.0.8.0-40_181013.1730.x86_64
```

The problem is that the diagnostic generation utility interferes with the upgrade process. You must remove the diagnostic generation utility before you can perform the upgrade.

C.9 Fast-Start Failover (FSFO) Suspended (ORA-16818)

An ORA-16818: Fast-Start Failover suspended error can appear as a result of a fast start failover operation failing.

If the primary server was shut down gracefully in a controlled way, such as by clicking a **Power Off** button instead of manually turning off the computer, then a fast start failover cannot be performed and the ORA-16818: Fast-Start Failover suspended error appears. In a graceful shutdown operation, the primary server's failover status goes into a suspended state with the standby waiting indefinitely for the primary server to be available. This is the expected behavior for a fast-start failover (FSFO) operation, as defined by Oracle Data Guard avoid a split brain scenario. By design, a fast-start failover operation error occurs only when the primary server shuts down unexpectedly. If you perform a SHUTDOWN IMMEDIATE or SHUTDOWN NORMAL command in SQL*Plus, then the FSFO does not occur because the database shuts down gracefully.

C.10 SSH Tunnel Add Failure

While you are configuring the SSH tunnel, a Failed to establish SSH tunnel. Refer to Oracle documentation error may appear.

You might get the following error message while trying to set up the SSH tunnel:

The failure may be due to one or more of the following problems:

- The following settings may be invalid:
 - Invalid IP address
 - Invalid port
 - Invalid user name
- The public SSH Oracle Key Vault key was not copied to the `authorized_keys` file of the `okv` user on the Database as a Service instance.
- The Database as a Service instance is not reachable because of network overload.

To remedy this problem, check your input values and connection and retry.

C.11 Error: Provision Command Fails if /usr/bin/java Does Not Exist

The RESTful service command to provision an endpoint fails if the soft link `/usr/bin/java` does not exist or points to an incorrect Java directory.

To remedy this problem, ensure that the Java version is 1.7.21 or later. You can create a soft link to the Java home directory as follows:

```
ln -s Java_home_directory/bin/java /usr/bin/java
```

C.12 TDE Endpoint Integration Issues

Several issues related to Transparent Data Encryption (TDE) endpoint integration problems can arise.

Common Transparent Data Encryption (TDE) endpoint integration problems caused by installation errors, `svrctl` misuse, and the mismanagement of security objects in a primary-standby environment can arise.

- **Installing the Oracle Key Vault library:** You must run `root.sh` to install the Oracle Key Vault library only once on a computer that has multiple Oracle databases. During an upgrade you must upgrade the library only after you have shut down all the associated endpoints. Oracle Key Vault servers are backward compatible with endpoint libraries.
- **Using `svrctl` to manage the database:** If you use the `svrctl` utility to manage the database, remember that `svrctl` can set the `ORACLE_BASE` environment variable to `NULL`. Oracle recommends that you set `ORACLE_BASE` to `ORACLE_HOME` if `ORACLE_BASE` is not used in your environment.
- **Managing security objects the same way in a primary-standby environment:** In a primary-standby configuration, ensure that both the primary and standby servers use the same mechanism to manage security objects. These servers should either both use a wallet or both use Oracle Key Vault.

C.13 Failover Situations in Primary-Standby Mode

Failover situations can occur with or without read-only restricted mode or during a planned shutdown operation for both primary and standby servers.

- [About Failover Situations in Primary-Standby Mode](#)
Failover situations in primary-standby node can occur with read-only restricted mode disabled, and with read-only restricted mode enabled.
- [Failover Situations Without Read-Only Restricted Mode](#)
If read-only restricted mode is not used, then various failover situations may occur in Oracle Key Vault.
- [Failover Situations with Read-Only Restricted Mode](#)
The use read-only restricted mode affects failover operations in Oracle Key Vault.

C.13.1 About Failover Situations in Primary-Standby Mode

Failover situations in primary-standby node can occur with read-only restricted mode disabled, and with read-only restricted mode enabled.

The types of failover situations are as follows:

- **Planned shutdown of the primary server:** A system administrator shuts down the primary server during an upgrade or maintenance window.
- **Planned shutdown of the standby server:** A system administrator shuts down the standby server during an upgrade or maintenance window.
- **Unplanned shutdown of the primary server:** The primary server is offline due to unforeseen circumstances such as power loss or network failure.

- **Unplanned shutdown of the standby server:** The standby server is offline due to unforeseen circumstances such as power loss or network failure.

C.13.2 Failover Situations Without Read-Only Restricted Mode

If read-only restricted mode is not used, then various failover situations may occur in Oracle Key Vault.

- [Primary Server: Planned Shutdown During an Upgrade](#)
In a failover, the use of read-only restricted mode affects a planned shutdown of a primary server during an upgrade.
- [Primary Server: Planned Shutdown During Maintenance](#)
In a failover, not using read-only restricted mode affects the planned shutdown of a primary server during maintenance.
- [Standby Server: Planned Shutdown](#)
In a failover, not using read-only restricted mode affects a planned shutdown in a standby server.
- [Primary Server: Unplanned Shutdown](#)
In a failover, not using read-only restricted mode affects an unplanned shutdown in a primary server.
- [Standby Server: Unplanned Shutdown](#)
In a failover, not using read-only restricted mode affects a standby server during an unplanned shutdown.

C.13.2.1 Primary Server: Planned Shutdown During an Upgrade

In a failover, the use of read-only restricted mode affects a planned shutdown of a primary server during an upgrade.

If read-only restricted mode is not used, when the primary server goes offline during an upgrade, then the standby server waits in read-only mode for the primary server to return online. During the upgrade, you cannot access the Oracle Key Vault management console.

- **Recovery process:** When the primary server is back online after the upgrade the standby server will automatically synchronize with the primary server. The primary and standby servers retain their earlier roles, and both servers will continue to operate in primary-standby mode.
- **Primary server state:** Down
- **Standby server state:** Up
- **Does failover occur?** No

Related Topics

- [Performing a Primary Server Planned Shutdown During an Upgrade](#)
You must upgrade both servers in a pair when you perform a primary server shutdown.

C.13.2.2 Primary Server: Planned Shutdown During Maintenance

In a failover, not using read-only restricted mode affects the planned shutdown of a primary server during maintenance.

If read-only restricted mode is not used, when the primary server is powered off or restarted during maintenance, then the standby server takes over from the primary server.

- **Recovery process:** The standby server is now the new primary server. When the old primary server is back online after maintenance, it will automatically synchronize with the new primary server and take over the role of standby server. Both servers will continue to operate in primary-standby mode. Be aware that when the primary server is offline, data replication is disabled. If the new primary server goes offline before synchronizing with the new standby server, it may cause a loss of critical data.
- **Primary server state:** Down
- **Standby server state:** Up
- **Does failover occur?** Yes

Related Topics

- [Performing a Primary Server Planned Shutdown During Maintenance](#)
To perform a primary server planned shutdown during maintenance, power off or restart Oracle Key Vault.

C.13.2.3 Standby Server: Planned Shutdown

In a failover, not using read-only restricted mode affects a planned shutdown in a standby server.

If read-only restricted mode is not used, when the standby server is powered off during upgrade or maintenance, the primary server continues operating as the primary server. Read and write operations are allowed.

- **Recovery process:** When the standby server is back online post-upgrade or post-maintenance, the primary server will automatically synchronize with the standby server. The primary and standby servers retain their earlier roles, and both servers will continue to operate in primary-standby mode. Be aware that when the standby server is offline, data replication is disabled. If the primary server goes offline before synchronizing with the standby server, then it may cause a loss of critical data.
- **Primary server state:** Up
- **Standby server state:** Down
- **Does failover occur?** No

Related Topics

- [Performing a Standby Server Planned Shutdown During an Upgrade](#)
You must upgrade both servers in a pair when you perform a standby server shutdown.
- [Performing a Standby Server Planned Shutdown During Maintenance](#)
You can perform a standby server planned shutdown during maintenance from the standby server using SSH.

C.13.2.4 Primary Server: Unplanned Shutdown

In a failover, not using read-only restricted mode affects an unplanned shutdown in a primary server.

If read-only restricted mode is not used, when the primary server goes offline because of power loss, network failure, or hardware failure, the standby server waits for the duration specified in the **Fast Start Failover Threshold** field on the Configure High

Availability page in the Oracle Key Vault management console. If the primary server cannot be reached after the specified duration has elapsed, then the standby server takes over from the primary server.

- **Recovery process:** The standby server is now the new primary server. Rectify the failure that affected the primary server by restarting the server or restoring network connectivity. When the primary server is back online, it will automatically synchronize with the new primary server and take over the role of standby server.
- **Primary server state:** Down
- **Standby server state:** Up
- **Does failover occur?** Yes

C.13.2.5 Standby Server: Unplanned Shutdown

In a failover, not using read-only restricted mode affects a standby server during an unplanned shutdown.

If read-only restricted mode is not used, when the standby server goes offline because of power loss, network failure, or hardware failure, then the primary server becomes unavailable. All operations are disabled.

- **Recovery process:** Rectify the failure that affected the standby server by restarting the server or restoring network connectivity. When the standby server is back online, it will automatically synchronize with the primary server. You cannot re-establish synchronization or network connectivity between the primary and standby servers, contact Oracle Support.
- **Primary server state:** Up
- **Standby server state:** Down
- **Does failover occur?** No

C.13.3 Failover Situations with Read-Only Restricted Mode

The use read-only restricted mode affects failover operations in Oracle Key Vault.

- [Primary Server: Planned Shutdown During an Upgrade](#)
In a failover, not using read-only restricted mode affects a planned shutdown of a primary server during an upgrade
- [Primary Server: Planned Shutdown During Maintenance](#)
In a failover, using read-only restricted mode affects the planned shutdown of a primary server during maintenance.
- [Standby Server: Planned Shutdown](#)
In a failover, using read-only restricted mode affects a planned shutdown in a standby server.
- [Primary Server: Unplanned Shutdown](#)
In a failover, using read-only restricted mode affects an unplanned shutdown in a primary server.
- [Standby Server: Unplanned Shutdown](#)
In a failover, using read-only restricted mode affects a standby server during an unplanned shutdown.

C.13.3.1 Primary Server: Planned Shutdown During an Upgrade

In a failover, not using read-only restricted mode affects a planned shutdown of a primary server during an upgrade

When the primary server goes offline during an upgrade, the standby server enters read-only restricted mode and waits for the primary server to come back online. During the upgrade, you cannot access the Oracle Key Vault management console.

- **Recovery process:** When the primary server is back online post-upgrade, the standby server will automatically synchronize with the primary server. The primary and standby servers retain their earlier roles, and both servers will continue to operate in primary-standby mode.
- **Primary server state:** Down
- **Standby server state:** Up
- **Does failover occur?** No

Related Topics

- [Performing a Primary Server Planned Shutdown During an Upgrade](#)
You must upgrade both servers in a pair when you perform a primary server shutdown.

C.13.3.2 Primary Server: Planned Shutdown During Maintenance

In a failover, using read-only restricted mode affects the planned shutdown of a primary server during maintenance.

When the primary server is powered off or restarted during maintenance, the standby server enters read-only restricted mode, and takes over from the primary server. The Oracle Key Vault management console displays a warning.

- **Recovery process:** The standby server is now the new primary server. When the old primary server is back online after maintenance, it will automatically synchronize with the new primary server and take over the role of standby server. Both servers will continue to operate in primary-standby mode.
- **Primary server state:** Down
- **Standby server state:** Up
- **Does failover occur?** Yes

Related Topics

- [Performing a Primary Server Planned Shutdown During Maintenance](#)
To perform a primary server planned shutdown during maintenance, power off or restart Oracle Key Vault.

C.13.3.3 Standby Server: Planned Shutdown

In a failover, using read-only restricted mode affects a planned shutdown in a standby server.

When the standby server is powered off during upgrade or maintenance, the primary server enters read-only restricted mode, and continues operating as the primary server. The Oracle Key Vault management console displays a warning.

- **Recovery process:** When the standby server is back online post-upgrade or after maintenance, the primary server will automatically synchronize with the standby server. The primary and standby servers retain their earlier roles, and both servers will continue to operate in primary-standby mode.
- **Primary server state:** Up
- **Standby server state:** Down
- **Does failover occur?** No

Related Topics

- [Performing a Standby Server Planned Shutdown During an Upgrade](#)
You must upgrade both servers in a pair when you perform a standby server shutdown.
- [Performing a Standby Server Planned Shutdown During Maintenance](#)
You can perform a standby server planned shutdown during maintenance from the standby server using SSH.

C.13.3.4 Primary Server: Unplanned Shutdown

In a failover, using read-only restricted mode affects an unplanned shutdown in a primary server.

When the primary server goes offline because of power loss, network failure, or hardware failure, then the standby server waits for the duration specified in the **Fast Start Failover Threshold** field on the Configure Primary-Standby page in the Oracle Key Vault management console. If the primary server is not reachable after the specified duration has elapsed, then the standby server enters read-only restricted mode, and takes over from the primary server.

- **Recovery process:** The standby server is now the new primary server. Rectify the failure that affected the primary server by restarting the server or restoring network connectivity. When the primary server is back online, it will automatically synchronize with the new primary server and take over the role of standby server.
- **Primary server state:** Down
- **Standby server state:** Up
- **Does failover occur?** Yes

C.13.3.5 Standby Server: Unplanned Shutdown

In a failover, using read-only restricted mode affects a standby server during an unplanned shutdown.

When the standby server goes offline because of power loss, network failure, or hardware failure, the primary server waits for the duration specified in the **Fast Start Failover Threshold** field on the Configure Primary-Standby page of the Oracle Key Vault management console. If the standby server is not reachable after the specified duration has elapsed, the primary server enters read-only restricted mode, and continues operating as the primary server.

- **Recovery process:** Rectify the failure that affected the standby server by restarting the server or restoring network connectivity. When the standby server is back online, it will automatically synchronize with the primary server. If you cannot re-establish synchronization or network connectivity between the primary and standby servers, then contact Oracle Support.
- **Primary server state:** Up

- **Standby server state:** Down
- **Does failover occur?** No

C.14 Performing a Planned Shutdown

A user who has the System Administrator role can perform planned shutdowns during an upgrade or a maintenance window.

- [Primary Server Planned Shutdown](#)
A user who has the System Administrator role can plan a shutdown of the primary server during an upgrade or a maintenance window.
- [Standby Server Planned Shutdown](#)
A user who has the System Administrator role can plan a shutdown of the primary server during an upgrade or a maintenance window.

C.14.1 Primary Server Planned Shutdown

A user who has the System Administrator role can plan a shutdown of the primary server during an upgrade or a maintenance window.

- [Performing a Primary Server Planned Shutdown During an Upgrade](#)
You must upgrade both servers in a pair when you perform a primary server shutdown.
- [Performing a Primary Server Planned Shutdown During Maintenance](#)
To perform a primary server planned shutdown during maintenance, power off or restart Oracle Key Vault.

C.14.1.1 Performing a Primary Server Planned Shutdown During an Upgrade

You must upgrade both servers in a pair when you perform a primary server shutdown.

During an upgrade, failover does not occur. The primary and standby servers retain their earlier roles after the primary server is back online post-upgrade. After an upgrade, the primary and standby server retain their old roles.

- To perform a primary upgrade, upgrade both of the Oracle Key Vault server pair used in the primary-standby configuration.

Related Topics

-

C.14.1.2 Performing a Primary Server Planned Shutdown During Maintenance

To perform a primary server planned shutdown during maintenance, power off or restart Oracle Key Vault.

1. Log in to the Oracle Key Vault management console as a user who has the System Administrator role.
2. Select the **System** tab, and then select **Status** in the left navigation bar.
3. On the Status page, do one of the following:
 - Click the **Power Off** button.
 - Click the **Reboot** button.

When the primary server is shut down, the standby server waits for the duration specified in the **Fast Start Failover Threshold** field on the Configure Primary-Standby page. When the duration has elapsed, the standby server will failover and take over from the primary server. The standby server is now the new primary server.

After a maintenance window, the primary and standby server switch roles. When the old primary server is back online after maintenance, it will take over the role of standby server.

C.14.2 Standby Server Planned Shutdown

A user who has the System Administrator role can plan a shutdown of the primary server during an upgrade or a maintenance window.

During upgrade, the standby server shuts down automatically, and no manual steps are necessary.

- [Performing a Standby Server Planned Shutdown During an Upgrade](#)
You must upgrade both servers in a pair when you perform a standby server shutdown.
- [Performing a Standby Server Planned Shutdown During Maintenance](#)
You can perform a standby server planned shutdown during maintenance from the standby server using SSH.

C.14.2.1 Performing a Standby Server Planned Shutdown During an Upgrade

You must upgrade both servers in a pair when you perform a standby server shutdown.

When you restart the standby server during the upgrade, the upgrade script initiates an automatic shutdown. There are no manual steps to be performed after the standby server is restarted.

- To perform a standby upgrade, upgrade both of the Oracle Key Vault server pair used in the primary-standby configuration.

Related Topics

-

C.14.2.2 Performing a Standby Server Planned Shutdown During Maintenance

You can perform a standby server planned shutdown during maintenance from the standby server using SSH.

1. Log in to the standby server terminal using `ssh` as user `support`, then switch user (`su`) to `root`.
2. Switch user (`su`) to `oracle`.
3. Log in to the standby database instance as a user who has the `ALTER DATABASE` system privilege.

For example:

```
sqlplus sec_admin
Enter password: password
```

4. Execute the `ALTER DATABASE` statement as follows:

```
ALTER DATABASE RECOVER MANAGED STANDBY DATABASE CANCEL;
```
5. Shut down the database.

SHUTDOWN IMMEDIATE

6. Power off the standby server.
 - a. Log in to the Oracle Key Vault management console as a user who has the System Administrator role.
 - b. Select the **System** tab, and then select **Status** from the left navigation bar.
 - c. In the Status page, click the **Power Off** button.

D

Security Technical Implementation Guides Compliance Standards

Oracle Key Vault follows the Security Technical Implementation Guides (STIG)-based compliance standards.

- [About Security Technical Implementation Guides](#)
A Security Technical Implementation Guide (STIG) is a methodology followed by the U.S. Department of Defense (DOD).
- [Enabling and Disabling STIG Rules on Oracle Key Vault](#)
You can enable STIG rules on Oracle Key Vault by enabling Strict mode.
- [Current Implementation of STIG Rules on Oracle Key Vault](#)
You should be aware of the vulnerability categories that STIG recommendations addresses.
- [Current Implementation of Database STIG Rules](#)
The current implementation of the database STIG rules encompass a wide range of rules.
- [Current Implementation of Operating System STIG Rules](#)
The current implementation of the operating system STIG rules encompass a wide range of rules.

D.1 About Security Technical Implementation Guides

A Security Technical Implementation Guide (STIG) is a methodology followed by the U.S. Department of Defense (DOD).

STIG is designed reduce the attack surface of computer systems and networks, thereby ensuring a lockdown of highly confidential information stored within the DOD network. STIGs provide secure configuration standards for the DOD's Information Assurance (IA) and IA-enabled devices and systems. STIGs are created by the Defense Information Systems Agency (DISA).

For over a decade, Oracle has worked closely with the DOD to develop, publish, and maintain a growing list of STIGs for a variety of core Oracle products and technologies including:

- Oracle Database
- Oracle Solaris
- Oracle Linux
- Oracle WebLogic

When STIGs are updated, Oracle analyzes the latest recommendations in order to identify new ways to improve the security of its products by:

- Implementing new and innovative security capabilities that are then added to future STIG updates

- Delivering functionality to automate the assessment and implementation of STIG recommendations
- Improving “out of the box” security configuration settings based upon STIG recommendations

D.2 Enabling and Disabling STIG Rules on Oracle Key Vault

You can enable STIG rules on Oracle Key Vault by enabling Strict mode.

- [Enabling STIG Rules on Oracle Key Vault](#)
You enable STIG rules (strict mode) from the command line.
- [Disabling STIG Rules on Oracle Key Vault](#)
You disable STIG rules (strict mode) from the command line.

D.2.1 Enabling STIG Rules on Oracle Key Vault

You enable STIG rules (strict mode) from the command line.

1. Log in to the operating system of the Key Vault server as the root user.
2. Run the following command as root:

```
/usr/local/dbfw/bin/stig --apply --OS|--rdbms
/usr/local/dbfw/bin/stig --enable
```

D.2.2 Disabling STIG Rules on Oracle Key Vault

You disable STIG rules (strict mode) from the command line.

1. Log in to the operating system of the Key Vault server as the root user.
2. Run the following command as root:

```
/usr/local/dbfw/bin/stig --disable
```

D.3 Current Implementation of STIG Rules on Oracle Key Vault

You should be aware of the vulnerability categories that STIG recommendations addresses.

Oracle has developed a security-hardened configuration of Oracle Key Vault that supports U.S. Department of Defense Security Technical Implementation Guide (STIG) recommendations.

[Table D-1](#) lists the three vulnerability categories that STIG recommendations address.

Table D-1 Vulnerability Categories

Category	Description
CAT I	Any vulnerability, the exploitation of which will, directly and immediately result in loss of Confidentiality, Availability, or Integrity.

Table D-1 (Cont.) Vulnerability Categories

Category	Description
CAT II	Any vulnerability, the exploitation of which has a potential to result in loss of Confidentiality, Availability, or Integrity.
CAT III	Any vulnerability, the existence of which degrades measures to protect against loss of Confidentiality, Availability, or Integrity.

D.4 Current Implementation of Database STIG Rules

The current implementation of the database STIG rules encompass a wide range of rules.

Table D-2 shows the current implementation of Database STIG rules on Oracle Key Vault.

Table D-2 Current Implementation of Database STIG Rules

STIG ID	Title	Severity	Addressed by Script	Addressed by Documentation	Action required	Implemented	Notes
DG0004-ORACLE 11	DBMS application object owner accounts	CAT II	No	No	None	No	Application object owner accounts KEYVAULT, APEX_040200, MANAGEMENT, and AVSYS are locked after the installation of Oracle Key Vault.
DG0008-ORACLE 11	DBMS application object ownership	No	No	Yes	No	No	The object owner accounts in the Oracle Key Vault server are as follows: <ul style="list-style-type: none"> KEYVAULT APEX_040200 AVSYS MANAGEMENT
DG0014-ORACLE 11	DBMS demonstration and sample databases	CAT II	No	No	None	No	All default demonstration and sample database objects have been removed.
DG0071-ORACLE 11	DBMS password change variance	CAT II	No	No	No	No	Currently not supported
DG0073-ORACLE 11	DBMS failed login account lock	CAT II	Yes	No	No	No	For profiles FAILED_LOGIN_ATTEMPTS is set to the required limit in the script.

Table D-2 (Cont.) Current Implementation of Database STIG Rules

STIG ID	Title	Severity	Addressed by Script	Addressed by Documentation	Action required	Implemented	Notes
DG0075-ORACLE 11	DBMS links to external databases	CAT II	No	Yes	No	No	No
DG0077-ORACLE 11	Production data protection on a shared system	CAT II	No	No	None	No	No
DG0116-ORACLE 11	DBMS privileged role assignments	CAT II	Yes	Yes	No	No	No
DG0117-ORACLE 11	DBMS administrative privilege assignment	CAT II	No	No	No	No	Currently not supported
DG0121-ORACLE 11	DBMS application user privilege assignment	CAT II	No	No	No	No	Currently not supported
DG0123-ORACLE 11	DBMS Administrative data access	CAT II	No	No	No	No	Currently not supported
DG0125-ORACLE 11	DBMS account password expiration	CAT II	Yes	No	No	No	For profiles PASSWORD_LIFE_TIME is set to the required limit in the script.
DG0126-ORACLE 11	DBMS account password reuse	CAT II	No	No	None	No	No.
DG0128-ORACLE 11	DBMS default passwords	CAT I	Yes	No	No	No	Account CTXSYS is assigned a random password in the script.
DG0133-ORACLE 11	DBMS Account lock time	CAT II	Yes	No	No	No	No
DG0141-ORACLE 11	DBMS access control bypass	CAT II	Yes	No	No	No	Users can use a script to audit the following events: DROP ANY SYNONYM DROP ANY INDEXTYPE
DG0142-ORACLE 11	DBMS Privileged action audit	CAT II	No	No	None	No	No

Table D-2 (Cont.) Current Implementation of Database STIG Rules

STIG ID	Title	Severity	Addressed by Script	Addressed by Documentation	Action required	Implemented	Notes
DG0192-ORACLE 11	DBMS fully-qualified name for remote access	CAT II	Yes	No	No	No	Currently not supported
DO0231-ORACLE 11	Oracle application object owner tablespaces	CAT II	No	No	No	No	Currently not supported
DO0250-ORACLE 11	Oracle database link usage	CAT II	No	Yes	No	No	No
DO0270-ORACLE 11	Oracle redo log file availability	CAT II	No	No	No	No	Currently not supported
DO0350-ORACLE 11	Oracle system privilege assignment	CAT II	No	No	No	No	Currently not supported
DO3475-ORACLE 11	Oracle PUBLIC access to restricted packages	CAT II	No	No	No	No	Currently not supported
DO3536-ORACLE 11	Oracle IDLE_TIME profile parameter	CAT II	Yes	No	No	No	No
DO3540-ORACLE 11	Oracle SQL92_SECURITY parameter	CAT II	No	No	None	No	Parameter SQL92_SECURITY is already set to TRUE.
DO3609-ORACLE 11	System privileges granted WITH ADMIN OPTION	CAT II	No	No	No	No	Currently not supported
DO3610-ORACLE 11	Oracle minimum object auditing	CAT II	No	No	No	No	Currently not supported
DO3689-ORACLE 11	Oracle object permission assignment to PUBLIC	CAT II	No	No	No	No	Currently not supported

Table D-2 (Cont.) Current Implementation of Database STIG Rules

STIG ID	Title	Severity	Addressed by Script	Addressed by Documentation	Action required	Implemented	Notes
DO3696-ORACLE11	Oracle RESOURCE_LIMIT parameter	CAT II	No	No	No	No	Currently not supported

D.5 Current Implementation of Operating System STIG Rules

The current implementation of the operating system STIG rules encompass a wide range of rules.

[Table D-3](#) shows the current implementation of Operating System STIG Rules on Oracle Key Vault.

Table D-3 Current Implementation of Operating System STIG Rules

STIG ID	Title	Severity	Key Vault Server - Default	Key Vault Server - STIG
SV-50237r1_rule	Automated file system mounting tools must not be enabled unless needed.	CAT III	No action required	Addressed by script
SV-50238r2_rule	Auditing must be enabled at boot by setting a kernel parameter.	CAT III	No action required	Addressed by script
SV-50243r1_rule	The <code>/etc/gshadow</code> file must be owned by root.	CAT II	No action required	Addressed by script
SV-50248r1_rule	The <code>/etc/gshadow</code> file must be group-owned by root.	CAT II	No action required	Addressed by script
SV-50249r1_rule	The <code>/etc/gshadow</code> file must have mode 0000.	CAT II	No action required	Addressed by script
SV-50250r1_rule	The <code>/etc/passwd</code> file must be owned by root.	CAT II	No action required	Addressed by script
SV-50251r1_rule	The <code>/etc/passwd</code> file must be group-owned by root.	CAT II	No action required	Addressed by script
SV-50255r1_rule	The system must use a separate file system for <code>/tmp</code> .	CAT III	No action required	Addressed by script

Table D-3 (Cont.) Current Implementation of Operating System STIG Rules

STIG ID	Title	Severity	Key Vault Server - Default	Key Vault Server - STIG
SV-50256r1_rule	The system must use a separate file system for <code>/var</code> .	CAT III	Addressed by script	Implemented differently
SV-50257r1_rule	The <code>/etc/passwd</code> file must have mode 0644 or less permissive.	CAT II	No action required	Addressed by script
SV-50258r1_rule	The <code>/etc/group</code> file must be owned by root.	CAT II	No action required	Addressed by script
SV-50259r1_rule	The <code>/etc/group</code> file must be group-owned by root.	CAT II	No action required	Addressed by script
SV-50261r1_rule	The <code>/etc/group</code> file must have mode 0644 or less permissive.	CAT II	No action required	Addressed by script
SV-50263r1_rule	The system must use a separate file system for <code>/var/log</code> .	CAT III	No action required	Addressed by script
SV-50266r1_rule	Library files must be owned by root.	CAT II	No action required	Addressed by script
SV-50267r1_rule	The system must use a separate file system for the system audit data path.	CAT III	Addressed by script	Not implemented
SV-50269r2_rule	All system command files must have mode 0755 or less permissive.	CAT II	No action required	Addressed by script
SV-50270r2_rule	The audit system must alert designated staff members when the audit storage volume approaches capacity.	CAT II	Addressed by script	Not implemented
SV-50272r1_rule	All system command files must be owned by root.	CAT II	No action required	Addressed by script
SV-50273r1_rule	The system must use a separate file system for user home directories.	CAT III	No action required	Addressed by script

Table D-3 (Cont.) Current Implementation of Operating System STIG Rules

STIG ID	Title	Severity	Key Vault Server - Default	Key Vault Server - STIG
SV-50275r1_rule	The system must require passwords to contain a minimum of 14 characters.	CAT II	Addressed by script	Addressed by script
SV-50277r1_rule	Users must not be able to change passwords more than once every 24 hours.	CAT II	No action required	Addressed by script
SV-50278r2_rule	The Red Hat Network Service (rhnvd) service must not be running, unless using RHN or an RHN Satellite.	CAT III	No action required	Addressed by script
SV-50279r1_rule	User passwords must be changed at least every 60 days.	CAT II	Addressed by script	Addressed by script
SV-50280r1_rule	Users must be warned 7 days in advance of password expiration.	CAT III	No action required	Addressed by script
SV-50282r1_rule	The system must require passwords to contain at least one numeric character.	CAT III	No action required	Addressed by script
SV-50283r1_rule	The system package management tool must cryptographically verify the authenticity of system software packages during installation.	CAT II	No action required	Addressed by script
SV-50288r1_rule	The system package management tool must cryptographically verify the authenticity of all software packages during installation.	CAT III	No action required	Addressed by script
SV-50290r1_rule	A file integrity tool must be installed.	CAT II	No action required	Addressed by script
SV-50291r2_rule	The operating system must enforce requirements for the connection of mobile devices to operating systems.	CAT II	No action required	Addressed by script

Table D-3 (Cont.) Current Implementation of Operating System STIG Rules

STIG ID	Title	Severity	Key Vault Server - Default	Key Vault Server - STIG
SV-50292r1_rule	There must be no <code>.rhosts</code> or <code>hosts.equiv</code> files on the system.	CAT I	No action required	Addressed by script
SV-50293r1_rule	The system must prevent the root account from logging in from virtual consoles.	CAT II	No action required	Addressed by script
SV-50295r1_rule	The system must prevent the root account from logging in from serial consoles.	CAT III	No action required	Addressed by script
SV-50296r1_rule	Audit log files must be owned by <code>root</code> .	CAT II	No action required	Addressed by script
SV-50298r2_rule	The system must not have accounts configured with blank or null passwords.	CAT I	No action required	Addressed by script
SV-50299r1_rule	Audit log files must have mode 0640 or less permissive.	CAT II	No action required	Addressed by script
SV-50300r1_rule	The <code>/etc/passwd</code> file must not contain password hashes.	CAT II	No action required	Addressed by script
SV-50301r2_rule	The root account must be the only account having a UID of 0.	CAT II	No action required	Addressed by script
SV-50302r3_rule	The system must disable accounts after excessive login failures within a 15-minute interval.	CAT II	No action required	Addressed by script
SV-50303r1_rule	The <code>/etc/shadow</code> file must be owned by <code>root</code> .	CAT II	No action required	Addressed by script
SV-50304r1_rule	The <code>/etc/shadow</code> file must be group-owned by <code>root</code> .	CAT II	No action required	Addressed by script
SV-50305r1_rule	The <code>/etc/shadow</code> file must have mode 0000.	CAT II	No action required	Addressed by script
SV-50312r1_rule	IP forwarding for IPv4 must not be enabled, unless the system is a router.	CAT II	No action required	Addressed by script

Table D-3 (Cont.) Current Implementation of Operating System STIG Rules

STIG ID	Title	Severity	Key Vault Server - Default	Key Vault Server - STIG
SV-50313r2_rule	The operating system must prevent public IPv4 access into an organizations internal networks, except as appropriately mediated by managed interfaces employing boundary protection devices.	CAT II	No action required	Addressed by script
SV-50314r1_rule	The systems local IPv4 firewall must implement a deny-all, allow-by-exception policy for inbound packets.	CAT II	No action required	Addressed by script
SV-50315r2_rule	The Datagram Congestion Control Protocol (DCCP) must be disabled unless required.	CAT II	No action required	Addressed by script
SV-50316r2_rule	The Stream Control Transmission Protocol (SCTP) must be disabled unless required.	CAT II	No action required	Addressed by script
SV-50317r2_rule	The Reliable Datagram Sockets (RDS) protocol must be disabled unless required.	CAT III	No action required	Addressed by script
SV-50318r2_rule	The Transparent Inter-Process Communication (TIPC) protocol must be disabled unless required.	CAT II	No action required	Addressed by script
SV-50319r2_rule	All rsyslog-generated log files must be owned by root.	CAT II	No action required	Addressed by script
SV-50321r1_rule	The operating system must back up audit records on an organization defined frequency onto a different system or media than the system being audited.	CAT II	Addressed by script	Not implemented

Table D-3 (Cont.) Current Implementation of Operating System STIG Rules

STIG ID	Title	Severity	Key Vault Server - Default	Key Vault Server - STIG
SV-50322r1_rule	The operating system must support the requirement to centrally manage the content of audit records generated by organization defined information system components.	CAT II	Addressed by script	Not implemented
SV-50323r2_rule	The audit system must be configured to audit all attempts to alter system time through <code>settimeofday</code> .	CAT III	No action required	Addressed by script
SV-50324r2_rule	The system must not accept IPv4 source-routed packets on any interface.	CAT II	No action required	Addressed by script
SV-50325r1_rule	The system must not accept ICMPv4 redirect packets on any interface.	CAT II	No action required	Addressed by script
SV-50326r3_rule	The audit system must be configured to audit all attempts to alter system time through <code>stime</code> .	CAT III	No action required	Addressed by script
SV-50327r1_rule	The system must not accept ICMPv4 secure redirect packets on any interface.	CAT II	No action required	Addressed by script
SV-50328r2_rule	The audit system must be configured to audit all attempts to alter system time through <code>clock_settime</code> .	CAT III	No action required	Addressed by script
SV-50329r1_rule	The system must log Martian packets.	CAT III	Addressed by script	Not implemented
SV-50330r1_rule	The system must not accept IPv4 source-routed packets by default.	CAT II	No action required	Addressed by script

Table D-3 (Cont.) Current Implementation of Operating System STIG Rules

STIG ID	Title	Severity	Key Vault Server - Default	Key Vault Server - STIG
SV-50331r1_rule	The audit system must be configured to audit all attempts to alter system time through <i>/etc/localtime</i> .	CAT III	No action required	Addressed by script
SV-50332r1_rule	The operating system must automatically audit account creation.	CAT III	No action required	Addressed by script
SV-50333r1_rule	The system must not accept ICMPv4 secure redirect packets by default.	CAT II	No action required	Addressed by script
SV-50334r2_rule	The system must ignore ICMPv4 redirect messages by default.	CAT III	No action required	Addressed by script
SV-50335r1_rule	The operating system must automatically audit account modification.	CAT III	No action required	Addressed by script
SV-50336r2_rule	The system must not respond to ICMPv4 sent to a broadcast address.	CAT III	No action required	Addressed by script
SV-50337r1_rule	The operating system must automatically audit account disabling actions.	CAT III	No action required	Addressed by script
SV-50338r2_rule	The system must ignore ICMPv4 bogus error responses.	CAT III	No action required	Addressed by script
SV-50339r1_rule	The operating system must automatically audit account termination.	CAT III	No action required	Addressed by script
SV-50340r1_rule	The system must be configured to use TCP <i>syncookies</i> .	CAT II	No action required	Addressed by script

Table D-3 (Cont.) Current Implementation of Operating System STIG Rules

STIG ID	Title	Severity	Key Vault Server - Default	Key Vault Server - STIG
SV-50342r1_rule	The audit system must be configured to audit modifications to the systems Mandatory Access Control (MAC) configuration (SELinux).	CAT III	No action required	Addressed by script
SV-50343r1_rule	The system must use a reverse-path filter for IPv4 network traffic when possible on all interfaces.	CAT II	No action required	Addressed by script
SV-50344r2_rule	The audit system must be configured to audit all discretionary access control permission modifications using chmod.	CAT III	No action required	Addressed by script
SV-50345r1_rule	The system must use a reverse-path filter for IPv4 network traffic when possible by default.	CAT II	No action required	Addressed by script
SV-50346r2_rule	The audit system must be configured to audit all discretionary access control permission modifications using chown.	CAT III	No action required	Addressed by script
SV-50347r2_rule	The IPv6 protocol handler must not be bound to the network stack unless needed.	CAT II	No action required	Addressed by script
SV-50348r2_rule	The audit system must be configured to audit all discretionary access control permission modifications using fchmod.	CAT III	No action required	Addressed by script
SV-50349r2_rule	The system must ignore ICMPv6 redirects by default.	CAT II	No action required	Addressed by script

Table D-3 (Cont.) Current Implementation of Operating System STIG Rules

STIG ID	Title	Severity	Key Vault Server - Default	Key Vault Server - STIG
SV-50351r2_rule	The audit system must be configured to audit all discretionary access control permission modifications using <code>fchmodat</code> .	CAT III	No action required	Addressed by script
SV-50353r2_rule	The audit system must be configured to audit all discretionary access control permission modifications using <code>fchown</code> .	CAT III	No action required	Addressed by script
SV-50355r2_rule	The audit system must be configured to audit all discretionary access control permission modifications using <code>fchownat</code> .	CAT III	No action required	Addressed by script
SV-50356r2_rule	The system must employ a local IPv4 firewall.	CAT II	No action required	Addressed by script
SV-50357r2_rule	The audit system must be configured to audit all discretionary access control permission modifications using <code>fremovexattr</code> .	CAT III	No action required	Addressed by script
SV-50358r2_rule	The audit system must be configured to audit all discretionary access control permission modifications using <code>fsetxattr</code> .	CAT III	No action required	Addressed by script
SV-50359r2_rule	The audit system must be configured to audit all discretionary access control permission modifications using <code>lchown</code> .	CAT III	No action required	Addressed by script

Table D-3 (Cont.) Current Implementation of Operating System STIG Rules

STIG ID	Title	Severity	Key Vault Server - Default	Key Vault Server - STIG
SV-50360r2_rule	The audit system must be configured to audit all discretionary access control permission modifications using <code>lremovexattr</code> .	CAT III	No action required	Addressed by script
SV-50362r2_rule	The audit system must be configured to audit all discretionary access control permission modifications using <code>lsetxattr</code> .	CAT III	No action required	Addressed by script
SV-50364r2_rule	The audit system must be configured to audit all discretionary access control permission modifications using <code>removexattr</code> .	CAT III	No action required	Addressed by script
SV-50366r2_rule	The audit system must be configured to audit all discretionary access control permission modifications using <code>setxattr</code> .	CAT III	No action required	Addressed by script
SV-50369r2_rule	The audit system must be configured to audit successful file system mounts.	CAT III	No action required	Addressed by script
SV-50370r1_rule	The system must require passwords to contain at least one uppercase alphabetic character.	CAT III	No action required	Addressed by script
SV-50371r1_rule	The system must require passwords to contain at least one special character.	CAT III	No action required	Addressed by script
SV-50372r1_rule	The system must require passwords to contain at least one lowercase alphabetic character.	CAT III	No action required	Addressed by script

Table D-3 (Cont.) Current Implementation of Operating System STIG Rules

STIG ID	Title	Severity	Key Vault Server - Default	Key Vault Server - STIG
SV-50373r1_rule	The system must require at least four characters be changed between the old and new passwords during a password change.	CAT III	No action required	Addressed by script
SV-50374r3_rule	The system must disable accounts after three consecutive unsuccessful logon attempts.	CAT II	No action required	Addressed by script
SV-50375r1_rule	The system must use a FIPS 140-2 approved cryptographic hashing algorithm for generating account password hashes (system-auth).	CAT II	No action required	Addressed by script
SV-50376r4_rule	The audit system must be configured to audit user deletions of files and programs.	CAT III	No action required	Addressed by script
SV-50377r1_rule	The system must use a FIPS 140-2 approved cryptographic hashing algorithm for generating account password hashes (login.defs).	CAT II	No action required	Addressed by script
SV-50378r1_rule	The system must use a FIPS 140-2 approved cryptographic hashing algorithm for generating account password hashes (libuser.conf).	CAT II	No action required	Addressed by script
SV-50379r1_rule	The audit system must be configured to audit changes to the /etc/sudoers file.	CAT III	No action required	Addressed by script

Table D-3 (Cont.) Current Implementation of Operating System STIG Rules

STIG ID	Title	Severity	Key Vault Server - Default	Key Vault Server - STIG
SV-50380r1_rule	The system boot loader configuration file(s) must be owned by root.	CAT II	No action required	Addressed by script
SV-50381r1_rule	The audit system must be configured to audit the loading and unloading of dynamic kernel modules.	CAT II	No action required	Addressed by script
SV-50382r1_rule	The system boot loader configuration file(s) must be group-owned by root.	CAT II	No action required	Addressed by script
SV-50383r2_rule	The xinetd service must be disabled if no network services utilizing it are enabled.	CAT II	No action required	Addressed by script
SV-50384r2_rule	The system boot loader configuration file(s) must have mode 0600 or less permissive.	CAT II	No action required	Addressed by script
SV-50385r1_rule	The xinetd service must be uninstalled if no network services utilizing it are enabled.	CAT III	No action required	Addressed by script
SV-50386r1_rule	The system boot loader must require authentication.	CAT II	Addressed by script	Not implemented
SV-50387r1_rule	The system must require authentication upon booting into single-user and maintenance modes.	CAT II	Addressed by script	Not implemented
SV-50388r1_rule	The telnet-server package must not be installed.	CAT I	No action required	Addressed by script
SV-50389r1_rule	The system must not permit interactive boot.	CAT II	No action required	Addressed by script
SV-50390r2_rule	The telnet daemon must not be running.	CAT I	No action required	Addressed by script

Table D-3 (Cont.) Current Implementation of Operating System STIG Rules

STIG ID	Title	Severity	Key Vault Server - Default	Key Vault Server - STIG
SV-50391r1_rule	The system must allow locking of the console screen in text mode.	CAT III	Addressed by script	Not implemented
SV-50392r1_rule	The <code>rsh-server</code> package must not be installed.	CAT I	No action required	Addressed by script
SV-50393r3_rule	The system must require administrator action to unlock an account locked by excessive failed login attempts.	CAT II	Addressed by script	Addressed by script
SV-50395r2_rule	The <code>rshd</code> service must not be running.	CAT I	No action required	Addressed by script
SV-50399r2_rule	The <code>rexecd</code> service must not be running.	CAT I	No action required	Addressed by script
SV-50401r1_rule	The system must not send ICMPv4 redirects by default.	CAT II	No action required	Addressed by script
SV-50402r1_rule	The system must not send ICMPv4 redirects from any interface.	CAT II	No action required	Addressed by script
SV-50403r2_rule	The <code>rlogind</code> service must not be running.	CAT I	No action required	Addressed by script
SV-50404r1_rule	The <code>ypserv</code> package must not be installed.	CAT II	No action required	Addressed by script
SV-50405r2_rule	The <code>ypbind</code> service must not be running.	CAT II	No action required	Addressed by script
SV-50406r2_rule	The <code>cron</code> service must be running.	CAT II	No action required	Addressed by script
SV-50407r1_rule	The <code>tftp-server</code> package must not be installed.	CAT II	No action required	Addressed by script
SV-50408r1_rule	The SSH daemon must be configured to use only the SSHv2 protocol.	CAT I	No action required	Addressed by script
SV-50409r1_rule	The SSH daemon must set a timeout interval on idle sessions.	CAT III	No action required	Addressed by script

Table D-3 (Cont.) Current Implementation of Operating System STIG Rules

STIG ID	Title	Severity	Key Vault Server - Default	Key Vault Server - STIG
SV-50411r1_rule	The SSH daemon must set a timeout count on idle sessions.	CAT III	No action required	Addressed by script
SV-50412r1_rule	The SSH daemon must ignore <code>rhosts</code> files.	CAT II	No action required	Addressed by script
SV-50413r1_rule	The SSH daemon must not allow host-based authentication.	CAT II	No action required	Addressed by script
SV-50414r1_rule	The system must not permit root logins using remote access programs such as SSH.	CAT II	No action required	Addressed by script
SV-50415r1_rule	The SSH daemon must not allow authentication using an empty password.	CAT I	No action required	Addressed by script
SV-50416r1_rule	The SSH daemon must be configured with the Department of Defense (DoD) login banner.	CAT II	Addressed by script	Not implemented
SV-50417r1_rule	The SSH daemon must not permit user environment settings.	CAT III	No action required	Addressed by script
SV-50419r2_rule	The <code>avahi</code> service must be disabled.	CAT III	No action required	Addressed by script
SV-50421r1_rule	The system clock must be synchronized continuously, or at least daily.	CAT II	Addressed by script	Addressed by documentation
SV-50422r1_rule	The system clock must be synchronized to an authoritative DoD time source.	CAT II	No action required	Addressed by script
SV-50423r2_rule	Mail relaying must be restricted.	CAT II	Addressed by script	Not applicable
SV-50428r1_rule	The <code>openldap-servers</code> package must not be installed unless required.	CAT III	No action required	Addressed by script

Table D-3 (Cont.) Current Implementation of Operating System STIG Rules

STIG ID	Title	Severity	Key Vault Server - Default	Key Vault Server - STIG
SV-50430r3_rule	The graphical desktop environment must set the idle timeout to no more than 15 minutes.	CAT II	No action required	Addressed by script
SV-50431r3_rule	The graphical desktop environment must automatically lock after 15 minutes of inactivity and the system must require user reauthentication to unlock the environment.	CAT II	No action required	Addressed by script
SV-50434r1_rule	The system must set a maximum audit log file size.	CAT II	No action required	Addressed by script
SV-50435r1_rule	The system must rotate audit log files that reach the maximum file size.	CAT II	No action required	Addressed by script
SV-50436r2_rule	The audit system must be configured to audit all attempts to alter system time through <code>adjtimex</code> .	CAT III	No action required	Addressed by script
SV-50437r1_rule	The system must retain enough rotated audit logs to cover the required log retention period.	CAT II	No action required	Addressed by script
SV-50439r3_rule	The graphical desktop environment must have automatic lock enabled.	CAT II	No action required	Addressed by script
SV-50440r3_rule	The system must display a publicly-viewable pattern during a graphical desktop environment session lock.	CAT III	No action required	Addressed by script
SV-50441r2_rule	The Automatic Bug Reporting Tool (<code>abrt</code>) service must not be running.	CAT III	No action required	Addressed by script
SV-50442r2_rule	The <code>atd</code> service must be disabled.	CAT III	No action required	Addressed by script

Table D-3 (Cont.) Current Implementation of Operating System STIG Rules

STIG ID	Title	Severity	Key Vault Server - Default	Key Vault Server - STIG
SV-50443r1_rule	The system default umask for daemons must be 027 or 022.	CAT III	No action required	Addressed by script
SV-50445r2_rule	The ntpdate service must not be running.	CAT III	No action required	Addressed by script
SV-50446r1_rule	The system default umask in /etc/login.defs must be 077.	CAT III	No action required	Addressed by script
SV-50447r2_rule	The oddjobd service must not be running.	CAT III	No action required	Addressed by script
SV-50448r1_rule	The system default umask in /etc/profile must be 077.	CAT III	Addressed by script	Not implemented
SV-50449r2_rule	The qpidd service must not be running.	CAT III	No action required	Addressed by script
SV-50450r1_rule	The system default umask for the csh shell must be 077.	CAT III	Addressed by script	Not implemented
SV-50451r2_rule	The rdisc service must not be running.	CAT III	No action required	Addressed by script
SV-50452r1_rule	The system default umask for the bash shell must be 077.	CAT III	Addressed by script	Not implemented
SV-50457r1_rule	The system must use SMB client signing for connecting to samba servers using smbclient.	CAT III	Addressed by script	Not implemented
SV-50470r1_rule	The postfix service must be enabled for mail delivery.	CAT III	Addressed by script	Not implemented
SV-50472r1_rule	The sendmail package must be removed.	CAT II	No action required	Addressed by script
SV-50473r2_rule	The netconsole service must be disabled unless required.	CAT III	No action required	Addressed by script
SV-50475r1_rule	X Windows must not be enabled unless required.	CAT II	No action required	Addressed by script

Table D-3 (Cont.) Current Implementation of Operating System STIG Rules

STIG ID	Title	Severity	Key Vault Server - Default	Key Vault Server - STIG
SV-50476r2_rule	Process core dumps must be disabled unless needed.	CAT III	Addressed by script	Not implemented
SV-50477r1_rule	The <code>xorg-x11-server-common</code> (X Windows) package must not be installed, unless required.	CAT III	No action required	Addressed by script
SV-50480r2_rule	The DHCP client must be disabled if not needed.	CAT II	Addressed by script	Not implemented
SV-50481r1_rule	The audit system must identify staff members to receive notifications of audit log storage volume capacity issues.	CAT II	No action required	Addressed by script
SV-50485r2_rule	The system must limit users to 10 simultaneous system logins, or a site-defined number, in accordance with operational requirements.	CAT III	Addressed by script	Not implemented
SV-50488r2_rule	The system must provide VPN connectivity for communications over untrusted networks.	CAT III	Addressed by script	Not implemented
SV-50489r2_rule	A login banner must be displayed immediately prior to, or as part of, graphical desktop environment login prompts.	CAT II	No action required	Addressed by script
SV-50492r2_rule	The Bluetooth service must be disabled.	CAT II	No action required	Addressed by script
SV-50493r1_rule	Accounts must be locked upon 35 days of inactivity.	CAT III	Addressed by script	Not implemented

Table D-3 (Cont.) Current Implementation of Operating System STIG Rules

STIG ID	Title	Severity	Key Vault Server - Default	Key Vault Server - STIG
SV-50495r1_rule	The operating system must manage information system identifiers for users and devices by disabling the user identifier after an organization defined time period of inactivity.	CAT III	Addressed by script	Not implemented
SV-50498r2_rule	The sticky bit must be set on all public directories.	CAT III	Addressed by script	No action required
SV-50500r2_rule	All public directories must be owned by a system account.	CAT III	No action required	Addressed by script
SV-50502r1_rule	The TFTP daemon must operate in secure mode which provides access only to a single directory on the host file system.	CAT I	No action required	Addressed by script
SV-65547r1_rule	The system must use a Linux Security Module at boot time.	CAT II	No action required	Addressed by script
SV-65573r1_rule	The system must use a Linux Security Module configured to enforce limits on system services.	CAT II	Addressed by script	Not implemented
SV-65579r1_rule	The system must use a Linux Security Module configured to limit the privileges of system services.	CAT III	No action required	Addressed by script
SV-66089r1_rule	The operating system, upon successful logonSuccess, must display to the user the number of unsuccessful logonSuccess attempts since the last successful logonSuccess.	CAT II	No action required	Addressed by script

Table D-3 (Cont.) Current Implementation of Operating System STIG Rules

STIG ID	Title	Severity	Key Vault Server - Default	Key Vault Server - STIG
SV-68627r1_rule	The audit system must switch the system to single-user mode when available audit storage volume becomes dangerously low.	CAT II	Addressed by script	Not implemented

Glossary

appliance

The format in which Oracle Key Vault is made available. The Oracle Key Vault software appliance includes the operating system, the software that implements the Oracle Key Vault functionality, the database, the replication software, and other related components. Oracle Key Vault is delivered as a software image that is installed on a standalone computer, or machine, supplied by the user. Oracle provides all updates for the software on the appliance, including the operating system. Do not load additional software on the Oracle Key Vault appliance.

You can deploy an Oracle Key Vault appliance as a standalone server, a member of a primary-standby configuration, or a node in a multi-master cluster.

Audit Manager

An Oracle Key Vault administrative role that enables a user to manage audit lifecycle and policies and to separate the role of auditing from the role of managing the Oracle Key Vault server.

auto-login wallet

An Oracle wallet file that can be accessed without a password. An auto-login wallet is stored in a `cwallet.sso` file.

candidate node

During [node induction](#), an Oracle Key Vault server to be added to a multi-master cluster. A candidate node must be a freshly installed Oracle Key Vault appliance, except when it is the [initial node](#), in which case it provides the entirety of the cluster's initial data. A candidate node must be at the same release and patch level as the multi-master cluster to which it is being added.

After the server has been inducted into a cluster, it is called a [node](#). After a successful node induction, you can configure the server to use the cluster-wide configuration settings. The [cluster data set](#) is then replicated to the node.

cluster data set

The set of all [security objects](#) managed by the cluster. When creating the cluster, the initial node provides all of the security objects that will be part of the initial cluster data set.

cluster link

A link that represents the outbound network connection (to the [node](#)) and the inbound replication process (from the node). You can enable or disable the link to manage node data replication.

cluster subgroup

A group of one or more [nodes](#) that is a subgroup of a cluster. Each node in a cluster can belong to only one subgroup. The node is assigned to a subgroup when the node is added to the multi-master cluster. The assignment is for each node, and members of a [read-write pair](#) can be in different subgroups.

The subgroup implements a notion of [endpoint](#) affinity. Endpoints are also a part of subgroups. The endpoint's subgroup is assigned when the endpoint is created. It is used when you set the endpoint's node search order in the [endpoint node scan list](#). Nodes in the same subgroup as the endpoint are considered local to the endpoint. The local subgroup is scanned first before communicating with nodes that are not in the local subgroup.

The cluster topology can change when you add or remove new nodes to and from the cluster. The endpoints get this information with the response messages for the operations the endpoint initiated. Oracle Key Vault periodically sends the updated endpoint node scan list back to the endpoint even if there is no change to cluster topology. This is to account for any lost messages.

controller node

A [node](#) that controls or manages a cluster reconfiguration change, such as adding, enabling, disabling, or removing nodes. A node is only a controller node while the change is being made. During [node induction](#), the controller node provides the server certificate and the data that is used to initialize the [candidate node](#).

Each concurrent operation will have its own controller node. One controller node can only control one cluster configuration transaction at a time.

credential file

A file that contains sensitive information such as user IDs, passwords, and keys. The file, such as a Kerberos keytab file, is stored as an opaque object, which means that its individual contents are not interpreted by Oracle Key Vault. The entire file is uploaded and downloaded as an object.

See also [security object](#).

default wallet

A special [virtual wallet](#) that is associated with an [endpoint](#), into which all the endpoint's [security objects](#) can be automatically uploaded.

deleted node

A [node](#) that has been disassociated from the cluster, either by using the **Delete** or **Force Delete** buttons on the Oracle Key Vault management console. If it has been disabled for longer than the [Maximum Disable Node duration](#), then you must delete the node.

Once a node has been deleted, you cannot re-associate it with the cluster. If it is to be inducted into the cluster, then you must re-image it and then convert into a freshly installed server.

You can use the **Delete** option under normal operating circumstances. Only use the **Force Delete** option if the node is unreachable when the **Delete** option does not work.

endpoint

A computer system such as a database server, an application server, and other information systems, where keys are used to access encrypted data and credentials are used to authenticate to other systems.

endpoint administrator

Owner of an [endpoint](#). Endpoint administrators can be typically system, security, or database administrators, but they can be any personnel charged with deploying, managing and maintaining security within an enterprise. They are responsible for enrolling endpoints and controlling endpoint access to [security objects](#).

endpoint group

A collection of [endpoints](#) that are created to share a set of [security objects](#).

endpoint node scan list

A list of [nodes](#) to which an [endpoint](#) can connect.

heartbeat lag

A monitored metric that determines the health of the multi-master cluster. This is an indication of the [node](#) and network health. It is the time since the current node received a heartbeat message from a given node. A heartbeat is sent out from each node every two minutes. Every heartbeat should be received on each other node shortly thereafter.

A higher heartbeat lag indicates that the user operations that require conflict resolution like creating a wallet will take longer. Heartbeat lags between any two nodes affect the operations

cluster wide. If the heartbeat lag is high, ensure that the cluster services are active and that replication is active. Disable and then re-enable the links between the two nodes between which the heartbeat lag is significant.

initial node

The first, or initial, [node](#) of an [Oracle Key Vault Multi-Master Cluster](#). You create a multi-master cluster by converting a single Oracle Key Vault server to become the initial node. The Oracle Key Vault server can be a clean installed Oracle Key Vault server, or it can already be in service with active data. A standalone server or a member of a primary-standby configuration can be converted to be the initial node of a cluster. If you want to use a member of a primary-standby configuration, then you must first break the primary-standby relationship splitting the pair.

If the initial node has been active and therefore has data, then Oracle Key Vault uses this data as the [cluster data set](#) to initialize the cluster.

Initialization can occur only once in the life of the cluster.

installation passphrase

A password that is specified during the Oracle Key Vault installation. The installation passphrase is used to log in to Oracle Key Vault and complete the post-installation tasks. The installation passphrase can only be changed on the Oracle Key Vault management console after installation but before post-installation. After you complete the post-installation process, this option no longer appears on the management console.

JAVA_HOME

The environment variable that points to the location of Java files (JDK/JRE) in the system. This allows Java applications to look up the `JAVA_HOME` variable in order to operate.

Java keystore file

A file that can hold multiple [security objects](#) such as keys and certificates. It uses the Java Keystore File (JKS) format.

Key Administrator

An Oracle Key Vault administrator role that enables a user to manage the key lifecycle and control access to all [security objects](#) within Oracle Key Vault. This is a highly sensitive role and should be granted with care.

keystore

A generalized term for a container that stores encryption keys including but not limited to TDE master encryption keys.

Management Information Base (MIB)

See [MIB](#).

master encryption key

See [TDE master encryption key](#).

maximum disable node duration

The time, in hours, that a node may remain in the disabled state. If the node has been disabled for a longer duration, it can no longer be enabled.

The default maximum disable node duration is 24 hours.

MIB

Management information base; a text file that, if Oracle Key Vault is monitored through SNMP, describes the variables that contain the information that SNMP can access. The variables described in a MIB, which are also called MIB objects, are the items that can be monitored using SNMP. There is one MIB for each element that is monitored.

name resolution time

A monitored metric used to determine the health of the multi-master cluster. It is the average time taken to ascertain that there is no name conflict in the cluster or to resolve the name conflict after an attempt to use conflicting names took place.

node

An Oracle Key Vault server that has been converted to be a member of an Oracle Key Vault multi-master cluster. It is known as an Oracle Key Vault cluster node or simply a node.

node induction

The process of converting an Oracle Key Vault server to be a node in the multi-master cluster.

The initial node in a cluster provides the initial [cluster data set](#). Subsequently, only new Oracle Key Vault servers can be inducted to the multi-master cluster, and the current data in the multi-master cluster is loaded into the new nodes.

OKV_HOME

The environment variable that points to the location in which the Oracle Key Vault [endpoint](#) software will reside. It contains sub-directories for endpoint software such as the

configuration files, log files, libraries, binaries, and other files that the endpoint software utility needs.

online master key

A TDE-generated master encryption key that is stored in Oracle Key Vault. The online master key enables Oracle Key Vault administrators to have full control over the TDE master encryption keys that Key Vault protects. When a key rotation is performed on the online master key, the change is reflected in all other [nodes](#) in a cluster. In previous releases, the term for online master key was TDE direct connection.

Opaque Object

A [security object](#) that Oracle Key Vault cannot interpret.

Oracle Key Vault appliance

See [appliance](#).

Oracle Key Vault multi-master cluster

A distributed set of Oracle Key Vault [nodes](#) that are grouped together so that they all communicate with one another. Some pairs of nodes are configured as [read-write pairs](#). In a read-write pair, an update to one node is replicated to the other node, and the update must be verified on the other node before the update is considered successful.

All nodes in the multi-master cluster connect to all other nodes. Data updated in a read-write pair is replicated to all nodes.

Oracle Key Vault node

See [node](#).

Oracle Key Vault server

An Oracle Key Vault server that is a standalone installation of the Oracle Key Vault appliance. It provides all the core functionality related to endpoints and wallets.

Oracle wallet file

A container that can hold multiple [security objects](#) such as keys and certificates. It uses the PKCS#12 cryptographic standard.

You can manage Oracle wallets in Oracle Key Vault just like other security objects. Optionally, you can encrypt them and protect them with a password. An Oracle wallet that can be accessed without a password is called an [auto-login wallet](#).

See also [password-protected wallet](#).

ORACLE_BASE

The environment variable that points to the root of the Oracle Database directory tree. The Oracle Base directory is the top level directory that you can use to install the various Oracle software products. You can use the same Oracle base directory for multiple installations. For example, `/u01/app/oracle` is an Oracle base directory created by the `oracle` user.

ORACLE_HOME

The environment variable that points to the directory path to install Oracle components (for example, `/u01/app/oracle/product/18.3.0/db_n`). You are prompted to enter an Oracle home in the **Path** field of the Specify File Locations window.

`ORACLE_HOME` corresponds to the environment in which Oracle Database products run. If you install an OFA-compliant database, using Oracle Universal Installer defaults, then the Oracle home (known as `$ORACLE_HOME` in this guide) is located beneath `$ORACLE_BASE`. The default Oracle home is `db_n` where `n` is the Oracle home number. It contains subdirectories for Oracle Database software executable files and network files.

ORACLE_SID

The environment variable that represents the Oracle System ID (SID), which uniquely identifies a particular database on a system. For this reason, you cannot have more than one database with the same SID on a computer system.

When using Oracle Real Application Clusters, you must ensure that all instances that belong to the same database have a unique SID.

oraenv

Along with `coraenv`, a Unix/ Linux command line utility that sets the required environment variables (`ORACLE_SID`, `ORACLE_HOME` and `PATH`) to allow a user to connect to a given database instance. If these environment variables are not set, then commands such as `sqlplus`, `imp`, `exp` will not work (or not be found).

Use `coraenv` when using the C Shell and `oraenv` when using a Bourne, Korn, or Bash shell.

password-protected wallet

An encrypted Oracle wallet that has a user-defined password stored in an `ewallet.p12` file.

PKCS#11 library

A library that allows an Oracle TDE database to connect to Oracle Key Vault to manage the master encryption keys.

PKCS#12 file

In cryptography, PKCS#12 defines an archive file format for storing many cryptographic objects as a single file. Wallet files are stored in PKCS#12 format.

read-only node

A [node](#) that is not part of a replication pair. Most data cannot be directly updated using the Oracle Key Vault management console, or with Oracle Key Vault client software. Critical data such as keys, wallets, and certificates in a read-only node is only updated through replication from [read-write nodes](#).

read-only restricted mode

A [node](#) enters read-only restricted mode when it has no [read-write pair](#), or if its [read-write peer](#) is unavailable. The Oracle Key Vault console displays a warning that the node is operating in read-only restricted mode. In read-only restricted mode, updates using the Oracle Key Vault management console, or Oracle Key Vault client software are restricted. However, you can still perform system configuration on the node.

When the node is a member of a [read-write pair](#), this indicates the other node has been disabled but not deleted from the cluster, or the heartbeat is not detected for other reasons.

read-write mode

A node is in read-write mode when it is available for endpoint and wallet data updates using the Oracle Key Vault management console, or Oracle Key Vault client software. The node must be a member of a [read-write pair](#), and the [read-write peer](#) must be online and active.

When both nodes in the pair are available, both nodes can accept updates, and all updates to one node are synchronously replicated to the peer. If one of the nodes in the pair becomes unavailable, then the remaining node enters [read-only restricted mode](#) and will not accept any data updates until the peer is restored.

The node state is displayed on the Monitoring page of the **Cluster** tab of the node management console. The **Cluster** tab of the node management console displays the type and status of all nodes in the cluster.

read-write node

An active, connected, member of a read-write pair of [nodes](#).

read-write pair

A pair of [nodes](#) that operates with bidirectional synchronous replication. You create the read-write pair by pairing a new node with a read-only node. You can update data, including the [endpoint](#) and wallet data, in either node by using the Oracle Key Vault management console, or Oracle Key Vault client software. The updates are replicated

immediately to the other node in the pair. Updates are replicated asynchronously to all other nodes.

A node can be a member of at most one bidirectional synchronous pair.

A multi-master cluster requires at least one [read-write pair](#) to be fully operational. It can have a maximum of 8 read-write pairs.

read-write peer

The specific member of one, and only one, [read-write pair](#) in the cluster. Each read-write pair consists of only two [nodes](#). You configure nodes as peers by setting **Add Candidate Node as Read-Write Peer** to **Yes** on the [controller node](#) during induction of the [candidate node](#). Peers are identified on the Cluster Management Configuration page.

If one member of the pair is deleted, then the peer automatically becomes a [read-only node](#).

recovery passphrase

A secret token that is created during the installation of an Oracle Key Vault [appliance](#). The recovery passphrase created for the [initial node](#) is subsequently used by the cluster and propagated to all other [nodes](#) in the cluster.

You enter the existing recovery passphrase on both the controller page and the candidate page during induction of any nodes into the cluster. Because there is only one recovery passphrase, you must use that same recovery passphrase when the recovery passphrase is required.

replication

The process of replicating data changes that were made to a [read-write node](#) to all other [nodes](#). The [read-write peer](#) is updated immediately. Replication is used to distribute the data to all other nodes in the cluster.

replication lag

A monitored metric that determines the health of the multi-master cluster. It is the time taken for an object to be replicated to another [node](#).

A higher replication lag indicates that the Oracle Key Vault operations like changing the access permissions for an [endpoint](#) on the wallet will take longer to replicate. Depending on the operation, a replication lag may or may not have a cluster-wide impact. If the replication lag is significant between two nodes, then you should disable and re-enable the cluster links.

security object

An object that contains critical data provided by the [user](#). A security object can be of the following types:

- private encryption key

- Oracle wallet
- Java keystore
- Java Cryptography Extension keystore
- certificate
- credential file

software appliance

A self-contained preconfigured product that can be installed on supported hardware dedicated for a specific purpose.

sqlnet.ora

An Oracle Database configuration file for the client or server. By default, the `sqlnet.ora` file resides in `$ORACLE_HOME/network/admin` directory. It specifies the following connection information:

- Client domain to append to unqualified service names or net service names
- Order of naming methods for the client to use when resolving a name
- Logging and tracing features to use
- Route of connections
- External naming parameters
- Oracle Advanced Security parameters

System Administrator

An Oracle Key Vault administrator role that enables a user to create [users](#), [endpoints](#) and their respective groups, configure system settings and alerts, and generally administer Oracle Key Vault. This is a highly sensitive role and should be granted with care.

TDE master encryption key

A key that encrypts the data encryption keys for tables and tablespaces.

template

A collection of attributes for [security objects](#). When a security object is created using a template, then the attributes in the template are automatically assigned to the new object.

user

A staff member who uses Oracle Key Vault. Users can be administrators, auditors, or ordinary users with no administrative roles.

user group

A named collection of Oracle Key Vault [users](#). A user group can collectively be granted privileges or roles.

virtual wallet

A container for [security objects](#) such as public and private encryption keys, TDE master encryption keys, passwords, credentials, and certificates in Oracle Key Vault. The main purpose of a virtual wallet is to enable sharing of keys among [endpoints](#).

Index

A

- about managing, [8-20](#)
- access control, [2-3](#)
 - access grants for virtual wallets, [2-4](#)
 - how configuration works, [2-3](#)
- access control options, [2-4](#)
- access grants, [2-4](#)
- adding user to user group, [8-23](#)
- administration users
 - multi-masters clusters effect on, [8-4](#)
- administrative roles
 - about, [2-6](#)
 - about managing, [8-8](#)
 - Audit Manager
 - about, [2-8](#)
 - granting or changing, [8-8](#)
 - Key Administrator
 - about, [2-8](#)
 - revoking, [8-13](#)
 - separation of duty, [2-5](#)
 - System Administrator
 - about, [2-7](#)
- alerts, [1-11](#)
 - about, [19-17](#)
 - configuring, [19-24](#)
 - types of, [19-17](#)
 - viewing open alerts, [19-26](#)
- architecture, [3-3](#)
- archiving
 - credential files, [15-1](#)
- Audit Manager
 - about, [2-8](#)
- Audit Manager role
 - multi-master cluster effect on, [8-3](#)
- audit trail contents, [19-29](#)
- auditing
 - about, [19-29](#)
 - audit trail contents, [19-29](#)
 - deleting audit records, [19-31](#)
 - exporting audit records to file, [19-31](#)
 - setting for cluster, [16-26](#)
 - setting for node, [16-21](#)
 - syslog file, [19-30](#)
 - viewing audit records, [19-31](#)

- Automatic Storage Management
 - uploading keystores
 - about, [14-9](#)
 - copying keystore to, [14-11](#)
 - procedure, [14-9](#)

B

- backing up data
 - about, [18-1](#)
 - best practices, [18-15](#)
 - changing schedule, [18-10](#)
 - deleting schedule, [18-10](#)
 - multi-master cluster environment, [18-11](#)
 - primary-standby deployment, [18-10](#)
 - recovery passphrase, [18-11](#)
 - scheduling backup, [18-9](#)
- backup destinations
 - about, [18-2](#)
 - changing settings, [18-5](#)
 - creating remote, [18-3](#)
 - deleting remote, [18-6](#)
- backup scheduling, [18-8](#)
 - about, [18-7](#)
 - types, [18-7](#)
- backups
 - console certificates, [17-10](#)
 - protecting with recovery passphrase, [18-11](#)
 - reports, [19-42](#)
 - types, [18-7](#)
- benefits
 - centralizing key lifecycle management, [1-2](#)
 - centralizing key storage, [1-2](#)
 - fighting security threats, [1-2](#)

C

- C SDK, [1-16](#)
- candidate nodes, [3-10](#)
- centralized storage
 - Java keystores, [1-4](#)
 - Oracle wallet files, [1-4](#)
- centralized storage and management of security objects, [1-10](#)
- centrally managed passwords, [15-6](#)

- certificates
 - rotating, about, [17-1](#)
 - rotating, procedure, [17-4](#)
 - rotation, checking overall status, [17-6](#)
 - rotation, checking status for endpoints, [17-6](#)
 - certificates, [17-8](#)
 - post-rotation tasks, [17-7](#)
 - rotating, advice, [17-2](#)
 - rotating, factors that may affect process, [17-3](#)
 - See also console certificates
 - changepwd command (okvutil), [B-3](#)
 - changing a user group description, [8-24](#)
 - Classic mode network interface
 - checking status of, [16-5](#)
 - cluster node types
 - about, [3-6](#)
 - cluster nodes
 - about, [3-4](#)
 - limitation, [3-4](#)
 - cluster size and availability guidance, [3-14](#)
 - cluster subgroups
 - about, [3-5](#)
 - clusters
 - creating first node, [4-2](#)
 - deleting a node, [4-10](#)
 - disabling a node, [4-9](#)
 - disabling node replication, [4-11](#)
 - enabling a node, [4-9](#)
 - enabling node replication, [4-11](#)
 - force deleting a node, [4-10](#)
 - management information, [3-20](#), [4-12](#)
 - monitoring information, [4-13](#)
 - read-only, creating, [4-6](#)
 - read-write pair of nodes, creating, [4-4](#)
 - read-write pairs of nodes, creating, [4-7](#)
 - restarting cluster services, [4-11](#)
 - setting up, about, [4-2](#)
 - terminating node pairing, [4-8](#)
 - Commercial National Security Algorithm (CNSA)
 - about, [16-32](#)
 - backup and restore operations, [16-34](#)
 - running scripts, [16-33](#)
 - upgrading primary-standby Oracle Key Vault servers, [16-36](#)
 - upgrading standalone Oracle Key Vault server, [16-34](#)
 - configuration files
 - endpoint configuration file, [13-11](#)
 - configuration parameters
 - endpoints, [12-15](#)
 - setting for individual endpoints, [12-18](#)
 - setting globally for individual endpoints, [12-16](#)
 - configuring a primary-standby deployment, [5-2](#)
 - conflicts in names of objects, [4-15](#)
 - console certificates, [17-8](#)
 - about managing, [17-8](#)
 - backup data restored, [17-10](#)
 - downloading CA request, [17-8](#)
 - having signed, [17-9](#)
 - primary-standby environments, [17-10](#)
 - RESTful services, [17-10](#)
 - uploading, [17-10](#)
 - controller nodes
 - about, [3-9](#)
 - Create Endpoint Group privilege
 - endpoint privileges
 - separation of duty, [2-5](#)
 - granting or changing, [8-11](#)
 - separation of duty, [2-5](#)
 - Create Endpoint privilege
 - about, [2-9](#)
 - granting or changing, [8-10](#)
 - separation of duty, [2-5](#)
 - creating a user group, [8-21](#)
 - creating user accounts, [8-5](#)
 - credential files
 - about archiving and downloading, [15-1](#)
 - change to content guidance, [15-3](#)
 - downloading
 - guidance, [15-3](#)
 - procedure, [15-3](#)
 - overwriting danger of, [15-3](#)
 - sharing with multiple endpoints guidance, [15-3](#)
 - uploading
 - guidance, [15-3](#)
 - procedure, [15-2](#)
 - credentials
 - guidance for SQL*Plus, [15-4](#)
 - guidance for SSH, [15-5](#)
 - critical data, [3-5](#)
- ## D
-
- dashboard
 - status panes, [16-3](#)
 - viewing, [16-2](#)
 - data
 - backing up, about, [18-1](#)
 - restoring, about, [18-1](#)
 - Database as a Service
 - about configuring for Key Vault, [7-2](#)
 - configuring instance, [7-2](#)
 - creating low privileged user, [7-3](#)
 - deleting SSH tunnel, [7-11](#)
 - disabling SSH tunnel, [7-9](#)
 - enrolling instance as endpoint
 - about, [7-12](#)

Database as a Service (*continued*)

- enrolling instance as endpoint (*continued*)
- installing Oracle Key Vault software onto, [7-15](#)
- post-installation tasks, [7-17](#)
- preparing environment, [7-15](#)
- registering, [7-13](#)
- resuming access to Oracle Key Vault, [7-21](#)
- reverse SSH tunnel in multi-master cluster, [7-8](#)
- reverse SSH tunnel in primary-standby configuration, [7-8](#)
- SSH tunnel between Oracle Key Vault and DBaaS instance, [7-5](#)
- SSH tunnel not active, [7-11](#)
- suspending access to Oracle Key Vault
 - about, [7-18](#)
 - procedure, [7-19](#)
- users
 - low privileged user for DBaaS, [7-3](#)
 - viewing SSH tunnel details, [7-9](#)

deleting user accounts, [8-7](#)

deleting user groups, [8-25](#)

deployment

- architecture, [2-2](#)
- overview, [1-17](#)

deployment scenarios

- cluster size and availability, [3-14](#)
- mid-size cluster, [3-15](#)
- two data centers, [3-15](#)
- two nodes, [3-14](#)

deployments

- credential files, archiving and downloading, [15-1](#)
- Java keystores, uploading and downloading, [11-20](#)
- JKS and JCEKS keystores, archiving and downloading, [11-23](#)
- migrating standalone Key Vault server to multi-master cluster, [3-12](#)
- online master keys for TDE wallets, [1-5](#)
- Oracle wallets, uploading and downloading, [11-20](#)
- primary-standby to multi-master cluster, [3-13](#)
- recommendations for, [4-17](#)

diagnostic reports, [19-14](#)

- about, [19-14](#)
- generating file, [19-16](#)
- installing generation utility, [19-15](#)
- removing diagnostic generation utility, [19-16](#)
- removing temp files, [19-16](#)

diagnostics

- accessing with okvutil diagnostics, [B-3](#)

diagnostics generation utility

- transaction check error, [C-4](#)

DNS

- configuring NTP servers for non-multi-master clusters, [16-7](#)
- nodes, [16-17](#)

DNS settings

- multi-master clusters, [16-24](#)

download command (okvutil), [B-4](#)

downloading

- credential files, [15-3](#)
- JKS and JCEKS keystores, [11-23](#), [11-24](#)
- wallets, [11-21](#)

downtime, minimizing, [16-37](#)

Dual NIC mode network interface

- checking status of, [16-5](#)

dual NIC network mode

- changing for nodes, [16-19](#)
- changing for standalone environment, [16-10](#)

E

effective group membership, LDAP users, [9-1](#)

email addresses

- changing, [8-19](#)
- disabling email notifications, [8-19](#)

email notification

- about, [19-10](#)
- configuring, [19-10](#)
- disabling, [19-13](#)
- testing, [19-12](#)

emergency system recovery, [2-15](#)

endpoint administrators

- about, [2-16](#)

endpoint groups, [12-24](#)

- access grant to virtual wallet, [12-27](#)
- adding endpoint too, [12-28](#)
- creating, [12-24](#)
- deleting, [12-30](#)
- modifying details, [12-26](#)
- modifying virtual wallets from Keys & Wallets tab, [10-9](#)
- multi-master clusters, effect on, [12-24](#)
- naming guidelines, [2-14](#)
- removing access to virtual wallets from Keys & Wallets tab, [10-8](#)
- removing endpoint, [12-29](#)

endpoint node scan lists

- about, [3-19](#)

endpoint privileges

- about managing, [8-8](#)

endpoint self-enrollment, about, [12-3](#)

endpoints, [12-24](#)

- about, [12-10](#)
- about managing, [12-1](#)
- adding access to virtual wallet, [12-21](#)
- adding to an endpoint group, [12-28](#)

- endpoints (*continued*)
 - adding using administrator-initiated enrollment, [12-5](#)
 - adding using self-enrollment, [12-9](#)
 - adding using self-enrollment, about, [12-9](#)
 - adding using self-enrollment, procedure for, [12-9](#)
 - administrators for, [12-1](#)
 - alternative for individual, [12-11](#)
 - associating default wallet with, [12-18](#)
 - configuration file, [13-11](#)
 - configuration parameters, about, [12-15](#)
 - DBaaS
 - enrolling, [7-12](#)
 - registering, [7-12](#)
 - default wallet, setting for, [12-19](#)
 - deleting, [12-10](#), [12-11](#)
 - details
 - about, [12-14](#)
 - configuration parameters, about, [12-15](#)
 - modifying, [12-14](#)
 - diagnostics, [B-3](#)
 - downloading software, [13-3](#)
 - endpoint node scan lists, [3-19](#)
 - enrolling and provisioning, [13-3](#)
 - enrollment
 - about, [13-1](#)
 - administrator initiated, about, [12-3](#)
 - types of enrollment, [12-3](#)
 - enrollment in multi-master cluster, [12-4](#)
 - enrollment process
 - about, [13-1](#)
 - enrollment types, [12-3](#)
 - guidance on enrolling across deployments, [3-15](#)
 - installing software for new enrollment, [13-5](#)
 - Java home, how determined, [13-8](#)
 - limitations of TDE endpoint integration, [11-12](#)
 - modifying virtual wallets from Keys & Wallets tab, [10-9](#)
 - multi-master clusters, effect on, [12-3](#)
 - naming guidelines, [2-14](#)
 - nodes available for connection, [3-19](#)
 - not using Oracle Key Vault client software, [13-10](#)
 - okvclient.ora file, [13-11](#)
 - okvutil utility for provisioning, [B-1](#)
 - one or more endpoints, [12-11](#)
 - Oracle Cloud Infrastructure database instance
 - about, [7-1](#)
 - password, changing, [B-3](#)
 - post-installation for new enrollment, [13-7](#)
- endpoints (*continued*)
 - preparing environment for new enrollment, [13-5](#)
 - privileges for managing, [2-9](#)
 - provisioning
 - about, [13-1](#)
 - reenrolling, [12-13](#)
 - removing access to virtual wallets from Keys & Wallets tab, [10-8](#)
 - removing from an endpoint group, [12-29](#)
 - reports, [19-40](#)
 - revoking access to virtual wallet, [12-22](#)
 - setting configuration parameters globally, [12-16](#)
 - setting configuration parameters individually, [12-18](#)
 - suspending, [12-12](#)
 - TDE endpoint management, [13-10](#)
 - upgrading for enrolled, [13-17](#)
 - upgrading for unenrolled
 - downloading Oracle Key Vault okvclient.jar software, [13-13](#)
 - installing Oracle Key Vault okvclient.jar software, [13-14](#)
 - post-installation tasks, [13-15](#)
 - preparing environment, [13-13](#)
 - upgrading from unenrolled endpoint, [13-12](#)
 - wallet items, viewing, [12-23](#)
 - See also endpoint groups
- enrolling endpoints
 - about, [13-1](#)
 - administrator initiated
 - about, [12-3](#)
 - self-initiated
 - about, [12-3](#)
- environment variables
 - JAVA_HOME, how determined during client installation, [13-8](#)
 - OKV_HOME
 - non-database utilities, [13-9](#)
 - set during installation, [13-9](#)
 - okvclient.ora location of, [13-9](#)
 - persistent master encryption key cache, [11-3](#)
 - sqlnet.ora file, [13-10](#)
- Error
 - Object is Unstorable in Container error, [B-4](#)
- EXPIRE PKCS11 PERSISTENT CACHE ON DATABASE SHUTDOWN parameter, [11-8](#)
- external keystore password uploads
 - about, [15-6](#)
- external keystore password uploads to large deployments, [15-6](#)
 - changing passwords, [15-12](#)
 - example script for using passwords, [15-9](#)

external keystore password uploads to large deployments (continued)
 sharing secrets, [15-10](#)

F

failover situations
 read-only restricted mode, [C-6](#)

failovers
 restoring primary-standby after, [5-10](#)

FIPS 140–2, [2-16](#)

FIPS mode, [2-16](#)
 disabling, [16-18](#)
 disabling for non-multi-master clusters, [16-9](#)
 enabling, [16-18](#)
 enabling for non-multi-master clusters, [16-9](#)

FIPS-Inside
 See FIPS mode

G

granting access to objects or users, [2-4](#)

I

initial node
 creating, [4-2](#)
 creation of, [3-8](#)

interfaces, [1-15](#)
 C client, [1-16](#)
 Java client, [1-16](#)
 management console, [1-16](#)
 okvutil endpoint utility, [1-16](#)
 RESTful services, [1-16](#)

J

Java keystores
 downloading, [B-4](#)
 uploading, [B-8](#)

Java SDK, [1-16](#)

JAVA_HOME environment variable
 how determined during client installation,
[13-8](#)
 location determined during installation, [13-8](#)

JKS and JCEKS keystores
 downloading
 JKS and JCEKS keystores, [11-23](#)
 procedure, [11-24](#)
 uploading
 procedure, [11-23](#)

JKS and JCKS keystores
 change to content guidance, [11-25](#)
 downloading
 guidance, [11-25](#)

JCKS and JCKS keystores (*continued*)
 overwriting danger of, [11-25](#)
 sharing with multiple endpoints guidance,
[11-25](#)
 uploading
 guidance, [11-25](#)

K

Kerberos keytabs
 downloading, [B-4](#)

Key Administrator role
 about, [2-8](#)
 multi-master cluster effect on, [8-3](#)

key lifecycle management, [1-11](#)

key management reports for Oracle endpoints,
[19-38](#)

key rotation, [1-5](#)

keys
 activating, [10-13](#)
 deactivating, [10-13](#)
 deleting, [10-14](#)
 finding for Key Vault, [B-6](#)
 multi-master clusters, effect on, [10-12](#)
 reports, [19-39](#)
 revoking, [10-13](#)
 state of, managing, [10-12](#)

keystores
 Automatic Storage Management
 about uploading from, [14-9](#)
 copying keystore to, [14-11](#)
 procedure for uploading from, [14-9](#)

KMIP Protocol, [1-13](#)

L

LDAP configuration, [9-1](#)
 about, [9-1](#)
 about logging in as LDAP user, [9-7](#)
 creating the provider connection, [9-4](#)
 deleting, [9-10](#)
 disabling, [9-10](#)
 enabling, [9-8](#)
 LDAP directory server preparation tasks, [9-4](#)
 logging in as LDAP user, [9-7](#)
 mapping LDAP groups to Oracle Key Vault
 user groups, [9-6](#)
 modifying, [9-9](#)
 privilege grants for LDAP users, [9-3](#)
 testing, [9-10](#)

LDAP groups
 about, [9-11](#)
 creating group mappings, [9-12](#)
 deleting mapping, [9-14](#)
 modifying group mappings, [9-13](#)

LDAP groups (*continued*)
 validating group mappings, [9-14](#)

LDAP users
 about, [9-15](#)
 about validation, [9-16](#)
 effective group membership, [9-1](#)
 finding information about, [9-15](#)
 modifying by regular users who have
 manage wallet privileges, [9-18](#)
 modifying using Key Administrator role, [9-17](#)
 modifying, about, [9-17](#)
 removing from Oracle Key Vault, [9-18](#)
 validating, [9-16](#)

list command (okvutil), [B-6](#)

local backup destinations
 about, [18-2](#)

log file locations, [C-2](#)

logging in
 as LDAP user, [9-7](#)
 as LDAP user, about, [9-7](#)

M

Manage Endpoint Group privilege
 about, [2-11](#), [2-13](#)
 endpoint privileges
 separation of duty, [2-5](#)
 granting or changing, [8-11](#)
 revoking, [8-13](#)
 separation of duty, [2-5](#)

Manage Endpoint privilege
 about, [2-10](#)
 granting or changing, [8-10](#)
 revoking, [8-13](#)
 separation of duty, [2-5](#)

management console
 about, [1-15](#), [1-16](#)

Management Information Base (MIB) variables,
[19-6](#)

master encryption keys
 persistent master encryption key cache,
[1-12](#), [11-3](#)
 TDE,
 See persistent master encryption key cache
 user-defined key as, [11-26](#)

maximum disable node duration
 multi-master clusters, [16-25](#)

Microsoft Active Directory
 See LDAP configuration

migration
 directory permissions, [C-2](#)

monitoring
 diagnostic reports, [19-14](#)
 email notification, [19-10](#)
 remote monitoring, [19-2](#)

monitoring (*continued*)
 reports, [19-37](#)
 SNMP, [19-2](#)
 syslog configuration, [19-13](#)

monitoring information for clusters, [4-13](#)

multi-master cluster configuration
 Oracle Audit Vault integration, [19-36](#)

multi-master clusters, [3-3](#)
 about managing, [4-2](#)
 addition of new server to cluster, [3-10](#)
 addition of nodes, [3-10](#)
 administration users, effect on, [8-4](#)
 Audit Manager role, affect on, [8-3](#)
 auditing for cluster
 setting, [16-26](#)
 auditing for individual nodes
 setting, [16-21](#)
 backup and restore operations, [18-1](#)
 benefits, [3-2](#)
 building and managing, about, [3-7](#)
 candidate node, [3-10](#)
 changing recovery passphrase, [16-29](#)
 cluster node, [3-4](#)
 cluster subgroups, [3-5](#)
 controller node, [3-9](#)
 critical data, [3-5](#)
 difference from primary-standby
 configuration, [5-4](#)

DNS for individual nodes
 configuring, [16-17](#)

DNS settings, [16-24](#)

downtime, minimizing, [16-37](#)

effect on role management, [8-8](#)

endpoint enrollment, [12-4](#)

endpoint groups, effect on, [12-24](#)

endpoints, [12-4](#)

endpoints, effect on, [12-3](#)

expansion of
 about, [3-9](#)
 addition of more nodes, [3-10](#)
 controller node, [3-9](#)

FIPS mode for individual nodes, setting,
[16-18](#)

host name network setting for individual
 nodes, [16-16](#)

inconsistency resolution, [3-19](#)

initial node, [3-8](#)

Key Administrator role, effect on, [8-3](#)

keys, effect on, [10-12](#)

maximum disable node duration, [16-25](#)

mid-size cluster, [3-15](#)

migrating standalone Key Vault server to,
[3-12](#)

mode types, [3-6](#)

multi-master clusters (*continued*)

- multi-master clusters
 - expansion of
 - candidate nodes, [3-10](#)
 - name conflict resolution, [3-19](#)
 - network services for individual nodes, [16-16](#)
 - node limitations, [3-4](#)
 - operations permitted on nodes, [3-7](#)
 - Oracle Key Vault management console,
 - setting timeout, [16-27](#)
 - overview, [3-1](#)
 - primary-standby to multi-master cluster, [3-13](#)
 - read-only mode, [3-6](#)
 - read-only node, [3-6](#)
 - read-only restricted mode, [3-6](#)
 - read-write mode, [3-6](#)
 - read-write node, [3-6](#)
 - reconfiguration changes, [3-9](#)
 - RESTful services enablement, [16-26](#)
 - restore operations, [18-13](#)
 - reverse SSH tunnels, [7-8](#)
 - security objects, effect on, [10-12](#)
 - size and availability, [3-14](#)
 - SNMP settings, [16-26](#)
 - SNMP settings for individual node, [16-22](#)
 - syslog destination
 - clearing, [19-14](#)
 - setting, [19-13](#)
 - syslog settings, [16-25](#)
 - syslog settings, node, [16-19](#)
 - System Administrator role, effect on, [8-3](#)
 - system settings, [16-14](#)
 - system settings for individual nodes, [16-15](#)
 - system time for cluster
 - setting, [16-24](#)
 - system time for individual nodes
 - setting, [16-17](#)
 - system users, effect on, [8-4](#)
 - two data centers, [3-15](#)
 - two nodes, [3-14](#)
 - user accounts, effect on, [8-2](#)
 - user groups, changing description, [8-24](#)
 - user groups, creating in, [8-21](#)
 - user groups, deleting, [8-25](#)
 - user groups, effect on, [8-21](#)
 - user groups, removing users from, [8-24](#)
 - user groups, renaming, [8-24](#)
 - users, effect on, [8-4](#)
 - virtual wallet user access to, [8-12](#)
- MySQL integration with Oracle Key Vault, [14-11](#)

N

naming conflicts
about, [4-15](#)

naming conflicts (*continued*)

- accepting suggested name, [4-16](#)
- changing suggested name, [4-16](#)
- finding, [4-15](#)

network details

- configuring for non-multi-master clusters, [16-5](#)

network interface

- checking status of, [16-5](#)

network services

- configuring for non-multi-master clusters, [16-6](#)

nodes

- creating first node, [4-2](#)
- deleting, [4-10](#)
- disabling, [4-9](#)
- disabling replication, [4-11](#)
- enabling, [4-9](#)
- enabling replication, [4-11](#)
- force deleting, [4-10](#)
- restarting cluster services for, [4-11](#)
- terminating pairing of, [4-8](#)

NTP servers

- configuring DNS for non-multi-master clusters, [16-7](#)

O

OASIS Key Management Interoperability Protocol (KMIP)

- Oracle Key Vault implementation of, [1-13](#)

objects

- naming guidelines, [2-14](#)

OKV_HOME environment variable

- non-database utilities, [13-9](#)

okvclient.jar

- downloading for installation on endpoint, [13-3](#)

okvclient.ora file

- about, [13-11](#)

okvutil utility, [1-15](#), [1-16](#)

- about, [1-15](#), [1-16](#)
- changepwd command, [B-3](#)
- diagnostics command, [B-3](#)
- download command, [B-4](#)
- list command, [B-6](#)
- syntax, [B-1](#)
- upload command, [B-8](#)
- used to manage endpoints, [B-1](#)

online master keys, [1-5](#)

- about using with Oracle Key Vault, [1-5](#)
- centralized management of TDE keys, [1-5](#)
- Oracle Data Guard connection, [14-6](#)
- Oracle GoldenGate, [14-3](#)

operations, restrictions and conditions of, [A-1](#)

options for access control, [2-4](#)

- Oracle Active Data Guard
 - support for data moves, [14-12](#)
- Oracle Audit Vault
 - checking monitoring for multi-master cluster node, [16-22](#)
 - checking monitoring for non-multi-master clusters, [16-13](#)
- Oracle Audit Vault integration
 - checking environment, [19-32](#)
 - deleting integration, [19-35](#)
 - integration steps, [19-33](#)
 - multi-master cluster integration, [19-36](#)
 - primary-standby integration, [19-36](#)
 - resuming monitoring operation, [19-35](#)
 - suspending monitoring operation, [19-35](#)
 - viewing collected audit data, [19-34](#)
- Oracle Cloud Infrastructure database instance
 - endpoints
 - about, [7-1](#)
- Oracle Data Guard
 - migrating Oracle wallets, [14-6](#)
 - online master keys connection, [14-6](#)
 - reverse migrating wallets, [14-7](#)
 - uploading wallets to Oracle Key Vault, [14-5](#)
- Oracle Data Pump support for data moves, [14-12](#)
- Oracle GoldenGate
 - online master keys with
 - about, [14-3](#)
 - TDE wallet migration
 - about, [14-3](#)
 - wallets used with, [14-2](#)
- Oracle Key Vault
 - administering cluster environments, [16-14](#)
 - benefits, [1-2](#)
 - deployment architecture, [2-2](#)
 - deployment overview, [1-17](#)
 - key management, about, [1-1](#)
 - standards and protocols, [1-13](#)
 - who should use, [1-8](#)
- Oracle Key Vault client
 - C SDK, [1-16](#)
 - Java SDK, [1-16](#)
- Oracle Key Vault client software
 - endpoints not using, [13-10](#)
- Oracle Key Vault compute instance
 - about, [6-1](#)
 - about provisioning, [6-3](#)
 - benefits, [6-2](#)
 - finding image, [6-4](#)
 - launching process, [6-5](#)
 - launching, about, [6-4](#)
 - migrating data out of compute instance, [6-10](#)
 - migrations, about, [6-9](#)
 - post-installation tasks, [6-5](#)
 - post-launch tasks, [6-5](#)
- Oracle Key Vault compute instance (*continued*)
 - prerequisites, [6-4](#)
 - restarting, [6-7](#)
 - starting, [6-7](#)
 - stopping, [6-7](#)
 - system settings, [6-7](#)
 - terminating, [6-8](#)
 - transitioning data into a compute instance, [6-9](#)
- Oracle Key Vault compute instances
 - backup operations, [6-8](#)
 - restore operations, [6-8](#)
- Oracle Key Vault concepts, [2-1](#)
- Oracle Key Vault endpoint utility, [1-15](#), [1-16](#)
 - about, [1-15](#), [1-16](#)
 - See also [okvutil](#) utility
- Oracle Key Vault features
 - ASM cluster file system encryption key management, [1-14](#)
 - audit and monitoring services, external support for, [1-14](#)
 - backup and restore support for security objects, [1-12](#)
 - centralized storage and management of security objects, [1-10](#), [1-13](#)
 - database release and platform support, [1-13](#)
 - DBaaS endpoint support, [1-14](#)
 - HSM integration, [1-14](#)
 - key lifecycle management, [1-11](#)
 - MySQL integration, [1-14](#)
 - persistent master encryption key cache, [1-12](#)
 - primary-standby environment support, [1-15](#), [16-31](#)
 - reporting and alerts, [1-11](#)
 - RESTful service support, [1-13](#)
 - separation of duties, [1-11](#)
- Oracle Key Vault general system administration
 - about, [16-2](#)
- Oracle Key Vault interfaces, [1-15](#), [1-16](#)
 - management console, [1-16](#)
 - RESTful services, [1-16](#)
- Oracle Key Vault keys
 - finding, [B-6](#)
- Oracle Key Vault maintenance
 - dashboard, [16-2](#)
 - system settings, [16-15](#)
- Oracle Key Vault management console
 - about, [1-15](#)
 - timeout for multi-master cluster nodes, [16-27](#)
 - timeout for Web sessions for non-multi-master clusters, [16-13](#)
- Oracle Key Vault Multi-Master Cluster, [A-1](#)
- Oracle Key Vault state
 - viewing, [16-2](#)
- Oracle Key Vault use cases, [1-4](#)

Oracle Real Application Clusters
 support for data moves, [14-12](#)
 wallets, [14-1](#)

Oracle Recovery Manager (RMAN) support for
 data moves, [14-12](#)

Oracle wallets
 downloading
 about, [11-20](#)
 uploading
 about, [11-20](#)

P

passphrases, [16-28](#)
 changing in clusters environment, [16-29](#)
 changing in non-clusters environment, [16-28](#)
 recovering credentials, [16-28](#)
 recovering system, [16-28](#)
See also passwords

passwords, [16-28](#)
 about changing, [8-14](#), [8-15](#)
 centrally managed, [15-6](#)
 changing endpoint password, [B-3](#)
 changing password automatically, [8-16](#)
 changing password manually, [8-16](#)
 changing support user, [8-17](#)
 changing your own, [8-15](#)
 controlling manual password reset
 operations, about, [8-18](#)
 controlling manual password reset
 operations, configuration, [8-19](#)
See also passphrases

persistent master encryption key cache, [11-2](#)
 about, [11-2](#)
 architecture, [11-2](#)
 caching master encryption keys in-memory, [11-3](#)
 contents of, listing, [11-9](#)
 environment variables, importance of setting, [11-3](#)
 modes of operation
 first mode, [11-4](#)
 Oracle Key Vault first mode, [11-4](#)

Oracle Database deployments, [11-11](#)

PEXPIRE PKCS11 PERSISTENT CACHE ON
 DATABASE SHUTDOWN parameter, [11-8](#)

PKCS11_CACHE_TIMEOUT parameter, [11-6](#)

PKCS11_CONFIG_PARAM_REFRESH_INTERVAL
 parameter, [11-7](#)

PKCS11_PERSISTENT_CACHE_FIRST parameter,
[11-7](#)

PKCS11_PERSISTENT_CACHE_REFRESH_WINDOW
 parameter, [11-8](#)

PKCS11_PERSISTENT_CACHE_TIMEOUT parameter,
[11-6](#)

refresh window, [11-5](#)
 storage location, [11-3](#)

PKCS11_CACHE_TIMEOUT parameter, [11-6](#)

PKCS11_CONFIG_PARAM_REFRESH_INTERV
 AL parameter, [11-7](#)

PKCS11_PERSISTENT_CACHE_FIRST
 parameter, [11-7](#)

PKCS11_PERSISTENT_CACHE_REFRESH_WI
 NDOW parameter, [11-8](#)

PKCS11_PERSISTENT_CACHE_TIMEOUT
 parameter, [11-6](#)

powering off Oracle Key Vault for non-multi-
 master clusters, [16-14](#)

powering off Oracle Key Vault nodes, [16-23](#)

primary servers
 role in primary-standby configuration, [5-4](#)

primary-standby
 restore operations, [18-14](#)

primary-standby configuration
 about, [5-2](#)
 benefits, [5-3](#)
 best practices, [5-20](#)
 changing SNMP settings on standby server,
[19-4](#)

checking TDE wallet migration for logical
 standby, [14-8](#)

configuring primary server, [5-5](#)
 configuring standby server, [5-6](#)
 difference from multi-master clusters, [5-4](#)
 disabling, [5-11](#)
 downtime, minimizing, [16-37](#)
 enabling primary-standby on primary, [5-8](#)
 migrating TDE wallets to Oracle Key Vault for
 standby, [14-8](#)

Oracle Audit Vault integration, [19-36](#)

persistent master encryption key cache
 downtime, minimizing, [16-37](#)

primary server
 configuring, [5-5](#)
 enabling for primary-standby, [5-8](#)

primary server role, [5-4](#)

read-only restricted mode
 downtime, minimizing, [16-37](#)

read-only restricted mode disabled, [5-14](#)

read-only restricted mode enabled, [5-14](#)

read-only restricted mode impact, [5-13](#)

read-only restricted mode state during
 network failure, [5-17](#)

read-only restricted mode state during
 primary server failure, [5-16](#)

read-only restricted mode state during
 standby server failure, [5-17](#)

read-only restricted mode states, [5-15](#)

read-only restricted mode, disabling, [5-18](#)

read-only restricted mode, enabling, [5-17](#)

read-only restricted mode, recovering from,
[5-19](#)

primary-standby configuration (*continued*)
 restoring primary-standby after, [5-10](#)
 reverse SSH tunnels, [7-8](#)
 standby server
 configuring, [5-6](#)
 standby server role, [5-5](#)
 switching servers, [5-9](#)
 unpairing, [5-11](#)
 primary-standby environments
 console certificates, [17-10](#)
 primary-standby server
 moving to multi-master cluster, [3-13](#)
 privileges, [2-3](#)
 access control options, [2-4](#)
 access grants for virtual wallets, [2-4](#)
 See also access control

R

read-only mode
 about, [3-6](#)
 read-only nodes
 about, [3-6](#)
 creating, [4-6](#)
 read-only restricted mode
 about, [3-6](#)
 disabling, [5-18](#)
 enabling, [5-17](#)
 failover, planned shutdown in standby server,
 [C-8](#), [C-10](#)
 failover, planned shutdown of primary server
 during upgrade, [C-7](#), [C-10](#)
 failover, planned shutdown on primary server
 during maintenance, [C-7](#), [C-10](#)
 failover, unplanned shutdown in primary
 server, [C-8](#), [C-11](#)
 failover, unplanned shutdown in standby
 server, [C-9](#), [C-11](#)
 notifications, [5-20](#)
 primary-standby configuration with read-only
 restricted mode enabled, [5-14](#)
 primary-standby configuration without read-
 only restricted mode enabled, [5-14](#)
 primary-standby configuration, impact on,
 [5-13](#)
 recovering primary-standby, [5-19](#)
 read-only restricted mode states
 network failure in primary-standby
 configuration, [5-17](#)
 primary server failure, [5-16](#)
 primary-standby configuration, [5-15](#)
 standby server failure, [5-17](#)
 read-write mode
 about, [3-6](#)

read-write nodes
 about, [3-6](#)
 read-write pair of nodes
 creating, [4-4](#)
 read-write pairs of nodes
 creating additional, [4-7](#)
 rebooting Oracle Key Vault for non-multi-master
 clusters, [16-14](#)
 rebooting Oracle Key Vault nodes, [16-23](#)
 recovery passphrase
 about recovering, [16-28](#)
 changing in clusters environment, [16-29](#)
 changing in non-clusters environment, [16-28](#)
 protecting the backup, [18-11](#)
 recovering credentials, [16-28](#)
 rekey operation, [1-5](#)
 remote backup destination
 about, [18-2](#)
 remote backup destinations
 changing settings, [18-5](#)
 creating, [18-3](#)
 deleting, [18-6](#)
 remote monitoring
 about, [19-2](#)
 changing settings on standby server, [19-4](#)
 changing user name and password, [19-4](#)
 granting SNMP access to users, [19-3](#)
 remotely monitoring using SNMP, [19-5](#)
 removing user from a user group, [8-24](#)
 renaming a user group, [8-24](#)
 reporting, [1-11](#)
 reports
 about, [19-37](#)
 endpoint reports, [19-40](#)
 key management reports for Oracle
 endpoints reports, [19-38](#)
 keys reports, [19-39](#)
 notification report, [19-42](#)
 secrets reports, [19-39](#)
 system reports, [19-42](#)
 user reports, [19-41](#)
 wallets reports, [19-39](#)
 restarting Oracle Key Vault for non-multi-master
 clusters, [16-14](#)
 restarting Oracle Key Vault nodes, [16-23](#)
 RESTful command-line interface commands
 reports, [19-42](#)
 RESTful services
 about, [1-16](#)
 console certificates, [17-10](#)
 disabling for non-multi-master clusters, [16-12](#)
 enabling for non-multi-master clusters, [16-12](#)
 multi-master clusters, enablement, [16-26](#)
 restoring data
 about, [18-12](#)

restoring data (*continued*)
 best practices, [18-15](#)
 multi-master clusters, [18-13](#)
 primary-standby deployment, [18-14](#)
 procedure, [18-12](#)
 system state after, [18-14](#)
 third-party certificates, [18-14](#)

roles
 about, [2-6](#)

root user
 about, [2-15](#)

Roots of Trust (RoT), [1-14](#)

S

secrets
 guidance for SQL*Plus, [15-4](#)
 guidance for SSH, [15-5](#)
 reports, [19-39](#)

secure user management, [8-18](#)

security objects
 activating, [10-13](#)
 adding to virtual wallets, [10-5](#)
 deactivating, [10-13](#)
 deleting, [10-14](#)
 details of, about, [10-14](#)
 downloading to different types, [B-4](#)
 modifying details of, [10-19](#)
 multi-master clusters, effect on, [10-12](#)
 removing from virtual wallets, [10-6](#)
 revoking, [10-13](#)
 searching for object items, [10-15](#)
 state of, managing, [10-12](#)
 viewing details of, [10-16](#)
 virtual wallets, creating for, [10-2](#)
 virtual wallets, modifying, [10-4](#)

self-enrollment, for endpoints, [12-9](#)

separation of duties, [1-11](#)
 how Oracle Key Vault manages, [2-5](#)
 users, [8-1](#)

SNMP
 about, [19-2](#)
 changing settings on standby server, [19-4](#)
 changing user name and password, [19-4](#)
 example of simplified remote monitoring, [19-7](#)
 granting access to user, [19-3](#)
 Management Information Base (MIB)
 variables, [19-6](#)
 remotely monitoring Oracle Key Vault, [19-5](#)

SNMP settings
 multi-master clusters, [16-26](#)
 nodes, [16-22](#)

split-brain scenarios, [5-2](#)

SQL*Plus
 guidance for credentials, [15-4](#)
 guidance for secrets, [15-4](#)

sqlnet.ora file
 environment variables and, [13-10](#)

SSH
 guidance for credentials, [15-5](#)
 guidance for secrets, [15-5](#)

SSH key files
 downloading from Key Vault to a wallet, [B-4](#)

SSH tunnels
 creating between Oracle Key Vault and DBaaS instance, [7-5](#)
 deleting, [7-11](#)
 disabling, [7-9](#)
 multi-master clusters, [7-9](#), [7-11](#)
 not active, [7-11](#)
 reverse SSH tunnel in multi-master cluster, [7-8](#)
 reverse SSH tunnel in primary-standby configuration, [7-8](#)
 viewing details, [7-9](#)

standby servers
 role in primary-standby configuration, [5-5](#)

support user
 about, [2-15](#)

syslog
 configuring for non-multi-master clusters, [16-10](#)

syslog configuration
 audit records, [19-30](#)
 destination
 clearing, [19-14](#)
 setting, [19-13](#)

syslog settings
 multi-master cluster node, [16-19](#)
 multi-master clusters, [16-25](#)

System Administrator role
 about, [2-7](#)
 multi-master cluster effect on, [8-3](#)

system diagnostics
 See diagnostic reports

system recovery, [2-15](#), [16-28](#)

system time
 setting for non-multi-master clusters, [16-7](#)

system users
 multi-master cluster effect on, [8-4](#)

T

TDE direct connect
 See online master keys

TDE master encryption keys
 centralized management, [1-5](#)

TDE wallets
 Oracle GoldenGate, [14-3](#)

TDE-enabled databases, [11-12](#)
 about configuring Key Vault for, [11-12](#)
 configuring environment for, [11-13](#)
 integrating TDE with Key Vault, [11-15](#)
 limitations of TDE endpoint integration, [11-12](#)

third-party certificates
 restoring data, [18-14](#)

time
 setting for cluster, [16-24](#)
 setting for node, [16-17](#)
 setting for non-multi-master clusters, [16-7](#)

Transparent Data Encryption, [11-12](#)
 downtime, minimizing for TDE heartbeat,
[16-37](#)
 endpoint management, [13-10](#)
See also TDE-enabled databases

transportable tablespaces support for data
 moves, [14-12](#)

troubleshooting
 finding log files, [C-2](#)
 upgrade errors, [C-3](#)
 uploading Java keystores, [C-2](#)
 uploading keystores with same file name but
 different contents, [C-3](#)
 uploading the same Oracle wallet multiple
 times, [C-3](#)

types of backups, [18-7](#)

U

upgrades
 error handling, [C-3](#)

upgrading endpoint software
 unenrolled endpoint, [13-12](#)

upload command (okvutil), [B-8](#)

uploading
 credential files, [15-2](#)
 JKS and JCEKS keystores, [11-23](#)
 wallet to Oracle RAC, [14-1](#)
 wallets, [11-20](#)

use cases, [1-4](#)
 centralized storage, [1-4](#)
 key rotation, [1-5](#)
 online management of keys and secret data,
[1-8](#)
 storage of credential files, [1-7](#)

user accounts
 multi-master clusters, effect on, [8-2](#)

user groups, [8-20](#)
 adding a user, [8-23](#)
 changing description, [8-24](#)
 creating, [8-21](#)
 deleting, [8-25](#)

user groups (*continued*)
 granting access to virtual wallet, [8-23](#)
 modifying virtual wallets from Keys & Wallets
 tab, [10-9](#)
 multi-master clusters, effect on, [8-21](#)
 naming guidelines, [2-14](#)
 removing access to virtual wallets from Keys
 & Wallets tab, [10-8](#)
 removing access to virtual wallets from
 User's tab, [10-11](#)
 removing user from, [8-24](#)
 renaming, [8-24](#)
 revoking access to virtual wallets, [10-11](#)

user-defined keys
 about, [11-26](#)
 activating, [11-28](#)
 uploading to Oracle Key Vault, [11-26](#)

users, [8-20](#)
 about changing password, [8-15](#)
 about user accounts, [8-1](#)
 administrative roles, about, [8-8](#)
 administrative roles, granting or changing,
[8-8](#)
 administrative roles, revoking, [8-13](#)
 changing own password, [8-15](#)
 changing password automatically, [8-16](#)
 changing password manually, [8-16](#)
 changing passwords, about, [8-14](#)
 changing support user password, [8-17](#)
 changing user email address, [8-19](#)
 controlling manual password reset
 operations, about, [8-18](#)
 controlling manual password reset
 operations, configuration, [8-19](#)
 Create Endpoint Group privilege, granting or
 changing, [8-11](#)
 Create Endpoint privilege, granting or
 changing, [8-10](#)
 creating accounts, [8-5](#)
 deleting accounts, [8-7](#)
 disabling email notifications, [8-19](#)
 endpoint administrators
 about, [2-16](#)
 endpoint privileges, about, [8-8](#)
 endpoint privileges, revoking, [8-13](#)
 granting access to virtual wallet, [8-12](#)
 Manage Endpoint Group privilege, granting
 or changing, [8-11](#)
 Manage Endpoint privilege, granting or
 changing, [8-10](#)
 modifying virtual wallets from Keys & Wallets
 tab, [10-9](#)
 multi-master cluster effect on, [8-4](#)
 naming guidelines, [2-14](#)

users (*continued*)

- removing access to virtual wallets from Keys & Wallets tab, [10-8](#)
- removing access to virtual wallets from User's tab, [10-10](#)
- reports, [19-41](#)
- root user
 - about, [2-15](#)
- support user
 - about, [2-15](#)
- view account details, [8-7](#)
 - See *also* user groups

V

viewing user account details, [8-7](#)

virtual wallets

- about, [10-2](#)
- access management from Keys and Wallets tab, [10-7](#)
- adding endpoint access to, [12-21](#)
- adding security objects to, [10-5](#)
- creating, [10-2](#)
- deleting, [10-6](#)
- endpoint group access grant, [12-27](#)
- granting access to from Keys & Wallets tab, [10-8](#)
- granting access to from Users tab, [10-10](#)
- granting user access to, [8-12](#), [8-23](#)
- granting user group access to from User's tab, [10-11](#)
- modifying, [10-4](#)
- modifying from Keys & Wallets tab, [10-9](#)
- naming guidelines, [2-14](#)
- removing security objects from, [10-6](#)
- removing user access to from Users tab, [10-10](#)
- revoking endpoint access, [12-22](#)
- revoking user group access from, [10-11](#)

W

wallets

- checking TDE wallet migration for logical standby
 - about, [14-8](#)
- downloading
 - guidance, [11-22](#)
 - procedure, [11-21](#)
- downloading from Key Vault to a wallet, [B-4](#)
- endpoint group access grant, [12-27](#)
- endpoints, associating, [12-18](#)
- endpoints, viewing wallet items for, [12-23](#)
- key rotation guidance, [11-22](#)
- migrating existing TDE wallet to Key Vault
 - about, [11-16](#)
 - procedure, [11-17](#)
- migrating TDE to Key Vault for logical standby database
 - about, [14-8](#)
- migrating to Oracle Data Guard, [14-6](#)
- Oracle GoldenGate use with, [14-2](#)
- Oracle Real Application Clusters environment, [14-1](#)
- overwriting danger of, [11-22](#)
- reports, [19-39](#)
- restoring database contents previously encrypted by TDE
 - about, [11-19](#)
- reverse migrating in Oracle Data Guard
 - about, [14-7](#)
- setting default for endpoint, [12-19](#)
- sharing with multiple endpoints guidance, [11-22](#)
- uploading
 - guidance, [11-22](#)
 - procedure, [11-20](#)
- uploading contents to Key Vault server, [B-8](#)
- uploading in Oracle Data Guard
 - about, [14-5](#)
 - procedure, [14-5](#)