

Messaging User Guide

# **Oracle Banking Payments**

Release 14.5.4.0.0

**Part No. F56734-01**

April 2022

Messaging User Guide  
Oracle Financial Services Software Limited

Oracle Park

Off Western Express Highway  
Goregaon (East)  
Mumbai, Maharashtra 400 063  
India

Worldwide Inquiries:

Phone: +91 22 6718 3000

Fax: +91 22 6718 3001

[www.oracle.com/financialservices/](http://www.oracle.com/financialservices/)

Copyright © 2017, 2022, Oracle and/or its affiliates. All rights reserved.

Oracle and Java are registered trademarks of Oracle and/or its affiliates. Other names may be trademarks of their respective owners.

U.S. GOVERNMENT END USERS: Oracle programs, including any operating system, integrated software, any programs installed on the hardware, and/or documentation, delivered to U.S. Government end users are “commercial computer software” pursuant to the applicable Federal Acquisition Regulation and agency-specific supplemental regulations. As such, use, duplication, disclosure, modification, and adaptation of the programs, including any operating system, integrated software, any programs installed on the hardware, and/or documentation, shall be subject to license terms and license restrictions applicable to the programs. No other rights are granted to the U.S. Government.

This software or hardware is developed for general use in a variety of information management applications. It is not developed or intended for use in any inherently dangerous applications, including applications that may create a risk of personal injury. If you use this software or hardware in dangerous applications, then you shall be responsible to take all appropriate failsafe, backup, redundancy, and other measures to ensure its safe use. Oracle Corporation and its affiliates disclaim any liability for any damages caused by use of this software or hardware in dangerous applications.

This software and related documentation are provided under a license agreement containing restrictions on use and disclosure and are protected by intellectual property laws. Except as expressly permitted in your license agreement or allowed by law, you may not use, copy, reproduce, translate, broadcast, modify, license, transmit, distribute, exhibit, perform, publish or display any part, in any form, or by any means. Reverse engineering, disassembly, or decompilation of this software, unless required by law for interoperability, is prohibited.

The information contained herein is subject to change without notice and is not warranted to be error-free. If you find any errors, please report them to us in writing.

This software or hardware and documentation may provide access to or information on content, products and services from third parties. Oracle Corporation and its affiliates are not responsible for and expressly disclaim all warranties of any kind with respect to third-party content, products, and services. Oracle Corporation and its affiliates will not be responsible for any loss, costs, or damages incurred due to your access to or use of third-party content, products, or services.

---

# Contents

<b>1. About this Manual .....</b>	<b>1-1</b>
1.1 Introduction.....	1-1
1.2 Audience.....	1-1
1.3 Documentation Accessibility.....	1-1
1.4 Organization .....	1-1
1.5 Glossary of Icons.....	1-2
<b>2. Messaging .....</b>	<b>2-1</b>
2.1 Message Flow Diagrams.....	2-1
2.2 Key Features of Messaging.....	2-3
2.2.1 Rule Parameter .....	2-3
2.2.2 Rule Definition .....	2-3
2.2.3 Rule Group .....	2-4
2.2.4 Rule Priority.....	2-4
2.3 Basic Maintenance for File Exchange.....	2-4
2.3.1 Invoking Distinguished Name Definition Screen.....	2-4
2.3.2 Viewing Distinguished Name Summary .....	2-5
2.3.3 Invoking SWIFTNet Service Definition Screen.....	2-7
2.3.4 Viewing SWIFTNet Service Summary.....	2-8
2.3.5 Invoking Protocol Parameter Definition Screen.....	2-9
2.3.6 Viewing Protocol Parameter Definition Summary.....	2-11
2.3.7 Invoking Rule Definition Screen .....	2-12
2.3.8 Viewing Rule Definition Summary .....	2-14
2.3.9 Invoking Rule Group Definition Screen .....	2-15
2.3.10 Viewing Rule Group Summary .....	2-16
2.3.11 Invoking Rule Group Mapping Screen.....	2-17
2.3.12 Viewing Rule Group Mapping Summary .....	2-18
2.4 Bulking and De-bulking of SWIFT MT Messages.....	2-19
2.4.1 Invoking Bulk Preference Definition Screen .....	2-19
2.4.2 Viewing Bulking Preference Definition Summary .....	2-22
2.4.3 Viewing Debulk Rule Summary.....	2-23
2.4.4 Invoking Bulker Monitor Screen.....	2-24
2.4.5 Bulk Monitor Summary .....	2-26
2.4.6 Invoking Outgoing Message Browser Screen .....	2-26
2.4.7 Viewing Outgoing Message Browser Summary .....	2-29
2.4.8 Invoking Incoming Message Browser Screen .....	2-31
2.4.9 Viewing Incoming Message Browser Summary .....	2-33
2.5 File Transmission over SWIFTNet.....	2-35
2.5.1 Invoking File Transfer Adapter Connector Configuration .....	2-35
2.5.2 Invoking Connectivity Operation Manager Screen .....	2-38
2.5.3 Invoking Outbound File Browser Screen .....	2-39
2.5.4 Invoking Inbound File Browser Screen.....	2-41
2.5.5 Connector Network Linkage Maintenance.....	2-42
2.5.6 Connector File Type Linkage Maintenance .....	2-43
2.5.7 Fedwire Message Mapping .....	2-45

2.5.8	<i>Fedwire Message Mapping Summary</i> .....	2-46
2.5.9	<i>SWIFT Message Notifications</i> .....	2-47
2.6	SWIFT LAU .....	2-47
2.6.1	<i>Invoking SWIFT LAU Key Maintenance Screen</i> .....	2-48
2.6.2	<i>Viewing SWIFT LAU Key Summary</i> .....	2-49
2.6.3	<i>Detailed Processing Logic for Incoming SWIFT LAU</i> .....	2-50
2.7	SWIFT Message Routing Parameter via block chain network .....	2-51
2.7.1	<i>SWIFT Message Routing Parameter Detailed</i> .....	2-51
2.7.2	<i>Smart Contract Transaction Summary</i> .....	2-53
2.8	SWIFT FIN Header Configuration .....	2-54
2.8.1	<i>SWIFT FIN Header Preference</i> .....	2-54
2.8.2	<i>SWIFT FIN Header Host Preference</i> .....	2-56
2.8.3	<i>SWIFT FIN Header Processing</i> .....	2-57
<b>3.</b>	<b>Function ID Glossary</b> .....	<b>3-1</b>

---

# 1. About this Manual

## 1.1 Introduction

This manual is designed to help you to quickly get familiar with the messaging functionalities of Oracle Banking Payments in addition to the electronic messaging support available as part of Common-Core. It takes you through the various stages in Messaging functionality.

You can further obtain information specific to a particular field by placing the cursor on the relevant field and striking <F1> on the keyboard.

## 1.2 Audience

This manual is intended for the following User/User Roles:

Role	Function
Payment Department Operators	Messaging functions Input functions except Authorization.
Back Office Payment Department Operators	Messaging monitoring maintenances/Payment Transaction Input functions except Authorization
Payment Department Officers	Messaging monitoring and authorization
Bank's Financial Controller/ Payment Department Manager	Host level processing related setup for PM module and PM Query functions

## 1.3 Documentation Accessibility

For information about Oracle's commitment to accessibility, visit the Oracle Accessibility Program website at <http://www.oracle.com/pls/topic/lookup?ctx=acc&id=docacc>.



## 1.4 Organization

This manual is organized into the following chapters.:

Chapter	Description
Chapter 1	<i>About this Manual</i> gives information on the intended audience. It also lists the various chapters covered in this User Manual.
Chapter 2	<i>Messaging</i> provides information on Messaging functionality in Oracle Banking Payments.
Chapter 3	<i>Function ID Glossary</i> has alphabetical listing of Function/Screen ID's used in the module with page references for quick navigation.

## 1.5 Glossary of Icons

This User Manual may refer to all or some of the following icons:

Icons	Function
	Exit
	Add row
	Delete row
	Option List

## 2. Messaging

This document details bulker, de-bulker, router and the SWIFTNet connectivity framework to be built in the Oracle Banking Payments to send the bulked files to the SWIFTNet network through SAG with the File Act protocol.

The files are bulked and stored on Application server. The file from Application server will be transmitted to SWIFT over FTA.'

The system technically bulk MT messages and routes them to configured destination.

The system transmits and receives bulked files from SWIFT Network using SAG interface, through the FTA (Folder) connector.

This chapter contains the following sections:

- [Section 1, "Section 2.7, "SWIFT Message Routing Parameter Maintenance"](#)
- [Section 2.2, "Key Features of Messaging"](#)
- [Section 2.3, "Basic Maintenance for File Exchange"](#)
- [Section 2.4, "Bulking and De-bulking of SWIFT MT Messages"](#)
- [Section 2.5, "File Transmission over SWIFTNet"](#)
- [Section 2.6, "SWIFT LAU"](#)
- [Section 2.7, "SWIFT Message Routing Parameter Maintenance"](#)

### 2.1 Message Flow Diagrams

The below flow diagram depicts the flow of outgoing message:

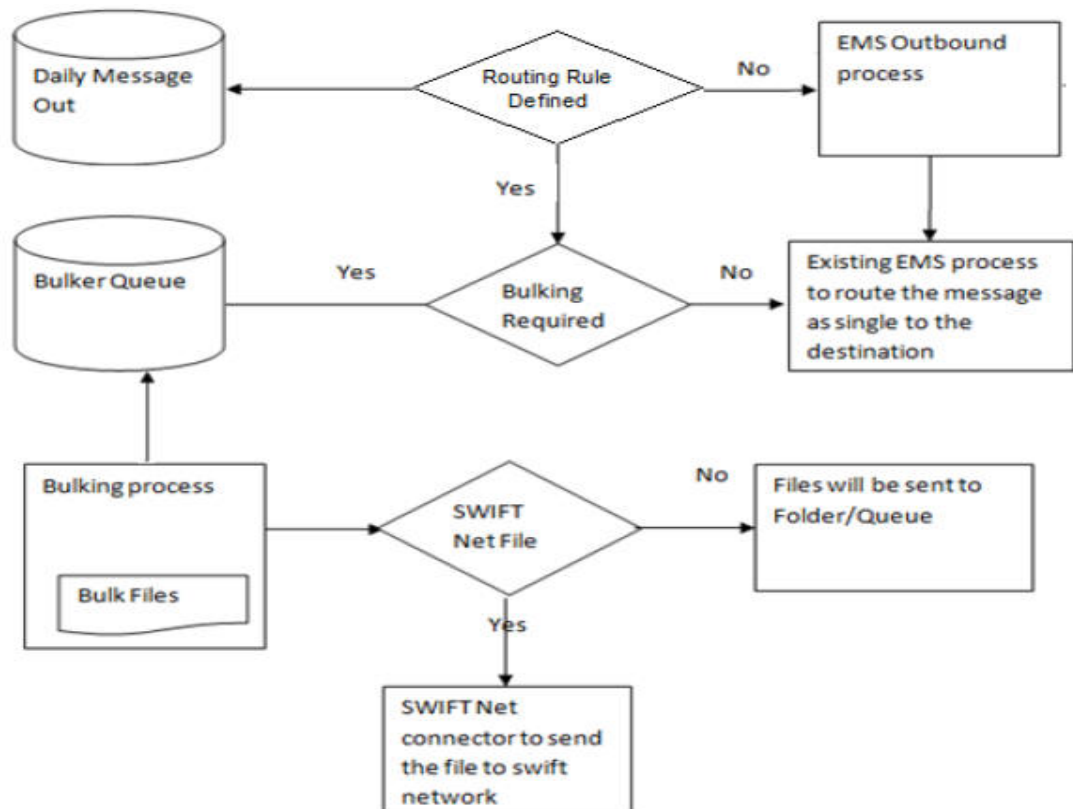

The below diagram depicts the flow of incoming message:

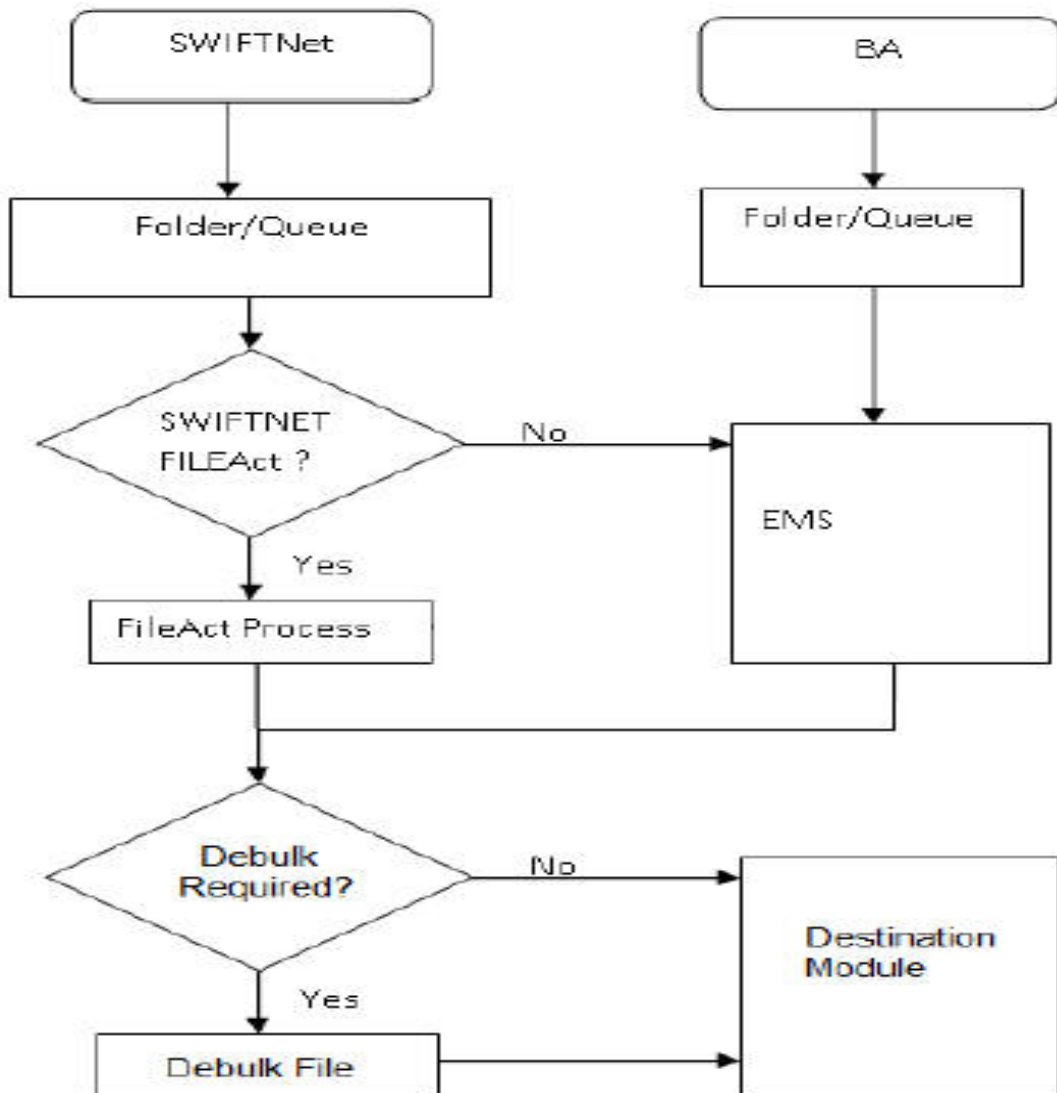

The below diagram depicts the flow diagram of data exchange with SWIFTNet.

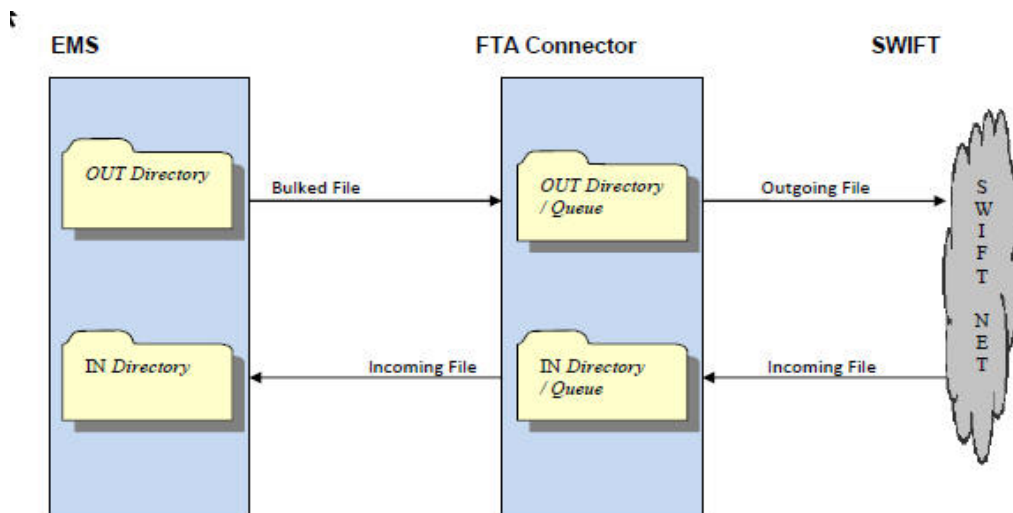



## 2.2 Key Features of Messaging

Routing rules are defined for each module. Using these routing rules the messages are sent to the mapped destinations. To achieve this multiple maintenances are introduced.

- Rule definition – This screen is used to define the rule and respective destination.
- Rule Group – This maintenance is used to map the modules to different rule groups.
- Rule Priority – This maintenance is used to prioritise the rules.

The following functionalities are developed to support the routing of messages to different destinations.

### 2.2.1 Rule Parameter

Rule parameters are part of day zero set up. There is no user interface to maintain this.

The following set of standard rule parameters is used for all types of rule definition-

- Amount
- Currency
- Media
- Network Code
- Sender BIC
- Receiver BIC
- Message Type
- Module Name

### 2.2.2 Rule Definition

Rule configuration maintenance is provided to define the rule and to map it to a specific destination. Standard set of parameters are available while defining a rule. You can also provide values manually for evaluating the rules. On the same screen an option is provided to map a rule to its destination. Each rule must belong to a rule group.

Messaging provides a router implementation which evaluates configured rules and identifies the destination for a message dynamically. The routing capabilities in messaging include the ability to define/modify rule configurations based on a set of pre-defined routing parameters. These parameters are stored in the Database and for each routing configuration; the values for these routing parameters are calculated at runtime, thus enabling dynamic routing configuration.

Destination for any message is mapped on the rule definition screen. This is done by specifying the rules which unambiguously lead to the selection of a single destination to be used for outward transmission of data from messaging.

Routing configuration supports routing based on the messaging standard parameters.

Routing rules can be mapped to the following entities in the system.

- Connectivity Lines
- Bulker
- De-bulker
- Folder
- Queue

### **2.2.3 Rule Group**

You can group one or more modules into different groups. Based on the rule groups a module is associated with, mapped rules are executed to identify the qualifying rule definition and thus destination for any message.

Each module can belong to only one rule group to avoid ambiguous results.

The modules for which routing rules should be used for identifying the destination is added to a default rule group as part of day zero script.

When a message is received from a modules that is not a part of any rule group, the existing EMS flow is considered to identify its destination.

### **2.2.4 Rule Priority**

You can provide priority of rules belonging to a rule group. Based on this priority, rules are executed to identify the qualifying rule definition and thus destination for any message. First rule that matches the message properties is used to identify the destination for that message.

## **2.3 Basic Maintenance for File Exchange**

A message is routed to the specific SWIFT connector, bulker, folder or queue if they meet certain user-defined criteria.

Routing Rules are defined for each module. Using these routing rules, the messages are sent to the mapped destinations. To achieve this, the following maintenances are introduced:

- Rule Definition - Used for defining rules and respective definitions.
- Rule Group - Used for mapping modules to different groups
- Rule Priority - Used for prioritizing rules

### **2.3.1 Invoking Distinguished Name Definition Screen**

The Distinguished Name (DN) serves to uniquely identify any entity that sends or receives messages over SWIFTNet.

Distinguished name follow an X.500-compliant naming convention. Refer the SWIFTNet Naming and Address Guide from SWIFT for more details.

You can invoke 'Distinguished Name Definition' screen by typing MSDDSTNM" in the field at the top right corner of the Application tool bar and clicking on the adjoining arrow button...

The screenshot shows a software window titled "Distinguished Name Definition". The window has a menu bar with "New" and "Enter Query". The main area contains three input fields: "Distinguished Name ID \*", "Distinguished Name \*", and "Description". At the bottom, there is a status bar with fields for "Maker", "Date Time:", "Mod No", "Record Status", "Checker", "Date Time:", "Authorization Status", and an "Exit" button.

You can specify the following fields:

**Distinguished Name ID**

Specify the unique identification of the distinguished name.

**Distinguished Name**

Specify the distinguished name to identify the entity that sends or gets messages.

**Description**

Specify the description of the distinguished name.

### 2.3.2 Viewing Distinguished Name Summary

This summary screen is used to view the distinguished name serves. It includes the information about the various distinguished names and the description.



### 2.3.3 Invoking SWIFTNet Service Definition Screen

This screen is used to capture SWIFTNet service details.

SWIFT Net service should be a valid SWIFT Net service to which the bank has registered to send the message.

When the message is sent through the File Act, the service name attribute is sent with the envelope.

This service name defined from this screen gets listed in the protocol parameters to choose the service name, which is used for constructing the envelope to send to SWIFT Net.

You can invoke 'SWIFTNet Service Definition' screen by typing 'MSDSWTSR' in the field at the top right corner of the Application tool bar and clicking on the adjoining arrow button...

The screenshot shows the 'SWIFTNet Service Definition' application window. At the top, there is a title bar with 'SWIFTNet Service Definition' and window control buttons. Below the title bar is a menu bar with 'New' and 'Enter Query'. The main area contains a form titled 'SwiftNet service Definition'. It has a 'Service Name\*' field with a red asterisk indicating it is required. Below this is a 'Service Mode' section with two radio buttons: 'Real Time(RT)' (which is selected) and 'Store And Forward(SnF)'. There are two table-like sections: 'Requestor DN Details' and 'Responder DN Details'. Each section has a 'Go' button and navigation icons. At the bottom of the window, there are several fields: 'Maker', 'Checker', 'Date Time:', 'Mod No', 'Record Status', and 'Authorization Status'. An 'Exit' button is located in the bottom right corner.

You can specify the following fields:

#### **Service Name**

Specify the SWIFTnet Service name.

#### **Service Mode**

Select any one of the service modes.

- Real Time- Choose this button to send and receive messages real-time.

- Store and Forward - Choose this button to send and receive messages by storing them in a location and then forwarding them accordingly.

---

**Note**

Real Time option is selected by default.

---

**Requestor DN**

Specify the DN that send request to the service.

---

**Note**

You must provide at least one DN.

---

**Responder DN**

Specify the DN that responds request to the service.

---

**Note**

You must provide at least one DN.

---

### **2.3.4 Viewing SWIFTNet Service Summary**

This summary screen is used to display SWIFTNet service details.

You can invoke “SWIFTNet Service Summary” screen by typing ‘MSSSWTSR’ in the field at the top right corner of the Application tool bar and clicking on the adjoining arrow button.

SwiftNet Service Definition Summary

Search Advanced Search Reset Clear All

Case Sensitive

Authorization Status  Record Status

Service Name

Records per page 15 1 Of 1 Go Lock Columns 0

Authorization Status	Record Status	Service Name
----------------------	---------------	--------------

Exit

You can search using one or more of the following parameters:

- Service Name
- Authorization Status
- Record Status

Once you have specified the search parameters, click ‘Search’ button. The system displays the records that match the search criteria for the following

- Service Name
- Authorization Status
- Record Status

### 2.3.5 Invoking Protocol Parameter Definition Screen

This screen is used to capture protocol parameters for FTA protocol used to connect to SWIFT Net. These are additional SWIFTNet connectivity attributes, which are required for SWIFTNet file transfer and communication with SWIFT Network.

You can invoke 'Protocol Parameter Definition' screen by typing 'MSDPTPRM' in the field at the top right corner of the Application tool bar and clicking on the adjoining arrow button...

Protocol Parameter Definition

Save

Protocol Parameter Name \*

Description

Protocol Type FTA

Overlapping Parameter Set

Parameter *	Value
-------------	-------

Maker Date Time: Mod No Record Status  
Checker Date Time: Authorization Status

Cancel

You can specify the following fields:

### **Protocol Parameter Name**

Specify the name of the Protocol Parameter.

### **Description**

Specify the description of the Protocol Parameter set.

### **Protocol Type**

Select the Protocol Type from the drop-down values listed. Select the name of the protocol for which parameter list is defined.

### **Overlapping Parameter Set**

#### **Parameters**

Specify the parameters for the protocol. Click on '+' button to add new parameters.

---

#### **Note**

- Compression of outbound file is done based on the parameter defined in this field. The parameter is set as 'COMPRESSIONALGOPROP' and value is set as 'GZIP'.
- For the outbound files sent, FTA connector, compresses the file using GZIP and handsoff the zipped file in destination folder.
- For the inbound files received, the zipped files with extension 'gz' are unzipped and handed off to payments.

---

#### **Value**

Specify the value of the parameter.



## 2.3.6 Viewing Protocol Parameter Definition Summary

This summary screen is used to display protocol parameters captured for FTA.

You can invoke “Protocol Parameter Definition Summary” screen by typing ‘MSSPTPRM’ in the field at the top right corner of the Application tool bar and clicking on the adjoining arrow button.

The screenshot shows a web application window titled "Protocol Parameter Definition Summary". At the top, there are search options: "Search", "Advanced Search", "Reset", and "Clear All". Below this is a "Case Sensitive" section with two dropdown menus: "Authorization Status" and "Record Status". A text input field for "Protocol Parameter Name" is also present. The main area is a table with the following columns: "Authorization Status", "Record Status", "Protocol Parameter Name", "Description", and "Protocol Type". The table is currently empty. At the bottom right of the table area, there is an "Exit" button.

You can search using one or more of the following parameters:

- Protocol Parameter Name
- Authorization Status
- Record Status

Once you have specified the search parameters, click 'Search' button. The system displays the records that match the search criteria for the following

- Protocol Parameter Name
- Description
- Authorization Status
- Record Status

## 2.3.7 Invoking Rule Definition Screen

Rule Definition screen will be provided in EMS module to capture the Rule details.

You can invoke 'Rule Definition' screen by typing 'MSDRLDFN' in the field at the top right corner of the Application tool bar and clicking on the adjoining arrow button.

The screenshot shows the 'Routing Rule Definition' application window. The window title is 'Routing Rule Definition'. It features a menu bar with 'New' and 'Enter Query'. The main area is divided into three sections: 'Rule Details', 'Destination Details', and 'Expression Details'. 'Rule Details' has fields for 'Rule Name \*' and 'Rule Description'. 'Destination Details' has fields for 'Destination Type \*' (a dropdown menu showing 'Folder'), 'Folder Path', 'Queue Jndi Name', 'Protocol Type' (a dropdown menu), 'Protocol Name', 'SwiftNet Connectivity', and 'Bulk Rule Name'. 'Expression Details' has a toolbar with navigation arrows, '1 Of 1', and a 'Go' button. Below the toolbar is a table with columns: 'Expression Section', 'Scope', 'LOP Type', 'LOP Data Type', 'Left Operand', 'Operator', and 'ROF'. The table is currently empty.

You can specify the following fields:

### **Rule Name**

Specify the unique rule name.

### **Description**

Enter a brief description of the rule name.

### **Destination Type**

Specify the type of destination to which the messages matching the rule criteria is being sent. Select any of the options given below:

- SWIFT connector
- Bulker
- Folder
- Queue

### **Folder Path**

Specify the folder path if the destination is folder.

**Queue JNDI Name**

Specify the name of JNDI Queue. This is mandatory if the destination type is Queue.

**Protocol Type**

Specify the type of Protocol.

**Protocol Name**

Specify the required protocol for the selected protocol.

**SWIFTNet Connectivity**

Specify the name of the connector if the destination type is SWIFTNet.

**Bulk Rule Name**

Select the required bulk rule name.

**Expression Section**

Specify the value of the parameter.

**Scope**

Specify the value of the parameter.

**Left Operand Type**

Specify the value of the parameter. The type can be constant, parameter or expression.

**Left Operand Data Type**

Specify the value of the parameter. The value can be string, date, boolean or number.

**Left Operand**

Specify the value of the parameter. If left operator is parameter values from the static table is populated, if its constant then any constant can be selected or expression is build if its a expression.

**Operator**

Specify the value of the parameter like equal to, less than and so on.

**Right Operand Type**

Specify the value of the parameter.

**Right Operand Data Type**

Specify the value of the parameter.

**Right Operand**

Specify the value of the parameter.

**Scope**

Specify the value of the parameter.

**Logical Operators**

Specify the value of the parameter.

**Pre Defined Functions**

Specify the value of the parameter.

**Parameter Name**

Specify the value of the parameter.

**Parameter Value**

Specify the value of the parameter.

### Parameter Type

Specify the value of the parameter.

### Expression For

Specify the value of the parameter.

### Final Expression

Specifies the final expression built for the rule.

### Build Expression

Specifies the final expression built for the rule.

## 2.3.8 Viewing Rule Definition Summary

You can invoke “Rule Definition Summary” screen by typing ‘MSSRLDFN’ in the field at the top right corner of the Application tool bar and clicking on the adjoining arrow button.

The screenshot shows a web application window titled "Routing Rule Definition Summary". At the top, there is a search bar with options for "Search", "Advanced Search", "Reset", and "Clear All". Below this is a "Case Sensitive" section with several input fields: "Authorization Status" (a dropdown menu), "Record Status" (a dropdown menu), "Rule Name" (a text input field with a search icon), "Rule Description" (a text input field with a search icon), "Rule Group Name" (a text input field with a search icon), and "Destination Type" (a dropdown menu). Below the search fields is a control bar with "Records per page" set to 15, navigation arrows, "1 Of 1", a "Go" button, and "Lock Columns" set to 0. The main area is a table with the following columns: "Authorization Status", "Record Status", "Rule Name", "Rule Description", "Rule Group Name", and "Destination Type". The table is currently empty. At the bottom right corner of the window, there is an "Exit" button.

You can search using one or more of the following parameters:

- Authorization Status
- Record Status

- Rule Name
- Rule Description
- Rule Group Name
- Destination Name

Once you have specified the search parameters, click 'Search' button. The system displays the records that match the search criteria for the following

- Authorization Status
- Record Status
- Rule Name
- Rule Description
- Rule Group Name
- Destination Type

### 2.3.9 Invoking Rule Group Definition Screen

Rule Group Definition screen is provided to capture the Rule group details. A logical grouping of the routing rules can be done using this group name.

Populate Rules button populates all the routing rules defined which can be moved or swapped.

On click of 'populate rules' all the rules marked for the group are listed and priority of which can be changed.

From the populated list select a rule priority for swapping and enter another priority visible on search result in Move to/Swap to field to swap the selected rule priority with the priority entered.

From the populated list select a priority for moving and enter another priority visible on search result in Move to/Swap to field to move the selected rule priority with the priority entered.

You can invoke 'Rule Group Definition' screen by typing 'MSDRLGRP' in the field at the top right corner of the Application tool bar and clicking on the adjoining arrow button.

The screenshot shows the 'Rule Group Definition' application window. At the top, there is a search bar labeled 'Enter Query'. Below it are two input fields: 'Rule Group Name \*' and 'Description'. A table with columns 'Rule Name', 'Rule Description', and 'Priority' is displayed, showing '1 Of 1' records. Below the table is a 'Move to/Swap to' field with 'Move' and 'Swap' buttons. The bottom of the window contains a footer with fields for 'Maker', 'Checker', 'Date Time', 'Mod No', 'Record Status', and 'Authorization Status', along with an 'Exit' button.

You can specify the following fields:

**Rule Group Name**

Specify the unique rule group name.

**Description**

Enter a brief description of the rule group.

**Rule Name**

Specify the rule name from the rule definition screen.

**Rule Description**

Specify the relevant description for Rule Name mentioned

**Priority**

Specify the priority of the rule name.

**Move To/ Swap**

Specify whether the priority must be swapped or moved.

**Move**

Click the **Move** button to move the priority record.

**Swap**

Click the **Swap** button to swap the priority record.

### 2.3.10 Viewing Rule Group Summary

You can invoke “Rule Group Summary” screen by typing ‘MSSRLGRP’ in the field at the top right corner of the Application tool bar and clicking on the adjoining arrow button.

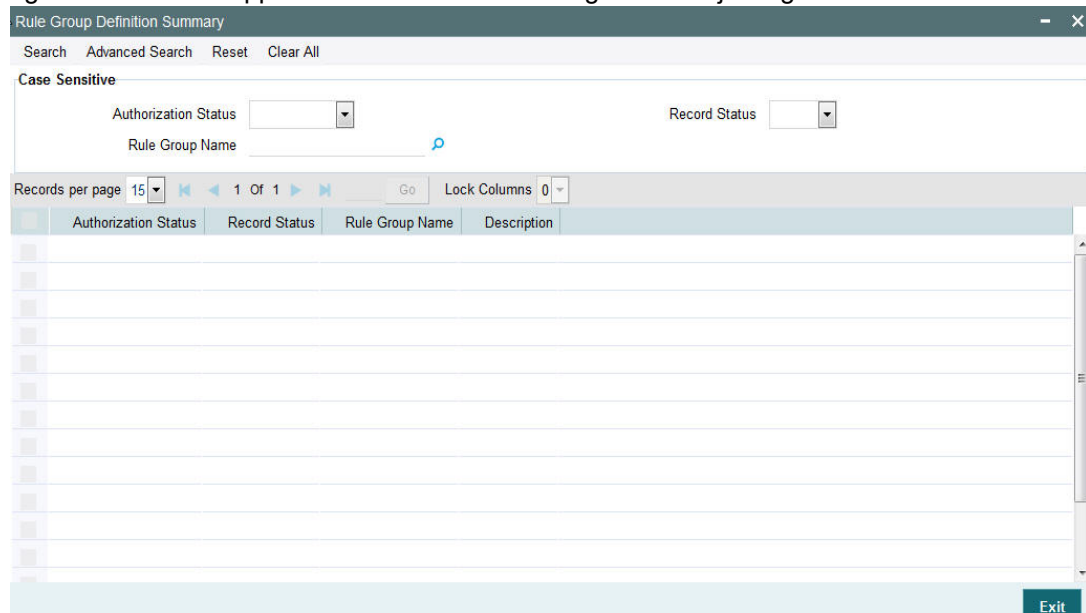

You can search using one or more of the following parameters:

- Authorization Status
- Record Status
- Rule Group Name

Once you have specified the search parameters, click ‘Search’ button. The system displays the records that match the search criteria for the following

- Authorization Status
- Record Status
- Rule Group Name
- Description

### 2.3.11 Invoking Rule Group Mapping Screen

Modules can be mapped to the rule groups defined.

In case a rule group is mapped to the module then all the rules from rule group are executed and the destination is derived.

If there is no rule group mapping for the module then the normal EMS flow should get executed.

You can invoke 'Rule Group Mapping' screen by typing 'MSDRLMAP' in the field at the top right corner of the Application tool bar and clicking on the adjoining arrow button.

The screenshot shows a software window titled "Rule Group Mapping". At the top, there is a menu bar with "New" and "Enter Query". Below this, there are two input fields: "Module Identification \*" and "Rule Group Name \*". At the bottom of the window, there is a status bar with several fields: "Maker", "Checker", "Date Time:", "Mod No", "Record Status", and "Authorization Status". An "Exit" button is located in the bottom right corner of the status bar.

You can specify the following fields:

#### **Rule Group Name**

Specify the unique rule group name.

#### **Module Id**

Specify the module that needs to be mapped to the created rule group.

## 2.3.12 Viewing Rule Group Mapping Summary

You can invoke “Rule Group Mapping Summary” screen by typing ‘MSSRLMAP’ in the field at the top right corner of the Application tool bar and clicking on the adjoining arrow button.

Rule Group mapping Summary

Search Advanced Search Reset Clear All

Case Sensitive

Authorization Status  Record Status

Module Identification

Records per page 15 1 Of 1 Go Lock Columns 0

Authorization Status	Record Status	Module Identification	Rule Group Name
----------------------	---------------	-----------------------	-----------------

Exit

You can search using one or more of the following parameters:

- Authorization Status
- Record Status
- Module Id

Once you have specified the search parameters, click ‘Search’ button. The system displays the records that match the search criteria for the following

- Authorization Status
- Record Status
- Rule Group Name
- Description



## **2.4 Bulking and De-bulking of SWIFT MT Messages**

The following are the list of functionalities that are part of Bulker Framework:

- Ability to bulk the outgoing SWIFT MT messages with a configurable delimiter based on parameters like Message Type, Value Date, Currency, Receiver BIC and Sender BIC.
- Option to schedule automatic bulking with a start and end time with time frequency so that the bulking process runs between start and end time for configured frequency.
- Ability to configure size or volume based bulking.
- File name prefix should be configurable in the system.
- The system supports option to compress the bulk file before sending it to the SWIFTNet network.

### **2.4.1 Invoking Bulk Preference Definition Screen**

Bulk Preference Definition screen is used to configure the preferences to be used during the bulking process.

It also defines the scheduling parameters to automate the bulking process, like start time, end time and frequency.

Compression required and compression type is applicable only for SWIFTNet connectivity not for other destination types.

You can invoke 'Bulk Preference Definition' screen by typing MSDBLKRL' in the field at the top right corner of the Application tool bar and clicking on the adjoining arrow button...

You can specify the following fields:

**Bulk Preference Name**

Specify the name used for storing the Bulk Preference.

**Scheduler**

**Volume Restriction Required**

Check this box to configure volume based bulking.

**Size Restriction Required**

Check this field to configure size based bulking and to have any restriction on the bulking size

**Max Number of Messages**

The systems indicates the maximum number of messages that can be stored in a bulk file.

**Size (in KB)**

Specify the size of messages depending on the number of messages mentioned.

**Scheduler Type**

Select the type of scheduler. Choose any one of the following:

- Time Based
- Frequency

## **Scheduler Frequency Details**

### **Start Time (HH:MM)**

Specify the Start Time of the trigger. Enter the format in HH:MM format.

### **End Time (HH:MM)**

Specify the Start Time of the trigger. Enter the format in HH:MM format.

### **Time Interval in Min**

Specify the interval of the repeat in MM format.

## **Scheduler Timings**

### **Scheduling No**

Specify the scheduling sequence.

### **Start Hour**

Specify the start hour of the scheduling sequence.

### **Start Min**

Specify the start minute for frequency based scheduler.

## **File Attributes**

### **Bulk File Name Prefix**

Specify the prefix to indicate the name of the bulk file.

### **Maximum size of a Bulk File (inKB)**

Specify the maximum size of a bulk file in KB.

### **Payload Delimiter**

Specify the delimiter while bulking messages.

## **Bulk Processing Attributes**

### **Compression Required**

Check this box to indicate that file compression is required.

### **Compression Type**

Specify the required type of compression.

## **Destination Attributes**

### **Destination Type**

Specify the type of destination.

- Folder
- Router

### **Protocol Name**

Specify the protocol name required for FTA protocols.

### **Folder Path**

Specify the user defined destination folder path.

### **Queue JNDI Name**

Specify the name of the Queue if the destination type is Queue.

## Protocol Type

Select the type of Protocol.

## Swift Net Connectivity

Specify the details specific to Swift Net connectivity.

### 2.4.2 Viewing Bulking Preference Definition Summary

This summary screen is used to view the bulk rules defined. It includes the information about the scheduler, file, bulk and destination attributes.

You can invoke “Bulking Preference Definition Summary” screen by typing ‘MSSBLKRL’ in the field at the top right corner of the Application tool bar and clicking on the adjoining arrow button.

The screenshot displays the 'Bulking Preference Definition Summary' application window. The window title is 'Bulking Preference Definition Summary'. The interface includes a search bar with 'Search', 'Advanced Search', 'Reset', and 'Clear All' buttons. Below the search bar is a 'Case Sensitive' checkbox. There are four filter fields: 'Authorization Status' (dropdown), 'Record Status' (dropdown), 'Bulk Preference Name' (text input with a search icon), and 'Bulk Initiated' (dropdown). A table below shows columns: 'Authorization Status', 'Record Status', 'Bulk Preference Name', 'Max Number of Messages', 'Size (in KB)', 'Bulk File Name Prefix', and 'Maximum size of'. The table is currently empty. At the bottom right, there is an 'Exit' button.

You can search using one or more of the following parameters:

- Bulking Preference Name
- Bulk Initiated
- Auth Initiated
- Record Status

Once you have specified the search parameters, click 'Search' button. The system displays the records that match the search criteria for the following:

- Bulking Preference Name
- Frequency
- Max Number of Messages
- Size (in KB)
- File Format
- Bulk Filename Prefix
- Maximum size of bulk file (in KB)
- Bulk Initiated
- Destination Type
- Auth Status
- Record Status

### 2.4.3 Viewing Debulk Rule Summary

You can invoke "Debulk Rule Summary" screen by typing 'MSSDEBRL' in the field at the top right corner of the Application tool bar and clicking on the adjoining arrow button.

Debulk Rule Definition Summary

Search Advanced Search Reset Clear All

Case Sensitive

Authorization Status  Record Status

Debulk Rule Name  Protocol

Records per page 15 1 Of 1 Go Lock Columns 0

Authorization Status	Record Status	Debulk Rule Name	Payload Delimiter	Protocol
----------------------	---------------	------------------	-------------------	----------

Exit

You can search using one or more of the following parameters:

- Authorization Status
- Record Status
- Debulk Rule Name
- Protocol

Once you have specified the search parameters, click 'Search' button. The system displays the records that match the search criteria for the following:

- Authorization Status
- Record Status
- Debulk Rule Name
- Payload Delimiter
- Protocol

#### 2.4.4 Invoking Bulker Monitor Screen

This is the screen to monitor the bulk scheduler execution.

You can view the bulk preference name and the execution start time, end time, execution status and no of files generated.

You can initiate the ad-hoc bulking for the selected bulk preference.

To initiate the adhoc manual bulking the detail screen has to be invoked and click on the adhoc bulking button to trigger the adhoc bulking for the chosen bulk preference.

To Reprocess the messages which are got failed in the previous bulking process user has to invoke bulk monitor details screen. Then click on the user regenerate button to reprocess the failed message to reprocess.

You can invoke 'Bulker Monitor' screen by typing MSDBLKMN' in the field at the top right corner of the Application tool bar and clicking on the adjoining arrow button...

Bulk Monitor

Enter Query

Process Reference Number

Execution Start Date YYYYMMDD

Execution Start Time

Execution End Date YYYYMMDD

Execution End Time

Status

Bulk Preference Name

No Of Files Generated

Error Code

Error Parameter

Error Description

Regenerate

Initiate Adhoc Bulking

Specify the following fields:

##### **Process Reference Number**

Specify the Process Reference Number.

**Execution Start Date**

Specify the Execution Start Date.

**Execution Start Time**

Specify the Execution Start Time.

**Execution End Date**

Specify the Execution End Date.

**Execution End Time**

Specify the Execution End Time.

**Status**

Specify the Status.

**Bulk Preference Name**

Specify the Bulk Preference Name.

**No Of Files Generated**

Specify the No Of Files Generated

**Error Code**

Specify the Error Code.

**Error Parameter**

Specify the Error Parameter

**Error Description**

Specify the Error Description.

## 2.4.5 Bulk Monitor Summary

You can invoke 'Bulk Monitor Summary' screen by typing MSSBLKMN' in the field at the top right corner of the Application tool bar and clicking on the adjoining arrow button...

Bulk Monitor Summary

Search Advanced Search Reset Clear All

Case Sensitive

Execution Start Date YYYY-MM-DD No Of Files Generated

Status Bulk Preference Name

Execution End Date YYYY-MM-DD Process Reference Number

Records per page 15 1 Of 1 Lock Columns 0

Execution Start Date	Execution Start Time	No Of Files Generated	Status	Bulk Preference Name	Execution End Date	Execution End Time
----------------------	----------------------	-----------------------	--------	----------------------	--------------------	--------------------

Exit

You can search using one or more of the following parameters:

- Bulk Preference Name
- Execution Start Time
- Execution End Time
- Status

Once you have specified the search parameters, click 'Search' button. The system displays the records that match the search criteria for the following:

- Bulk Preference Name
- Execution Start Time
- Execution End Time
- Status
- No of Files

## 2.4.6 Invoking Outgoing Message Browser Screen

Additional fields are introduced in the outgoing browser to track the status of the message and along with bulk criteria and bulk reference number.



The new fields are bulk status, bulk file reference number and bulk preference name.

If the message is not satisfied with any of the bulk rule defined in the system, then bulk status will be marked as NA (Bulking not applicable).

You can invoke 'Message Outgoing Browser' screen by typing PMDOUTBR' in the field at the top right corner of the Application tool bar and clicking on the adjoining arrow button.

The screenshot shows the 'Message Outgoing Browser' application window. It features a search interface with the following sections:

- Message Details:** Includes fields for Document Number, Reference Number, Module, Message Type, Receiver, Currency, Amount, DCN List, Message Status, Hold/Release Status, Acknowledgement Status, Funding Status, External Reference, Delivery By, RTGS Network, and Testing Status.
- Receiver Details:** Includes fields for Name, Location, Address, Address 2, Address 3, Address 4, Media, Node, Branch, SWIFT Message Type, Priority, and Exception.
- Test Word Details:** Includes fields for Testword, Test Date (format dd/MM/yy), Test Word Narrative, Network, Test Currency, and Test Amount.

A 'Cancel' button is located at the bottom right of the window.

You can specify the following fields:

### **Operation**

The system displays the type of operation.

### **Any or Original**

The system displays if the message was 'Any' or 'Original'.

### **Message Details**

#### **Document Number**

Specify the Document Number.

#### **Message Status**

The system displays the status of the message.

#### **Reference Number**

Specify the reference number

#### **Hold/Release Status**

The system displays if the message is in Hold or Released status.

#### **Module**

Specify the module name.

**Acknowledgement Status**

The system displays the acknowledgement status of the message.

**Message Type**

Specify the type of message.

**External Reference**

Specify the external reference details.

**Receiver**

Specify the Receiver details.

**Delivery By**

Specify the Delivery details of the message.

**Currency**

Specify the currency that is specified in the message.

**RTGS Network**

Specify the RTGS Network.

**Testing Status**

The system checks this box, if the message requires testing.

**DCN List**

Specify the DCN List details.

**Receiver Details****Name**

Specify the name of the Receiver.

**Node**

Specify the Receiver Node.

**Location**

Specify the location of the Receiver.

**Branch**

Specify the branch of the Receiver.

**Address**

Specify the address details of the Receiver in the lines provided from 1 o 4.

**SWIFT Message Type**

Specify the SWIFT Message Type.

**Priority**

The system displays the priority of the message.

**Hold Mail**

The system check this box, if the mail must be held.

**Exception**

Specify the Exception details.

**Media**

Specify the media details.

## **Test Word Details**

### **Test-word**

Specify the Test Word details.

### **Test Amount**

Specify the Test Amount

### **Test Date**

Specify the date of testing.

### **Test Currency**

Specify the currency used for testing.

### **Test Word Narrative**

Specify the Test Word details.

### **Network**

Specify the Network.

## **2.4.7 Viewing Outgoing Message Browser Summary**

You can invoke “Outgoing Message Browser Summary” screen by typing ‘PMSOUTBR’ in the field at the top right corner of the Application tool bar and clicking on the adjoining arrow button.

Outbound Browser Summary

Search Advanced Search Reset Clear All

Case Sensitive

Branch Document Number Reference Number  
Module Message Type Connectivity Option Message Format Receiver Currency Amount Media SWIFT Message Type Swift MX Type Node Priority Name

Records per page 15 Of 1

View | Edit | Hold | Cancel | Release | Authorize | Handoff | Suppress | Generate | Print

Exit

You can search using one or more of the following parameters:

- Branch
- Document Number
- Reference Number
- Module
- Message Type
- Connectivity Option
- Message Format
- Receiver
- Media
- SWIFT Message Type
- Swift MX Type

- Message Status
- Hold/Release Status
- Acknowledgement Status
- Authorization Status
- Delivery Status
- Handoff Status
- Destination Type
- Funding Status
- Network
- Network Acknowledgement Status

---

**Note**

Queue Access rights is applicable for Outgoing Browser Summary (PMSOUTBR). Refer to Exception Queues user guide, for details on Queue Access Rights.

---

Once you have specified the search parameters, click 'Search' button. The system displays the records that match the search criteria.

The following are the actions can be performed on the resultant search results:

- View - Displays the selected message
- Edit - Edit and change message content, if not handed off yet
- Hold - Hold a message, if generated & not handed off yet
- Cancel - Cancel a message, which is not handed off yet
- Release - Release a message, if withheld due to a hold rule
- Suppress - Suppress a message, if not handed off yet
- Authorize - Authorize the edited message
- Handoff - Handoff a message to SWIFT alliance, if not released yet
- Generate - Generate a message which is un-generated status
- Print - Print a generated message

---

**Note**

- Only Release/Suppress Actions are allowed on messages that are marked as 'Withheld' and requires authorization by another user.
- Messages that are marked as 'Withheld' can be manually released any time, even before the release rule start time. Release time gets updated on authorization of manual release.
- If a payment message marked as 'Withheld' is Released on any other business day after 'Message Date', then the system shows 'This payment message cannot be released' information message. Such payment messages are allowed to be suppressed from the outbound browser.
- Any message with Message Status Un-generated can be generated using the Generate action.
- A generated or handed off message can be printed using Print action.
- SWIFT LAU generated for the outgoing SWIFT MT message for payments can be viewed from the Payments Outgoing message browser screen.

- SWIFT LAU is displayed in summary result which shows the LAU generated for the message.

## 2.4.8 Invoking Incoming Message Browser Screen

This screen is modified to view the incoming message details like source type and SWIFTNet connector name.

You can invoke 'Incoming Message Browser' screen by typing PMDINBRW' in the field at the top right corner of the Application tool bar and clicking on the adjoining arrow button...

You can specify the following fields:

### **Document Number**

Specify the Document Number.

### **Reference No**

Specify the Reference Number of the document.

### **Sender**

Specify the reference number.

### **Media**

Specify the required media.

### **SWIFT Message Type**

Specify the required SWIFT Message Type.

### **Queue**

Specify the queue name.

### **Required Execution Date**

Specify the required execution date.

**Operation**

Select the required operation.

**Name**

Specify the name.

**Address 1**

Specify the address.

**Address 2**

Specify the address.

**Address 3**

Specify the address.

**Address 4**

Specify the address.

**Location**

Specify the required location.

**Status**

Specify the required status.

**Currency**

Specify the required currency.

**Amount**

Specify the amount.

**Value Date**

Specify the value date.

**External Reference**

Specify the external reference number.

**Multi Credit Reference**

Specify the multi credit reference details.

**Branch**

Specify the required branch.

**Media Control System**

Specify the Media Control System.

**Node**

Specify the required node.

**Testword**

Specify the testword.

**Repair Reason**

Specify the Repair Reason.

**Reason Description**

Specify the description of the reason.

**Suppress Details**

**Process Status**

Specify the status of the process.

**PDE Flag**

Check the PDE flag if required.

**Remarks**

Specify the any remarks of the Suppress details.

**Suppress Message**

Specify the suppress message details.

**Cover Match Status**

Specify the status of the cover match.

**Suppress Status**

Specify the status of the suppress.

**Funding Exception Status**

Specify the status of the Funding Exception.

**Authorization Status**

Check the Authorization Status box, if required.

**2.4.9 Viewing Incoming Message Browser Summary**

Payments incoming messages can be viewed from the Incoming Message Browser screen

SWIFT LAU received from incoming message and the check sum calculated by system (LAU\_Validation) are displayed in the incoming browser.

You can invoke “Incoming Message Browser Summary” screen by typing ‘PMSINBRW’ in the field at the top right corner of the Application tool bar and clicking on the adjoining arrow button.

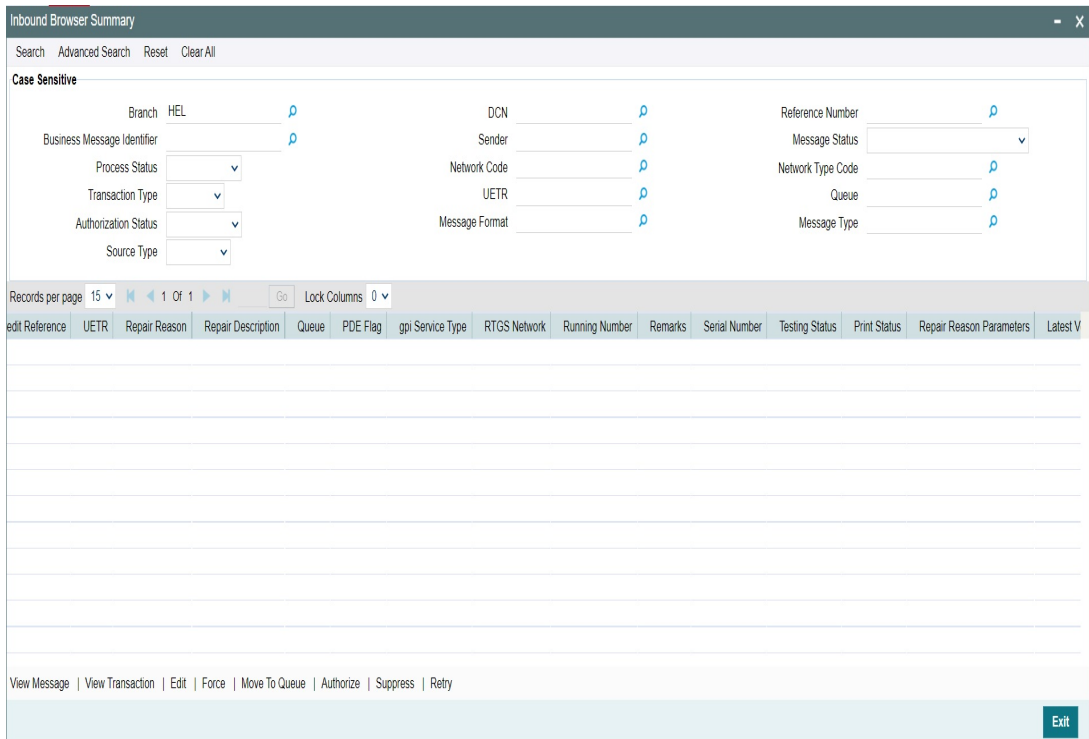

You can search using one or more of the following parameters:

- Branch
- DCN
- Reference Number
- Business Message Identifier
- Sender
- Message Type
- Message Status (Suppressed/ Pending Cover Match / Repair / Pending Network Resolution / Moved to Unmatched Queue / Move to Non STP Queue)
- Process Status (Unprocessed / Processed / Repair / Exception)
- Queue
- Network Code
- Network Type Code
- Transaction Type (Incoming / Outgoing)
- UETR
- Authorization Status (Authorized / Unauthorized)
- Message Format
- Source Type

---

**Note**

- Queue Access rights is applicable for Incoming Browser Summary(PMSINBRW). Refer to Exception Queues user guide, for details on Queue Access Rights.
- If the Payments incoming messages has UETR then system populates UETR value in the search result section.
- Incoming MT210 message received via SWIFT is logged in Inbound Browser Summary (PMSINBRW) screen with process status “Unprocessed”.
- Incoming MT210 message would be matched to another Inbound SWIFT payment message (MT202, MT205) that is expected to be received later.

---

Once you have specified the search parameters, click ‘Search’ button. The system displays the records that match the search criteria.

The following operations are available in the Summary screen:



## View Message

You can view the message received from SWIFT/RTGS network for the selected record" - Description for View Message button.

View Message

Enter Query

DCN \_\_\_\_\_  
Branch \_\_\_\_\_  
Message \_\_\_\_\_

Details

Remarks \_\_\_\_\_

Maker ID \_\_\_\_\_  
Release Time \_\_\_\_\_  
Latest Version No. \_\_\_\_\_

Checker ID \_\_\_\_\_  
Checker Date Stamp \_\_\_\_\_  
Authorized Authorized ▾

View History

Exit

## View Transaction

You can view the incoming/outgoing transaction view screen based on the Payment Type and Transaction Type (i.e. Incoming / Outgoing) of the selected payment message.

## 2.5 File Transmission over SWIFTNet

The following are the list of functionalities that are part of File Transmission over SWIFTNet:

- A framework that provides the SWIFTNet connectivity for the bulked SWIFT FIN files that were generated by bulker.
- New Maintenance functions to capture configurations that are required to connect SWIFTNet via SAG File Act
- Monitoring and tracking function to track FileAct processing within the system.

### 2.5.1 Invoking File Transfer Adapter Connector Configuration

This new screen is used to capture the parameters required for SWIFT Net FileAct connectivity using FTA.

They define the mode of transmission and the parameters required to actually perform the message transmission.

You can invoke 'File Transfer Adapter Connector Configuration' screen by typing 'MSDFTACN' in the field at the top right corner of the Application tool bar and clicking on the adjoining arrow button.

You can specify the following fields:

### **FTA Connector Name**

Specify the valid Connector name and click on Execute Query button. The FTA connectors are factory shipped data.

### **Operation Type**

System defaults the Operation Type. The possible options displayed are - Inbound/Outbound.

### **Node**

System defaults the Node detail. This is mandatory for inbound.

### **Media**

System defaults the Media. This is mandatory for inbound.

### **Media Control System**

System defaults the media control system. This is mandatory for inbound.

### **Host Code**

System defaults the Host code of the logged in user.

### **FTA Parameter**

#### **File Directory**

Specifies store details of emission directory for outbound connectivity and reception directory for inbound flow.

**Success Directory**

For Outbound connectivity, Delivery notification response related to file transfer status from the SAG are placed in this directory. For inbound connectivity file transfer, success status files are placed in this folder.

**Log Directory**

Specifies the responses from SAG.

**Parameter File**

Check this box if FCM creates or receives a Parameter File corresponding to each and every data file in configured file directory along with data file.

**FTA Outbound Parameter****Data file LAU**

Check this box if FCM calculates the LAU of Data File and puts the calculated value in parameter file. Override

Check this box if parameters defined at the emission profile of SAG side will be overridden by information in Companion file.

**Companion LAU**

Check this box if parameters defined at emission profile of SAG side are overridden by information in companion file.

**Debulk Preference****Debulk Required**

Check this box, if debulk is required for inbound messages.

**Debulk Rule Name**

Specifies the debulk rule name.

### 2.5.1.1 Viewing SWIFTNet FTA Connector Definition Summary

You can invoke “SWIFTNet FTA Connector Definition Summary” screen by typing MSSFTACN’ in the field at the top right corner of the Application tool bar and clicking on the adjoining arrow button.

The screenshot shows a web application window titled "SWIFTNet FTA Connector Definition Summary". The interface includes a search bar at the top with buttons for "Search", "Advanced Search", "Reset", and "Clear All". Below the search bar, there are four filter fields: "Case Sensitive", "Authorization Status", "Record Status", and "FTA Connector Name". The "FTA Connector Name" field has a magnifying glass icon. Below the filters, there is a table with columns for "Authorization Status", "Record Status", "FTA Connector Name", and "Operation Type". The table is currently empty. At the bottom right of the window, there is an "Exit" button.

You can search using one or more of the following parameters:

- Authorization Status
- Record Status
- FTA Connector Name
- Operation Type

Once you have specified the search parameters, click 'Search' button. The system displays the records that match the search criteria for the following:

- Authorization Status
- Record Status
- FTA Connector Name
- Operation Type

### 2.5.2 Invoking Connectivity Operation Manager Screen

This screen is used to start and stop the connectivity lines.

You can search for the connectivity lines and perform the operation start/stop on the line searched.

You can invoke 'Connectivity Operation Manager' screen by typing 'MSDCNMGR' in the field at the top right corner of the Application tool bar and clicking on the adjoining arrow button...

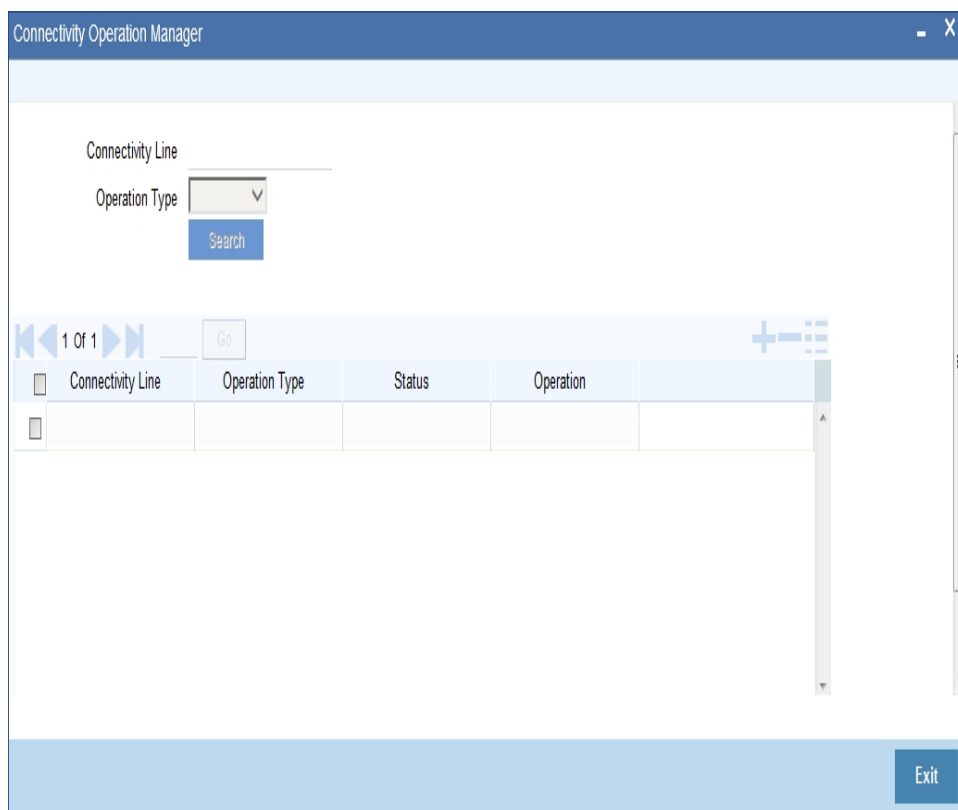

You can specify the following fields:

**Connectivity**

Specify the required connectivity line.

**Operation Type**

Select the type of operation.

**Status**

Specify the display line status.

**Start**

Click the Start button to start the connectivity line.

**Stop**

Click the Stop button to start the connectivity line.

### 2.5.3 Invoking Outbound File Browser Screen

This screen is used to view the bulk files generated for the bulk criteria maintained in the system.

You can search based on the Bulk criteria (rule) name, Generated date, File Name and Status.

File details like name of the bulker file, status, bulk rule name, file generated time, bulk reference number, Size of the file; number of transactions bulked is shown in the details.

File can be resent to the destination if the file status is not processed.

You can invoke 'Outbound File Browser' screen by typing 'MSSFLBRW' in the field at the top right corner of the Application tool bar and clicking on the adjoining arrow button...

Outbound File Browser

Search Advanced Search Reset Clear All

Case Sensitive

File Reference Number

File Type

Generated Date

Handoff Status

File Status

Media

Network Code

Module

Records per page 15 1 Of 1 Go Lock Columns 0

File Reference Number	File Type	Generated Date	Handoff Status	Receiver BIC	Sender BIC	File Format Type	File Status	Media
-----------------------	-----------	----------------	----------------	--------------	------------	------------------	-------------	-------

View

You can specify the following fields:

**File Reference Number**

Specify the File Reference Number of the generated file.

**Generated Date**

Specify the date of the generated file.

**File Status**

Specify the file status of the generated file.

**Network Code**

Specify the network code of the generated file.

### File Type

Specify the type of the generated file.

### Handoff Status

Specify the handoff status of the generated file.

### Media

Specify the media of the generated file.

### Module

Specify the module of the generated file.

## 2.5.4 Invoking Inbound File Browser Screen

This new screen can be used to view the bulk files received from SWIFT Net through the FileAct connectors.

You can search based on the File Name, Received date time and status of the file.

Files received through FileAct connectors is sent to the EMS after parsing the payload file.

De-bulking of the file happen in the EMS.

You can invoke 'Inbound File Browser' screen by typing 'MSSIFBRW' in the field at the top right corner of the Application tool bar and clicking on the adjoining arrow button...

Inbound File Browser Summary

Search Advanced Search Reset Clear All

Case Sensitive

File Reference No \_\_\_\_\_ Host Code \_\_\_\_\_

Received Date \_\_\_\_\_ Status \_\_\_\_\_

Source Code \_\_\_\_\_ Media \_\_\_\_\_

File Name \_\_\_\_\_ SWIFTNET Connector Name \_\_\_\_\_

Records per page 15 1 Of 1 Go Lock Columns 0

File Reference No	Host Code	File Format Type	Received Date	Network Code	Status	Source Code	Media	File Name	SWIFTNE
-------------------	-----------	------------------	---------------	--------------	--------	-------------	-------	-----------	---------

View Exit

You can specify the following fields:

**File Name**

Specify the name of the received file.

**File Reference Number**

Specify the unique reference number of the generated file.

**Received Date**

Specify the date and time of the received file.

**Status**

Specify the status of the file.

**FileAct Connector Name**

Specify the connector through which the file is received.

**Host Code**

Specify the host code of the received file.

**Source Code**

Specify the source code of the received file.

**Media**

Specify the media of the generated file.

## 2.5.5 Connector Network Linkage Maintenance

You can link the SWIFTNet connector with the Network defined in OBPM, using this screen.

You can invoke 'Connector Network Linkage Maintenance' screen by typing 'PMDCONNW' in the field at the top right corner of the Application tool bar and clicking on the adjoining arrow button. Click 'New' button on the Application toolbar.

The screenshot shows a web-based application window titled "Connector Network Linkage Maintenance". The window has a dark header bar with a "New" button and an "Enter Query" button. Below the header, there are several input fields: "Host Code \*" (with a red asterisk), "Connector Name \*" (with a red asterisk), and "Network Code \*" (with a red asterisk) on the left side. On the right side, there are "Host Code Description" and "Connector Type" (a dropdown menu). At the bottom of the window, there is a light blue footer bar containing fields for "Maker", "Checker", "Date Time", "Mod No", "Record Status", and "Authorization Status", along with an "Exit" button.

You can specify the following:

**Host Code**

This field is defaulted as the logged in Host.

**Host Code Description**

System defaults the Host Description of the Host Code defaulted.



### Connector Name

Specify the Connector Name from the list of values. All open and authorized connectors maintained and linked to the Host in the maintenances FTA Connector Configuration (Function ID: MSDFTACN) and MQHA Connector Configuration (Function ID: MSDMQHAC) are listed.

### Connector Type

Specify the Connector Type of the Connector Name selected.

### Network Code

Specify the Network Code from the list of values. All open and authorized Network codes of payment type SEPA CT and SEPA DD are listed

## 2.5.5.1 Connector Network Linkage Maintenance Summary

You can invoke 'Connector Network Linkage Maintenance Summary' screen by typing 'PMSCONNW' in the field at the top right corner of the Application tool bar and clicking on the adjoining arrow button. Click 'Search' button on the Application toolbar.

Authorization Status	Record Status	Host Code	Network Code	Connector Name	Connector Type
----------------------	---------------	-----------	--------------	----------------	----------------

You can search using one or more of the following parameters:

- Authorization Status
- Record Status
- Host Code
- Network Code
- Costumer Name

Once you have specified the search parameters, click 'Search' button. The system displays the records that match the search criteria.

## 2.5.6 Connector File Type Linkage Maintenance

You can link the SWIFTNet connector with the File Type defined Non CSM SEPA CT/SEPA DD files, using this screen.

You can invoke 'Connector File Type Linkage Maintenance' screen by typing 'PMDCONFL' in the field at the top right corner of the Application tool bar and clicking on the adjoining arrow button. Click 'New' button on the Application toolbar.

Connector - File Type Linkage Maintenance

New Enter Query

Host Code \*

Connector Name \*

File Type \*

File Format Type \* XML

Schema Path \*

Schema Name \*

Host Code Description

Connector Type

Network Code

Maker  
Checker

Date Time:  
Date Time:

Mod No

Record Status  
Authorization  
Status

Exit

You can specify the following:

### Host Code

This field is defaulted as the logged in Host.

### Host Code Description

System defaults the Host Description of the Host Code defaulted.

### Connector Name

Specify the Connector Name from the list of values. Lists the combinations of all open and authorized maintenances available in PMDCONNW for the connector name and Network.

### Connector Type

System defaults the Connector Type of the Connector Name selected.

### Network Code

System defaults the Network Code of the Connector Name selected.

### File Type

Specify the File Type from the list of values. Based on the Network payment type, File Type list is populated.

### File Format Type

Select the only value 'XML' for the File Type from the drop-down list.

### Schema Path

Specify the Schema Path.

### Schema Name

Specify the Schema Name.

## 2.5.6.1 Connector File Type Linkage Maintenance Summary

You can invoke 'Connector File Type Linkage Maintenance Summary' screen by typing 'PMSCONFL' in the field at the top right corner of the Application tool bar and clicking on the adjoining arrow button. Click 'Search' button on the Application toolbar.

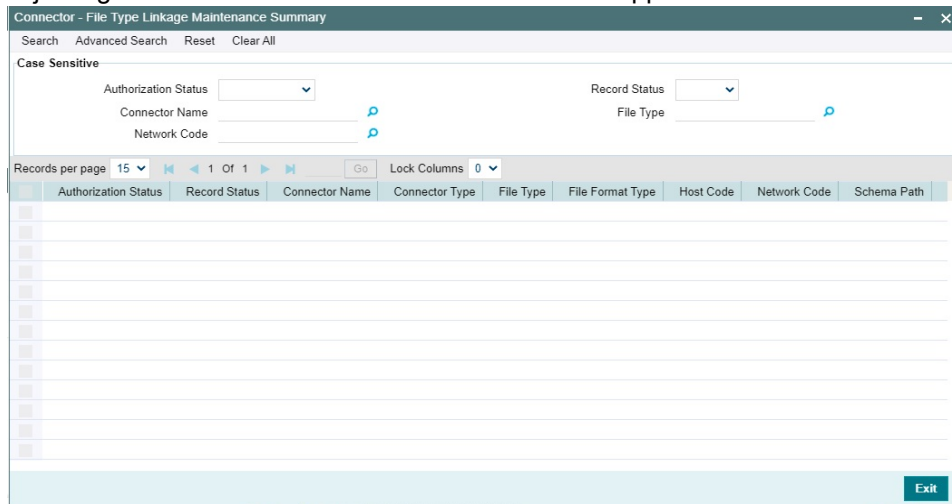

You can search using one or more of the following parameters:

- Authorization Status
- Record Status
- Costumer Name
- File Type
- Network Code

Once you have specified the search parameters, click 'Search' button. The system displays the records that match the search criteria.

## 2.5.7 Fedwire Message Mapping

You can invoke 'Fedwire Message Mapping' screen by typing 'MSDFQMAP' in the field at the top right corner of the Application tool bar and clicking on the adjoining arrow button.

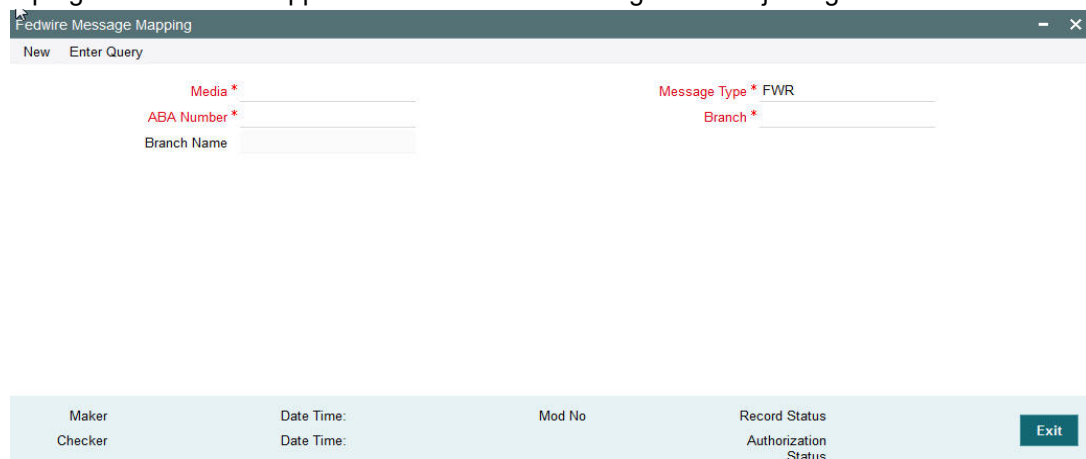

You can specify the following fields:

### Media

Specify the required Media from the list of values.

### ABA Number

Specify the required ABA Number from the list of values.

### Message Type

The system displays the message type by default.

### Branch

Select the required branch from the list of values.

### Branch Name

This is displayed when you select the branch.

## 2.5.8 Fedwire Message Mapping Summary

You can invoke “Fedwire Message Mapping Summary” screen by typing ‘MSSFQMAP’ in the field at the top right corner of the Application tool bar and clicking on the adjoining arrow button.

The screenshot shows the 'Fedwire Message Mapping Summary' application window. The window has a title bar with the text 'Fedwire Message Mapping Summary'. Below the title bar, there is a search bar with the following options: 'Search', 'Advanced Search', 'Reset', and 'Clear All'. Below the search bar, there is a section for search filters. The filters are: 'Case Sensitive' (checkbox), 'Authorization Status' (dropdown), 'Record Status' (dropdown), 'Message Type' (text input with search icon), 'ABA Number' (text input with search icon), 'Media' (text input with search icon), and 'Branch' (text input with search icon). Below the filters, there is a table with the following columns: 'Authorization Status', 'Record Status', 'Message Type', 'ABA Number', 'Media', and 'Branch'. The table is currently empty. At the bottom right of the window, there is an 'Exit' button.

You can search using one or more of the following parameters:

- Authorization Status
- Record Status
- Message Type
- ABA Number
- Media
- Branch

Once you have specified the search parameters, click 'Search' button. The system displays the records that match the search criteria for the following:

- Authorization Status
- Record Status
- Message Type
- ABA Number
- Media
- Branch

## 2.5.9 SWIFT Message Notifications

You can invoke 'SWIFT Message Notifications' screen by typing 'MSDNOTIB' in the field at the top right corner of the Application tool bar and clicking on the adjoining arrow button.

SWIFT Message Notifications

Enter Query

Document Number\* \_\_\_\_\_

Sender \_\_\_\_\_

SWIFT Message Type \_\_\_\_\_

Branch Date \_\_\_\_\_

Reference No \_\_\_\_\_

Message Reference \_\_\_\_\_

Receiver \_\_\_\_\_

User Reference \_\_\_\_\_

Mod Number \_\_\_\_\_

Branch \_\_\_\_\_

Running Number \_\_\_\_\_

Process Status \_\_\_\_\_

Authorization Status \_\_\_\_\_

Maker ID \_\_\_\_\_

Release Time \_\_\_\_\_

LBL\_CHECKER\_ID \_\_\_\_\_

Checker Date Stamp \_\_\_\_\_

Exit

You can specify the following fields:

### **Document Number**

Specify the Document Number and click on Execute Query button to view the details pertaining to it.

Following details are displayed on clicking Execute Query button:

- Branch
- Sender
- Running Number
- SWIFT Message Type
- Process Status
- Branch Date
- Authorization Status
- Reference No
- Message Reference
- Maker ID
- Receiver
- Release Time
- User Reference
- Checker ID
- Mod Number
- Checker Date Stamp

## 2.6 SWIFT LAU

SWIFT Alliance LAU is enabled in order to secure messaging between Oracle Banking Payments and SWIFT.

If there is any interference with the message as it is transmitted between source and destination, the checksum fails, indicating the message integrity has been breached.

## 2.6.1 Invoking SWIFT LAU Key Maintenance Screen

This screen can be accessed for maintenance from Head Office only.

Specific users with necessary roles can access the maintenance screen. Switching LAU 'ON' or 'OFF' affects all the outgoing SWIFT messages in FCUBS. SWIFT LAU maintenance data is referred by EMS for calculation of checksum for outbound or inbound messages.

Message direction must be chosen based on the key is maintained for Outgoing or Incoming SWIFT message.

You can invoke 'SWIFT LAU Key Maintenance' screen by typing 'MSDLAUMN' in the field at the top right corner of the Application tool bar and clicking on the adjoining arrow button.

The screenshot shows the 'SWIFT LAU Key Maintenance' application window. The title bar includes 'SWIFT LAU Key Maintenance' and standard window controls. The menu bar contains 'New' and 'Enter Query'. The main form area has the following elements: a 'Host Code \*' field with a red asterisk indicating it is required; a 'Description' field; a 'Message Direction' dropdown menu currently showing 'Incoming'; a 'SWIFT LAU Required' checkbox; a section titled 'SWIFT LAU Key' containing 'Key First Part' and 'Key Second Part' text input fields. The bottom status bar includes labels for 'Maker', 'Checker', 'Date Time', 'Mod No', 'Record Status', and 'Authorization Status', and an 'Exit' button.

You can specify the following fields:

### Host Code

Specify the required Host Code from the list of values. Depending on the host code selected, the description of the host code is auto-populated.

### Description

The description of the host code is auto-populated, depending on the host code selected.

### .Message Direction

Choose the direction of the message based on the key maintained for Outgoing or Incoming SWIFT message.

### SWIFT LAU Required

Check this box to indicate that local authentication is required for the host.

---

### Note

- This flag is used to activate / deactivate the LAU capability.
  - If the "SWIFT LAU Required" parameter is checked then all other parameters in the screen will be mandatory fields.
-

## **SWIFT LAU Key**

### **Key First Part**

System defaults the value for Key First part on clicking Execute Query, when maintained. The length of the key must be in sixteen hexadecimal characters.

### **Key Second Part**

System defaults the value for Key Second part on clicking Execute Query, when maintained. The length of the key must also be in sixteen hexadecimal characters.

## **2.6.2 Viewing SWIFT LAU Key Summary**

You can invoke “SWIFT LAU Key Summary” screen by typing ‘MSSLAUMN’ in the field at the top right corner of the Application tool bar and clicking on the adjoining arrow button.

The screenshot shows the 'SWIFT LAU Key Summary' application window. At the top, there is a search bar with 'Search', 'Advanced Search', 'Reset', and 'Clear All' options. Below the search bar, there are filters for 'Case Sensitive', 'Authorization Status', 'Record Status', 'Host Code', and 'Message Direction'. A table below shows columns for 'Authorization Status', 'Record Status', 'Host Code', 'Message Direction', 'SWIFT LAU Required', 'Key First Part', and 'Key Second Part'. The table is currently empty. At the bottom right, there is an 'Exit' button.

You can search using one or more of the following parameters:

- Authorization Status
- Record Status
- Host Code
- Message Direction

Once you have specified the search parameters, click ‘Search’ button. The system displays the records that match the search criteria for the following:

- Authorization Status
  - Record Status
  - Host Code
  - Message Direction
  - SWIFT LAU Required
  - Key First Part
  - Key Second Part
- Detailed Processing Logic for Outgoing SWIFT LAU

- The messaging module is enhanced to incorporate the new S-block in the SWIFT message. And the same is generated for all outbound messages from FCUBS with message status 'G'.
- The messaging module fetches the records in outgoing browser with MSG\_STATUS = 'G' and generates S-Block data.
- For all outbound messages, the generated checksum is appended in S-Block and can be viewed from Outgoing Message Browser front end screen.
- Successful generation of S-Block data and message hand-off to out folder updates the message status to 'H'
- EMS does not update message status to 'H' in Outgoing message browser if, there is failure to append the S block data in the message and the status of message remains 'G'.

EMS next hand-off job picks the messages with status 'G' and regenerates S Block data and appends same in the message which also updates message status to 'H'.

Refer the Process Flow diagram below:

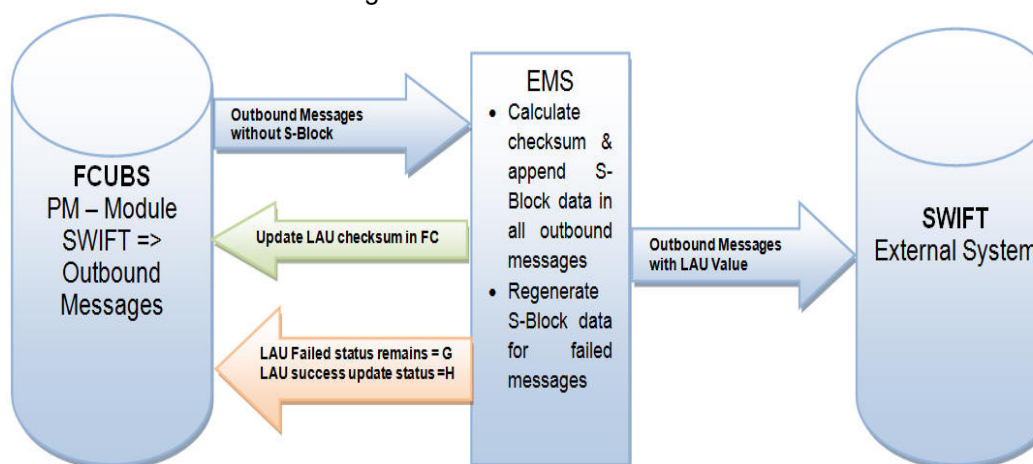

### 2.6.3 Detailed Processing Logic for Incoming SWIFT LAU

- The messaging module is enhanced to validate inbound messages with S block data.
- Received encrypted S-Block checksum values are validated.
- You can view both, check sum received & generated in SWIFT\_LAU & LAU\_VALIDATION fields respectively. Messages with status 'R' in Incoming message browser hold differences in check sum data between SWIFT\_LAU and LAU\_VALIDATION data.
- Incoming message without any data in S Block is uploaded in incoming browser with status 'R' and there is no data updated in SWIFT\_LAU field where as EMS generated checksum gets updated in LAU\_VALIDATION field.



Refer the Process Flow diagram below:

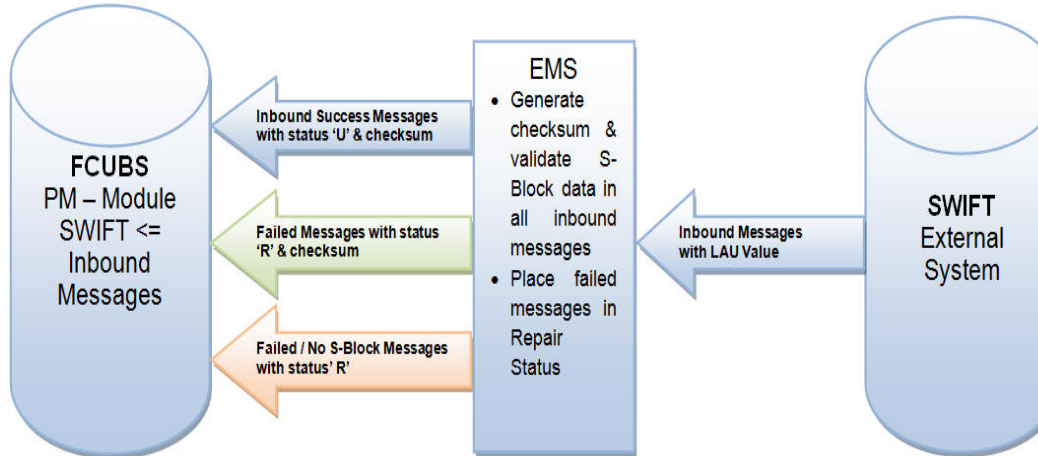

## 2.7 SWIFT Message Routing Parameter via block chain network

Cross border Outbound transactions initiated from a particular Branch, with as specific Receiver BIC, Message Type, Transfer Currency and Source Code are processed using block chain network and not via SWIFT network. User can verify the details of transaction initiated in source environment are received in destination environment for the combination maintained.

### 2.7.1 SWIFT Message Routing Parameter Detailed

You can invoke 'SWIFT Message Routing Parameter Detailed' screen by typing 'PMDMSGRT' in the field at the top right corner of the Application tool bar and clicking on the adjoining arrow button

You can specify the following details by clicking on 'New' button to create a new record or verify the existing records by clicking on Enter Query button

#### **Transaction Branch**

Specify the Transaction branch in which the transaction is to be booked. Alternatively you can select a valid Transaction Branch from the list of values displayed.

## Receiver BIC

Specify a valid Receiver BIC, which is the internal SWIFT routing receiver BIC. Alternatively you can select a valid Receiver BIC from the list of values displayed.

## SWIFT Message Type

Specify the SWIFT message Type, for which the SWIFT Routing parameter is to be maintained. Alternatively you can select a valid Receiver BIC from the list of values displayed.

## Transfer Currency

Specify the Transfer Currency. Alternatively, you can select a currency code from the list of values displayed.

## Source Code

Specify the Source Code. Alternatively, you can select the Source Code from the list of values displayed

### 2.7.1.1 SWIFT Message Routing Parameter Summary

You can invoke 'SWIFT Message Routing Parameter Summary' screen by typing 'PMSMSGRT' in the field at the top right corner of the Application tool bar and clicking on the adjoining arrow button.

The screenshot shows a web application window titled "SWIFT Message Routing Parameter Summary". At the top, there is a search bar with buttons for "Search", "Advanced Search", "Reset", and "Clear All". Below the search bar, there are several search filters: "Case Sensitive" (checkbox), "Authorization Status" (dropdown), "Record Status" (dropdown), "Transaction Branch" (text input with a search icon), and "SWIFT Message Type" (text input with a search icon). Below the filters, there is a table with columns: "Authorization Status", "Record Status", "Transaction Branch", "Receiver BIC", and "SWIFT Message Type". The table currently shows one record. At the bottom right of the window, there is an "Exit" button.

You can search using one or more of the following parameters:

- Authorization Status
- Record Status
- Transaction Branch
- Receiver BIC
- SWIFT Message Type

Once you have specified the search parameters, click 'Search' button. The system displays the records that match the search criteria.

Double click a record or click the 'Details' button after selecting a record to view the detailed screen. You can also export the details of selected records to a file using 'Export' button.

## 2.7.2 Smart Contract Transaction Summary

You can invoke 'DLT Message Browser Summary' screen by typing 'PMSHYLTR' in the field at the top right corner of the Application tool bar and clicking on the adjoining arrow button.

DLT Message Browser Summary

Search Advanced Search Reset Clear All

Case Sensitive

Sender Branch \_\_\_\_\_

Reference Number \_\_\_\_\_

Receiver \_\_\_\_\_

Generated Reference \_\_\_\_\_

Receiver Branch \_\_\_\_\_

Sender \_\_\_\_\_

Status \_\_\_\_\_

Source Type \_\_\_\_\_

Records per page 15 1 Of 1 Lock Columns 0

Sender Branch	Receiver Branch	Reference Number	Sender	Receiver	Status	Generated Reference	Currency	Amount	Source Type	Val
---------------	-----------------	------------------	--------	----------	--------	---------------------	----------	--------	-------------	-----

Retry

Exit

You can search using one or more of the following parameters:

- Sender Branch
- Receiver Branch
- Reference Number
- Sender
- Receiver
- Status
- Generated Reference
- Source Type

Once you have specified the search parameters, click 'Search' button. The system displays the records that match the search criteria.

You can perform below action:

### 2.7.2.1 Retry

This action is allowed for all the outbound messages with Rejected/Failed status. You are required to have user/role level queue access rights, to take this action. Source Type needs to 'Out'.

You can use this action to resubmit the payment message for OFBA to pick up and process the message. This action is allowed for a configured number of times.

This sub screen have following fields as display fields

- DCN
- Generated Reference
- Receiver Branch
- Sender Branch
- Smart Contract ID
- Message Status
- Error Code
- Error Description

Status field is shown as the current status. Please select the option to 'Ready'.

On clicking of OK, the message is populated in the OFBA polling table for pick up by OFBA. The message status is then updated as 'Ready'.

On receiving the response from OFBA table, the ACK/NACK status is updated in the SWIFT Message Notification Browser (MSSNOTIB).

Retry of failed/rejected messages are allowed for the maximum number of retry count value maintained against the parameter 'MAX\_OFBA\_RETRY\_COUNT' [PMDSYSPM]. The factory shipped value for maximum retry value is 10.

## 2.8 SWIFT FIN Header Configuration

Provision is given in an application to configure delivery monitoring flag in the FIN message application header. Based on the configuration provided the customer can do the maintenance to receive/not receive MT011 delivery notifications.

### 2.8.1 SWIFT FIN Header Preference

This screen supports processing of delivery notification messages.

You can invoke 'SWIFT FIN Header Preference screen' by typing 'PXDFNHDR' in the field at the top right corner of the Application tool bar and clicking on the adjoining arrow button

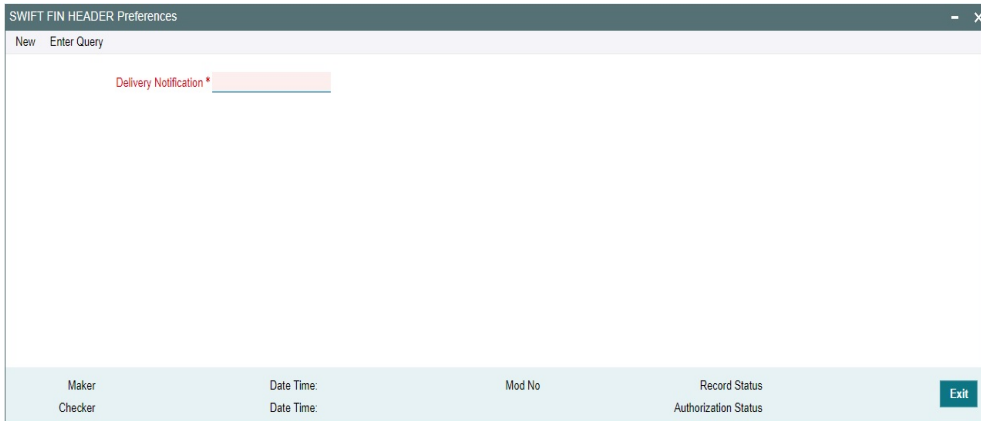

You can specify the following details by clicking on 'New' button to create a new record or verify the existing records by clicking on Enter Query button.

### Delivery Notification

Specify the Delivery Notification from the following list of values:

- Required
- Not Required

### 2.8.1.1 SWIFT FIN HEADER Preferences Summary

You can invoke 'SWIFT FIN HEADER Preferences Summary' screen by typing 'PXSFNHDR' in the field at the top right corner of the Application tool bar and clicking on the adjoining arrow button.

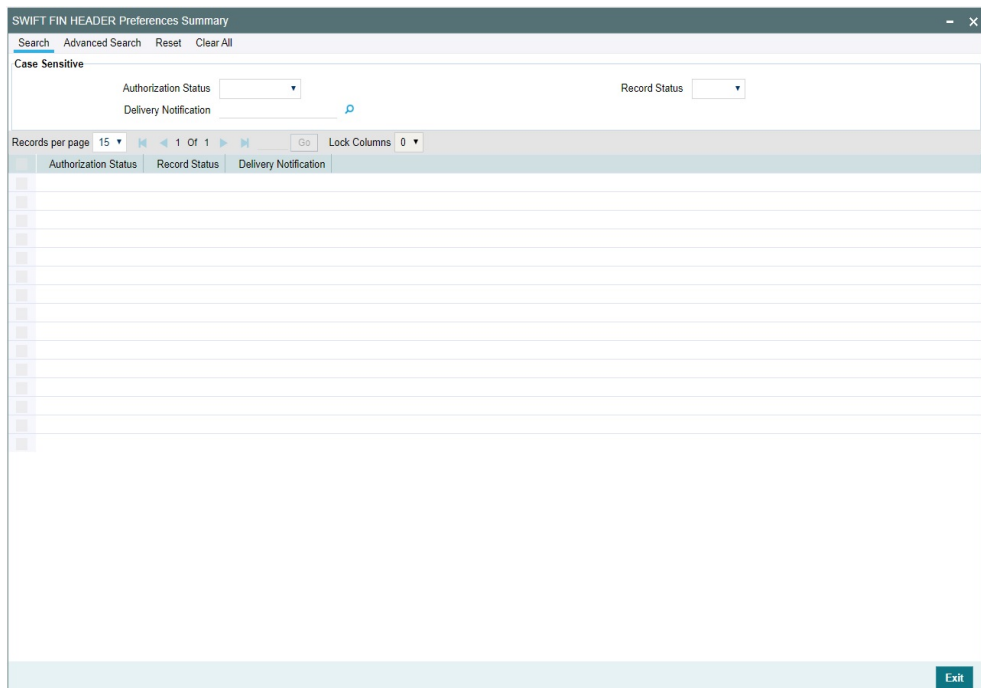

You can search using one or more of the following parameters:

- Authorization Status (Authorized / Unauthorized / Rejected)
- Record Status (Open / Closed)
- Delivery Notification

Once you have specified the search parameters, click 'Search' button. The system displays the records that match the search criteria.

Double click a record after selecting a record to view the detailed screen.

## 2.8.2 **SWIFT FIN Header Host Preference**

This screen supports processing of delivery notification messages.

You can invoke 'SWIFT FIN Header Host Preference screen' by typing 'PXDFNHST' in the field at the top right corner of the Application tool bar and clicking on the adjoining arrow button

The screenshot shows a web-based application window titled "SWIFT FIN HEADER Host Preferences". At the top left, there are two buttons: "New" and "Enter Query". Below these are five input fields arranged in two columns. The left column contains three fields: "Network Code \*", "Host Code \*", and "Delivery Notification \*". The right column contains two fields: "Network Description" and "Network Type Description". At the bottom of the window, there is a light blue footer area containing several fields: "Maker", "Checker", "Date Time:", "Date Time:", "Mod No", "Record Status", "Authorization Status", and an "Exit" button.

You can specify the following details by clicking on 'New' button to create a new record or verify the existing records by clicking on Enter Query button.

### **Host Code**

System defaults the Host code of the logged in user.

### **Network Code**

This field list all the Network codes maintained for payment types 'Cross Border' and 'RTGS' in the host.

### **Delivery Notification**

Specify the Delivery Notification from the following list of values:

- Required
- Not Required

### **Network Description**

The system defaults the Network Description based on the Network Code selected.

### **Network Type Description**

The system defaults the Network Type Description based on the Network Code selected.

## 2.8.2.1 **SWIFT FIN HEADER Host Preferences Summary**

You can invoke 'SWIFT FIN HEADER Host Preferences Summary' screen by typing 'PXSFNHDR' in the field at the top right corner of the Application tool bar and clicking on the adjoining arrow button

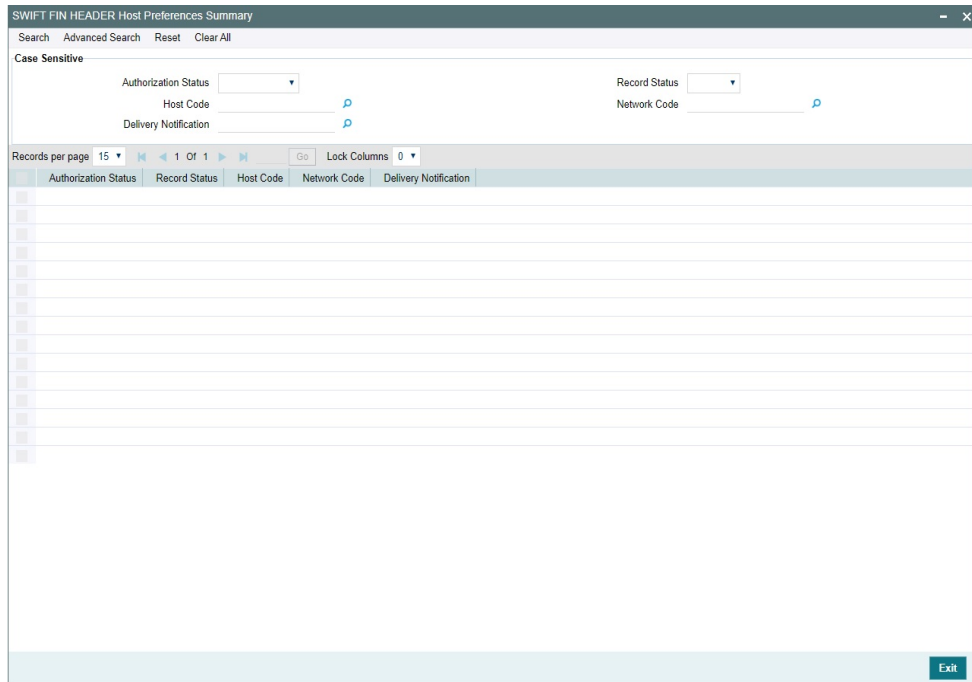

You can search using one or more of the following parameters:

- Authorization Status (Authorized / Unauthorized / Rejected)
- Record Status (Open / Closed)
- Host Code
- Network Code
- Delivery Notification

Once you have specified the search parameters, click 'Search' button. The system displays the records that match the search criteria.

Double click a record after selecting a record to view the detailed screen.

### 2.8.3 **SWIFT FIN Header Processing**

Below is the list of messages applicable on Swift Fin Header preferences and Host preferences:

Message Type	Message Description
MT103/103 REMIT/103 STP	Single Customer Credit Transfer
MT202	General Financial Institution Transfer
MT205	Financial Institution Transfer Execution
MT202COV	General Financial Institution Transfer
MT205COV	Financial Institution Transfer Execution
MT200	Financial Institution Transfer for its Own Account
MT210	Notice to Receive

While generating the outgoing MT message, system checks for Delivery Notification maintenance done in the FIN Header Host Preference (PXDFNHST) screen.

If there is no host level message preference maintained, then system checks the FIN Header Preference (PXDFNHDR) screen.

Level 1	SWIFT FIN Header Host Preference
Level 2	SWIFT FIN Header Preference

Based on the Message Priority (i.e. Value provided in Bank priority field) of outgoing transaction input screen and Delivery Notification field value, the Delivery Monitoring field of FIN message application header gets populated

- When Message Priority value is U
  - If Delivery Notification value is 'Required, Field value gets populated with 3.
  - If Delivery Notification value is Not Required, Field value gets populated as 1.
- When Message Priority value is N
  - If Delivery Notification value is 'Required, Field value gets populated with 2.
  - If Delivery Notification value is Not Required, Field value gets blank.

---

**Note**

When value of the delivery notification is sent as blank then system do not receive MT011 (i.e. Delivery Notification) from SWIFT.

---



---

## 3. Function ID Glossary

### M

MSDBLKMN .....	2-24
MSDBLKRL .....	2-20
MSDCNMGR .....	2-39
MSDFQMAP .....	2-45
MSDFTACN .....	2-36
MSDLAUMN .....	2-48
MSDNOTIB .....	2-47
MSDPTPRM .....	2-10
MSDRLDFN .....	2-12
MSDRLGRP .....	2-15
MSDRLMAP .....	2-17
MSDSWTSR .....	2-7
MSSBLKMN .....	2-26
MSSDEBRL .....	2-23
MSSFQMAP .....	2-46
MSSFTACN .....	2-38
MSSLAUMN .....	2-49
MSSPTPRM .....	2-11

MSSRLDFN .....	2-14
MSSRLGRP .....	2-16
MSSRLMAP .....	2-18
MSSSWTSR .....	2-9

### P

PMDCONFL .....	2-44
PMDCONNW .....	2-42
PMDINBRW .....	2-31
PMDMSGRT .....	2-51
PMDOUTBR .....	2-27
PMSCONFL .....	2-45
PMSCONNW .....	2-43
PMSHYLTR .....	2-53
PMSINBRW .....	2-33
PMSMSGRT .....	2-52
PMSOUTBR .....	2-29
PXDFNHDR .....	2-54
PXDFNHST .....	2-56
PXSFNHDR .....	2-55, 2-56